

# SEARS OWNER'S MANUAL

MODEL NO.  
**934.55125590**

## CONTENTS

IMPORTANT SAFEGUARDS .....	2
PRECAUTIONS .....	4
FEATURES .....	5
SUPPLIED ACCESSORIES .....	6
OPERATING CONTROLS AND FUNCTIONS .....	6
REMOTE CONTROL OPERATION .....	8
ANTENNA/CABLE SYSTEM CONNECTIONS .....	10
CONTROLLING VCR INPUT & OUTPUT .....	13
CHANNEL MEMORY PROGRAMMING .....	14
SETTING THE CLOCK .....	16
TO CHANGE THE LANGUAGE .....	17
VIEWING AND RECORDING THE SAME PROGRAM .....	18
RECORDING ONE PROGRAM WHILE VIEWING ANOTHER .....	19
AUTOMATIC TIMER RECORDING .....	19
QUICK SET PROGRAM .....	22
INDEX SEARCH .....	24
TIME SEARCH .....	25
BLANK SEARCH .....	26
SETTING THE REMAINING TIME .....	27
JUST-IN TIME RECORDING .....	28
OTR (ONE TOUCH RECORDING) .....	29
MONITORING RECORDING .....	29
PLAYBACK .....	30
AUTO REPEAT PLAYBACK .....	30
RENTAL PLAY .....	31
COUNTER MEMORY .....	32
SPECIAL FEATURES .....	33
VIDEO CASSETTE TAPE .....	34
TROUBLESHOOTING GUIDE .....	35
MAINTENANCE .....	36
SPECIFICATIONS .....	37

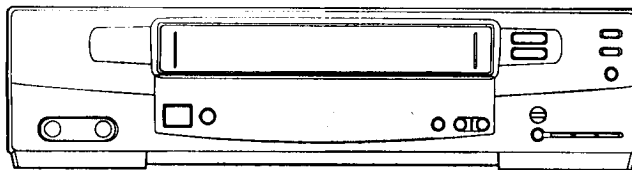

## VIDEO CASSETTE RECORDER

Record the Model Number and Serial Number of your VCR. The Model Number and the Serial number are on the rear panel.



Model No. \_\_\_\_\_

Serial No. \_\_\_\_\_



Keep these numbers for future use.

**WARNING:**

TO REDUCE THE RISK OF FIRE OR ELECTRIC SHOCK, DO NOT EXPOSE THIS APPLIANCE TO RAIN OR MOISTURE.

	<b>CAUTION</b> RISK OF ELECTRIC SHOCK DO NOT OPEN	
<b>CAUTION:</b> TO REDUCE THE RISK OF ELECTRIC SHOCK, DO NOT REMOVE COVER (OR BACK) NO USER SERVICEABLE PARTS INSIDE. REFER SERVICING TO QUALIFIED SERVICE PERSONNEL.		

The important note is located on the rear of the cabinet.

	THIS SYMBOL INDICATES THAT DANGEROUS VOLTAGE CONSTITUTING A RISK OF ELECTRIC SHOCK IS PRESENT WITHIN THIS UNIT.
	THIS SYMBOL INDICATES THAT THERE ARE IMPORTANT OPERATING AND MAINTENANCE INSTRUCTIONS IN THE LITERATURE ACCOMPANYING THE APPLIANCE.

## IMPORTANT SAFEGUARDS

- 1. Read instructions**-All the safety and operating instructions should be read before the appliance is operated.
- 2. Retain Instructions**-The safety and operating instructions should be retained for future reference.
- 3. Heed Warnings**-All warnings on the appliance and in the operating instructions should be adhered to.
- 4. Follow Instructions**-All operating and use instructions should be followed.
- 5. Cleaning**-Unplug this video product from the wall outlet before cleaning. Do not use liquid cleaners or aerosol cleaners. Use a damp cloth for cleaning.  
**EXCEPTION:** A product that is meant for uninterrupted service and, that for some specific reason, such as the possibility of the loss of an authorization code for a CATV converter, is not intended to be unplugged by the user for cleaning or any other purpose, may exclude the reference to unplugging the appliance in the cleaning description otherwise required in item 5.
- 6. Attachments**-Do not use attachments not recommended by the video product manufacturer as they may cause hazards.
- 7. Water and Moisture**-Do not use this video product near water, for example, near a bath tub, wash bowl, kitchen sink, or laundry tub, in a wet basement, or near a swimming pool, and the like.
- 8. Accessories**-Do not place this video product on an unstable cart, stand, tripod, bracket, or table. The video product may fall, causing serious injury to a child or adult, and serious damage to the appliance. Use only with a cart, stand, tripod, bracket, or table recommended by the manufacturer, or sold with the video product. Any mounting of the appliance should follow the manufacturer's instructions and should use a mounting accessory recommended by the manufacturer. An appliance and cart combination should be moved with care. Quick stops, excessive force, and uneven surfaces may cause the appliance and cart combination to overturn.
- 9. Ventilation**-Slots and openings in the cabinet are provided for ventilation and to ensure reliable operation of the video product and to protect it from overheating, and these openings must not be blocked or covered. The openings should never be blocked by placing the video product on a bed, sofa, rug, or other similar surface. This video product should not be placed in a built-in installation such as a bookcase or rack unless proper ventilation is provided or the manufacturer's instructions have been adhered to .
- 10. Power Sources**-This video product should be operated only from the type of power source indicated on the marking label. If you are not sure of the type of power supply to your home, consult your appliance dealer or local power company. For products intended to operate from battery power, or other sources, refer to the operating instructions.
- 11. Grounding or Polarization**-This video product is equipped with a polarized alternating-current line plug (a plug having one blade wider than the other). This plug will fit into the power outlet only one way. This is a safety feature. If you are unable to insert the plug fully into the outlet, try reversing the plug. If the plug should still fail to fit, contact your electrician to replace your obsolete outlet. Do not defeat the safety purpose of the polarized plug.
- 12. Power Cord Protection**-Power supply cords should be routed so that they are not likely to be walked on or pinched by items placed upon or against them, paying particular attention to cords at plugs, convenience receptacles, and the point where they exit from the appliance.
- 13. Outdoor Antenna Grounding**-If an outside antenna or cable system is connected to the video product, be sure the antenna or cable system is grounded so as to provide some protection against voltage surges and built-up static charges. Article 810 of the National Electrical Code, ANSI/NFPA No. 70, provides information with regard to proper grounding of the mast and supporting structure, grounding of the lead-in wire to an antenna discharge unit, size of grounding conductors, location of antenna-dis-

PORTABLE CART WARNING  
(Symbol provided by RETAC)



S3125A

**FIGURE A**  
**EXAMPLE OF ANTENNA GROUNDING AS PER**  
**NATIONAL ELECTRICAL CODE**

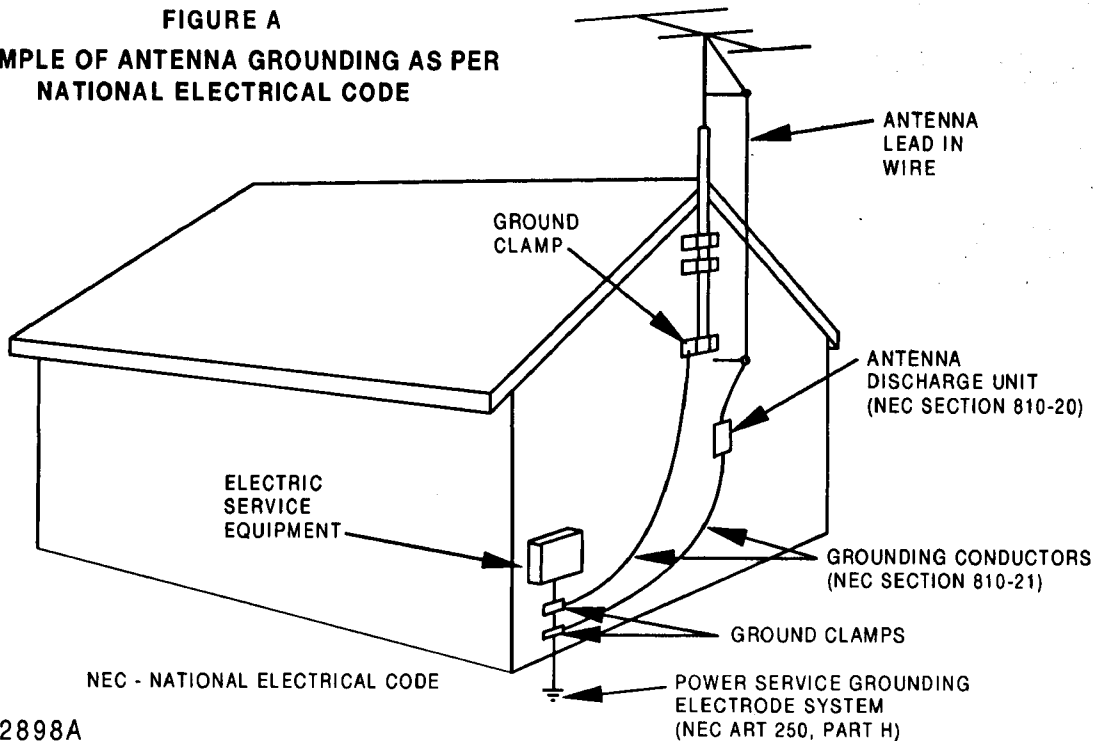

S2898A

charge unit, connection to grounding electrodes, and requirements for the grounding electrode. (Fig. A)

14. **Lightning**-For added protection for this video product during a lightning storm, or when it is left unattended and unused for long periods of time, unplug it from the wall outlet and disconnect the antenna or cable system. This will prevent damage to the video product due to lightning and power-line surges.
15. **Power Lines**-An outside antenna system should not be located in the vicinity of overhead power lines or other electric light or power circuits, or where it can fall into such power lines or circuits. When installing an outside antenna system, extreme care should be taken to keep from touching such power lines or circuits as contact with them might be fatal.
16. **Overloading**-Do not overload wall outlets and extension cords as this can result in a risk of fire or electric shock.
17. **Object and Liquid Entry**-Never push objects of any kind into this video product through any openings as they may touch dangerous voltage points or short-out parts that could result in a fire or electric shock. Never spill liquid of any kind on the video product.
18. **Servicing**-Do not attempt to service this video product yourself as opening or removing covers may expose you to dangerous voltage or other hazards. Refer all servicing to qualified service personnel.
19. **Damage Requiring Service**-Unplug this video product from the wall outlet and refer servicing to qualified service personnel under the following conditions:
  - a. When the power-supply cord or plug is damaged.
  - b. If liquid has been spilled, or objects have fallen into the video product.
  - c. If the video product has been exposed to rain or water.
  - d. If the video product does not operate normally by following the operating instructions. Adjust only those controls that are covered by the operating instructions as an improper adjustment of other controls may result in damage and will often require extensive work by a qualified technician to restore the video product to its normal operation.
  - e. If the video product has been dropped or damaged in any way.
  - f. When the video product exhibits a distinct change in performance-this indicates a need for service.
20. **Replacement Parts**-When replacement parts are required, be sure the service technician has used replacement parts specified by the manufacturer or have the same characteristics as the original part. Unauthorized substitutions may result in fire, electric shock or other hazards.
21. **Safety Check**-Upon completion of any service or repairs to this video product, ask the service technician to perform safety checks to determine that the video product is in proper operating condition.
22. **Heat**-This video product should be situated away from heat sources such as radiators, heat registers, stoves, or other products (including amplifiers) that produce heat.

# PRECAUTIONS

## LOCATION

For safe operation and satisfactory performance of your VCR, keep the following in mind when selecting a place for its installation:

- Shield it from direct sunlight and keep it away from sources of intense heat.
- Avoid dusty or humid places.
- Avoid places with insufficient ventilation for proper heat dissipation. Do not block the ventilation holes at the top and bottom of the VCR. Do not place the unit on a carpet because this will block the ventilation holes.
- Install unit in a horizontal position.
- Avoid locations subject to strong vibration.
- Do not place the VCR near strong magnetic fields.
- Do not move the unit from a cold to a hot place or vice versa.

## AVOID THE HAZARDS OF ELECTRICAL SHOCK AND FIRE

- Do not handle the power cord with wet hands.
- Do not pull on the power cord when disconnecting it from AC wall outlet. Grasp it by the plug.
- If, by accident, water is spilled on your VCR, unplug the power cord immediately and take the unit to a Sears Authorized Service Center for servicing.
- Do not put your fingers or objects into the VCR cassette holder.
- Do not place anything directly on top of the VCR.

## WARNING

Moisture condensation may occur inside the unit when it is moved from a cold place to a warm place, or after heating a cold room or under conditions of high humidity. Do not use the VCR until its inside is dry.

**FCC WARNING-** This equipment may generate or use radio frequency energy. Changes or modifications to this equipment may cause harmful interference unless the modifications are expressly approved in the instruction manual. The user could lose the authority to operate this equipment if an unauthorized change or modification is made.

## IMPORTANT COPYRIGHT INFORMATION

Unauthorized recording or use of broadcast television programming, video tape, film or other copyrighted material may violate applicable copyright laws. We assume no responsibility for the unauthorized duplication, use or other acts which infringe upon the rights of copyright owners.

The serial number of this product may be found on the back of the VCR. No others have the same serial number as yours. You should record the number and other vital information here and retain this book as a permanent record of your purchase to aid identification in case of theft.

Date of Purchase	
Dealer Purchased from	
Dealer Address	
Dealer Phone No.	
Model No.	
Serial No.	

# FEATURES

---

- **Rotary 4-head Record /Playback System**– Rotary 4-heads to ensure excellent picture quality and special effects playback.
- **Auto Power On and Off System**– Automatically turns the VCR on as you insert the cassette, turns off after auto-rewind, and ejects when the beginning of the tape is reached.
- **Automatic Rewind**– Automatically rewinds at the end of the tape, except during timer recording.
- **Auto Repeat**– Lets you set the VCR to automatically repeat a tape when it reaches the end.
- **Digital Auto Tracking (DTR)**– Adjusts the tracking automatically for each tape you play.
- **Three Different Record/Playback Speeds**– Select the Standard Play (SP mode), Long Play (LP mode) or Super Long Play (SLP mode) for up to eight hours of recording/playback with a T-160 tape.
- **Automatic Playback Speed Selection**– Automatically selects the proper playback speed.
- **1 Year, 8 events (including Quick Set Program, Daily and Weekly Timer Recording)**– The built-in timer allows you to record up to 7 programs at different times on different channels up to 1 year in advance. The Quick Set Program feature uses program number 8. The daily timer allows recordings to be made of daily broadcasts, and the weekly timer allows recording to be made once a week up to the end of the tape.
- **Quick Set Program**– Allows you to easily record one program within the next 24 hours.
- **OTR (One Touch Recording)**– Instant timed recording from 30 to 480 minutes is possible at the push of OTR button.
- **Rental Play Mode**– Improves playback picture quality of worn tapes, especially rental tapes.
- **2 Step Picture Search Operation**– You can view a video program at a high speed or super high speed in either a forward or reverse direction in LP and SLP mode.
- **STILL**– "Freeze" the picture at any time, for close viewing of a particular scene.
- **181 Channel Capability PLL Frequency Synthesizer Tuner with Direct Channel Entry**– (A converter may be necessary to view scrambled cable channels.)
- **Infrared Remote Control**– Allows you to use most of the controls from a remote location.
- **Real Time Tape Counter**– This shows the elapsed recording or playback time in hours, minutes, and seconds. The "-" indication will appear when the tape is rewound further than the tape counter position "0:00:00".
- **Direct Button Operation**– When a tape is in the VCR and the power is off, just pressing PLAY, REW or F.FWD button on the main unit will automatically turn on the VCR and playback, rewinding or fast-forwarding will start immediately.
- **On-Screen-Programming**– All operating and programming functions appear on your TV screen.
- **Bilingual on screen menu display selectable in English or Spanish**
- **Time Search**– Lets you set the VCR to advance the tape by entering the desired playback time you want to skip.
- **Blank Search**– Lets you set the VCR to search for an unrecorded portion on the tape.
- **Index Search**– Lets you Index the start of a recording.
- **Edit Search**– Lets you set the VCR to edit an unwanted segment of a recording.
- **Just-In-Time Recording**– Measures the remaining tape and automatically adjusts the tape speed so that the automatic timer recording fits on a cassette.
- **Tape Remainder**– You can check the remaining running time of your tape.
- **Slow Motion**– You can view the video program at a slower than normal playback speed. Slow speed can be controlled by pressing F.FWD button (faster) or REWIND button (slower).

# SUPPLIED ACCESSORIES

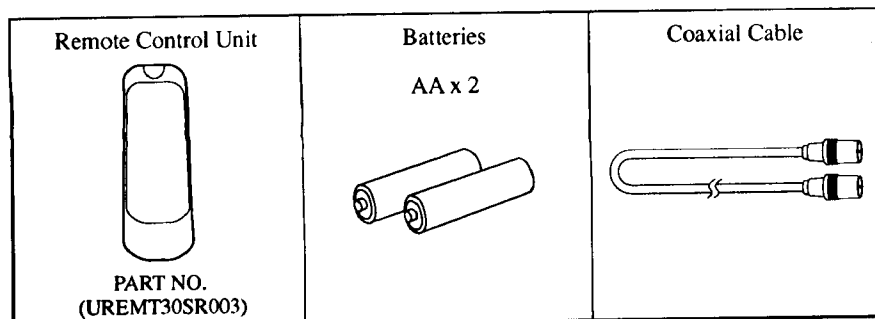

## NOTES:

- If you need to replace these accessories, please refer to the PART NO. under the illustrations and contact the parts department for ordering.
- Depending on your antenna system, you may need different types of Combiners (Mixer) or Separators (Splitter). Contact your local electronics store for these items.

# OPERATING CONTROLS AND FUNCTIONS

## —FRONT VIEW—

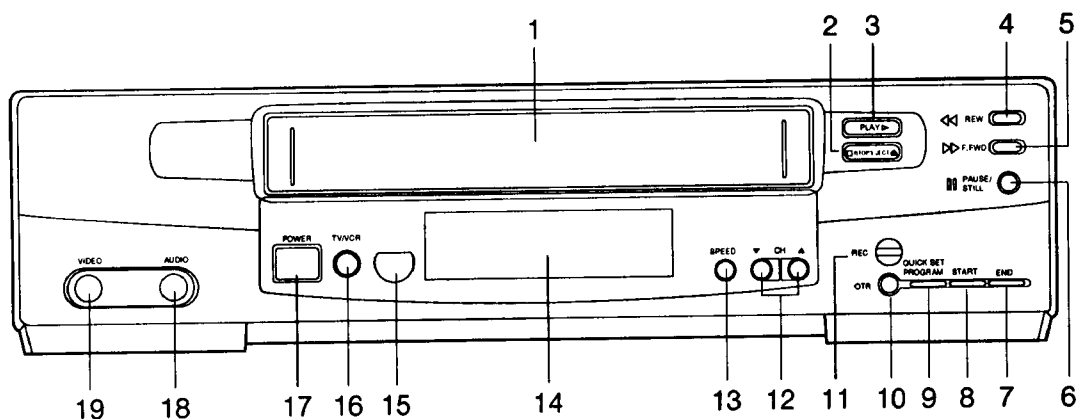

## —REAR VIEW AND TERMINALS—

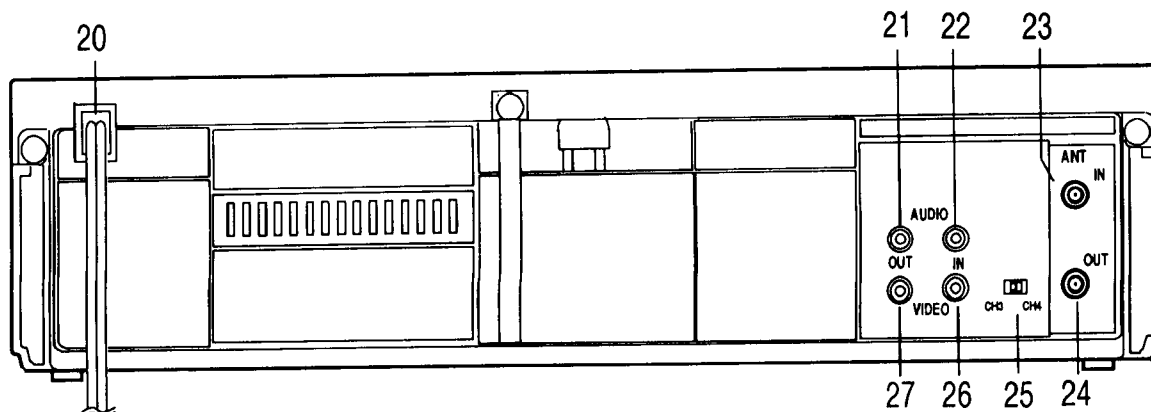

- 1 **Cassette Compartment**
- 2 **STOP/EJECT button**—Press to stop the tape motion. Press again to remove the tape from VCR.
- 3 **PLAY button**—Press to begin playback of a tape.
- 4 **REW(ind) button**—Press to rewind the tape, or to view video in reverse direction at a faster than normal speed. Press PLAY button to return VCR to normal playback speed.
- 5 **F.FWD button**—Press to advance the tape, or to view video in forward direction at a faster than normal speed. Press PLAY button to return VCR to normal playback speed.
- 6 **PAUSE/STILL button**—Press to temporarily stop the tape during recording or to view a still picture during playback.
- 7 **END button**—Press to select desired end time in the Quick Set Program mode.
- 8 **START button**—Press to select desired start time in the Quick Set Program mode.
- 9 **QUICK SET PROGRAM button**—Press to set the Quick Set Program.
- 10 **OTR button**—Press to activate one touch recording mode.
- 11 **REC(ord) button**—Press to begin manual recording.
- 12 **CH(annel) buttons**— Press to select the channel for viewing or recording.  
**TRACKING function**—Press ▲ or ▼ to minimize video ‘noise’ (lines or dots on the TV screen) during tape playback.
- 13 **SPEED button**— Press to set desired tape speed.
- 14 **Digital Display**—Displays the clock, timer recording, counter, channel etc.
- 15 **Remote Sensor window**—Receives the infrared control signals from the handheld remote control unit.
- 16 **TV/VCR button**—Press to select the signal source that your TV will receive.  
**VCR position:** to view playback, to monitor video recordings or watch TV using the VCR tuner.  
**TV position:** to watch TV or to view one program while recording another.
- 17 **POWER button**—Press to turn VCR on and off. Press to activate the automatic timer recording.
- 18 **AUDIO IN jack**—For connection to audio output jack of your audio equipment or another VCR. (Use these jack when selecting the "L2" position, see page 13 "INPUT SELECT".)
- 19 **VIDEO IN jack**—For connection to video output jack of your video camera or another VCR. (Use this jack when selecting the "L2" position, see page 13 "INPUT SELECT".)
- 20 **Power cord**—Connect to a standard AC outlet (120V/60Hz).
- 21 **AUDIO OUT jack**—For connection to the audio in jack of your audio equipment or another VCR.
- 22 **AUDIO IN jack**—For connection to the audio output jack of your audio equipment or another VCR. (Use these jack when selecting the "L1" position, see page 13 "INPUT SELECT".)
- 23 **ANT. IN terminal**—For connection to an antenna or CATV.
- 24 **ANT. OUT terminal**—For connection to an antenna in terminal of your TV.
- 25 **CH3/CH4 selector switch**—Use to select the video output channel (3 or 4) for playback from the VCR.
- 26 **VIDEO IN jack**—For connection to the video output jack of your video camera or another VCR.(Use this jack when selecting the "L1" position, see page 13 "INPUT SELECT".)
- 27 **VIDEO OUT jack**—For connection to the video in jack of video processor or another VCR.

# REMOTE CONTROL OPERATION

You can operate most of your VCR's functions from the Remote Control (included). The buttons on the Remote Control have the same functions as the corresponding buttons on the VCR.

## HOW TO USE THE REMOTE CONTROL

- 1 **POWER/TIMER REC button**—Press to turn VCR on and off. Press to activate the automatic timer recording.
- 2 **NUMBER buttons**—Press to select desired channels and to enter digits for setting program. They cannot be used to set desired channel during Timer Recording. To select channels from 1 to 9, first press "0" button then 1 to 9.  
**+100 button**—Press to select cable channels which are equal or greater than number 100.
- 3 **BLANK SEARCH button** —Press to use Blank Search mode.
- 4 **SLOW button** —Press in playback for slow motion, Slow speed can be controlled by pressing F.FWD button (faster) or REWIND button (slower).
- 5 **MENU button**—Press to display main menu on the TV screen.
- 6 **SELECT button**— Press to select setting modes (TIMER PROGRAMMING, CHANNEL SET UP, SETTING CLOCK, REPEAT PLAY, RENTAL, REMAIN, etc) from menu.
- 7 **REWIND button**—Press to rewind the tape or to view the picture rapidly in reverse during playback. (Rewind Search)  
**SLOW [-] Function** —Press to control speed in slow motion. (slower)
- 8 **RECORD button**—Press to begin manual recording.
- 9 **STOP button**—Press to stop the tape motion.
- 10 **PAUSE/STILL button**—Press to temporarily stop the tape during recording or to view a still picture during playback.  
**F.ADV Function**—Press to advance one frame during pause/still mode. To release, press PAUSE/STILL button again.
- 11 **PLAY button**—Press to playback the tape.
- 12 **F.FWD button**—Press to rapidly advance the tape or to view the picture rapidly in forward during playback. (Forward Search)  
**SLOW [+] Function** —Press to control speed in slow motion. (faster)
- 13 **TAPE COUNTER MEMORY button**—Press to set counter memory on and off.
- 14 **ADD/DELETE button**—Press to add or delete channel numbers. Press to cancel a timer program.  
**TAPE COUNTER RESET button**—Press to reset counter to 0:00:00.
- 15 **INDEX SEARCH** —Press to use Index Search mode.
- 16 **TIME SEARCH button** —Press to use Time Search mode.
- 17 **CHANNEL buttons**—Press to select desired channel by using either ▲ or ▼ button. They cannot be used during Timer Recording.
- 18 **EJECT button**—Press to remove the tape from VCR.
- 19 **TV/VCR button**—Press to select TV or VCR mode.  
**VCR position:** to view playback, to monitor video recordings or watch TV using the VCR tuner.  
**TV position:** to watch TV or to view one program while recording another.



## INSTALLING THE BATTERIES

**1**

Open the battery compartment cover by pressing the cover on the remote unit in the direction of the arrow.

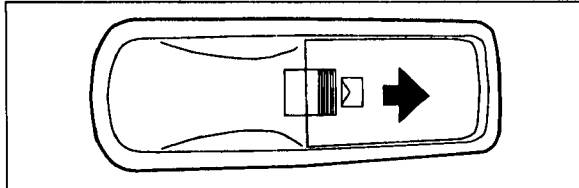

**2**

Insert 2 "AA" penlight batteries into the battery compartment in the direction indicated by the polarity (+/-) markings.

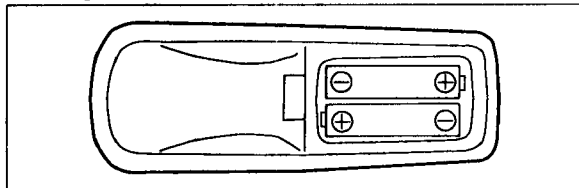

**3**

Replace the cover.

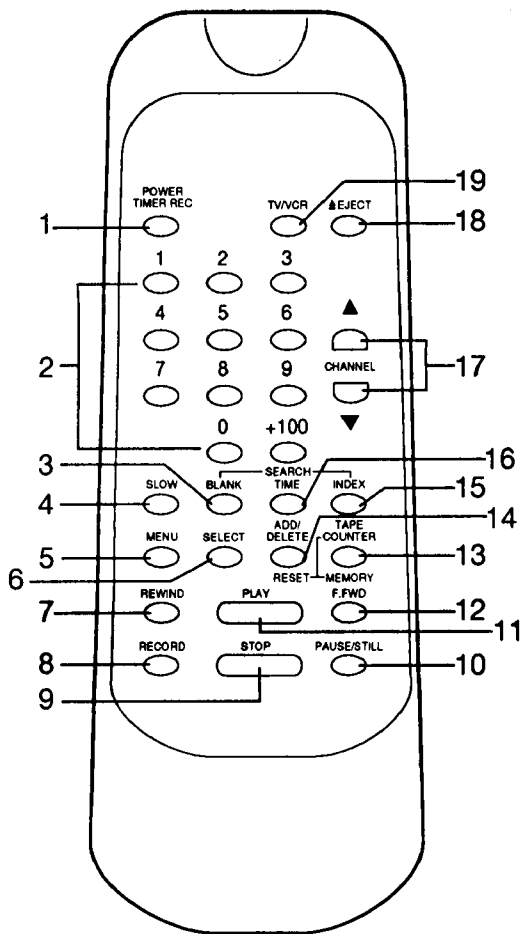
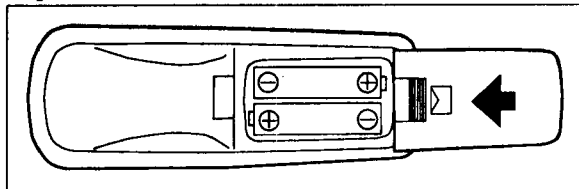

# ANTENNA/CABLE SYSTEM CONNECTIONS

For some of the most common types of connections, see the following drawings. Use only one connection. For any further complex connections, please contact your local dealer or other qualified persons. (You may need additional accessories which are not supplied).

## COMBINATION VHF/UHF ANTENNA

- (1) Disconnect the round 75-ohm combination VHF/UHF coaxial antenna cable from the back of your TV set.
- (2) Reconnect the coaxial cable to ANT. IN terminal of the VCR.
- (3) Connect one end of the COAXIAL CABLE (supplied) to the ANT. OUT jack of the VCR.
- (4) Connect the other end of the COAXIAL CABLE (supplied) to the antenna/cable jack of your TV.

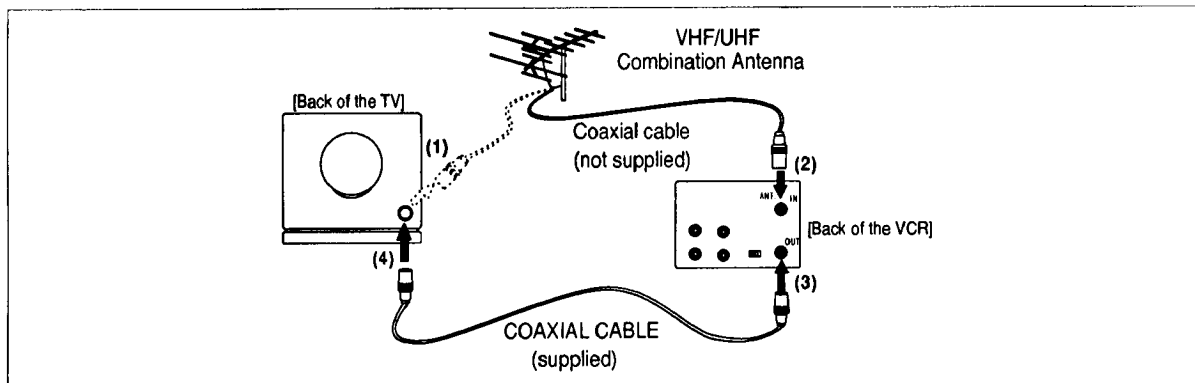

## CATV COAXIAL CABLE

- (1) Disconnect the CATV coaxial cable from the back of your TV set.
- (2) Reconnect the CATV coaxial cable to ANT. IN terminal of the VCR.
- (3) Connect one end of the COAXIAL CABLE (supplied) to the ANT. OUT jack of the VCR.
- (4) Connect the other end of the COAXIAL CABLE (supplied) to the antenna/cable jack of your TV.

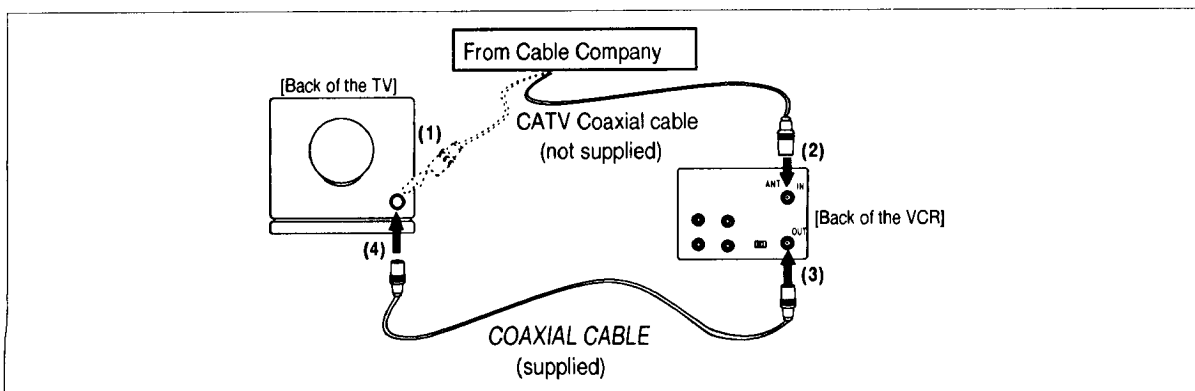

### Note to CATV system installer

This reminder is provided to call the CATV system installer's attention to Article 820-40 of the NEC that provides guidelines for proper grounding and, in particular, specifies that the cable ground shall be connected to the grounding system of the building as close to the point of cable entry as practical.

## SEPARATE VHF (75-OHM) / UHF (300-OHM) ANTENNA

- (1) Disconnect the VHF coaxial antenna cable and the UHF flat twin-lead antenna cable from the back of your TV set.
- (2) Reconnect those cables to a UHF/VHF combiner (not supplied).
- (3) Connect end of the UHF/VHF combiner to the ANT. IN terminal of the VCR.
- (4) Connect one end of the COAXIAL CABLE (supplied) to the ANT. OUT terminal of the VCR.
- (5) Connect the other end of the COAXIAL CABLE (supplied) to a UHF/VHF separator (not supplied).
- (6) Connect the separator's coaxial end to the TV's VHF jack, and flat twin-lead end to the TV's UHF terminal.

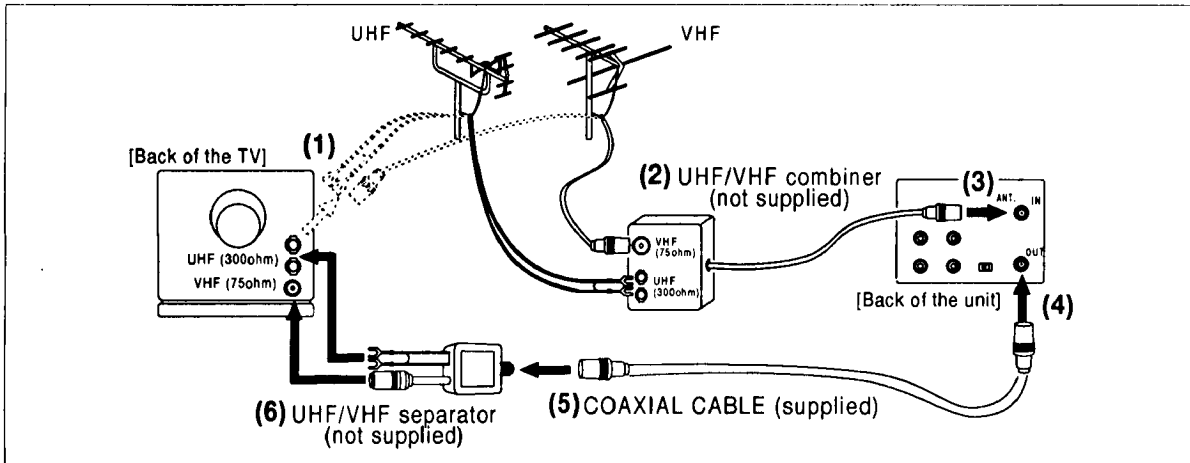

## INDOOR VHF/UHF ANTENNA

- (1) Disconnect the indoor VHF/UHF antenna cable from the back of your TV set.
- (2) Reconnect the cable to the ANT. IN terminal of the VCR.
- (3) Connect one end of the COAXIAL CABLE (supplied) to the ANT. OUT terminal of the VCR.
- (4) Connect the other end of the COAXIAL CABLE (supplied) to the antenna/cable jack of your TV.

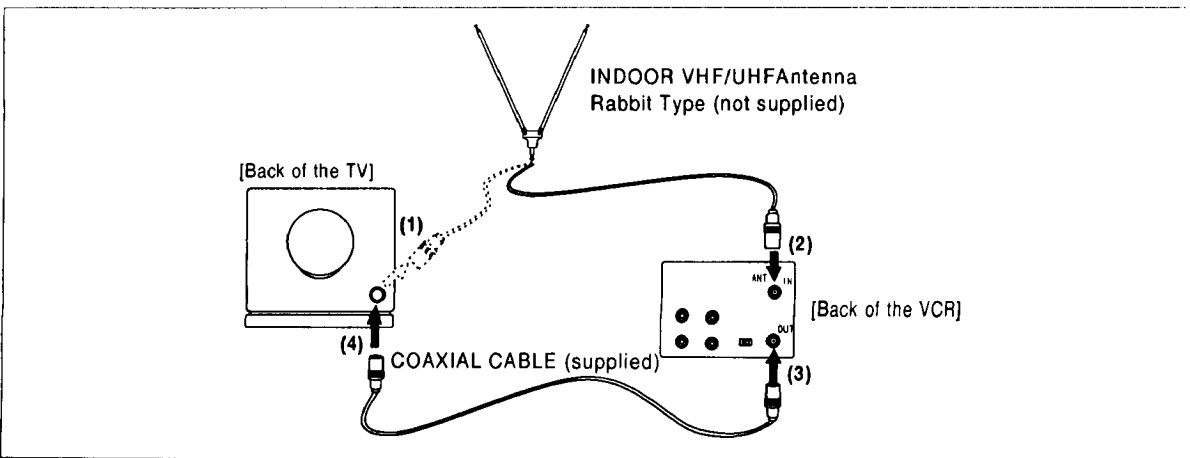

**NOTE:** The connection of an indoor antenna to a VCR may not always give acceptable TV Reception.

## USING A/V JACKS WITH TV/MONITOR (OPTIONAL)

If your TV has A/V input jacks, you may connect your VCR's AUDIO/VIDEO OUTPUT jacks to the audio/video input jacks on back of your TV.

Direct audio/video connections usually result in a better picture and sound quality for tape playback. Please see your TV's owner's manual for details.

Then, set your TV to the Video mode using TV/VCR button on your TV.

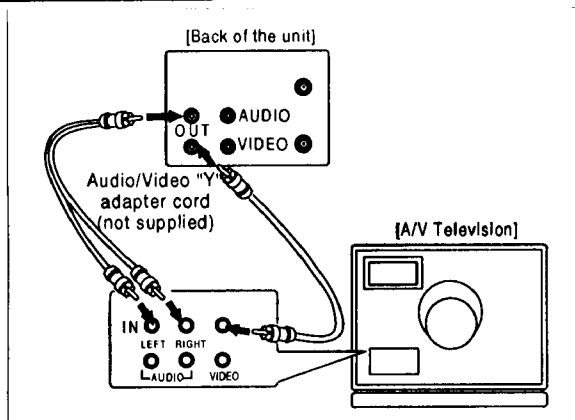

## TO COPY A VIDEO TAPE

Connect the editing (recording) VCR, the source (playing) VCR and your TV using the following diagram.

**NOTE:** You can use the audio and video input jacks on the front panel at editing(recording) VCR instead of using jacks on the back.

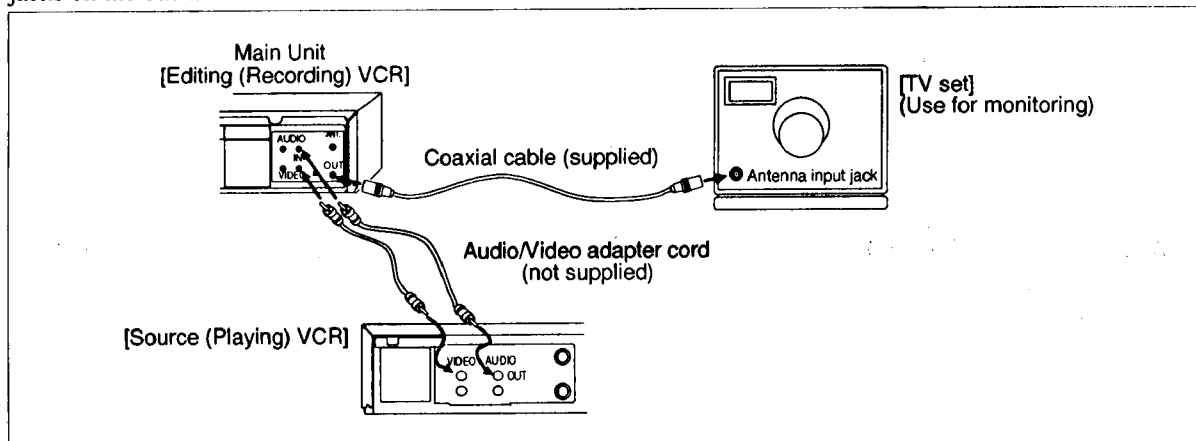

1. Insert a pre-recorded video cassette into the source(playing) VCR.
2. Insert a blank video cassette, or one you want to record over, into the editing(recording) VCR cassette compartment.
3. Press SPEED button on the editing(recording) VCR to select the desired recording speed (SLP, LP or SP).
4. Select L1 or L2 position on the editing(recording) VCR. See page 13, under "Input Select".
5. Press REC button on the editing(recording) VCR.
6. Begin playback of the tape in the source(playing) VCR.

**NOTE:** For best results during dubbing, use the VCR's front panel controls whenever possible. The remote control might affect the playback VCR's operation.

- Always use video-quality shielded cables with RCA-type connectors. Standard audio cables are not recommended.
- You can use a video disc player, satellite receiver, or other audio/video component with A/V outputs in place of the source(playing) VCR.

## TO MONITOR THE RECORDING

1. Turn on the TV and set it to the same output channel as the editing(recording) VCR channel 3 or 4.
2. Press TV/VCR button on the editing(recording) VCR so that "VCR" appears on the display.

## USING A CABLE CONVERTER BOX

If your cable service supplies you with a cable converter box, you can use the basic connection shown below.

### TO RECORD AND VIEW A SCRAMBLED/UNSCRAMBLED CHANNEL.

1. Press TV/VCR button so that "VCR" appears on the display.
2. Set the TV channel to the same video output channel as the switch located on the back of the VCR (CH3 or 4).
3. Set the VCR channel selector to the output channel of the Cable Converter box. (EXAMPLE CH3)
4. Select the channel to be recorded at the Cable Converter Box.

#### NOTES:

- With this connection, you CANNOT record one program while viewing another.
- Channel memory programming is NOT needed when using this connection.

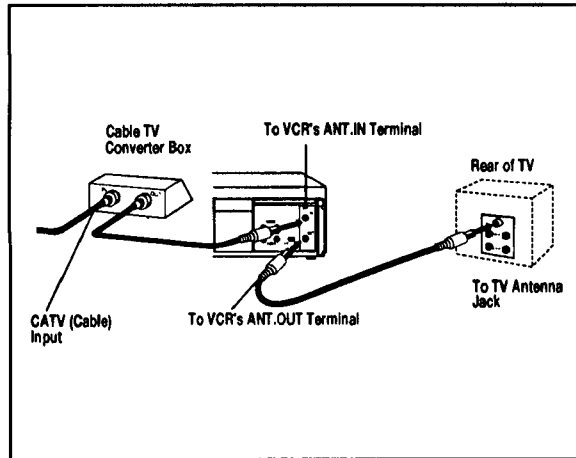

## CONTROLLING VCR INPUT & OUTPUT

### VIDEO OUTPUT CHANNEL SETTING (BACK OF VCR)

When the VCR is in the Playback mode, or when the TV/VCR button is in the VCR position, your TV will receive the signals from the VCR on either channel 3 or 4. Set the 3CH/4CH selector switch to the station that is not used for normal broadcasts in your area; then set your TV to that same channel when viewing from the VCR.



CH3 CH4

The video output channel of this unit is set to channel 3 prior to shipment from the factory.

### INPUT SELECT

To use the external input jacks, select the "L1" or "L2" position.

- If you use the audio and video input jacks **on the back of the unit**, press 0, 0, 1 with number buttons to select the "L1" position.
- If you use the audio and video input jacks **on the front of the unit**, press 0, 0, 2 with number buttons to select the "L2" position.

You can select "L1", "L2" as a channel by using the CHANNEL "▲" or "▼" button.

**Note:** "L1" and "L2" are found before the lowest memorized channel. (Example: CH2)

### VIDEO MODE SELECTION ON TV

TV power must be on. Please see your TV's owner's manual for details.

To Set your TV to the Video Mode	
Connection Using AV Cord (Refer to page 12.)	Set your TV to the Video mode using TV/VCR button of your TV. To set your TV to the TV mode, press TV/VCR button of your TV again.
Connection Without AV Cord (Refer to page 10, 11, 13.)	Set the TV channel to the same video output channel located on the back of the VCR. (CH 3 or 4) Then, set your VCR to the VCR mode using TV/VCR button of your VCR.

# CHANNEL MEMORY PROGRAMMING (Without a Cable Box)

Channel memory programming is NOT needed when connected to a CABLE BOX. You can program the tuner to scan only the channels you receive in your area.

- You must use remote control for this procedure.

## NOTES:

- Follow the steps below, once. Repeat it only if there is a power failure or the VCR is unplugged for more than 3 seconds. In these cases, since the programmed channels are erased, the VCR will prompt you with "--:--" when you turn it on.
- You must follow the steps below before attempting to play or record a video tape. If you want to play or record a video tape **BEFORE** programming the tuner, you must first press POWER button to turn off the VCR. Then, press POWER button again to turn it back on. To program the tuner again, see "To preset channel memory again" on this page.

1

Plug the VCR power cord into a standard AC outlet. The "--:--" flashes.

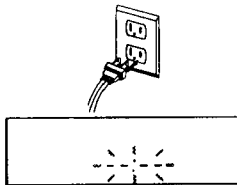

2

Turn on the TV and set the TV channel to the same video output channel located on the back of the VCR. (CH 3 or 4)

After scanning, the tuner stops on the lowest memorized channel.

The VCR distinguishes between standard TV channels and Cable channels. If you subscribe to cable TV, "CATV" appears on the display. (TV mode: from CH2/ CATV mode: from CH1)

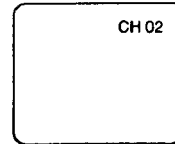
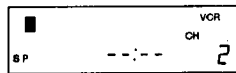

3

Press the POWER button to turn on the VCR so that the "■" appears on the display.

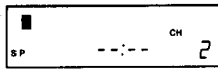

8

The TV screen returns to TV mode.

- If you want to recall the selected channels, you can select the desired channel directly by number buttons on the remote control.
- The TV screen returns to TV mode when you press MENU button in Tuner Set Up mode.

4

Press the TV/VCR button so that "VCR" appears on the display. "LANGUAGE SELECT" appears on the TV screen.

## To preset channel memory again

5

Select 1(ENGLISH) or 2(ESPAÑOL = SPANISH) with number buttons.

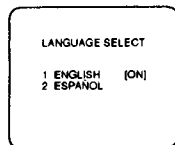

6

Press SELECT or MENU button on the remote control so that "TUNER SET UP" appears on the TV screen.

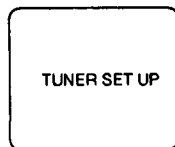

7

Press SELECT button once. The tuner scans and memorizes all the active channels in your area.

- 1 Turn on the VCR.
- 2 Turn on the TV and set the TV channel to the same video output channel located on the back of the VCR. (CH 3 or 4)
- 3 Press the TV/VCR button so that "VCR" appears on the display.
- 4 Press MENU button. Select item 3(INITIALIZE) with number buttons.
- 5 Select item 1(CHANNEL SET UP) with number buttons. And select 1(TV) or 2(CATV) with number buttons.
- 6 Press SELECT button once. After scanning, the tuner stops on the lowest memorized channel.

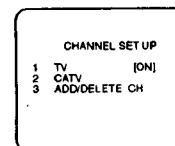

## TO DELETE, ADD PRESET CHANNEL

Use this procedure to delete from memory the channels you no longer receive or seldom watch and to manually add to memory previously deleted channels.

- Turn on the TV and set the TV channel to the same video output channel located on the back of the VCR. (CH 3 or 4)
- Press the TV/VCR button so that "VCR" appears on the display.

### DELETING PRESET CHANNELS

**1**  
Press MENU button on the remote control. Select item 3(INITIALIZE) with number buttons.

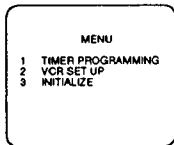

**2**  
Select item 1(CHANNEL SET UP) with number buttons.

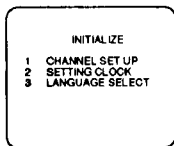

**3**  
Select item 3(ADD/DELETE CH) with number buttons.

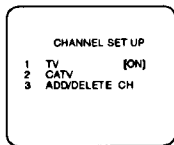

**4**  
Enter the desired channel using the number buttons. The channel flashes.

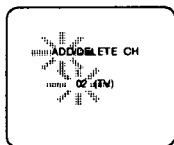

You must precede single-digit channel numbers with a zero (02, 03, 04 and so on).

**5**  
Press ADD/DELETE button so that "DELETE" flashes on the display. The channel is deleted from the VCR.

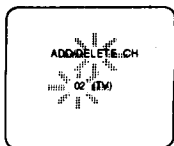

- For next channel you wish to delete, select that channel and follow step [5].
- If you press ADD/DELETE button again, the channel is memorized again.

**6**  
Press MENU button. The TV screen returns to TV mode.

- To check the channel(s) that has been deleted, press CHANNEL ▲ or ▼ button.

### ADDING PRESET CHANNELS

**1**  
Press MENU button on the remote control. Select item 3(INITIALIZE) with number buttons.

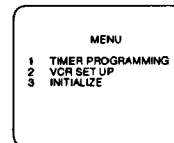

**2**  
Select item 1(CHANNEL SET UP) with number buttons.

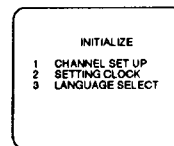

**3**  
Select item 3(ADD/DELETE CH) with number buttons.

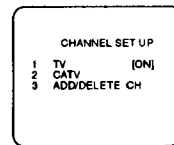

**4**  
Enter the desired channel using the number buttons. The channel flashes.



You must precede single-digit channel numbers with a zero (02, 03, 04 and so on).

**5**  
Press ADD/DELETE button so that "ADD" flashes on the display. The channel is added to the VCR.



- For next channel you wish to add, select that channel and follow step [5].
- If you press ADD/DELETE button again, the channel is deleted again.

**6**  
Press MENU button. The TV screen returns to TV mode.

- To check the channel(s) that has been added, press CHANNEL ▲ or ▼ button.

# SETTING THE CLOCK

Set the clock accurately for proper automatic timer recording. We suggest that you use a TV or radio station as your time source.

- VCR Power must be on.
- Turn on the TV and set the TV channel to the same video output channel located on the back of the VCR. (CH 3 or 4)
- Press the TV/VCR button so that "VCR" appears on the display.
- You must use remote control for this procedure.

In the example below, the clock is to be set to:

DATE Wednesday 1st March, 1995  
 SETTING TIME 5:40PM

**1**  
 Press MENU button on the remote control. The main menu appears on the TV screen.

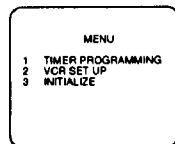

**2**  
 Select item 3(INITIALIZE) with number buttons.



**3**  
 Select item 2(SETTING CLOCK) with number buttons. The MONTH digits flash.

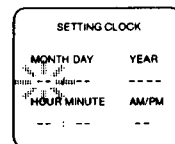

**4**  
 Enter your desired MONTH with number buttons.

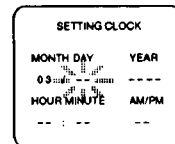

**5**  
 Enter your desired DAY with number buttons.

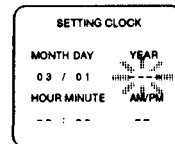

**6**  
 Enter your desired YEAR with number buttons.

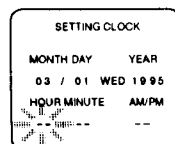

The day of the week will change automatically.

**7**  
 Enter your desired HOUR with number buttons.

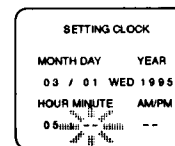

**8**  
 Enter your desired MINUTE with number buttons.

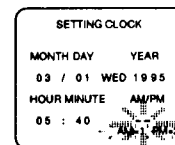

**9**  
 Select AM(1) or PM(2) with number buttons.

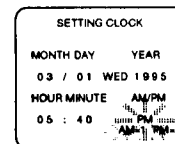

Press ADD/DELETE button to go back one step from current step during steps [4] to [9].

**10**  
 Press MENU or SELECT button to start the clock.

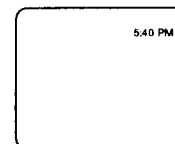

Although seconds are not displayed, they begin counting at 00 when you press them. Use this feature to synchronize the clock as accurately as possible.

This unit has a built in calendar up to the year 2009.

- When unplugging the AC-cord or if there is a power failure for more than 3 seconds, "- : -" flashes on the display.
- If the display shows an abnormal reading or no reading, unplug the power cord for more than 3 seconds. Then plug it back in.



## TO CHANGE CLOCK SETTING

If you want to change the clock,

- 1 Turn on the VCR.
- 2 Turn on the TV and set the TV channel to the same video output channel located on the back of the VCR. (CH 3 or 4)
- 3 Press the TV/VCR button so that "VCR" appears on the display.
- 4 Press MENU button. Select item 3(INITIALIZE) with number buttons.
- 5 Select item 2(SETTING CLOCK) with number buttons.
- 6 Select desired digit with SELECT button.
- 7 Enter correct numbers with number buttons.
- 8 Press MENU button to return to original mode.

## CHECKING THE REMAIN, COUNT, CLOCK AND CHANNEL NUMBER

To check the Remain, Count, Clock and Channel number on the TV screen or display, press SELECT button. Each time you press SELECT button, TV screen or display will change as follows:

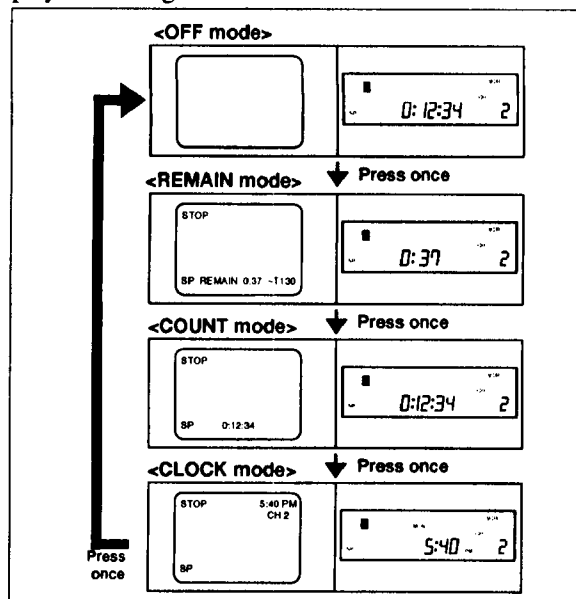

## TO CHANGE THE LANGUAGE

- VCR Power must be on.
- Turn on the TV and set the TV channel to the same video output channel located on the back of the VCR. (CH 3 or 4)
- Press the TV/VCR button so that "VCR" appears on the display.
- You must use remote control for this procedure.

**1**

Press MENU button on the remote control. The main menu appears on the TV screen.

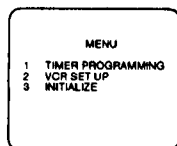

**3**

Select item 3(LANGUAGE SELECT) with number buttons.



**4**

Select 1(ENGLISH) or 2(ESPAÑOL - SPANISH) with number buttons.



**2**

Select item 3(INITIALIZE) with number buttons.

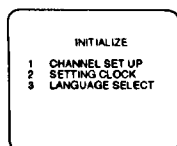

**5**

Press MENU button. The TV screen returns to TV mode.

# VIEWING AND RECORDING THE SAME PROGRAM

- VCR Power must be on.
- Turn on the TV and set the TV channel to the same video output channel located on the back of the VCR. (CH 3 or 4)
- Press the TV/VCR button so that "VCR" appears on the display.

**1**

Insert a cassette tape with the erase-protection tab, if necessary, rewind or fast forward the tape to the point at which you want to begin recording.

Counter mode appears at counter 0:00:00 on the display.

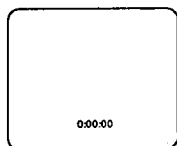

**2**

Select the channel to be recorded by pressing the number buttons on the remote control or the CHANNEL ▲ or ▼ button.

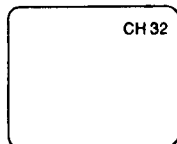

**3**

Press SPEED button on the VCR to select the desired tape speed (SP-LP-SLP).

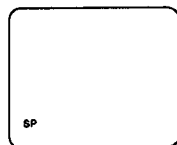

**4**

Press REC button. The red "O" indicator lights on the display.

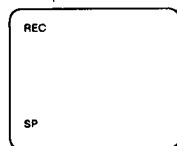

**5**

Press STOP button when recording is completed.

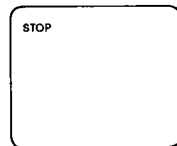

## TO DELETE SCENES DURING RECORDING

**1**

While VCR remains in record mode, press PAUSE button.

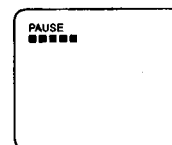

**Note:** If you do not press PAUSE button again within five minutes, VCR will automatically return to Stop mode. You may review the time remaining with "■" marks on the display. Each "■" mark shows one minute.

**2**

Press PAUSE or REC button to resume recording.

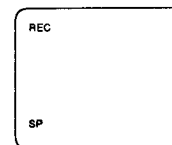

## EDIT SEARCH

To edit an unwanted segment from the already recorded portion of tape while VCR remains in record mode.

**1**

While VCR remains in record mode, press PAUSE button.

**2**

Press and hold REWIND button until you have reached the beginning of the unwanted segment. (If you rewind past the beginning of the unwanted segment, press and hold F.FWD button until you have reached it.)

**Note:** If you do not press PAUSE button again within five minutes, VCR will automatically return to Stop mode.

**3**

Press PAUSE or REC button to resume recording.

# RECORDING ONE PROGRAM WHILE VIEWING ANOTHER

You can record one program while viewing another. To start recording, follow steps [1] to [4] under "VIEWING AND RECORDING THE SAME PROGRAM" on page 18.

**5**

If you set the TV channel to 3 or 4 channel, press TV/VCR button so that "VCR" disappears from the display.



- If you connect VCR to TV using AV cord, set your TV to the TV mode using TV/VCR button of your TV.

**6**

Set the TV to the channel you want to watch (leave the VCR tuned to the channel you want to record).

## TO MONITOR THE PROGRESS OF YOUR RECORDING,

**7**

If you set the TV channel to 3 or 4 channel, press TV/VCR button so that "VCR" appears on the display.

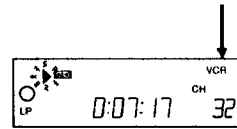

**8**

Turn on the TV and set the TV channel to the same video output channel located on the back of the VCR. (CH 3 or 4)

- If you connect VCR to TV using AV cord, set your TV to the VCR mode using TV/VCR button of your TV.

# AUTOMATIC TIMER RECORDING

You may set the VCR to start and end a recording while you are away. You can set seven events to record on specific days, daily or weekly within a 1 year period.

- VCR Power must be on.
- Turn on the TV and set the TV channel to the same video output channel located on the back of the VCR. (CH 3 or 4)
- Press the TV/VCR button so that "VCR" appears on the display.
- Clock must be set to the correct time and date before setting the timer.
- You must use remote control for this procedure.

In the example below, the timer is being set to record:

DATE	Saturday 6th May, 1995	CHANNEL	CH61
SETTING TIME	from 7:30AM to 8:50AM	TAPE SPEED	LP

**1**

Insert a cassette tape with the erase-protection tab, if necessary, rewind or fast forward the tape to the point at which you want to begin recording.

**2**

Press MENU button on the remote control. The main menu appears on the TV screen.

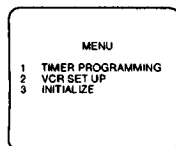

**3**

Select item 1(TIMER PROGRAMMING) with number buttons.

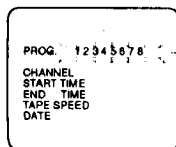

**4**

Select your desired program number with number buttons.

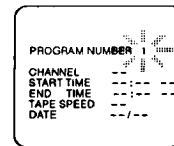

The program number 8 is used for setting Quick Set Program only. You cannot select number 8 in the procedure of Automatic Timer Recording.

**5**

Press SELECT button on the remote control.

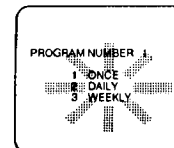

6

Select item 1(ONCE) with number buttons. The CHANNEL digits flash.

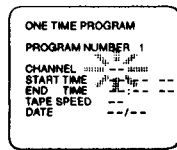

7

Enter your desired CHANNEL with number buttons.



8

Enter your desired HOUR with number buttons.

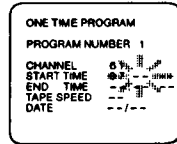

9

Enter your desired MINUTE with number buttons.

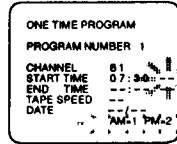

10

Select AM(1) or PM(2) with number buttons.

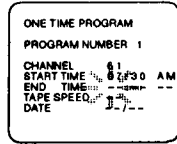

11

Repeat steps [8]-[10] to set the end time.

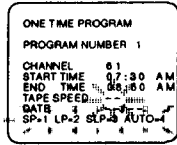

12

Select your desired recording speed SP(1), LP(2), SLP(3) or AUTO(4) with number buttons.

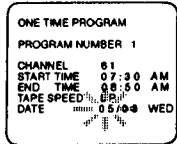

- AUTO(4) is available only with Program No. 1.
- See "Just-In Time Recording" on page 28 for the use of AUTO(4) setting.

13

Enter your desired MONTH with number buttons.

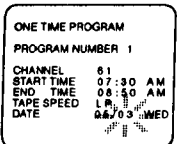

14

Enter your desired DAY with number buttons. The day of the week will change automatically.

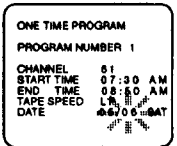

15

Press MENU button. Program 1 is now completed.

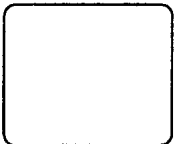

To set another program, repeat steps [2] to [15] starting on page 19.

16

Press POWER/TIMER REC button. The "☑" indicator appears on the display. The number of all programmed events are displayed with current time.

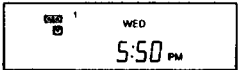

NOTES:

- When the programs overlap, the earliest program has priority.
- When the earliest program has finished and the programs which should start still overlap, the recording will start in order of the program number.

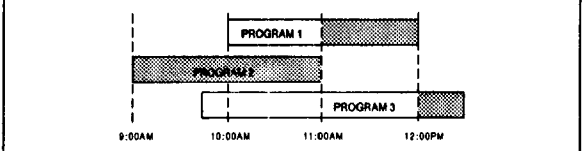

If you programmed as per the above illustration the timer recording would be carried out as follows:  
9:00AM - 11:00AM for PROGRAM 2  
11:00AM - 12:00PM for PROGRAM 1  
12:00PM - for PROGRAM 3

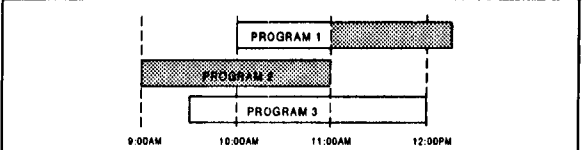

If you programmed as per the above illustration the timer recording would be carried out as follows:  
9:00AM - 11:00AM for PROGRAM 2  
11:00AM - for PROGRAM 1

## DAILY PROGRAM (MONDAY~SUNDAY)

To record a program at the same time on the same channel every day, follow steps [1] to [5] on page 19, then step [6a] below.

**6a**

Select item 2(DAILY) with number buttons.

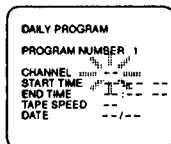

Continue with step [7] on page 20 onwards.

## WEEKLY PROGRAM

To record a program at the same time on the same channel every week, follow steps [1] to [5] on page 19, then step [6b] below.

**6b**

Select item 3(WEEKLY) with number buttons.



Continue with step [7] on page 20 onwards.

## TO CORRECT OR CANCEL A PROGRAM

- Press ADD/DELETE button to go back one step from current step during steps [5]~[14].
- If you finished setting program, repeat steps [2] to [4] on page 19. Then press SELECT button repeatedly until your desired digit flashes and reset program.
- You may cancel the entire program by pressing ADD/DELETE button at step [5].

## CHECKING TIMER PROGRAMS

To check a program that is to be recorded using the Automatic Timer Program when the VCR is in the timer-record mode:

- 1) Turn on the TV and set the TV channel to the same video output channel located on the back of the VCR. (CH 3 or 4)
- 2) Press POWER/TIMER REC button so that the "☑" indicator *disappears* from the display.
- 3) Press the TV/VCR button so that "VCR" appears on the display.
- 4) Follow instructions in steps [2] to [5] on page 19. Information which was set for programming will now appear.

## TO STOP RECORDING

Press STOP button on the VCR.

- If you are recording using the Automatic Timer Program, you may not operate the unit manually, but, you may still stop the recording by pressing STOP/EJECT button on the VCR.

**NOTE:** STOP button on the remote control will not function in the Automatic Timer Recording mode.

## AUTOMATIC TIMER RECORDING HINTS

- If there a power failure or the VCR is unplugged for more than 3 seconds, the clock setting and all timer settings are lost.
- If the tape runs out before the end time, the VCR will switch to the Stop mode immediately, eject the tape and the VCR power will be turned off. The "☑" indicator will flash.
- If a tape is not inserted or the erase-protection tab is removed, the "☑" indicator flashes and automatic timer recording cannot occur. Insert a tape that allows recording.
- The TV that is connected to your VCR may be turned ON or OFF when the VCR is in the timer-record mode.

# QUICK SET PROGRAM

You may set the VCR to start and end recording one program within 24 hours by simply pressing QUICK SET PROGRAM button on the VCR. It is easy for you to set the timer for recording today's TV program.

- VCR power must be on to set Quick Set Program.
- Clock must be set to the correct time before setting the timer.
- Quick Set Program controls program number 8.

In the example below, the Quick Set Program is being set to record (current time is 6:00PM):

SETTING TIME      from 9:30PM to 11:00PM  
CHANNEL            CH61  
TAPE SPEED        LP

**NOTE: This function cannot be done by the remote control.**

**1**

Insert a cassette tape with its safety tab in place. (If necessary, rewind or fast forward the tape to the point at which you want to begin recording.)

The VCR display will change to the count mode.

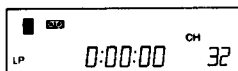

**2**

Press QUICK SET PROGRAM button on the VCR. Program number "8" appears on the display.

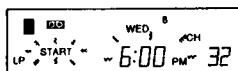

**3**

Set the desired start time. Press START button repeatedly or hold it down until your desired start time is displayed.

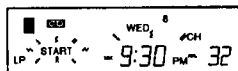

**4**

Set the desired end time. Press END button repeatedly or hold it down until your desired end time is displayed.

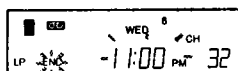

**5**

Set the channel number. Press CHANNEL ▲ or ▼ button repeatedly or hold it down until your desired channel number is displayed.

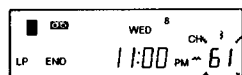

**6**

Set the tape speed. Press SPEED button until your desired tape speed is displayed.

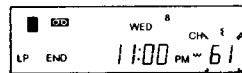

(AUTO=no display, SP, LP or SLP)

- The tape speed can be changed at any step from [2] to [5].

**7**

Press QUICK SET PROGRAM button to return to original mode.

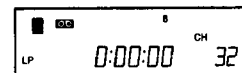

**8**

Press POWER/TIMER REC button to set Quick Set Program.

This turns the VCR power off, and the "ⓧ" indicator lights up on the display. The program number "8" is displayed with current time.

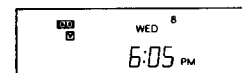

When the programs overlap, Quick Set Program has priority. But if an another program has been activated when the start time of the Quick Set Program comes, the Quick Set program will be begun after finished the faster program.

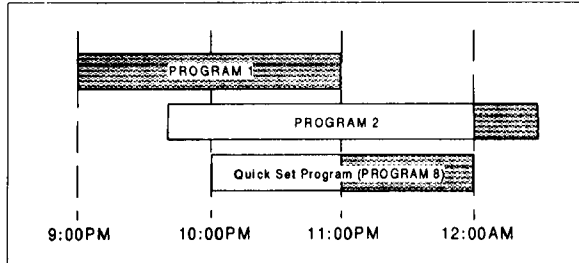

If you program as per the illustration the timer recording would be carried out as follows.

9:00AM - 11:00AM for PROGRAM 1  
 11:00AM - 12:00PM for PROGRAM 8  
 (Quick Set Program)  
 12:00PM - for PROGRAM 2

## TO CHECK THE START/END TIME

To check the start/end time and channel number, first press POWER/TIMER REC button so that "☑" indicator appears, then press QUICK SET PROGRAM button once. Both the start and end time will appear for 3 seconds each, and return to the Timer Stand-by mode.

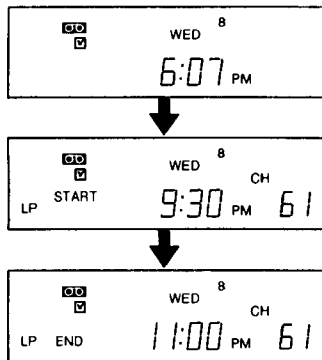

## TO CANCEL A QUICK SET PROGRAM

- **While setting a program;** press STOP/EJECT button on the VCR.
- **After setting a program;** (power must be on) First, press QUICK SET PROGRAM button. Then, press STOP/EJECT button.
- **While recording is in progress;** press STOP/EJECT button.

## HINTS

- If there is a power failure or the VCR is unplugged for more than 3 seconds, the clock setting and all timer settings will be lost.
- If the tape runs out before the end time, the VCR will switch to the Stop mode immediately, eject the tape and the VCR power will be turned off. The "☑" indicator will flash.
- If a tape is not inserted or the erase-protection tab is removed, the "☑" indicator flashes and automatic timer recording cannot occur. Insert a tape that allows recording.
- The TV that is connected to your VCR may be turned ON or OFF when the VCR is in the timer-record mode.

# INDEX SEARCH

This feature provides a method of indexing the starting point so that it can be easily returned to in either fast forward or rewind mode.

- The index mark will be made automatically when the REC button is pressed. It will also be marked at the starting point of Timer recording and OTR.
- The index mark is not recorded if the PAUSE/ STILL button is pressed and released during recording.
- The time gap between making the index marks on the tape should be greater than 1 minute for SP recording, 2 minutes for LP recording and 3 minutes for SLP recording.

## NOTES:

- VCR Power must be on.
- Turn on the TV and set the TV channel to the same video output channel located on the back of the VCR. (CH 3 or 4)
- Press the TV/VCR button so that "VCR" appears on the display.
- You must use remote control for this procedure.

**Example:** You are watching program number 4 and want to fast forward to program number 7. You must skip three programs.

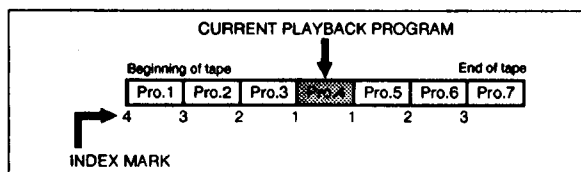

**1**

Press INDEX SEARCH button. Index Search mode appears on the TV screen.



**4**

When the preset program is reached, normal playback will start.



**2**

Press the number button corresponding to the number of programs that you want to skip.



To correct the Index number, press DELETE button and re-enter the correct number.

**3**

Press REWIND or F.FWD button. The VCR begins rewinding or fast forwarding then goes into playback mode at the beginning of desired program.

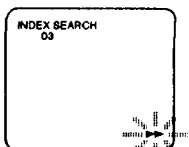

## Notes:

- Index search can be set up to 20.
- This function is not operative in recording mode.
- Procedures must be followed within 30 seconds, from steps [1] to [2]. Otherwise the Index Search mode will be cancelled.
- A video cassette must be inserted in the VCR for this function to work.
- Press STOP button on the VCR or remote control unit to exit the Index Search mode.

**Note:** Every time an index signal is skipped, the number in the program indicator decreases by one.



# TIME SEARCH

The Time Search function makes it possible to quickly advance the tape from any position by entering the exact desired amount of playback time of the part that you want to skip.

- VCR Power must be on.
- Turn on the TV and set the TV channel to the same video output channel located on the back of the VCR. (CH 3 or 4)
- Press the TV/VCR button so that "VCR" appears on the display.
- You must use remote control for this procedure.

**Example:** To watch a program after 2 hours 53 minutes from present position to forward direction.

**1**  
Press TIME SEARCH button. The HOUR digits flash.



**2**  
Enter the desired hour with number buttons.



**3**  
Enter the desired minutes with number buttons.



**To correct the time, press DELETE button and repeat steps [1] to [3].**

**4**  
Press F.FWD or REWIND button. The tape will move to the specified point.

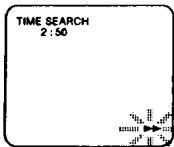

**Note:** The time counts down as the searching progresses.

**5**  
When 0:00 is reached, the tape will start playback automatically.



## Notes:

- Time search can be set up to 9:59.
- Procedures must be followed within 30 seconds from steps [1] to [3]. Otherwise the Time Search mode will be cancelled.
- This function is not operative in recording mode.
- A video cassette must be inserted in the VCR for this function to work.
- Press STOP button on the VCR or remote control unit to exit the Time Search mode.

# BLANK SEARCH

This function enables you to search for the unrecorded portion of the tape in the forward direction.

- Tape must be fully rewound.
- VCR Power must be on.
- Turn on the TV and set the TV channel to the same video output channel located on the back of the VCR. (CH 3 or 4)
- Press the TV/VCR button so that "VCR" appears on the display.
- You must use remote control for this procedure.

**1**

Press **BLANK SEARCH** button. Blank Search function starts automatically in the forward direction.

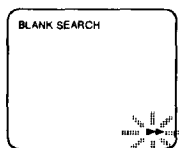

**2**

The VCR begins fast forwarding to the beginning of the blank part of the tape.

The tape will automatically stop.



## Note:

- A video cassette must be inserted in the VCR for this function to work.

# SETTING THE REMAINING TIME

You can set the remaining tape running time of your tape.

- If your cassette tape length is T-130 or less, select "~T130". For example, the popular T-120 cassette tape calls for the "~T130" selection. If your cassette tape is T-140 or greater, select "T140~". Then the tape remaining indication will be correct.

## NOTES:

- VCR Power must be on.
- Turn on the TV and set the TV channel to the same video output channel located on the back of the VCR. (CH 3 or 4)
- Press the TV/VCR button so that "VCR" appears on the display.
- You must use remote control for this procedure.

1

Press MENU button. Select item 2(VCR SET UP) with number buttons.

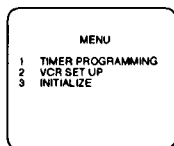

2

Select "~T130" or "T140~" with 1 button.

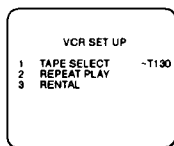

3

Press MENU button to return to normal mode.

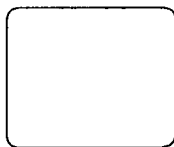

4

To check the remain time, press SELECT button on the remote control unit until REMAIN appears on TV screen.

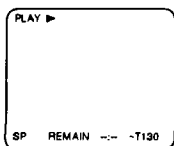

## Notes:

- In the Remain Time Mode calculating will start when the cassette tape is inserted and PLAY button is pressed.  
While calculating, the TV screen shows as illustrated.
- A video cassette must be inserted in the VCR for this function to work.

## REMAINING TAPE RUNNING TIME DISPLAY

- Since the reel diameter and tape thickness are not common to all cassettes, the time count differs from cassette to cassette. Use the time display as an informative number only.
- During recording, the remaining tape running time is estimated based on the current recording mode (SP, LP, SLP).
- During playback the remaining tape running time is calculated based on the current playback mode.
- Remain time will not appear on TV screen while in the Fast forward or Rewind Mode.
- There will be a delay of up to 1 minute before the remain time appears on the TV display.

### Note:

The use of the following tapes will result in difference between the displayed remaining time and actual time to the end of the tape:

- Tape housed in a VHS-C cassette adapter.
- Shorter tape length such as a 10-minute cassette
- T-180 cassette. In this case the display may read 2 Hours, 40 Minutes at the start point of the tape in SP mode.

# JUST-IN TIME RECORDING

This function allows you to fully utilize the available tape length for timer recording. The VCR calculates the remaining tape amount and then adjusts the tape speed from SP to SLP as needed.

If it is suspected that the end of the tape will be reached before the reserved program ends (as long as SP mode is kept all the way), set recording mode to AUTO. This function is available only with Program No. 1 and Quick Set Program.

The auto mode starts recording in SP mode. The internal circuit compares the rest of the program against the available tape length. If the internal circuit determines that the available tape is not long enough to record the program in the SP mode, the Recording mode is automatically changed to SLP mode. This will assure coverage of the desired timer program before the end of the tape is reached.

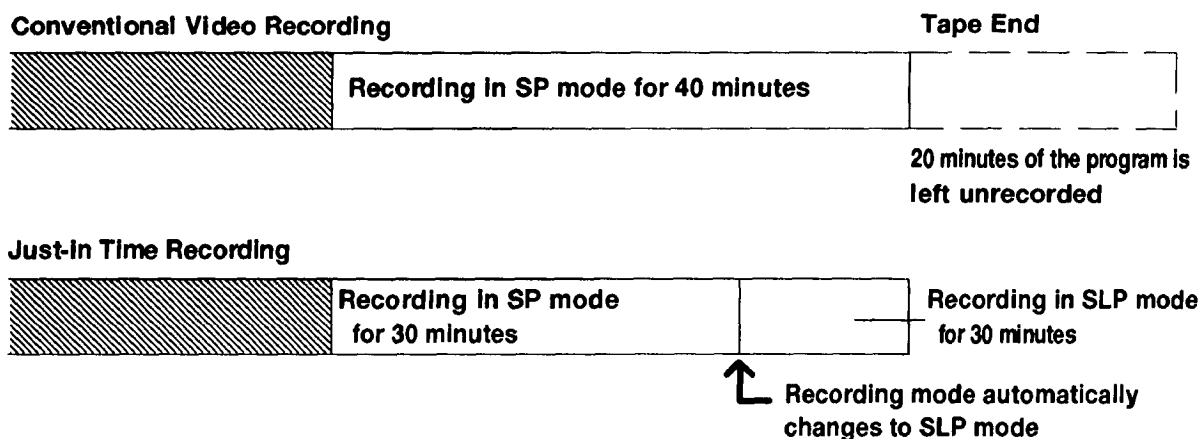

## Notes:

- Set the tape remainder switch ("~T130" or "T140~") to the tape loaded.
- Even if SLP mode is selected, just-in time recording cannot compensate for a tape length which may be too short.
- A momentary picture break up will occur at the point on the tape when the recording speed changes from SP to SLP.
- The displayed remaining tape running time may not always match the actual remaining time on the tape (usually longer than the actual time). It is recommended to set the end of the reserved recording time several minutes after the end of the TV program.

# OTR (ONE TOUCH RECORDING)

The One Touch Recording function enables you to record a program simply by pressing OTR button on the VCR. According to the table, simply press OTR button as many times as needed to set the desired recording length. The channel number to be recorded and recording length will be shown on the display.

**NOTE: This function cannot be done by the remote control.**

**1**

Turn on the VCR.

**2**

Set the VCR to the channel to be recorded.

**3**

Press OTR button.

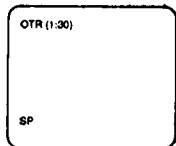

Recording starts immediately when the OTR button is pressed, at least two times whether if you are watching the same or a different channel. The recording length will be determined by the number of times you press OTR button.

PUSH(ES)	DISPLAY	LENGTH
1 push	0:00	0:00
2 pushes	0:30	30 minutes
3 pushes	1:00	60 minutes
4 pushes	1:30	90 minutes
5 pushes	2:00	120 minutes
6 pushes	2:30	150 minutes
7 pushes	3:00	180 minutes
8 pushes	3:30	210 minutes
9 pushes	4:00	240 minutes
10 pushes	4:30	270 minutes
11 pushes	5:00	300 minutes
12 pushes	5:30	330 minutes
13 pushes	6:00	360 minutes
14 pushes	6:30	390 minutes
15 pushes	7:00	420 minutes
16 pushes	7:30	450 minutes
17 pushes	8:00	480 minutes
18 pushes	0:00	0:00

- Each time you press OTR button, you will extend the recording time by 30 minutes at a time up to 8-hours (or to the end of the tape).
- When OTR button is pressed 18 times, the VCR will switch to the Stop mode immediately and the VCR power will be turned off.
- To stop the OTR operation, press STOP button.
- The recording length time remaining is indicated on the display as the recording is started.
- Recording stops when 0:00 is reached.
- Please note that in the SLP mode maximum recording time, assuming the tape is started at the beginning, is 8 hours using T-160 (or 6 hours using T-120).
- The TV that is connected to your VCR may be turned on or off during OTR recording.

## MONITORING RECORDING

**1**

If you set the TV channel to 3 or 4 channel, press TV/VCR button so that "VCR" appears on the display.

**2**

Turn on the TV and set the TV channel to the same video output channel located on the back of the VCR. (CH 3 or 4)

- If you connect VCR to TV using AV cord, set your TV to the VCR mode using TV/VCR button of your TV.

# PLAYBACK

**1**

Turn on the TV and set the TV channel to the same video output channel located on the back of the VCR. (CH3 or 4)

**2**

Insert a tape. VCR will automatically turn on. Press PLAY button.

(If the erase-protection tab has been removed, the VCR will start playback automatically.)

**3a**

If a tape is already in the VCR, **press PLAY button on the VCR**. Power will turn on and playback will start automatically. (Direct Button Operation)

**3b**

If a tape is already in the VCR, **Press POWER button to turn on, and then press PLAY button on the remote control**.

**4**

Press STOP button when playback is completed.

# AUTO REPEAT PLAYBACK

The VCR has an auto repeat function that allows you to repeat a tape indefinitely.

- VCR Power must be on.
- Turn on the TV and set the TV channel to the same video output channel located on the back of the VCR. (CH 3 or 4)
- Press the TV/VCR button so that "VCR" appears on the display.
- You must use remote control for this procedure.

**1**

Press MENU button on the remote control. Select item 2(VCR SET UP) with number buttons.

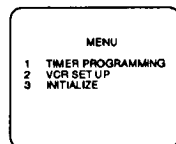

**2**

Select item 2(REPEAT PLAY) with number buttons.

"ON" will appear next to "REPEAT PLAY".

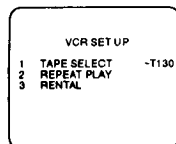

**3**

Repeat playback will start automatically.



## TO EXIT THE REPEAT PLAY MODE

Repeat steps [1] and [2]. "ON" will then disappear from the menu.

**Note:** Once you select the repeat play mode, it stays in effect even after you turn off the VCR.

# RENTAL PLAY

This function enables you to improve the picture quality when playing back worn cassettes such as those rented from a video shop.

- VCR Power must be on.
- Turn on the TV and set the TV channel to the same video output channel located on the back of the VCR. (CH 3 or 4)
- Press the TV/VCR button so that "VCR" appears on the display.
- You must use remote control for this procedure.

## TO EXIT THE RENTAL PLAY MODE

Repeat steps [1] to [3]. Then, follow step [4], but select "OFF" for normal playback.

**1**

Insert rental tape into VCR. VCR will automatically start tape playback.

**2**

Press MENU button on the remote control. Select item 2(VCR SET UP) with number buttons.

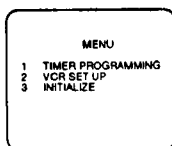

**3**

Select item 3(RENTAL) with number buttons.

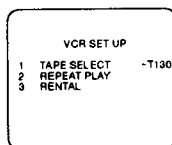

**4**

Press SELECT button repeatedly to select "ON".



### NOTES:

- Once you select the rental play mode, it stays in effect even after you turn off the VCR.
- Selecting ON or OFF must be done in the play mode only.

# COUNTER MEMORY

The TAPE COUNTER MEMORY button can be used during rewind or fast forward to automatically stop the tape when the counter reaches a preset memory position of approx. 0:00:00.

For example, this feature can be used to return the tape to a pre-selected position immediately after recording, or to repeatedly playback a certain portion of a tape.

**NOTE: You must use remote control for this procedure.**

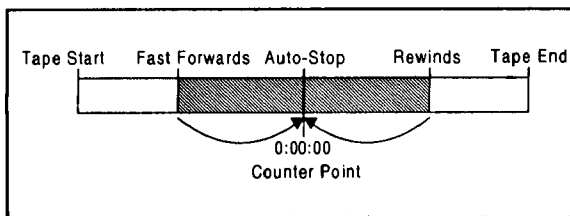

**1**

Insert a cassette tape with its safety tab in place, if necessary, rewind or fast forward the tape to the point at which you want to begin recording.

**2**

If the counter is not shown 0:00:00, press TAPE COUNTER RESET button to reset to 0:00:00.

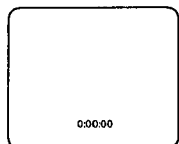

**3**

Press TAPE COUNTER MEMORY button so that "M" appears on the TV screen.

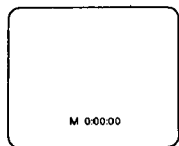

**4**

Press RECORD or PLAY button.

**5**

Press STOP button when recording or playback is completed.

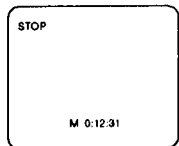

**6**

(If the counter is not displayed, press SELECT button so that the counter appears on the VCR display or on the TV screen.)

To activate the counter memory function, press REWIND button. The tape will automatically stop when the counter returns to 0:00:00.

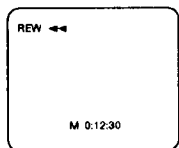

## TO CANCEL THE COUNTER MEMORY

When the counter appears on the display, press TAPE COUNTER MEMORY button so that "M" disappears from the TV screen.

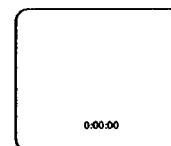



# SPECIAL FEATURES

## Picture Search (SP/LP/SLP Mode)

You may view a video tape at a high speed in either a forward or reverse direction. This feature is useful in finding or skipping over a particular scene on a tape. In this mode, the sound will be muted.

### Forward Direction:

When in the Play mode, press F.FWD button to view the tape at a fast speed in the forward direction.

### Reverse Direction:

To view the tape at a fast speed in the reverse direction, press REWIND button in the Play mode.

For normal speed, simply press PLAY button.

## Super High Speed Search (LP/SLP Mode)

For Picture Search in super high speed:

- 1) Press either F.FWD or REWIND button while the unit is in the Play mode.
- 2) Release button.
- 3) Depress it again. The unit will now search in super high speed.

For normal playback simply press PLAY button.

## Still Picture During Playback

If you press PAUSE button during playback, the picture will "freeze" on the screen. You may use this feature to study details of a particular scene. Press PLAY button to continue playback.

**NOTE:** The VCR will automatically switch to the Stop mode, if it is left in the Pause mode for more than five minutes.

## Vertical Hold Control

When the picture begins to vibrate vertically, adjust to stabilize the picture by pressing CH ▲ or ▼ button on the VCR.

### NOTES:

- This adjustment works only in the Still mode with CH ▲ or ▼ button on the VCR.
- When the picture is distorted or rolling vertically, adjust vertical hold control on your TV.
- Some newer TV's do not have a user adjustable vertical hold control.

## Tracking Adjustment – "DTR"

- Tracking adjustment will be set automatically (Digital TRacking function) when you start playback. "DTR" appears on the display.
- When playing pre-recorded tapes or tapes recorded on units other than your own, noise lines (black and white streaks) may appear on the playback picture. If this occurs, adjust the tracking control by pressing CH ▲ or ▼ button until the streaks disappear. To return to the DTR function, stop the tape once and start playback again.

### Slow Tracking

- You can reduce the noise lines by pressing CH ▲ or ▼ button in slow mode, too. Slow tracking adjustment will not be set automatically.

**Note:** Press SLOW button in Still mode and press CH ▲ or ▼ button until the streaks disappear. To return to Still mode, press PAUSE/ STILL button again.

This enables you to see the picture in its entirety without distracting noise lines.

## Auto Rewind

When the end of a tape is reached during recording, playback, or fast-forward, the tape will automatically rewind to the beginning (or to the 0:00:00 counter reading if the memory function is activated), eject, and the VCR will turn off.

### NOTES:

- The tape will not auto-rewind during timer recording or One Touch Recording.
- When the tape is rewound to the preset memory position, the tape will not eject and the VCR will not turn off.

## Slow Motion

Press SLOW button to reduce the playback speed. The VCR mutes the sound during slow motion. You can control the speed by pressing F.FWD button (faster) or REWIND button (slower).

Press PLAY button to return to normal playback.

# VIDEO CASSETTE TAPE

This VCR will operate with any cassette that has the VHS mark. For best results we recommend the use of high-quality tapes.

- Do not use poor quality or damaged tapes.

The table below shows the recording/playback time using T-60, T-120 or T-160 tapes in the SP, LP or SLP mode.

MODE	CASSETTE		
	T-60	T-120	T-160
SP Mode	1 hour	2 hours	2-2/3 hours
LP Mode	2 hours	4 hours	5-1/3 hours
SLP Mode	3 hours	6 hours	8 hours

When handling video tapes, follow the precautions below:

- Avoid moisture, which can condense on the tape if it is moved from a cold place to a warm place. Playing a tape that has moisture in it will damage the tape and your VCR. Before using a tape with these conditions, wait until the tape has warmed to room temperature and the moisture has evaporated.
- Avoid extreme heat, high humidity and magnetic fields.
- Do not tamper with the cassette mechanism.
- Do not touch the tape with your fingers.

## ERASE PREVENTION

You may prevent accidental erasing of a tape by breaking off the tab on the back edge of the cassette. If you decide to record on the tape again, cover the hole with plastic tape.

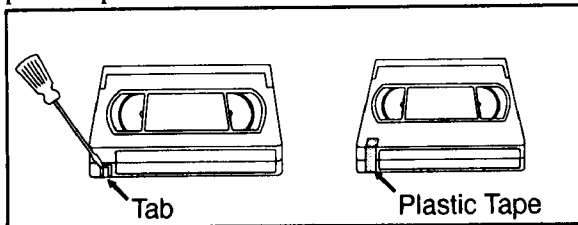

## INSERTING A CASSETTE

Insert the cassette in the direction as shown. Push in gently, but continuously, on the center-back of the cassette until it is drawn into the VCR.

The VCR will automatically turn on, and cassette-in indicator will light when the cassette is properly inserted.

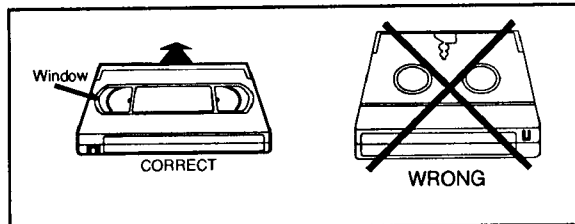

## REMOVING A CASSETTE

1

Press EJECT button on the unit or on the remote control.

2

When the cassette-in indicator goes off and the cassette stops moving, pull the cassette out of the cassette compartment and store it properly.

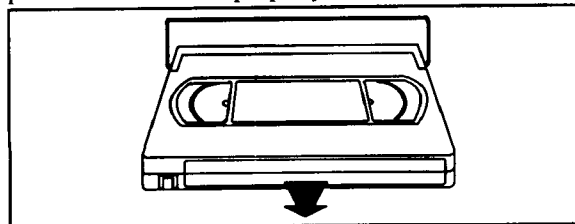

3

Store the cassette in its case as shown.

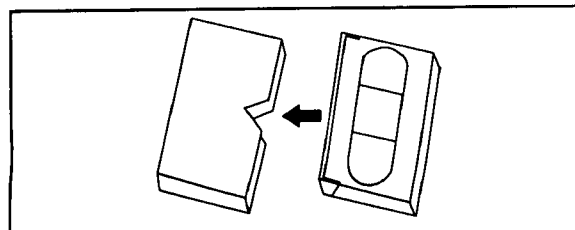

# TROUBLESHOOTING GUIDE

If you have followed the instructions contained in this manual and have difficulty in operating your VCR, locate the SYMPTOM in the left column below. Check the corresponding POSSIBLE CAUSE and CORRECTIVE ACTION columns to remedy the problem.

SYMPTOM	POSSIBLE CAUSE	CORRECTIVE ACTION
No power.	<ul style="list-style-type: none"> <li>• Power cord is not connected.</li> <li>• VCR POWER is off.</li> </ul>	<ul style="list-style-type: none"> <li>• Connect power cord to AC outlet.</li> <li>• Press POWER button to turn on the VCR.</li> </ul>
Timer recording is not possible.	<ul style="list-style-type: none"> <li>• The timer recording is set incorrectly.</li> <li>• VCR clock is not set correctly.</li> </ul>	<ul style="list-style-type: none"> <li>• Set the timer recording correctly.</li> <li>• Set VCR clock correctly.</li> </ul>
Rec mode cannot be engaged.	<ul style="list-style-type: none"> <li>• The record safety tab on cassette is missing.</li> </ul>	<ul style="list-style-type: none"> <li>• Place vinyl tape over missing safety tab.</li> </ul>
No picture or poor picture on playback.	<ul style="list-style-type: none"> <li>• The TV channel selector is not set to the proper channel.</li> <li>• The TV fine tuning is not set correctly.</li> </ul>	<ul style="list-style-type: none"> <li>• On playback, set the TV to channel 3 or 4 for video output channel. Then, press TV/VCR button so that "VCR" appears on the display.</li> <li>• Fine tune your TV.</li> </ul>
No picture on TV.	<ul style="list-style-type: none"> <li>• The VCR is in TV mode.</li> </ul>	<ul style="list-style-type: none"> <li>• Press TV/VCR button.</li> </ul>
Noise in picture on playback.	<ul style="list-style-type: none"> <li>• Video heads are dirty.</li> </ul>	<ul style="list-style-type: none"> <li>• Head cleaning is necessary, consult the nearest Sears Authorized Service Center.</li> </ul>
Playback picture is partially noisy.	<ul style="list-style-type: none"> <li>• The TRACKING control is not set correctly.</li> </ul>	<ul style="list-style-type: none"> <li>• Adjust TRACKING control for a better picture.</li> </ul>
On-the-air TV programs cannot be seen.	<ul style="list-style-type: none"> <li>• Connections are not correctly made.</li> </ul>	<ul style="list-style-type: none"> <li>• Re-check the ANT. IN and ANT. OUT connections.</li> </ul>
No operation by infrared Remote Control.	<ul style="list-style-type: none"> <li>• Weak batteries.</li> </ul>	<ul style="list-style-type: none"> <li>• Check the batteries in Infrared Remote Control.</li> </ul>
Operation buttons do not work after there is a power failure or you move your VCR.	<ul style="list-style-type: none"> <li>• Channel Memory Programming is proceeded because programmed channels are erased.</li> </ul>	<ul style="list-style-type: none"> <li>• See "Note" under "Channel Memory Programming" on page 14.</li> </ul>

# MAINTENANCE

## CABINET CLEANING

- Wipe the front panel and other exterior surfaces of the VCR with a soft cloth immersed in lukewarm water and wrung dry.
- Never use a solvent or alcohol. Do not spray insecticide liquid near the VCR. Such chemicals may cause damage and discoloration to the exposed surfaces.

## SERVICING

- Should your VCR become inoperative, do not try to correct the problem by yourself. There are no user-serviceable parts inside. Turn off, unplug the power cord, and take the unit to Sears Authorized Service Center for servicing.

## HEAD CLEANING

- Picture playback may become blurred or interrupted while the TV program reception is clear. This does not mean that the recorded program has been erased. Dirt accumulated on the video heads after long periods of use, or the usage of rental or worn tapes can cause this problem. If a steaky or snowy picture appears during playback, the heads in your VCR may need to be cleaned. Please visit your local Audio/Video store and purchase a good quality VHS Video Head Cleaner. Remember to read the instructions included with the head cleaner before use. Clean heads only when problems occur. If this does not correct the problem, consult the nearest Sears Authorized Service Center. Professional video head cleaning requires highly technical attention.

### SEARS SERVICE

Your Sears Video Cassette Recorder has added value when you consider that Sears has service units nationwide staffed with Sears trained technicians...professional technicians specifically trained on Sears home entertainment products, having the parts, tools and equipment to insure that we meet our pledge to you... "We Service What We Sell".

### HOW TO ORDER REPAIR PARTS

Now that you have purchased your Video Cassette Recorder, should a need ever exist for repair parts to service, simply contact any Sears Service Center or Sears, Roebuck and Co store. Be sure to provide all pertinent facts when you call or visit.

The Model Number will be found on the rear of cabinet. Always mention the Model Number when requesting service or repair parts for your VCR.

# SPECIFICATIONS

## GENERAL SPECIFICATIONS

Television system	: NTSC, TV standard
Video head	: Rotary 4-head Double Azimuth Video System
Tape width	: 1/2inch (12.65mm)
Tape speed	
SP	: 33.35mm/sec.
LP	: 16.67mm/sec.
SLP	: 11.12mm/sec.
Tuner channel	
VHF	: #2~#13
UHF	: #14~#69
Cable channel	: 5A, A-5 ~ A-1, A ~ W+84
RF converter	: Built-in VHF converter
Converter output	: VHF Channel 3 or 4.
Timer indication	: AM/PM 12-hour system
Operating temperature	: 5°C~40°C (41°F~104°F)
Terminals	
Antenna input	: F type connector x 1
Antenna output	: F type connector x 1
Video input/output	: RCA connector x 3
Audio input/output	: RCA connector x 3

## ELECTRICAL SPECIFICATIONS

Video output level	: 1Vp-p
Video output impedance	: 75Ω
Audio output level	: -6dBv (1KHz)
Video input level	: 0.5~2.0Vp-p
Audio input level	: -10dBv
Video S/N ratio	
SP	: More than 42dB
Audio S/N ratio	
SP	: More than 38dB

## OTHER SPECIFICATIONS

Power requirement	: 120V, 60Hz
Power consumption	: 17 Watts
Dimensions	: W 14-1/4" (360mm) H 3-5/8" (92mm) D 10" (252mm)
Weight	: 7.0lbs. (3.2 Kg.) (Approx.)
Accessories, included	: Remote control unit 2 "AA" Batteries : Owner's Manual : Coaxial cable

- Designs and specifications are subject to change without notice and without our legal obligation.

**MEMO**

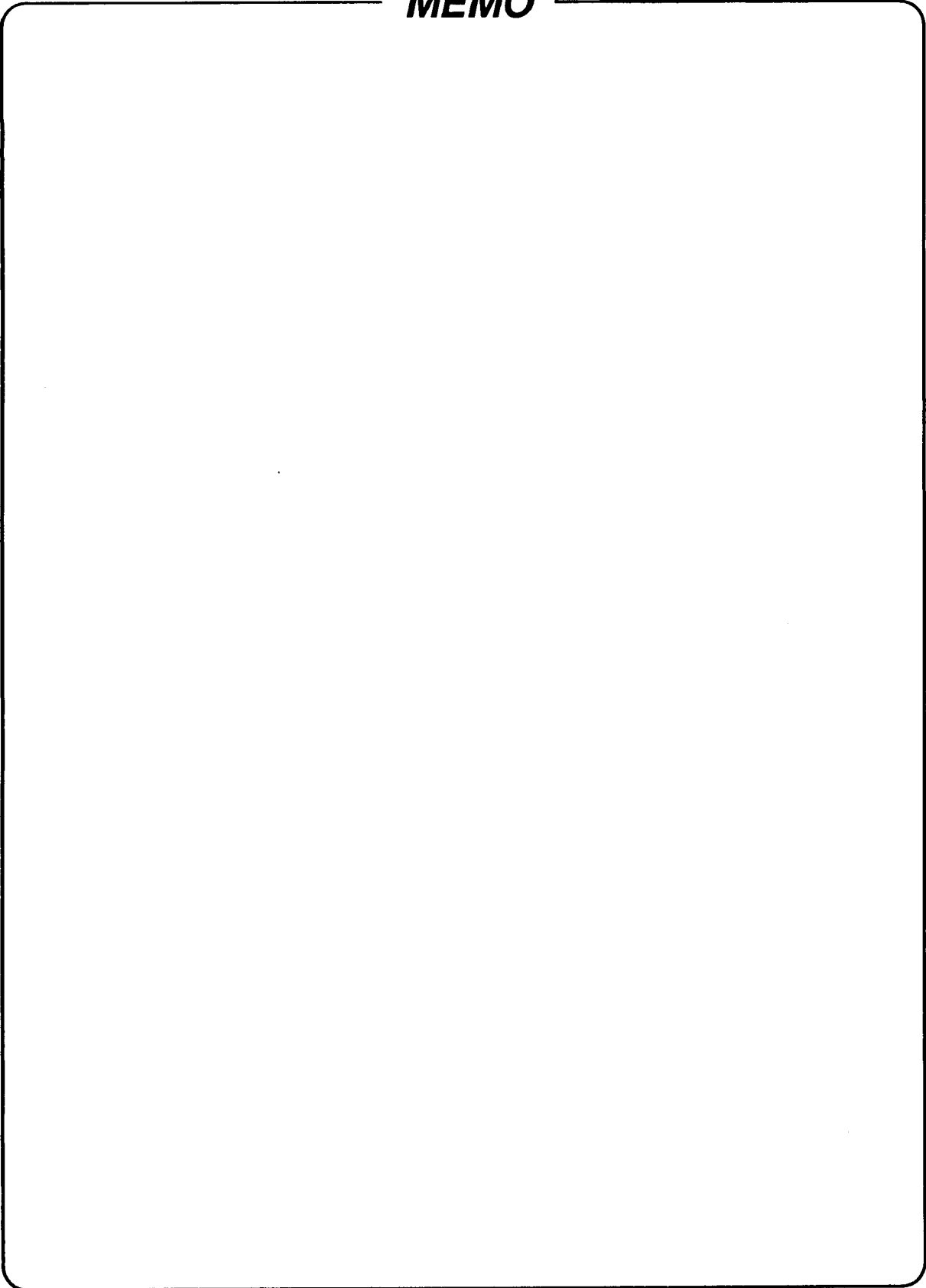

**For the repair or replacement parts you need**

Call 7 am - 7 pm, 7 days a week

**1-800-366-PART**

(1-800-366-7278)

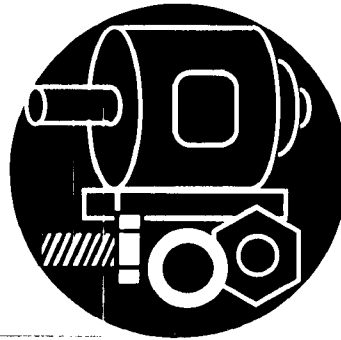

**For in-home major brand repair service**

Call 24 hours a day, 7 days a week

**1-800-4-REPAIR**

(1-800-473-7247)



**For the location of a  
Sears Repair Service Center in your area**

Call 24 hours a day, 7 days a week

**1-800-488-1222**



**For information on purchasing a Sears  
Maintenance Agreement or to inquire  
about an existing Agreement**

call 9 am - 5 pm, Monday-Saturday

**1-800-827-6655**



**SEARS**  
**REPAIR SERVICES**

*America's Repair Specialists*



# OWNER'S MANUAL

**MODEL NO.  
934.55125590**

Printed in Hong Kong

## SEARS VIDEO CASSETTE RECORDER WITH REMOTE CONTROL

Your Sears Video Cassette Recorder has added value when you consider that Sears has service units nationwide staffed with Sears trained technicians-professional technicians specifically trained on Sears home entertainment products, having the parts, tools and equipment to ensure that we meet our pledge to you - "We Service What We Sell."

Should a need ever exist for repair parts or service, simply contact any Sears Service Center/Department.

### WARRANTY

For 90 days from the date of purchase, Sears will repair any defect in material or workmanship in this video cassette recorder, free of charge. For one year from the date of purchase, Sears will supply, at no charge, replacement for defective parts.

The above warranty coverage applies only to video cassette recorders which are used for private household purposes.

TO OBTAIN WARRANTY SERVICE, SIMPLY RETURN THE VIDEO CASSETTE RECORDER TO THE NEAREST SEARS SERVICE CENTER / DEPARTMENT IN THE UNITED STATES.

This warranty gives you specific legal rights, and you may also have other rights which vary from state to state.

*Sears, Roebuck and Co.*

**Dept. 817WA, Hoffman Estates, IL 60179**

OVMN01588  
H3380UD ★★★★★



## Free Manuals Download Website

<http://myh66.com>

<http://usermanuals.us>

<http://www.somanuals.com>

<http://www.4manuals.cc>

<http://www.manual-lib.com>

<http://www.404manual.com>

<http://www.luxmanual.com>

<http://aubethermostatmanual.com>

Golf course search by state

<http://golfingnear.com>

Email search by domain

<http://emailbydomain.com>

Auto manuals search

<http://auto.somanuals.com>

TV manuals search

<http://tv.somanuals.com>