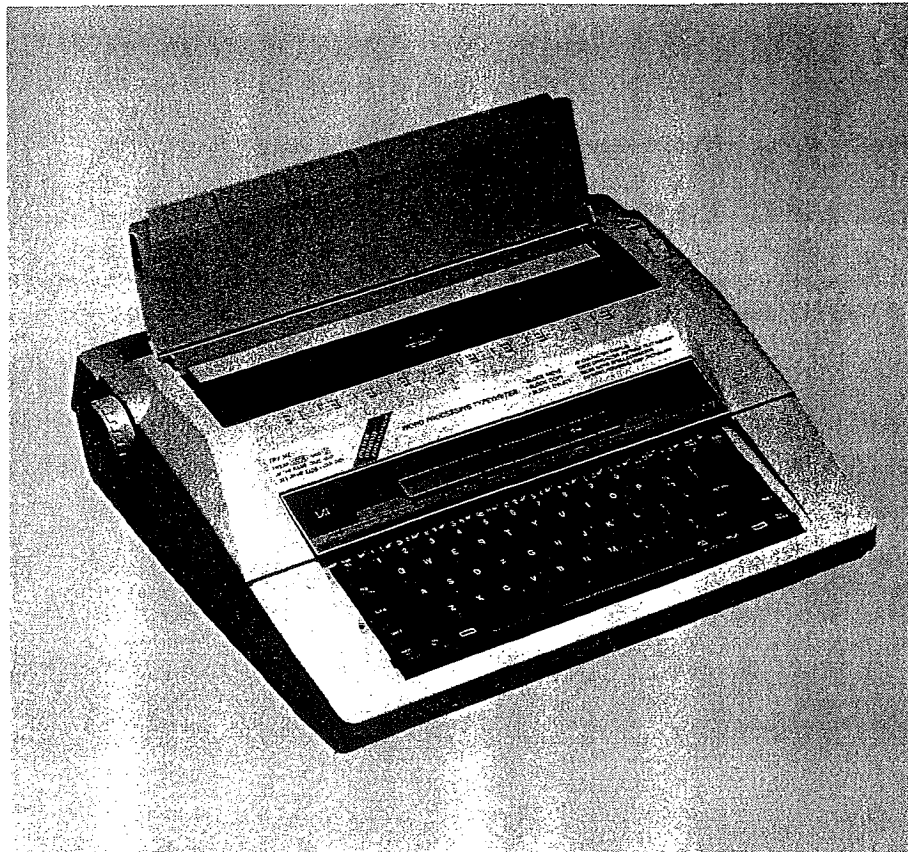

SEARS**OWNERS
MANUAL****WORD
PROCESSING
TYPEWRITER****MODEL NO.
161.53514090****Operation
Repair parts****CAUTION:
Read Rules for
Safe Operation
and Instructions
Carefully**

757481

**Warranty****FULL ONE YEAR WARRANTY**

For one year from the date of purchase, Sears will repair this Typewriter, free of charge, if defective in material or workmanship.

WARRANTY SERVICE IS AVAILABLE BY CONTACTING THE NEAREST SEARS SERVICE CENTER/DEPARTMENT IN THE UNITED STATES. This warranty applies only while product is in use in the United States.

This warranty gives you specific legal rights, and you may also have other rights which vary from state to state.

SEARS, ROEBUCK AND CO., Dept. 731 CR-W, Sears Tower, Chicago, IL. 60684

Word Processing Typewriter

Record in space provided below the Model No. and Serial No. of this appliance.

The Model No. and the Serial No. are located at the back of the machine.

Model No. 161.53514090 Serial No. _____

Retain these numbers for future reference.

Sears, Roebuck and Co., Chicago, IL. 60684 U.S.A.

NOTE: This equipment has been tested and found to comply with the limits for a Class B digital device, pursuant to Part 15 of the FCC Rules. These limits are designed to provide reasonable protection against harmful interference in a residential installation. This equipment generates, uses and can radiate radio frequency energy and, if not installed and used in accordance with the instructions, may cause harmful interference to radio communications. However, there is no guarantee that interference will not occur in a particular installation. If this equipment does cause harmful interference to radio or television reception, which can be determined by turning the equipment off and on, the user is encouraged to try to correct the interference by one or more of the following measures:

- Reorient or relocate the receiving antenna.
- Increase the separation between the equipment and receiver.
- Connect the equipment into an outlet on a circuit different from that to which the receiver is connected.
- Consult the dealer or an experienced radio/TV technician for help.

RULES FOR SAFE OPERATION

- 1) Your new Sears Typewriter has been designed to operate on standard U.S.A. Power 110-120 Volts AC, 60Hz only.
- 2) Your typewriter is a highly sophisticated mechanism, so never attempt to repair it yourself. If repair becomes necessary, have it repaired by Sears qualified serviceman.
- 3) Never insert metal objects such as a screwdriver, paper clip, nail file, etc., inside the typewriter. This could cause damage to the typewriter, and/or electrical shock.
- 4) Do not leave your typewriter unattended when the machine is on. Always turn off the typewriter when you have finished typing.

Your new Sears Word Processing Typewriter uses the most advanced electronic technology and greatly increases your typing efficiency. Some of the many outstanding features of your new typewriter are:

- 50 line, 10,000-character memory
- Four typewriter modes
- 40-character Liquid Crystal Display (LCD: 40 character 2 lines)
- Easy-to-change 100-character printwheel
- Line spacing selector: 1, 1-1/2 and 2 lines
- Pitch selector: 10, 12 and 15 characters per inch
- 5-year memory back-up battery
- Full-line correction memory
- Full electronic tabulator (16 positions resettable)
- Automatic centering (1)
- Decimal tabulation (7)
- Automatic paragraph indentation (5)
- Automatic carrier return
- Automatic word correction
- Automatic word/full underlining (4)(6)
- Bold typing (3)
- Required hyphen
- Required space (2)
- Block copy/move/delete
- Spell Corrector
- Caps lock
- Self demonstration (See below)

* The number in brackets refers to the Sample Letter on the next page.

Hold down the Code Key and press the "D" Key to automatically print out the feature listing as follows:

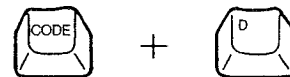

THIS *WORD PROCESSING* TYPEWRITER HAS MANY FEATURES TO MAKE TYPING EASIER.

- * 80 CHARACTER DISPLAY - Allows you to review and edit text before printing.
- * SPELLING CHECK - Automatically checks spelling of 50,000 words plus checks an additional 100 words that may be special to you.
- * TEXT MEMORY - Allows you to review, edit and recall up to 10,000 characters.
- * DUAL MARGIN ALIGNMENT - Automatically "blocks" both sides of the typing, just like it is on this page.
- * BLOCK OPERATIONS - Allows you to move, copy, delete and insert entire blocks of text for enhanced editing.
- * 3 PITCH SELECTIONS - Allows a much wider variety of type styles.
- * OTHER FEATURES INCLUDE - **BOLD TYPING**, Automatic carrier return,

-Automatic Centering-

Paragraph Indentation, Decimal tabulation, Automatic Underlining, CAPS LOCK and many more.

Sample Letter

"Tools for Everyone" **Automatic Centering (1)**
Consolidated Tool Co., Inc.
138 Elm Boulevard
Chicago, Illinois 60690

June 3, 1997

Everyday Hardware, Inc.
10301 Main Street
Portland, Oregon 98645

Required Space (2) 

Dear Sir;

Thank you very much for your letter of May 23 and for your inquiry as to any developments in our product-line for next year.

As a favored customer, you are presently entitled to a 10% discount on all products ordered. We certainly understand your position and we realize that recently the market for our products has been somewhat slow. Therefore to thank you for your continued patronage, we have decided that we can offer an additional 5% discount. We hope that this will help the situation.

Bold Typing (3)

The following passage from Tools Today typifies our feelings on the matter.

Automatic Full Underlining (4)

Paragraph Indentation (5) "The market will continually grow as the expense of hiring out home improvements increases. Consumers will be forced to do whatever is necessary and this fact offers a grand opportunity to all those involved in this area!"

Please look under the following areas in the Company Prospectus inserted which describes our goals for the coming years:

<u>Section Title</u> Automatic Word Underlining (6)	<u>Section</u>	<u>Pages</u>
Meeting the New Markets	2.3-2	31 - 46
Our Answer	11.6	93 - 102
What We Can Do Together	18.14	209 - 234

Decimal Tabulation (7)

Thank you again for your continued use of our products. We wait for your reply.

Very truly yours,

James Harrison
Assistant Sales Manager

This owners manual describes how to use all of the typewriter's features and controls, how to replace accessories and many other important things. Please read this manual completely before operating your new electronic typewriter.

Sears typewriter stands are designed to give you comfort by providing the proper height for the typewriter when typing.

A Sears typewriter stand also provides you with a convenient storage location for your typewriter when it is not being used.

TABLE OF CONTENTS

PART NAMES AND FUNCTIONS	1
BASIC OPERATIONS	4
1. SELF DEMONSTRATION	4
2. HOW TO START TYPING	4
3. HOW TO CHANGE RIBBON CASSETTE	7
4. HOW TO CHANGE CORRECTION TAPE	8
5. HOW TO CHANGE PRINTWHEEL	9
6. TYPEWRITER MODES	10
7. MARGINS	11
8. TABS	12
9. CORRECTIONS ON PAPER	13
10. CORRECTIONS ON LCD (DISPLAY)	15
11. AUTOMATIC WORD CORRECTION	17
SPELL CORRECTOR FUNCTION	19
TYPEWRITER FUNCTION	24
1. DECIMAL TABULATION	24
2. AUTOMATIC CENTERING	25
3. AUTOMATIC PARAGRAPH INDENTATION	26
4. BOLD TYPING	26
5. AUTOMATIC UNDERLINING	27
6. AUTOMATIC CARRIER RETURN	28
7. REQUIRED HYPHEN AND REQUIRED SPACE	28
8. SECOND KEYBOARD (SPECIAL CHARACTER SET)	29
9. CAPS LOCK	29
MEMORY FUNCTION	30
1. FILE STORING	30
2. STOP CODE	34
3. FILE EDITING	36
4. FILE RECALL (PRINTOUT ON PAPER)	39
5. FILE LISTING	41
6. AVAILABLE MEMORY CAPACITY	41
7. FILE DELETING	42
8. MEMORY ALL CLEAR	42
9. BLOCK OPERATIONS (COPY/MOVE/DELETE)	43
SUPPLIES	46
AFTER USING THE TYPEWRITER AND TO STORE	47
MAINTENANCE AND SERVICE	47

PART NAMES AND FUNCTIONS

1. Operating Parts

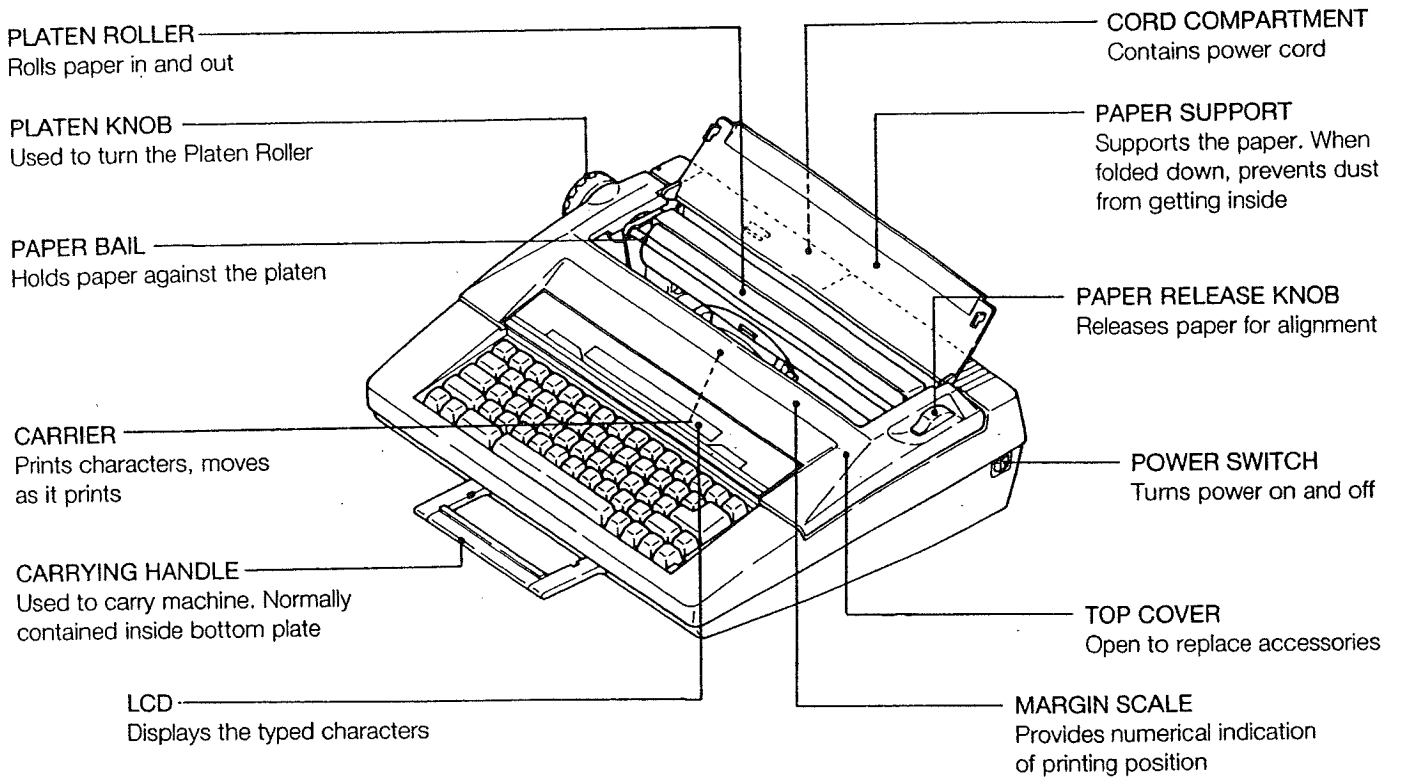

2. Carrier Mechanism (under the Top Cover)

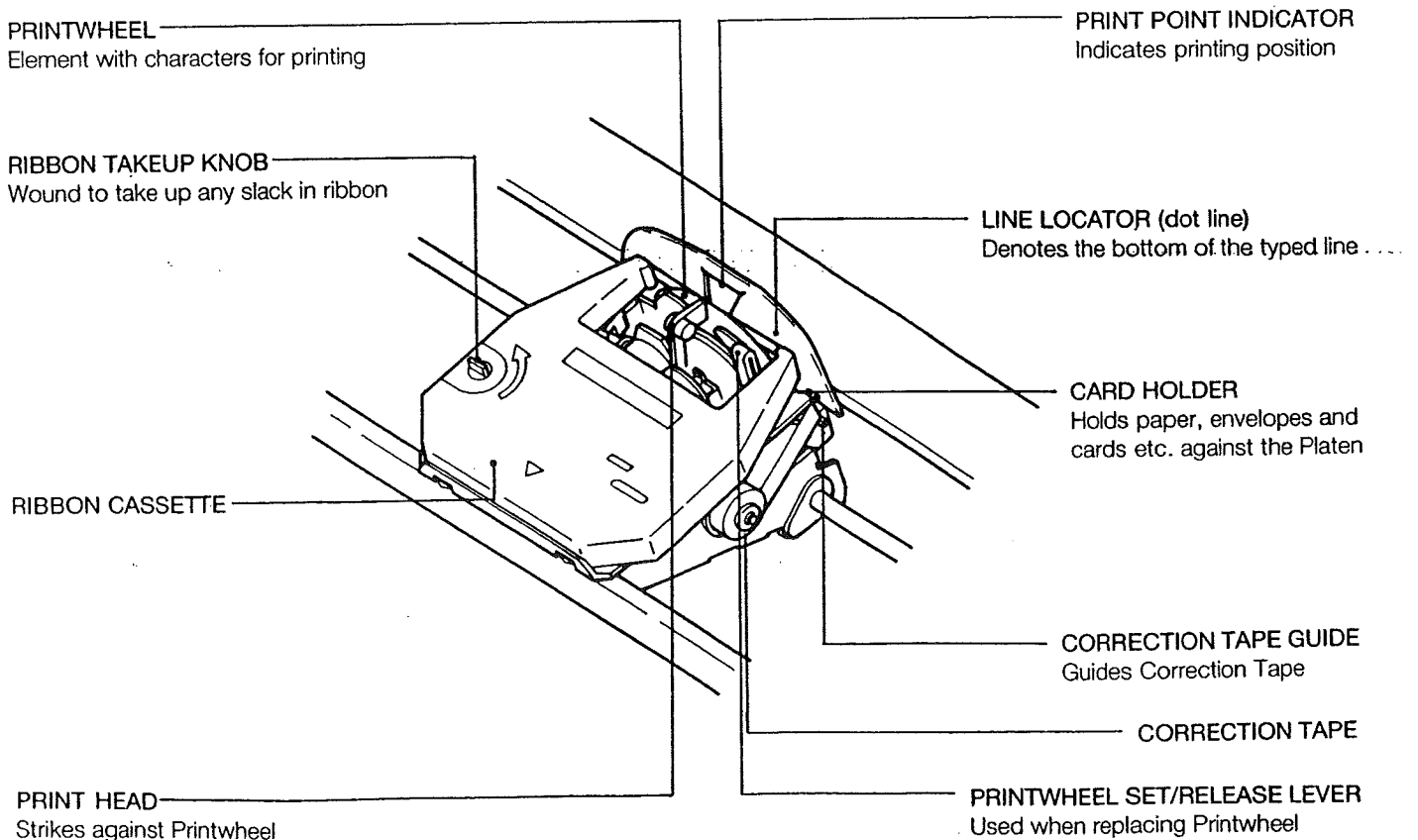

3. Keyboard Layout

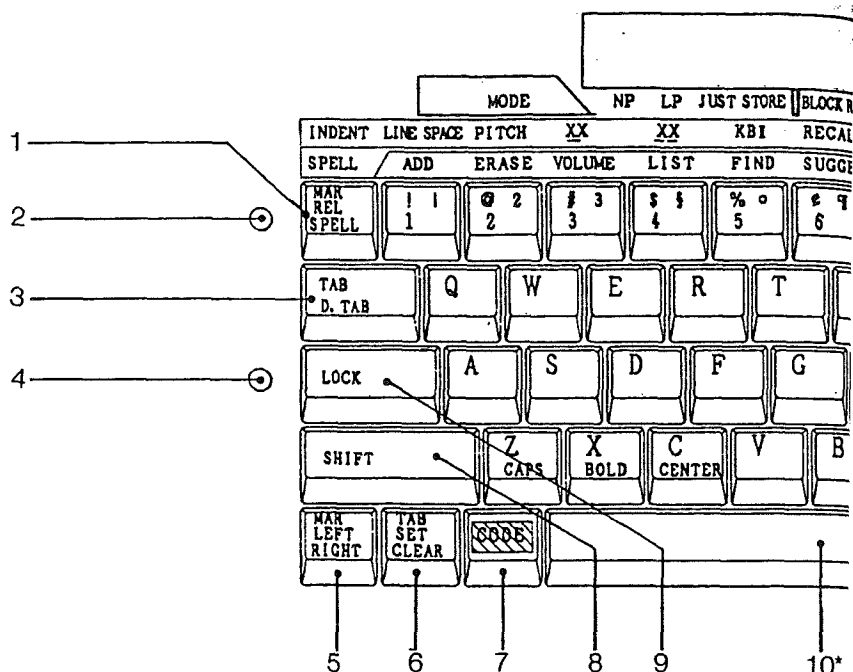

4. Key Functions

<p>1 MARGIN RELEASE KEY Releases the margins to type beyond them or set new ones.</p>	<p>8 SHIFT KEY Enables typing of capital letters or a character on the upper half of a key when held down. When it's pressed, the Shift Lamp (red) on the Keyboard lights up.</p>
<p>2 POWER-ON LAMP (GREEN) Lights up when the machine is turned on.</p>	<p>9 SHIFT LOCK KEY Locks the Shift Key in position to type a series of capital letters when pressed. When it's locked, the Shift Lamp (red) lights up. Release by touching either Shift Key.</p>
<p>3 TAB KEY Moves the Carrier to the next tab.</p>	<p>10 SPACE BAR A light touch moves the Carrier ahead one space. For repeat spacing, hold it down.</p>
<p>4 SHIFT LAMP (RED) Lights up when the Shift Key is pressed or locked.</p>	<p>11 CORRECTION KEY Corrects characters. Hold down for repeat correction.</p>
<p>5 LEFT/RIGHT MARGIN SET KEY Sets the left/right margin.</p>	<p>12 RELOCATION KEY After backspacing to correct or underline text, etc., press the Relocation Key to return the Carrier one space after the last character typed. On the LCD, the cursor returns to its former position.</p>
<p>6 TAB SET/CLEAR KEY Sets or clears tabs.</p>	
<p>7 CODE KEY Hold down the Code Key to activate special functions (Auto center, File recall, etc.) in conjunction with several other keys.</p>	

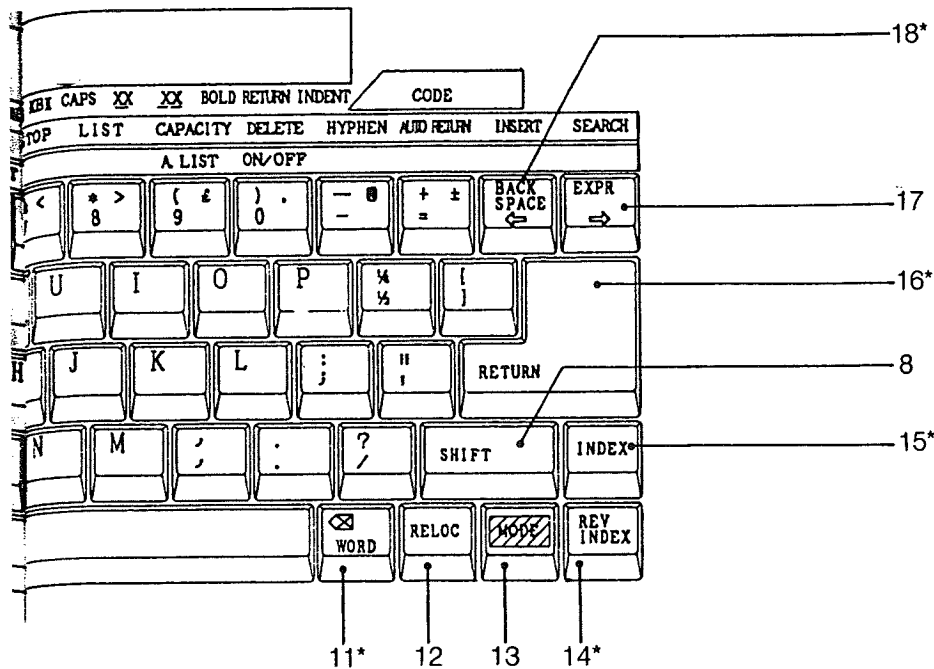

* Hold down these keys for repeat action.
 The following characters x, X, -, __, =, ., *, are also repeated by holding down the respective keys.

<p>13 MODE KEY Changes the typewriter mode.</p>
<p>14 REVERSE INDEX KEY Pressed to retract paper without moving the Carrier. Paper will retract a half-line (1/12") every time the key is pressed. By holding down the key, paper will retract continuously. Also clears the correction memory.</p>
<p>15 INDEX KEY Pressed to advance paper without moving the Carrier. Paper will advance a half-line (1/12") every time the key is pressed. By holding down the key, paper will advance continuously. Also clears the correction memory.</p>

<p>16 RETURN KEY Pressed to advance paper one line and return the Carrier to the left margin. For repeat line spacing, hold it down. Also clears the correction memory.</p>
<p>17 EXPRESS KEY Press to return the Carrier to the left margin without line spacing (LCD must be cleared), or move the cursor one space to the right on the LCD. Hold down the key for repeat spacing (on the LCD only).</p>
<p>18 BACKSPACE KEY A light touch moves the Carrier backward one space, or moves the cursor one space to the left on the LCD. For repeat action, hold it down.</p>

BASIC OPERATIONS

1. SELF DEMONSTRATION

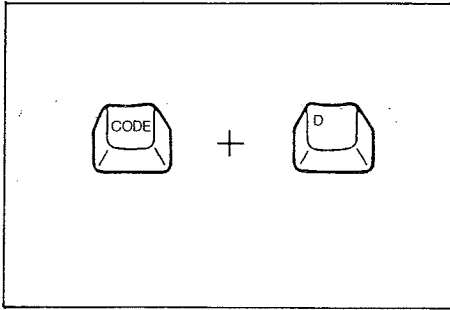

Hold down the Code Key and press the "D" Key. The typewriter will automatically perform a printout of features.

When you activate this function, the correction memory is cleared.

To cancel the printout at any time, simply touch the Space Bar.

2. HOW TO START TYPING

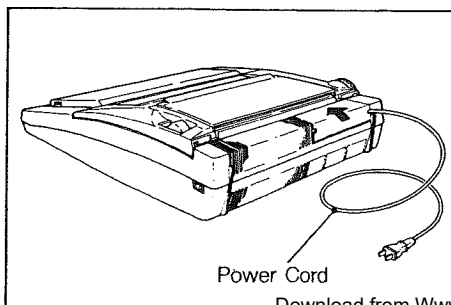
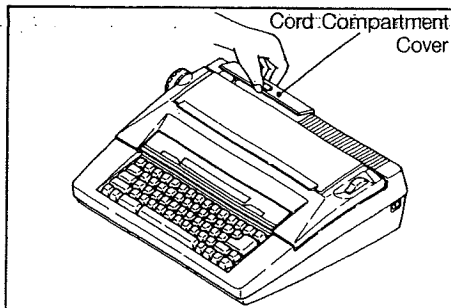
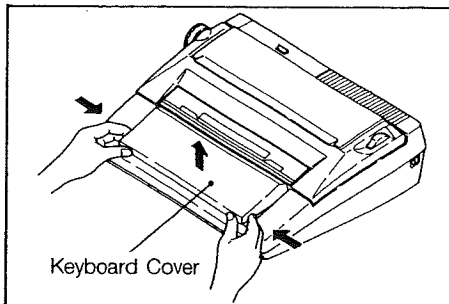

1. Set Up Typewriter

1) Place the typewriter on a desk or other flat surface. Lift up the Keyboard Cover and remove it.

2) Press the mark on the Cord Compartment Cover on the rear of the typewriter, open the cover and take out the power cord.

3) Fit the power cord through the slot on the Cord Compartment and close the cover. Plug the cord into an outlet of the proper voltage (110-120V AC 60Hz).

2. Turn On Typewriter

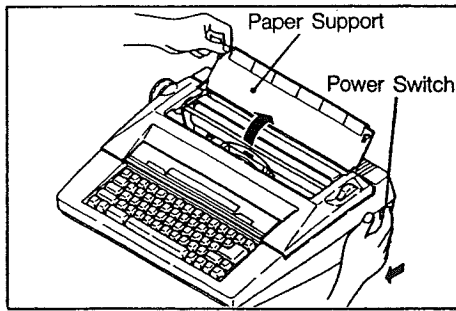

Raise the Paper Support and turn on the Power Switch located on the right side of the typewriter. The following initial operations occur:

1. A beep sounds and the Power-on Lamp (green) on the keyboard lights up.
2. The Carrier moves to the extreme left side and then moves to the left margin. The Printwheel rotates and stops at the programmed position.

While the above operations are occurring, all other typewriter functions stop. Start the next operation only after the initial operations are completed.

- Make sure the Printwheel, Ribbon Cassette and Correction Tape are properly installed and that there is a sufficient quantity of ribbon and correction tape remaining.

3. Insert Paper

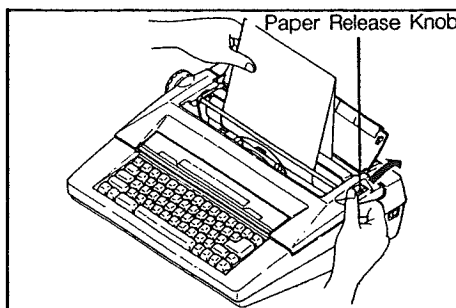
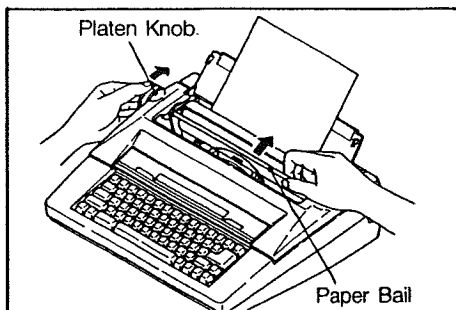
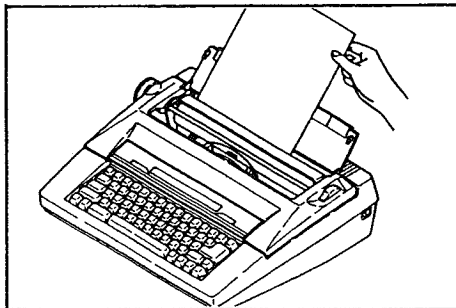

- 1) Insert paper between the Paper Support and Platen Roller.
 - 2) Turn the Platen Knob on the left of the typewriter to advance the paper. When the top of the paper comes into sight, pull the Paper Bail upward by hand to open it and continue turning the Platen Knob to feed paper in between the Paper Bail and Platen Roller.
 - 3) The paper is released when the Paper Release Knob is turned backward, enabling you to freely move the paper by hand for alignment purposes.
- Close the Paper Bail and return the Paper Release Knob to its forward position before typing.

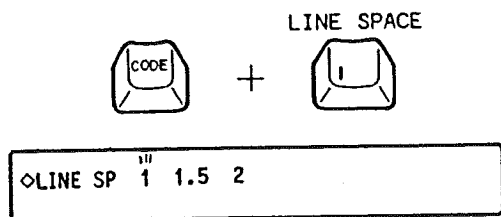

4. Set Typing Controls

- 1) Line Spacing
Hold down the Code Key and press the "1" Key. "◇ LINE SP 1 1.5 2" appears on the LCD. The line space in use will blink.

To change the line spacing, hold down the Code Key and press the "1" Key again. The line spacing changes each time the "1" Key is pressed, and the respective setting blinks.

Releasing the Code Key sets the line spacing and automatically terminates the selection mode.

Setting 2 provides double spacing (3 lines per inch).
Setting 1-1/2 provides one-and-a-half spacing (4 lines per inch).

Setting 1 provides single spacing (6 lines per inch).

- Line space selection can be performed in the NP mode, and in the LP or JUST modes when there are no characters on the LCD.

- Your typewriter has a memory back-up battery which protects the line space/print pitch settings for a minimum of five years, even when the power switch is turned off.
- When power is turned on, six beeps sound if the back-up battery has been completely drained. The line space/print pitch settings are cleared. Please contact your nearest Sears Service Center in this case.

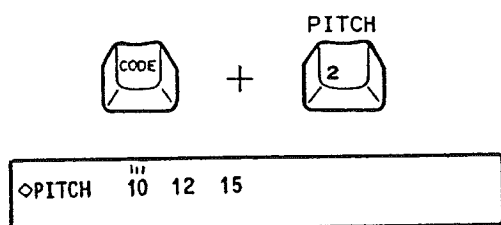

- 2) Print Pitch
The print pitch should be set to match the Printwheel being used. Typing can be done with different pitches on the same line.

Hold down the Code Key and press the "2" Key. "◇ PITCH 10 12 15" appears on the LCD and the pitch in use will blink.

To change the print pitch, hold down the Code Key and press the "2" Key again. The print pitch changes each time the "2" Key is pressed and the respective setting blinks.

Releasing the Code Key sets the print pitch and automatically terminates the selection mode.

- 10: PICA pitch — 10 characters per inch
- 12: ELITE pitch — 12 characters per inch
- 15: MICRO pitch — 15 characters per inch

- Print pitch selection can be performed in the NP mode, and in the LP or JUST modes when there are no characters on the LCD.

3. HOW TO CHANGE RIBBON CASSETTE

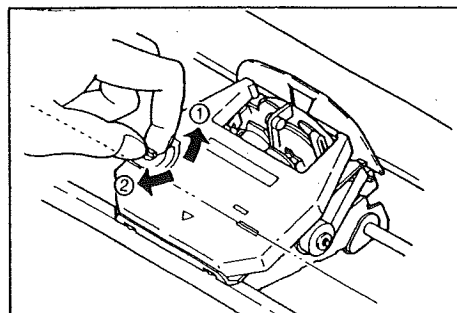
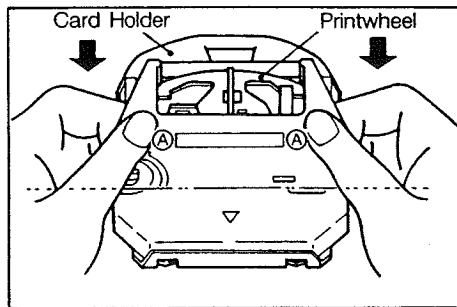
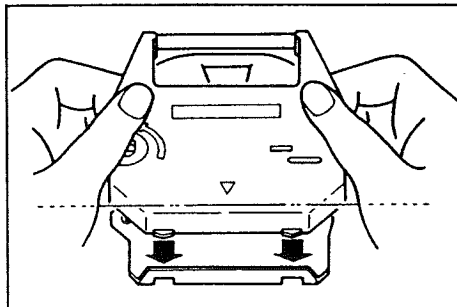
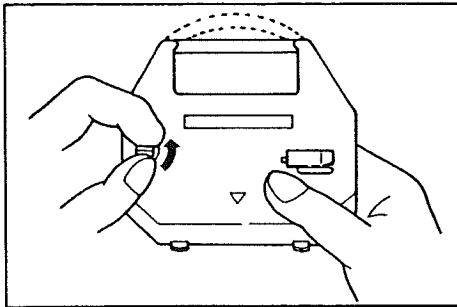
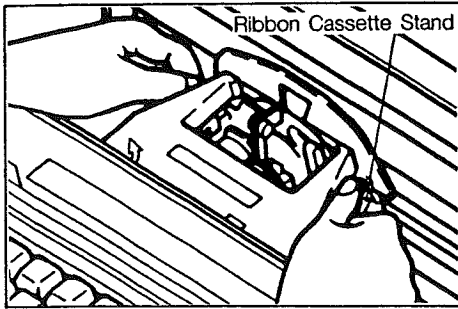

1. Removing Ribbon Cassette

- 1) Turn off the machine and open the Top Cover.
 - 2) Hold down the Ribbon Cassette Stand with your thumbs and gently remove the Cassette by pulling upward on the Cassette Arms as shown.
- Look through the window in the Cassette to check on how much ribbon remains. If you see colored tape in the window, replace the Ribbon Cassette with a new one.

2. Installing Ribbon Cassette

- 1) Before installing a new Ribbon Cassette, always take up any slack in the ribbon by winding the Ribbon Takeup Knob counterclockwise, and remove tab on Cassette Ribbon.
 - When installing a new ribbon, wind past the colored portion at the beginning.
- 2) Fit the two projections at the back of the Ribbon Cassette into the two slots in the Ribbon Cassette Stand.
- 3) Carefully lower the front of the cassette so that the ribbon fits between the Card Holder and Printwheel. Press the portions marked "A" in the illustration until the Ribbon Cassette snaps into place.
- 4) Turn the Ribbon Takeup Knob counterclockwise until it locks into place ①. Then, turn it clockwise until it stops ②.
 - 5) Close the Top Cover.

4. HOW TO CHANGE CORRECTION TAPE

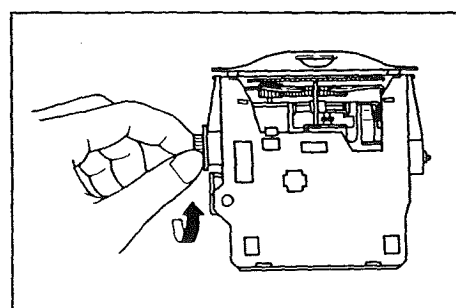
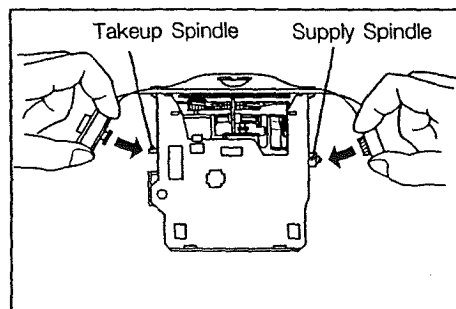
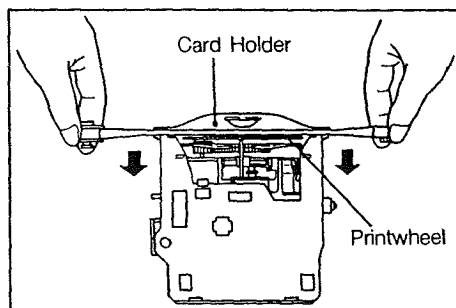
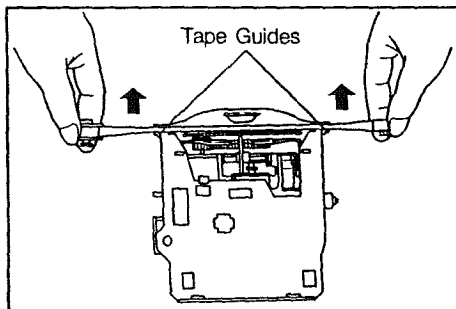
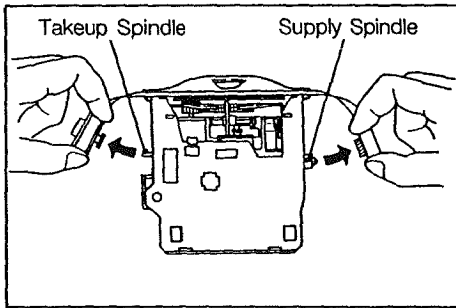

1. Removing Correction Tape

- 1) Turn off the machine. Open the Top Cover and remove the Ribbon Cassette as explained under "Removing Ribbon Cassette".
- 2) Remove the left and right spools from the respective spindles. Be sure not to pull on the spindle hub when removing the right spool.
- 3) Grasp both spools and bring back to a position that is parallel with the Tape Guides. Pull on the Correction Tape to take up any slack and lift it out of the typewriter.

2. Installing Correction Tape

- 1) While holding the two spools in your hands, unwind the Correction Tape and position behind the Tape Guides and Printwheel as shown. Make sure that the sticky side of the tape faces the Card Holder.
- 2) Fit the full spool of the Correction Tape onto the Right (Supply) Spindle. Then fit the left spool (the one with the knob) onto the Left (Takeup) Spindle.
- 3) Turn the left spool counterclockwise until the colored portion of the tape disappears.
- Check again to make sure that the Correction Tape has been fed properly behind the left and right Tape Guides.
- 4) Replace the Ribbon Cassette and close the Top Cover.

5. HOW TO CHANGE PRINTWHEEL

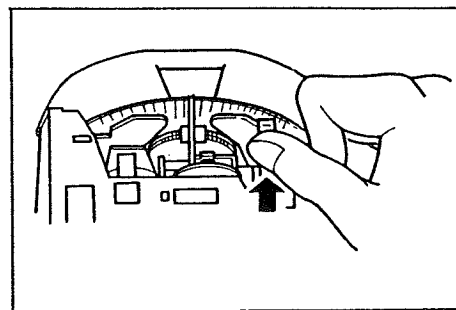
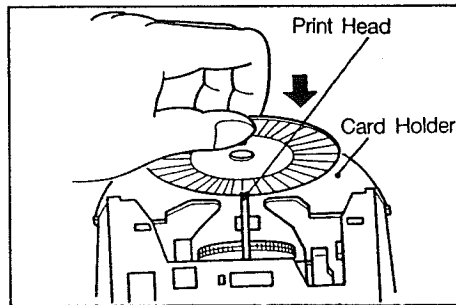
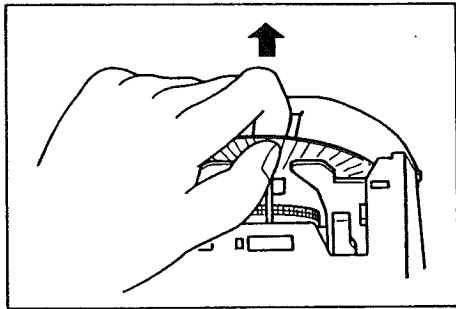
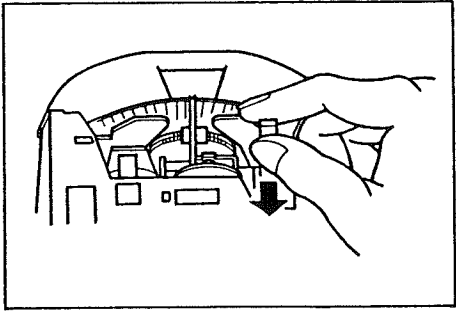

1. Removing Printwheel

- 1) Turn off the machine. Open the Top Cover and remove the Ribbon Cassette as explained under "Removing Ribbon Cassette".
- 2) Pull the Printwheel Set/Release Lever towards you.
- 3) Lightly grasp the top of the Printwheel and carefully pull it up towards you.

2. Installing Printwheel

- 1) Lightly grasp the edge of the Printwheel and carefully lower it in between the Card Holder and the Print Head.
 - Make sure that the typeface (the side with typing style indicated) faces the Platen.
- 2) Press the Printwheel Set/Release Lever away from you until it snaps into place, locking the Mechanism.
 - Press the Lever as far as it goes again to make sure the Printwheel has been locked into place.
- 3) Replace the Ribbon Cassette and close the Top Cover.
 - Remount the Printwheel if any abnormal noise is heard or if incorrect characters are printed.

6. TYPEWRITER MODES

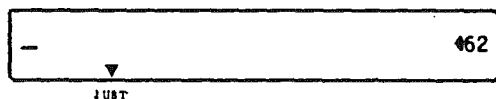
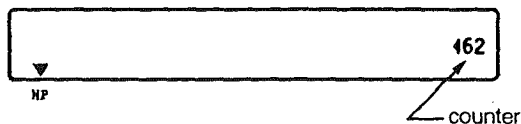

Sample Printout

Left Margin



Your typewriter has four different modes: Normal Print (NP), Line Print (LP), Justified Print (JUST) and Store (STORE).

Your typewriter has four different modes: Normal Print (NP), Line Print (LP), Justified Print (JUST) and Store (STORE).

Right Margin



<printout in NP/LP mode>

<printout in JUST mode>

Your typewriter has four different modes. Normal Print (NP), Line Print (LP), Justified Print (JUST) and Store (STORE). The mode in use is indicated on the LCD by a "▼", and it's changed each time the Mode Key is pressed.

- 1) Normal Print Mode (NP)
When power is first turned on, the typewriter is in the Normal Print (NP) mode. In this mode, characters are immediately typed on the paper without appearing on the display (LCD).

- Counter
The counter at the right side of the LCD indicates the remaining number of spaces to the right margin. If you type beyond the right margin, the number increases one by one.

- 2) Line Print Mode (LP)
This mode allows you to print one line at a time. Characters appear on the display as you type them, enabling you to correct any typed entry on the LCD. Characters are printed when you press the Tab or Return Key. You can type in new text while the previous line is being printed.

- 3) Justified Print Mode (JUST)
This mode allows you to align both margins, i.e., evenly position the words between the left and right margins.

Characters appear on the display as you type them, enabling you to correct any typed entry on the LCD. When you type a character of any word exceeding the right margin (indicated by the counter on the LCD), words preceding the right margin are automatically printed out, justified between the left and right margins, and the carrier returns to the left margin. The word whose characters exceeded the right margin will remain on the LCD to start the next line (word-wrap). You can type new text while the previous line is being printed.

If you press the Return or Tab Key while typing in a line, text will be printed out immediately and will not be justified.

- 4) Store Mode (STORE)
This mode allows you to store text into the typewriter's memory. For an explanation of details, refer to "Memory Function".



7. MARGINS

The following auto margins are permanently stored in this typewriter.

	Left Margin	Right Margin
PICA typing (10 pitch)	10	75
ELITE typing (12 pitch)	12	90
MICRO typing (15 pitch)	15	113

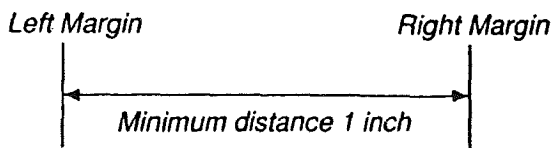
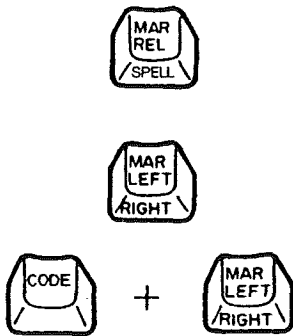

1. Auto Margins (Standard Pre-set Margins)

When the power is first turned on, the Print Point Indicator moves to the left auto margin. A beep sounds when the 6th character or space is printed before the right margin, informing you that the Print Point Indicator is nearing the right margin. Printing stops after 5 more characters (or spaces) are typed, and a beep signals that the Print Point Indicator is at the right margin.

2. Setting New Margins

Move the Print Point Indicator to the position where you want to set a new margin by using the Space Bar and/or Backspace Key.

- To set a new margin beyond either of the present margins, press and release the Margin Release Key while the Print Point Indicator is at that margin, then move the Print Point Indicator to the desired position.
 - 1) Left Margin
Press the Margin Set Key to set the new left margin.
 - 2) Right Margin
Hold down the Code Key and press the Margin Set Key to set the new right margin.
- A beep sounds, signaling that a new margin has been set. When you set a new left or right margin, the respective auto margins are automatically cleared.
- The LCD must be clear to set new margins, and the Auto center and Decimal tab functions must not be in active use.
- The left and right margins must be at least one inch apart.

3. Typing Beyond Margins

- 1) Typing beyond right margin:
Press and release the Margin Release Key when the Print Point Indicator stops at the right margin and continue typing.
- 2) Typing beyond left margin:
Press and release the Margin Release Key at the left margin, and press the Backspace Key to move the Print Point Indicator to the position where you want to start typing.

- Your typewriter has a memory back-up battery which protects the margin/tab settings for a minimum of five years, even when the power switch is turned off.
- When power is turned on, six beeps sound if the back-up battery has been completely drained. The margin/tab settings are cleared. Please contact your nearest Sears Service Center in this case.

8. TABS

Setting tabs makes aligning columns of figures or tables of data easy.

1. Setting Tabs

- 1) Move the Print Point Indicator to the position where you want a tab by using the Space Bar or Backspace Key.
 - 2) Press the Tab Set/Clear Key. A beep will confirm that a tab has been set. A maximum of 16 tab stops can be set.
- The LCD must be clear to set tabs, and the Auto center and Decimal tab functions must not be in active use.



2. Clearing Tabs

- 1) Move the Print Point Indicator to the tab you want to clear.
 - 2) Hold down the Code Key and press the Tab Set/Clear Key to clear the tab. A beep will confirm that the tab has been cleared.
- If you want to clear all tabs, hold down the Code Key and press the Tab Set/Clear Key with a little pressure. Two beeps will confirm that all tabs have been cleared. The print carrier can be at any position when all tabs are cleared.



3. Using Tabs

Press the Tab Key to advance the Print Point Indicator to the next tab on the right.

- If any text remains on the LCD, it will be printed before the carrier advances to the next tab.

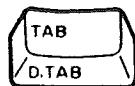

9. CORRECTIONS ON PAPER

Your new typewriter has a one line automatic correction memory. The machine remembers all characters typed in the last full line and will correct any or all of those characters. Characters beyond the correction memory can also be corrected easily with a few extra steps.

- The correction memory is automatically cleared when the Return, Index or Reverse Index Key is pressed.
- The correction memory is also cleared if the power is turned off.

1. Correcting the Last Character(s) Typed

- 1) Press the Correction Key. The Print Point Indicator will backspace and erase the incorrect character(s).
- If you hold down the Correction Key, the machine will continue erasing characters in the last full line until the Correction Key is released.
- 2) Type the correct character(s).

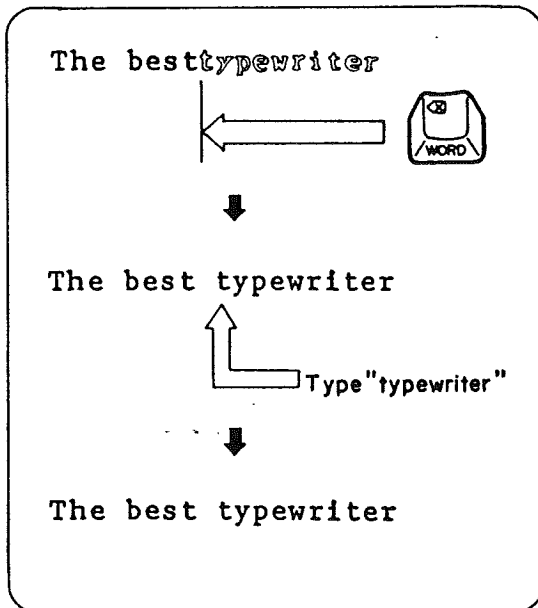

2. Correcting Previous Character(s) Within the Current Line

- 1) Move the Print Point Indicator to align it with the character(s) to be corrected, using the Backspace Key.
- 2) Press the Correction Key to erase the incorrect character(s).
- Hold down the Correction Key to correct more than one character. Correction will be repeated until the Correction Key is released.
- 3) Type the correct character(s).

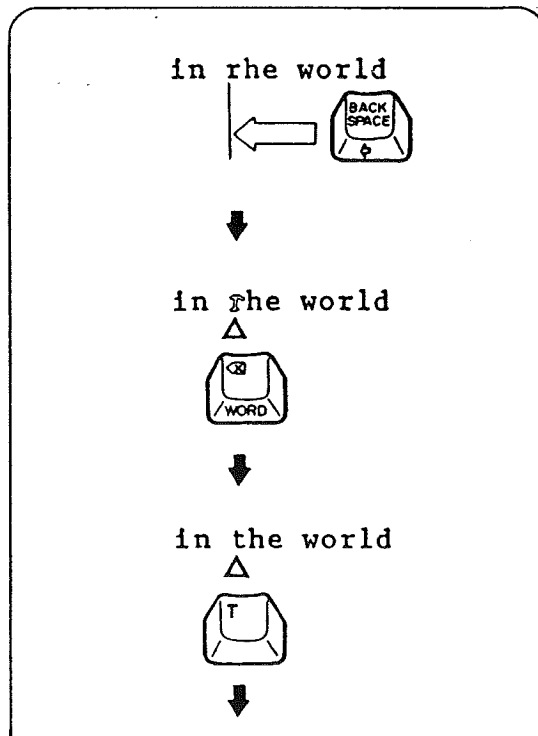

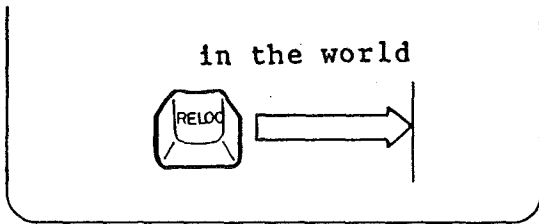

- 4) Press the Relocation Key to return the Print Point Indicator to its previous position.

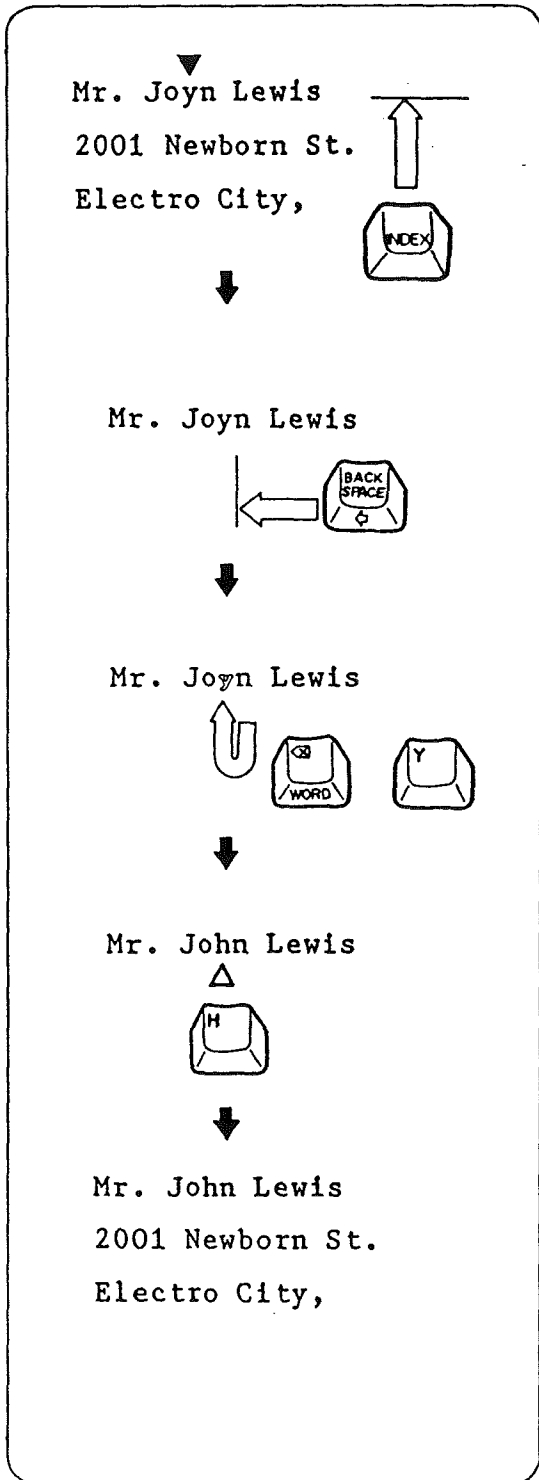

3. Correcting Character(s) on Another Line

- 1) If the correction is on another line, press the Reverse Index Key or Index Key (clears any correction memory) to align the Print Point Indicator with the line where the correction is to be made.
- 2) Move the Print Point Indicator to the position one space to the right of the character(s) to be corrected, using the Space Bar and/or Backspace Key.
- 3) Press the Correction Key. The Print Point Indicator will backspace to the incorrect character. Type the incorrect character and it will be erased. The Print Point Indicator does not move.
- 4) Type the correct character(s).
- 5) Return the Print Point Indicator to the previous position.

10. CORRECTIONS ON LCD (DISPLAY)



Ex.

to be corrected:

best typewriter 442
LP

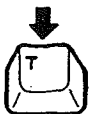

best typewriter 442
LP



best typewriter_ 442
LP

Ex.

to be corrected:

bbest typewriter 442
LP



best typewriter 443
LP



best typewriter_ 443
LP

1. Moving the Cursor

- 1) Press the Backspace Key to move the Cursor one space to the left.
 - 2) Press the Express Key to move the Cursor one space to the right.
- Hold down either key for continuous movement.

2. Replacing

- 1) Bring the cursor under the character you want to correct, using the Backspace and/or Express Key.
- 2) Type the correct character. The character is automatically replaced.
- 3) Press the Relocation Key to return the cursor to its former position.

3. Deleting

- <In text>
- 1) Position the cursor under the character to be deleted, using the Backspace and/or Express Key.
- To delete more than one character, position the cursor under the character at the far left of the series you want to delete.
- 2) Press the Correction Key to delete the character(s). Each time the Correction Key is pressed, the character above the cursor is deleted, and the text is pulled one space to the left.
 - Hold the Correction Key down to quickly delete a number of characters.
 - 3) Press the Relocation Key to return the cursor to the previous position.

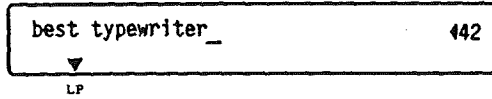
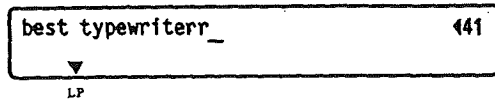

Ex.

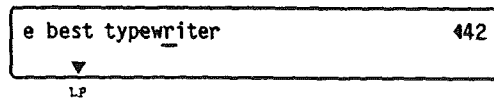
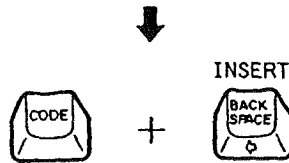
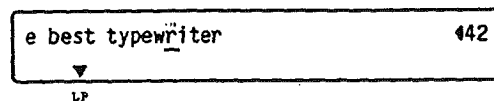
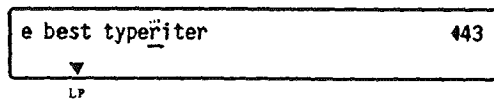
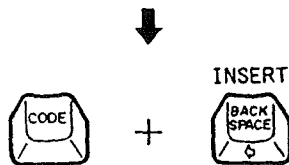
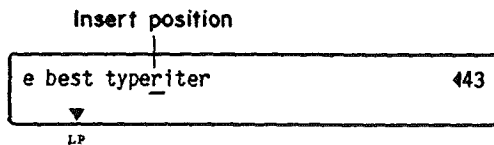

OR

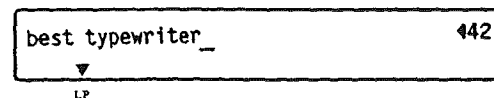

<At the end of text>

When the cursor is at the end of the text, characters are pulled one space to the right as each deletion is made.

- If the beginning of the text appears at the left side of the LCD with the cursor at the end of the text, the cursor will move to the left each time a deletion is made.

4. Inserting

- 1) Use the Backspace and/or Express Key to bring the cursor to the character one space to the right of where you want to insert text.
- 2) Hold down the Code Key and press the Backspace Key. The character above the cursor will alternately flash with a box mark (■).
- 3) Type the desired character(s) and/or space(s). Inserts are effected to the left of the cursor. The cursor moves one space to the right for each character inserted. (When the cursor is at the far-right side of the LCD, text is pushed to the left for each character inserted).
- 4) Hold down the Code Key and press the Backspace Key again. The insert mode is terminated and the cursor does not move.

OR

Press the Relocation Key. The Insert mode is terminated and the cursor returns to the end of the text.

11. AUTOMATIC WORD CORRECTION

This function allows you to correct the last or previously typed word(s) only on the current line with one operation.

1. Deleting the Last Word Typed on Paper

- 1) Hold down the Code Key and press the Correction Key. An intermittent beep will sound. Press the Space Bar. The typewriter will delete the word, starting from the last character.

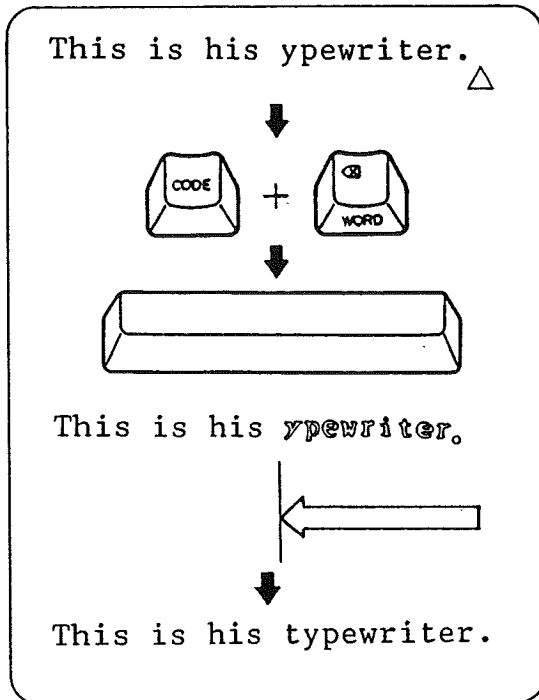

- 2) Type the correct word(s).

- To cancel this function before the word is deleted, hold down the Code Key and press the Correction Key again. Two beeps signal that the function has been canceled.

2. Deleting a Previous Word on the Current Line

- 1) While holding down the Code Key, press the Correction Key and then the last character of the word to be corrected. The Carrier moves to the position of that character and an intermittent beep will sound.

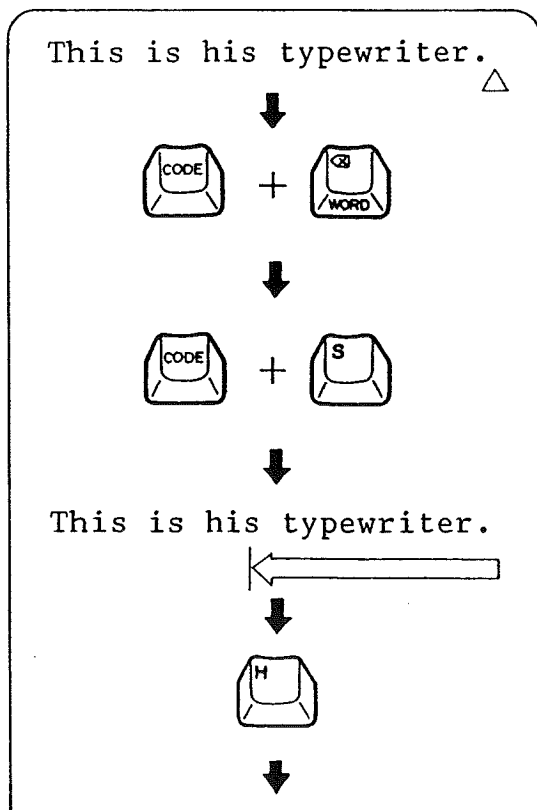

- 2) Press the first character of the word to be corrected. The typewriter will delete the word, starting from the last character.

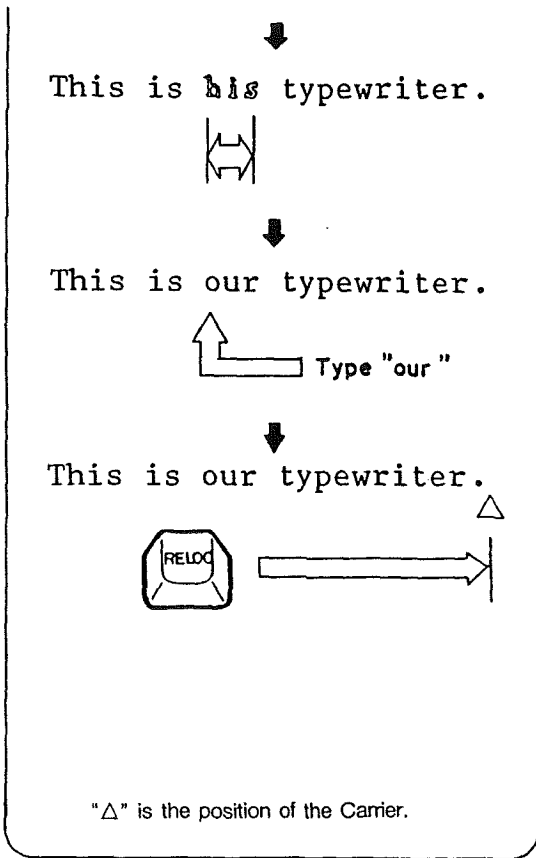

- 3) Type the correct word.
- To cancel this function before the word is deleted, hold down the Code Key and press the Correction Key again. Two beeps signal that the function has been canceled.
- 4) Press the Relocation Key to return the Carrier to its previous position.

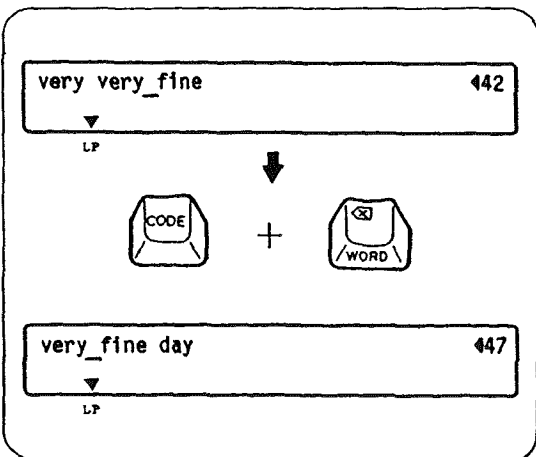

3. Deleting a Word on the LCD

- 1) Position the cursor under the space following the word you wish to delete.
- 2) Hold down the Code Key and press the Correction Key. The word is deleted and text is pulled to the left.
- Type any desired text after activating the insert mode.

SPELL CORRECTOR FUNCTION

The Spelling portion of this product is based on Proximity Linguistic Technology.

THE PROXIMITY/MERRIAM-WEBSTER LINGUIBASE

Copyright 1984 All Rights Reserved Proximity Technology, Inc.

Copyright 1984 All Rights Reserved Merriam-Webster Inc.

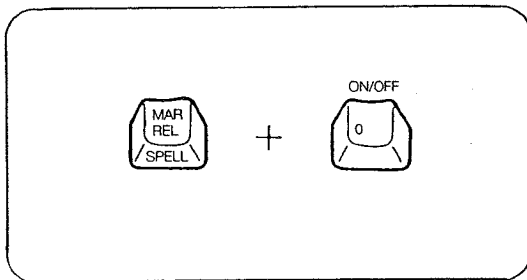

character
 character
 character

Room No. 505
 PICA/ELITE pitch

etc..
 forget-me-not
 The best type-
 writer

"i" signals the end of a word to the typewriter

1. Turning On/Off the Spell Corrector

- 1) Hold down the Margin Release (SPELL) Key and press the "0" (ON/OFF) Key. A beep sound indicates that the Spell Corrector is turned on.
- 2) Hold down the Margin Release (SPELL) Key and press the "0" (ON/OFF) Key again to turn off the Spell Corrector.

2. How the Spell Corrector Works

- 1) This typewriter is equipped with a 50,000 word Main Dictionary and when you type any series of characters (word) that is not found in the dictionary, a beep sounds at the end of the word. In addition to this dictionary, there is an approximately 100 word User Dictionary to register frequently used terms and proper nouns.
- 2) The Spell Corrector identifies a group of letters as a completed word when immediately followed by the characters and key functions below. The Spell Corrector therefore starts checking spelling from the first character of the next word.

Numbers: 0 1 2 3 4 5 6 7 8 9

Symbols: ! | @ # \$ % & ' () _ = + - \$ ¶

& < * > () _ = + - \$ ¶

• ½ ¼ [] : ; " ' ? /

Key functions: Space, Tab, Return, Index, Reverse Index

- Two periods or apostrophes in a row signal the end of a word.
- Hyphens that do not fall at the end of a line signal the end of a word.

3. Error Types

The Spell Corrector checks spelling and indicates error in the following manner:

- 1) For words not found in the dictionary, a beep will sound.
 - The names of major cities in the world, abbreviations of the 50 American states, common first and last names and frequently used contractions are also included in the 50,000 word dictionary.

Examples: New York, Tokyo, CA, IL, John, Mary, don't isn't

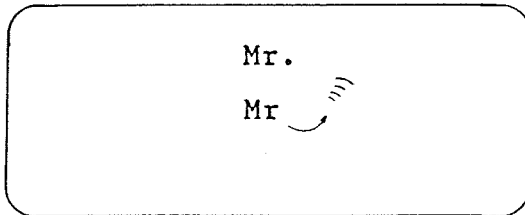
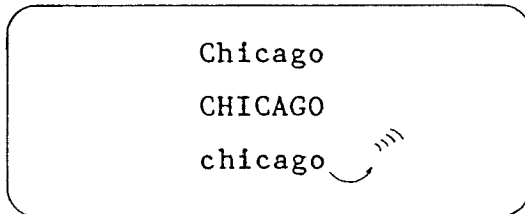

- 2) A beep sounds if the first letter of a proper noun or if all the letters of a proper noun are not capitalized.

Examples: Chicago, San Francisco, Tom

- 3) A period must be typed after all abbreviations. If not, a beep will sound.

Examples: Mr., bldg., etc.

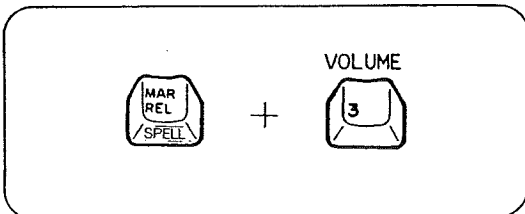

4. Beep Volume Adjustment

Any of 10 volume levels can be set from the Keyboard. When the power is first turned on, the beep volume is set to the fifth level.

Hold down the Margin Release (SPELL) Key and press the "3" (VOLUME) Key. Each time this key is pressed, the volume increases one step. The volume returns to the first level after it reaches the tenth level.

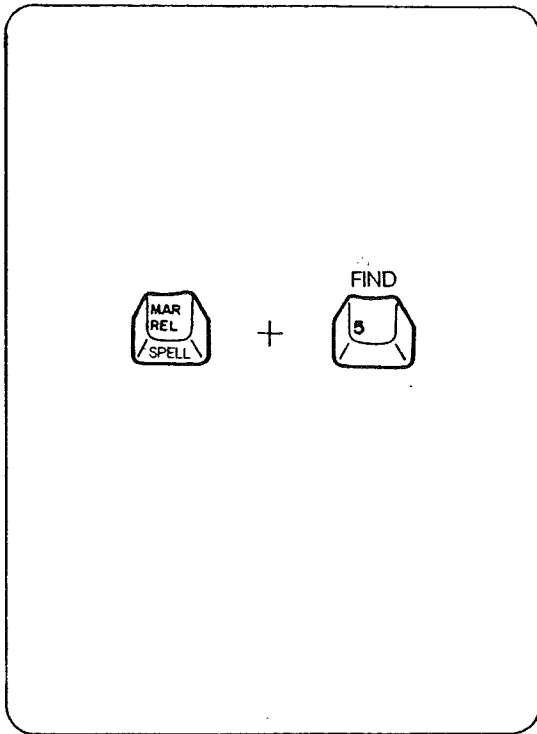

5. Finding Typing Errors on the Current Line

- 1) Hold down the Margin Release (SPELL) Key and press the "5" (FIND) Key. The Carrier will move to the first incorrect word on the current line.
 - 2) Correct the error.
 - 3) To find any other incorrect word, hold down the Margin Release (SPELL) Key and press the "5" (FIND) Key again. The Carrier or cursor moves to the next incorrect word. Then correct the error.
 - 4) Repeat the same procedure to correct all errors on the current line. The Carrier or cursor stops at the end of the line typed, after all errors are corrected.
- The one line memory is cleared by pressing return, center, index, reverse index.
 - This function cannot be used when editing the file.

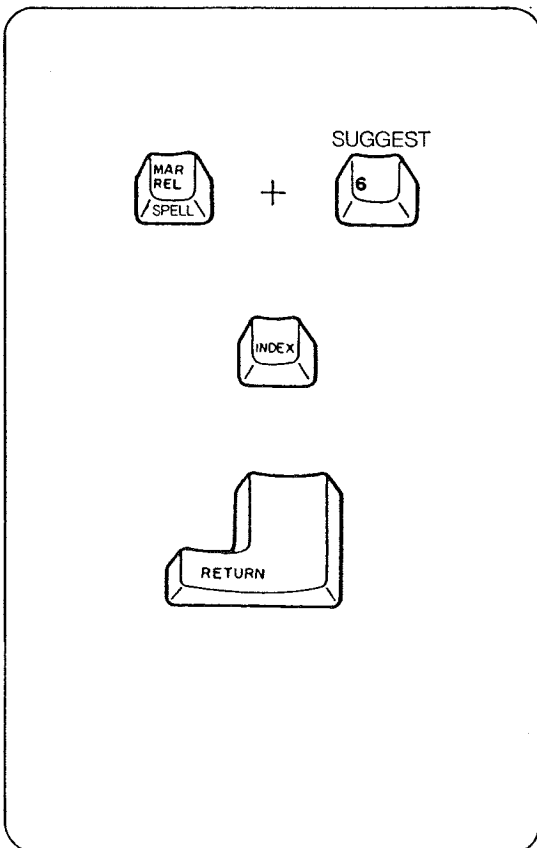

6. Suggestions for Similar Words

- 1) Move the Carrier or cursor to the word in question.
 - 2) Hold down the Margin Release (SPELL) Key and press the "6" (SUGGEST) Key. A similar word to the word in question appears on the LCD.
 - 3) Press the Index Key to display the next similar word, until the desired word appears.
 - 4) When the desired word appears, press the Return Key in order to correct the word.
- If the word in question is on the LCD, it is automatically replaced with the desired word when you press the Return Key.

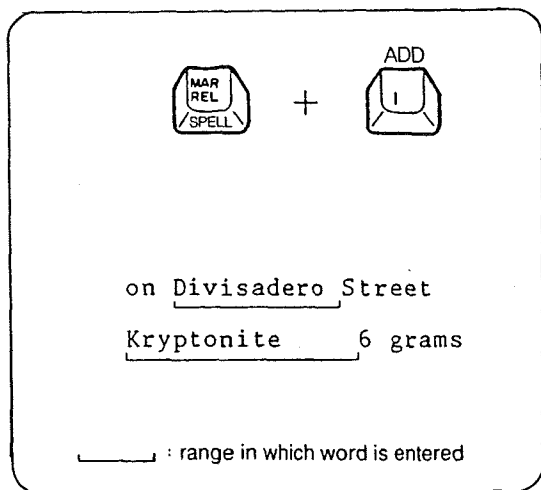

7. Adding Words to the User Dictionary

Names and unusual words not contained in the Main Dictionary can be stored in the User Dictionary.

- 1) Type the word to be stored in the User Dictionary.
 - 2) Hold down the Margin Release (SPELL) Key and press the "1" (ADD) Key. A beep sounds, confirming that the word has been stored. If no beep sounds, it means the word is already registered in the Main or User Dictionary and it will not be stored again.
- Previous words on the same line can be stored by backspacing to any position under the word to be entered.
 - If the User Dictionary is full, the word with the least usage frequency is automatically deleted to make room for new entries. The number of times you type each word in the User Dictionary is counted by the Spell Corrector, enabling it to rearrange them in the order of usage frequency.

8. Erasing Words from the User Dictionary

The words in the User Dictionary can be deleted desired.

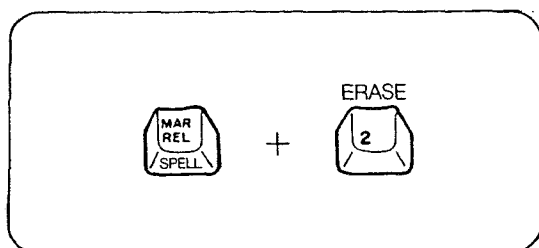

- 1) Type the word to be deleted from the User Dictionary.
 - 2) Hold down the Margin Release (SPELL) Key and press the "2" (ERASE) Key. A beep sounds, confirming that the word has been deleted. If no beep sounds, it means that the word has not been stored in the User Dictionary.
- The Print Point Indicator can be either below the word or one space immediately following the word to be deleted.
 - Previous words on the same line can be deleted by backspacing to any position under the word to be deleted.

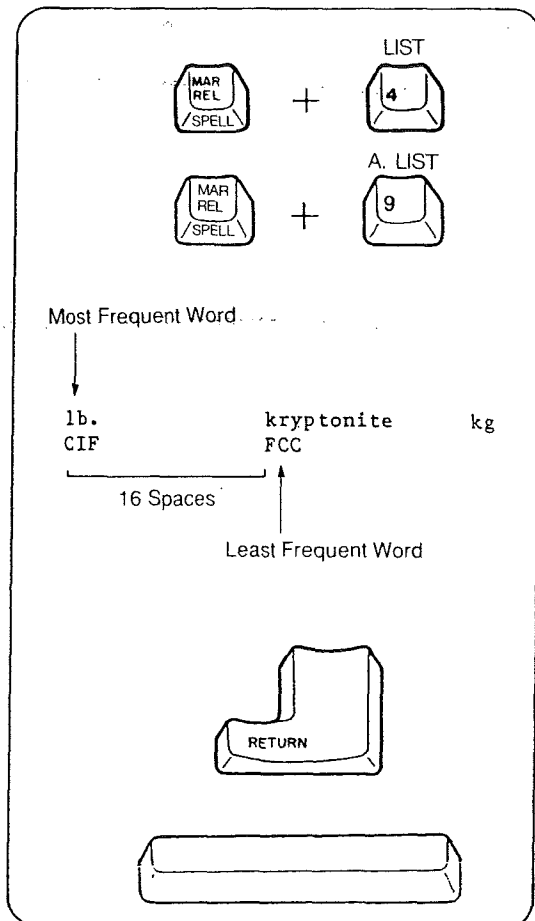

9. List of the User Dictionary

The words in the User Dictionary can be printed out in the order of usage frequency, or alphabetically. (The last word in the list is the first word which will be deleted to make room for new entries when the User Dictionary is full.)

- 1) Hold down the Margin-Release (SPELL) Key and press the "4" (LIST) Key. The words in the User Dictionary are printed in order of usage frequency in a certain format.

- 2) Hold down the Margin Release (SPELL) Key and press the "9" (A.LIST) Key. The words in the User Dictionary are now printed in alphabetical order.

- If the User Dictionary is empty, the expression "NO WORD" is shown in the display.
- The printout can be temporarily stopped by pressing the Return Key. Press the Return Key again to restart printout. Press the Space Bar during printout to cancel the list function.

■ Back-up battery

The Spell Corrector is provided with a back-up battery which protects data in the User Dictionary for a minimum of five years, even when the power switch is turned off. Six beeps sound when power is turned on if the back-up battery has been completely drained, and the contents of the User Dictionary have been erased. Please contact your nearest Sears Service Center in this case.

1. DECIMAL TABULATION

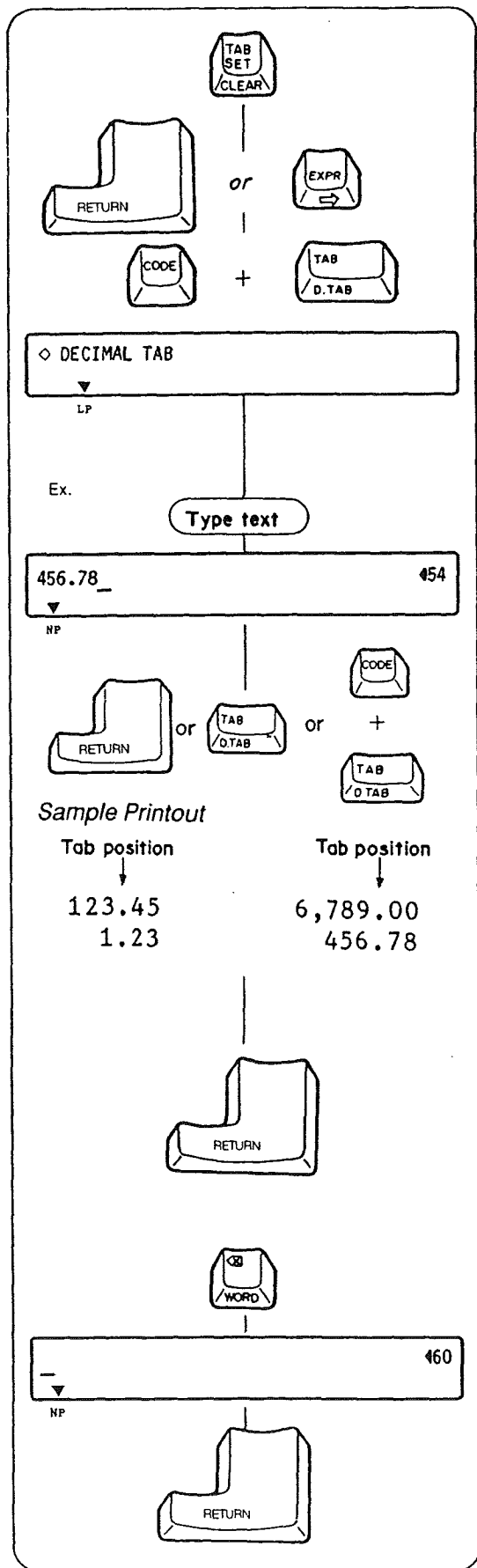

This function allows you to do statistical typing easily. All numbers are automatically aligned by their decimal points.

- 1) Set tab(s) at the decimal positions for each column.
- 2) Press the Return Key or Express Key to return the Carrier to the left margin.
- 3) Hold down the Code Key and press the Tab Key. "◇ DECIMAL TAB" appears on the LCD and the Print Point Indicator will move to the first tab stop.
- If any text remains on the LCD, it will be printed before the Carrier moves to the first tab stop.
- 4) Type the text with or without decimal point. Typed text is displayed on the LCD. Make corrections on the LCD before printout.
- 5) You now have three options to print the text.
 - a) Press the Return Key. Text will be printed and the Carrier stops at that position.
 - b) Press the Tab Key. Text will be printed and the Carrier will advance to the next tab position, making it a standard tab.
 - c) Hold down the Code Key and press the Tab Key. Text will be printed and the Carrier will advance to the next tab, making it a decimal tab again.
- 6) To advance to the next line, press the Return Key and repeat 3) through 5).
- To cancel the Decimal tab mode, first clear the text on the LCD using the Correction Key, and then press the Return Key. The Decimal tab mode will be canceled and the Carrier returns to the left margin on the next line.

2. AUTOMATIC CENTERING

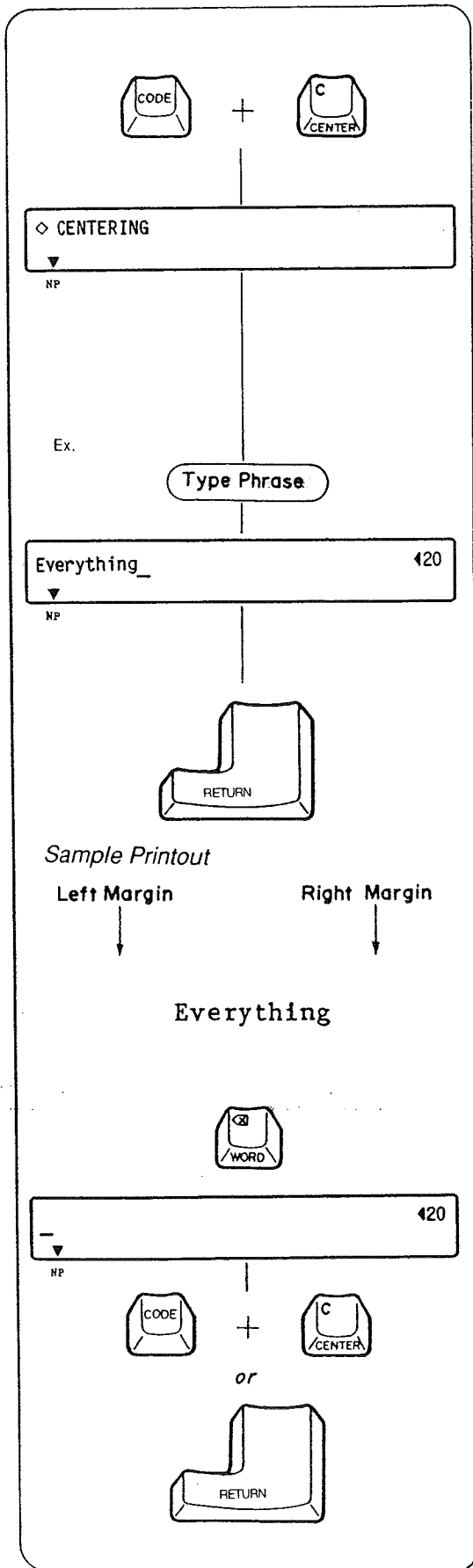

This function allows you to center text evenly between the left (or indent) and right margin.

- 1) Hold down the Code Key and press the "C" Key.
- 2) "◇ CENTERING" appears on the LCD and the Print Point Indicator automatically advances to the center of the margin setting.
 - If any text remains on the LCD, it will be printed before the Carrier advances to the center of the margin setting.
- 3) Type the phrase to be centered. Typed text is displayed on the LCD. Make corrections on the LCD before printout.
 - If more characters are typed than will fit between the left and right margins (the counter indicates "0"), a beep will sound. Press the Margin Release Key to continue typing.
- 4) Press the Return Key. The text is printed, centered between the left (or indent) and right margins, and the Automatic centering function is cleared. The Print Point Indicator remains positioned one space to the right of the centered text.
 - To cancel the Automatic centering function without printing, first clear the text on the LCD using the Correction Key, then hold down the Code Key and press the "C" Key.
 - or
 - Press the Return Key after clearing the text on the LCD. The Carrier returns to the left margin (or indent) on the next line.
 - This function can be used together with Bold typing and Automatic underlining functions.

3. AUTOMATIC PARAGRAPH INDENTATION

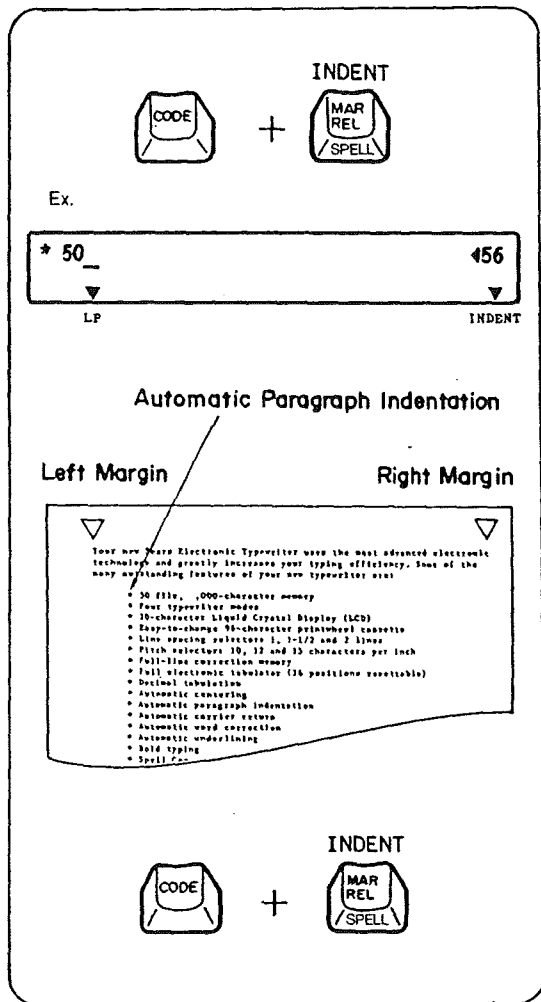

This function sets a temporary left margin, which eliminates the need for constant tabbing or spacing after each carrier return.

- 1) Move the Print Point Indicator to the position where the paragraph is to be indented.
- 2) Hold down the Code Key and press the Margin Release Key. A "▼" appears above "INDENT" on the LCD. The present position will be set as the temporary left margin until the function is canceled.
- 3) Type in the text to be indented.
- 4) To cancel Paragraph Indentation, hold down the Code Key and press the Margin Release Key again. The "▼" above "INDENT" on the LCD disappears.

4. BOLD TYPING

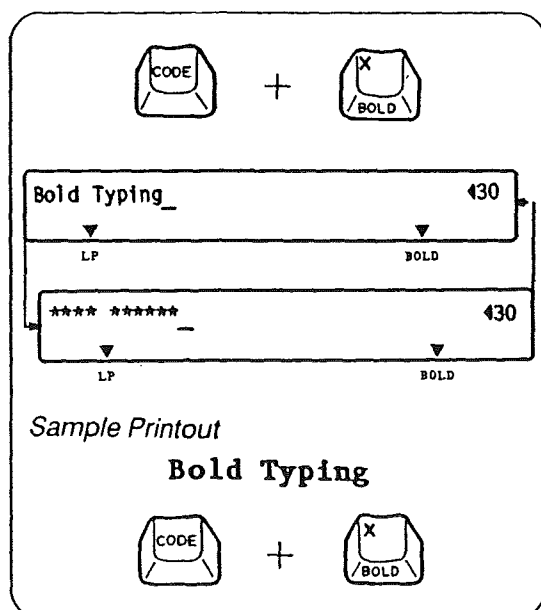

This function makes words stand out from the rest of the text. It's useful for emphasizing titles, critical information, etc.

- 1) Hold down the Code Key and press the "X" Key. A "▼" appears above "BOLD" on the LCD.
- 2) Type in the text.
 - On the LCD, characters to be emphasized in bold flash alternately with asterisks to distinguish them from other text.
- 3) To cancel Bold typing, hold down the Code Key and press the "X" Key again. The "▼" above "BOLD" on the LCD disappears.
- 4) This function can be used together with the Automatic centering and Automatic underlining functions.

5. AUTOMATIC UNDERLINING

This function underlines all text (including spaces) or individual words (all text except spaces) as you type.

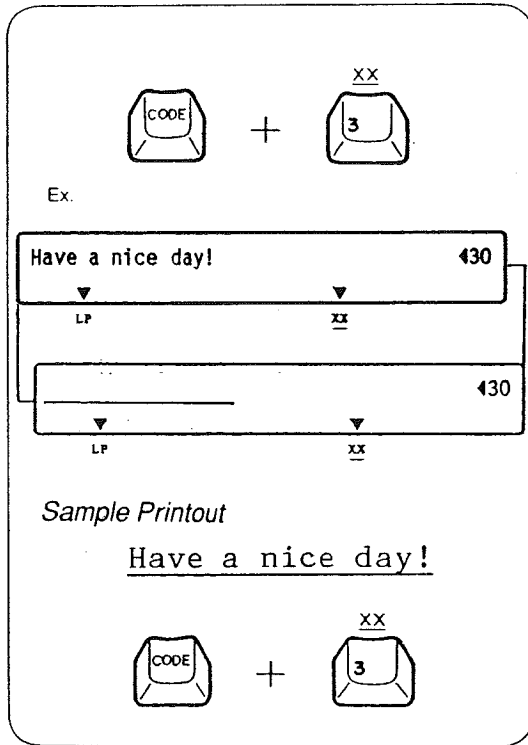

1. Automatic Full Underlining

- 1) Hold down the Code Key and press the "3" (XX) Key. A "▼" appears above "XX" on the LCD.
- 2) Type in the text to be underlined.
- Underlined text is distinguished on the LCD by the "▼" mark and characters which flash alternately.
- 3) To cancel the full underlining, hold down the Code Key and press the "3" (XX) Key again. The "▼" above "XX" on the LCD disappears.
- 4) This function can be used together with the Automatic centering and Bold typing functions.

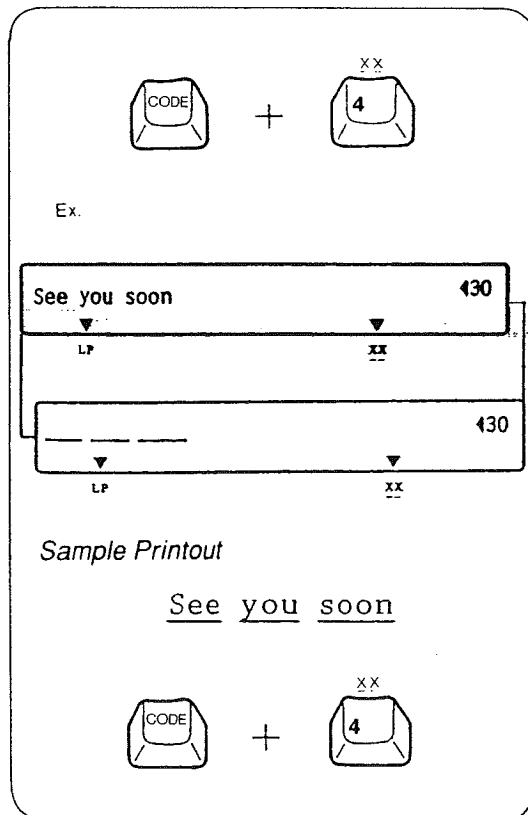

2. Automatic Word Underlining

- 1) Hold down the Code Key and press the "4" (XX) Key. A "▼" appears above "XX" on the LCD.
- 2) Type in the text to be underlined.
- Underlined text is distinguished on the LCD by the "▼" mark and characters which flash alternately.
- 3) To cancel the word underlining, hold down the Code Key and press the "4" (XX) Key again. The "▼" above "XX" on the LCD disappears.
- 4) This function can be used together with Automatic centering and Bold typing functions.

6. AUTOMATIC CARRIER RETURN

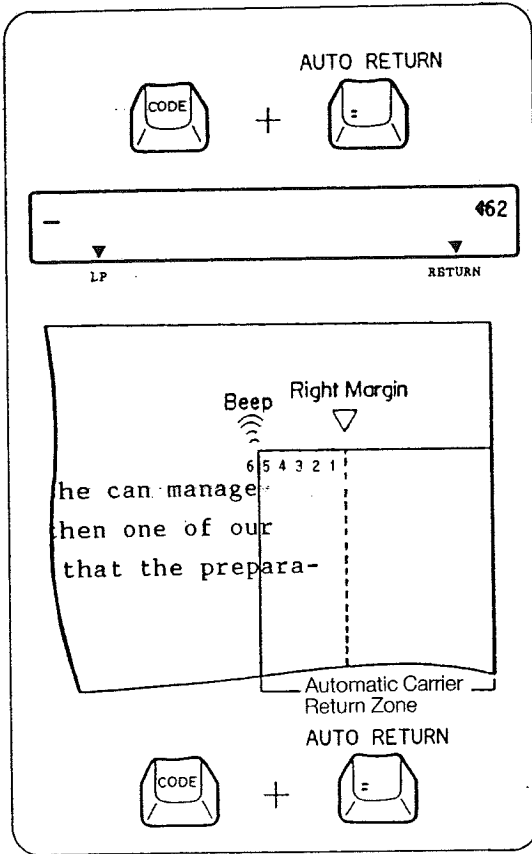

This function eliminates the need to press the Return Key at the end of every line.

- This function is automatically activated in STORE mode, but cannot be activated in JUST mode.
- 1) Hold down the Code Key and press the "=" Key. A "▼" appears above "RETURN" on the LCD.
 - 2) Once activated, the Carrier will automatically return when you type a hyphen or space in the automatic carrier return zone. The automatic carrier return zone is the area 5 spaces to the left of the currently set right margin. A beep is heard when the Carrier enters the automatic carrier return zone:
 - If a hyphen or space is not typed in the automatic carrier return zone, the Carrier will advance past the right margin.
 - 3) To cancel the Automatic carrier return function, hold down the Code Key and press the "=" Key again. The "▼" above "RETURN" on the LCD disappears.

7. REQUIRED HYPHEN AND REQUIRED SPACE

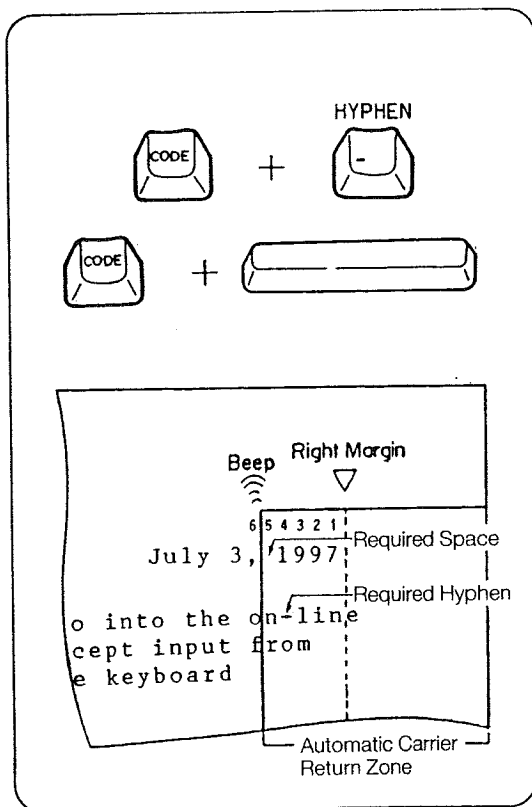

This function allows you to enter hyphens or spaces in the automatic carrier return zone that will not trigger the automatic carrier return.

- 1) To type a required hyphen or required space, hold down the Code Key and Hyphen Key or Space Bar.
- 2) Any hyphen or space typed in this manner will not be removed, nor will it trigger a carrier return.
 - Hyphens typed before entering the automatic carrier return zone when storing a file or when editing a file are automatically entered as required hyphens.
 - When a file is recalled, normal hyphens-i.e. usually syllable hyphens, originally typed in the automatic carrier return zone without the Code Key-will automatically be removed if they do not fall in the automatic carrier return zone during printout.
 - When a file is recalled, normal spaces (spaces typed without pressing the Code Key) will automatically trigger a carrier return if they fall in the automatic carrier return zone during printout.

8. SECOND KEYBOARD (SPECIAL CHARACTER SET)

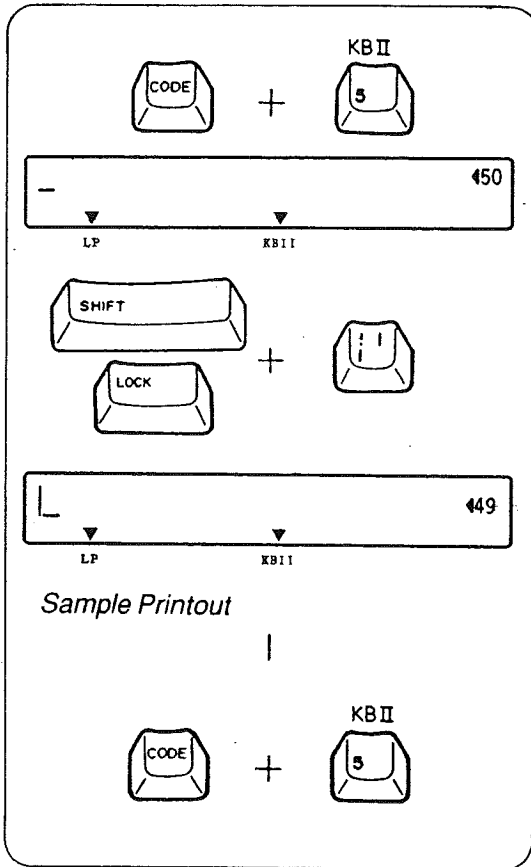

The symbols located at the upper right side of the three character keys can be typed with the following procedure.

- 1) Hold down the Code Key and press the "5" Key. A "▼" appears above "KBII" on the LCD.
- 2) Hold down the Shift Key, or press the Shift Lock Key, and type the key with the desired symbol. (If you pressed the Shift Key, keep it depressed).
- 3) Hold down the Code Key and press the "5" Key again to cancel the Second Keyboard and restore the standard keyboard. The "▼" above "KBII" on the LCD disappears.

9. CAPS LOCK

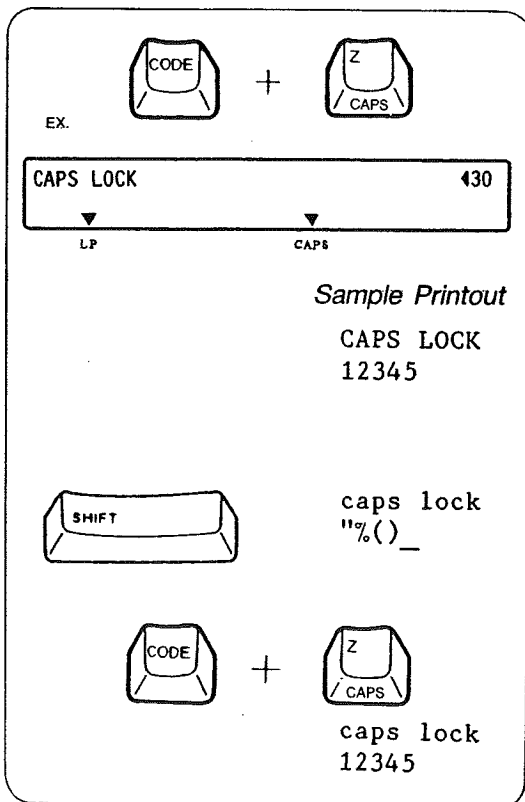

This function allows the typing of capital letters and numbers without pressing the Shift Key.

- 1) Hold down the Code Key and press the "Z" Key. A "▼" appears above "CAPS" on the LCD.
 - While in Caps lock mode, alphabetic characters are capitalized without pressing the Shift Key. The number/symbol keys are printed in lower case.
 - If you press the Shift Key in this mode, alphabetic characters are printed in lower case, and the number/symbol keys are printed in upper case.
- 2) To cancel Caps lock mode, hold down the Code Key and press the "Z" Key again. A "▼" above "CAPS" on the LCD disappears.

MEMORY FUNCTION

The memory functions will make your typing easier and more efficient.

Repetitive phrases, technical terminology and entire letters can be stored, edited and recalled (printed) at will.

You can also make several files with formats (margins and tabs) for letters and other documents you regularly type.

- Your typewriter has a memory back-up battery which protects the stored files for a minimum of five years, even when the power switch is turned off.
- When power is turned on, six beeps sound if the back-up battery has been completely drained. The contents of the stored file is erased. Please contact your nearest Sears Service Center in this case.

1. FILE STORING

This typewriter is equipped with a 10,000 character memory for storing up to 50 files.

Three types of files can be stored.

TEXT file ——— for entire letters

PHRASE file — for often-used phrases or terminology

FORMAT file — for line formats (margins and tabs only)

Choose the file type according to the text to be stored.

1. Storing a TEXT File

For storing entire letters (including tabs and margins).

- 1) Press the Mode Key until a "▼" appears on the LCD above "STORE". "NAME OF FILE?" is displayed.
 - 2) Type the file name (maximum of five letters/numbers). Then press the Return Key.
- You can terminate the STORE mode at any time by pressing the Mode Key. Any entered text will be automatically stored.

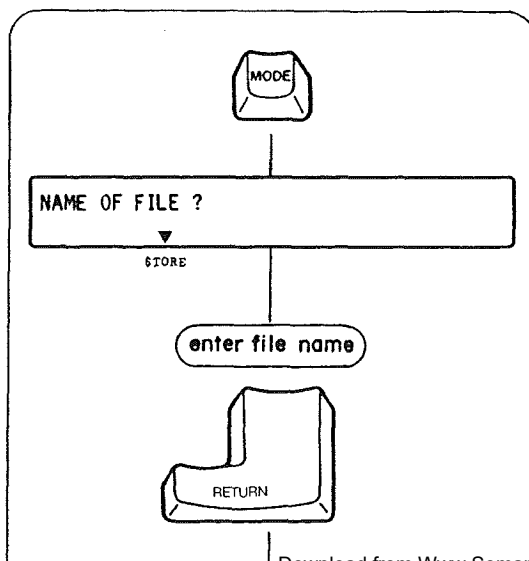

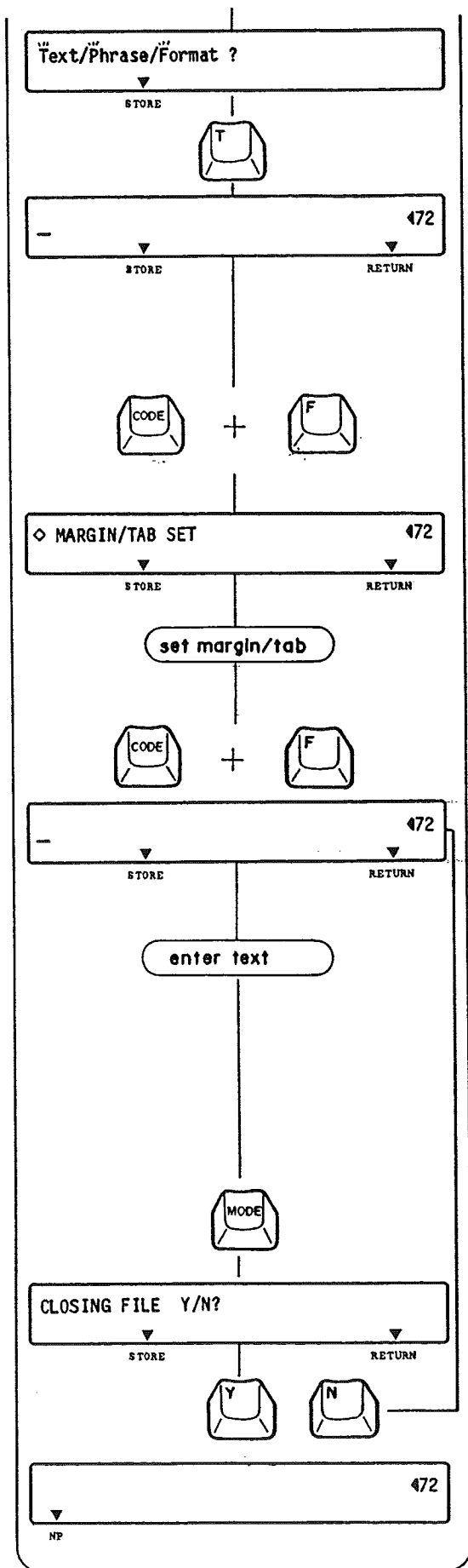

- 3) "Text/Phrase/Format?" appears on the LCD. "T", "P" and "F" will flash.
- 4) Press the "T" (TEXT) Key.
The paper is fed one line and the Carrier returns to the left margin. The LCD is cleared and the counter indicating the number of spaces to the right margin appears. The Automatic return is automatically activated.
 - Margin and tab settings, as well as other functions which were in effect before entering the STORE mode, are automatically canceled to be stored in the back-up memory. They are automatically recalled when you exit the STORE mode.
- 5) Hold down the Code Key and press the "F" Key. "◇ MARGIN/TAB SET" appears.
- 6) Set the left and right margins and tabs, as you would in the NP mode. Clear any unnecessary tabs.
- 7) Hold down the Code Key and press the "F" Key again. "◇ MARGIN/TAB SET" disappears. The Carrier returns to the newly set left margin.
- 8) Enter text. Entered text is displayed on the LCD and printed one line at a time when you type a normal hyphen or space in the automatic carrier return zone.
 - Make corrections on the LCD before the line is printed. Once text is printed on paper, it cannot be corrected. To make corrections after text has been printed, first close the file and edit it on the LCD, as described in section 3, "File Editing".
- 9) Press the Mode Key to terminate the STORE mode. "CLOSING FILE Y/N?" appears on the LCD.
- 10) Press the "Y" Key to close the file and return to the Normal Print (NP) mode.
 - Press the "N" Key to return to the Text storing mode.

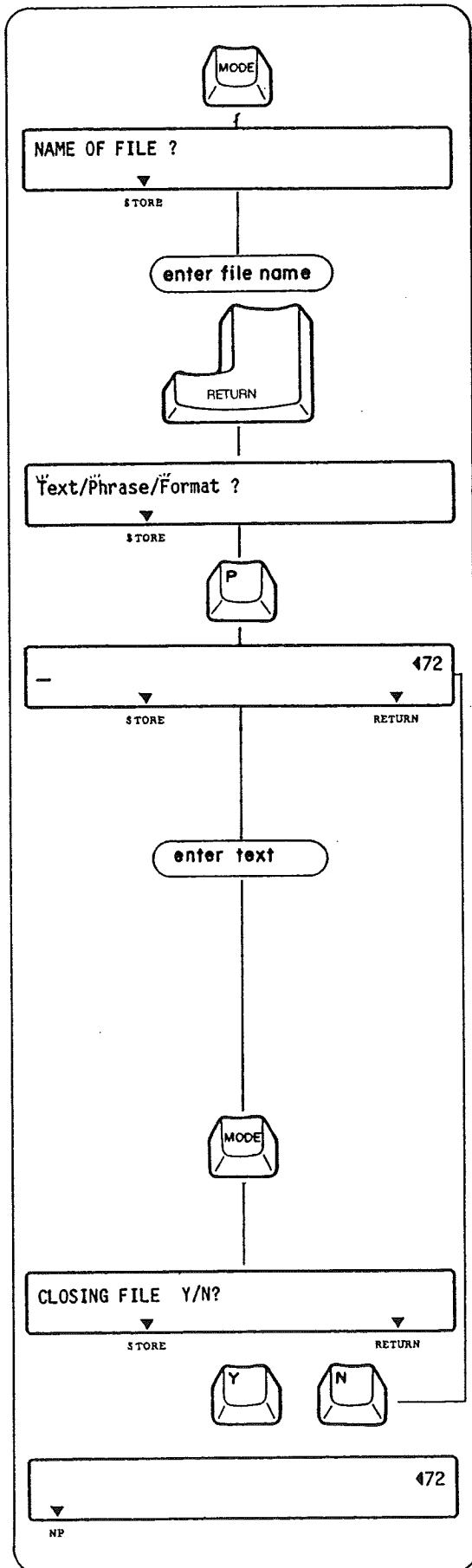

2. Storing a PHRASE File

Phrase files are used to store brief expressions or terminology without margins or tabs.

- 1) Press the Mode Key until a "▼" appears on the LCD above "STORE". "NAME OF FILE?" is displayed.
- 2) Type the file name (maximum of five letters/numbers). Then press the Return Key:
 - You can terminate the STORE mode at any time by pressing the Mode Key. Any entered text will be automatically stored.
- 3) "Text/Phrase/Format?" appears on the LCD. "T", "P" and "F" will flash.
- 4) Press the "P" (PHRASE) Key. The LCD is cleared and the counter indicating the number of spaces to the right margin appears. The Automatic return is automatically activated.
 - The Underlining and Bold functions set before entering the STORE mode are automatically canceled to be stored in the back-up memory. They are automatically recalled when you exit the STORE mode.
- 5) Enter text. Entered text is displayed on the LCD and printed one line at a time when you type a normal hyphen or space in the automatic carrier return zone.
 - Make corrections on the LCD before the line is printed. Once text is printed on paper, it cannot be corrected. To make corrections after text has been printed, first close the file and edit it on the LCD, as described in section 3, "File Editing".
- 6) Press the Mode Key to terminate the STORE mode. "CLOSING FILE Y/N?" appears on the LCD.
- 7) Press the "Y" Key to close the file and return to the Normal Print (NP) mode.
 - Press the "N" Key to return to Phrase storing mode.

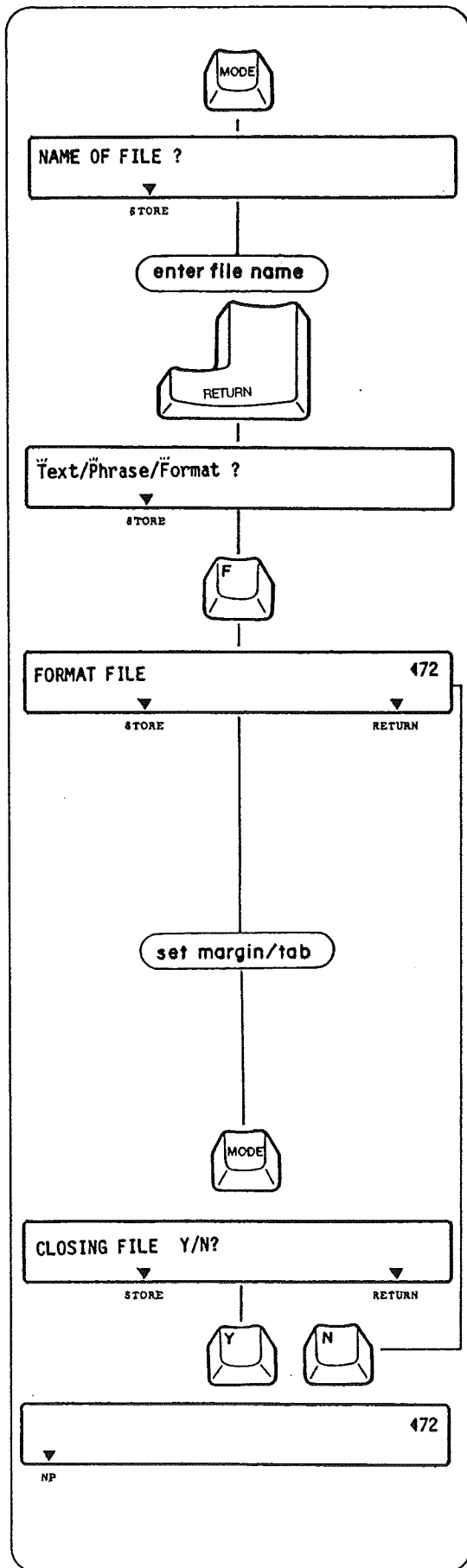

3. Storing a FORMAT File

For storing margin and tab line formats. This function is useful for typing onto preprinted forms.

- 1) Press the Mode Key until a "▼" appears on the LCD above "STORE". "NAME OF FILE?" is displayed.
- 2) Type the file name (maximum of five letters/numbers). Then press the Return Key.
 - You can terminate the STORE mode at any time by pressing the Mode Key. Any entered format data will be automatically stored.
- 3) "Text/Phrase/Format?" appears on the LCD. "T", "P" and "F" will flash.
- 4) Press the "F" (FORMAT) Key.
 - Margin and tab settings, as well as other functions which were in effect before entering the STORE mode, are automatically canceled to be stored in the back-up memory. They are automatically recalled when you exit the STORE mode.
- 5) Set the left and right margins and tabs at any position as you would in any other mode. Clear any unnecessary tabs.
- 6) Press the Mode Key to terminate the STORE mode. "CLOSING FILE Y/N?" appears on the LCD.
- 7) Press the "Y" Key to close the file and return to the Normal Print (NP) mode.
 - Press the "N" Key to return to the Format storing mode.

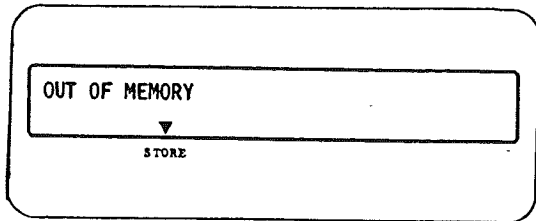
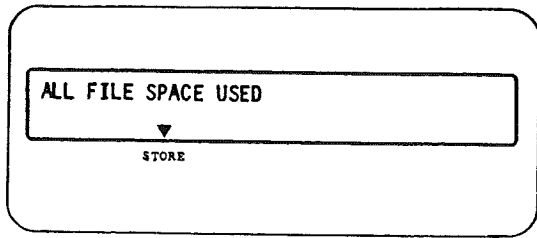

2. STOP CODE

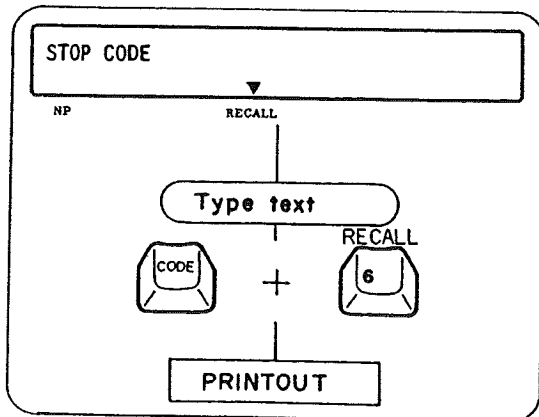
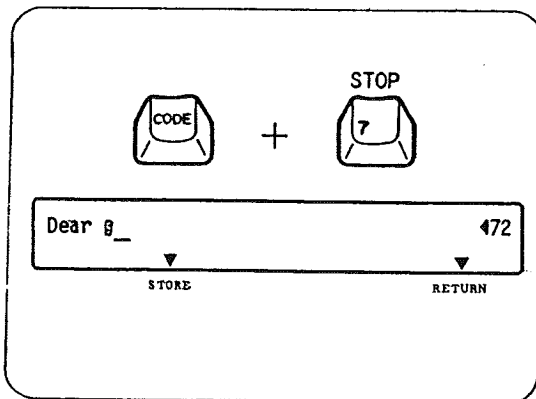

4. All File Space Used

If you specify a new file and there are already 50 files in the typewriter memory, "ALL FILE SPACE USED" appears on the LCD.

In this case, one file must be deleted to create a new file. (Refer to "File Deleting".)

5. Out of Memory

If you run out of memory, "OUT OF MEMORY" appears on the LCD.

In this case, press the Mode Key to store entered text and return to the NP mode. Unneeded file(s) must be deleted to make room in the memory for your present file. (Refer to "File Deleting".)

To stop printing at locations in a file in order to type words or phrases during recalling (printing), enter stop codes while storing or editing the file.

1. Entering Stop Codes

1) Hold down the Code Key and press the "7" Key at the position you wish to stop in the file. A highlighted "S" is displayed on the LCD.

• You can remove the stop code by deleting the character "g" with the Correction Key.

2) An "X", which stands for the stop code, is printed on the paper when the line is printed while you are storing the file. (When entering stop codes while editing the file, an "X" is not printed.) The "X" is only an indicator, and will not appear during recall (printout).

2. Using Stop Code During Recalling (Printing)

1) When the typewriter has stopped at a stop code during printout, "STOP CODE" appears on the LCD.

2) Type desired text.

3) Hold down the Code Key and press the "6" Key to restart printout. (Refer to "File Recall".)

The stop code can also be used in conjunction with the decimal tab or auto centering, as a Decimal tab stop or an Auto center stop.

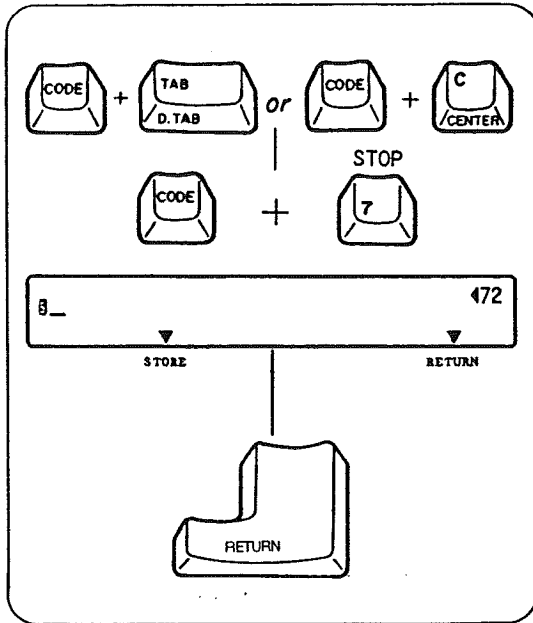

3. Entering a Decimal Tab/Auto Center Stop Code

- 1) First activate the Decimal tab/Automatic centering function.
- 2) Then enter the stop code. A highlighted "S" is displayed on the LCD.
- You can remove the stop code by deleting the character "S" with the Correction Key.
- 3) Press the Return Key. An "X" which represents the stop code is printed on the paper. (When entering stop codes while editing a file, there is no need to press the Return Key and an "X" is not printed.) The "X" is only an indicator, and will not appear during recall (printout).

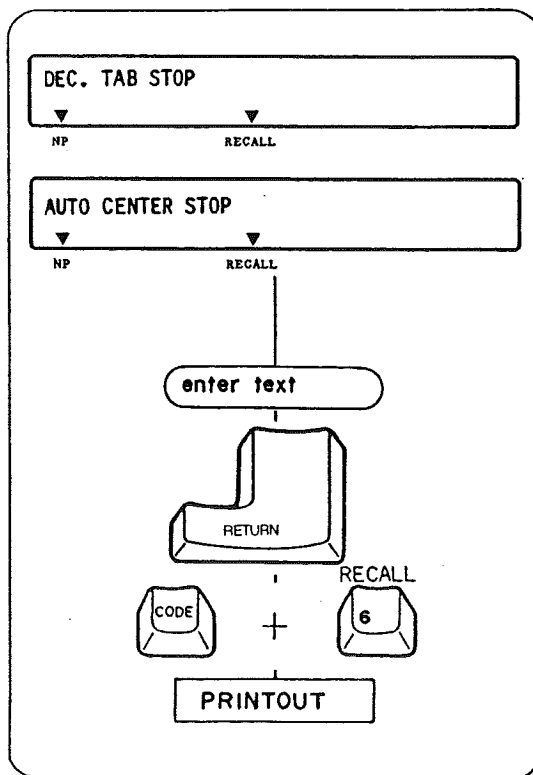

4. Using a Decimal Tab/Auto Center Stop Code During Recalling (printing)

- 1) When the typewriter has stopped at a Decimal tab stop or Auto center stop during printing, "DEC. TAB STOP" or "AUTO CENTER STOP" will appear on the LCD.
- 2) Enter desired text. Entered text is displayed on the LCD.
- 3) Press the Return Key or Tab Key for decimal tab stop to print the text. (Refer to "Decimal Tab", "Automatic Centering".)
- 4) Hold down the Code Key and press the "6" Key to restart printout. (Refer to "File Recall".)

3. FILE EDITING

This function allows you to edit stored files on the LCD.

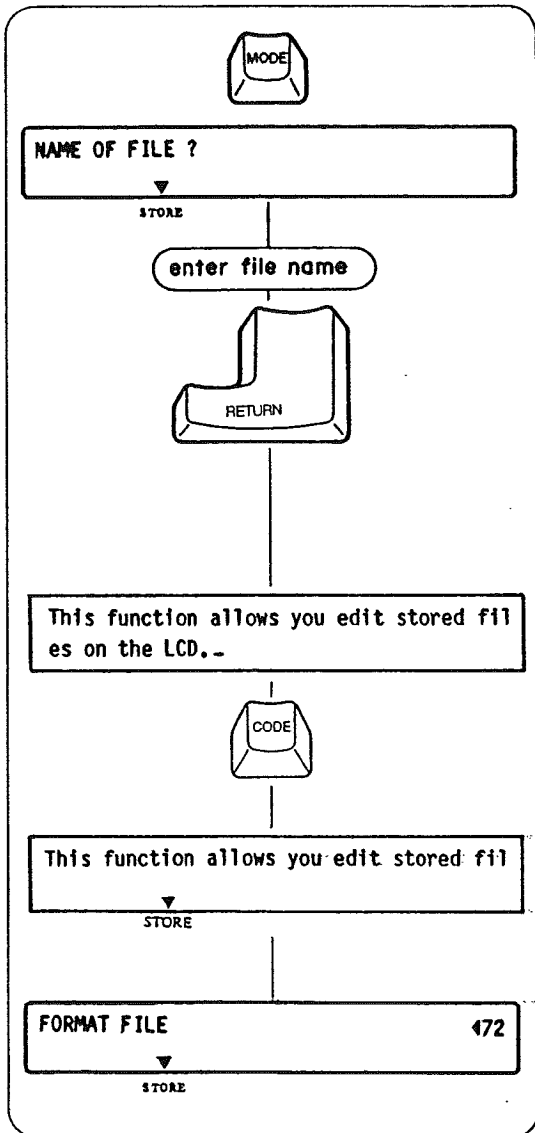

1. Activating Edit Mode

- 1) Press the Mode Key until a "▼" appears on the LCD above "STORE". "NAME OF FILE?" is displayed.
- 2) Type the file name to be edited (maximum of five letters/numbers). Then press the Return Key.
 - You can terminate the Edit mode by pressing the Mode Key (and the "Y" Key to close the file) at any time.
- 3) The beginning of the file appears on the LCD. Move the cursor to any position in the file and edit it. Make corrections as explained in "Corrections on LCD".
 - In the Edit mode, when more than 40 characters are entered, they appear on the LCD in 2 lines. In order to check which features are engaged, depressing the Code Key will change the LCD to one line and the "▼" marks will appear to show the mode and feature settings. When the Code Key is released, the indication on the LCD returns to 2 lines.
 - When you specify a format file, "FORMAT FILE" appears. Move the Carrier to any position and set the new margins/tabs as you would in any other mode.

2. Function Symbols

When stored text is displayed on the LCD, the typewriter functions are represented by the symbols shown at left.

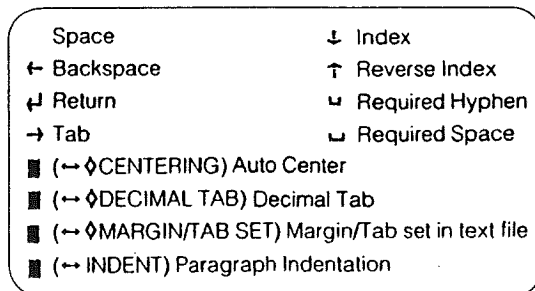

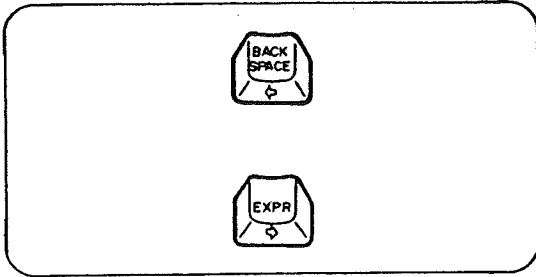

3. Moving Cursor

- 1) Press the Backspace Key to move the cursor one space to the left.
 - 2) Press the Express Key to move the cursor one space to the right.
- Hold down either key for continuous movement.

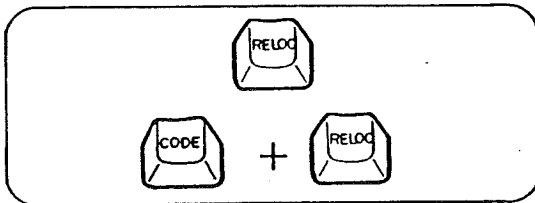

4. Going to the Beginning or End of a File

- 1) Press the Relocation Key to go to the end of the file.
- 2) Hold down the Code Key and press the Relocation Key to go to the beginning of the file.

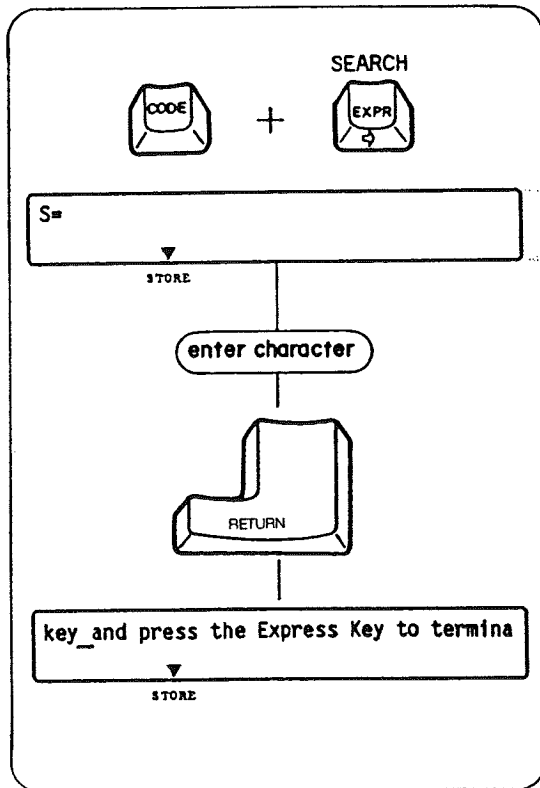

5. Moving Cursor to Desired Position (Using the Search Function)

- 1) Hold down the Code Key and press the Express Key. "S=" appears on the LCD.
 - 2) Type the characters you want to find (maximum of 18 characters).
 - 3) Press the Return Key. The typewriter searches for the text that you have typed from its present position (regardless of any underlining of text.)
 - 4) Once found, the cursor appears at the position after the last letter of that text. If the text that you have typed is not in the file, the cursor returns to its previous position before function activation.
- The desired text will be memorized by the typewriter until power is turned off, and appears every time you activate the Search function. It is useful to find any other occurrences of the same text.

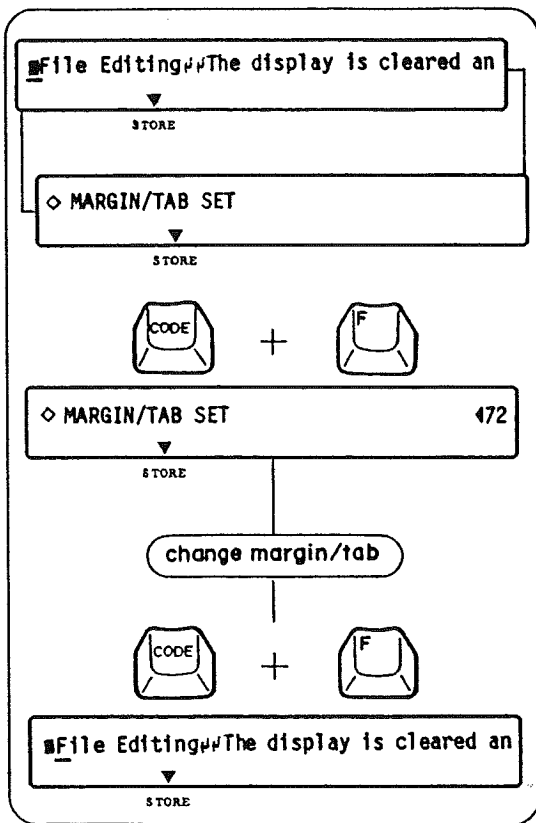

6. Changing Existing Margin and Tab Settings (in the Text File Only)

- 1) Locate the box mark (■) which will alternately flash with "◇ MARGIN/TAB SET" when you bring the cursor under it.
- 2) Hold down the Code Key and press the "F" Key. The counter indicating the remaining number of spaces to the right margin appears. The margin/tab settings in this file are recalled.
- 3) Set any new margins and tabs, moving the carrier to any position as you would in any other mode.
- 4) Hold down the Code Key and press the "F" Key again. The cursor returns one space to the right of the box mark (■).

7. Back Code

To move the Carrier back one space at the left margin or a tab position, enter back codes while editing the file.

● Hanging Indentation

This function is used to temporarily move the character(s) to the left of the stored left margin of text. It causes the beginning of the paragraph to be highlighted and the reader of the text to distinguish the beginning of each paragraph.

● Saving Tab

This function is used to temporarily move the character(s) to the left of a stored tab position or indent position in the text. Tab memory can be saved with this function.

Entering Back Codes

Hold down the Code Key and press the "B" Key. The symbol "←" appears on the LCD.

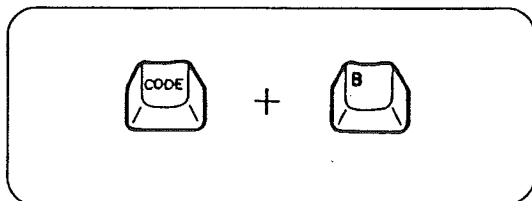

4. FILE RECALL (PRINTOUT ON PAPER)

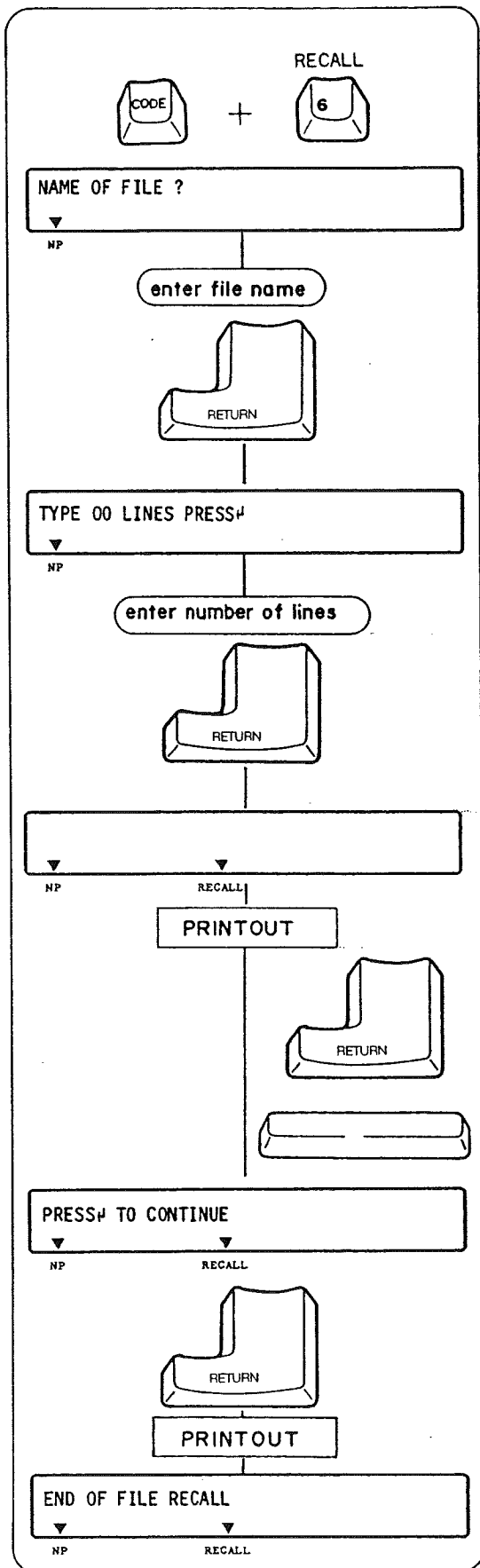

This function allows you to recall (print out) the stored file in the NP or JUST mode.

- The LCD must be cleared to activate the File recall.

1. Recalling a TEXT File

- 1) Hold down the Code Key and press the "6" Key. "NAME OF FILE?" appears on the LCD. Type the file name and press the Return Key.

- "NOT FOUND PRESS ←" appears on the LCD if you have entered a file name that is not stored in the memory. Press the Return Key and retype the file name.

- 2) The Carrier will move to the left margin setting of that particular file and "TYPE 00 LINES PRESS ←" appears on the LCD.

- 3) Type in any number of lines from 01 to 99. (Standard 11" paper is 66 single-spaced lines long and 14" paper is 84 single-spaced lines long.) Then press the Return Key.

- If you do not enter the number of lines desired, printing will not stop until the end of the file.

- 4) A "▼" appears on the LCD above "RECALL", and the typewriter will print the file.

- To temporarily stop printout, press the Return Key. "PAUSE PRESS ←" appears on the LCD. Restart printing by pressing the Return Key again.

- You can cancel the recall function at any time during printout by pressing the Space Bar. "END OF FILE RECALL" appears on the LCD when the recall has been canceled.

- 5) The typewriter will stop after printing the specified number of lines, and "PRESS ← TO CONTINUE" appears on the LCD asking you to restart printing. Press the Return Key to restart printout.

- You can not cancel the recall function by pressing the Space Bar when "PAUSE PRESS ←" or "PRESS ← TO CONTINUE" is displayed on the LCD.

- 6) When the recall has been completed, "END OF FILE RECALL" appears on the LCD.

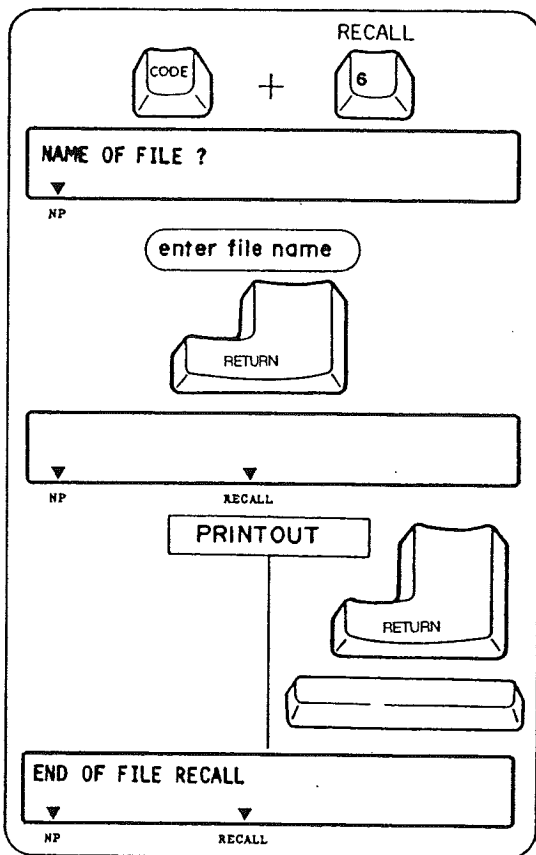

2. Recalling a PHRASE File

- 1) Hold down the Code Key and press the "6" Key. "NAME OF FILE?" appears on the LCD. Type the file name and press the Return Key.
 - "NOT FOUND PRESS ←]" appears on the LCD if you have entered a file name that is not stored in the memory. Press the Return Key and retype the file name.
- 2) A "▼" appears on the LCD above "RECALL", and the Carrier will start printing from its present position, according to the margins which are currently set.
 - To temporarily stop printout, press the Return Key. "PAUSE PRESS ←]" appears on the LCD. Restart printing by pressing the Return Key again.
 - You can cancel the Recall function at any time after starting a printout by pressing the Space Bar. "END OF FILE RECALL" appears on the LCD when recall has been canceled.

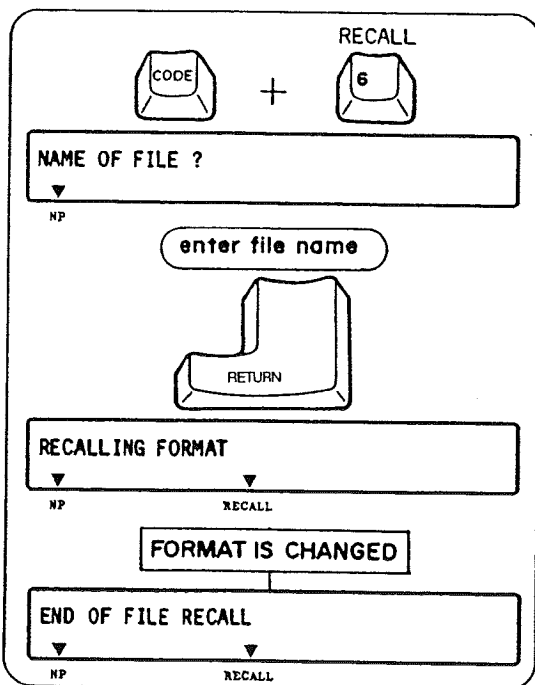

3. Recalling a FORMAT File

- 1) Hold down the Code Key and press the "6" Key. "NAME OF FILE?" appears on the LCD. Type the file name and press the Return Key.
 - "NOT FOUND PRESS ←]" appears on the LCD if you have entered a file name that is not stored in the memory. Press the Return Key and retype the file name.
- 2) A "▼" appears on the LCD above "RECALL". While "RECALLING FORMAT" appears on the LCD, the margin/tab format set on the typewriter will be automatically changed to the recalled one, and then "END OF FILE RECALL" appears on the LCD.
 - The printing stops at any stop code in the file and "STOP CODE", "DEC. TAB STOP" or "AUTO CENTER STOP" appears on the LCD. Enter desired text and restart printout by holding down the Code Key and pressing the "6" Key. (Refer to "Stop Code".)

5. FILE LISTING

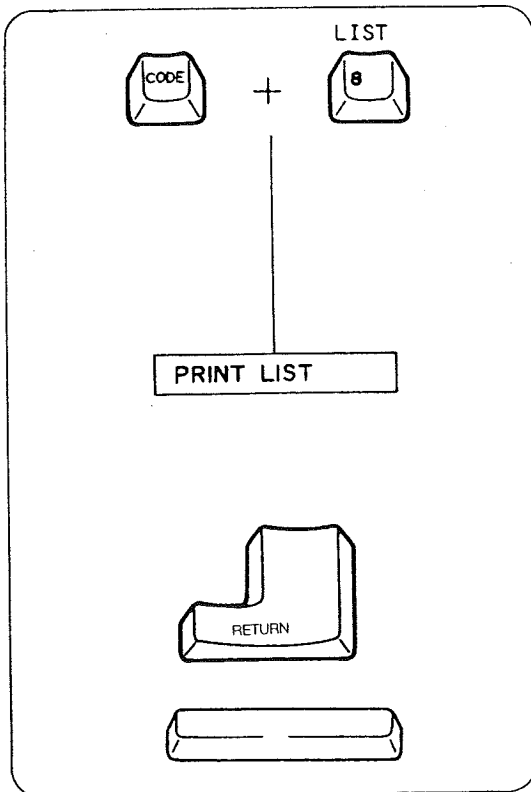

Sample Printout

```
TEXT      LTR1 :Dear X Thank you very much for your lett
PHRASE    PHRS1:Please remember me kindly to your parent
FORMAT    FRMT1:
```

```
3515 CHARACTERS AVAILABLE
03 FILES
```

This function allows you to print a list of stored files.

- The LCD must be cleared to activate this function, and it cannot be activated in the STORE mode.
- 1) Hold down the Code Key and press the "8" Key.
- "00 FILES" is printed if there are no files in the memory.
- 2) The type of file, file name and the first 40 characters in the file are printed in a certain format from position 10 on the margin scale (in 10 pitch), regardless of the present margin settings. The number of characters remaining (available) in the memory and number of files already in memory are printed at the end of this list.
- To temporarily stop printout, press the Return Key. "PAUSE PRESS ←" appears on the LCD. Restart printing by pressing the Return Key again.
 - Press the Space Bar to terminate this function after it has been activated.

6. AVAILABLE MEMORY CAPACITY

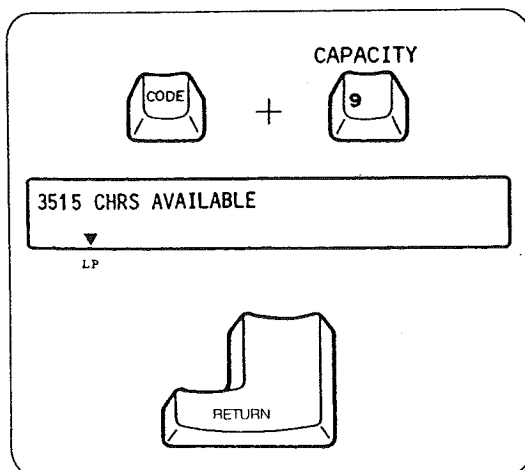

This function allows you to see exactly how much memory is still available.

- The LCD must be cleared to activate this function, and it cannot be activated in the STORE mode.
- 1) Hold down the Code Key and press the "9" Key.
 - 2) The amount of memory available is automatically displayed on the LCD.
 - 3) Press the Return Key to terminate this function.

7. FILE DELETING

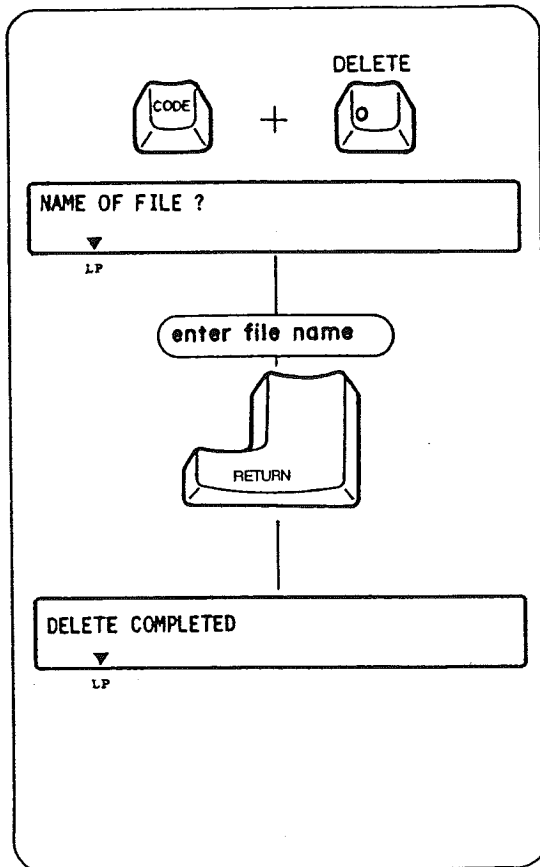

Use this function to delete any unnecessary files or to make room for new files in the memory.

- The LCD must be cleared to activate this function, and it cannot be activated in the STORE mode.
- 1) Hold down the Code Key and press the "0" Key. "NAME OF FILE?" appears on the LCD.
 - 2) Type in the file name and press the Return Key.
 - 3) "DELETE COMPLETED" will appear on the LCD if the file was in the typewriter memory.
- "NOT FOUND PRESS ←" will appear if the file was not in the memory. Press the Return Key and retype the file name. Use Correction Key to delete any name on the LCD, if necessary.
 - You can cancel the file deleting function by pressing the Return Key only if there is no file name on the LCD.
- 4) Press the Return Key to terminate this function.

8. MEMORY ALL CLEAR

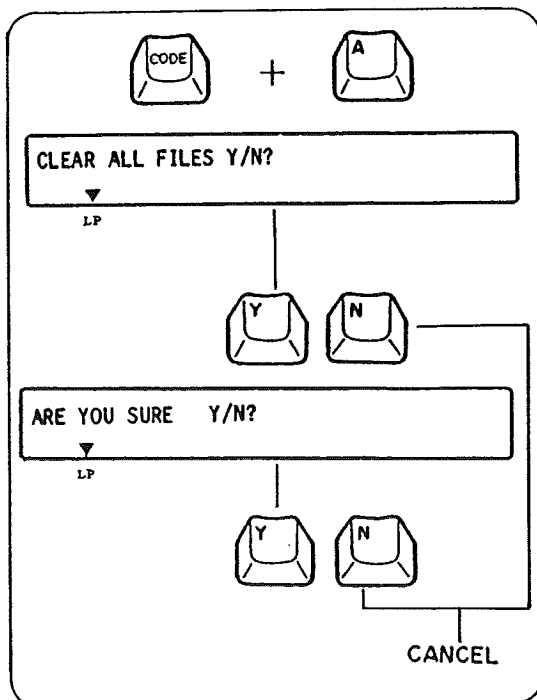

This function allows you to delete all files in the memory.

- The LCD must be cleared to activate this function, and it cannot be performed in the STORE mode.
- 1) Hold down the Code Key and press the "A" Key. "CLEAR ALL FILES Y/N?" appears on the LCD.
 - 2) Press the "Y" Key. "ARE YOU SURE Y/N?" appears on the LCD, asking for confirmation.
 - 3) All files are cleared when the "Y" Key is pressed again.
- The function is canceled if the "N" Key is pressed after the first or second prompt.

9. BLOCK OPERATIONS (COPY/MOVE/DELETE)

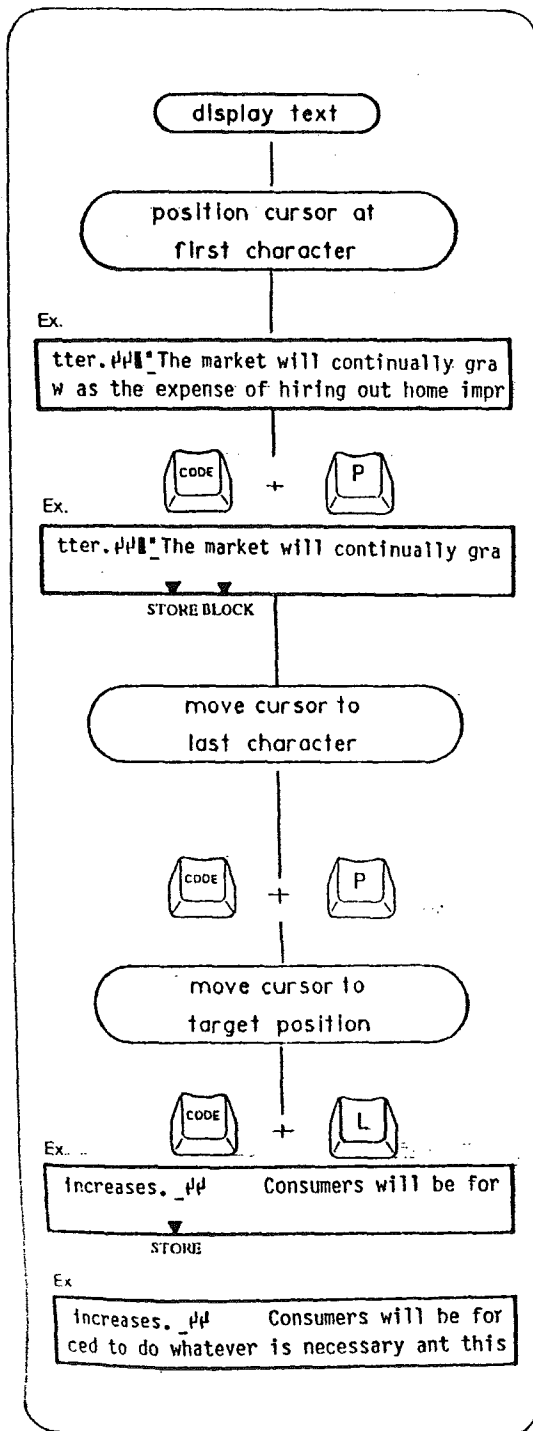

1. Block Copy

This function copies a block of text and inserts the copy at a specified location in the file. Block copy does not alter or remove the contents of the original block.

- 1) Display the file text using the edit mode.
 - 2) Position the cursor on the first character of the text to be copied.
 - 3) Hold down the Code Key and press the "P" Key. This marks the beginning of the block. Two beeps sound and a "▼" appears above "BLOCK" on the display. (BLOCK function becomes effective at this time.)
 - 4) Move the cursor to the last character of the text to be copied.
 - 5) Hold down the Code Key and press the "P" key again to mark the end of the block. Two beeps sound, indicating that the block of text has been defined. The defined block of text starts flashing on the display.
 - 6) Move the cursor to the position where you want to copy the block of text.
 - 7) Hold down the Code key and press the "L" key. The block of text is copied at the specified position. The "▼" above "BLOCK" disappears. The block function is canceled at this time.
- If the defined block of text does not exceed 1 character, the copy operation is not carried out and the block function is canceled.

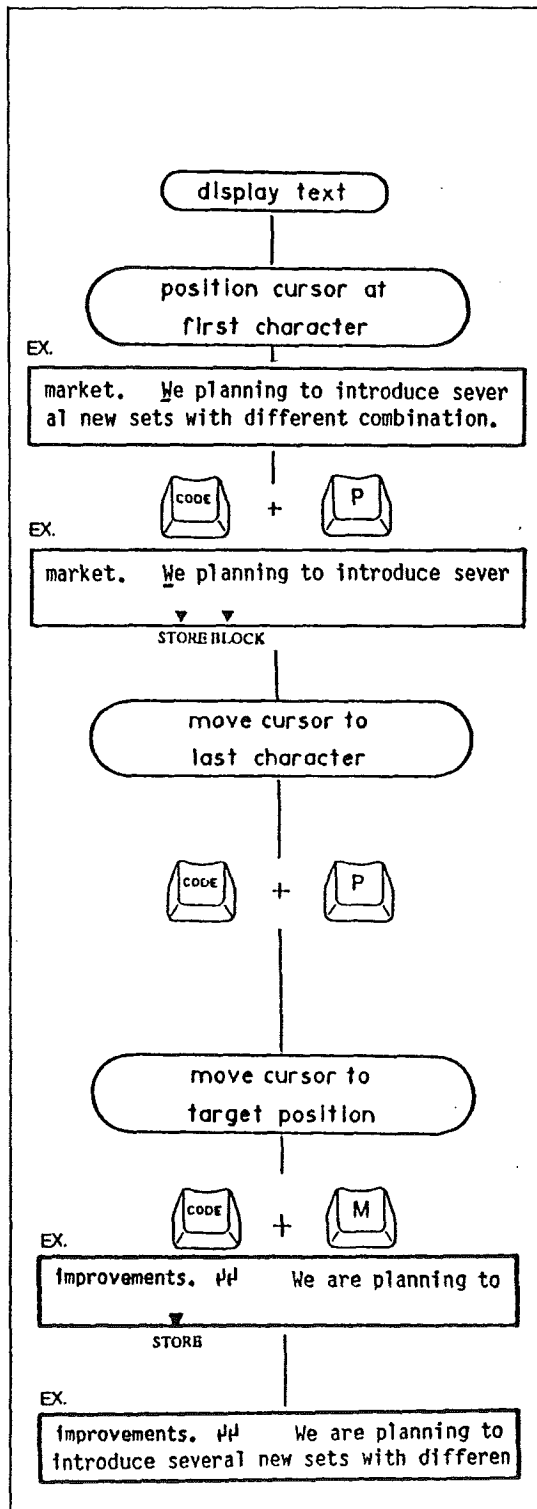

2. Block Move

This function moves a block of text to a specified location in the file.

- 1) Display the file text using the edit mode.
 - 2) Position the cursor on the first character of the text to be moved.
 - 3) Hold down the Code Key and press the "P" Key. This marks the beginning of the block. Two beeps sound and a "▼" appears above "BLOCK" on the display, indicating that the block function is in effect.
 - 4) Move the cursor to the last character of the text to be moved.
 - 5) Hold down the Code Key and press the "P" key again to mark the end of the block. Two beeps sound, indicating that the block of text has been defined. The defined block of text starts flashing on the display.
 - 6) Move the cursor to the position where you want to move the block of text.
 - 7) Hold down the Code Key and press the "M" Key. The block of text is moved to the specified position. "▼" above "BLOCK" disappears. The block function is canceled at this time.
- When a block of text is moved, succeeding characters are shifted to the left to fill in the space created by the moving of text.

3. Block Delete

This function deletes a block of text in a file.

- 1) Display the file text using the edit mode.
- 2) Position the cursor on the first character of the text to be deleted.
- 3) Hold down the Code Key and press the "P" Key. This marks the beginning of the block. Two beeps sound and a "▼" appears above "BLOCK" on the display, indicating that the block function is in effect.
- 4) Move the cursor to the last character of the text to be deleted.
- 5) Hold down the Code Key and press the "P" key again to mark the end of the block. Two beeps sound, indicating that the block of text has been defined. The defined block of text starts flashing on the display.
- 6) Hold down the Code Key and press the Correction Key. The block of text is deleted and all succeeding text is shifted to the left to fill in the space created. The "▼" mark above "BLOCK" disappears, indicating that the block function is canceled.

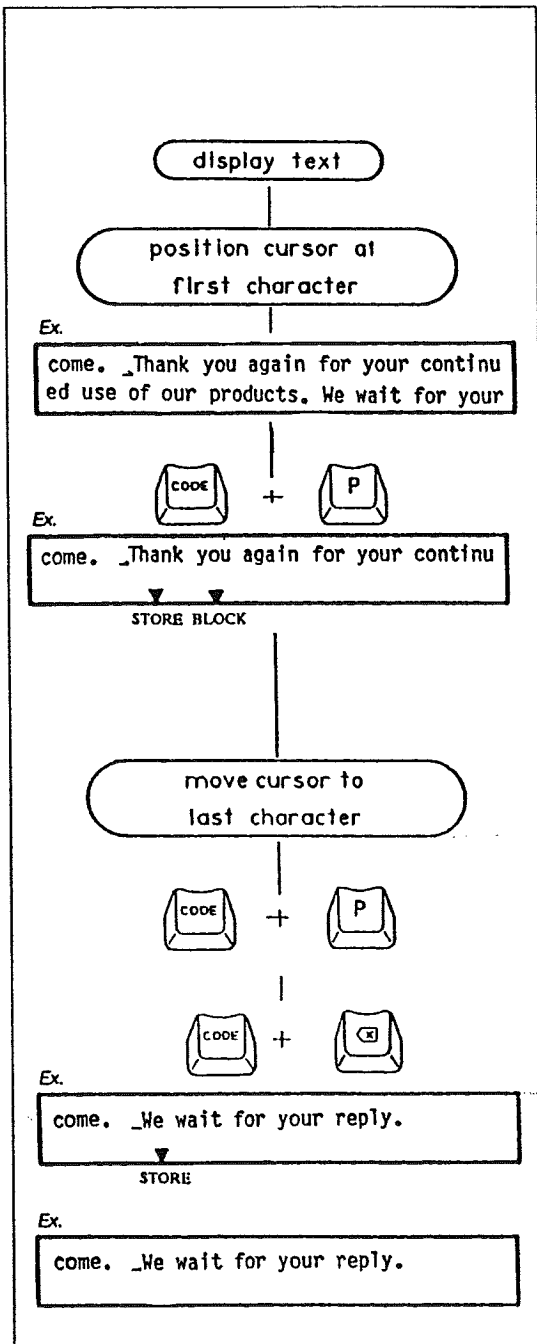

SUPPLIES

1. Printwheel

Your typewriter comes with a Prestige 10 Printwheel (Sears No. 54018). Besides this type style, a variety of printwheels with different type styles as listed below are available for your machine.

Sears No.	Type Style	Pitch	Type Style Sample:
54011	Prestige	12	ABCDEabcde1234
54012	Courier	10	ABCDEabcde1234
54013	Courier	12	ABCDEabcde1234
54014	Cubic	10	ABCDEabcde1234
54015	Script	12	ABCDEabcde1234
54016	Orator	10	ABCDEABCDE1234
54017	Mini Gothic	15	ABCDEabcde1234

Contact the nearest Sears Store or Catalog Plant for further information.

2. Ribbon Cassette

- 1) Correctable Black Carbon Film Ribbon — 54085
Your typewriter comes with Correctable Black Carbon Film Ribbon. This ribbon is not reusable because the inked surface of the ribbon is transferred to the paper as you type.
- 2) Nylon Fabric Ribbon — 54091
This optional ribbon can be used to type a considerably larger number of characters than Carbon Film Ribbon.

3. Correction Tape

- 1) Lift-off Correction Tape — 54009
Your typewriter comes with Lift-off Correction Tape. This correction tape is used only with Correctable Black Carbon Film Ribbon (No. 54085) which was originally installed on your typewriter. It lifts the black carbon film ink off the paper.
- 2) Cover-up Correction Tape — 5498
This optional correction tape covers up the error and is used only with Nylon Fabric Ribbon (No. 54091).

AFTER USING THE TYPEWRITER AND TO STORE

- 1) Turn off the on/off Switch and disconnect the Power Cord from the electrical outlet.
- 2) Store the Power Cord in the Cord Compartment.
- 3) Replace the Keyboard Cover and fasten securely.

MAINTENANCE AND SERVICE

1. Cleaning

- 1) Do not attempt to disassemble the typewriter to clean it.
- 2) Dust the typewriter lightly, using only a dry cloth.
- 3) Never use water or solvents such as thinner, alcohol, etc. to clean your typewriter.
- 4) When the Top Cover is opened for replacement of the Printwheel, Ribbon Cassette or Correction Tape, be sure not to drop items such as a pin, paper clip, nail file, etc. into the typewriter. They may cause damage to the typewriter.

2. Service

- 1) It is recommended that your typewriter be serviced at least once a year by a Sears qualified service technician. Any malfunction caused by maintenance performed by anyone other than Sears qualified service personnel will void the warranty.
- 2) If the typewriter fails to function or does not function properly, check the following:
 - Is the typewriter plugged into a live socket?
 - Is the typewriter switched on?
 - Is the Printwheel properly installed? (See Page 9, Section 2, Paragraph 2)
 - Are the Ribbon Cassette and the Correction Tape properly installed?
 - Have the Ribbon Cassette or Correction Tape been used up?

If the typewriter still does not work properly after checking the above, contact your nearest Sears Service Center.

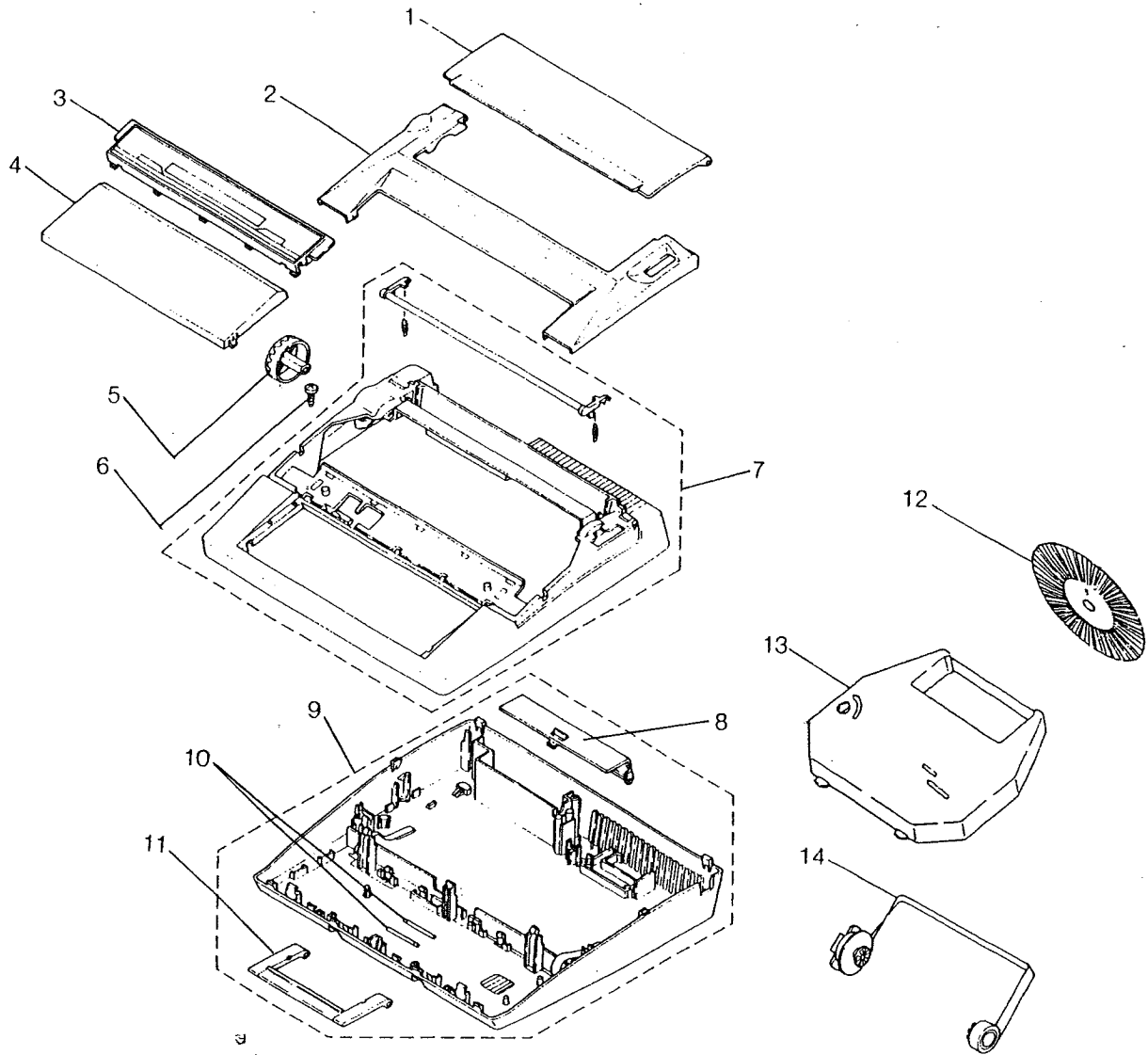

Key No.	Description	Part No.
1	Paper Support	060-71520-44
2	Top Cover	005-13062
3	LCD Assembly	060-27300
4	Keyboard Cover	060-70530
5	Platen Knob	060-70540-45
6	Screw	200-71020
7	Cover Assembly	005-61513
8	Cord Storage Cover	060-70580-44
9	Bottom Pan Assembly	005-70711
10	Handle Hinge Pin	200-70180
11	Handle	060-70320-44
12	Printwheel	} See page 46
13	Ribbon Cassette	
14	Correction Tape	

Your Sears Merchandise has added value when you consider that Sears has Service Units nationwide staffed with Sears trained professional technicians using Sears approved parts and methods. For replacement parts or service not shown above, contact your nearest Sears Service Center.

SEARS

OWNERS MANUAL

**MODEL NO.
161.53514090**

HOW TO ORDER REPAIR PARTS

Now that you have purchased your typewriter, should a need ever exist for repair parts or service, simply contact any Sears Service Center and most Sears Stores. Be sure to provide all pertinent facts when you call or visit.

757481

WORD PROCESSING TYPEWRITER

**WHEN ORDERING REPAIR PARTS, ALWAYS GIVE THE
FOLLOWING INFORMATION:**

1. PART NUMBER
2. PART DESCRIPTION
3. MODEL NUMBER 161.53514090
4. NAME of ITEM-WORD PROCESSING TYPEWRITER

All parts listed may be ordered from any Sears Service Center and most Sears Stores.

If the parts you need are not stocked locally, your order will be electronically transmitted to a Sears Repair Parts Distribution Center for expedited handling.

Sears, Roebuck and Co., Chicago, IL. 60684 U.S.A.

SEARS**OWNERS
MANUAL****WORD
PROCESSING
TYPEWRITER****MODEL NO.
161.53514090****Operation
Repair parts****CAUTION:
Read Rules for
Safe Operation
and Instructions
Carefully**

757481

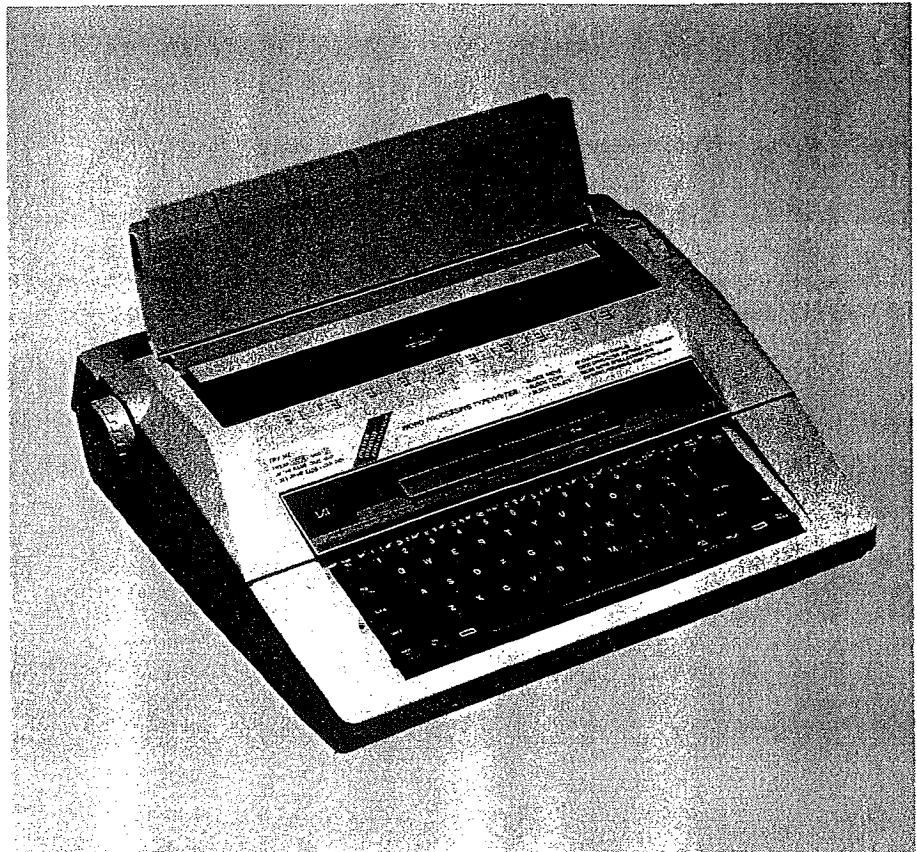
**Warranty****FULL ONE YEAR WARRANTY**

For one year from the date of purchase, Sears will repair this Typewriter, free of charge, if defective in material or workmanship.

WARRANTY SERVICE IS AVAILABLE BY CONTACTING THE NEAREST SEARS SERVICE CENTER/DEPARTMENT IN THE UNITED STATES. This warranty applies only while product is in use in the United States.

This warranty gives you specific legal rights, and you may also have other rights which vary from state to state.

SEARS, ROEBUCK AND CO., Dept. 731 CR-W, Sears Tower, Chicago, IL. 60684

Word Processing Typewriter

Record in space provided below the Model No. and Serial No. of this appliance.

The Model No. and the Serial No. are located at the back of the machine.

Model No. 161.53514090 Serial No. _____

Retain these numbers for future reference.

Sears, Roebuck and Co., Chicago, IL. 60684 U.S.A.

NOTE: This equipment has been tested and found to comply with the limits for a Class B digital device, pursuant to Part 15 of the FCC Rules. These limits are designed to provide reasonable protection against harmful interference in a residential installation. This equipment generates, uses and can radiate radio frequency energy and, if not installed and used in accordance with the instructions, may cause harmful interference to radio communications. However, there is no guarantee that interference will not occur in a particular installation. If this equipment does cause harmful interference to radio or television reception, which can be determined by turning the equipment off and on, the user is encouraged to try to correct the interference by one or more of the following measures:

- Reorient or relocate the receiving antenna.
- Increase the separation between the equipment and receiver.
- Connect the equipment into an outlet on a circuit different from that to which the receiver is connected.
- Consult the dealer or an experienced radio/TV technician for help.

RULES FOR SAFE OPERATION

- 1) Your new Sears Typewriter has been designed to operate on standard U.S.A. Power 110-120 Volts AC, 60Hz only.
- 2) Your typewriter is a highly sophisticated mechanism, so never attempt to repair it yourself. If repair becomes necessary, have it repaired by Sears qualified serviceman.
- 3) Never insert metal objects such as a screwdriver, paper clip, nail file, etc., inside the typewriter. This could cause damage to the typewriter, and/or electrical shock.
- 4) Do not leave your typewriter unattended when the machine is on. Always turn off the typewriter when you have finished typing.

Your new Sears Word Processing Typewriter uses the most advanced electronic technology and greatly increases your typing efficiency. Some of the many outstanding features of your new typewriter are:

- 50 line, 10,000-character memory
- Four typewriter modes
- 40-character Liquid Crystal Display (LCD: 40 character 2 lines)
- Easy-to-change 100-character printwheel
- Line spacing selector: 1, 1-1/2 and 2 lines
- Pitch selector: 10, 12 and 15 characters per inch
- 5-year memory back-up battery
- Full-line correction memory
- Full electronic tabulator (16 positions resettable)
- Automatic centering (1)
- Decimal tabulation (7)
- Automatic paragraph indentation (5)
- Automatic carrier return
- Automatic word correction
- Automatic word/full underlining (4)(6)
- Bold typing (3)
- Required hyphen
- Required space (2)
- Block copy/move/delete
- Spell Corrector
- Caps lock
- Self demonstration (See below)

* The number in brackets refers to the Sample Letter on the next page.

Hold down the Code Key and press the "D" Key to automatically print out the feature listing as follows:

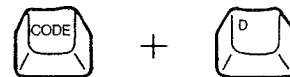

THIS *WORD PROCESSING* TYPEWRITER HAS MANY FEATURES TO MAKE TYPING EASIER.

- * 80 CHARACTER DISPLAY - Allows you to review and edit text before printing.
- * SPELLING CHECK - Automatically checks spelling of 50,000 words plus checks an additional 100 words that may be special to you.
- * TEXT MEMORY - Allows you to review, edit and recall up to 10,000 characters.
- * DUAL MARGIN ALIGNMENT - Automatically "blocks" both sides of the typing, just like it is on this page.
- * BLOCK OPERATIONS - Allows you to move, copy, delete and insert entire blocks of text for enhanced editing.
- * 3 PITCH SELECTIONS - Allows a much wider variety of type styles.
- * OTHER FEATURES INCLUDE - **BOLD TYPING**, Automatic carrier return,

-Automatic Centering-

Paragraph Indentation, Decimal tabulation, Automatic Underlining, CAPS LOCK and many more.

Sample Letter

"Tools for Everyone" **Automatic Centering (1)**
Consolidated Tool Co., Inc.
138 Elm Boulevard
Chicago, Illinois 60690

June 3, 1997

Everyday Hardware, Inc.
10301 Main Street
Portland, Oregon 98645

Required Space (2) 

Dear Sir;

Thank you very much for your letter of May 23 and for your inquiry as to any developments in our product line for next year.

As a favored customer, you are presently entitled to a 10% discount on all products ordered. We certainly understand your position and we realize that recently the market for our products has been somewhat slow. Therefore to thank you for your continued patronage, we have decided that we can offer an additional 5% discount. We hope that this will help the situation.

Bold Typing (3)

The following passage from Tools Today typifies our feelings on the matter.

Automatic Full Underlining (4)

Paragraph Indentation (5) "The market will continually grow as the expense of hiring out home improvements increases. Consumers will be forced to do whatever is necessary and this fact offers a grand opportunity to all those involved in this area!"

Please look under the following areas in the Company Prospectus inserted which describes our goals for the coming years:

<u>Section Title</u> Automatic Word Underlining (6)	<u>Section</u>	<u>Pages</u>
Meeting the New Markets	2.3-2	31 - 46
Our Answer	11.6	93 - 102
What We Can Do Together	18.14	209 - 234

Decimal Tabulation (7)

Thank you again for your continued use of our products. We wait for your reply.

Very truly yours,

James Harrison
Assistant Sales Manager

This owners manual describes how to use all of the typewriter's features and controls, how to replace accessories and many other important things. Please read this manual completely before operating your new electronic typewriter.

Sears typewriter stands are designed to give you comfort by providing the proper height for the typewriter when typing.

A Sears typewriter stand also provides you with a convenient storage location for your typewriter when it is not being used.

TABLE OF CONTENTS

PART NAMES AND FUNCTIONS	1
BASIC OPERATIONS	4
1. SELF DEMONSTRATION	4
2. HOW TO START TYPING	4
3. HOW TO CHANGE RIBBON CASSETTE	7
4. HOW TO CHANGE CORRECTION TAPE	8
5. HOW TO CHANGE PRINTWHEEL	9
6. TYPEWRITER MODES	10
7. MARGINS	11
8. TABS	12
9. CORRECTIONS ON PAPER	13
10. CORRECTIONS ON LCD (DISPLAY)	15
11. AUTOMATIC WORD CORRECTION	17
SPELL CORRECTOR FUNCTION	19
TYPEWRITER FUNCTION	24
1. DECIMAL TABULATION	24
2. AUTOMATIC CENTERING	25
3. AUTOMATIC PARAGRAPH INDENTATION	26
4. BOLD TYPING	26
5. AUTOMATIC UNDERLINING	27
6. AUTOMATIC CARRIER RETURN	28
7. REQUIRED HYPHEN AND REQUIRED SPACE	28
8. SECOND KEYBOARD (SPECIAL CHARACTER SET)	29
9. CAPS LOCK	29
MEMORY FUNCTION	30
1. FILE STORING	30
2. STOP CODE	34
3. FILE EDITING	36
4. FILE RECALL (PRINTOUT ON PAPER)	39
5. FILE LISTING	41
6. AVAILABLE MEMORY CAPACITY	41
7. FILE DELETING	42
8. MEMORY ALL CLEAR	42
9. BLOCK OPERATIONS (COPY/MOVE/DELETE)	43
SUPPLIES	46
AFTER USING THE TYPEWRITER AND TO STORE	47
MAINTENANCE AND SERVICE	47

PART NAMES AND FUNCTIONS

1. Operating Parts

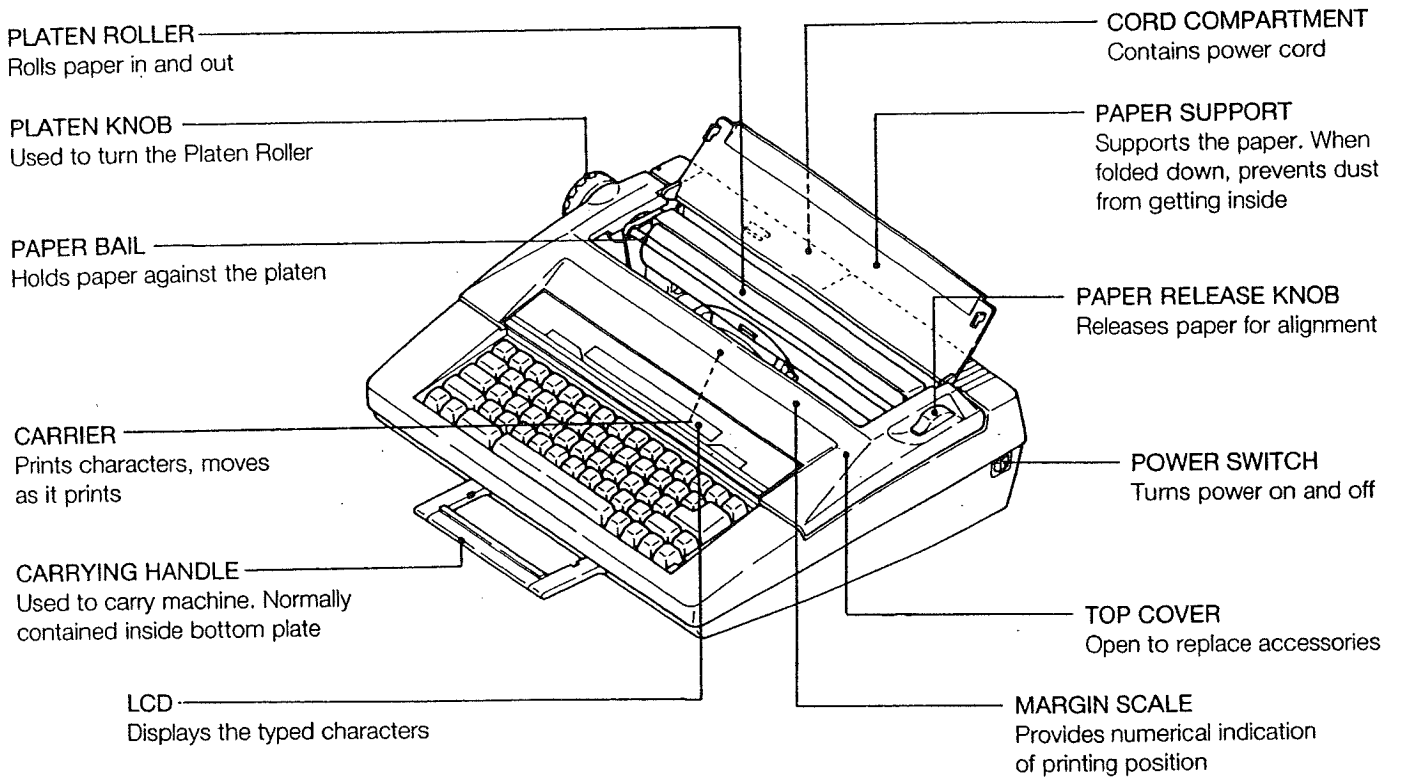

2. Carrier Mechanism (under the Top Cover)

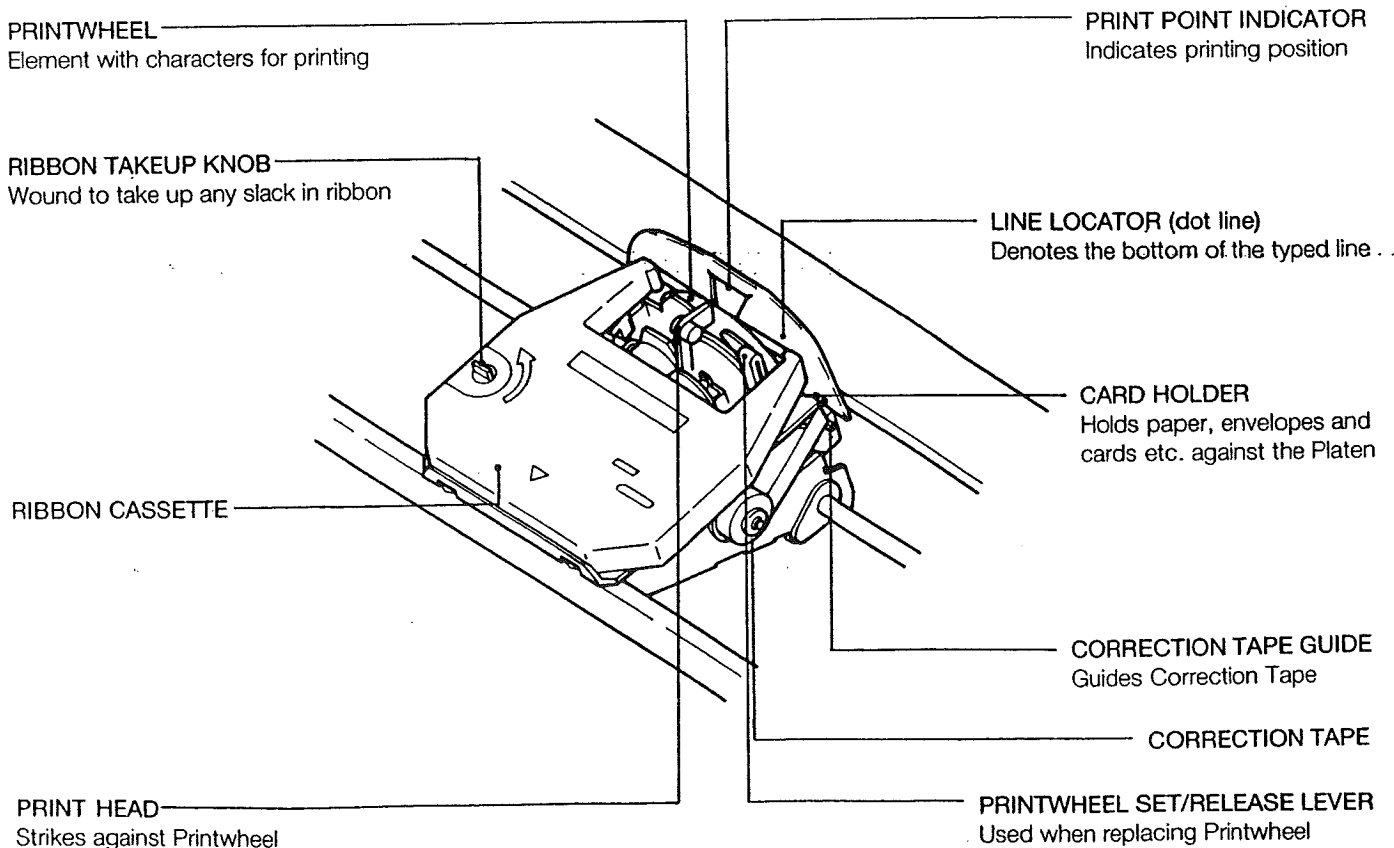

3. Keyboard Layout

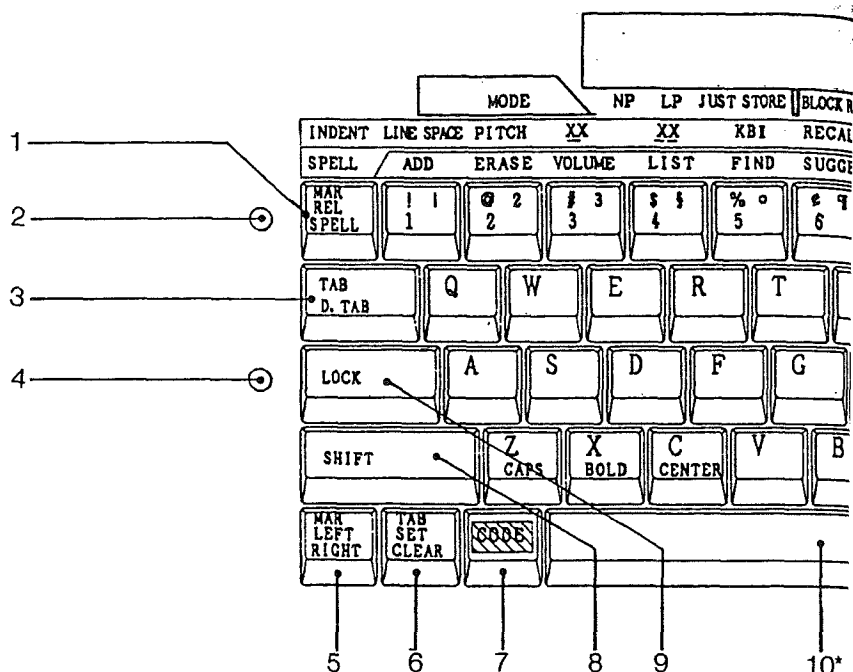

4. Key Functions

<p>1 MARGIN RELEASE KEY Releases the margins to type beyond them or set new ones.</p>
<p>2 POWER-ON LAMP (GREEN) Lights up when the machine is turned on.</p>
<p>3 TAB KEY Moves the Carrier to the next tab.</p>
<p>4 SHIFT LAMP (RED) Lights up when the Shift Key is pressed or locked.</p>
<p>5 LEFT/RIGHT MARGIN SET KEY Sets the left/right margin.</p>
<p>6 TAB SET/CLEAR KEY Sets or clears tabs.</p>
<p>7 CODE KEY Hold down the Code Key to activate special functions (Auto center, File recall, etc.) in conjunction with several other keys.</p>

<p>8 SHIFT KEY Enables typing of capital letters or a character on the upper half of a key when held down. When it's pressed, the Shift Lamp (red) on the Keyboard lights up.</p>
<p>9 SHIFT LOCK KEY Locks the Shift Key in position to type a series of capital letters when pressed. When it's locked, the Shift Lamp (red) lights up. Release by touching either Shift Key.</p>
<p>10 SPACE BAR A light touch moves the Carrier ahead one space. For repeat spacing, hold it down.</p>
<p>11 CORRECTION KEY Corrects characters. Hold down for repeat correction.</p>
<p>12 RELOCATION KEY After backspacing to correct or underline text, etc., press the Relocation Key to return the Carrier one space after the last character typed. On the LCD, the cursor returns to its former position.</p>

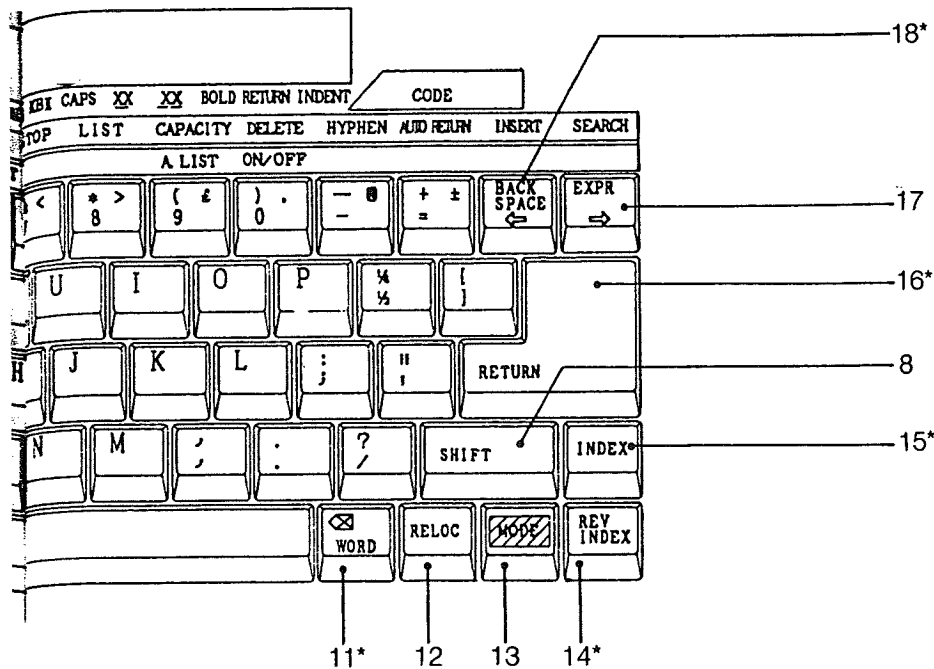

* Hold down these keys for repeat action.
 The following characters x, X, -, __, =, ., *, are also repeated by holding down the respective keys.

13 MODE KEY

Changes the typewriter mode.

14 REVERSE INDEX KEY

Pressed to retract paper without moving the Carrier. Paper will retract a half-line (1/12") every time the key is pressed. By holding down the key, paper will retract continuously. Also clears the correction memory.

15 INDEX KEY

Pressed to advance paper without moving the Carrier. Paper will advance a half-line (1/12") every time the key is pressed. By holding down the key, paper will advance continuously. Also clears the correction memory.

16 RETURN KEY

Pressed to advance paper one line and return the Carrier to the left margin. For repeat line spacing, hold it down. Also clears the correction memory.

17 EXPRESS KEY

Press to return the Carrier to the left margin without line spacing (LCD must be cleared), or move the cursor one space to the right on the LCD. Hold down the key for repeat spacing (on the LCD only).

18 BACKSPACE KEY

A light touch moves the Carrier backward one space, or moves the cursor one space to the left on the LCD. For repeat action, hold it down.

BASIC OPERATIONS

1. SELF DEMONSTRATION

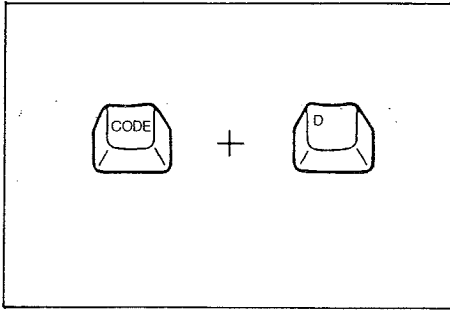

Hold down the Code Key and press the "D" Key. The typewriter will automatically perform a printout of features.

When you activate this function, the correction memory is cleared.

To cancel the printout at any time, simply touch the Space Bar.

2. HOW TO START TYPING

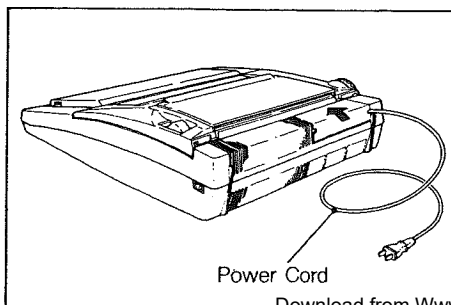
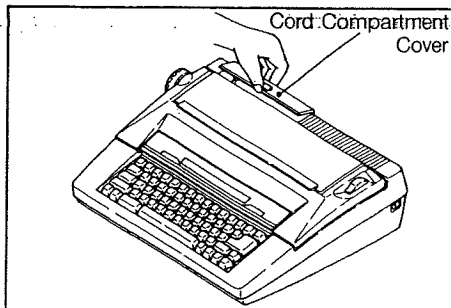
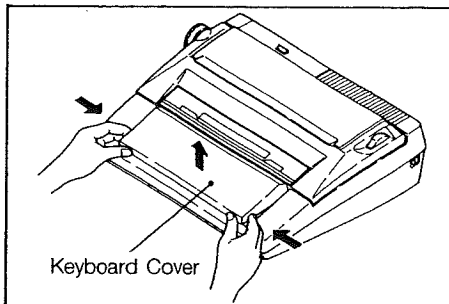

1. Set Up Typewriter

1) Place the typewriter on a desk or other flat surface. Lift up the Keyboard Cover and remove it.

2) Press the mark on the Cord Compartment Cover on the rear of the typewriter, open the cover and take out the power cord.

3) Fit the power cord through the slot on the Cord Compartment and close the cover. Plug the cord into an outlet of the proper voltage (110-120V AC 60Hz).

2. Turn On Typewriter

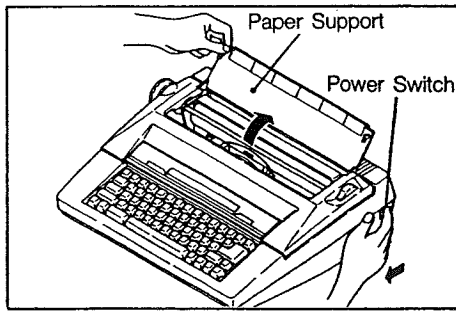

Raise the Paper Support and turn on the Power Switch located on the right side of the typewriter. The following initial operations occur:

1. A beep sounds and the Power-on Lamp (green) on the keyboard lights up.
2. The Carrier moves to the extreme left side and then moves to the left margin. The Printwheel rotates and stops at the programmed position.

While the above operations are occurring, all other typewriter functions stop. Start the next operation only after the initial operations are completed.

- Make sure the Printwheel, Ribbon Cassette and Correction Tape are properly installed and that there is a sufficient quantity of ribbon and correction tape remaining.

3. Insert Paper

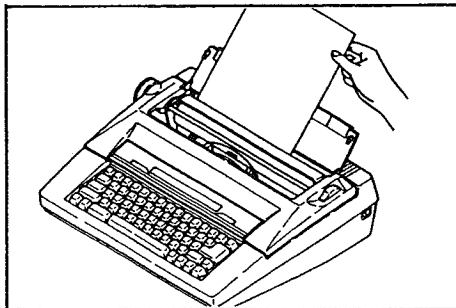

- 1) Insert paper between the Paper Support and Platen Roller.

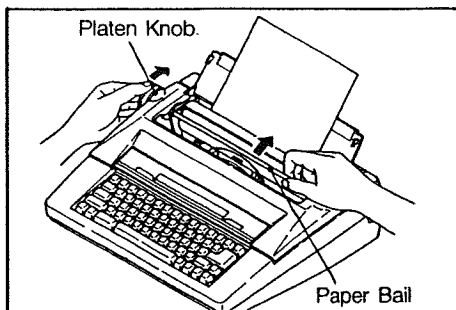

- 2) Turn the Platen Knob on the left of the typewriter to advance the paper. When the top of the paper comes into sight, pull the Paper Bail upward by hand to open it and continue turning the Platen Knob to feed paper in between the Paper Bail and Platen Roller.

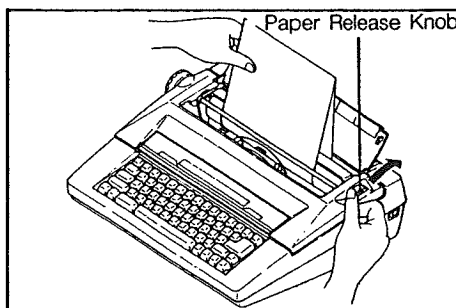

- 3) The paper is released when the Paper Release Knob is turned backward, enabling you to freely move the paper by hand for alignment purposes.
- Close the Paper Bail and return the Paper Release Knob to its forward position before typing.

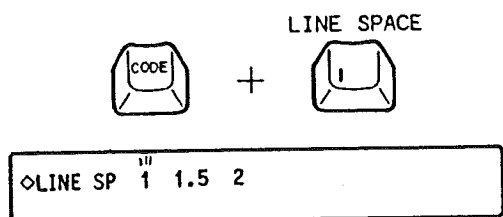

4. Set Typing Controls

- 1) Line Spacing
Hold down the Code Key and press the "1" Key. "◇ LINE SP 1 1.5 2" appears on the LCD. The line space in use will blink.

To change the line spacing, hold down the Code Key and press the "1" Key again. The line spacing changes each time the "1" Key is pressed, and the respective setting blinks.

Releasing the Code Key sets the line spacing and automatically terminates the selection mode.

Setting 2 provides double spacing (3 lines per inch).
Setting 1-1/2 provides one-and-a-half spacing (4 lines per inch).

Setting 1 provides single spacing (6 lines per inch).

- Line space selection can be performed in the NP mode, and in the LP or JUST modes when there are no characters on the LCD.

- Your typewriter has a memory back-up battery which protects the line space/print pitch settings for a minimum of five years, even when the power switch is turned off.
- When power is turned on, six beeps sound if the back-up battery has been completely drained. The line space/print pitch settings are cleared. Please contact your nearest Sears Service Center in this case.

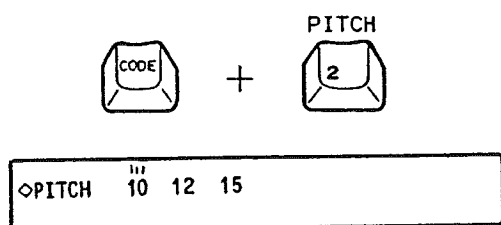

- 2) Print Pitch
The print pitch should be set to match the Printwheel being used. Typing can be done with different pitches on the same line.

Hold down the Code Key and press the "2" Key. "◇ PITCH 10 12 15" appears on the LCD and the pitch in use will blink.

To change the print pitch, hold down the Code Key and press the "2" Key again. The print pitch changes each time the "2" Key is pressed and the respective setting blinks.

Releasing the Code Key sets the print pitch and automatically terminates the selection mode.

- 10: PICA pitch — 10 characters per inch
- 12: ELITE pitch — 12 characters per inch
- 15: MICRO pitch — 15 characters per inch

- Print pitch selection can be performed in the NP mode, and in the LP or JUST modes when there are no characters on the LCD.

3. HOW TO CHANGE RIBBON CASSETTE

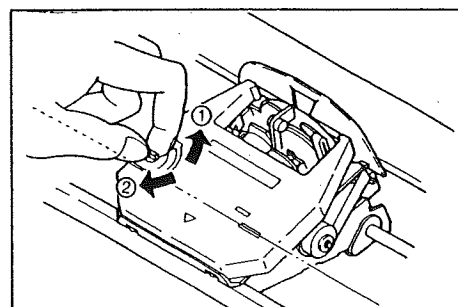
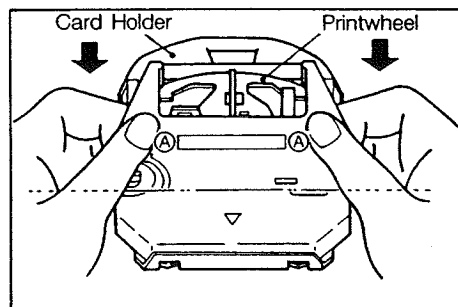
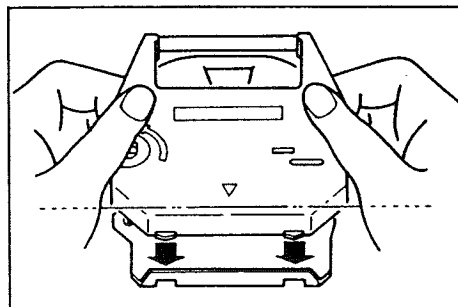
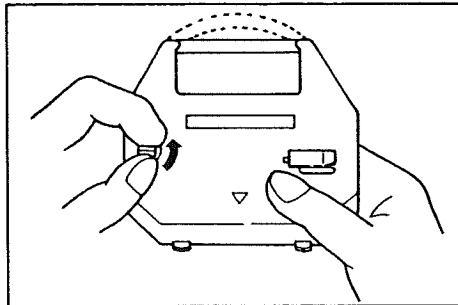
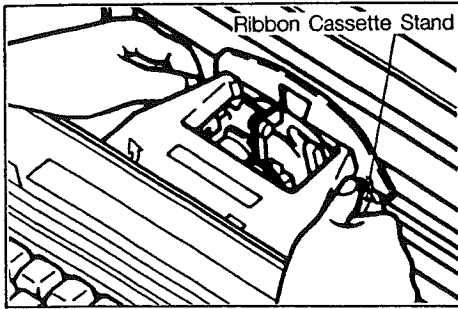

1. Removing Ribbon Cassette

- 1) Turn off the machine and open the Top Cover.
 - 2) Hold down the Ribbon Cassette Stand with your thumbs and gently remove the Cassette by pulling upward on the Cassette Arms as shown.
- Look through the window in the Cassette to check on how much ribbon remains. If you see colored tape in the window, replace the Ribbon Cassette with a new one.

2. Installing Ribbon Cassette

- 1) Before installing a new Ribbon Cassette, always take up any slack in the ribbon by winding the Ribbon Takeup Knob counterclockwise, and remove tab on Cassette Ribbon.
 - When installing a new ribbon, wind past the colored portion at the beginning.
- 2) Fit the two projections at the back of the Ribbon Cassette into the two slots in the Ribbon Cassette Stand.
-
- 3) Carefully lower the front of the cassette so that the ribbon fits between the Card Holder and Printwheel. Press the portions marked "A" in the illustration until the Ribbon Cassette snaps into place.
-
- 4) Turn the Ribbon Takeup Knob counterclockwise until it locks into place ①. Then, turn it clockwise until it stops ②.
- 5) Close the Top Cover.

4. HOW TO CHANGE CORRECTION TAPE

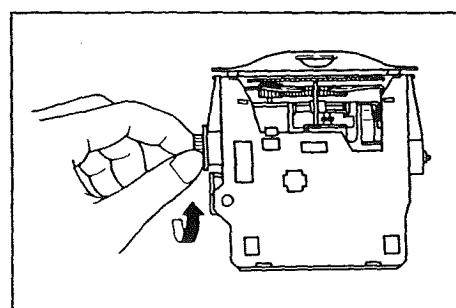
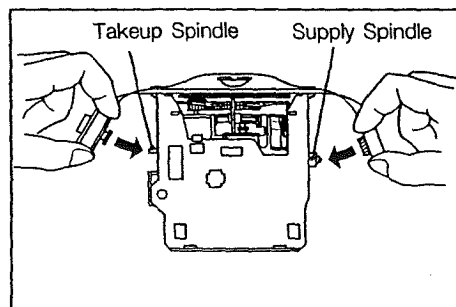
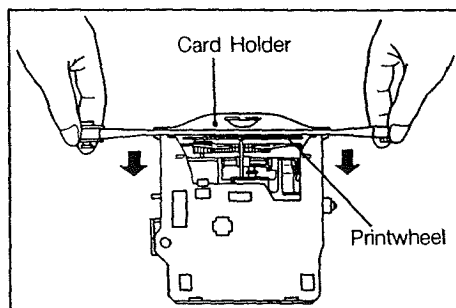
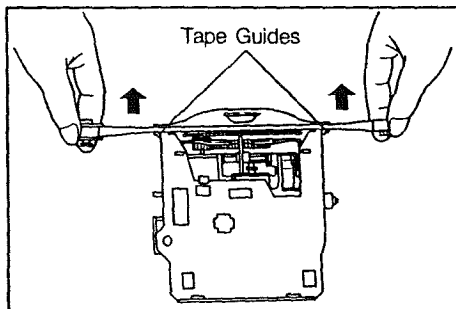
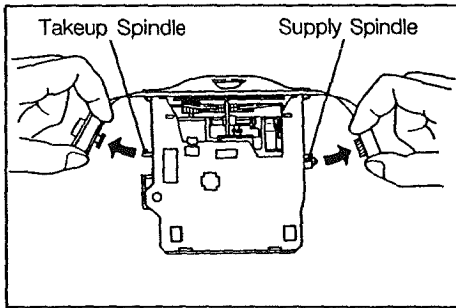

1. Removing Correction Tape

- 1) Turn off the machine. Open the Top Cover and remove the Ribbon Cassette as explained under "Removing Ribbon Cassette".
- 2) Remove the left and right spools from the respective spindles. Be sure not to pull on the spindle hub when removing the right spool.
- 3) Grasp both spools and bring back to a position that is parallel with the Tape Guides. Pull on the Correction Tape to take up any slack and lift it out of the typewriter.

2. Installing Correction Tape

- 1) While holding the two spools in your hands, unwind the Correction Tape and position behind the Tape Guides and Printwheel as shown. Make sure that the sticky side of the tape faces the Card Holder.
- 2) Fit the full spool of the Correction Tape onto the Right (Supply) Spindle. Then fit the left spool (the one with the knob) onto the Left (Takeup) Spindle.
- 3) Turn the left spool counterclockwise until the colored portion of the tape disappears.
- Check again to make sure that the Correction Tape has been fed properly behind the left and right Tape Guides.
- 4) Replace the Ribbon Cassette and close the Top Cover.

5. HOW TO CHANGE PRINTWHEEL

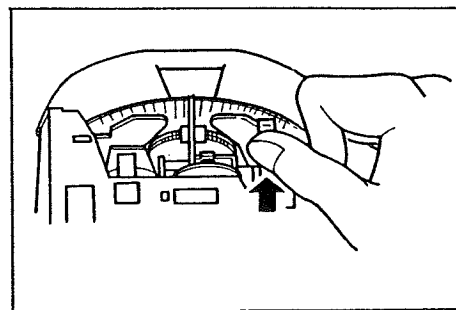
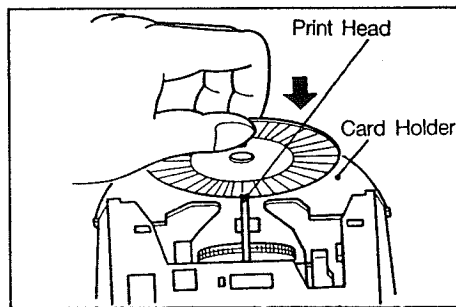
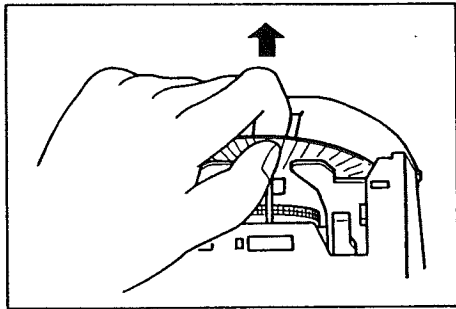
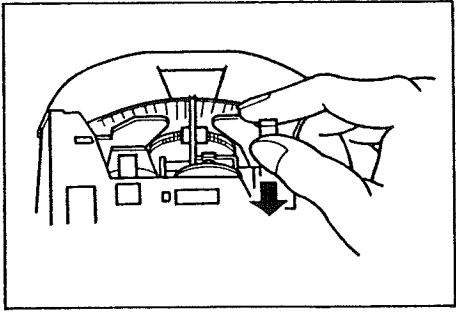

1. Removing Printwheel

- 1) Turn off the machine. Open the Top Cover and remove the Ribbon Cassette as explained under "Removing Ribbon Cassette".
- 2) Pull the Printwheel Set/Release Lever towards you.
- 3) Lightly grasp the top of the Printwheel and carefully pull it up towards you.

2. Installing Printwheel

- 1) Lightly grasp the edge of the Printwheel and carefully lower it in between the Card Holder and the Print Head.
 - Make sure that the typeface (the side with typing style indicated) faces the Platen.
- 2) Press the Printwheel Set/Release Lever away from you until it snaps into place, locking the Mechanism.
 - Press the Lever as far as it goes again to make sure the Printwheel has been locked into place.
- 3) Replace the Ribbon Cassette and close the Top Cover.
 - Remount the Printwheel if any abnormal noise is heard or if incorrect characters are printed.

6. TYPEWRITER MODES

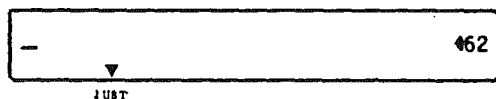
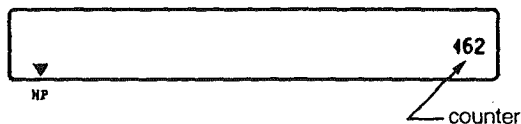

Sample Printout

Left Margin



Your typewriter has four different modes: Normal Print (NP), Line Print (LP), Justified Print (JUST) and Store (STORE).

Your typewriter has four different modes: Normal Print (NP), Line Print (LP), Justified Print (JUST) and Store (STORE).

Right Margin



<printout in NP/LP mode>

<printout in JUST mode>

Your typewriter has four different modes. Normal Print (NP), Line Print (LP), Justified Print (JUST) and Store (STORE). The mode in use is indicated on the LCD by a "▼", and it's changed each time the Mode Key is pressed.

- 1) Normal Print Mode (NP)
When power is first turned on, the typewriter is in the Normal Print (NP) mode. In this mode, characters are immediately typed on the paper without appearing on the display (LCD).

- Counter
The counter at the right side of the LCD indicates the remaining number of spaces to the right margin. If you type beyond the right margin, the number increases one by one.

- 2) Line Print Mode (LP)
This mode allows you to print one line at a time. Characters appear on the display as you type them, enabling you to correct any typed entry on the LCD. Characters are printed when you press the Tab or Return Key. You can type in new text while the previous line is being printed.

- 3) Justified Print Mode (JUST)
This mode allows you to align both margins, i.e., evenly position the words between the left and right margins.

Characters appear on the display as you type them, enabling you to correct any typed entry on the LCD. When you type a character of any word exceeding the right margin (indicated by the counter on the LCD), words preceding the right margin are automatically printed out, justified between the left and right margins, and the carrier returns to the left margin. The word whose characters exceeded the right margin will remain on the LCD to start the next line (word-wrap). You can type new text while the previous line is being printed.

If you press the Return or Tab Key while typing in a line, text will be printed out immediately and will not be justified.

- 4) Store Mode (STORE)
This mode allows you to store text into the typewriter's memory. For an explanation of details, refer to "Memory Function".



7. MARGINS

The following auto margins are permanently stored in this typewriter.

	Left Margin	Right Margin
PICA typing (10 pitch)	10	75
ELITE typing (12 pitch)	12	90
MICRO typing (15 pitch)	15	113

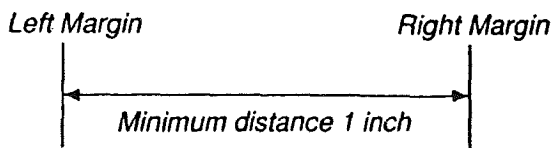
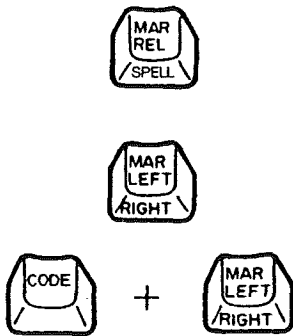

1. Auto Margins (Standard Pre-set Margins)

When the power is first turned on, the Print Point Indicator moves to the left auto margin. A beep sounds when the 6th character or space is printed before the right margin, informing you that the Print Point Indicator is nearing the right margin. Printing stops after 5 more characters (or spaces) are typed, and a beep signals that the Print Point Indicator is at the right margin.

2. Setting New Margins

Move the Print Point Indicator to the position where you want to set a new margin by using the Space Bar and/or Backspace Key.

- To set a new margin beyond either of the present margins, press and release the Margin Release Key while the Print Point Indicator is at that margin, then move the Print Point Indicator to the desired position.
 - 1) Left Margin
Press the Margin Set Key to set the new left margin.
 - 2) Right Margin
Hold down the Code Key and press the Margin Set Key to set the new right margin.
- A beep sounds, signaling that a new margin has been set. When you set a new left or right margin, the respective auto margins are automatically cleared.
- The LCD must be clear to set new margins, and the Auto center and Decimal tab functions must not be in active use.
- The left and right margins must be at least one inch apart.

3. Typing Beyond Margins

- 1) Typing beyond right margin:
Press and release the Margin Release Key when the Print Point Indicator stops at the right margin and continue typing.
- 2) Typing beyond left margin:
Press and release the Margin Release Key at the left margin, and press the Backspace Key to move the Print Point Indicator to the position where you want to start typing.

- Your typewriter has a memory back-up battery which protects the margin/tab settings for a minimum of five years, even when the power switch is turned off.
- When power is turned on, six beeps sound if the back-up battery has been completely drained. The margin/tab settings are cleared. Please contact your nearest Sears Service Center in this case.

8. TABS

Setting tabs makes aligning columns of figures or tables of data easy.

1. Setting Tabs

- 1) Move the Print Point Indicator to the position where you want a tab by using the Space Bar or Backspace Key.
 - 2) Press the Tab Set/Clear Key. A beep will confirm that a tab has been set. A maximum of 16 tab stops can be set.
- The LCD must be clear to set tabs, and the Auto center and Decimal tab functions must not be in active use.



2. Clearing Tabs

- 1) Move the Print Point Indicator to the tab you want to clear.
 - 2) Hold down the Code Key and press the Tab Set/Clear Key to clear the tab. A beep will confirm that the tab has been cleared.
- If you want to clear all tabs, hold down the Code Key and press the Tab Set/Clear Key with a little pressure. Two beeps will confirm that all tabs have been cleared. The print carrier can be at any position when all tabs are cleared.



3. Using Tabs

Press the Tab Key to advance the Print Point Indicator to the next tab on the right.

- If any text remains on the LCD, it will be printed before the carrier advances to the next tab.

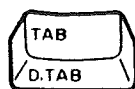

9. CORRECTIONS ON PAPER

Your new typewriter has a one line automatic correction memory. The machine remembers all characters typed in the last full line and will correct any or all of those characters. Characters beyond the correction memory can also be corrected easily with a few extra steps.

- The correction memory is automatically cleared when the Return, Index or Reverse Index Key is pressed.
- The correction memory is also cleared if the power is turned off.

1. Correcting the Last Character(s) Typed

- 1) Press the Correction Key. The Print Point Indicator will backspace and erase the incorrect character(s).
- If you hold down the Correction Key, the machine will continue erasing characters in the last full line until the Correction Key is released.
- 2) Type the correct character(s).

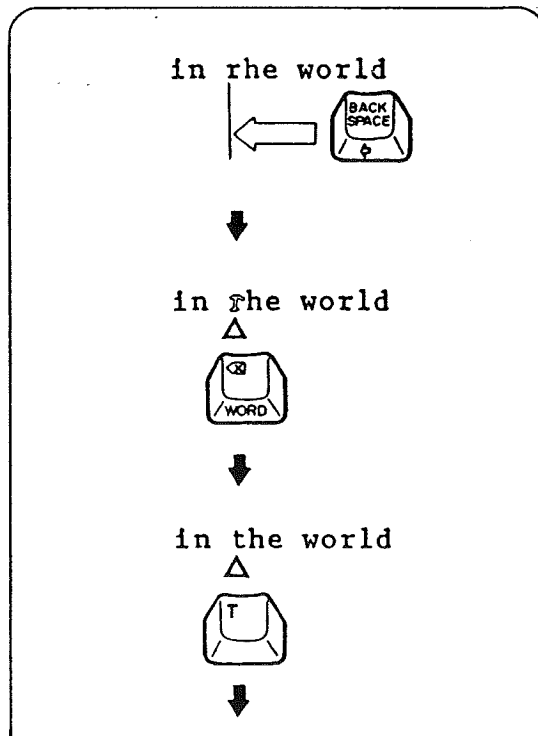
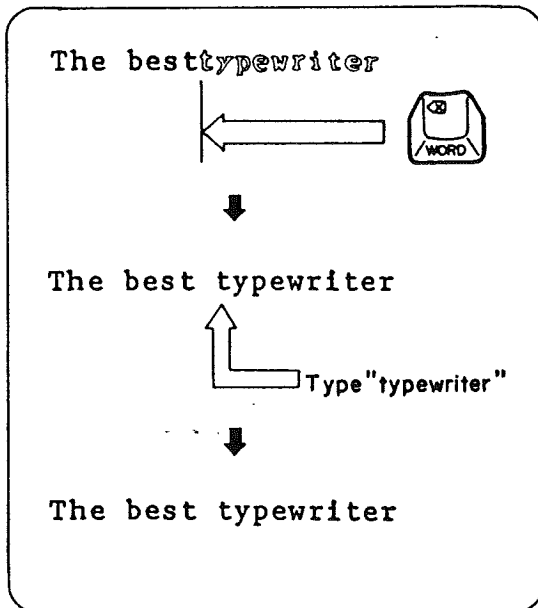

2. Correcting Previous Character(s) Within the Current Line

- 1) Move the Print Point Indicator to align it with the character(s) to be corrected, using the Backspace Key.
- 2) Press the Correction Key to erase the incorrect character(s).
- Hold down the Correction Key to correct more than one character. Correction will be repeated until the Correction Key is released.
- 3) Type the correct character(s).

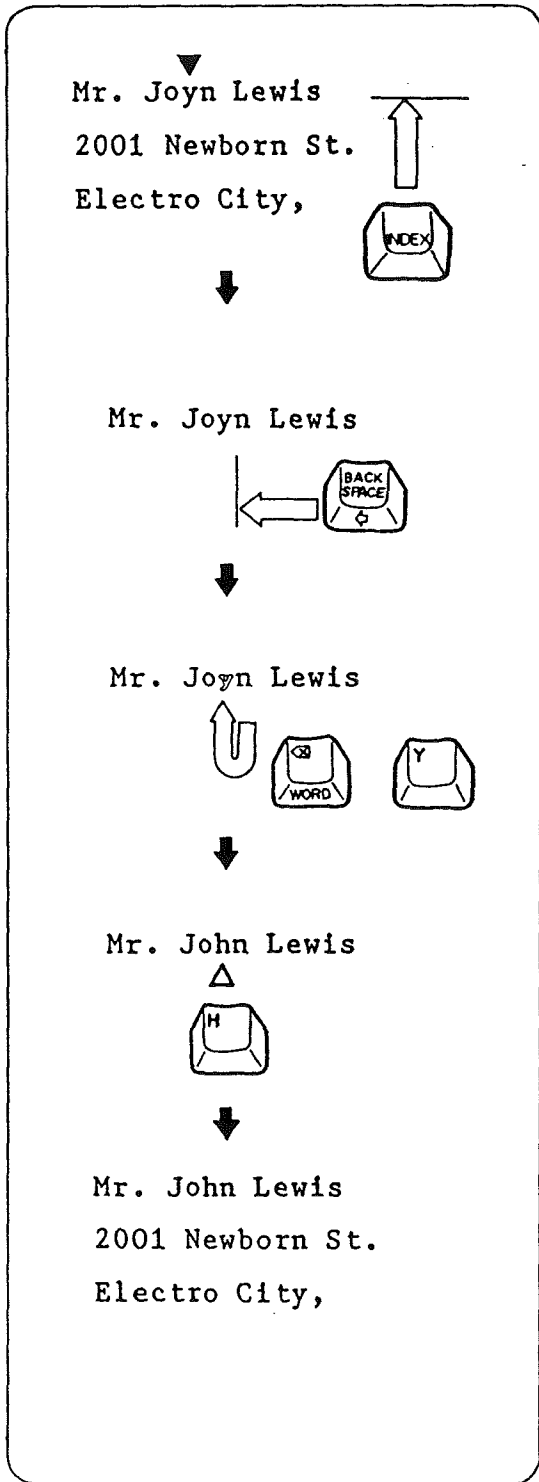
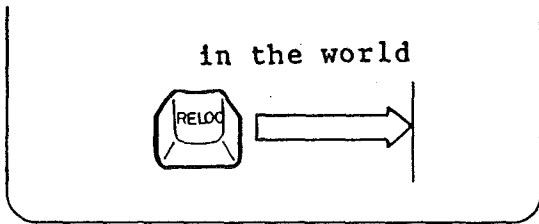

4) Press the Relocation Key to return the Print Point Indicator to its previous position.

3. Correcting Character(s) on Another Line

1) If the correction is on another line, press the Reverse Index Key or Index Key (clears any correction memory) to align the Print Point Indicator with the line where the correction is to be made.

2) Move the Print Point Indicator to the position one space to the right of the character(s) to be corrected, using the Space Bar and/or Backspace Key.

3) Press the Correction Key. The Print Point Indicator will backspace to the incorrect character. Type the incorrect character and it will be erased. The Print Point Indicator does not move.

4) Type the correct character(s).

5) Return the Print Point Indicator to the previous position.

10. CORRECTIONS ON LCD (DISPLAY)



Ex.

to be corrected:

best typewriter 442
LP

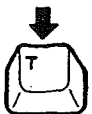

best typewriter 442
LP



best typewriter_ 442
LP

Ex.

to be corrected:

bbest typewriter 442
LP



best typewriter 443
LP



best typewriter_ 443
LP

1. Moving the Cursor

- 1) Press the Backspace Key to move the Cursor one space to the left.
 - 2) Press the Express Key to move the Cursor one space to the right.
- Hold down either key for continuous movement.

2. Replacing

- 1) Bring the cursor under the character you want to correct, using the Backspace and/or Express Key.
- 2) Type the correct character. The character is automatically replaced.
- 3) Press the Relocation Key to return the cursor to its former position.

3. Deleting

- <In text>
- 1) Position the cursor under the character to be deleted, using the Backspace and/or Express Key.
- To delete more than one character, position the cursor under the character at the far left of the series you want to delete.
- 2) Press the Correction Key to delete the character(s). Each time the Correction Key is pressed, the character above the cursor is deleted, and the text is pulled one space to the left.
 - Hold the Correction Key down to quickly delete a number of characters.
 - 3) Press the Relocation Key to return the cursor to the previous position.

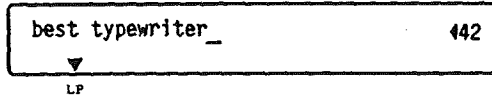
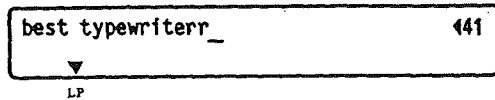

Ex.

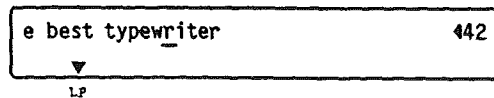
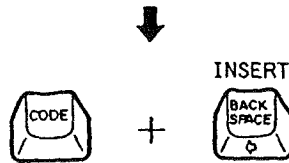
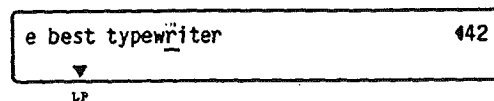
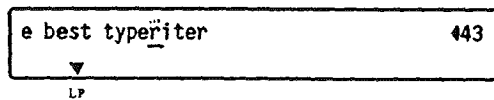
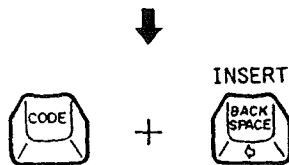
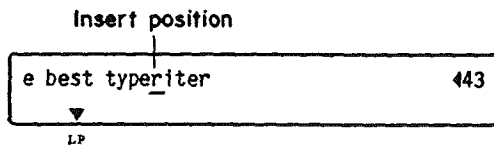

OR

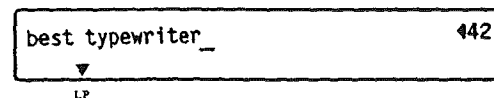

<At the end of text>

When the cursor is at the end of the text, characters are pulled one space to the right as each deletion is made.

- If the beginning of the text appears at the left side of the LCD with the cursor at the end of the text, the cursor will move to the left each time a deletion is made.

4. Inserting

- 1) Use the Backspace and/or Express Key to bring the cursor to the character one space to the right of where you want to insert text.
- 2) Hold down the Code Key and press the Backspace Key. The character above the cursor will alternately flash with a box mark (■).
- 3) Type the desired character(s) and/or space(s). Inserts are effected to the left of the cursor. The cursor moves one space to the right for each character inserted. (When the cursor is at the far-right side of the LCD, text is pushed to the left for each character inserted).
- 4) Hold down the Code Key and press the Backspace Key again. The insert mode is terminated and the cursor does not move.

OR

Press the Relocation Key. The Insert mode is terminated and the cursor returns to the end of the text.

11. AUTOMATIC WORD CORRECTION

This function allows you to correct the last or previously typed word(s) only on the current line with one operation.

1. Deleting the Last Word Typed on Paper

- 1) Hold down the Code Key and press the Correction Key. An intermittent beep will sound. Press the Space Bar. The typewriter will delete the word, starting from the last character.

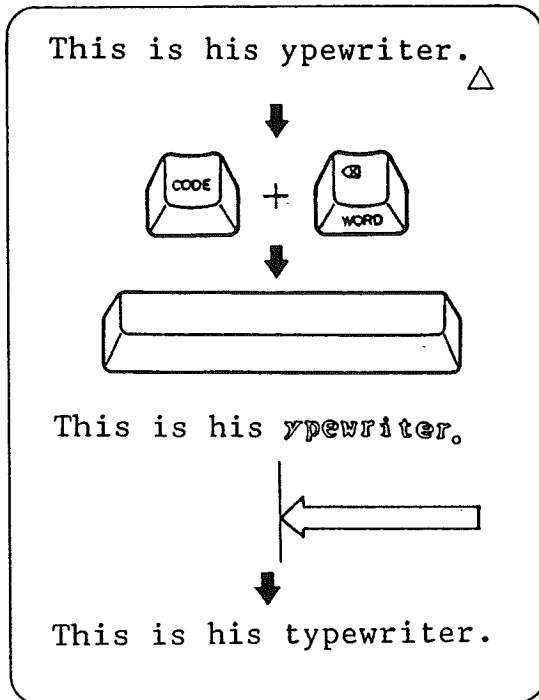

- 2) Type the correct word(s).

- To cancel this function before the word is deleted, hold down the Code Key and press the Correction Key again. Two beeps signal that the function has been canceled.

2. Deleting a Previous Word on the Current Line

- 1) While holding down the Code Key, press the Correction Key and then the last character of the word to be corrected. The Carrier moves to the position of that character and an intermittent beep will sound.

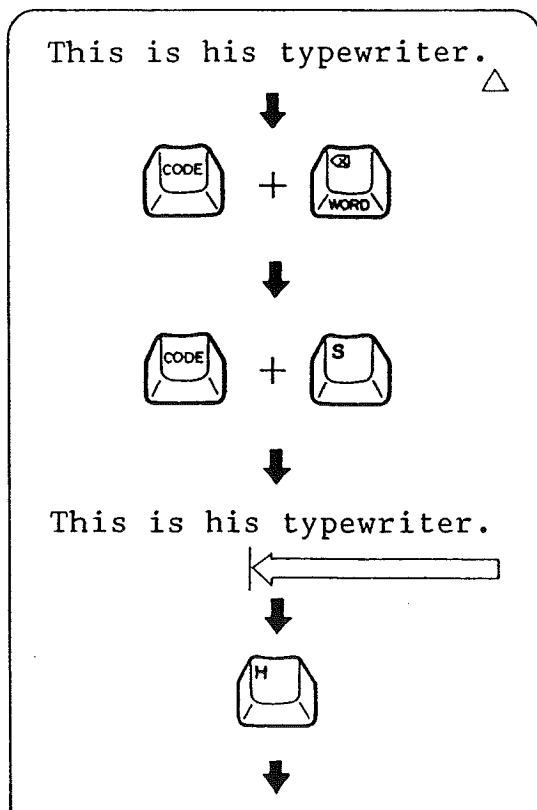

- 2) Press the first character of the word to be corrected. The typewriter will delete the word, starting from the last character.

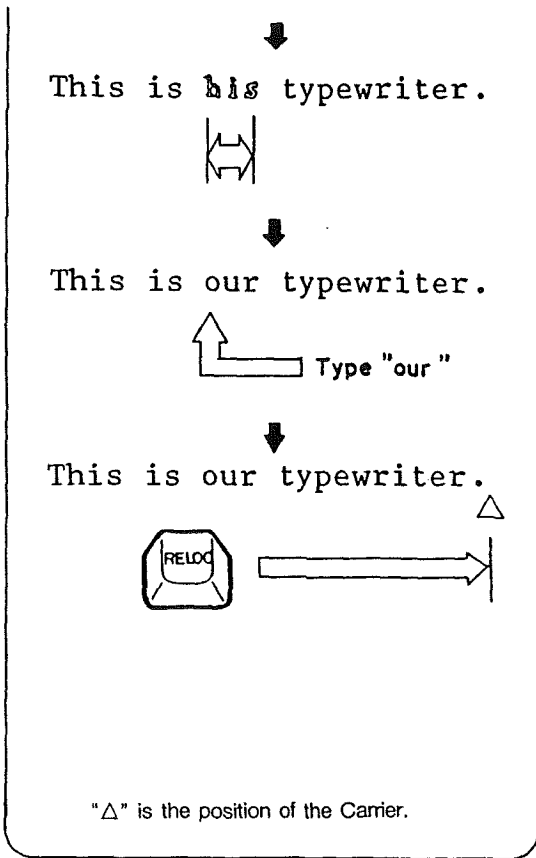

- 3) Type the correct word.
- To cancel this function before the word is deleted, hold down the Code Key and press the Correction Key again. Two beeps signal that the function has been canceled.
- 4) Press the Relocation Key to return the Carrier to its previous position.

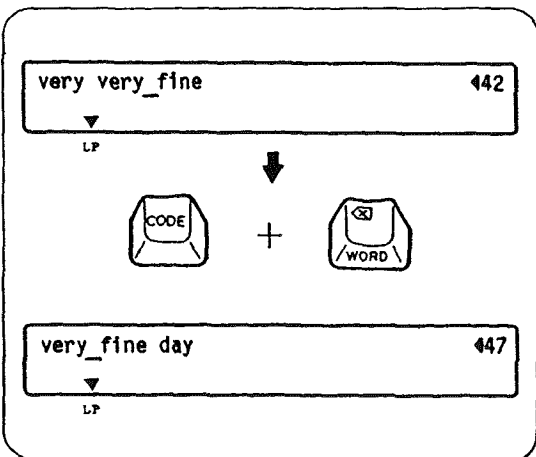

3. Deleting a Word on the LCD

- 1) Position the cursor under the space following the word you wish to delete.
- 2) Hold down the Code Key and press the Correction Key. The word is deleted and text is pulled to the left.
- Type any desired text after activating the insert mode.

SPELL CORRECTOR FUNCTION

The Spelling portion of this product is based on Proximity Linguistic Technology.

THE PROXIMITY/MERRIAM-WEBSTER LINGUIBASE

Copyright 1984 All Rights Reserved Proximity Technology, Inc.

Copyright 1984 All Rights Reserved Merriam-Webster Inc.

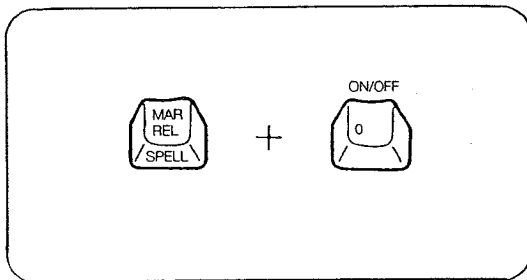

character
 character
 character

Room No. 505
 PICA/ELITE pitch

etc..
 forget-me-not
 The best type-
 writer

"i" signals the end of a word to the typewriter

1. Turning On/Off the Spell Corrector

- 1) Hold down the Margin Release (SPELL) Key and press the "0" (ON/OFF) Key. A beep sound indicates that the Spell Corrector is turned on.
- 2) Hold down the Margin Release (SPELL) Key and press the "0" (ON/OFF) Key again to turn off the Spell Corrector.

2. How the Spell Corrector Works

- 1) This typewriter is equipped with a 50,000 word Main Dictionary and when you type any series of characters (word) that is not found in the dictionary, a beep sounds at the end of the word. In addition to this dictionary, there is an approximately 100 word User Dictionary to register frequently used terms and proper nouns.
- 2) The Spell Corrector identifies a group of letters as a completed word when immediately followed by the characters and key functions below. The Spell Corrector therefore starts checking spelling from the first character of the next word.

Numbers: 0 1 2 3 4 5 6 7 8 9

Symbols: ! | @ # \$ % & ' () _ = + - \$ ¶

& < * > () _ = + - \$ ¶

• ½ ¼ [] : ; " ' ? /

Key functions: Space, Tab, Return, Index, Reverse Index

- Two periods or apostrophes in a row signal the end of a word.
- Hyphens that do not fall at the end of a line signal the end of a word.

3. Error Types

The Spell Corrector checks spelling and indicates error in the following manner:

- 1) For words not found in the dictionary, a beep will sound.
 - The names of major cities in the world, abbreviations of the 50 American states, common first and last names and frequently used contractions are also included in the 50,000 word dictionary.

Examples: New York, Tokyo, CA, IL, John, Mary, don't isn't

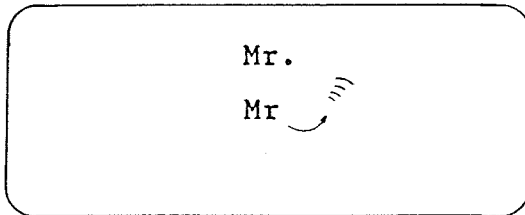
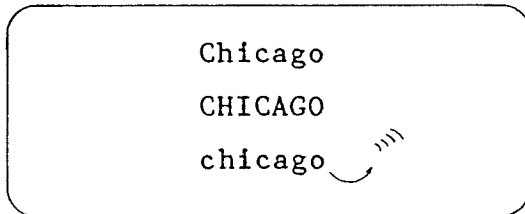

- 2) A beep sounds if the first letter of a proper noun or if all the letters of a proper noun are not capitalized.

Examples: Chicago, San Francisco, Tom

- 3) A period must be typed after all abbreviations. If not, a beep will sound.

Examples: Mr., bldg., etc.

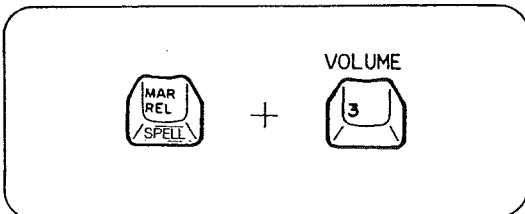

4. Beep Volume Adjustment

Any of 10 volume levels can be set from the Keyboard. When the power is first turned on, the beep volume is set to the fifth level.

Hold down the Margin Release (SPELL) Key and press the "3" (VOLUME) Key. Each time this key is pressed, the volume increases one step. The volume returns to the first level after it reaches the tenth level.

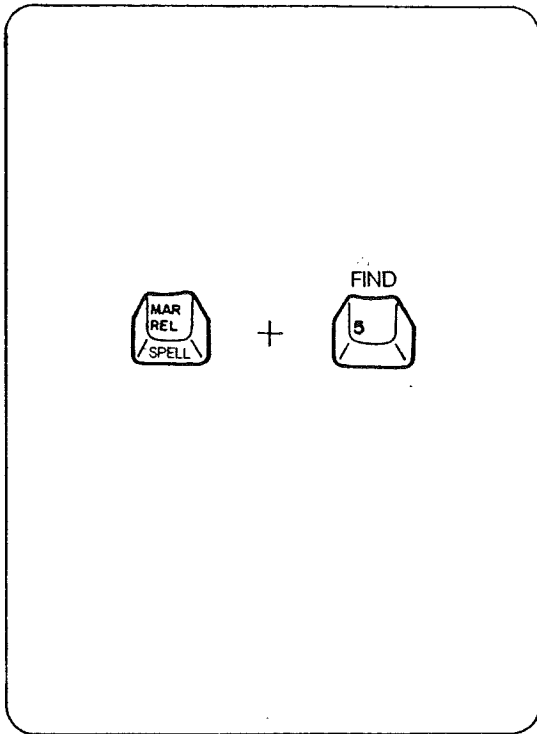

5. Finding Typing Errors on the Current Line

- 1) Hold down the Margin Release (SPELL) Key and press the "5" (FIND) Key. The Carrier will move to the first incorrect word on the current line.
 - 2) Correct the error.
 - 3) To find any other incorrect word, hold down the Margin Release (SPELL) Key and press the "5" (FIND) Key again. The Carrier or cursor moves to the next incorrect word. Then correct the error.
 - 4) Repeat the same procedure to correct all errors on the current line. The Carrier or cursor stops at the end of the line typed, after all errors are corrected.
- The one line memory is cleared by pressing return, center, index, reverse index.
 - This function cannot be used when editing the file.

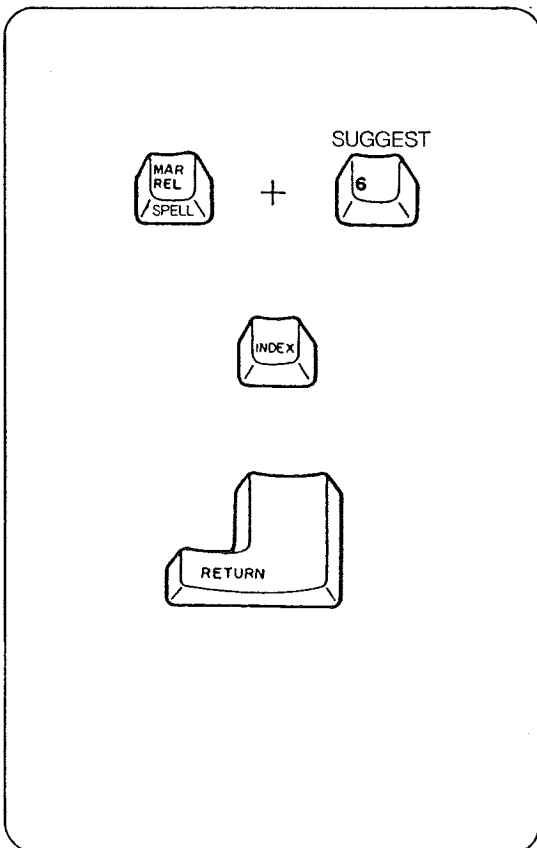

6. Suggestions for Similar Words

- 1) Move the Carrier or cursor to the word in question.
 - 2) Hold down the Margin Release (SPELL) Key and press the "6" (SUGGEST) Key. A similar word to the word in question appears on the LCD.
 - 3) Press the Index Key to display the next similar word, until the desired word appears.
 - 4) When the desired word appears, press the Return Key in order to correct the word.
- If the word in question is on the LCD, it is automatically replaced with the desired word when you press the Return Key.

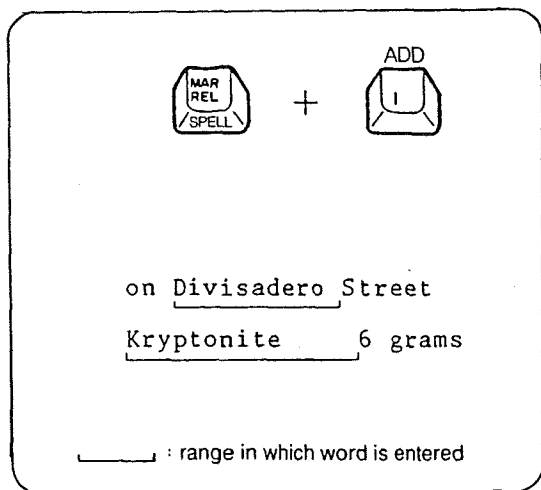

7. Adding Words to the User Dictionary

Names and unusual words not contained in the Main Dictionary can be stored in the User Dictionary.

- 1) Type the word to be stored in the User Dictionary.
 - 2) Hold down the Margin Release (SPELL) Key and press the "1" (ADD) Key. A beep sounds, confirming that the word has been stored. If no beep sounds, it means the word is already registered in the Main or User Dictionary and it will not be stored again.
- Previous words on the same line can be stored by backspacing to any position under the word to be entered.
 - If the User Dictionary is full, the word with the least usage frequency is automatically deleted to make room for new entries. The number of times you type each word in the User Dictionary is counted by the Spell Corrector, enabling it to rearrange them in the order of usage frequency.

8. Erasing Words from the User Dictionary

The words in the User Dictionary can be deleted desired.

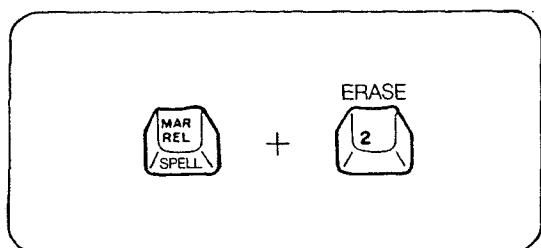

- 1) Type the word to be deleted from the User Dictionary.
 - 2) Hold down the Margin Release (SPELL) Key and press the "2" (ERASE) Key. A beep sounds, confirming that the word has been deleted. If no beep sounds, it means that the word has not been stored in the User Dictionary.
- The Print Point Indicator can be either below the word or one space immediately following the word to be deleted.
 - Previous words on the same line can be deleted by backspacing to any position under the word to be deleted.

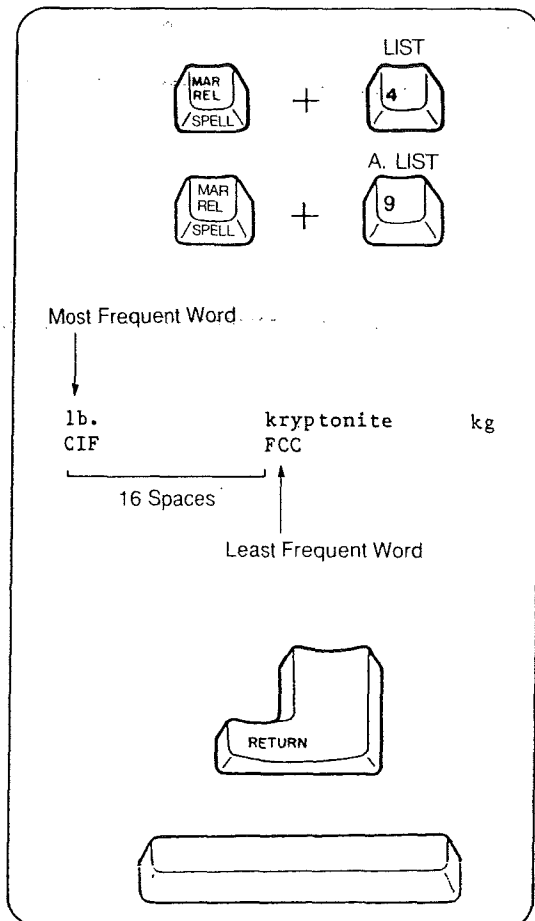

9. List of the User Dictionary

The words in the User Dictionary can be printed out in the order of usage frequency, or alphabetically. (The last word in the list is the first word which will be deleted to make room for new entries when the User Dictionary is full.)

- 1) Hold down the Margin-Release (SPELL) Key and press the "4" (LIST) Key. The words in the User Dictionary are printed in order of usage frequency in a certain format.

- 2) Hold down the Margin Release (SPELL) Key and press the "9" (A.LIST) Key. The words in the User Dictionary are now printed in alphabetical order.

- If the User Dictionary is empty, the expression "NO WORD" is shown in the display.
- The printout can be temporarily stopped by pressing the Return Key. Press the Return Key again to restart printout. Press the Space Bar during printout to cancel the list function.

■ Back-up battery

The Spell Corrector is provided with a back-up battery which protects data in the User Dictionary for a minimum of five years, even when the power switch is turned off. Six beeps sound when power is turned on if the back-up battery has been completely drained, and the contents of the User Dictionary have been erased. Please contact your nearest Sears Service Center in this case.

1. DECIMAL TABULATION

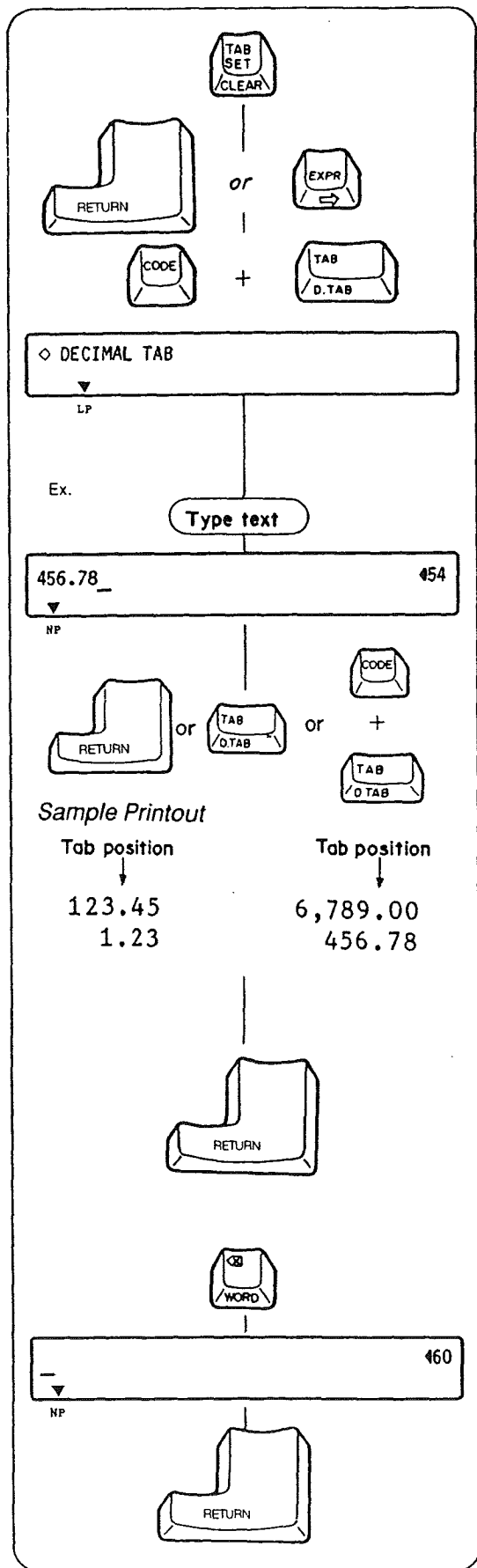

This function allows you to do statistical typing easily. All numbers are automatically aligned by their decimal points.

- 1) Set tab(s) at the decimal positions for each column.
- 2) Press the Return Key or Express Key to return the Carrier to the left margin.
- 3) Hold down the Code Key and press the Tab Key. "◇ DECIMAL TAB" appears on the LCD and the Print Point Indicator will move to the first tab stop.
- If any text remains on the LCD, it will be printed before the Carrier moves to the first tab stop.
- 4) Type the text with or without decimal point. Typed text is displayed on the LCD. Make corrections on the LCD before printout.
- 5) You now have three options to print the text.
 - a) Press the Return Key. Text will be printed and the Carrier stops at that position.
 - b) Press the Tab Key. Text will be printed and the Carrier will advance to the next tab position, making it a standard tab.
 - c) Hold down the Code Key and press the Tab Key. Text will be printed and the Carrier will advance to the next tab, making it a decimal tab again.
- 6) To advance to the next line, press the Return Key and repeat 3) through 5).
- To cancel the Decimal tab mode, first clear the text on the LCD using the Correction Key, and then press the Return Key. The Decimal tab mode will be canceled and the Carrier returns to the left margin on the next line.

2. AUTOMATIC CENTERING

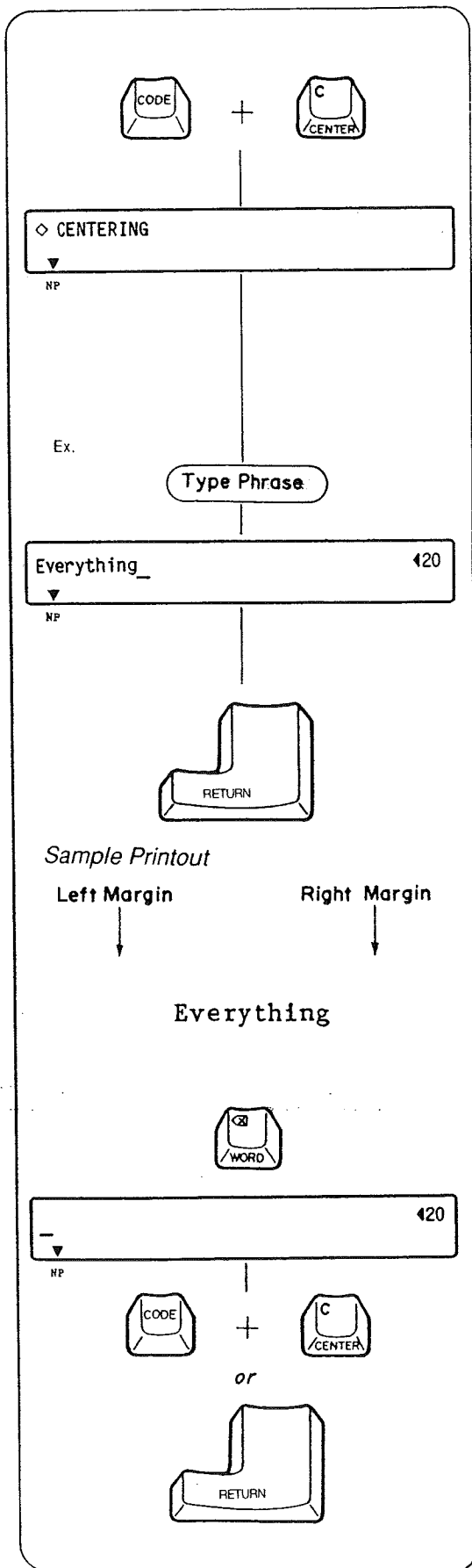

This function allows you to center text evenly between the left (or indent) and right margin.

- 1) Hold down the Code Key and press the "C" Key.
- 2) "◇ CENTERING" appears on the LCD and the Print Point Indicator automatically advances to the center of the margin setting.
 - If any text remains on the LCD, it will be printed before the Carrier advances to the center of the margin setting.
- 3) Type the phrase to be centered. Typed text is displayed on the LCD. Make corrections on the LCD before printout.
 - If more characters are typed than will fit between the left and right margins (the counter indicates "0"), a beep will sound. Press the Margin Release Key to continue typing.
- 4) Press the Return Key. The text is printed, centered between the left (or indent) and right margins, and the Automatic centering function is cleared. The Print Point Indicator remains positioned one space to the right of the centered text.
 - To cancel the Automatic centering function without printing, first clear the text on the LCD using the Correction Key, then hold down the Code Key and press the "C" Key.
 - or
 - Press the Return Key after clearing the text on the LCD. The Carrier returns to the left margin (or indent) on the next line.
 - This function can be used together with Bold typing and Automatic underlining functions.

3. AUTOMATIC PARAGRAPH INDENTATION

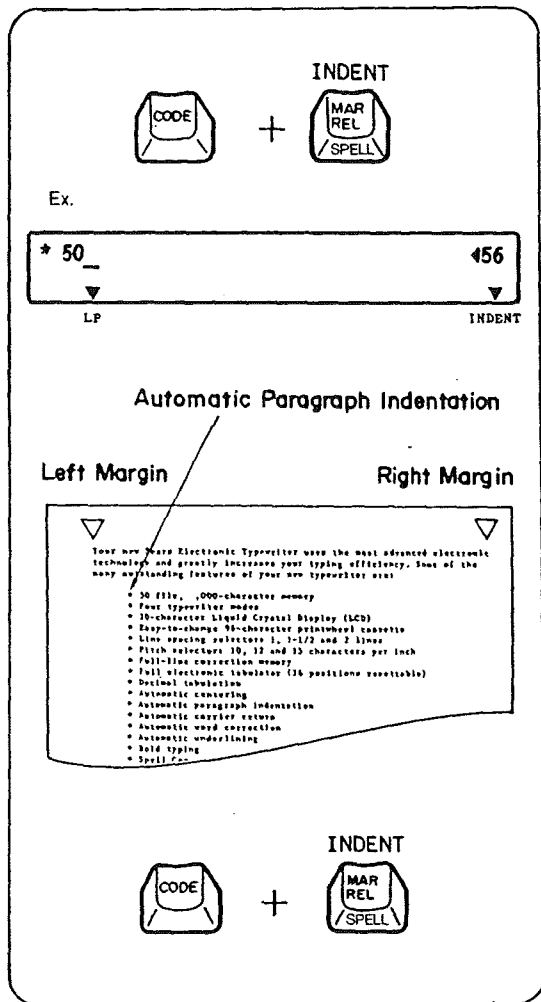

This function sets a temporary left margin, which eliminates the need for constant tabbing or spacing after each carrier return.

- 1) Move the Print Point Indicator to the position where the paragraph is to be indented.
- 2) Hold down the Code Key and press the Margin Release Key. A "▼" appears above "INDENT" on the LCD. The present position will be set as the temporary left margin until the function is canceled.
- 3) Type in the text to be indented.
- 4) To cancel Paragraph Indentation, hold down the Code Key and press the Margin Release Key again. The "▼" above "INDENT" on the LCD disappears.

4. BOLD TYPING

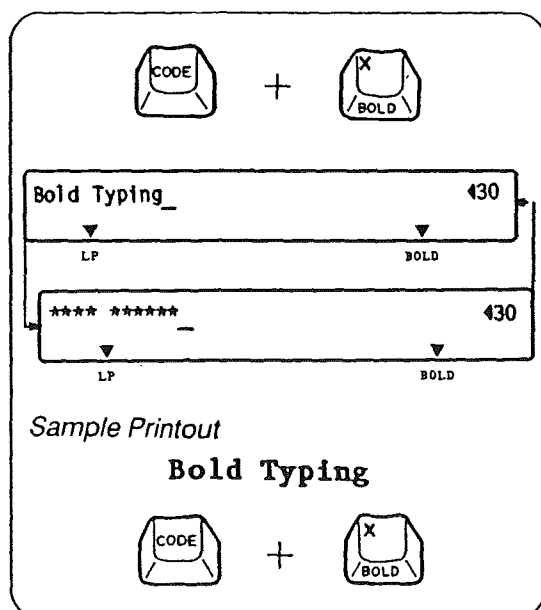

This function makes words stand out from the rest of the text. It's useful for emphasizing titles, critical information, etc.

- 1) Hold down the Code Key and press the "X" Key. A "▼" appears above "BOLD" on the LCD.
- 2) Type in the text.
- 3) To cancel Bold typing, hold down the Code Key and press the "X" Key again. The "▼" above "BOLD" on the LCD disappears.
- 4) This function can be used together with the Automatic centering and Automatic underlining functions.

5. AUTOMATIC UNDERLINING

This function underlines all text (including spaces) or individual words (all text except spaces) as you type.

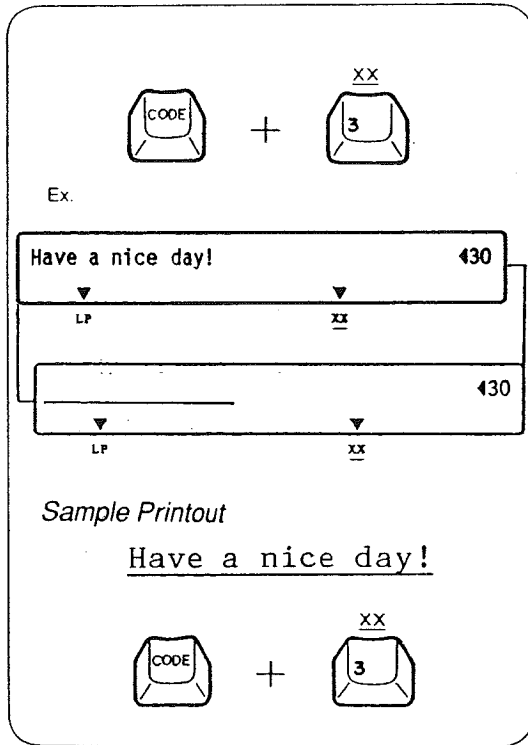

1. Automatic Full Underlining

- 1) Hold down the Code Key and press the "3" (XX) Key. A "▼" appears above "XX" on the LCD.
- 2) Type in the text to be underlined.
- Underlined text is distinguished on the LCD by the "▼" mark and characters which flash alternately.
- 3) To cancel the full underlining, hold down the Code Key and press the "3" (XX) Key again. The "▼" above "XX" on the LCD disappears.
- 4) This function can be used together with the Automatic centering and Bold typing functions.

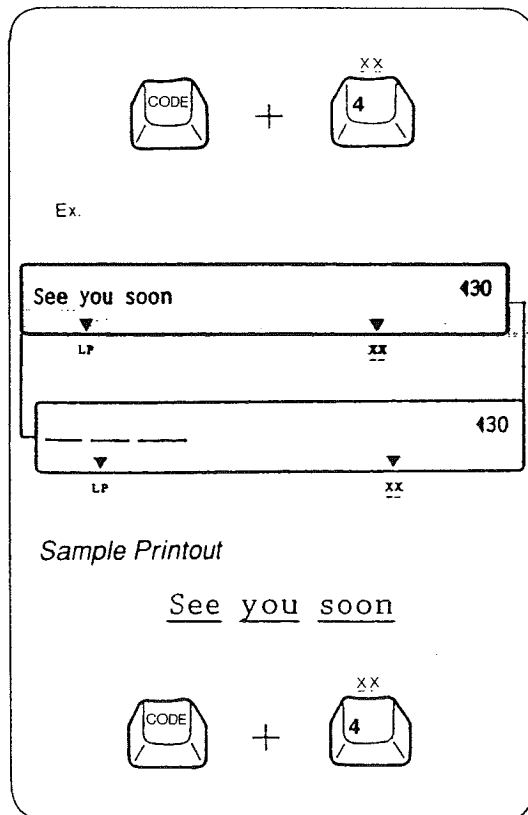

2. Automatic Word Underlining

- 1) Hold down the Code Key and press the "4" (XX) Key. A "▼" appears above "XX" on the LCD.
- 2) Type in the text to be underlined.
- Underlined text is distinguished on the LCD by the "▼" mark and characters which flash alternately.
- 3) To cancel the word underlining, hold down the Code Key and press the "4" (XX) Key again. The "▼" above "XX" on the LCD disappears.
- 4) This function can be used together with Automatic centering and Bold typing functions.

6. AUTOMATIC CARRIER RETURN

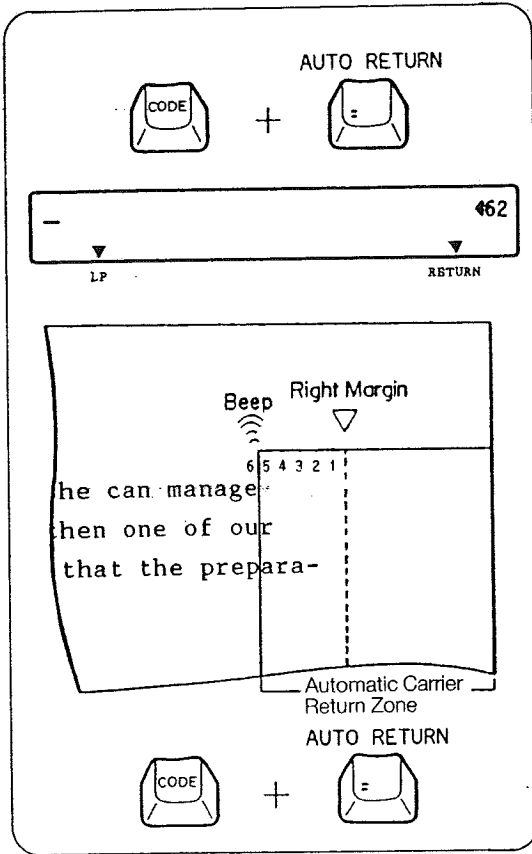

This function eliminates the need to press the Return Key at the end of every line.

- This function is automatically activated in STORE mode, but cannot be activated in JUST mode.
- 1) Hold down the Code Key and press the "=" Key. A "▼" appears above "RETURN" on the LCD.
 - 2) Once activated, the Carrier will automatically return when you type a hyphen or space in the automatic carrier return zone. The automatic carrier return zone is the area 5 spaces to the left of the currently set right margin. A beep is heard when the Carrier enters the automatic carrier return zone:
 - If a hyphen or space is not typed in the automatic carrier return zone, the Carrier will advance past the right margin.
 - 3) To cancel the Automatic carrier return function, hold down the Code Key and press the "=" Key again. The "▼" above "RETURN" on the LCD disappears.

7. REQUIRED HYPHEN AND REQUIRED SPACE

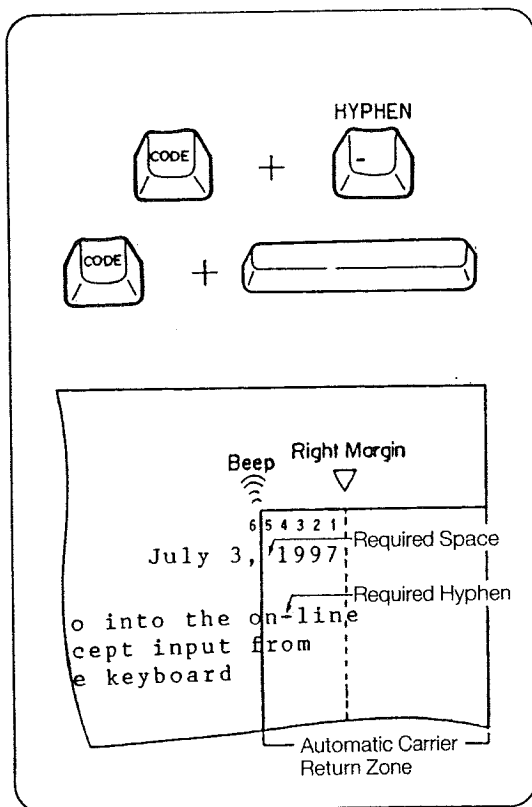

This function allows you to enter hyphens or spaces in the automatic carrier return zone that will not trigger the automatic carrier return.

- 1) To type a required hyphen or required space, hold down the Code Key and Hyphen Key or Space Bar.
- 2) Any hyphen or space typed in this manner will not be removed, nor will it trigger a carrier return.
 - Hyphens typed before entering the automatic carrier return zone when storing a file or when editing a file are automatically entered as required hyphens.
 - When a file is recalled, normal hyphens-i.e. usually syllable hyphens, originally typed in the automatic carrier return zone without the Code Key-will automatically be removed if they do not fall in the automatic carrier return zone during printout.
 - When a file is recalled, normal spaces (spaces typed without pressing the Code Key) will automatically trigger a carrier return if they fall in the automatic carrier return zone during printout.

8. SECOND KEYBOARD (SPECIAL CHARACTER SET)

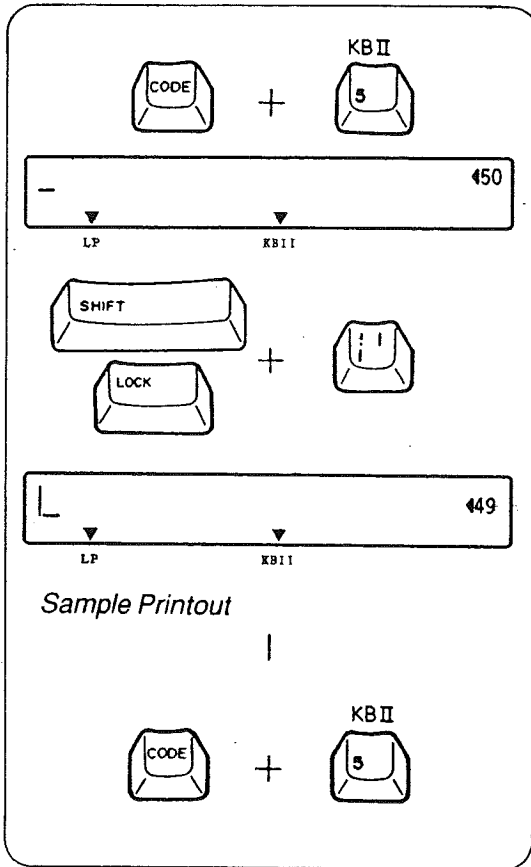

The symbols located at the upper right side of the three character keys can be typed with the following procedure.

- 1) Hold down the Code Key and press the "5" Key. A "▼" appears above "KBII" on the LCD.
- 2) Hold down the Shift Key, or press the Shift Lock Key, and type the key with the desired symbol. (If you pressed the Shift Key, keep it depressed).
- 3) Hold down the Code Key and press the "5" Key again to cancel the Second Keyboard and restore the standard keyboard. The "▼" above "KBII" on the LCD disappears.

9. CAPS LOCK

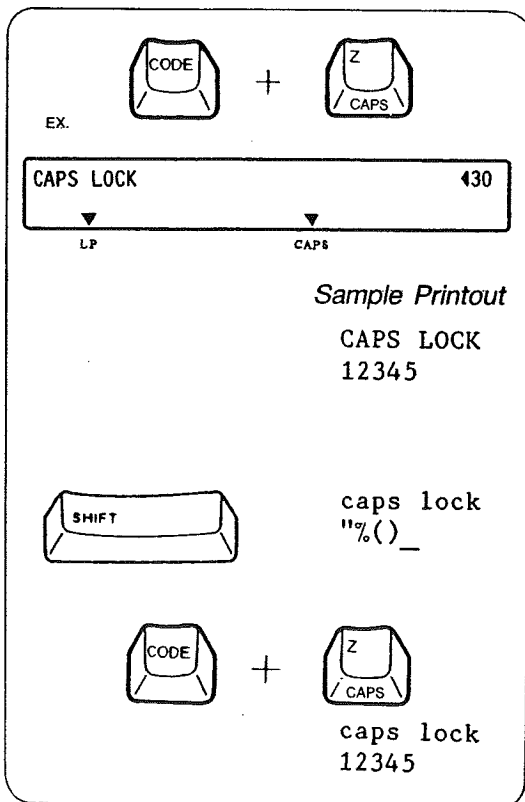

This function allows the typing of capital letters and numbers without pressing the Shift Key.

- 1) Hold down the Code Key and press the "Z" Key. A "▼" appears above "CAPS" on the LCD.
 - While in Caps lock mode, alphabetic characters are capitalized without pressing the Shift Key. The number/symbol keys are printed in lower case.
 - If you press the Shift Key in this mode, alphabetic characters are printed in lower case, and the number/symbol keys are printed in upper case.
- 2) To cancel Caps lock mode, hold down the Code Key and press the "Z" Key again. A "▼" above "CAPS" on the LCD disappears.

MEMORY FUNCTION

The memory functions will make your typing easier and more efficient.

Repetitive phrases, technical terminology and entire letters can be stored, edited and recalled (printed) at will.

You can also make several files with formats (margins and tabs) for letters and other documents you regularly type.

- Your typewriter has a memory back-up battery which protects the stored files for a minimum of five years, even when the power switch is turned off.
- When power is turned on, six beeps sound if the back-up battery has been completely drained. The contents of the stored file is erased. Please contact your nearest Sears Service Center in this case.

1. FILE STORING

This typewriter is equipped with a 10,000 character memory for storing up to 50 files.

Three types of files can be stored.

TEXT file ——— for entire letters

PHRASE file — for often-used phrases or terminology

FORMAT file — for line formats (margins and tabs only)

Choose the file type according to the text to be stored.

1. Storing a TEXT File

For storing entire letters (including tabs and margins).

- 1) Press the Mode Key until a "▼" appears on the LCD above "STORE". "NAME OF FILE?" is displayed.
 - 2) Type the file name (maximum of five letters/numbers). Then press the Return Key.
- You can terminate the STORE mode at any time by pressing the Mode Key. Any entered text will be automatically stored.

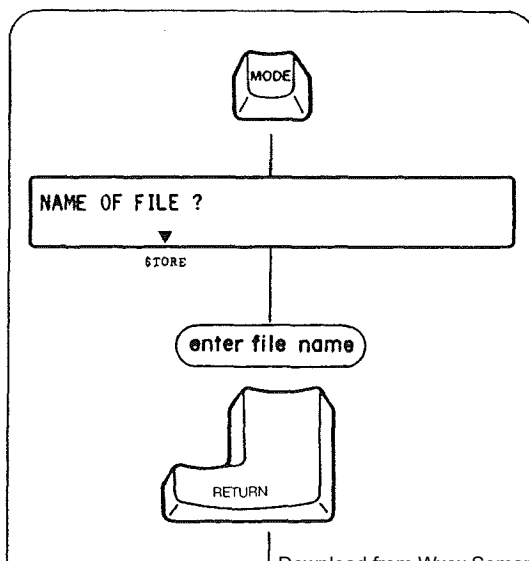

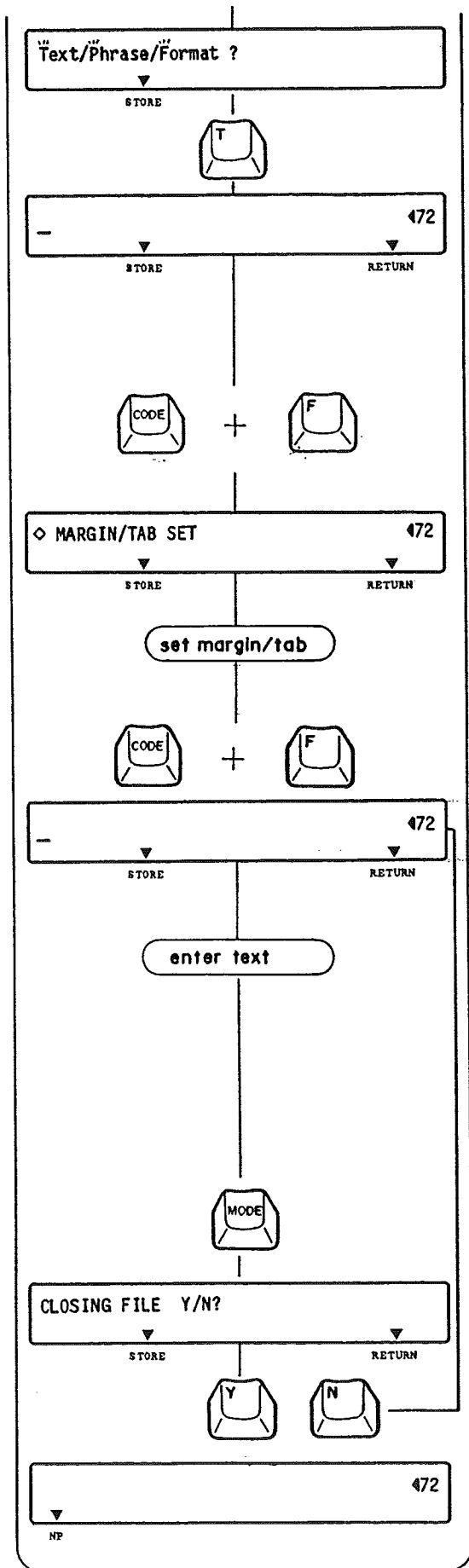

- 3) "Text/Phrase/Format?" appears on the LCD. "T", "P" and "F" will flash.
- 4) Press the "T" (TEXT) Key.
The paper is fed one line and the Carrier returns to the left margin. The LCD is cleared and the counter indicating the number of spaces to the right margin appears. The Automatic return is automatically activated.
 - Margin and tab settings, as well as other functions which were in effect before entering the STORE mode, are automatically canceled to be stored in the back-up memory. They are automatically recalled when you exit the STORE mode.
- 5) Hold down the Code Key and press the "F" Key. "◇ MARGIN/TAB SET" appears.
- 6) Set the left and right margins and tabs, as you would in the NP mode. Clear any unnecessary tabs.
- 7) Hold down the Code Key and press the "F" Key again. "◇ MARGIN/TAB SET" disappears. The Carrier returns to the newly set left margin.
- 8) Enter text. Entered text is displayed on the LCD and printed one line at a time when you type a normal hyphen or space in the automatic carrier return zone.
 - Make corrections on the LCD before the line is printed. Once text is printed on paper, it cannot be corrected. To make corrections after text has been printed, first close the file and edit it on the LCD, as described in section 3, "File Editing".
- 9) Press the Mode Key to terminate the STORE mode. "CLOSING FILE Y/N?" appears on the LCD.
- 10) Press the "Y" Key to close the file and return to the Normal Print (NP) mode.
 - Press the "N" Key to return to the Text storing mode.

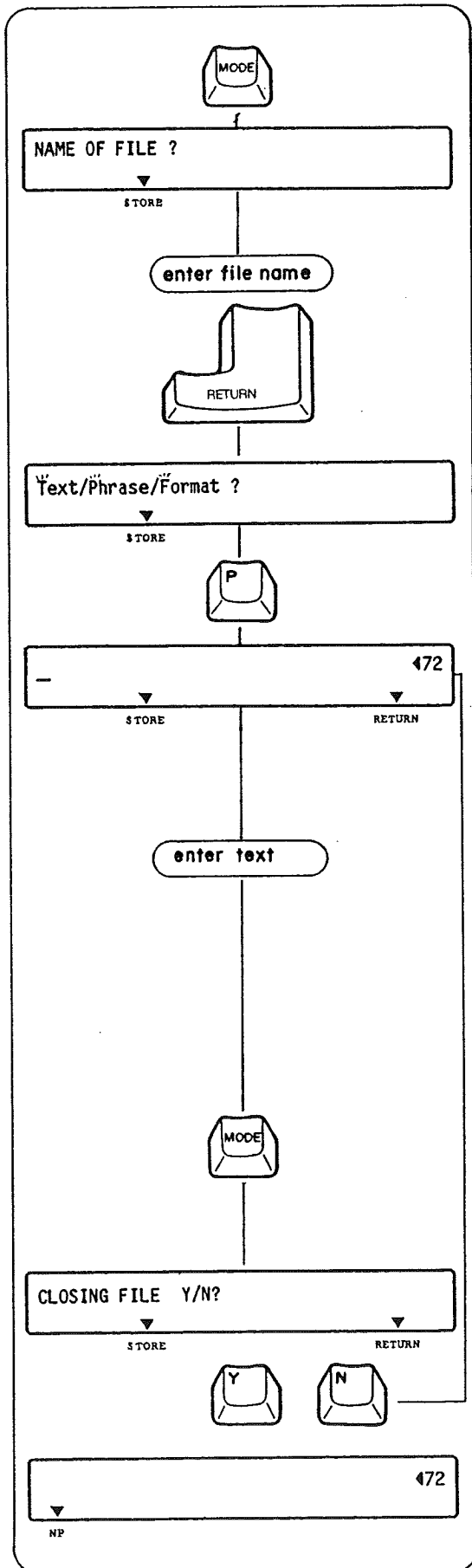

2. Storing a PHRASE File

Phrase files are used to store brief expressions or terminology without margins or tabs.

- 1) Press the Mode Key until a "▼" appears on the LCD above "STORE". "NAME OF FILE?" is displayed.
- 2) Type the file name (maximum of five letters/numbers). Then press the Return Key.
 - You can terminate the STORE mode at any time by pressing the Mode Key. Any entered text will be automatically stored.
- 3) "Text/Phrase/Format?" appears on the LCD. "T", "P" and "F" will flash.
- 4) Press the "P" (PHRASE) Key. The LCD is cleared and the counter indicating the number of spaces to the right margin appears. The Automatic return is automatically activated.
 - The Underlining and Bold functions set before entering the STORE mode are automatically canceled to be stored in the back-up memory. They are automatically recalled when you exit the STORE mode.
- 5) Enter text. Entered text is displayed on the LCD and printed one line at a time when you type a normal hyphen or space in the automatic carrier return zone.
 - Make corrections on the LCD before the line is printed. Once text is printed on paper, it cannot be corrected. To make corrections after text has been printed, first close the file and edit it on the LCD, as described in section 3, "File Editing".
- 6) Press the Mode Key to terminate the STORE mode. "CLOSING FILE Y/N?" appears on the LCD.
- 7) Press the "Y" Key to close the file and return to the Normal Print (NP) mode.
 - Press the "N" Key to return to Phrase storing mode.

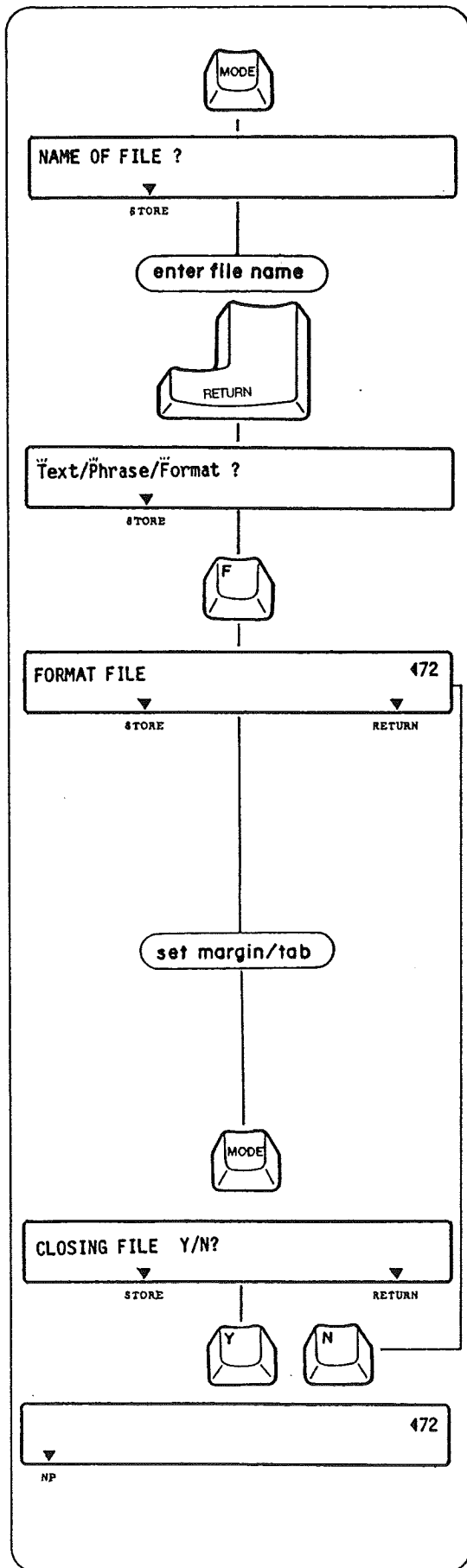

3. Storing a FORMAT File

For storing margin and tab line formats. This function is useful for typing onto preprinted forms.

- 1) Press the Mode Key until a "▼" appears on the LCD above "STORE". "NAME OF FILE?" is displayed.
- 2) Type the file name (maximum of five letters/numbers). Then press the Return Key.
 - You can terminate the STORE mode at any time by pressing the Mode Key. Any entered format data will be automatically stored.
- 3) "Text/Phrase/Format?" appears on the LCD. "T", "P" and "F" will flash.
- 4) Press the "F" (FORMAT) Key.
 - Margin and tab settings, as well as other functions which were in effect before entering the STORE mode, are automatically canceled to be stored in the back-up memory. They are automatically recalled when you exit the STORE mode.
- 5) Set the left and right margins and tabs at any position as you would in any other mode. Clear any unnecessary tabs.
- 6) Press the Mode Key to terminate the STORE mode. "CLOSING FILE Y/N?" appears on the LCD.
- 7) Press the "Y" Key to close the file and return to the Normal Print (NP) mode.
 - Press the "N" Key to return to the Format storing mode.

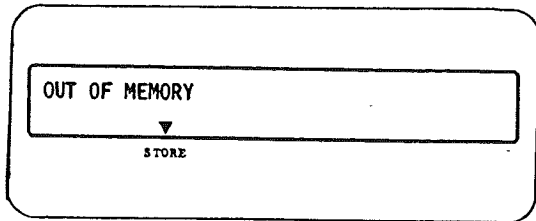
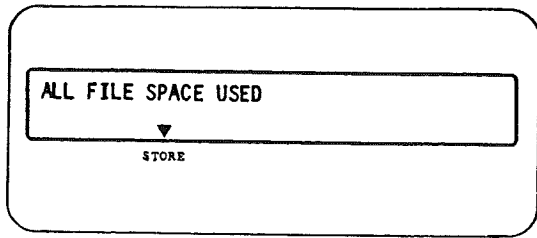

2. STOP CODE

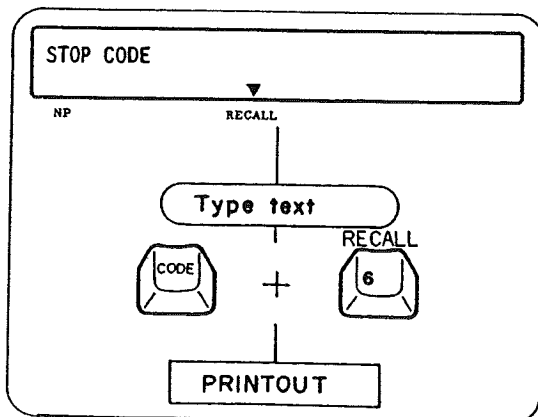
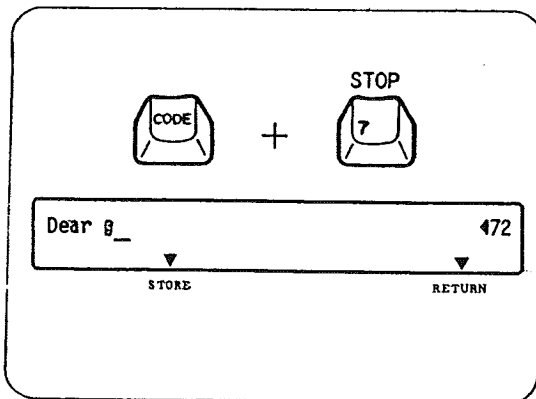

4. All File Space Used

If you specify a new file and there are already 50 files in the typewriter memory, "ALL FILE SPACE USED" appears on the LCD.

In this case, one file must be deleted to create a new file. (Refer to "File Deleting".)

5. Out of Memory

If you run out of memory, "OUT OF MEMORY" appears on the LCD.

In this case, press the Mode Key to store entered text and return to the NP mode. Unneeded file(s) must be deleted to make room in the memory for your present file. (Refer to "File Deleting".)

To stop printing at locations in a file in order to type words or phrases during recalling (printing), enter stop codes while storing or editing the file.

1. Entering Stop Codes

1) Hold down the Code Key and press the "7" Key at the position you wish to stop in the file. A highlighted "S" is displayed on the LCD.

• You can remove the stop code by deleting the character "g" with the Correction Key.

2) An "X", which stands for the stop code, is printed on the paper when the line is printed while you are storing the file. (When entering stop codes while editing the file, an "X" is not printed.) The "X" is only an indicator, and will not appear during recall (printout).

2. Using Stop Code During Recalling (Printing)

1) When the typewriter has stopped at a stop code during printout, "STOP CODE" appears on the LCD.

2) Type desired text.

3) Hold down the Code Key and press the "6" Key to restart printout. (Refer to "File Recall".)

The stop code can also be used in conjunction with the decimal tab or auto centering, as a Decimal tab stop or an Auto center stop.

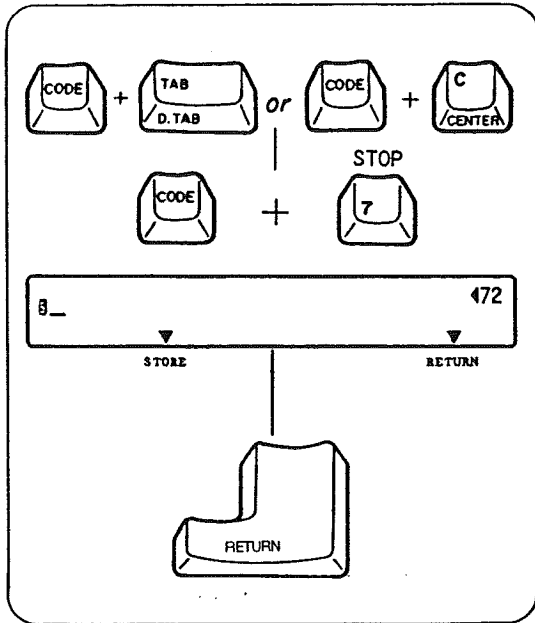

3. Entering a Decimal Tab/Auto Center Stop Code

- 1) First activate the Decimal tab/Automatic centering function.
- 2) Then enter the stop code. A highlighted "S" is displayed on the LCD.
- You can remove the stop code by deleting the character "S" with the Correction Key.
- 3) Press the Return Key. An "X" which represents the stop code is printed on the paper. (When entering stop codes while editing a file, there is no need to press the Return Key and an "X" is not printed.) The "X" is only an indicator, and will not appear during recall (printout).

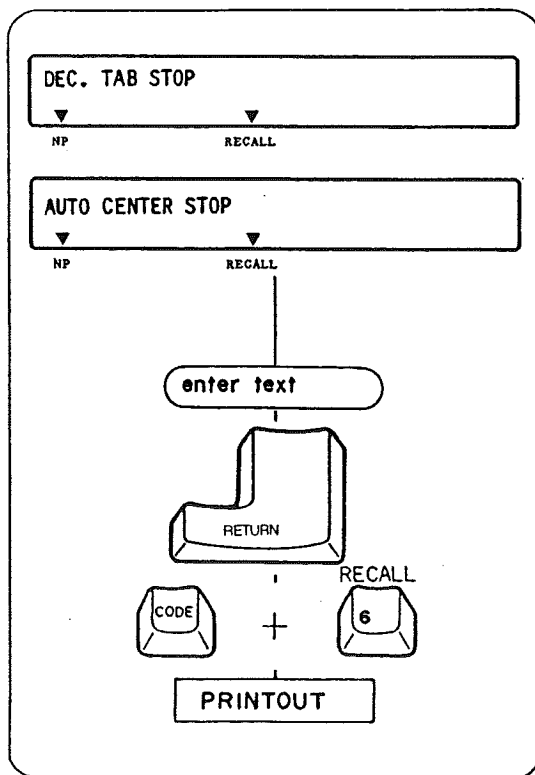

4. Using a Decimal Tab/Auto Center Stop Code During Recalling (printing)

- 1) When the typewriter has stopped at a Decimal tab stop or Auto center stop during printing, "DEC. TAB STOP" or "AUTO CENTER STOP" will appear on the LCD.
- 2) Enter desired text. Entered text is displayed on the LCD.
- 3) Press the Return Key or Tab Key for decimal tab stop to print the text. (Refer to "Decimal Tab", "Automatic Centering".)
- 4) Hold down the Code Key and press the "6" Key to restart printout. (Refer to "File Recall".)

3. FILE EDITING

This function allows you to edit stored files on the LCD.

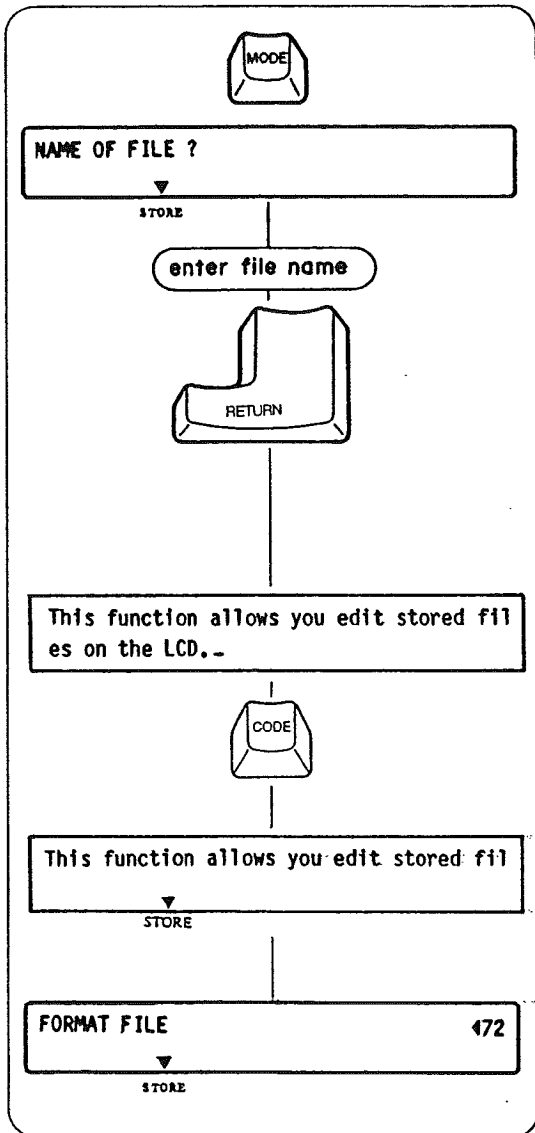

1. Activating Edit Mode

- 1) Press the Mode Key until a "▼" appears on the LCD above "STORE". "NAME OF FILE?" is displayed.
- 2) Type the file name to be edited (maximum of five letters/numbers). Then press the Return Key.
 - You can terminate the Edit mode by pressing the Mode Key (and the "Y" Key to close the file) at any time.
- 3) The beginning of the file appears on the LCD. Move the cursor to any position in the file and edit it. Make corrections as explained in "Corrections on LCD".
 - In the Edit mode, when more than 40 characters are entered, they appear on the LCD in 2 lines. In order to check which features are engaged, depressing the Code Key will change the LCD to one line and the "▼" marks will appear to show the mode and feature settings. When the Code Key is released, the indication on the LCD returns to 2 lines.
 - When you specify a format file, "FORMAT FILE" appears. Move the Carrier to any position and set the new margins/tabs as you would in any other mode.

2. Function Symbols

When stored text is displayed on the LCD, the typewriter functions are represented by the symbols shown at left.

Space	↓ Index
← Backspace	↑ Reverse Index
↵ Return	⌘ Required Hyphen
→ Tab	⌘ Required Space
■ (↔◊CENTERING) Auto Center	
■ (↔◊DECIMAL TAB) Decimal Tab	
■ (↔◊MARGIN/TAB SET) Margin/Tab set in text file	
■ (↔◊INDENT) Paragraph Indentation	

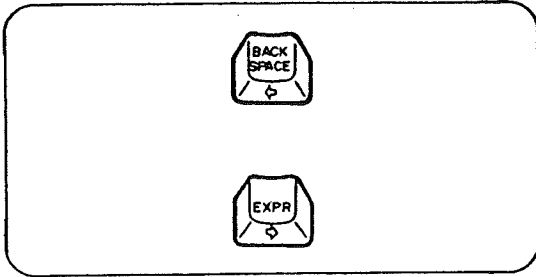

3. Moving Cursor

- 1) Press the Backspace Key to move the cursor one space to the left.
 - 2) Press the Express Key to move the cursor one space to the right.
- Hold down either key for continuous movement.

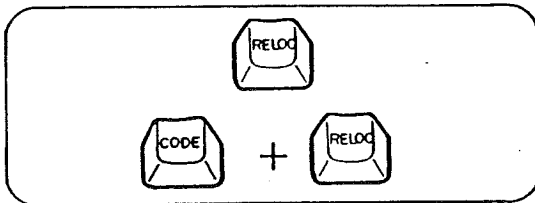

4. Going to the Beginning or End of a File

- 1) Press the Relocation Key to go to the end of the file.
- 2) Hold down the Code Key and press the Relocation Key to go to the beginning of the file.

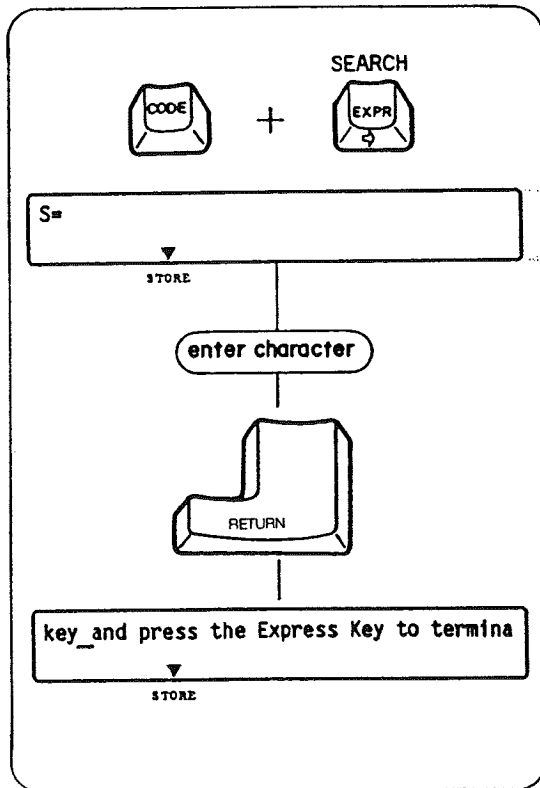

5. Moving Cursor to Desired Position (Using the Search Function)

- 1) Hold down the Code Key and press the Express Key. "S=" appears on the LCD.
 - 2) Type the characters you want to find (maximum of 18 characters).
 - 3) Press the Return Key. The typewriter searches for the text that you have typed from its present position (regardless of any underlining of text.)
 - 4) Once found, the cursor appears at the position after the last letter of that text. If the text that you have typed is not in the file, the cursor returns to its previous position before function activation.
- The desired text will be memorized by the typewriter until power is turned off, and appears every time you activate the Search function. It is useful to find any other occurrences of the same text.

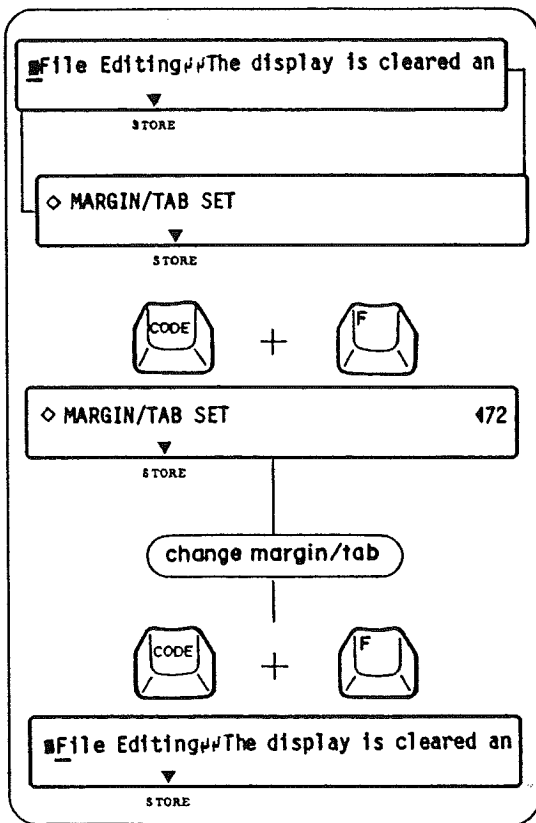

6. Changing Existing Margin and Tab Settings (in the Text File Only)

- 1) Locate the box mark (■) which will alternately flash with "◇ MARGIN/TAB SET" when you bring the cursor under it.
- 2) Hold down the Code Key and press the "F" Key. The counter indicating the remaining number of spaces to the right margin appears. The margin/tab settings in this file are recalled.
- 3) Set any new margins and tabs, moving the carrier to any position as you would in any other mode.
- 4) Hold down the Code Key and press the "F" Key again. The cursor returns one space to the right of the box mark (■).

7. Back Code

To move the Carrier back one space at the left margin or a tab position, enter back codes while editing the file.

● Hanging Indentation

This function is used to temporarily move the character(s) to the left of the stored left margin of text. It causes the beginning of the paragraph to be highlighted and the reader of the text to distinguish the beginning of each paragraph.

● Saving Tab

This function is used to temporarily move the character(s) to the left of a stored tab position or indent position in the text. Tab memory can be saved with this function.

Entering Back Codes

Hold down the Code Key and press the "B" Key. The symbol "←" appears on the LCD.

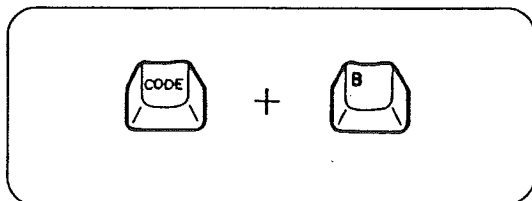

4. FILE RECALL (PRINTOUT ON PAPER)

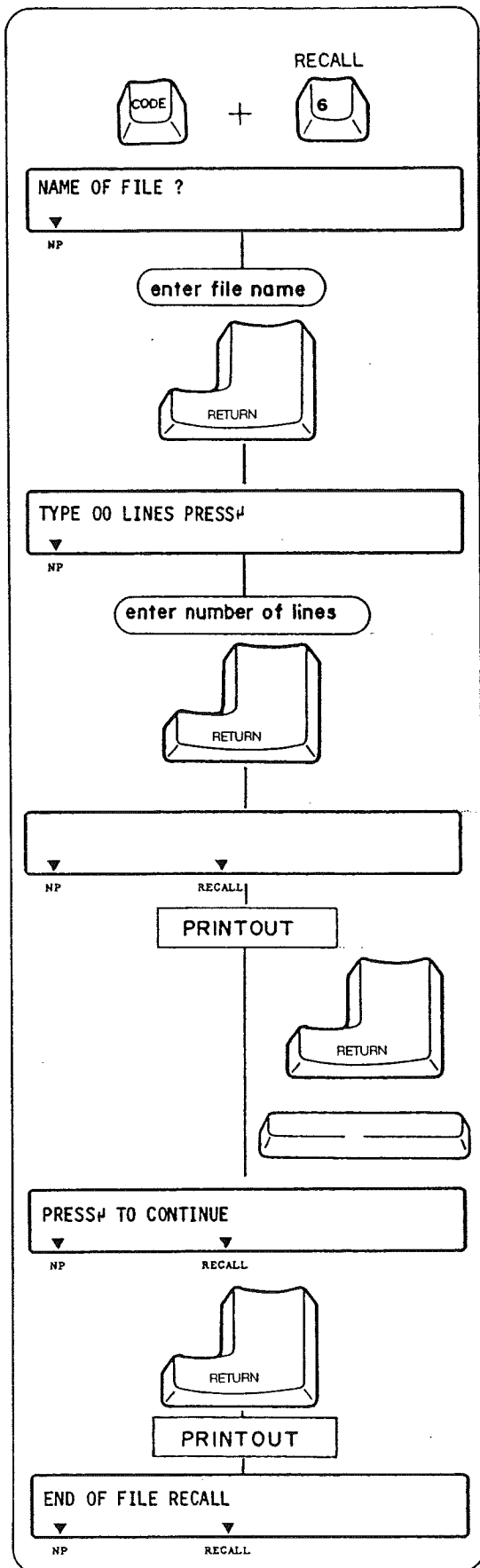

This function allows you to recall (print out) the stored file in the NP or JUST mode.

- The LCD must be cleared to activate the File recall.

1. Recalling a TEXT File

- 1) Hold down the Code Key and press the "6" Key. "NAME OF FILE?" appears on the LCD. Type the file name and press the Return Key.

- "NOT FOUND PRESS ←" appears on the LCD if you have entered a file name that is not stored in the memory. Press the Return Key and retype the file name.

- 2) The Carrier will move to the left margin setting of that particular file and "TYPE 00 LINES PRESS ←" appears on the LCD.

- 3) Type in any number of lines from 01 to 99. (Standard 11" paper is 66 single-spaced lines long and 14" paper is 84 single-spaced lines long.) Then press the Return Key.

- If you do not enter the number of lines desired, printing will not stop until the end of the file.

- 4) A "▼" appears on the LCD above "RECALL", and the typewriter will print the file.

- To temporarily stop printout, press the Return Key. "PAUSE PRESS ←" appears on the LCD. Restart printing by pressing the Return Key again.

- You can cancel the recall function at any time during printout by pressing the Space Bar. "END OF FILE RECALL" appears on the LCD when the recall has been canceled.

- 5) The typewriter will stop after printing the specified number of lines, and "PRESS ← TO CONTINUE" appears on the LCD asking you to restart printing. Press the Return Key to restart printout.

- You can not cancel the recall function by pressing the Space Bar when "PAUSE PRESS ←" or "PRESS ← TO CONTINUE" is displayed on the LCD.

- 6) When the recall has been completed, "END OF FILE RECALL" appears on the LCD.

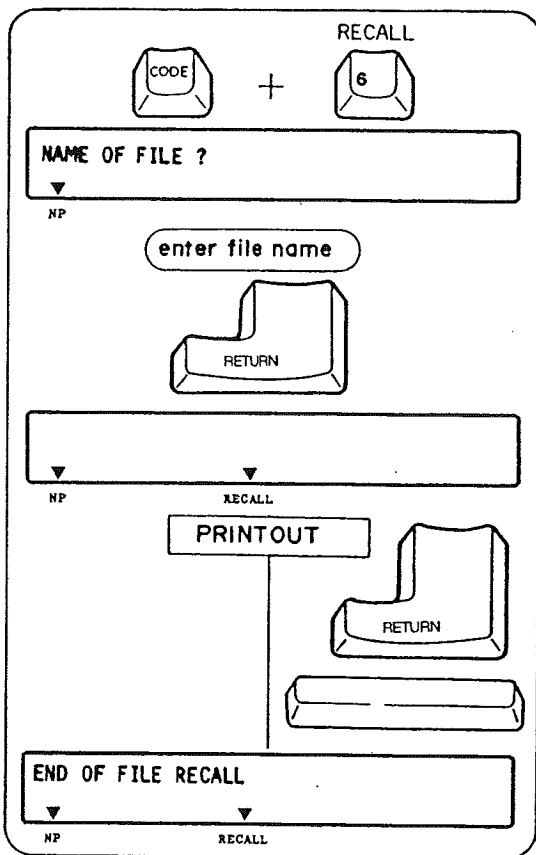

2. Recalling a PHRASE File

- 1) Hold down the Code Key and press the "6" Key. "NAME OF FILE?" appears on the LCD. Type the file name and press the Return Key.
 - "NOT FOUND PRESS ←" appears on the LCD if you have entered a file name that is not stored in the memory. Press the Return Key and retype the file name.
- 2) A "▼" appears on the LCD above "RECALL", and the Carrier will start printing from its present position, according to the margins which are currently set.
 - To temporarily stop printout, press the Return Key. "PAUSE PRESS ←" appears on the LCD. Restart printing by pressing the Return Key again.
 - You can cancel the Recall function at any time after starting a printout by pressing the Space Bar. "END OF FILE RECALL" appears on the LCD when recall has been canceled.

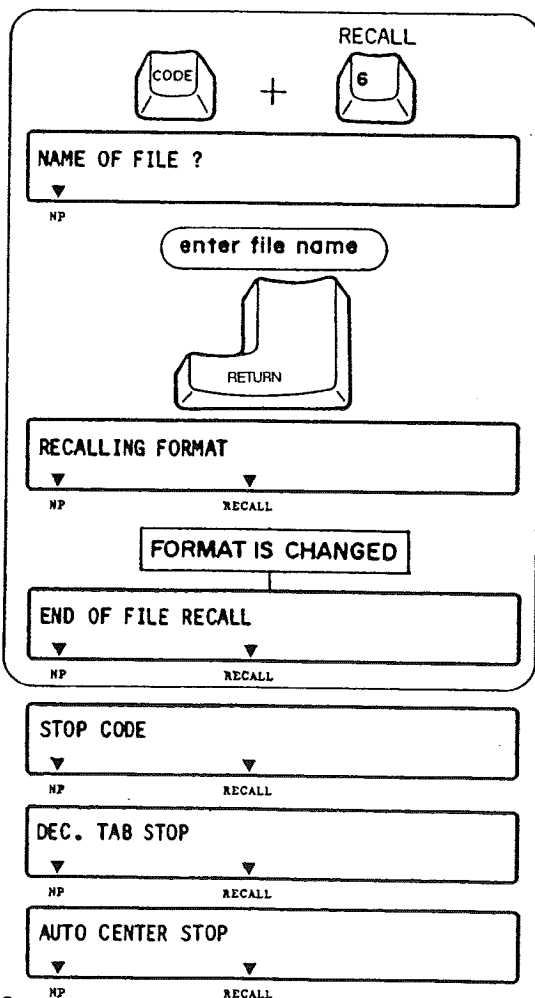

3. Recalling a FORMAT File

- 1) Hold down the Code Key and press the "6" Key. "NAME OF FILE?" appears on the LCD. Type the file name and press the Return Key.
 - "NOT FOUND PRESS ←" appears on the LCD if you have entered a file name that is not stored in the memory. Press the Return Key and retype the file name.
- 2) A "▼" appears on the LCD above "RECALL". While "RECALLING FORMAT" appears on the LCD, the margin/tab format set on the typewriter will be automatically changed to the recalled one, and then "END OF FILE RECALL" appears on the LCD.
 - The printing stops at any stop code in the file and "STOP CODE", "DEC. TAB STOP" or "AUTO CENTER STOP" appears on the LCD. Enter desired text and restart printout by holding down the Code Key and pressing the "6" Key. (Refer to "Stop Code".)

5. FILE LISTING

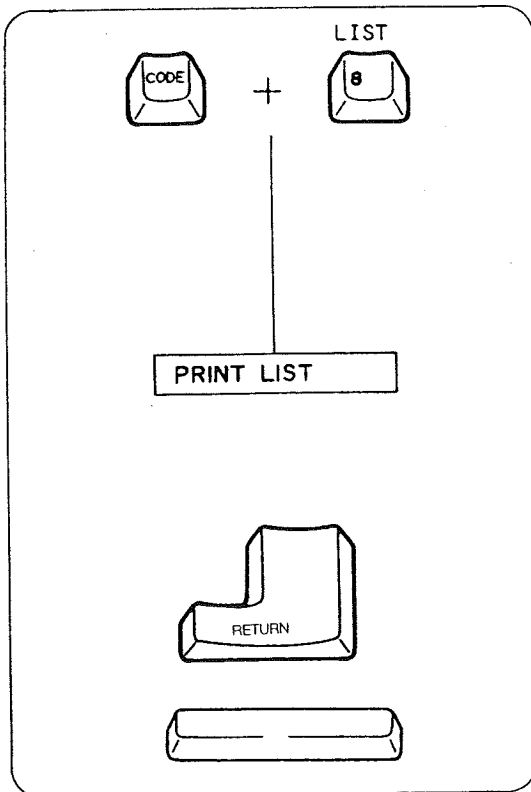

Sample Printout

```
TEXT      LTR1 :Dear X Thank you very much for your lett
PHRASE    PHRS1:Please remember me kindly to your parent
FORMAT    FRMT1:
```

```
3515 CHARACTERS AVAILABLE
03 FILES
```

This function allows you to print a list of stored files.

- The LCD must be cleared to activate this function, and it cannot be activated in the STORE mode.
- 1) Hold down the Code Key and press the "8" Key.
- "00 FILES" is printed if there are no files in the memory.
- 2) The type of file, file name and the first 40 characters in the file are printed in a certain format from position 10 on the margin scale (in 10 pitch), regardless of the present margin settings. The number of characters remaining (available) in the memory and number of files already in memory are printed at the end of this list.
- To temporarily stop printout, press the Return Key. "PAUSE PRESS ←" appears on the LCD. Restart printing by pressing the Return Key again.
 - Press the Space Bar to terminate this function after it has been activated.

6. AVAILABLE MEMORY CAPACITY

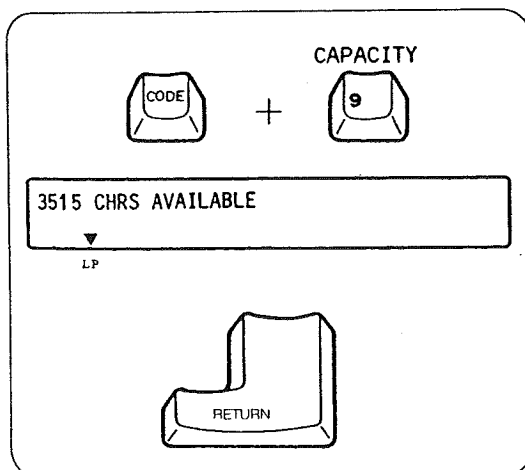

This function allows you to see exactly how much memory is still available.

- The LCD must be cleared to activate this function, and it cannot be activated in the STORE mode.
- 1) Hold down the Code Key and press the "9" Key.
 - 2) The amount of memory available is automatically displayed on the LCD.
 - 3) Press the Return Key to terminate this function.

7. FILE DELETING

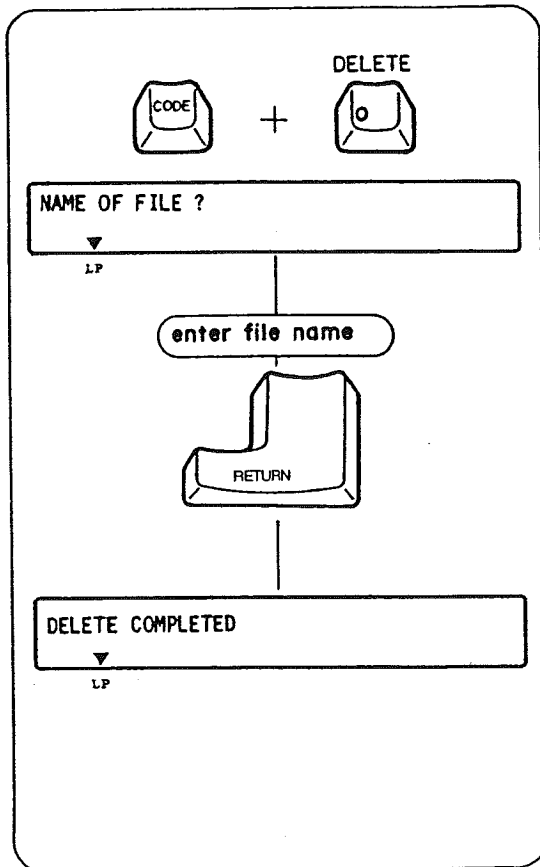

Use this function to delete any unnecessary files or to make room for new files in the memory.

- The LCD must be cleared to activate this function, and it cannot be activated in the STORE mode.
- 1) Hold down the Code Key and press the "0" Key. "NAME OF FILE?" appears on the LCD.
 - 2) Type in the file name and press the Return Key.
 - 3) "DELETE COMPLETED" will appear on the LCD if the file was in the typewriter memory.
- "NOT FOUND PRESS ←" will appear if the file was not in the memory. Press the Return Key and retype the file name. Use Correction Key to delete any name on the LCD, if necessary.
 - You can cancel the file deleting function by pressing the Return Key only if there is no file name on the LCD.
- 4) Press the Return Key to terminate this function.

8. MEMORY ALL CLEAR

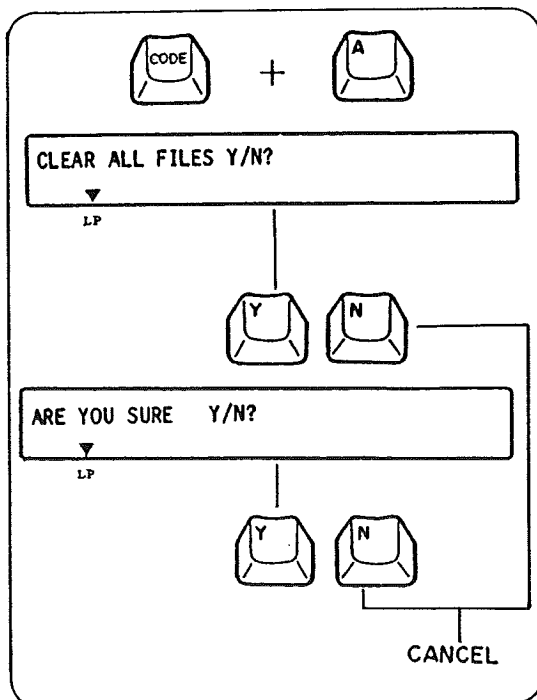

This function allows you to delete all files in the memory.

- The LCD must be cleared to activate this function, and it cannot be performed in the STORE mode.
- 1) Hold down the Code Key and press the "A" Key. "CLEAR ALL FILES Y/N?" appears on the LCD.
 - 2) Press the "Y" Key. "ARE YOU SURE Y/N?" appears on the LCD, asking for confirmation.
 - 3) All files are cleared when the "Y" Key is pressed again.
- The function is canceled if the "N" Key is pressed after the first or second prompt.

9. BLOCK OPERATIONS (COPY/MOVE/DELETE)

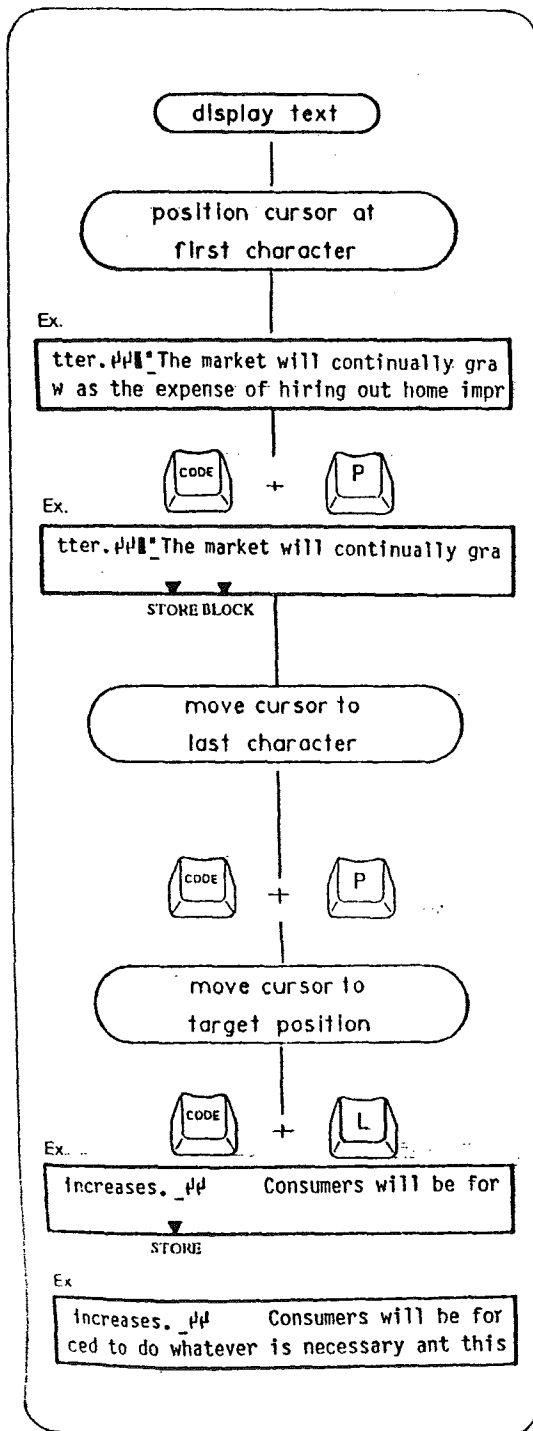

1. Block Copy

This function copies a block of text and inserts the copy at a specified location in the file. Block copy does not alter or remove the contents of the original block.

- 1) Display the file text using the edit mode.
 - 2) Position the cursor on the first character of the text to be copied.
 - 3) Hold down the Code Key and press the "P" Key. This marks the beginning of the block. Two beeps sound and a "▼" appears above "BLOCK" on the display. (BLOCK function becomes effective at this time.)
 - 4) Move the cursor to the last character of the text to be copied.
 - 5) Hold down the Code Key and press the "P" key again to mark the end of the block. Two beeps sound, indicating that the block of text has been defined. The defined block of text starts flashing on the display.
 - 6) Move the cursor to the position where you want to copy the block of text.
 - 7) Hold down the Code key and press the "L" key. The block of text is copied at the specified position. The "▼" above "BLOCK" disappears. The block function is canceled at this time.
- If the defined block of text does not exceed 1 character, the copy operation is not carried out and the block function is canceled.

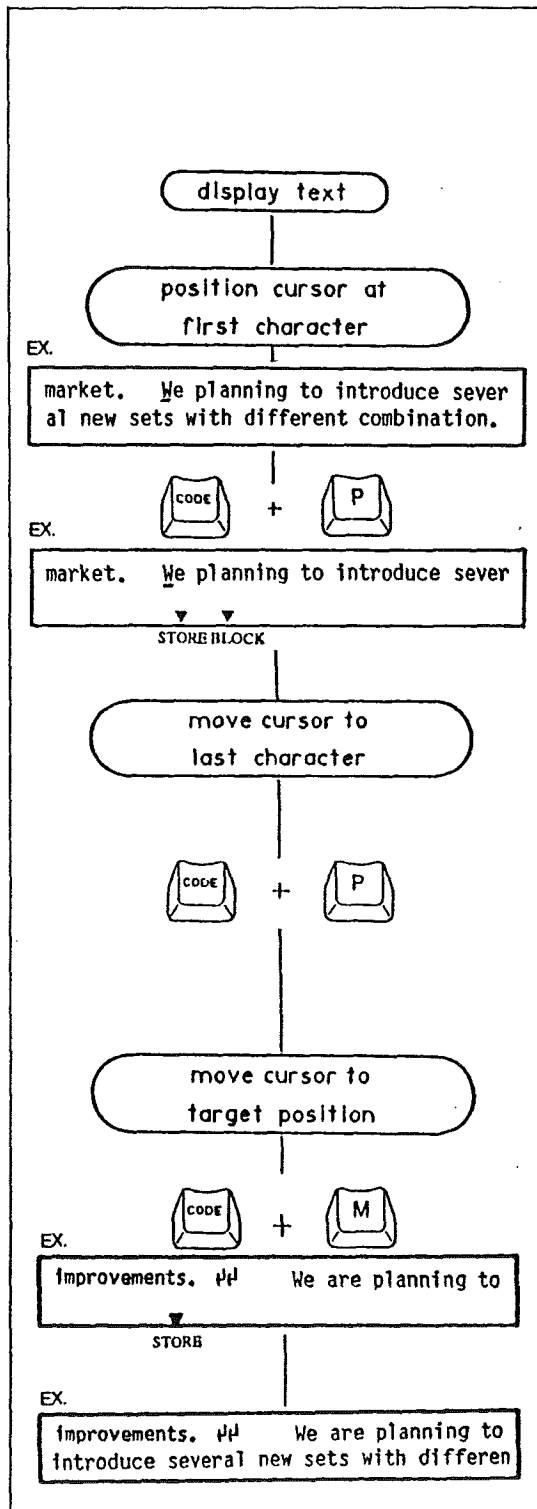

2. Block Move

This function moves a block of text to a specified location in the file.

- 1) Display the file text using the edit mode.
 - 2) Position the cursor on the first character of the text to be moved.
 - 3) Hold down the Code Key and press the "P" Key. This marks the beginning of the block. Two beeps sound and a "▼" appears above "BLOCK" on the display, indicating that the block function is in effect.
 - 4) Move the cursor to the last character of the text to be moved.
 - 5) Hold down the Code Key and press the "P" key again to mark the end of the block. Two beeps sound, indicating that the block of text has been defined. The defined block of text starts flashing on the display.
 - 6) Move the cursor to the position where you want to move the block of text.
 - 7) Hold down the Code Key and press the "M" Key. The block of text is moved to the specified position. "▼" above "BLOCK" disappears. The block function is canceled at this time.
- When a block of text is moved, succeeding characters are shifted to the left to fill in the space created by the moving of text.

3. Block Delete

This function deletes a block of text in a file.

- 1) Display the file text using the edit mode.
- 2) Position the cursor on the first character of the text to be deleted.
- 3) Hold down the Code Key and press the "P" Key. This marks the beginning of the block. Two beeps sound and a "▼" appears above "BLOCK" on the display, indicating that the block function is in effect.
- 4) Move the cursor to the last character of the text to be deleted.
- 5) Hold down the Code Key and press the "P" key again to mark the end of the block. Two beeps sound, indicating that the block of text has been defined. The defined block of text starts flashing on the display.
- 6) Hold down the Code Key and press the Correction Key. The block of text is deleted and all succeeding text is shifted to the left to fill in the space created. The "▼" mark above "BLOCK" disappears, indicating that the block function is canceled.

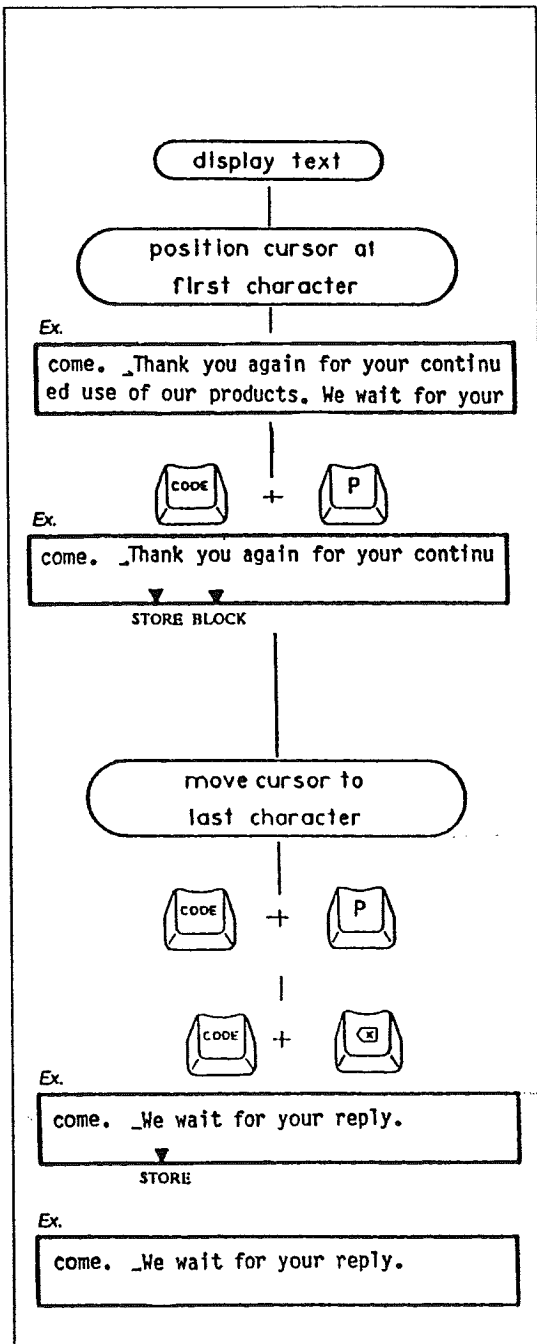

SUPPLIES

1. Printwheel

Your typewriter comes with a Prestige 10 Printwheel (Sears No. 54018). Besides this type style, a variety of printwheels with different type styles as listed below are available for your machine.

Sears No.	Type Style	Pitch	Type Style Sample:
54011	Prestige	12	ABCDEabcde1234
54012	Courier	10	ABCDEabcde1234
54013	Courier	12	ABCDEabcde1234
54014	Cubic	10	ABCDEabcde1234
54015	Script	12	ABCDEabcde1234
54016	Orator	10	ABCDEABCDE1234
54017	Mini Gothic	15	ABCDEabcde1234

Contact the nearest Sears Store or Catalog Plant for further information.

2. Ribbon Cassette

- 1) Correctable Black Carbon Film Ribbon — 54085
Your typewriter comes with Correctable Black Carbon Film Ribbon. This ribbon is not reusable because the inked surface of the ribbon is transferred to the paper as you type.
- 2) Nylon Fabric Ribbon — 54091
This optional ribbon can be used to type a considerably larger number of characters than Carbon Film Ribbon.

3. Correction Tape

- 1) Lift-off Correction Tape — 54009
Your typewriter comes with Lift-off Correction Tape. This correction tape is used only with Correctable Black Carbon Film Ribbon (No. 54085) which was originally installed on your typewriter. It lifts the black carbon film ink off the paper.
- 2) Cover-up Correction Tape — 5498
This optional correction tape covers up the error and is used only with Nylon Fabric Ribbon (No. 54091).

AFTER USING THE TYPEWRITER AND TO STORE

- 1) Turn off the on/off Switch and disconnect the Power Cord from the electrical outlet.
- 2) Store the Power Cord in the Cord Compartment.
- 3) Replace the Keyboard Cover and fasten securely.

MAINTENANCE AND SERVICE

1. Cleaning

- 1) Do not attempt to disassemble the typewriter to clean it.
- 2) Dust the typewriter lightly, using only a dry cloth.
- 3) Never use water or solvents such as thinner, alcohol, etc. to clean your typewriter.
- 4) When the Top Cover is opened for replacement of the Printwheel, Ribbon Cassette or Correction Tape, be sure not to drop items such as a pin, paper clip, nail file, etc. into the typewriter. They may cause damage to the typewriter.

2. Service

- 1) It is recommended that your typewriter be serviced at least once a year by a Sears qualified service technician. Any malfunction caused by maintenance performed by anyone other than Sears qualified service personnel will void the warranty.
- 2) If the typewriter fails to function or does not function properly, check the following:
 - Is the typewriter plugged into a live socket?
 - Is the typewriter switched on?
 - Is the Printwheel properly installed? (See Page 9, Section 2, Paragraph 2)
 - Are the Ribbon Cassette and the Correction Tape properly installed?
 - Have the Ribbon Cassette or Correction Tape been used up?

If the typewriter still does not work properly after checking the above, contact your nearest Sears Service Center.

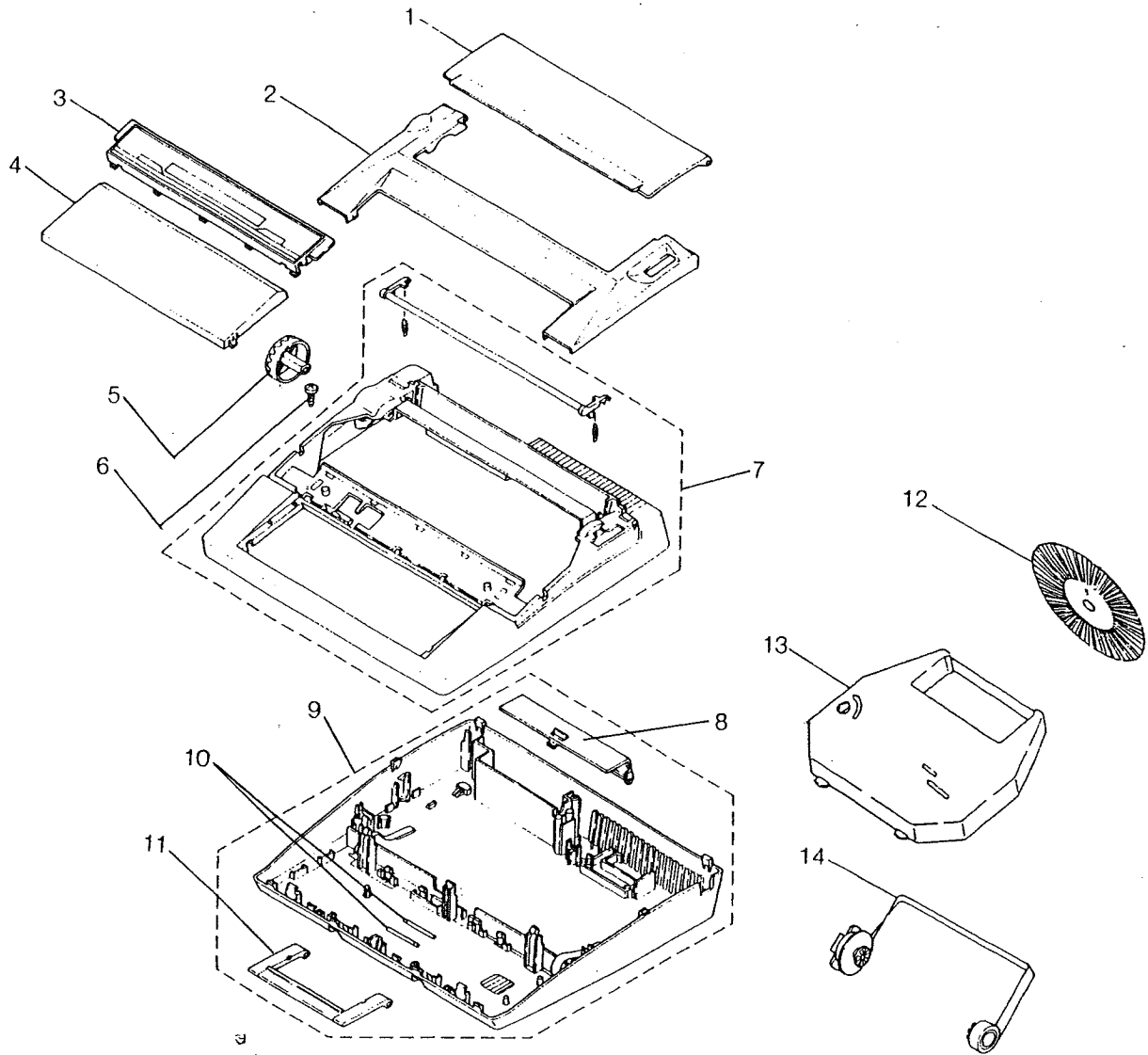

Key No.	Description	Part No.
1	Paper Support	060-71520-44
2	Top Cover	005-13062
3	LCD Assembly	060-27300
4	Keyboard Cover	060-70530
5	Platen Knob	060-70540-45
6	Screw	200-71020
7	Cover Assembly	005-61513
8	Cord Storage Cover	060-70580-44
9	Bottom Pan Assembly	005-70711
10	Handle Hinge Pin	200-70180
11	Handle	060-70320-44
12	Printwheel	} See page 46
13	Ribbon Cassette	
14	Correction Tape	

Your Sears Merchandise has added value when you consider that Sears has Service Units nationwide staffed with Sears trained professional technicians using Sears approved parts and methods. For replacement parts or service not shown above, contact your nearest Sears Service Center.

SEARS

OWNERS MANUAL

**MODEL NO.
161.53514090**

HOW TO ORDER REPAIR PARTS

Now that you have purchased your typewriter, should a need ever exist for repair parts or service, simply contact any Sears Service Center and most Sears Stores. Be sure to provide all pertinent facts when you call or visit.

757481

WORD PROCESSING TYPEWRITER

**WHEN ORDERING REPAIR PARTS, ALWAYS GIVE THE
FOLLOWING INFORMATION:**

1. PART NUMBER
2. PART DESCRIPTION
3. MODEL NUMBER 161.53514090
4. NAME of ITEM-WORD PROCESSING TYPEWRITER

All parts listed may be ordered from any Sears Service Center and most Sears Stores.

If the parts you need are not stocked locally, your order will be electronically transmitted to a Sears Repair Parts Distribution Center for expedited handling.

Sears, Roebuck and Co., Chicago, IL. 60684 U.S.A.

Free Manuals Download Website

<http://myh66.com>

<http://usermanuals.us>

<http://www.somanuals.com>

<http://www.4manuals.cc>

<http://www.manual-lib.com>

<http://www.404manual.com>

<http://www.luxmanual.com>

<http://aubethermostatmanual.com>

Golf course search by state

<http://golfingnear.com>

Email search by domain

<http://emailbydomain.com>

Auto manuals search

<http://auto.somanuals.com>

TV manuals search

<http://tv.somanuals.com>