

Palmcorder®  
PalmSight™

**Quasar®**

**VHS**

Camcorder  
**Operating Instructions**

Model No. **VM-L451**

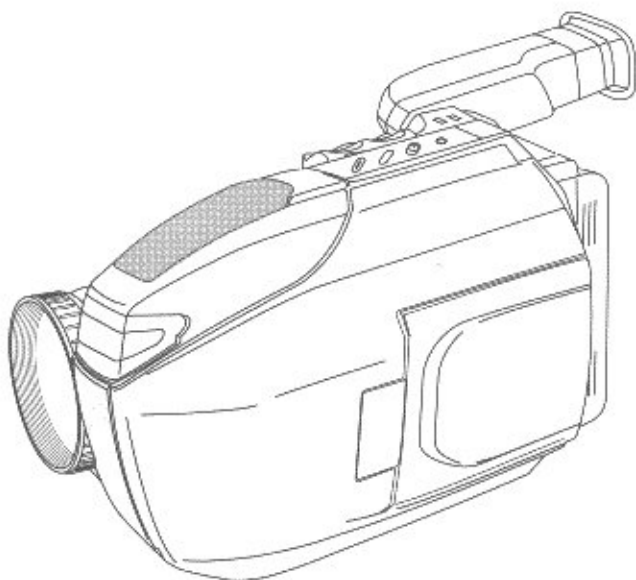

Please read these instructions carefully before attempting to operate this product.  
Please save this manual.

**Guía para rápida consulta en español está incluida.**

**For assistance, please call : 1-800-211-PANA(7262) or  
send e-mail to : [consumerproducts@panasonic.com](mailto:consumerproducts@panasonic.com)**

# Things You Should Know

## Thank you for choosing Panasonic!

You have purchased one of the most sophisticated and reliable products on the market today. Used properly, it will bring you years of enjoyment. Please take time to fill in the information at the right.

The serial number is on the tag located on the rear side of your Camcorder. Be sure to **retain this manual** as your convenient Camcorder information source.

Date of Purchase \_\_\_\_\_

Dealer Purchased From \_\_\_\_\_

Dealer Address \_\_\_\_\_

Dealer Phone No. \_\_\_\_\_

Model No. \_\_\_\_\_

Serial No. \_\_\_\_\_

## Unpack your Camcorder

These accessories are provided in order to set up or use your Camcorder.

1 pc. AC Adaptor  
(PV-A19) with DC Power  
Cable (page 9)

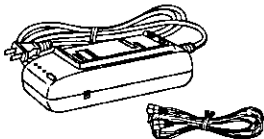

1 pc. Audio/Video Cable  
(LSJA0283/VJAW0032/  
VJAW0039) (pages 18, 19)



1 pc. Battery Pack  
(PV-BP15) (pages 8, 9)



1 pc. VHS PlayPak  
(PV-P1/YMW0009) and  
one "AA" battery (page 18)

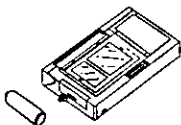

1 pc. Shoulder Strap  
(LSFC0012) (page 31)



1 pc. CR2025 Clock  
Battery (VSBW0004)  
(installed in Camcorder)  
(page 32)



## Battery Charging Confirmation Marker



Use this marker as a reminder to yourself when the battery is fully charged or in need of a charge. This marker performs no function and is for your reference only.

# Things You Should Know

Getting Started





## Safety Precautions

**WARNING : TO PREVENT FIRE OR SHOCK HAZARD, DO NOT EXPOSE THIS EQUIPMENT TO RAIN OR MOISTURE.**

Your Compact VHS Camcorder is designed to record and play back in Standard Play (SP) and Super Long Play (SLP) modes. You can also play a Compact VHS Camcorder recording on your VHS VCR using the VHS PlayPak supplied.

This Camcorder is equipped with the **HQ** System to provide excellent video pictures, and is compatible with standard VHS equipment.

It is recommended that only cassette tapes that have been tested and inspected for use in VCR machines with the **VHS-C** and/or **VHS** mark be used.

	<b>CAUTION</b> RISK OF ELECTRIC SHOCK DO NOT OPEN			This symbol warns the user that uninsulated voltage within the unit may have sufficient magnitude to cause electric shock. Therefore, it is dangerous to make any kind of contact with any inside part of this unit.
CAUTION: TO REDUCE THE RISK OF ELECTRIC SHOCK, DO NOT REMOVE COVER (OR BACK) NO USER-SERVICEABLE PARTS INSIDE REFER SERVICING TO QUALIFIED SERVICE PERSONNEL				This symbol alerts the user that important literature concerning the operation and maintenance of this unit has been included. Therefore, it should be read carefully in order to avoid any problems.

The above markings are located on the appliance's bottom cover.

**FCC Warning:** Any unauthorized changes or modifications to this equipment would void the user's authority to operate.

This device complies with Part 15 of the FCC Rules. Operation is subject to the following two conditions: (1) This device may not cause harmful interference, and (2) this device must accept any interference received, including interference that may cause undesired operation.

**Note:** This equipment has been tested and found to comply with Part 15 and part 18 of the FCC Rules. These limits are designed to provide reasonable protection against harmful interference when operated in a residential environment.

If this equipment does cause interference to radio or television reception, which can be determined by turning the equipment off and on, use the equipment in another location and/or utilize an electrical outlet different from that used by the receiver.

If necessary, consult the dealer or an experienced radio/TV technician for help. You may find the booklet, 'Something About Interference' available from FCC local regional offices helpful.

This product may cause interference to radio equipment and should not be installed near maritime safety communications equipment or other critical navigation or communication equipment operating between 0.45-30 MHz.

# Important Safeguards

- 1. Read Instructions** – All the safety and operating instructions should be read before the unit is operated.
- 2. Retain Instructions** – The safety and operating instructions should be retained for future reference.
- 3. Heed Warnings** – All warnings on the unit and in the operating instructions should be adhered to.
- 4. Follow Instructions** – All operating and maintenance instructions should be followed.
- 5. Cleaning** – Unplug this video unit from the wall outlet before cleaning. Do not use liquid or aerosol cleaners. Use a dry cloth for cleaning.
- 6. Attachments** – Do not use attachments not recommended by the video product manufacturer as they may be hazardous.
- 7. Water and Moisture** – Do not use this video unit near water – for example near a bath tub, wash bowl, kitchen sink, or laundry tub, in a wet basement, or near a swimming pool, and the like.
- 8. Accessories** – Do not place this video unit on an unstable cart, stand, tripod, bracket, or table. The video unit may fall, causing serious injury to a child or adult, and serious damage to the unit. Use only with a cart, stand, tripod, bracket, or table recommended by the manufacturer, or sold with the video unit. Any mounting of the unit should follow the manufacturer's instructions and should use a mounting accessory recommended by the manufacturer. An appliance and cart combination should be moved with care. Quick stops, excessive force, and uneven surfaces may cause the appliance and cart combination to overturn.
- 9. Ventilation** – Slots and openings in the cabinet are provided for ventilation and to ensure reliable operation of the video unit and to protect it from overheating. These openings must not be blocked or covered. Never place the video unit on a bed, sofa, rug, or other similar surface, or near or over a radiator or heat register. This video unit should not be placed in a built-in installation such as a bookcase or rack unless proper ventilation is provided or the manufacturer's instructions have been adhered to.
- 10. Power Sources** – This video unit should be operated only from the type of power source indicated on the marking label. If you are not sure of the type of power supply to your home, consult your appliance dealer or local power company. For video units intended to be operated from battery power, or other sources, refer to the operating instructions.



- 11. Grounding or Polarization** – This video unit may be equipped with either a polarized 2-wire AC (Alternating Current) line plug (a plug having one blade wider than the other) or 3-wire grounding type plug, a plug having a third (grounding) pin.

The 2-wire polarized plug will fit into the power outlet only one way. This is a safety feature. If you are unable to insert the plug fully into the outlet, try reversing the plug. If the plug still fails to fit, contact your electrician to replace your obsolete outlet. Do not defeat the safety purpose of the polarized plug.

The 3-wire grounding type plug will fit into a grounding type power outlet. This is a safety feature. If you are unable to insert the plug into the outlet, contact your electrician to replace your obsolete outlet. Do not defeat the safety purpose of the grounding type plug.

- 12. Power-Cord Protection** – Power-supply cords should be routed so that they are not likely to be walked on or pinched by items placed upon or against them. Paying particular attention to cords of plugs, convenience receptacles, and the point where they exit from the unit.
- 13. Outdoor Antenna Grounding** – If an outside antenna or cable system is connected to the video unit, be sure the antenna or cable system is grounded so as to provide some protection against voltage surges and built-up static charges. Part 1 of the Canadian Electrical Code, in USA Section 810 of the National Electrical Code, provides information with respect to proper grounding of the mast and supporting structure, grounding of the lead-in wire to an antenna discharge unit, size of grounding conductors, location of antenna discharge unit, connection to grounding electrodes, and requirements for the grounding electrode.

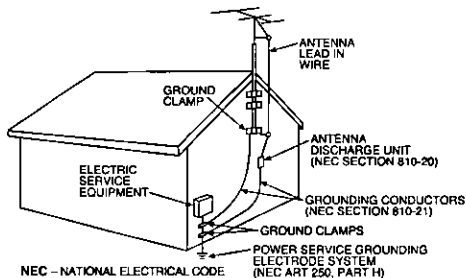

NEC - NATIONAL ELECTRICAL CODE

- 14. Lightning** – For added protection of this video unit receiver during a lightning storm, or when it is left unattended and unused for long periods of time, unplug it from the wall outlet and disconnect the antenna or cable system. This will prevent damage to the video unit due to lightning and power-line surges.

# Important Safeguards

15. **Power Lines** – An outside antenna system should not be located in the vicinity of overhead power lines or other electric light or power circuits, or where it can fall into such power lines or circuits. When installing an outside antenna system, extreme care should be taken to keep from touching such power lines or circuits as contact with them might be fatal.
16. **Overloading** – Do not overload wall outlets and extension cords as this can result in a risk of fire or electric shock.
17. **Objects and Liquids** – Never push objects of any kind into this video unit through openings as they may touch dangerous voltage points or short out parts that could result in a fire or electric shock. Never spill liquid of any kind onto the video unit.
18. **Servicing** – Do not attempt to service this video unit yourself as opening or removing covers may expose you to dangerous voltage or other hazards. Refer all servicing to qualified service personnel.
19. **Damage Requiring Service** – Unplug this video unit from the wall outlet and refer servicing to qualified service personnel under the following conditions:
  - a. When the power-supply cord or plug is damaged.
  - b. If any liquid has been spilled into, or objects have fallen onto, the video unit.
  - c. If the video unit has been exposed to rain or water.
  - d. If the video unit does not operate normally by following the operating instructions. Adjust only those controls that are covered by the operating instructions, as an improper adjustment of other controls may result in damage and will often require extensive work by a qualified technician to restore the video unit to its normal operation.
  - e. If the video unit has been dropped or the cabinet has been damaged.
  - f. When the video unit exhibits a distinct change in performance – this indicates a need for service.
20. **Replacement Parts** – When replacement parts are required, be sure the service technician has used replacement parts specified by the manufacturer or have the same characteristics as the original part. Unauthorized substitutions may result in fire, electric shock or other hazards.
21. **Safety Check** – Upon completion of any service or repairs to this video unit, ask the service technician to perform safety checks to determine that the video unit is in safe operating order.

## Precautions

### USE & LOCATION

- **TO AVOID SHOCK HAZARD ...** Your Camcorder and power supply should not be exposed to rain or moisture. Do not connect the power supply or operate your Camcorder if it gets wet. Your Camcorder has been designed for outdoor use, however it is not designed to sustain direct exposure to water, rain, sleet, snow, sand, dust, or a direct splashing from a pool or even a cup of coffee. This action could permanently damage the internal parts of your Camcorder. Do not attempt to disassemble this unit. There are no user serviceable parts inside. Unplug your Camcorder from the power supply before cleaning.
- **DO NOT AIM YOUR CAMCORDER AT THE SUN OR OTHER BRIGHT OBJECTS.**
- **DO NOT LEAVE THE CAMCORDER WITH THE EVF AIMED DIRECTLY AT THE SUN AS THIS MAY CAUSE DAMAGE TO THE INTERNAL PARTS OF THE EVF.**
- **DO NOT EXPOSE YOUR CAMCORDER TO EXTENDED HIGH TEMPERATURE ...** Such as, in direct sunlight, inside a closed car, next to a heater, etc... This action could permanently damage the internal parts of your Camcorder.
- **AVOID SUDDEN CHANGES IN TEMPERATURE ...** If the unit is suddenly moved from a cold place to a warm place, moisture may form on the tape and inside the unit.
- **DO NOT LEAVE YOUR CAMCORDER OR THE POWER SUPPLY TURNED ON WHEN NOT IN USE.**
- **STORAGE OF YOUR CAMCORDER ...** Store and handle your Camcorder in a manner that will not subject it to unnecessary movement (avoid shaking and striking). Your Camcorder contains a sensitive pick-up device which could be damaged by improper handling or storage.

### CARE

- **TO CLEAN YOUR CAMCORDER ...** Do not use strong or abrasive detergents when cleaning your Camcorder body.
- **TO PROTECT THE LENS ...** Do not touch the surface of the lens with your hand. Use a commercial camcorder lens solution and lens paper when cleaning the lens. Improper cleaning can scratch the lens coating.
- **TO PROTECT THE FINISH OF YOUR CAMCORDER ...** Before handling your Camcorder, make sure your hands and face are free from any chemical products, such as suntan lotion, as it may damage the finish.

# Table of Contents

## Getting Started

Things You Should Know .....	2~3
Important Safeguards .....	4~5
Precautions .....	5
Quick Operation Guide .....	7
Supplying Power (Battery Charge/Use/Refresh/Care, AC Adaptor, Car Battery Cord) ...	8~9
Cassette Information .....	10
Using MENU Mode .....	11
Setting the Clock (Time Zone, Auto Daylight Saving Time) .....	12~13

## Basic Operation

Camera Recording (Basic, Stand-by, Programmed Recording) .....	14~16
Playing Back Recordings (Basic Playback, Visual Search, Still Picture, Tracking, TV/VCR Playback) .....	17~18
Copying your Tapes (dubbing) .....	19

## Special Features

Four-Speed Power Zoom .....	20
Backlight .....	20
Focus (Auto/Manual Focus) .....	21
High Speed Shutter (Auto/Manual Shutter) .....	22
Auto Fade .....	23
Color Digital Fade .....	24
Digital Zoom .....	25
Digital Electronic Image Stabilization (E.I.S.) .....	25
Security Mode .....	26
Intelligent Titler (Auto/Manual Title, Phrase Title) .....	27~28

## For Your Information

Viewfinder/LCD Monitor Indications .....	29~30
Operation Notes (Using the Shoulder and Hand Straps, Cleaning EVF) .....	31
Replacing Clock Battery .....	32
Palmcorder Accessory System .....	33
Palmcorder Accessory Order Form .....	34
Specifications .....	35
Request for Service Notice .....	35
Before Requesting Service (Video Head Cleaning) .....	36
Warranty .....	37~38
Spanish Quick Use Guide/Guía Para Uso Rápido .....	39
Index .....	40

# Quick Operation Guide

## Charging the Battery Pack

Charge Battery Pack fully before operation (page 8).

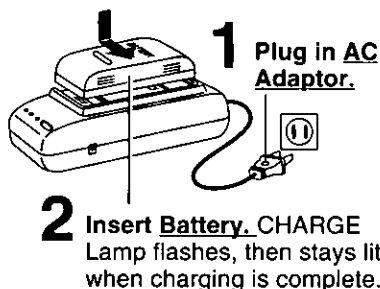

## Insert Cassette

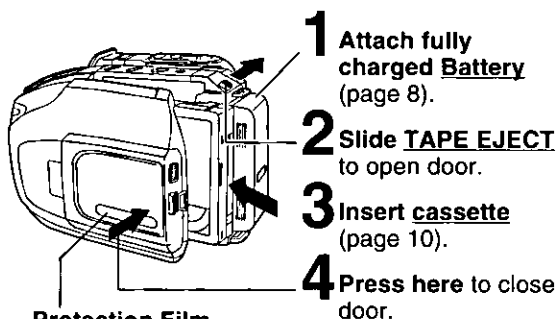

**Protection Film**  
**Note:**

- Remove the Protection Film before use.

## Camera Recording

When the LCD monitor is open, the EVF automatically turns OFF (page 14).

- 1** Press **LCD-OPEN** to unlock the LCD monitor. Swing it fully open and adjust the angle.

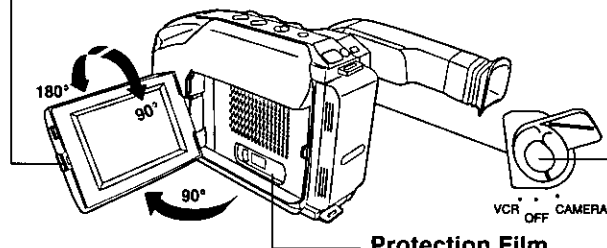

**Protection Film**  
**Note:**

- Remove the Protection Film before use.

## Playback using the LCD Monitor

When the LCD monitor is open, the EVF automatically turns OFF (page 17).

- 1** Press **LCD-OPEN** to unlock the LCD monitor. Swing it fully open and adjust the angle (see above).
- 2** Set **POWER** to **VCR**.

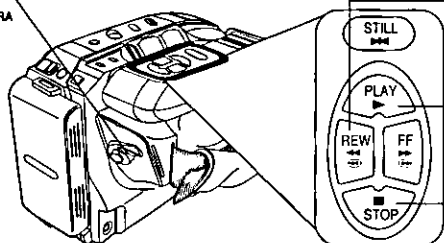
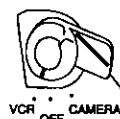

# Supplying Power

## Charging the Battery Pack

Charge Battery Pack fully before use.

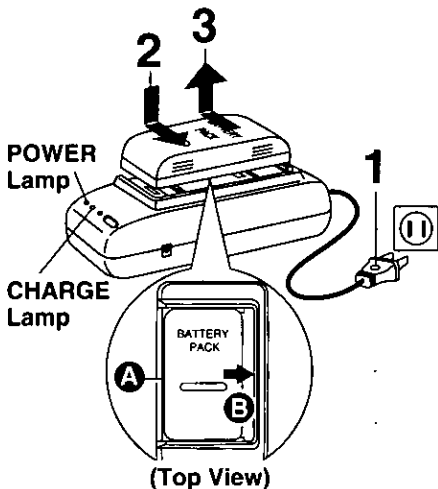

1

Plug in **AC Adaptor**.  
POWER Lamp lights.

2

Insert **Battery**.

- A Align left side of Battery with left edge of AC Adaptor.
- B Press Battery down and slide in direction of arrow.

The CHARGE Lamp flashes, then stays lit when charging is complete.

3

Remove **Battery**.

Slide Battery to the left and lift off.

**Note:**

- Charging takes about 1 hour.
- While the DC Power Cable (supplied) is connected to the AC Adaptor, the Battery cannot be charged.
- After charging 5 times, use Battery Refresh feature as explained below.
- Battery life gradually decreases after repeated use and recharging. If operation time becomes very short even after a sufficient charge, discard Battery properly (page 9).

## Using the Battery Pack

A fully charged Battery provides a maximum of about 1 hour 10 minutes of continuous use (LCD monitor off) or about 55 minutes (LCD monitor on). Actual time may vary due to operating conditions.

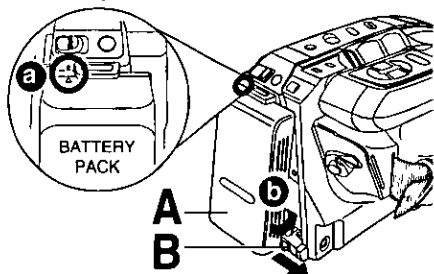

A

Attach **Battery**.

- a Insert top of Battery into top of mounting surface.
- b Press and snap into place.

B

Remove **Battery**.

Slide **BATTERY RELEASE** and remove Battery.

## Battery Refresh

This feature completely discharges Battery before recharging begins. Use after every 5 charges for optimum Battery performance.

REFRESH Lamp

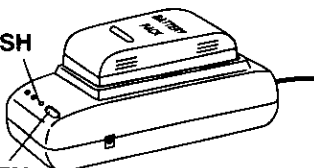

BATTERY REFRESH

To use battery refresh, insert Battery on AC Adaptor (see steps 1-2 above), then press **BATTERY REFRESH**.

The REFRESH Lamp lights, then goes out when discharge is complete. Battery charging will then start automatically.

If **BATTERY REFRESH** is pressed by mistake, remove Battery from AC Adaptor and reinsert it for normal charging.

**Note:**

- Charging takes about 5 hours when Battery Refresh is used.
- Battery will not operate in extremely high temperatures.



# Supplying Power

Getting Started

## Battery Care

### Caution:

- Charge only with specified charger.
- Battery can be charged within a temperature range of 10 °C (50 °F) and 35 °C (95 °F).
- Battery is normally warm after charging or just after use.
- Do not use an insufficiently charged or worn-out Battery.

### Safety precautions:

- Do not get Battery near, or dispose of in fire.
- Do not directly connect (short circuit) the positive (+) and negative (-) terminals.
- Never attempt to disassemble or reassemble Battery.

### To avoid Battery damage:

- Do not drop or jar Battery.
- Use Battery with specified units only.
- If Battery is used in extremely high temperatures, a safety device will automatically prevent operation.

### To prolong Battery life:

- While not in use, remove Battery from the Camcorder and AC Adaptor and store in a cool, dark, dry place.
- Keep Battery terminals clean.

## U.S.A. CONSUMERS: ATTENTION:



The product you have purchased is powered by a nickel cadmium battery which is recyclable. At the end of its useful life, under various state and local laws, it is illegal to dispose of this battery into your municipal waste stream. Please call 1-800-8-BATTERY for information on how to recycle this battery.

## AC Adaptor

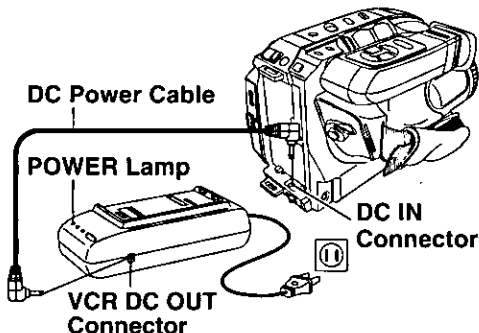

**1** Connect **AC Adaptor VCR DC OUT** to **Camcorder DC IN** with supplied DC Power Cable.

**2** Plug in AC Adaptor. POWER Lamp lights.

### Note:

- While the DC Power Cable (supplied) is connected to the AC Adaptor, the Battery cannot be charged.
- When not in use, unplug AC Adaptor from AC outlet. (Adaptor uses 1.2 W of electricity while plugged in.)

### CAUTION:

This unit will operate on 110/120/220/240 V AC. An AC plug adaptor may be required for voltages other than 120 V AC. Please contact either a local or foreign electrical parts distributor for assistance in selecting an alternate AC plug. We recommend using the accessory power plug adaptor (VJSS0070) in an area which has special AC outlets.

## Car Battery Cord (Optional)

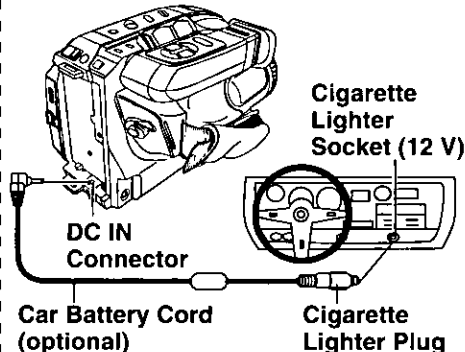

**1** Connect **PV-C16 Car Battery Cord (optional)** to **Camcorder DC IN**.

**2** **A** Start engine first.  
**B** Plug Car Battery Cord into Cigarette lighter socket.

- If Car Battery cord fuse needs replacing, use exact current rating (in amps).

### Note:

- This cord only works in vehicles equipped with **DC 12 V (negative ground)** battery. Check with your car/truck dealer. Use only specified car battery cord.
- To avoid blowing the car battery cord fuse, do step 2 in the proper order.
- Running vehicles must be well ventilated.
- When not in use, disconnect cigarette lighter plug.

# Cassette Information

## Cassette Insertion/Removal

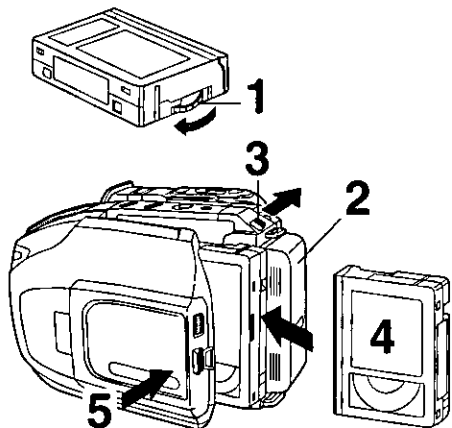

- 1 Turn **Tape Wheel** in direction of arrow until there is no slack.
- 2 Attach **Battery** (page 8).
- 3 Slide **TAPE EJECT** to open door.
- 4 Insert **cassette** as shown.
- 5 Press here to close door.

• To remove the cassette, slide the **TAPE EJECT** switch.

## Record/Playback Time

Use tapes with the **VHS** mark in this unit.

Tape Speed Selector Position	Cassette type		
	TC-20	TC-30	TC-40
SP (Standard Play)	20 minutes	30 minutes	40 minutes
SLP (Super Long Play)	1 hour	1 hour 30 minutes	2 hours

• SLP playback may contain more picture noise.

## Erase Protection Tab

Protects tapes from being accidentally erased.

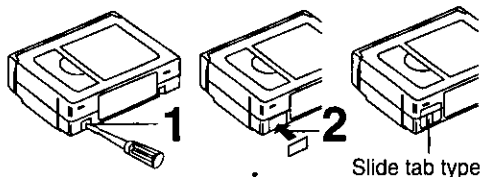

- 1 To prevent accidental erasing, break off tab with screwdriver. (Or, slide tab open.)
- 2 To record again, cover hole with adhesive tape. (Or, slide tab closed.)

# Using MENU Mode

## Before you begin...

- Connect Camcorder to power source.
- Set POWER to CAMERA or VCR.

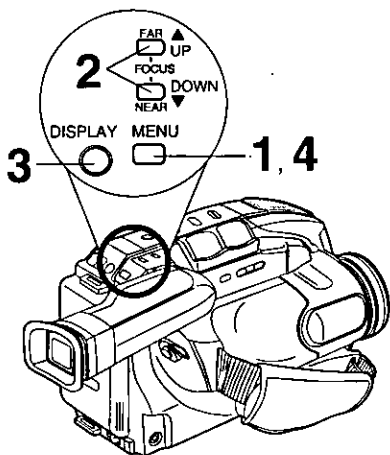

- 1** Press **MENU** for MENU mode.  
The CAMERA or VCR MENU screen (see below left) appears when Menu mode is entered.
- 2** Press **UP ▲** or **DOWN ▼** to highlight the desired menu item.
- 3** Press **DISPLAY** to set selection.
- 4** Press **MENU** to exit.

### Note:

- The Menu mode is canceled if **UP/DOWN(▲/▼)**, **DISPLAY**, or **MENU** are not pressed within 5 minutes.

## MENU Mode (CAMERA) Screen

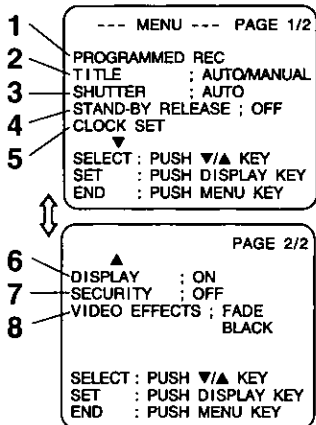

- 1 PROGRAMMED REC** (page 16).  
Camcorder starts and stops recording at a preset time.
- 2 TITLE** (pages 27, 28).  
AUTO/MANUAL : 16 items  
PHRASE : 10 items
- 3 SHUTTER** (page 22).  
Select desired shutter speed.
- 4 STAND-BY RELEASE** (page 15).  
ON: Enables quick resumption of recording from Stand-by mode.
- 5 CLOCK SET** (pages 12, 13).  
Select to set clock.
- 6 DISPLAY** (page 29).  
ON: On-screen Display (OSD) screens are displayed.
- 7 SECURITY** (page 26).  
ON: Enables Motion Security recording.
- 8 VIDEO EFFECTS** (pages 23, 24).  
AUTO FADE : BLACK or WHITE  
DIGITAL FADE : TYPE → 7 types  
COLOR → 8 colors

## MENU Mode (VCR) Screen

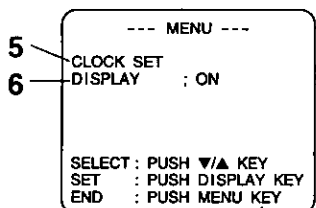

# Setting the Clock

Set the following items in order: Time Zone, Daylight Saving Time, Date, and Time.

## Before you begin...

- Connect Camcorder to power source.
- Set POWER to CAMERA or VCR.

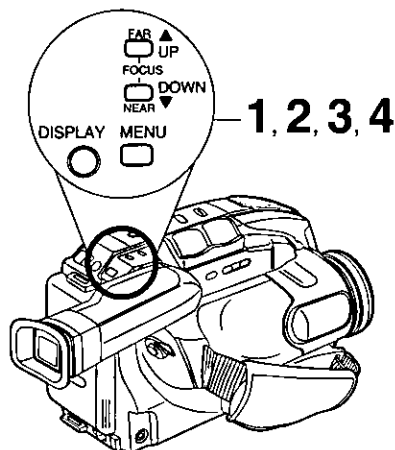

- 1** Press **MENU** for MENU mode.  
Press **UP ▲** or **DOWN ▼** to select **CLOCK SET**.

```
--- MENU --- PAGE 1/2
PROGRAMMED REC
TITLE      : AUTOMANUAL
SHUTTER    : AUTO
STAND-BY RELEASE : OFF
CLOCK SET
▼
SELECT : PUSH ▼/▲ KEY
SET     : PUSH DISPLAY KEY
END     : PUSH MENU KEY
```

[ CAMERA MODE ]

```
--- MENU ---
CLOCK SET
DISPLAY : ON
SELECT : PUSH ▼/▲ KEY
SET     : PUSH DISPLAY KEY
END     : PUSH MENU KEY
```

[ VCR MODE ]

- 2** Press **DISPLAY** for **CLOCK SET** menu.  
Press **UP ▲** or **DOWN ▼** to select **TIME ZONE**, **DST**, or **DATE/TIME**.

```
--- CLOCK SET ---
TIME ZONE : EASTERN
D.S.T.     : AUTO
DATE/TIME  : 12:00:00AM
              JAN 1 2001
SELECT : PUSH ▼/▲ KEY
SET     : PUSH DISPLAY KEY
END     : PUSH MENU KEY
```

- 3** Press **DISPLAY** for menu of item selected in step 2.

To change the setting:

**TIME ZONE** → Go to step 3a on page 13.

**D.S.T.** → Go to step 3b on page 13.

**DATE/TIME** → Go to step 3c on page 13.

- 4** Press **MENU** twice to exit.

# Setting the Clock

## 3a Setting the Time Zone

The Camcorder is preset to Eastern time.

### [ Time Zone chart ]

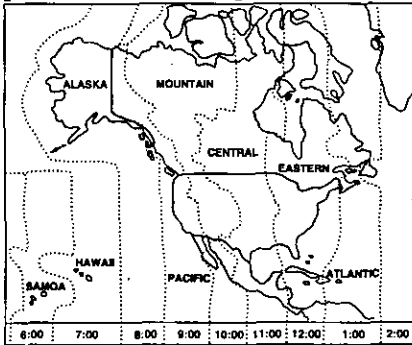

Press **UP ▲** or **DOWN ▼** to select local time zone.

Press **DISPLAY** to confirm entry.

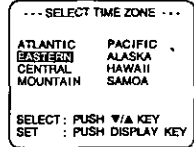

- When traveling, repeat this operation and select one of the 8 listed time zones to set the clock to local time.

### Note :

- Clock may lose or gain up to 2 minutes per month.
- When traveling outside the listed time zones, set clock to local time manually.
- To adjust or set clock, see "Setting Date and Time" bottom of page.

## 3b Auto Daylight Saving Time

Clock will auto-adjust to daylight saving time (DST).

**DST: AUTO**

**Spring (First Sunday in April) :**  
ahead one hour.

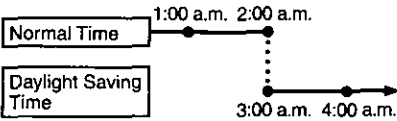

**Autumn (Last Sunday in October) :**  
back one hour.

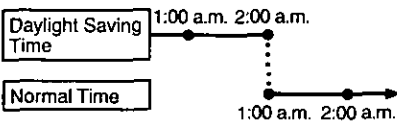

The Camcorder is preset to DST: **AUTO**. If DST is not observed in your area, set to **OFF** by doing the following.

Press **UP ▲** or **DOWN ▼** to select OFF or AUTO.

Press **DISPLAY** to confirm entry.

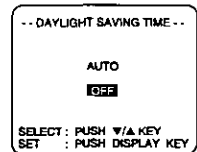

### Note:

- Auto DST does not function if time zone is set to Hawaii or Samoa (see "Setting the Time Zone" above).

## 3c Setting Date and Time

Date and time including leap year are calculated up to DEC 31, 2099.

**EXAMPLE :**

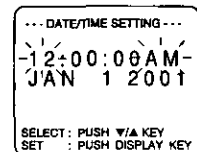
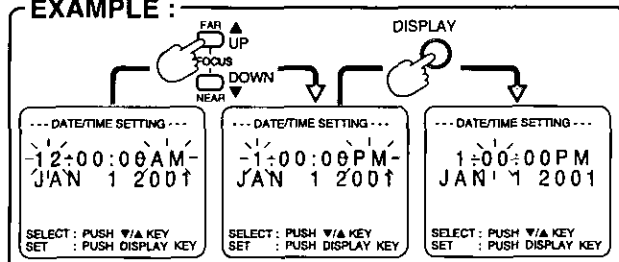

Press or hold down **UP ▲** or **DOWN ▼** to select hour, then press **DISPLAY** to fix.

Repeat for minute, month, day, and year.

Clock starts when year is entered and **DISPLAY** is pressed.

# Camera Recording

## Recording via EVF or LCD Monitor

View recording scene on EVF or LCD (Liquid Crystal Display) monitor.

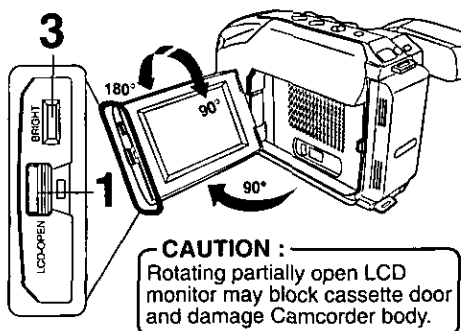

## 3 VISION ADJUSTMENT

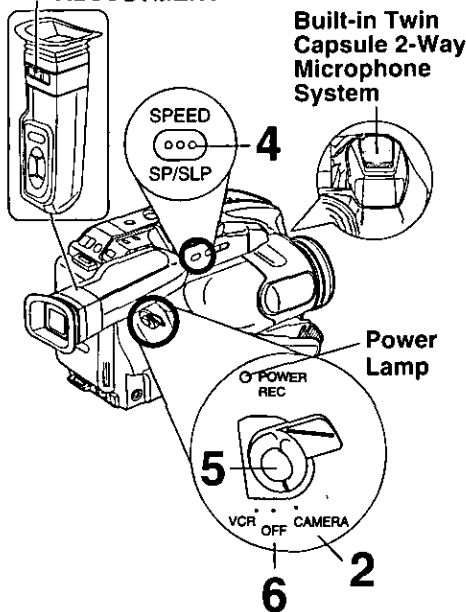

### Note:

- When Camcorder is aimed at excessively bright objects, or bright lights, a vertical bar may appear in the picture. This is normal for the CCD pick-up. Try to avoid this when possible.
- Using LCD monitor reduces battery operation time. Return LCD monitor to locked position when not in use.

## Before you begin...

- Connect Camcorder to power source.
- Insert cassette with record tab (page 10).

**1** Press **LCD-OPEN** to unlock the LCD monitor. **Swing LCD monitor fully open and adjust viewing angle.**

- If you want to record using EVF, close and lock LCD monitor.

**2** Set **POWER** to **CAMERA**.  
Lens Cover opens.  
Power Lamp lights.

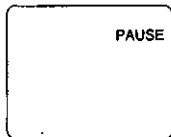

- Be sure **POWER** is fully turned to **CAMERA** position.
- EVF or LCD monitor turns on/off by the **POWER** switch.
- EVF shuts off when LCD monitor is opened and turns back on when LCD is closed.
- Both EVF and LCD monitor turn on when LCD is at 180° (see above left). This allows both you and the subject to view the recording.

**EVF or LCD Monitor**  
(Record/Pause mode)

**3** **LCD** : Turn **BRIGHT** control to **monitor** adjust LCD monitor brightness level.

**EVF** : Look into **EVF** and adjust **VISION ADJUSTMENT** to your eyesight.

**4** Hold down **TAPE SPEED** for about 1 second to change tape speed to **SP/SLP** (page 10).

**5** Press **RECORD/PAUSE** to start or pause recording.

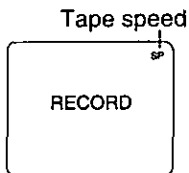

**6** Set **POWER** to **OFF** when finished.

**EVF or LCD Monitor**  
(Record mode)

- To remove the cassette, slide the **TAPE EJECT** switch (page 10).

## WARNING:

- Do not leave the camcorder with the EVF aimed directly at the sun. This may cause damage to the internal parts of the EVF.

# Camera Recording

## Before you begin...

- Connect Camcorder to power source.
- Insert cassette with record tab (page 10).

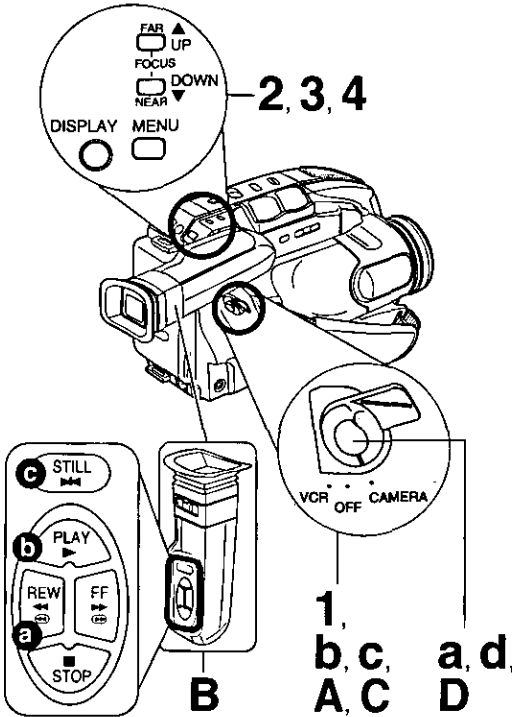

## Stand-by Quick Release

If left in RECORD/PAUSE mode for 5 minutes, Camcorder switches to Stand-by mode to conserve battery. When set to ON, Stand-by Quick Release lets you resume recording by pressing RECORD/PAUSE two times. Stand-by Quick Release is set to OFF at the factory.

**1** Set **POWER** to **CAMERA**.

**2** Press **MENU** for **MENU** mode.  
Press **UP ▲** or **DOWN ▼** to select

```
--- MENU --- PAGE 1/2
PROGRAMMED REC
TITLE          : AUTOMANUAL
SHUTTER        : AUTO
STANDBY RELEASE : OFF
CLOCK SET
SELECT : PUSH ▼/▲ KEY
SET     : PUSH DISPLAY KEY
END     : PUSH MENU KEY
```

### STAND-BY RELEASE

**3** Press **DISPLAY** to select ON/OFF.

**ON** : From Stand-by mode, press **RECORD/PAUSE** two times to resume recording.

**OFF** : From Stand-by mode, set **POWER** to **OFF**, then to **CAMERA**. Press **RECORD/PAUSE** to record.

**4** Press **MENU** to exit.

Basic Operation

## Manual Easy Editing

For proper continuity when taping from Stop mode or after attaching a new Battery.

**A** Set **POWER** to **VCR**.

**B** **a** Press **REWIND/SEARCH** to rewind a few seconds of tape.

**b** Press **PLAY** to review recording.

**c** Press **STILL** where you want to continue recording.

**C** Set **POWER** to **CAMERA**.

**D** Press **RECORD/PAUSE** to resume recording.

## Easy Edit Stand-by

For a smooth transition between scenes if recording is stopped, and then started within 24 hours.

**a** Press **RECORD/PAUSE** to stop recording.

**b** Set **POWER** to **OFF** and leave cassette in Camcorder.

**C** To resume recording, set **POWER** to **CAMERA**.

**d** Press **RECORD/PAUSE** to resume recording.

### Note:

- Use Manual Easy Edit (left) if more than 24 hours before recording is resumed.

# Camera Recording

## Programmed Recording

Set a recording start and stop time. Or, set a 5 or 10 second interval recording to be done each minute.

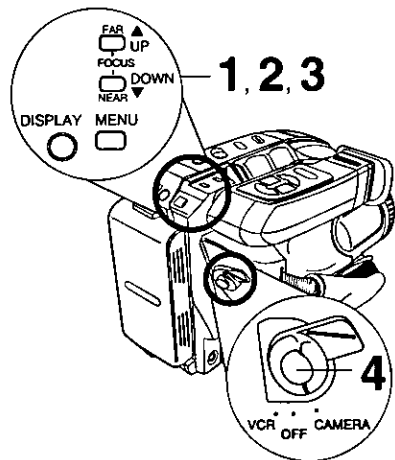

### Before you begin...

- Connect Camcorder to power source.  
Use AC Adaptor for longer recordings.
- Insert cassette with record tab (page 10).
- Set POWER to CAMERA.

**1** Press **MENU** for MENU mode. Press **UP ▲** or **DOWN ▼** to select **PROGRAMMED REC.**

```
--- MENU --- PAGE 1/2
PROGRAMMED REC
TITLE      : AUTOMANUAL
SHUTTER    : AUTO
STAND-BY RELEASE : OFF
CLOCK SET
↓
SELECT : PUSH  $\nabla/\blacktriangle$  KEY
SET     : PUSH DISPLAY KEY
END     : PUSH MENU KEY
```

**2** Press **DISPLAY**.  
(Current time is displayed.)  
Each additional press of **DISPLAY** increases start time by 30 minutes.

```
START : 10:20PM
REC TIME : 10MIN.

SELECT : PUSH  $\nabla/\blacktriangle$  KEY
SET     : PUSH DISPLAY KEY
START   : PUSH RECORD KEY
CANCEL : PUSH MENU KEY

10:20:00PM
```

**3** Press **DOWN ▼** to select **REC TIME**. Press **DISPLAY** repeatedly to select one of the options shown at left.

```
START : 10:20PM
REC TIME : 10MIN.

SELECT : PUSH  $\nabla/\blacktriangle$  KEY
SET     : PUSH DISPLAY KEY
START   : PUSH RECORD KEY
CANCEL : PUSH MENU KEY

10:20:00PM
```

To cancel the setup, press **MENU** twice.

**4** Press **RECORD/PAUSE** to place Camcorder in stand-by mode.

```
STAND-BY
START : 10:20PM
REC TIME : 10MIN.

10:20:00PM
JUN 1 2001
```

Recording will be done as scheduled.

### Note:

- Start time may not be set over 24 hours from current time.
- Camcorder shuts off at tape end, or 12 hours after Interval Recording starts.
- To cancel, set **POWER** to **OFF**.

**REC TIME :**

→ 10MIN. → 20MIN. → 30MIN. →  
INTERVAL\*2 ← INTERVAL\*1 ← TO TAPE ←  
10 SEC/MIN. ← 5 SEC/MIN. ← END

\*1 Record 5 seconds each minute.  
\*2 Record 10 seconds each minute.



# Playing Back Recordings

## Before you begin...

- Connect Camcorder to power source.
- Insert recorded tape.

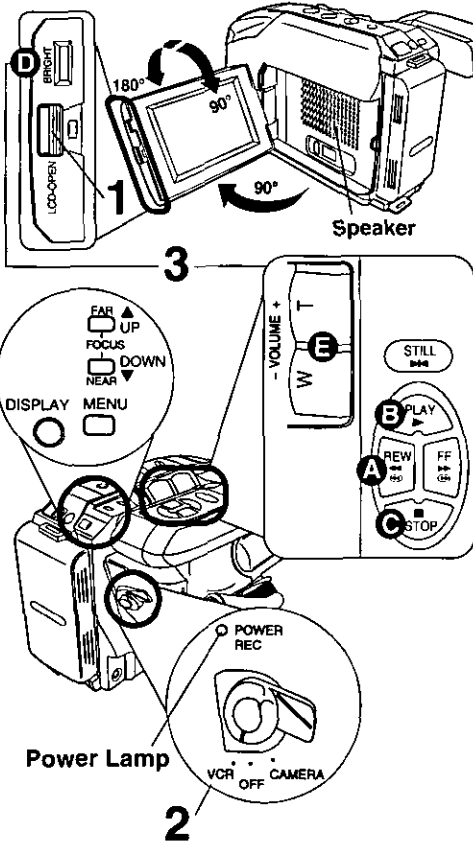

## Playback on EVF or LCD Monitor

- 1** Press **LCD-OPEN** and swing LCD monitor fully open.
  - If you want to playback on EVF, close and lock LCD monitor.
- 2** Set **POWER** to **VCR**. Power Lamp lights.
  - If tape has no record tab, auto playback begins.
  - EVF or LCD monitor turns on/off by the **POWER** switch.
  - EVF shuts off when LCD monitor is opened and turns back on when LCD is closed.
- 3** Playback function buttons.
  - A REW** : Rewind tape.
  - B PLAY** : Play tape.
  - C STOP** : Stop tape.
  - D BRIGHT** : Adjust LCD monitor brightness.
  - E VOLUME** : Adjust volume of speaker.
    - Press "T" : Volume up (+).
    - Press "W" : Volume down (-).

Basic Operation

### Note:

- Using LCD monitor reduces battery operating time.
- Return LCD monitor to locked position when not in use.

## Special Effects

### Quick Visual Search

#### Search Speed

- SP (Standard Play) : 3 times normal.
- SLP (Super Long Play) : 9 times normal.

#### During playback, press:

- **FF** : fast forward search
- **REW** : rewind search
  - Press again or press **PLAY** for normal play.

### Still Picture

Press **STILL** to freeze picture.

Press again for normal play.

This feature works best in SLP mode (page 10).

### Note:

- During search, horizontal noise bars will appear. Audio is muted.
- To protect video heads and tape, operating modes will revert as follows after 5 minutes:
  - Still → Stand-by
  - Stand-by → Power off (when Battery Pack is used).
- Tape auto-rewinds if played or fast forwarded to end.

## Tracking Control

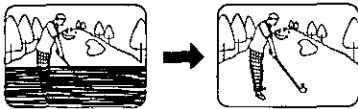

### Auto Tracking

Continuously analyzes each recording for optimum picture quality.

### Manual Tracking

Some recordings require manual adjustment to reduce noise.

Press **UP ▲** or **DOWN ▼** until Playback picture clears up.

Press **DISPLAY** to return to Auto Tracking.

# Playing Back Recordings

## TV Playback or Viewing

Connect Camcorder to a TV to view playback or recordings in progress.

### Connections

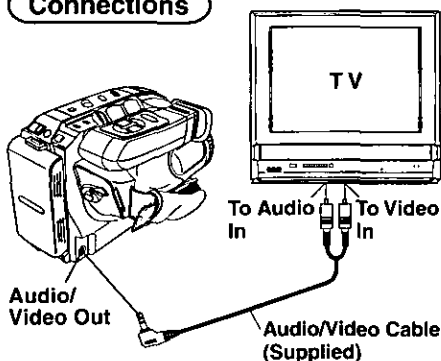

## Before you begin...

- Connect Camcorder to power source.
- Make all TV-Camcorder connections.

**1** Set **POWER** to:  
**VCR** → view playback.  
**CAMERA** → view picture as it is recorded.

**2** Turn **TV ON** and set to **LINE INPUT**.  
See TV owner's manual.

**3** Begin playback or recording.

## CATV System Installer

This reminder is provided to call the CATV system installer's attention to Article 820-40 of the NEC in USA (and to the Canadian Electrical Code in Canada) that provides guidelines for proper grounding and, in particular, specifies that the cable ground shall be connected to the grounding system of the building, as close to the point of cable entry as practical.

## VCR Playback using PlayPak

### 1 Load Battery in PlayPak

Remove Battery lid and insert AA battery.

- Do not reverse polarity.
- Replace battery when tape loading/unloading takes longer than usual.

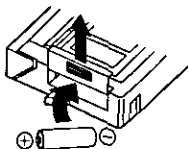

### 2 Insert VHS Cassette in PlayPak

- a** Turn **VHS** cassette **Tape Wheel** in direction of arrow to take up any slack.
- b** Slide **RELEASE** to open cassette lid.
- c** Insert the **VHS** cassette with the window up and on the left, then snap lid shut.

- Do not obstruct cassette reel while loading.
- Allow PlayPak Load Detector to fully retract before using in VHS VCR.

### 3 Remove VHS Cassette

- a** Slide **RELEASE** and wait for lid to open.
- b** Push cassette out through hole in bottom of PlayPak with your finger.

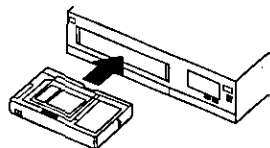

# Copying your Tapes (dubbing)

## Connections

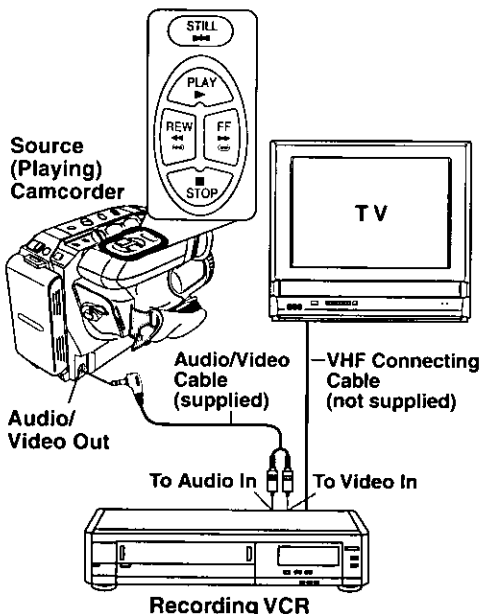

## Before you begin...

- Make Camcorder-VCR connections (see left).
- Turn both units on.
- Set VCR input signal to LINE.  
Please see VCR owner's manual.
- Set Camcorder POWER to VCR.

- 1** Insert a **pre-recorded tape** into Camcorder and a blank tape with record tab into VCR.
- 2** Press **PLAY** on Camcorder, then press **STILL** at starting point.
- 3** Press **REC**, then **STILL/PAUSE** on VCR.
- 4** Press **STILL** on Camcorder and **STILL/PAUSE** on VCR to start copying.
- 5** Press **STOP** on both units to stop copying.

## Note:

- Camcorder will only playback tapes recorded in SP or SLP mode.
- Dubbing may reduce picture quality.

## Monitor with your TV

- Turn TV on and tune to VCR channel (CH3 or CH4).
- Set TV/VCR Selector on VCR to VCR.

## CAUTION:

Unauthorized exchanging and/or copying of copyrighted recordings may be copyright infringement.

Basic Operation

# Four-Speed Power Zoom

Zoom in (close up) and out (wide angle) in one of four speeds ranging from slow (16 seconds) to fast (2 seconds).

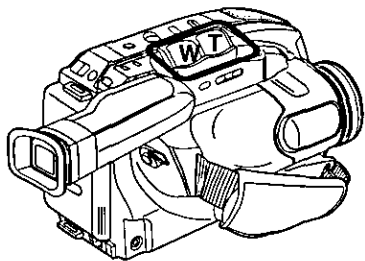

## Before you begin...

- Connect Camcorder to power source.
- Set POWER to CAMERA.

## Zoom In ("T")



## Zoom Out ("W")

### • Zoom slowly:

Lightly press "T" (telephoto) or "W" (wide angle) POWER ZOOM button.

### • Zoom quickly:

Apply more pressure to the button.

---

# Backlight

Use when subject is darker than surroundings, in shadowed area, or in front of the light source.

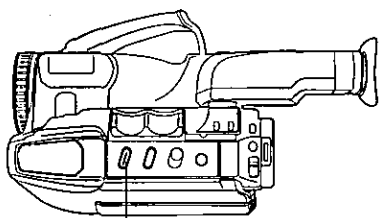

BACKLIGHT

## Before you begin...

- Connect Camcorder to power source.
- Set POWER to CAMERA.

Press **BACKLIGHT** while recording to select the level of backlight compensation.

In normal lighting, press **BACKLIGHT** repeatedly until no indicator is displayed.

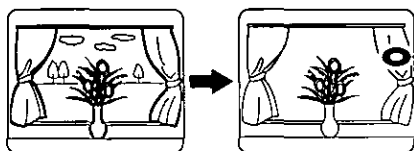

Press BACKLIGHT.

## EVF or LCD Monitor

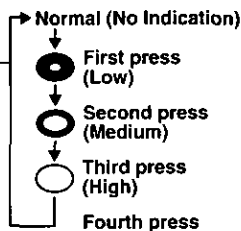

## Before you begin...

- Connect Camcorder to power source.
- Set POWER to CAMERA.

## Auto Focus

Camcorder automatically focuses on subject even during zooming.

Auto Focus is on when "MF" is not displayed in EVF or LCD monitor.

Press **MANUAL FOCUS** to remove "MF" in EVF or LCD monitor if necessary.

## Manual Focus

Use Manual Focus (MF) when :

- recording through glass.
- lighting is poor.
- subject is far away with objects in foreground.
- subject has distinct horizontal lines.
- subject is not centered in EVF or LCD monitor.
- subject has a shiny surface.
- subject is slanted.
- subject is bright and flat, like a white wall.
- subject has fast motion, like a golf swing.

EVF or LCD Monitor

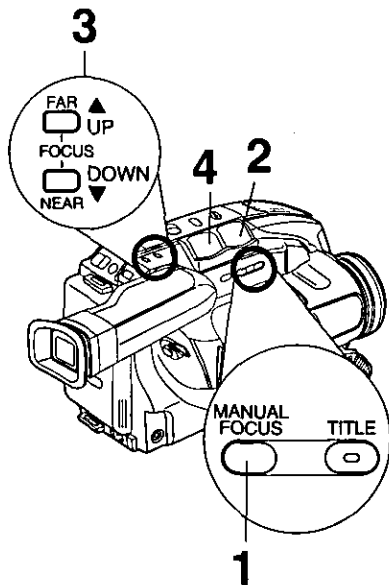
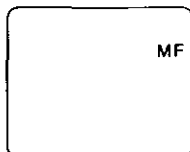

**1** Press **MANUAL FOCUS** so "MF" (Manual Focus) appears in EVF or LCD monitor.

**2** Hold down "**T**" (**telephoto**) on **POWER ZOOM** to maximum zoom in.

**3** Press **UP ▲ (FAR)** or **DOWN ▼ (NEAR)** until subject is in focus.  
• Back away from subject if necessary.

**4** Hold down "**W**" (**wide angle**) on **POWER ZOOM** as desired.

• Refocus as needed when aiming at new scenes.

Special Features

## Macro Focus (close-ups)

Auto Focus functions up to 12.7 mm (1/2 inch) from subject.

Hold down "**W**" on **POWER ZOOM** to maximum wide angle.

Bring Camcorder up close to the subject.

# High Speed Shutter

Improves Still or Slow Motion playback picture of high speed subjects (e.g. a tennis stroke), when viewed on Camcorder or 3 or 4 head VCR.

## Before you begin...

- Connect Camcorder to power source.
- Insert cassette with record tab (page 10).
- Set POWER to CAMERA.

## Auto Shutter

In AUTO mode (no indication in EVF or LCD Monitor), shutter speed is auto-adjusted from 1/60 to 1/350 according to subject brightness.

- AUTO mode is selected each time POWER is set to CAMERA.

## Manual Selection

The faster the shutter speed, the more light is needed for proper picture and color quality. High Speed Shutter indication flashes if light is inadequate. Provide additional light.

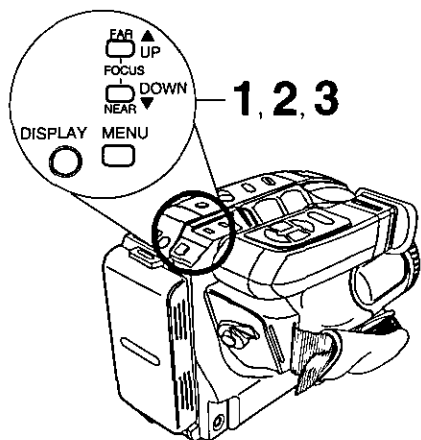

- 1 Press **MENU** for MENU mode. Press **UP ▲** or **DOWN ▼** to select **SHUTTER**.

- 2 Press **DISPLAY** repeatedly to select shutter speed.

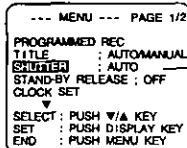

→ AUTO → 1/60 → 1/100 → 1/250 → 1/500  
1/10000 ← 1/4000 ← 1/2000 ← 1/1000 ←

- 3 Press **MENU** to exit.

### Note:

- Provide additional halogen or tungsten light for use indoors or in poor light. Fluorescent light degrades picture.
- Auto Focus may not function properly if high speed shutter is used in inadequate light.
- Setting reverts to AUTO each time POWER is set to CAMERA.

# Auto Fade

An interesting way to open and close scenes.

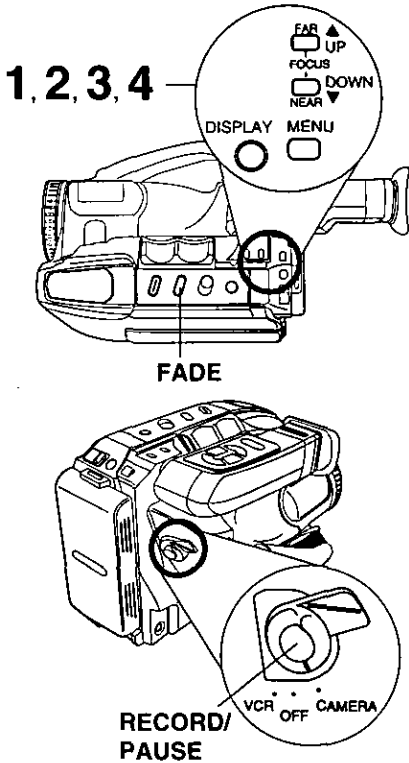

## Before you begin...

- Connect Camcorder to power source.
- Set POWER to CAMERA.

**1** Press **MENU** for MENU mode.  
Press **UP ▲** or **DOWN ▼** to select **VIDEO EFFECTS**.

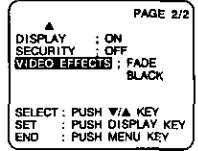

**2** Press **DISPLAY** for VIDEO EFFECTS menu.  
Press **UP ▲** or **DOWN ▼** to select **AUTO FADE**.

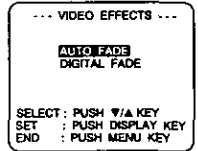

**3** Press **DISPLAY** for AUTO FADE ; COLOR menu.  
Press **UP ▲** or **DOWN ▼** to select BLACK or WHITE.

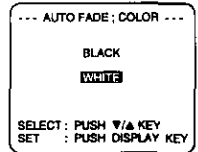

**4** Press **DISPLAY** to confirm entry.  
Press **MENU** to exit.

## Fade In:

In **RECORD/PAUSE** mode, press **FADE** so "FADE" flashes in EVF or LCD monitor.

Press **RECORD/PAUSE**.

Recording starts as picture and sound gradually fade in.

## Fade Out:

While recording, press **FADE** so "FADE" flashes in EVF or LCD monitor.

Press **RECORD/PAUSE**.

Picture and sound gradually fade out, and recording is paused.

If **FADE** is pressed accidentally, press again so "FADE" disappears in EVF or LCD monitor.

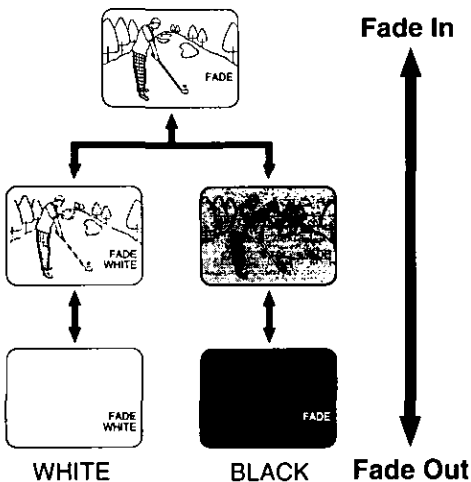

Special Features

# Color Digital Fade

Choose from 7 fade effects in 8 different colors.

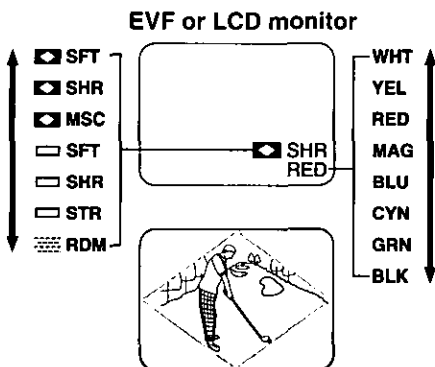
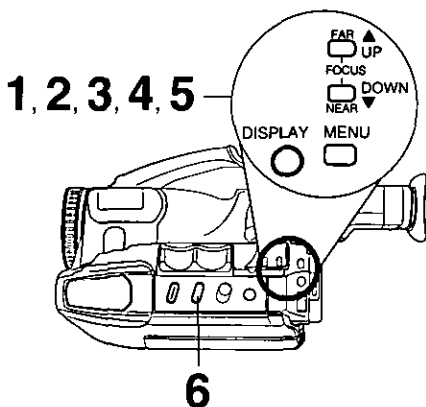

■ For more effects, stop fade in or fade out at any time (except RANDOM mode) by pressing **FADE**. Then, press **FADE** to resume fade.

## Note:

- Audio is not affected by fade.
- To cancel Digital Fade, do steps 1, 2, and 5. In step 2, select AUTO FADE.

## Before you begin...

- Connect Camcorder to power source.
- Set **POWER** to **CAMERA**.

**1** Press **MENU** for **MENU** mode.

Press **UP ▲** or **DOWN ▼** to select **VIDEO EFFECTS**.

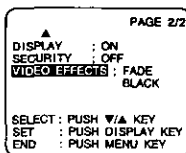

**2** Press **DISPLAY** for **VIDEO EFFECTS** menu. Press **DOWN ▼** to select **DIGITAL FADE**.

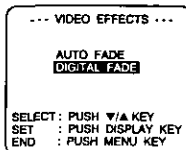

**3** Press **DISPLAY** for **DIGITAL FADE** menu. Press **UP ▲** or **DOWN ▼** to select **TYPE**. Press **DISPLAY** for **TYPE** menu. Press **UP ▲** or **DOWN ▼** to select from 7 different types of fades.

- A preview of each fade type is displayed as it is selected.

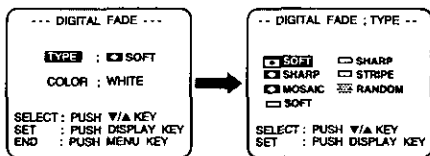

**4** Press **DISPLAY** for **DIGITAL FADE** menu. Press **DOWN ▼** to select **COLOR**. Press **DISPLAY** for **COLOR** menu. Press **UP ▲** or **DOWN ▼** to select from 8 colors.

- A preview of each color is displayed as it is selected.

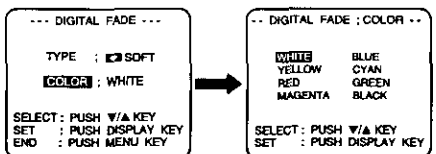

**5** Press **DISPLAY** to confirm entry. Press **MENU** twice to exit.

**6** Press **FADE** for about 2 seconds to fade out during recording (selected fade type flashes). Press **FADE** again to fade in.



# Digital Zoom

Power Zoom magnification is digitally increased.

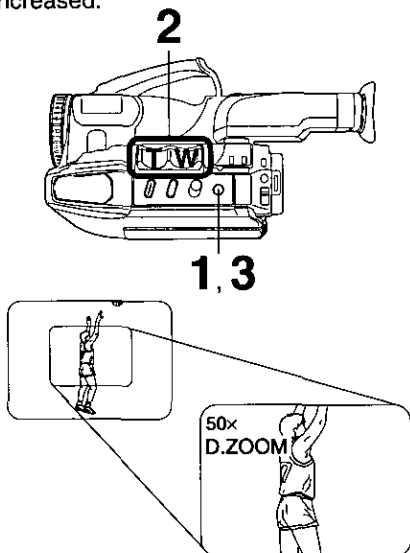

## Before you begin...

- Connect Camcorder to power source.
- Set POWER to CAMERA.

**1**

Press **D. ZOOM**.

Digital Zoom mode (150x maximum).

The Higher digital magnification levels may cause picture distortion.

**2**

Hold down **"T"** on **POWER ZOOM**.

Digital Zoom starts when normal zoom reaches maximum (20x).

- Zoom level appears in EVF or LCD monitor.
- POWER ZOOM switch controls digital zoom level.
- Normal zoom resumes when level falls to 20x.

**3**

Press **D. ZOOM** to turn off Digital Zoom so no indication appears.

# Digital Electronic Image Stabilization (E.I.S.)

Helps stabilize picture when recording in unstable situations.

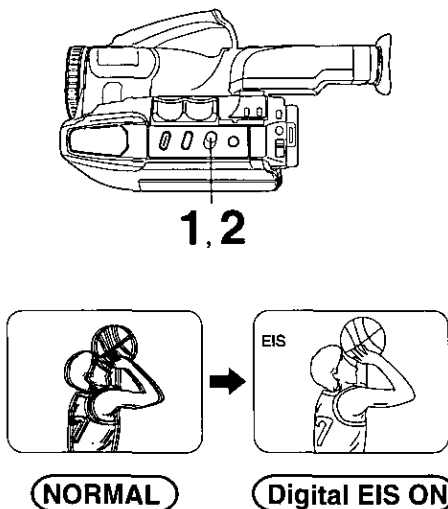

## Before you begin...

- Connect Camcorder to power source.
- Set POWER to CAMERA.

**1**

Press **EIS** to display "EIS" in the EVF or LCD monitor.

- Image becomes slightly enlarged and shutter speed auto-adjusts from 1/80 to 1/350 according to brightness.
- Use High Speed Shutter (page 22) if needed. Shutter speed setting remains after EIS is canceled.

**2**

Press **EIS** again to cancel when not in use.

## E.I.S. may not function during...

- extreme Camcorder movement.
- recording of subjects with distinct horizontal or vertical stripes.
- low light situations (EIS indicator flashes).
- intense fluorescent lighting situations.
- recording of very fast motion.

# Security Mode

Recording starts automatically if motion is detected.

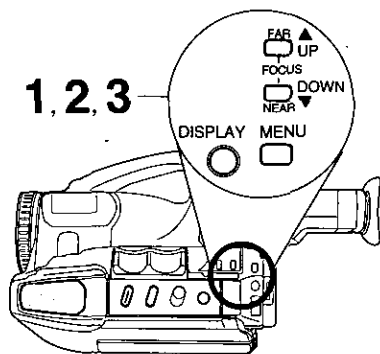

## Before you begin...

- Connect Camcorder to power source.  
Use AC Adaptor for longer recordings.
- Insert cassette with record tab (page 10).
- Set POWER to CAMERA.
- Securely position and aim Camcorder.

- 1 Press **MENU** for MENU mode.  
Press **UP ▲** or **DOWN ▼** to select **SECURITY**.

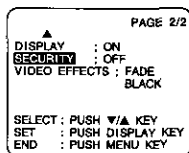

- 2 Press **DISPLAY** to select ON.

- 3 Press **MENU** for Motion Security stand-by mode. (If cassette is not inserted, "1.2" will flash.)

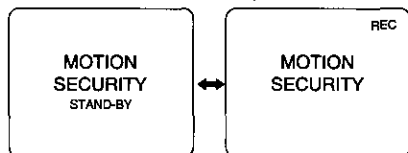

- Recording will start about 3 seconds after motion is detected.
- Date and time are recorded if displayed in EVF or LCD monitor (page 14).
- Recording stops about 30 seconds after motion ceases.

To cancel Security Mode, set **POWER to OFF**.

## Motion Security may mistakenly start when:

- background is plain, like a white wall, or has distinct vertical, horizontal, or slanted stripes, like a venetian blind.
- brightness suddenly changes.

## Motion Security may not start when:

- motion is very slow or fast.
- moving object is very small.
- motion occurs only in 1 corner of viewing area.
- in poor lighting (in this case, MOTION SECURITY flashes).
- background is plain, like a white wall, or has distinct horizontal or vertical stripes.

## Note:

- Security recording starts if Camcorder is bumped or repositioned.
- This feature is not available during normal recording.
- While in Motion Security stand-by, the following functions are not available: Record/Pause, Stand-by mode, Digital E.I.S., Video Effects (Auto/Digital Fade).

## Automatic Title

Camcorder auto-displays title greeting on selected holidays when power is first turned on. See title list below.

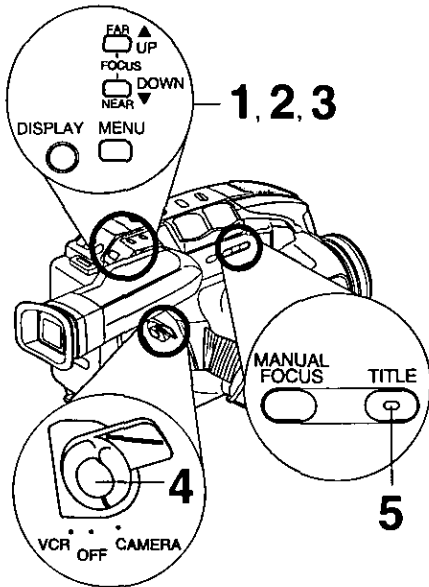

## Before you begin...

- Connect Camcorder to power source.
- Insert cassette with record tab (page 10).
- Set POWER to CAMERA.

- 1 Press **MENU** for MENU mode.  
Press **UP ▲** or **DOWN ▼** to select **TITLE**.

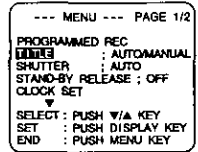

- 2 Press **DISPLAY** to select AUTO/MANUAL.

- 3 Press **MENU** to exit.

- 4 To record the title, press **RECORD/PAUSE**.

- 5 Press **TITLE** while recording to remove title.

### Note:

- Once removed, title will not be auto-displayed. To redisplay, or select from other titles, use Manual Title (see below).

## Automatic/Manual Title Display List

Dec. 31–Jan. 1	HAPPY NEW YEAR! / CHEERS!
Feb. 14	VALENTINE'S DAY / BE MY VALENTINE
2nd Sunday in May	HAPPY MOTHER'S DAY / WE LOVE YOU!
Last Monday in May	MEMORIAL DAY
3rd Sunday in Jun.	HAPPY FATHER'S DAY / WE LOVE YOU!
Jul. 4	INDEPENDENCE DAY
1st Monday in Sep.	LABOR DAY
Oct. 31	HAPPY HALLOWEEN
4th Thursday in Nov.	HAPPY THANKSGIVING
Dec. 24–25	MERRY CHRISTMAS / HO! HO! HO!
These Titles must be displayed manually.	HAPPY EASTER HAPPY ANNIVERSARY HAPPY BIRTHDAY VACATION WEDDING DAY A SPECIAL DAY

EVF or LCD Monitor

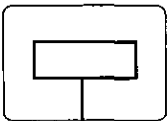

Automatic/Manual Title Display

# Intelligent Titler

## Before you begin...

- Connect Camcorder to power source.
- Insert cassette with record tab (page 10).
- Set POWER to CAMERA.

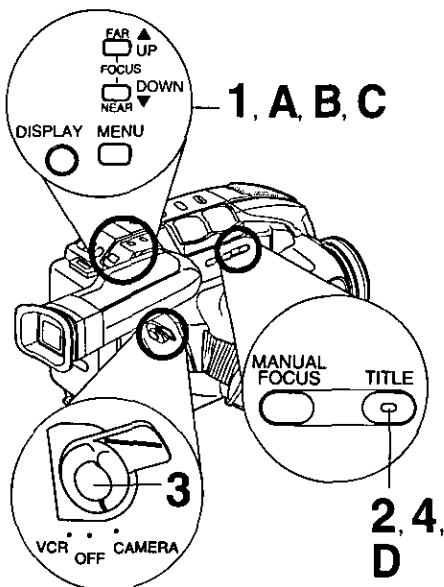

## Manual Title:

- 1 Confirm that **TITLE**: AUTO/MANUAL is set in Menu mode (steps 1-3, page 27).

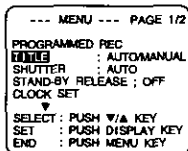

- 2 In Record/Pause mode, press **TITLE** repeatedly to display titles from list on page 27.
- 3 To record the title, Press **RECORD/PAUSE**.
- 4 Press **TITLE** while recording to remove title.

### Note:

- To redisplay title, press **TITLE** in Record/Pause mode.

## Phrase Title

- A Press **MENU** for MENU mode. Press **UP ▲** or **DOWN ▼** to select **TITLE**.

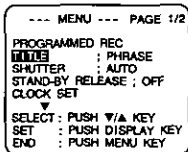

### Phrase Title Display

EVF or LCD Monitor



(no indication)  
 ↓  
 BEAUTIFUL  
 ↓  
 BRAVO!  
 ↓  
 CHEERS!  
 ↓  
 CONGRATULATIONS  
 ↓  
 GIMME A BREAK!  
 ↓  
 GOOD LUCK  
 ↓  
 I LOVE YOU  
 ↓  
 OOPSI!  
 ↓  
 OUR LITTLE ANGEL  
 ↓  
 WAY TO GO

- B Press **DISPLAY** to select PHRASE.
- C Press **MENU** to exit.
- D In Record/Pause mode, press **TITLE** repeatedly to display phrases from the list at left.
- E Do steps 3, 4 above to record and remove phrase.

### Note:

- To redisplay phrase, press **TITLE** in Record/Pause mode.

# Viewfinder/LCD Monitor Indications

Tape remaining and battery charge level can be displayed.

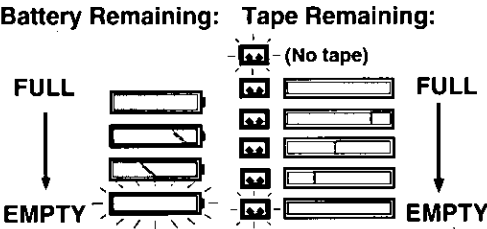
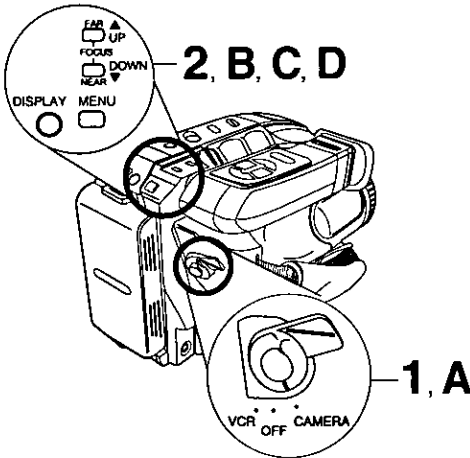

## Before you begin...

- Connect Camcorder to power source.

- 1 Set **POWER** to **CAMERA**.
- 2 Press **DISPLAY** repeatedly to select the following displays.

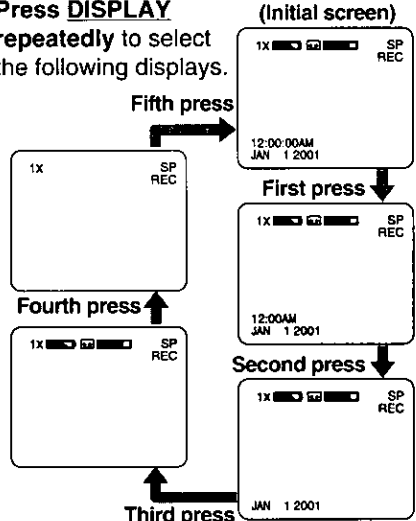

- Tape remaining indicator operates a few seconds after tape starts moving.

## Recording the Date and Time

- 1 Do steps 1 and 2 above to select time/date, date only, or no display.
- 2 Start a recording (page 14).
  - Only the Date and/or Time are recorded.

## Display-Off Mode

No Indication, except Intelligent Titler (pages 27, 28), will be displayed.

- A** Set **POWER** to **CAMERA** or **VCR**.
- B** Press **MENU** for **MENU** mode.  
Press **UP ▲** or **DOWN ▼** to select **DISPLAY**.
- C** Press **DISPLAY** to select **OFF**.  
Press **MENU** to exit.
- D** Press **DISPLAY** repeatedly to remove time/date.

Indications are restored the next time Camcorder is turned on.

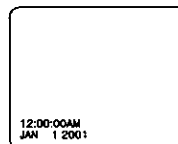
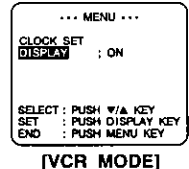
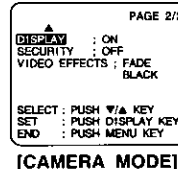
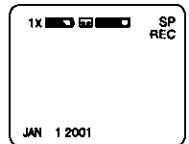
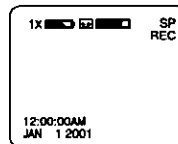



For Your Information

# Viewfinder/LCD Monitor Indications

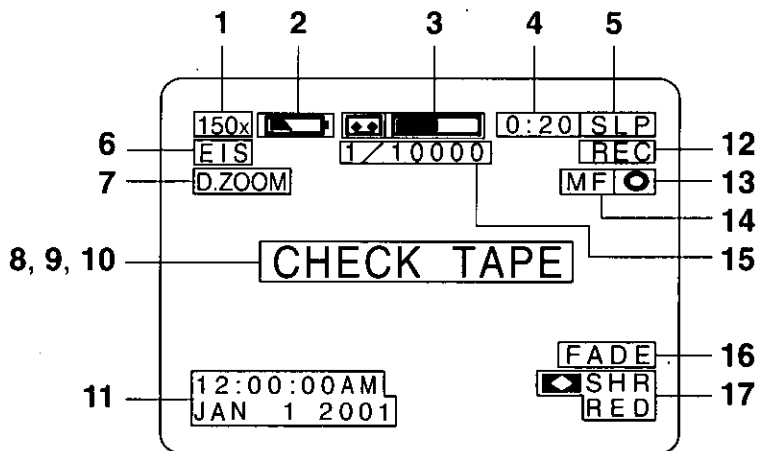
## CAMERA/VCR mode

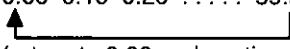

- Zoom Magnification level** (pages 20, 25).
- Battery Remaining**  (page 29).  
"WARNING LOW BATTERY" appears and Power Lamp starts flashing 15 seconds before Camcorder shuts off.
- Tape Remaining** (page 29).  
" flashes and "TAPE END" appears for 5 seconds when:  
• End of tape is reached.  
" flashes 1 minute and "CHECK TAPE" appears for 5 seconds when:  
• RECORD/PAUSE is pressed with no cassette, or cassette has no record tab in Camera (RECORD) mode.  
• PLAY, FF or REW is pressed with no cassette inserted in VCR mode.
- 10-Second Reminder**  
Each time a recording is started, a 10 second incremental display (up to 59:50) lets you monitor how long one scene is recorded.  
0:00 0:10 0:20 . . . . . 59:50  
  
(return to 0:00 and continue)
- TAPE SPEED** (pages 10, 14).  
(SP=standard play,  
SLP=super long play).
- Digital E.I.S.** (page 25).
- Digital Zoom** (page 25).
- VCR-MODE**  
"VCR-MODE" appears 1 minute when POWER is set to VCR or if RECORD/PAUSE is pressed in VCR mode.
- DEW**  
If moisture condensation occurs in unit, "WARNING DEW DETECTED" appears, Power Lamp flashes, and Camcorder will shut off in 15 seconds. Wait until lamp no longer flashes when Camcorder is turned on to use.
- Security Mode** (page 26).
- Date and Time** (pages 12, 13).
- Operating Mode**
  - REC (record)
  - PAUSE
  - FF (fast forward)
  - PLAY
  - REW (rewind)
- Backlight** (page 20).
- Manual Focus** (page 21).
- High Speed Shutter** (page 22).
- Fade** (page 23).
- Color Digital Fade** (page 24).

# Operation Notes

## Attaching Shoulder Strap

Remove Battery Pack before doing steps.

- 1 Undo strap ends from buckles.

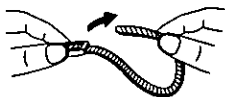

- 2 Thread strap ends through Strap Rings on Camcorder.

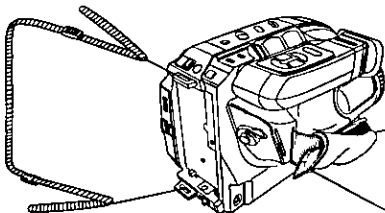

- 3 Re-insert the strap ends into buckles.



min. 25.4 mm (1 inch)

## Adjust the Length of the Shoulder Strap

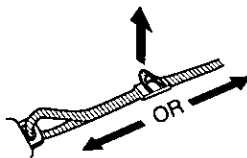

Pull a loop of strap from buckle, then pull strap tight to shorten or lengthen.

## Hand Strap

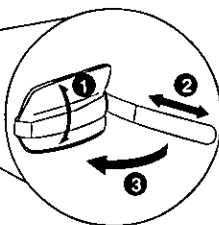

Adjust Hand Strap length to fit your hand as shown.

## Cleaning EVF (Electronic Viewfinder)

To Remove

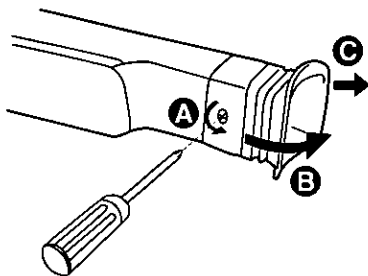

- 1 **A** Remove the screw with a Phillips screwdriver.  
Turn counterclockwise.  
**B** Turn the EVF Eyepiece.  
**C** Pull the EVF Eyepiece.
- 2 Remove any lint or dust particles with a soft clean cloth being careful not to scratch the glass surfaces.
- 3 Replace the EVF Eyepiece and the screw.

For Your Information

# Replacing Clock Battery

The clock battery is pre-installed. Follow the steps below if replacement becomes necessary.

## WARNING:

Replace battery with Panasonic PART NO. VSBW0004 (CR2025) only. Use of another battery may present a risk of fire or explosion.

Caution: Battery may explode if mistreated. Dispose of used battery promptly. Keep away from children. Do not recharge, disassemble or dispose of in fire.

## Clock Battery

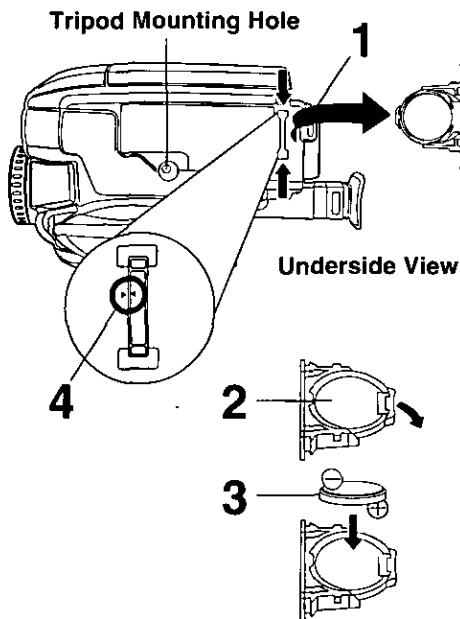

**1** While pinching 2 tabs, pull Battery Tray out.

**2** Bend middle tab out and remove Battery.

**3** Snap new Battery (+ mark down) into Battery Tray.  
• Do not reverse the polarity.

**4** Insert Battery Tray so the triangle marks meet.

### Note:

- Keep Battery out of children's reach. Swallowing it may be harmful.
- Improperly installed, discharged, or missing battery causes "CLOCK BATTERY" to appear when DISPLAY is pressed.
- Battery life is approximately 5 years.



# Palmcorder Accessory System

For ordering instructions, see the Accessory Order Form page.

• The listed standard battery use times are based on continuous recording using this Palmcorder.

Accessory #	Figure	Description	Price
PV-A17		AC Adaptor with DC Power Cable (Charging of the Nickel Cadmium Battery)	\$139.95
PV-A19		AC Adaptor with DC Power Cable (Charging of the Nickel Cadmium Battery or Nickel Metal Hydride Battery)	Call For Pricing
HHR-V60A/1B		Up to 6 hr Battery Pack (Rechargeable Nickel Metal Hydride Battery)	\$119.95
HHR-V40A/1B		Up to 4 hr Battery Pack (Rechargeable Nickel Metal Hydride Battery)	\$69.95
HHR-V20A/1B		Up to 2 hr Battery Pack (Rechargeable Nickel Metal Hydride Battery)	\$59.95
PV-AA6		"AA" Battery Case	\$20.00
PV-C16		Car Battery Cord	\$70.00
PV-P1		VHS PlayPak	\$39.95
PV-H18A		Soft Sided Carrying Case	\$49.95

**Note:**

• Prices subject to change without notice.

For Your Information

# Palmcorder Accessory Order Form

Please photocopy this form when placing an order.

1. Palmcorder Model # \_\_\_\_\_

2. Items Ordered

Accessory #	Description	Price Each	Quantity	Total Price
Subtotal				
Your State & Local Sales Tax				
Shipping & Handling				6.95
Total Enclosed				

3. Method of payment (check one)

- Check or Money Order enclosed (NO C.O.D.SHIPMENTS)
- VISA                      Credit Card # \_\_\_\_\_
- MasterCard              Expiration Date \_\_\_\_\_
- Discover                    Customer Signature \_\_\_\_\_

Make Check or Money Order to: MATSUSHITA ACCESSORIES

(Please do not send cash)

4. Shipping information (UPS delivery requires complete street address)

Ship To:

Mr.

Mrs.

Ms.

First \_\_\_\_\_ Last \_\_\_\_\_

Phone #:

Day (    ) \_\_\_\_\_

Street Address \_\_\_\_\_

Night (    ) \_\_\_\_\_

City \_\_\_\_\_ State \_\_\_\_\_ Zip \_\_\_\_\_

TO OBTAIN ANY OF OUR OMNIMOVIE/PALMCORDER ACCESSORIES YOU CAN DO ANY OF THE FOLLOWING:

VISIT YOUR LOCAL PANASONIC DEALER

OR

CALL PANASONIC'S ACCESSORY ORDER LINE AT 1-800-332-5368

[6 AM-5 PM M-F, 6 AM-10:30 AM SAT, PACIFIC TIME]

OR

MAIL THIS ORDER TO: PANASONIC SERVICES COMPANY ACCESSORY

ORDER OFFICE

20421 84th Avenue South Kent, WA. 98032

# Specifications

<b>Power Source:</b>	Compact VHS Camcorder: DC 6 V AC Adaptor: 110/120/220/240 V AC, 50/60 Hz Battery: Nickel-Cadmium Type DC 6 V
<b>Power Consumption:</b>	Compact VHS Camcorder: 6V DC 8.5 W AC Adaptor: 19 W 1.2 W (when not in use.)
<b>Video Signal:</b>	EIA Standard (525 lines, 60 fields) NTSC color signal
<b>Video Recording System:</b>	2 rotary heads plus flying erase head. Helical scanning system
<b>Audio:</b>	1 track
<b>Pick-Up System:</b>	Sequential color difference field reverse system
<b>Pick-Up Device:</b>	One integral color filter Charge Coupled Device (CCD)
<b>Lens:</b>	20:1 zoom lens, F1:1.6 with auto iris control Focal length: 3.6 mm - 72 mm 4 speed power zoom function
<b>Viewfinder:</b>	11 mm (0.45 inch)/14 mm (0.55 inch) Liquid Crystal Color Electronic Viewfinder
<b>LCD Monitor:</b>	76.2 mm (3.0 inch) Liquid Crystal Display
<b>Minimum Illumination Required:</b>	0.8 lx (F1:1.6) 0.08 footcandles 7 lx (F1:1.6) 0.7 footcandles (EIA Standard)
<b>Operating Temperature:</b>	0 °C~40 °C (32 °F~104 °F)
<b>Operating Humidity:</b>	10 %~75 %
<b>Weight:</b>	Compact VHS Camcorder: 0.98 kg 2.16 lbs. AC Adaptor: 0.3 kg 0.66 lbs.
<b>Dimensions:</b>	Compact VHS Camcorder: 120 (W) × 122 (H) × 186.5 (D) mm 4-3/4 (W) × 4-3/4 (H) × 7-3/8 (D) inch AC Adaptor: 68 (W) × 41 (H) × 140 (D) mm 2-11/16 (W) × 1-5/8 (H) × 5-1/2 (D) inch

Weight and dimensions shown are approximate.  
Designs and specifications are subject to change without notice.



## Request for Service Notice

Please photocopy this form when making a request for service notice.

### Request for Service Notice:

- In the unlikely event this product needs service.
  - Please include your **proof of purchase**.  
(Failure to do so will delay your repair.)
  - To further speed your repair please provide an explanation of what is wrong with the unit and any symptom it is exhibiting.

Mail this completed form and your Proof of Purchase along with your unit to:  
Panasonic Services Company  
1705 N. Randall Road  
Elgin, IL 60123-7847  
Attn: Camcorder Repair

For Your Information

# Before Requesting Service

If a problem arises, you may be able to correct it yourself.  
See Symptom and Correction list below.

Symptom	Correction
No picture in EVF or LCD monitor ...	<ul style="list-style-type: none"><li>• Connect Power Source. (pp. 8, 9)</li><li>• Set POWER to VCR or CAMERA. (pp. 14, 17)</li><li>• Check for Dew Indication. (p. 30)</li><li>• Use fully charged Battery. (p. 8)</li><li>• Firmly connect all needed cables. (p. 9)</li></ul>
Video cassette cannot be inserted ...	<ul style="list-style-type: none"><li>• Connect Power Source. (pp. 8, 9)</li><li>• Insert cassette, window side facing out. (p. 10)</li></ul>
Video cassette cannot be removed ...	<ul style="list-style-type: none"><li>• Connect Power Source. (pp. 8, 9)</li></ul>
Operation buttons do not work ...	<ul style="list-style-type: none"><li>• Check for Dew Indication. (p. 30)</li></ul>
Recording cannot be done ...	<ul style="list-style-type: none"><li>• Make sure record tab is intact. (p. 10)</li><li>• Check Battery Indicator. (p. 29)</li><li>• Check for Dew Indication. (p. 30)</li></ul>
Auto Focus does not operate ...	<ul style="list-style-type: none"><li>• Set FOCUS to AUTO. (p. 21)</li><li>• Set POWER to CAMERA. (p. 14)</li></ul>
Sound from microphone can't be monitored ...	<ul style="list-style-type: none"><li>• Set unit to REC or Record/Pause mode.</li></ul>
Camera picture is too dark ...	<ul style="list-style-type: none"><li>• Set HIGH SPEED SHUTTER to AUTO. (p. 22)</li></ul>
No playback picture, or the playback picture is noisy or contains streaks ...	<ul style="list-style-type: none"><li>• Press UP ▲/DOWN ▼ button during playback (Tracking Control). (p.17)</li></ul>
Top of playback picture waves back and forth excessively ...	<ul style="list-style-type: none"><li>• A playback signal is not as stable as an off the air TV signal, so the top of your TV screen may appear bent or unstable during playback. This is called, "Horizontal AFC time constant change." To correct, slowly turn the TV horizontal hold control. If your TV does not have this control, or adjusting it does not help, contact your TV service center. (Some nominal service charges may be required.)</li></ul>

## Video Head Cleaning



**Clogged Video Head**

While head cleaning is normally not needed, playing old or damaged tapes may clog the heads. When playback picture resembles example at the left, head cleaning is required.

Ideally, head cleaning should be performed by a qualified service technician. When this is not possible, purchase a head cleaning cassette. Be sure to follow cleaning cassette instructions exactly and only use when symptoms occur.

**Panasonic Consumer Electronics Company, Division of Matsushita Electric Corporation of America**  
One Panasonic Way Secaucus, New Jersey 07094

**Panasonic Sales Company, Division of Matsushita Electric of Puerto Rico, Inc.**  
Ave. 65 de Infantería. Km. 9.5  
San Gabriel Industrial Park, Carolina, Puerto Rico 00985

## PANASONIC/QUASAR Video Products Limited Warranty

Panasonic Consumer Electronics Company or Panasonic Sales Company (collectively referred to as "the Warrantor") will repair this product with new or refurbished parts, free of charge, in the USA or Puerto Rico, in the event of a defect in materials or workmanship as follows (all time periods commence from the date of the original purchase):

PRODUCT	PARTS	LABOR
CAMCORDER	ONE (1) YEAR, EXCEPT CCD IMAGE SENSOR CCD IMAGE SENSOR - SIX (6) MONTHS	NINETY (90) DAYS NINETY (90) DAYS
VCR	ONE (1) YEAR	NINETY (90) DAYS
A/V MIXER	ONE (1) YEAR	NINETY (90) DAYS
MONITOR-VCR	ONE (1) YEAR, EXCEPT CRT CRT - TWO (2) YEARS	NINETY (90) DAYS CRT - NINETY (90) DAYS CUSTOMER PAYS ALL LABOR CHARGES AFTER 90 DAYS

### Monitor-VCR In-home or carry-in Service: 22" (diagonal) CRT / LCD and Larger Monitor-VCR Carry-in Service: 21" (diagonal) CRT / LCD and smaller

**Batteries** (if included) - New rechargeable batteries in exchange for defective rechargeable batteries for ten (10) days. Non-rechargeable batteries are not warranted.

**Tape** (if included) - New video cassette tape in exchange for a defective video cassette tape for five (5) days.

In-home, carry-in or mail-in service, as applicable, in the USA can be obtained during the warranty period by contacting a Panasonic Services Company (PASC) Factory Servicenter listed in the Service Directory. Or call toll free 1-800-211-PANA(7262), to locate an authorized PASC Servicenter. Carry-in or mail-in service in Puerto Rico can be obtained during the warranty period by calling the Panasonic Sales Company telephone number listed in the Servicenter Directory.

This warranty is extended only to the original purchaser. A purchase receipt or other proof of the date of the original purchase is required before warranty service is rendered.

This warranty only covers failures due to defects in materials and workmanship which occur during normal use and does not cover normal maintenance, including, but not limited to, video and audio head cleaning. The warranty does not cover damage which occurs in shipment, or failures which are caused by products not supplied by the warrantor, or failures which result from accident, misuse, abuse, neglect, mishandling, misapplication, alteration, modification, faulty installation, set-up adjustments, improper antenna, inadequate signal pickup, maladjustment of consumer controls, improper operation, power line surge, improper voltage supply, lightning damage, commercial use such as hotel, office, restaurant, or other business or rental use of the product, or service by anyone other than a PASC Factory Servicenter or a PASC authorized Servicenter, or damage that is attributable to acts of God.

### LIMITS AND EXCLUSIONS

There are no express warranties except as listed above. THE WARRANTOR SHALL NOT BE LIABLE FOR INCIDENTAL OR CONSEQUENTIAL DAMAGES (INCLUDING, WITHOUT LIMITATION, DAMAGE TO TAPES) RESULTING FROM THE USE OF THIS PRODUCTS, OR ARISING OUT OF ANY BREACH OF THE WARRANTY. ALL EXPRESS AND IMPLIED WARRANTIES, INCLUDING THE WARRANTIES OF MERCHANTABILITY AND FITNESS FOR PARTICULAR PURPOSE, ARE LIMITED TO THE APPLICABLE WARRANTY PERIOD SET FORTH ABOVE. Some states do not allow the exclusion or limitation of incidental or consequential damages, or limitations on how long an implied warranty lasts, so the above exclusions or limitations may not apply to you.

This warranty gives you specific legal rights and you may also have other rights which vary from state to state.

If a problem with this product develops during or after the warranty period, you may contact your dealer or Servicenter. If the problem is not handled to your satisfaction, then write to the Customer Satisfaction Center at the Panasonic Consumer Electronics Company address above.

**SERVICE CALLS WHICH DO NOT INVOLVE DEFECTIVE MATERIALS OR WORKMANSHIP AS DETERMINED BY THE WARRANTOR, IN ITS SOLE DISCRETION, ARE NOT COVERED. COSTS OF SUCH SERVICE CALLS ARE THE RESPONSIBILITY OF THE PURCHASER.**

warvid 10/20/97

# Warranty

For Product Information, Operating Assistance, Literature Request, Dealer Locations, and all Customer Service inquiries please contact:  
**1-800-211-PANA(7262), Monday-Friday 9am-9pm Saturday-Sunday 9am-7am, EST.**  
or send e-mail to : [consumerproducts@panasonic.com](mailto:consumerproducts@panasonic.com)

**Web Site: <http://www.panasonic.com>**  
You can purchase parts, accessories or locate your nearest servicer by visiting our Web Site.

## Accessory Purchases:

**1-800-332-5368 (Customer Orders Only )**  
**Panasonic Services Company 20421 84th Avenue South, Kent, WA 98032**  
**(6 am to 5 pm Monday - Friday; 6 am to 10:30 am Saturday; PST)**  
**(Visa, MasterCard, Discover Card, American Express, Check)**

## Product Repairs

## Centralized Factory Servicer

**MAIL TO :** Panasonic Services Company  
1705 N. Randall Road,  
Elgin, IL 60123-7847  
Attention: Camcorder Repair

Please carefully pack and ship, prepaid and insured, to the Elgin centralized repair Factory Servicer. While there will be added handling delays, you may bring your unit to one of the following locations who will then forward the unit to Elgin for repair.  
Customer's in Puerto Rico, please ship or carry in to location below ("Service in Puerto Rico").

## Factory Servicer Locations

### CALIFORNIA

6550 Katella Avenue  
Cypress, CA 90630

800 Dubuque Avenue  
S. San Francisco  
CA 94080

20201 Sherman Way  
Suite 102  
Canoga Park, CA 91306

3878 Ruffin Road  
Suite A  
San Diego, CA 92123

### COLORADO

1640 South Abilene  
Street Suite D  
Aurora, CO 80012

### FLORIDA

3700 North 29th Avenue  
Suite 102  
Hollywood, FL 33020

### GEORGIA

8655 Roswell Road  
Suite 100  
Atlanta, GA 30350

### ILLINOIS

9060 Golf Road  
Niles, IL 60714

1703 North Randall Road  
Elgin, IL 60123  
(Pick-up/drop-off only)

### MARYLAND

62 Mountain Road  
Glen Burnie, MD 21061

### MASSACHUSETTS

60 Glacier Drive  
Suite G  
Westwood, MA 02090

### MICHIGAN

37048 Van Dyke Avenue  
Sterling Heights,  
MI 48312

### MINNESOTA

7850-12th Avenue South  
Airport Business Center  
Bloomington, MN 55425

### OHIO

2236 Waycross Road  
Civic Center Plaza  
ForestPark, OH 45240

### PENNSYLVANIA

2221 Cabot Blvd. West  
Suite B  
Langhorne, PA 19047

### TENNESSEE

3800 Ezell Road  
Suite 806  
Nashville, TN 37211

### TEXAS

13615 Welch Road  
Suite 101  
Farmers Branch, TX  
75244

### WASHINGTON

20425-84th Avenue  
South  
Kent, WA 98032

### HAWAII

99-859 Iwaiwa Street  
Aiea, Hawaii 96701  
Phone (808) 488-1996  
Fax (808) 486-4369

## Service in Puerto Rico

Matsushita Electric of Puerto Rico, Inc. Panasonic Sales Company/ Factory Servicer  
Ave: 65 de Infanteria. Km. 9.5 San Gabriel Industrial Park, Carolina, Puerto Rico 00985.  
Phone (787) 750-4300 Fax (787) 768-2910

# Spanish Quick Use Guide/Guía Para Uso Rápido

## Antes de comenzar...

- Inserte un casete con lengüeta para prevención del grabado.

### Cargue la batería

Cargue completamente la batería antes de usarla.

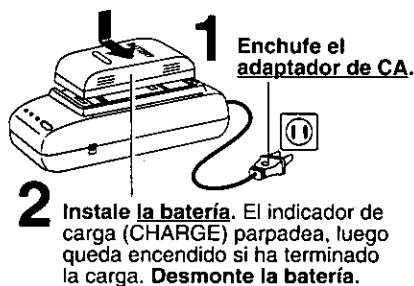

### Inserte el casete

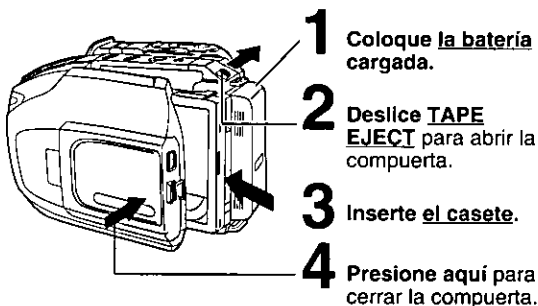

### Grabación con la videocámara

Cuando el monitor LCD está completamente abierto, el visor se desconecta automáticamente.

- 1** Presione **LCD-OPEN** para abrir el monitor LCD. Abralo completamente y ajuste el ángulo.

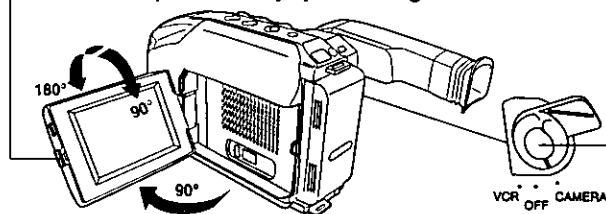

### Reproduzca usando el monitor LCD

Cuando el monitor LCD está completamente abierto, el visor se desconecta automáticamente.

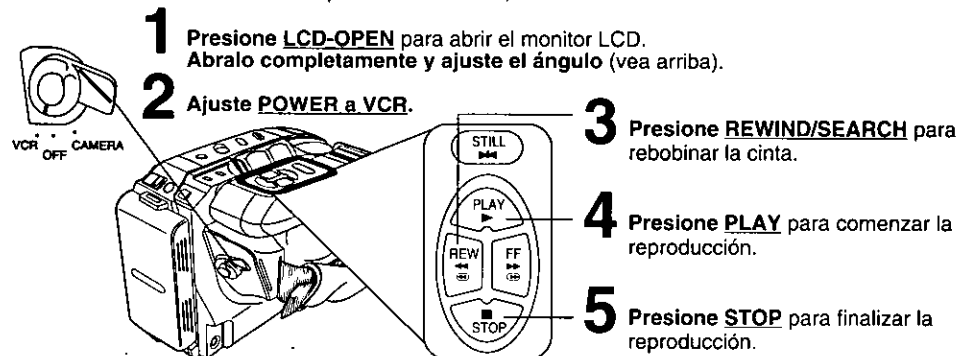

### Reproducción con efectos especiales

Para localizar rápidamente una escena específica

- Oprimir el botón de localización (SEARCH).

Para congelar una imagen

- Oprimir el botón de pausa/imagen fija (PAUSE/STILL).
- Oprimir nuevamente el botón cuando se desea continuar reproduciendo.

# Index

- A**  
AC Adaptor ..... 9  
Accessories (Optional) ... 33  
Accessories (Supplied) .... 2  
Audio/Video Cable ... 18, 19  
Audio/Video Out ..... 18, 19  
Auto Daylight Saving  
Time ..... 13
- B**  
Backlight ..... 20  
BACKLIGHT Button ..... 20  
Battery Pack ..... 8, 9  
BATTERY RELEASE  
Button ..... 8  
BRIGHT Control ..... 14, 17  
Built-in Twin Capsule 2-Way  
Microphone System .... 14
- C**  
Camera Recording ... 14~16  
Car Battery Cord ..... 9  
Charging Battery ..... 8  
Cleaning EVF ..... 31  
Clock Battery ..... 32  
Clock Set ..... 12, 13  
Copying your Tapes ..... 19
- D**  
DC IN ..... 9  
DC Power Cable ..... 9  
Digital E.I.S. .... 25  
Digital Zoom ..... 25  
D.ZOOM Button ..... 25  
DISPLAY Button .. 11, 17, 29  
Display-off Mode ..... 29
- E**  
EIS Button ..... 25
- F**  
Fade ..... 23, 24  
FADE Button ..... 23, 24  
FAST FORWARD/  
SEARCH Button ..... 17  
Focus ..... 21
- H**  
Hand Strap ..... 31  
High Speed Shutter ..... 22
- L**  
LCD Monitor ..... 14, 17  
LCD-OPEN Button ... 14, 17  
Lens Cover ..... 14
- M**  
MANUAL FOCUS Button 21  
MENU Button ..... 11  
MENU Mode ..... 11
- P**  
PLAY Button ..... 17  
Playback ..... 17, 18  
PlayPak ..... 18  
Power Lamp ..... 14, 17  
Power Supply ..... 8, 9  
POWER Switch ..... 14, 17  
POWER ZOOM Button  
..... 20, 21, 25  
Programmed Recording . 16
- R**  
RECORD/PAUSE Button 14  
Replacing Clock Battery . 32  
Request for Service Notice  
..... 35  
REWIND/SEARCH Button .  
..... 17
- S**  
Safety Precautions ..... 3  
Security Mode ..... 26  
Shoulder Strap ..... 31  
Speaker ..... 17  
Specifications ..... 35  
STILL Button ..... 17  
Still Picture ..... 17  
STOP Button ..... 17
- T**  
Tab ..... 10  
TAPE EJECT Switch 10, 14  
TAPE SPEED Button .... 14  
TITLE Button ..... 27, 28  
Titler ..... 27, 28  
Tracking Control ..... 17  
Tripod Mounting Hole .... 32
- U**  
UP ▲ (FAR) / DOWN ▼  
(NEAR) Button . 11, 17, 21
- V**  
VHF Connecting Cable .. 19  
Video Cassettes (tapes) . 10  
Video Head Cleaning .... 36  
Viewfinder/LCD Monitor  
Indications ..... 29, 30  
Viewing (TV/VCR) ..... 18  
VISION ADJUSTMENT .. 14  
VOLUME Control ..... 17
- W**  
Warranty ..... 37, 38
- Z**  
Zoom ..... 20, 25

Panasonic Consumer Electronics Company,  
Division of Matsushita Electric Corporation of America  
One Panasonic Way Secaucus, New Jersey 07094



Printed in Indonesia  
LSQT0362A  
S1100-0



## Free Manuals Download Website

<http://myh66.com>

<http://usermanuals.us>

<http://www.somanuals.com>

<http://www.4manuals.cc>

<http://www.manual-lib.com>

<http://www.404manual.com>

<http://www.luxmanual.com>

<http://aubethermostatmanual.com>

Golf course search by state

<http://golfingnear.com>

Email search by domain

<http://emailbydomain.com>

Auto manuals search

<http://auto.somanuals.com>

TV manuals search

<http://tv.somanuals.com>