

User's Manual

MAC 2.2/2.3/2.4

STEREO POWER AMPLIFIER



www.altoproaudio.com
Version 1.2 APRIL 2005

— English —

SAFETY RELATED SYMBOLS



This symbol, wherever used, alerts you to the presence of un-insulated and dangerous voltages within the product enclosure. These are voltages that may be sufficient to constitute the risk of electric shock or death.



This symbol, wherever used, alerts you to important operating and maintenance instructions. Please read.



Protective Ground Terminal



AC mains (Alternating Current)



Hazardous Live Terminal

ON: Denotes the product is turned on.

OFF: Denotes the product is turned off.

WARNING

Describes precautions that should be observed to prevent the possibility of death or injury to the user.

CAUTION

Describes precautions that should be observed to prevent damage to the product.

WARNING

• Power Supply

Ensure that the mains source voltage (AC outlet) matches the voltage rating of the product. Failure to do so could result in damage to the product and possibly the user.

Unplug the product before electrical storms occur and when unused for long periods of time to reduce the risk of electric shock or fire.

• External Connection

Always use proper ready-made insulated mains cabling (power cord). Failure to do so could result in shock/death or fire. If in doubt, seek advice from a registered electrician.

• Do Not Remove Any Covers

Within the product are areas where high voltages may present. To reduce the risk of electric shock do not remove any covers unless the AC mains power cord is removed.

Covers should be removed by qualified service personnel only.

No user serviceable parts inside.

• Fuse

To prevent fire and damage to the product, use only

the recommended fuse type as indicated in this manual. Do not short-circuit the fuse holder. Before replacing the fuse, make sure that the product is OFF and disconnected from the AC outlet.

• Protective Ground

Before turning the product ON, make sure that it is connected to Ground. This is to prevent the risk of electric shock.

Never cut internal or external Ground wires. Likewise, never remove Ground wiring from the Protective Ground Terminal.

• Operating Conditions

Always install in accordance with the manufacturer's instructions.

To avoid the risk of electric shock and damage, do not subject this product to any liquid/rain or moisture. Do not use this product when in close proximity to water.

Do not install this product near any direct heat source.

Do not block areas of ventilation. Failure to do so could result in fire.

Keep product away from naked flames.

IMPORTANT SAFETY INSTRUCTIONS

Read these instructions

Follow all instructions

Keep these instructions. Do not discard.

Heed all warnings.

Only use attachments/accessories specified by the manufacturer.

• Power Cord and Plug

Do not tamper with the power cord or plug. These are designed for your safety.

Do not remove Ground connections!

If the plug does not fit your AC outlet seek advice from a qualified electrician.

Protect the power cord and plug from any physical stress to avoid risk of electric shock.

Do not place heavy objects on the power cord. This could cause electric shock or fire.

• Cleaning

When required, either blow off dust from the product or use a dry cloth.

Do not use any solvents such as Benzol or Alcohol. For safety, keep product clean and free from dust.

• Servicing

Refer all servicing to qualified service personnel only.

Do not perform any servicing other than those instructions contained within the User's Manual.

PREFACE

Dear Customer:

Thanks for choosing ▲LTO MAC 2.2/2.3/2.4 Stereo Power Amplifier which is the result of our ▲LTO AUDIO TEAM's endeavors.

For ▲LTO AUDIO TEAM music and audio are much more than a job, they are a passion and an obsession!

We have been designing professional audio products for a long time in cooperation with many of the world's major brands.

The ▲LTO line represents unparalleled analogue and digital products made by musicians, for musicians. With our design centres in Italy, Netherlands, and United Kingdom we provide you with world-class designs, while our software development teams continue to develop an impressive range of audio specific algorithms.

By purchasing our ▲LTO products you become the most important member of our ▲LTO AUDIO TEAM. We would like to share with you our passion for what we design and we invite you to make suggestions, which will aid us in developing future products for you. We guarantee you our commitment to quality, continual research and development, and of course the best performance/price ratio.

Our ▲LTO MAC 2.2/2.3/2.4 Stereo Power Amplifier is the result of many hours of listening and tests involving common people, area experts, musicians and technicians. The result of this effort is the sophisticated circuit design featuring high power and superb quality together with superior reliability and stability to provide the highest possible audio performance.

We would like to thank all the people that worked with us to make a vision real! Our designers and ▲LTO staff made the MAC 2.2/2.3/2.4 Stereo Power Amplifier, a very reliable and high quality product ready for all your venues. And thanks to their passion for music and professional audio it has been possible for us to offer you, our most important team member, our continued support too.

Thank you very much.

▲LTO AUDIO TEAM

TABLE OF CONTENTS

1. INTRODUCTION	4
2. FEATURE LIST	4
3. CONTROL ELEMENTS	4
3.1 The Front Panel	
3.2 The Rear Panel	
4. INSTALLATION & CONNECTION	6
4.1 Mains Connection	
4.2 Rack Mounting	
4.3 Audio Connection	
a. Wiring Configuration	
b. In Line Connection	
5. OPERATION	7
5.1 Operate MAC 2.2/2.3/2.4 in Stereo Mode	
5.1 Operate MAC 2.2/2.3/2.4 in Parallel (Mono) Mode	
5.1 Operate MAC 2.2/2.3/2.4 in Bridged Mode	
6. CAUTION FOR APPLICATION	9
6.1 General Application Instruction	
6.2 Caution for Speaker Connection	
7. TECHNICAL SPECIFICATIONS	10
7.1 Specifications	
7.2 Block Diagram	
8. WARRANTY	12

1. INTRODUCTION

Thank you very much for expressing your confidence in ▲LTO products by purchasing our MAC 2.2/2.3/2.4 Stereo Power Amplifier. With the MAC 2.2/2.3/2.4 you have acquired an extremely musical and flexible high power amplifier which is based on many years of experience and finding in amplifier technology and is used through the world in the renowned studios. The MAC 2.2/2.3/2.4 is used for professional output of stage stereo with excellent performance. Output power can be adjusted at the user's demand, and the sound quality and protecting circuit are both sophisticated.

The front panel presents you with 6 LEDs (power LED, protection LED, clip & signal LED for each channel) and 2 level controls, you can operate this unit more precise and easier. The output connectors are speak-on jacks and binding post terminals, which are used for better matching. Before connecting this unit into your sound system, please make sure it is powered down to prevent any electric shock.

2. FEATURE LIST

- Sophisticated protecting circuit protects the machine from improper tampering
- Excellent frequency echo and sound quality
- High fidelity and low noise
- Balanced XLR and 1/4" TRS input connectors
- Output connectors are speak-on jacks and binding post terminals
- Stereo mode, parallel mode and bridged mode are available
- High-speed and low noise fan for releasing heat. The inside temperature determines the fan speed.
- Indicator for the output balance, as well as status indicators of SIG and CLIP. When there is any signal is more than 100mV, the SIG LED lights up. When there is overload, the CLIP LED lights up. If anything abnormal happens to the circuits, the CLIP LED will be continuously on, with no action from the circuits. This helps the user to determine which status it is in.
- Solid and durable, can be mounted into a cabinet
- Manufactured under QS9000, VDA6.1 certified management system

3. CONTROL ELEMENTS

3.1 Front Panel

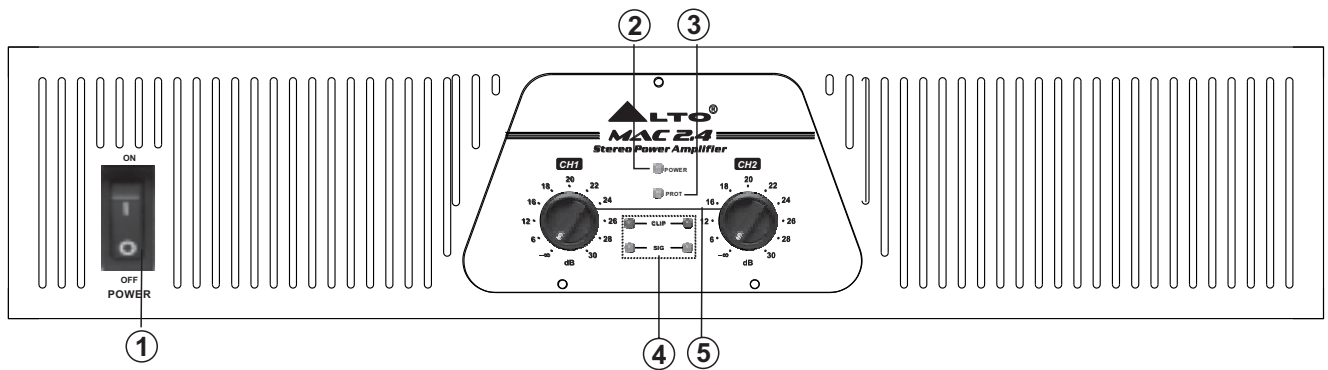

1 . Mains Switch ①

This switch turns on and off the unit by controlling both phases.

2 . Power LED ②

This Power LED lights up when the unit is powered up.

3. Protection LED ③

This red LED lights up when the thermal-protection system is working, no signal is output during this protection period. When any overheating occurs inside the unit (the critical temperature is 80°C), you should speed up the air circulation or decrease the signal level for avoiding overheating. If the problem is corrected the protection systems deactivate automatically, this LED goes out, and the normal amplifier operation is resumed.

4. Clip Signal LED ④

The clip LEDs light up when distortion reaches or exceeds 0.5% approximately, which means the unit is being driven by excessively high signal source, and you'd better adjust the level control until these LEDs go out.

Signal LED

These signal indicators light up when the output is more than 100mV.

5. Level Control ⑤

These level controls are used to adjust the output signal level, you'd better adjust them properly to avoid any distortion.

3.2 Rear Panel

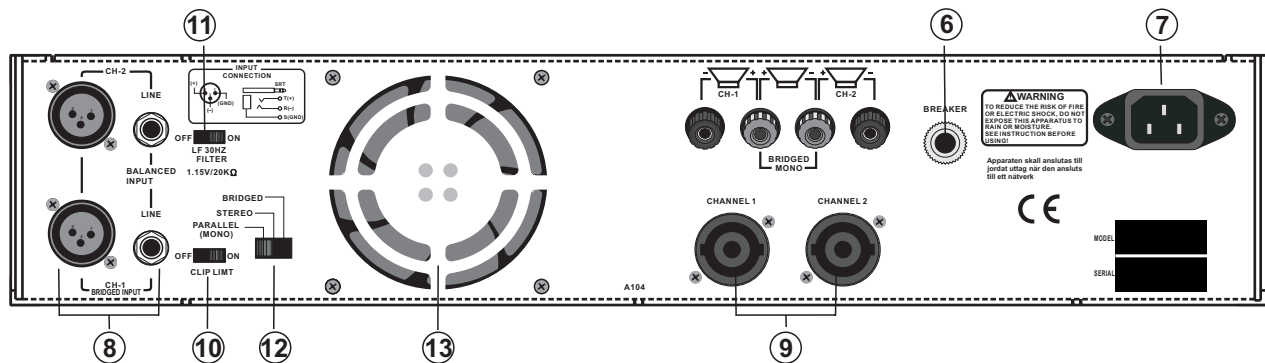

6. Breaker ⑥

This switch works as fuse for protecting the unit from damage. When the unit is overloaded or the temperature inside the unit is too high, this pushing-button will spring up and break the power supply. The power supply will be restored with pushing the switch down again.

7. AC Inlet ⑦

This connector is meant for the connection of the supplied main cord. Do not insert the power cord into this unit until voltage has been correctly set. Do not plug the power cord into the mains until the voltage has been correctly set.

8. Input Connectors ⑧

These connectors include the balanced XLR servo connectors and 1/4" TRS phone jacks. It is used to connect the input signal.

9. Output Connectors ⑨

These connectors include the speak-on jacks and binding post terminals, you can output the powered signal by the specific output connectors according to the actual application circumstance.

Caution: turn off the unit before connecting the output connectors so as to avoid any electric shock!

10. Clip Limit Switch ⑩

Set this switch at "ON" position, once the output level is above the maximum level, the clip limit begin, which is used to keep fixed output level for protecting apparatus. If the switch is at "OFF", this clip limit function doesn't work.

11. LF 30Hz Filter ⑪

Setting this switch to "ON" is equal to adding an appropriate low-pass filter in the input circuit, which is used to protect the speaker system from the damage caused by large subsonic frequencies.

12. Mode Selector ⑫

The MAC 2.2/2.3/2.4 stereo power amplifier presents three operating modes:

- Stereo Mode

In this mode, CHA and CHB operate independently (as a conventional stereo amplifier)

The CHA input signal will be output from the CHA output connector, and CHB input signal will be output from the CHB output connector.

- Parallel Mono Mode

In this mode, CHA input signal will be output from the output connectors of both channels, detail wiring diagram you can refer to chapter 5.

- Bridged Mode

In this mode, CHA input signal will be output from the bridge output connector, detail wiring diagram you can refer to chapter 5.

13. Fan 13

This fan release the heating from the unit by accelerating the air circulation (air flowing from front to back), and the speed is continuously variable.

4. INSTALLATION & CONNECTION

4.1 Mains Connection

Do not insert the power cord into this unit until voltage has been correctly set. Do not plug the power cord into the mains until the voltage has been correctly set. Please ensure that the MAC 2.2/2.3/2.4 Professional Stereo Amplifier is supplied with the correct voltage before turning on this unit. If you can't power up this unit while turning on the Mains Switch (1), please check the Breaker (6) on the rear panel first, maybe it is pressed to reset. Otherwise, contact the technician or qualified personnel for any service.

Caution: To reduce the risk of electric shock, do not perform any servicing other than contained in this manual unless you are qualified to do so. Please turn off this unit before any installation and connection, esp. when you connect your unit into the sound system. This is important to prevent damage to the unit itself as well as other consequent speaker system. The mains connection of the MAC 2.2/2.3/2.4 Professional Stereo Amplifier is made by using the enclosed power cord and a standard IEC receptacle, and it meets all of the international safety certification requirements.

4.2 Rack Mounting

The most secure mounting is on a universal rack shelf available from various rack manufactures or your music dealer. The MAC 2.2/2.3/2.4 Professional Stereo Amplifier fits into one standard 19" rack unit of space. Be sure that there is enough air space around the unit for sufficient ventilation. If heat release is inadequate, this unit will retain heat inside, which may cause the protection, or even a fire.

4.3 Audio Connection

The ▲LTO MAC 2.2/2.3/2.4 Professional High Power Amplifier presents with balanced XLR connectors and 1/4" TRS phone jack and it can be interfaced by several ways to support a variety of applications without any signal loss.

a. Wiring Configuration

Either the 1/4" TRS (Tip-Ring-Sleeve) phone jack or the XLR servo connector can be wired in balanced and unbalanced modes, which will be determined by the actual application status, Please wire your systems as the following examples:

- For 1/4" Phone jack

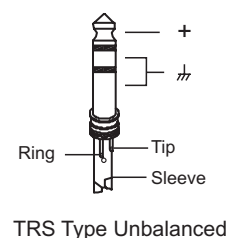
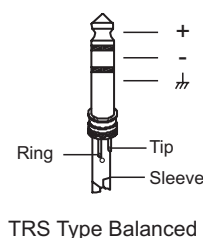
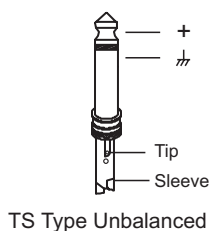

- For XLR connector

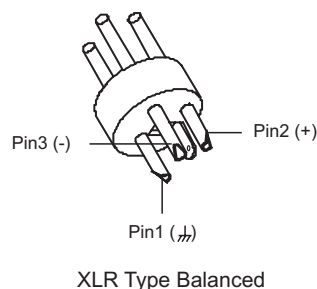
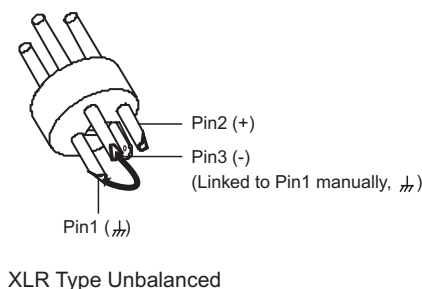

b. In Line Connection

For these applications, the MAC 2.2/2.3/2.4 stereo power amplifier provides XLR connectors and 1/4" TRS phone jack to

easily interface with most professional audio devices. Follow the configuration examples below for your particular connection.

• **Balanced**

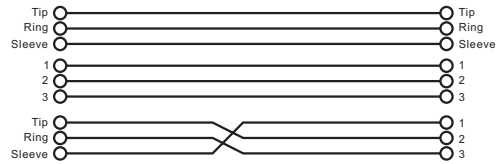
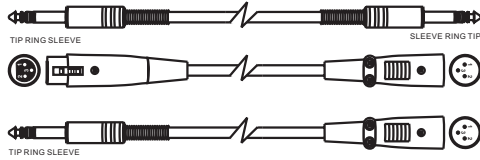

• **Unbalanced**

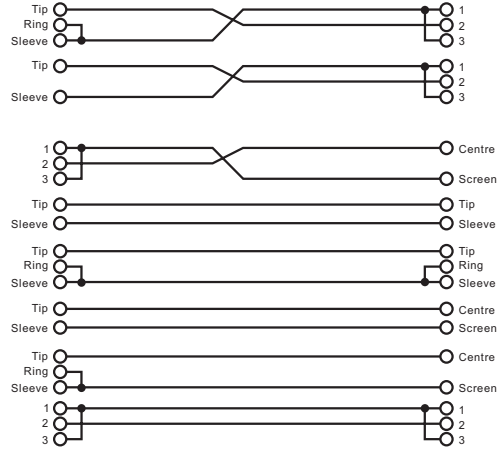
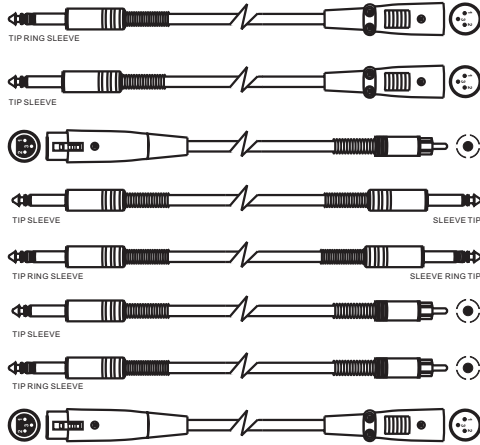

5. OPERATION

The MAC 2.2/2.3/2.4 stereo power amplifier provides three operating modes with each unit: stereo mode, parallel (mono) mode and bridged mode, you can decide each specific operating mode according to your actual application circumstance. Following examples will show you the typical connections, you can refer to install your MAC 2.2/2.3/2.4 into a sound system:

5.1 Operate MAC 2.2/2.3/2.4 in Stereo Mode

In this mode, channel A and channel B operate independently (as a conventional stereo amplifier). The channel A input signal will be output from the channel A output connectors, and the channel B input signal will be output from the channel B output connectors.

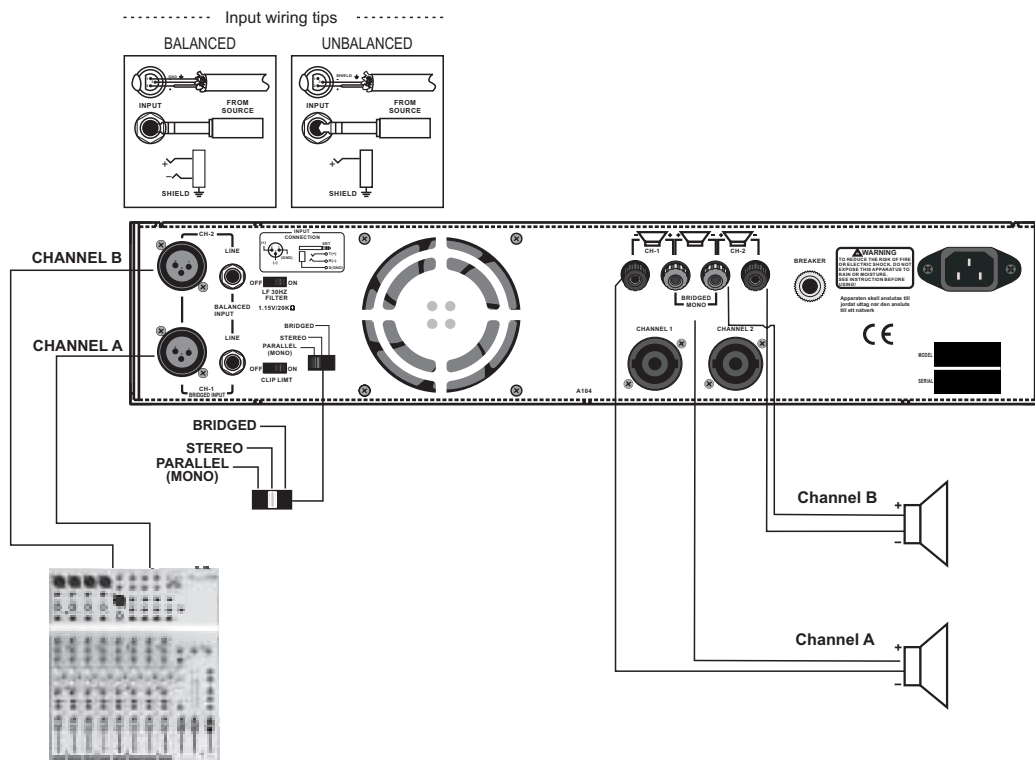

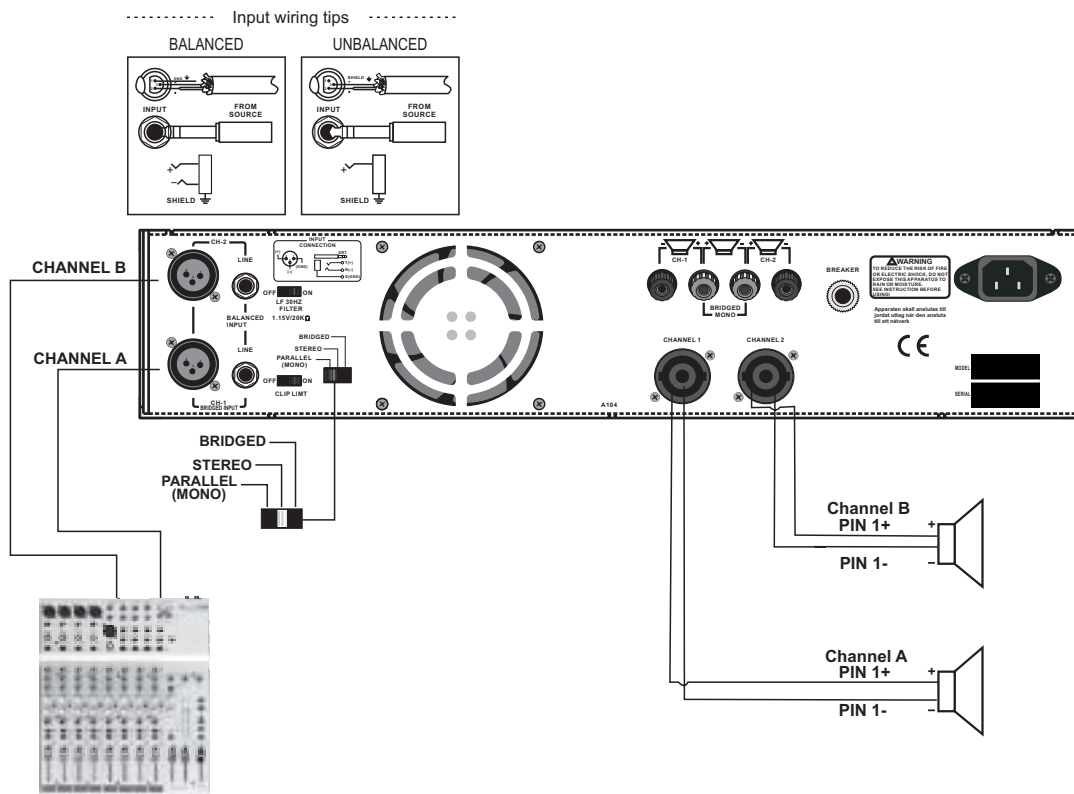

5.2 Operate MAC 2.2/2.3/2.4 in Parallel (Mono) Mode

In this mode, the channel A input signal will be output from the output connectors of both channels. The channel B input jack is not used, the channel A and B volumes can be adjusted independently.

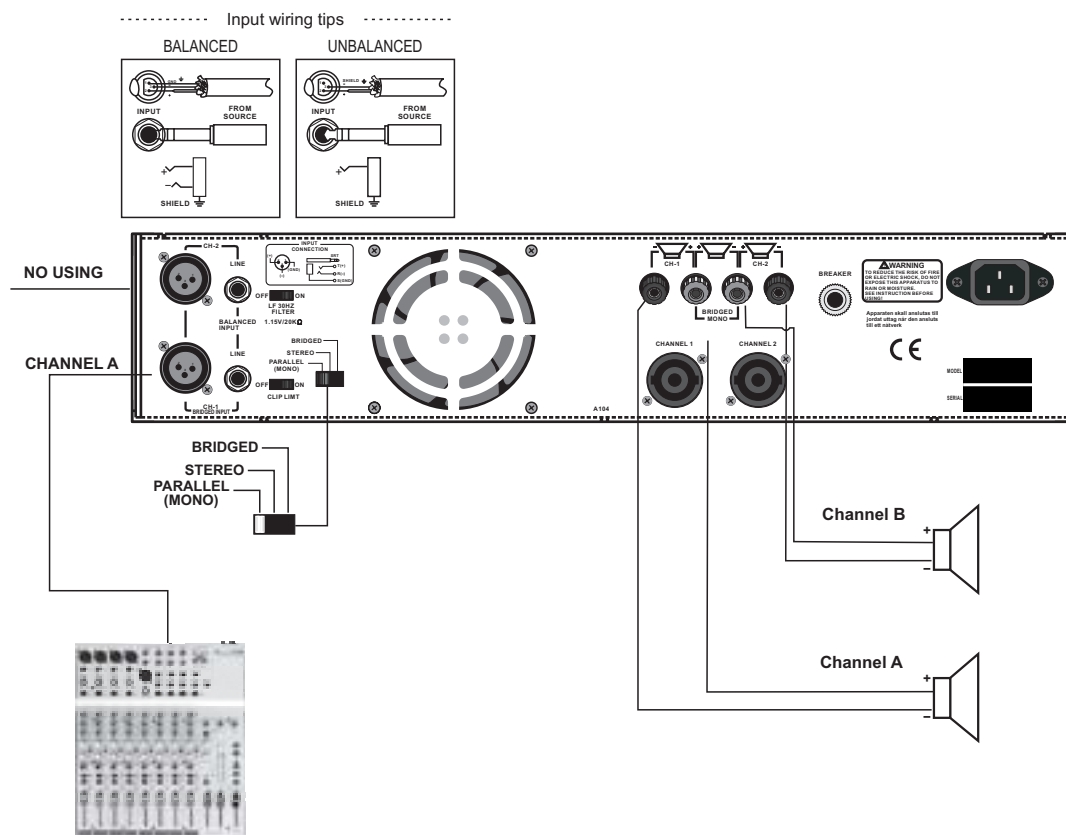

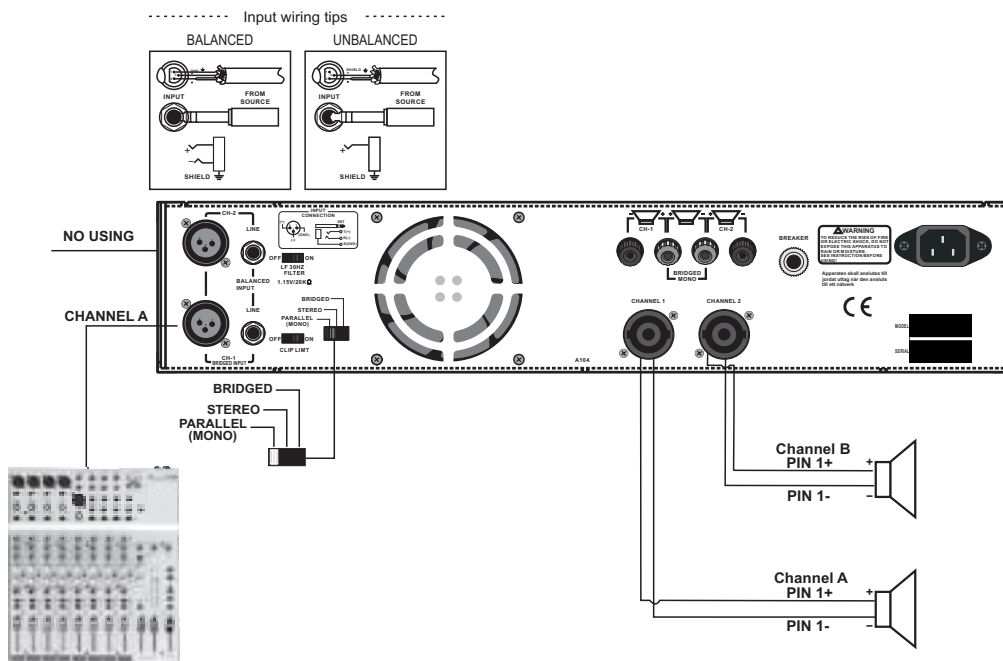

5.3 Operate MAC 2.2/2.3/2.4 in Bridged Mode

In this mode, the channel A input signal will be output from the bridge output connectors. In this case, use the channel A volume control to adjust the volume, keep the volume control of channel B turned completely down (counterclockwise). Bridged mode is intended for driving loads with a total impedance of 4 ohms or greater.

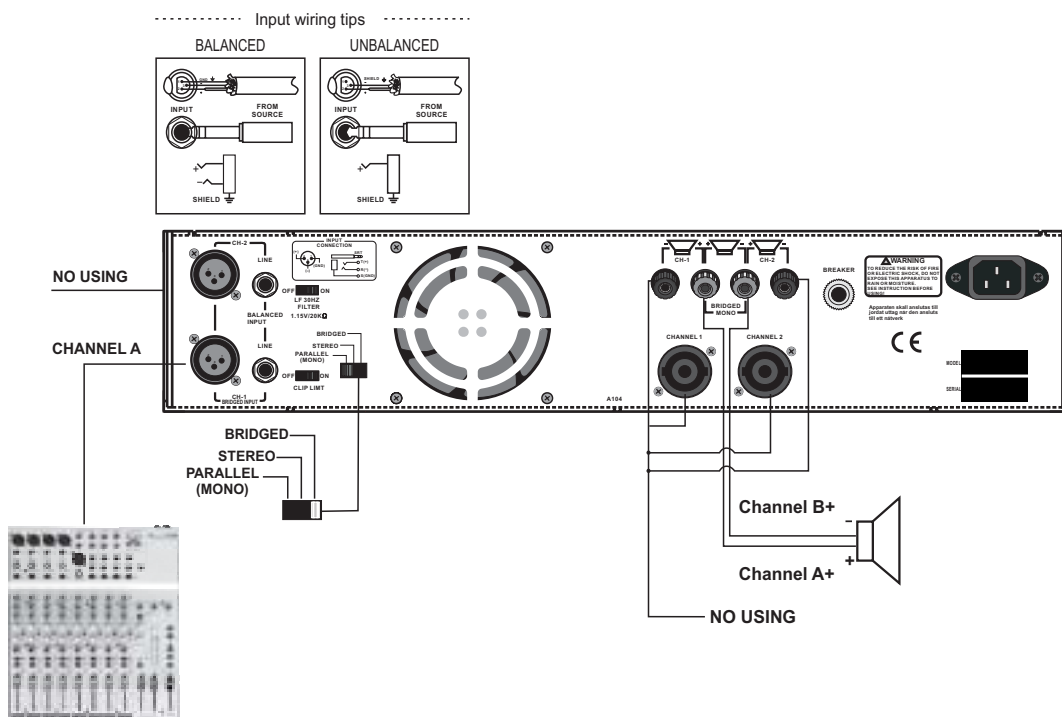

6. CAUTION FOR APPLICATION

6.1 General Application Instruction

The following instructions describe the common ways to install your MAC 2.2/2.3/2.4 stereo power amplifier into a sound application system:

1. First, turn off power switch before connection.
2. Refer to chapter 5 for speaker connection
3. MAC 2.2/2.3/2.4 stereo power amplifier may be operated in one of the three modes, please slide the mode selector (12) for the specific operating mode.

6.2 Caution for Speaker Connection

The output capacity of MAC 2.2/2.3/2.4 stereo power amplifier is very high, be sure to use a speaker system that has sufficient input capacity. If the input capacity of your speaker system is lower than the rated output of the MAC 2.2/2.3/2.4 stereo power amplifier, you can protect your speakers by connecting a fuse serially between the speaker and the amplifier as shown below.

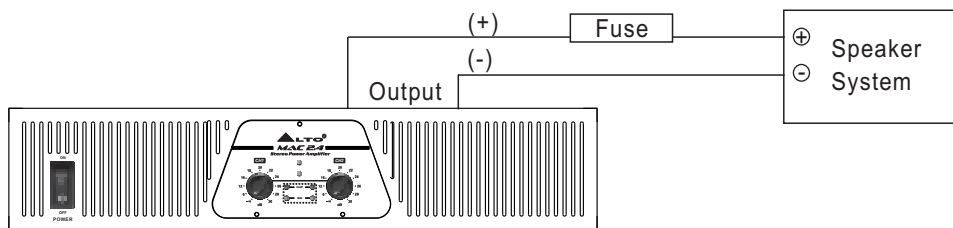

Use the following formula to determine the fuse capacity according to the speaker's input capacity.

$$P_o = I^2 R \rightarrow I = \sqrt{P_o / R}$$

P_o [W] : Speaker's continuous input capacity (noise or RMS)

R [Ω] : Speaker's nominal impedance

I [A] : Required fuse capacity

As to the speaker cable, if you use a long one, use as thick a cable as possible to prevent deterioration of the damping factor or power loss inside the cable.

7. TECHNICAL SPECIFICATIONS

7.1 Specifications

POWER SPECIFICATIONS		MAC 2.2	MAC 2.3	MAC 2.4
STEREO MODE (Both channels driven) 20Hz~20KHz	2 Ohms	480	800	1400
	4 Ohms	300	450	750
	8 Ohms	205	310	575
Bridge Mono Mode 20Hz~20KHz	8 Ohms	560	900	1500
	4 Ohms	800	1400	2500
ELECTRICAL SPECIFICATIONS		600W	900W	1500W
INPUT SENSITIVITY		1.15V(+3.4dBu)	1.15V(+3.4dBu)	1.15V(+3.4dBu)
INPUT IMPEDANCE		10K Ω Unbalanced 20K Ω Balanced		
FREQUENCY RESPONSE (at 10dB below rated output power)		25Hz~25KHz +0/-1dB -3dB points: 5Hz~50KHz		
VOLTAGE GAIN		30dB	32dB	34dB
DISTORTION(SMPTE-1M)		<0.03%	<0.03%	<0.03%
S/N ratio		100dB	100dB	100dB
GENERAL SPECIFICATIONS		600W	900W	1500W
PROTECTIONS		Full short circuit, open circuit, thermal, ultrasonic, and RF protection stable into reactive or mismatched loads, turn ON/OFF, muting, tried crowbar.		
CONTROLS		Front: AC switch 40-detect input level control for each channel. Rear: stereo/ parallel/ bridged selector, 30Hz filter selector clip ON/OFF selector.		
INDICATORS		SIGNAL: 2 \times green LED CLIP: 2 \times red LED POWER: 1 Blue LED PROTECTION: 1 red LED		
CONNECTORS		INPUT : Active balanced XLR and 1/4"(6.3mm)TRS OUTPUT: "Touch-proof" binding posts and speak-on jacks.		
POWER SUPPLY		Available for 110-120V or 220~240V AC, 50/60Hz		
DIMENSIONS		483(W) \times 400(D) \times 88.8(H)mm		
WEIGHT		14.4kg	16.54kg	19.02kg

7.2 Block Diagram

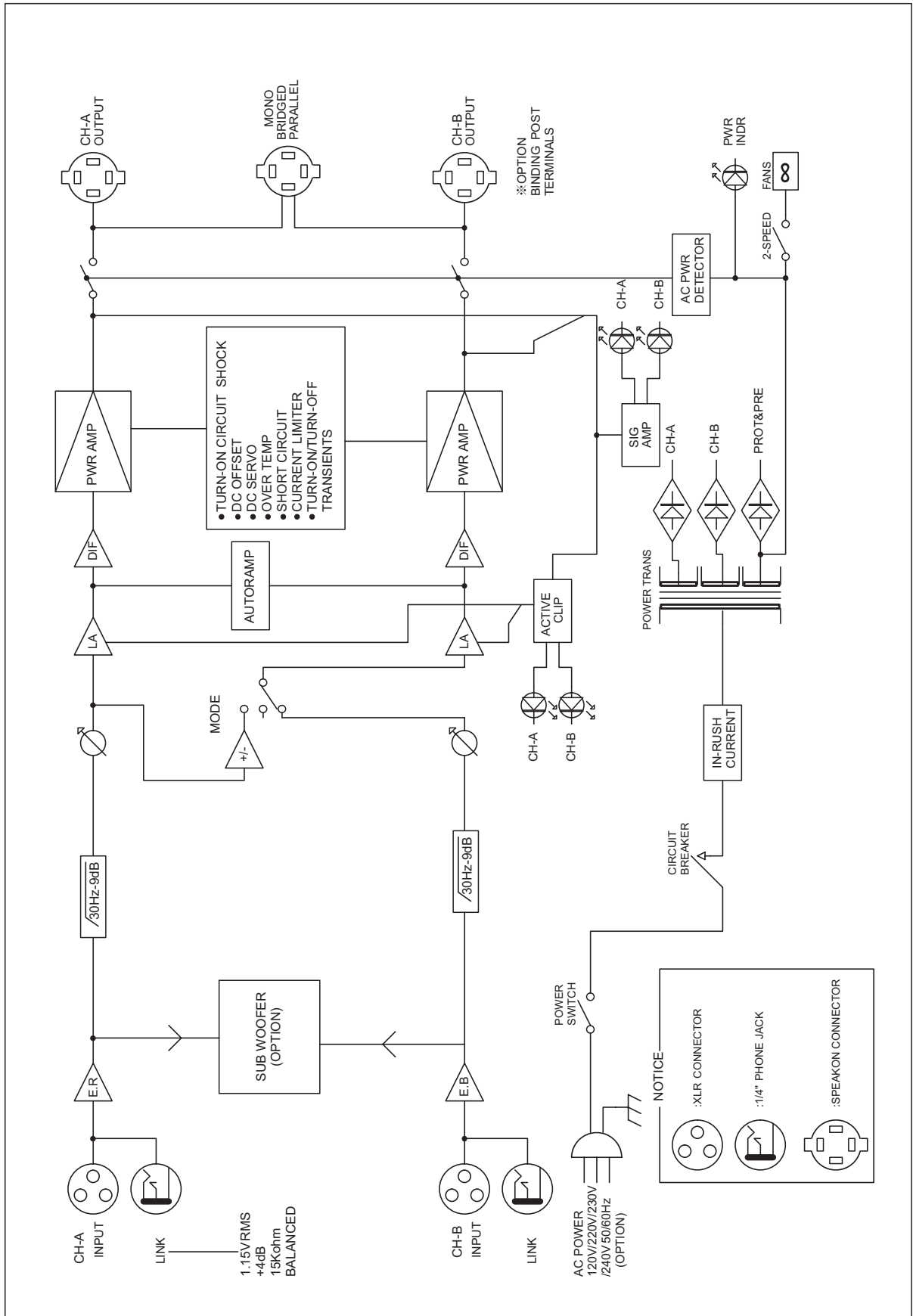

7. WARRANTY

1. WARRANTY REGISTRATION CARD

To obtain Warranty Service, the buyer should first fill out and return the enclosed Warranty Registration Card within 10 days of the Purchase Date.

All the information presented in this Warranty Registration Card gives the manufacturer a better understanding of the sales status, so as to purport a more effective and efficient after-sales warranty service.

Please fill out all the information carefully and genuinely, miswriting or absence of this card will void your warranty service.

2. RETURN NOTICE

2.1 In case of return for any warranty service, please make sure that the product is well packed in its original shipping carton, and it can protect your unit from any other extra damage.

2.2 Please provide a copy of your sales receipt or other proof of purchase with the returned machine, and give detail information about your return address and contact telephone number.

2.3 A brief description of the defect will be appreciated.

2.4 Please prepay all the costs involved in the return shipping, handling and insurance.

3. TERMS AND CONDITIONS

3.1 ▲LTO warrants that this product will be free from any defects in materials and/or workmanship for a period of 1 year from the purchase date if you have completed the Warranty Registration Card in time.

3.2 The warranty service is only available to the original consumer, who purchased this product directly from the retail dealer, and it can not be transferred.

3.3 During the warranty service, ▲LTO may repair or replace this product at its own option at no charge to you for parts or for labor in accordance with the right side of this limited warranty.

3.4 This warranty does not apply to the damages to this product that occurred as the following conditions:

- Instead of operating in accordance with the user's manual thoroughly, any abuse or misuse of this product.
- Normal tear and wear.
- The product has been altered or modified in any way.
- Damage which may have been caused either directly or indirectly by another product / force / etc.
- Abnormal service or repairing by anyone other than the qualified personnel or technician.

And in such cases, all the expenses will be charged to the buyer.

3.5 In no event shall ▲LTO be liable for any incidental or consequential damages. Some states do not allow the exclusion or limitation of incidental or consequential damages, so the above exclusion or limitation may not apply to you.

3.6 This warranty gives you the specific rights, and these rights are compatible with the state laws, you may also have other statutory rights that may vary from state to state.

SEIKAKU TECHNICAL GROUP LIMITED
SEKAKU ELECTRON INDUSTRY (H.K.) CO., LTD.
No. 1, Lane 17, Sec. 2, Han Shi West Road, Taichung 40151, Taiwan
<http://www.altoproaudio.com> Tel: 886-4-22313737
email: alto@altoproaudio.com Fax: 886-4-22346757

All rights reserved to ALTO. All features and content might be changed without prior notice. Any photocopy, translation, or reproduction of part of this manual without written permission is forbidden. Copyright © 2005 SEIKAKU GROUP

Free Manuals Download Website

<http://myh66.com>

<http://usermanuals.us>

<http://www.somanuals.com>

<http://www.4manuals.cc>

<http://www.manual-lib.com>

<http://www.404manual.com>

<http://www.luxmanual.com>

<http://aubethermostatmanual.com>

Golf course search by state

<http://golfingnear.com>

Email search by domain

<http://emailbydomain.com>

Auto manuals search

<http://auto.somanuals.com>

TV manuals search

<http://tv.somanuals.com>