

NEC

855-900549-A

Rev. 1

NX7700i/5020M-16

Operation Manual

CAUTION

Before using the product, be sure to read this manual and strictly adhere to the instructions.

Keep this manual at hand for quick reference as required.

©NEC Corporation 2006

This manual cannot be duplicated or revised without permission from NEC Corp.

The contents of this manual may be changed without prior notice.

NEC Corporation

Notes on export

This product (including software) may be classified into the cargo (or service) to which the Foreign Exchange and Foreign Trade Control Law is applied.

If this is the case, an export permit issued by the Government of Japan is required.

If you need materials to help go through the process of applying for an export permit, consult your delivery agent or the nearby NEC branch office.

Compliance with the criteria of Voluntary Control Council for Interference by Information Technology Equipment

This product is class A information technology equipment specified by the Voluntary Control Council for Interference by Information Technology Equipment (VCCI).

Use of this product in home environments may cause interference.

In this case, the user may be asked for taking appropriate preventive actions.

Compliance with the Harmonic Current Emissions Guideline

This product is in compliance with the Harmonic Current Emissions Guideline for home appliance and general purpose appliance notices by METI.

Disposing of your used NEC product



In the European Union

EU-wide legislation as implemented in each Member State requires that used electrical and electronic products carrying the mark (left) must be disposed of separately from normal household waste.

When you dispose of such products, please follow the agreements made by between you and NEC.

The mark on the electrical and electronic products only applies to the current European Union Member States.

Outside the European Union



If you wish to dispose of used electrical and electronic products outside the European Union, please contact your local authority and ask for the correct method of disposal.

Safety Precautions









Before using the product, read this manual carefully to ensure the proper and safe operation of the product. Follow the instructions in this manual to avoid physical injuries and damages to property. Keep this manual at hand for quick reference as required.

The cables supplied with this product are designed to be used solely for this product. Do not use them for other purposes.

This operation manual uses the following level of notification to ensure the proper and safe operation of the product:

 WARNING	Failure to follow the instruction with this symbol could result in severe injury or death.
 CAUTION	Failure to follow the instruction with this symbol could result in burns or other physical injury.

There are the following notifications (**pictorial symbols**) that you have to keep in mind:

	Danger of smoke emission or ignition.
	Danger of explosion.
	Danger of electric shock.
	Danger of injury with harmful substances.
	Do not disassemble or remodel.
	Forbidden.
	General instructions to the user.
	Pull out the power plug from the outlet, and turn off the circuit breaker on the distribution panel.

WARNING

Do not touch the internal components of the equipment

Nobody except the maintenance personnel should open the door of the equipment.

Do not disassemble, repair or remodel the equipment by yourself.

Do not touch the components inside the equipment or peer into the equipment while the maintenance personnel opened the door for service work. Failure to follow the instruction may result in electric shock or injury due to abnormal operation of the equipment.



Do not insert foreign materials into the equipment

Do not insert a metal plate or wire into the equipment through the air vent or other openings. This may cause fire or electric shock.



Failure processing

If the equipment failed, turn off the circuit breaker on the distribution panel, or pull out the power plug from the outlet, and contact the maintenance or sales personnel of NEC.



Emergency processing

If the equipment falls into the precarious state requiring an emergency shutdown, turn off the AC SW (emergency shutdown switch).



Data that is not saved may be destroyed when the AC SW is pushed during operation. Make clear in what situation the AC SW should be operated, and keep everyone informed about it. For details, consult the maintenance or sales personnel of NEC.

CAUTION

Handling of the lithium battery

A lithium battery is used for this equipment.

Incorrect replacement of the battery could cause explosion. Only the battery recommended by the battery manufacturer or an equivalent type of battery can be used.

Follow the instruction by the battery manufacturer when replacing the battery and disposing the used battery.

Contact the maintenance or sales personnel of NEC before replacing the battery and disposing the used battery.



* Battery life is about 5 years. Replacement of the lithium battery (paid) is therefore required once every five years.

Handling of the laser product

A laser product of Class 1, Subchapter J, Chapter 1 of JIS C6802, EN60825, IEC825 and FDA21CFR, is used for this equipment.

Note) Class 1 lasers are defined in JIC6802, EN60825, IEC825 and FDA 21CFR that they are exempt lasers or laser systems that cannot, under normal operating condition, produce a hazard, and the following label is attached to this class of laser product:

<p>クラス1レ - ザ製品 CLASS 1 LASER PRODUCT PER IEC825 LASER KLASSE 1 NACH IEC825 PRODUCTO LASER DE CLASE 1 Complies with 21CFR chapter 1, Subchapter J</p>

Disposing/collecting/recycling the equipment



Contact the sales personnel of NEC before disposing, collecting, or recycling the equipment.







The labels listed below are attached to the cabinet of this system.

Read the explanation of each label carefully before operating the system.

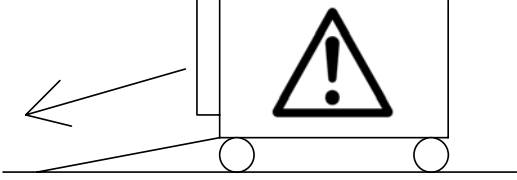

133-300656-GRP	MARKINGS
001	
031	<p>注 意：搭載品に関しては、インストレーションマニュアルを見ること。 WARNING: See operation Manual for a List of Equipment to be used with the rack. AVERTISSEMENT: Voyez au mode d'emploi fourni, pour un liste des materiels quels peuvent utiliser avec l'appareil.</p>
033	<p>注 意：分電盤の出力を確認後、ユニットを搭載すること。 WARNING: Confirm there is sufficient output voltage of power distribution from the outlet box before mounting units. AVERTISSEMENT: Avant la installation des materiels, confirmez que la tension de sortie au socle de raccordement au reseau est suffisante.</p>
103	

140	<p>注 意：同型同定格のヒューズと交換すること。 CAUTION:For continued protection against risk of fire, replace only with same type and ratings of fuse. ATTENTION:Pour une protection continue contre l'incendie,remplacer les fusibles par ceux de meme type et de meme amperage.</p>	
150	<p>注 意：資格者のみ保守すること。 HAZARD AREA:QUALIFIED SERVICE PERSONNEL ONLY DANGER:RESERVE SEULEMENT AU PERSONNEL</p>	
163	<p>矢印を上に向けて取り付けること。 Install with arrow pointing upwards. Monter de maniere a orienter la fleche vers le haut.</p> 	
165	<p>注 意：アースされていない場合には機器を動作させないこと。 CAUTION:HIGH LEAKAGE CURRENT Grounding circuit continuity is vital for safe operation of machine NEVER OPERATE MACHINE WITH GROUNDING CONDUCTOR DISCONNECTED.(see installation instruction) ATTENTION:MACHINE a FORT COURANT de FUITE NE JAMAIS FAIRE FONCTIONNER AVEC FIL DE TERRE DECONNECT.(voir instruction d'installation)</p>	
211	<p>注※意：この機器は、4系統から受電している。電源を切断するには、INPUT1,2,3,4のCB1をそれぞれ切り離せ。 WARNING:This unit contains 4 power inputs. To remove power from the unit disconnect CB1 at INPUT 1,2,3 and 4. AVERTISSEMENT:Cette unité possède 4 sources d'alimentation. Pour isoler l'équipement de toute alimentation électrique, couper CB1 à l'entrée 1,2,3 et 4.</p>	
217	<p> 注 意：入力電源線は銅線のみ接続のこと。 CAUTION:"Use Copper Conductors only" ATTENTION:N'utilisez que les conducteurs de cuivre</p>	

243	<p>注 意：カバーを開ける前に入力電源(分電盤)切断のこと。 CAUTION: Disconnect input power before removing this cover. ATTENTION: Couper l'alimentation électrique avant de démonter ce capot.</p>	
416	<p>注 意：保守時は安定板を引き出すこと。 CAUTION: PULL OUT STABILIZER WHEN MAINTAINING. ATTENTION: TIRER LE STABILISIEREN.</p>	
417		
420	<p> 注 意：装置運用中のファンボックス交換は、1分以内に行うこと。 CAUTION: Fan Box must be replaced within 60 seconds.</p> <p style="text-align: right;">YOT-502  420</p>	
422	<p> 注 意：保守の前に、レールがロックされていることを確認すること CAUTION: Confirm the side rails will be locked before maintain the unit.</p> <p style="text-align: right;">YOT-502  422</p>	

133-314121-GRP	MARKINGS	
051	<div style="border: 1px solid black; padding: 5px;"> <p style="text-align: center;">保守者の方へ</p> <p style="text-align: center;"> 警告 WARNING</p> <p>複数の装置を同時に引き出さないで下さい。 ラックの破損、転倒などの事故の原因となります。</p> <p> Do not pull out more than one component at a time as it may cause damage to the rack or allow the rack to tip over.</p> </div>	
052	<div style="border: 1px solid black; padding: 5px;"> <p style="text-align: center;">保守者の方へ</p> <p style="text-align: center;"> 警告 WARNING</p> <p>装置を引き出したり、装置の積み下ろしを行う際は、必ずラック前面にあるスタビライザを引き出し確実に設置してから作業を行ってください。スタビライザを引き出さないまま作業を行うと、ラックの破損、転倒など事故の原因となります。</p> <p>Always extract and install the stabilizers when pulling out ore unloading components from the rack. Operating on the rack without the stabilizers in place may cause damage to the rack or allow the rack to tip over.</p> </div>	
053	<div style="border: 1px solid black; padding: 5px;"> <p style="text-align: center;">保守者の方へ</p> <p style="text-align: center;"> 危険 DANGER</p> <p>本ラックを床に耐震固定しないで設置する場合、必ずスタビライザを取り付けて設置してください。スタビライザを取り付けないと、ラックの転倒など事故の原因となります。設置前に、必ず保守説明書をお読み下さい。</p> <p>Always install the stabilizers when not bolting to the floor for seismic restraint. Operating on the rack or allow the rack to tip over. Please read the Service Manual before installation.</p> </div>	
055	<div style="border: 1px solid black; padding: 5px;"> <p style="text-align: center;"> 注意 CAUTION</p> <p>指をドアに挟まないよう、注意してください。 Take care not to pinch your finger in the door.</p> </div>	

243-304367-GRP	MARKINGS
001	<div style="border: 1px solid black; padding: 5px;"> <p style="text-align: center;">保守者の方へ</p> <p style="text-align: center;"> 警告△WARNING</p> <p>本ラックを仮置き、設置する際は必ずレベルを降ろして下さい。 ラックの転倒など事故の原因となります。</p> <p>Always△install△the△leveler△when△setting the△rack. If△the△leveler△is△not△installed, it△may△cause△the△rack△to△tip△over.</p> </div>

243-306629-GRP	MARKINGS
001	<div style="border: 1px solid black; padding: 5px;"> <p> See△operation△manual△before connecting△the△supply. Y01-912</p> <p>Lisez△le△manuel△d'utlisation avant△de△connecter△à△la△source. 001</p> <p> 電源接続前に取扱説明書をお読みください。</p> </div>
002	<div style="border: 1px solid black; padding: 5px;"> <p> Check△input△power△source. Y01-912</p> <p>Vérifier△la△tension△de l'appareil. 202-101</p> <p>入力電圧を確認して下さい。 002</p> </div>

Preface

This document explains how to operate the hardware of the base module, the main body of this system. It is recommended that the related documents be read in order to make the best use of the above-mentioned system.

Special techniques are necessary for installing and expanding the system. Please consult our sales personnel.

Rev. 1, May 2006

Notes:

- (1) All rights reserved. This document cannot be reprinted or reproduced partly or entirely without permission from NEC Corp.
- (2) The contents of this document may be changed at any time without prior notice.

Contents

Chapter 1	NX7700i/5020M-16 System Overview	1-1
1.1.	Configuration and Specifications of the Base Module	1-2
1.2.	Expandability	1-6
1.2.1.	Adding Processors.....	1-6
1.2.2.	Expanding Memory Capacity	1-6
1.2.3.	Adding Cells.....	1-6
1.2.4.	Adding I/O Modules	1-6
1.2.5.	Adding Peripheral Units	1-6
Chapter 2	Base Module	2-1
2.1.	Partition Function.....	2-2
2.2.	Name and Function of Components	2-3
2.2.1.	Cabinet (Primary Cabinet)	2-3
2.2.2.	Base Module	2-4
2.2.3.	Expansion Power Bay	2-4
2.2.4.	Cell.....	2-4
2.2.5.	I/O Module	2-4
2.2.6.	Power Bay.....	2-5
2.2.7.	iSP	2-6
2.2.8.	DVD-ROM Unit	2-7
2.2.8.1.	Loading and Unloading Media	2-7
2.2.9.	DAT Unit.....	2-8
2.2.9.1.	Location of Index Labels	2-8
2.2.9.2.	Notes on Index Labels	2-8
2.2.9.3.	Preventing Accidental Erasure of Data.....	2-8
2.2.9.4.	Cleaning the DAT Unit.....	2-9
2.2.9.5.	Cleaning Schedule	2-9
2.2.9.6.	Cleaning Medium for the DAT Unit.....	2-9
2.2.9.7.	Life of Data Cartridge (Tape) for the DAT Unit	2-9
2.2.9.8.	Handling of the DAT Unit.....	2-9
2.2.9.9.	Notes on the DAT Unit.....	2-10
2.2.9.10.	Loading and Unloading Digital Audio Tapes.....	2-10
2.2.10.	Notes on Installing the UPS	2-11
2.2.11.	System LEDs	2-13
2.3.	Consoles.....	2-14
2.3.1.	SP Console	2-14
2.4.	Service Processor (SP)	2-16
2.4.1.	Console Connection and Login	2-16
2.4.1.1.	Type of Console Connections	2-16
2.4.1.2.	Accessible Console Functions	2-16
2.4.1.3.	Console Status and Login Authentication.....	2-17
2.4.1.4.	Login and Main Menu.....	2-19
2.4.2.	Note	2-21
2.4.3.	OS (BIOS) Console.....	2-22
2.4.4.	Virtual SOP	2-24
2.4.4.1.	Details of Partition Status Display	2-26
2.4.5.	SP Command Console.....	2-27
2.4.5.1.	SP Command Console Buffer	2-28
2.4.5.2.	SP Command Prompt	2-28
2.4.5.3.	SP Message Header	2-28
2.4.5.4.	SP Command List	2-29
2.4.6.	SP Command Reference	2-32
2.4.6.1.	DF (Shut down System Power <override>).....	2-33
2.4.6.2.	DN (Shut down System Power)	2-35
2.4.6.3.	DP (System Dump)	2-36

2.4.6.4.	DT (SP Data and Time)	2-37
2.4.6.5.	EN (Environmental Information)	2-38
2.4.6.6.	FV (Firmware Versions)	2-44
2.4.6.7.	HC (Hardware Configuration)	2-45
2.4.6.8.	HE (Help)	2-71
2.4.6.9.	ML (Message Log)	2-72
2.4.6.10.	PC (Power Cycle).....	2-74
2.4.6.11.	RS (Cold Reset System)	2-75
2.4.6.12.	SG (SP/System Setting).....	2-76
2.4.6.13.	SR (Save System CMOS/NvRAM)	2-87
2.4.6.14.	UB (Bring up BIOS)	2-89
2.4.6.15.	UP (Bring up System).....	2-90
Chapter 3	Operation Procedure	3-1
3.1.	System Startup	3-1
3.1.1.	System Startup Procedure	3-1
3.1.2.	SP Console Messages.....	3-5
3.2.	System Shutdown	3-7
3.2.1.	System Shutdown Procedure.....	3-7
3.2.2.	SP Console Messages.....	3-10
3.3.	Emergency System Shutdown with AC SW	3-11
3.4.	AC-LINK (Auto Control)	3-11
3.5.	OS Boot	3-13
3.5.1.	OS Boot with Boot Manager (Before Installing the OS)	3-13
3.5.2.	OS Boot from the EFI (Extensible Firmware Interface) Boot Manager	3-14
3.5.3.	EFI Shell	3-15
3.5.4.	EFI Shell Commands	3-15
3.5.5.	OS Boot from EFI Shell.....	3-18
3.5.6.	EFI Devices.....	3-20
3.5.7.	EFI Boot Option Maintenance	3-23
3.5.7.1.	Boot from a File	3-25
3.5.7.2.	Add a Boot Option.....	3-26
3.5.7.3.	Add Boot Option(s).....	3-27
3.5.7.4.	Change Boot Order	3-27
3.5.7.5.	Manage BootNext Setting	3-28
3.5.7.6.	Set Auto Boot Timeout	3-29
3.5.7.7.	Setting the Network Boot	3-30
3.5.7.8.	Changing BIOS Settings	3-32
3.6.	System Dump	3-34
Chapter 4	Troubleshooting	4-1
4.1.	Troubleshooting	4-1
Chapter 5	Notes on Handling	5-1
5.1.	Transportation.....	5-1
5.2.	DVD-ROM/CD-ROM.....	5-1
5.3.	Digital Audio Tape	5-1
5.4.	Cleaning.....	5-2
5.5.	Notes on Installation	5-3

Chapter 1 NX7700i/5020M-16 System Overview

This system is a server that implements the following by using the high performance Intel Itanium2 processor:

- High processing capability
- Open system using the industry standard architecture
- Advanced system management and RAS function
- High system expandability with a host of optional products

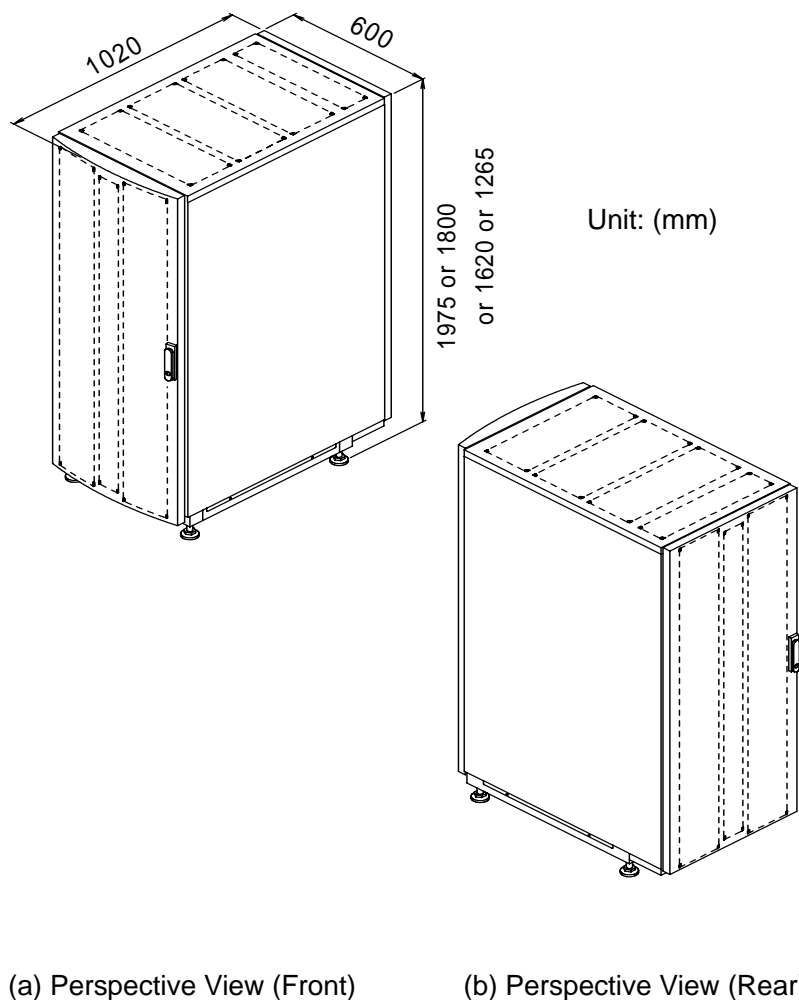

Figure. External Views of the Cabinet

1.1. Configuration and Specifications of the Base Module

The base module of this system is composed of the following hardware components:

- CELL
Can install one to four Intel Itanium2 processors.
The minimum required memory capacity is 2GB and can be expanded up to 128GB.

- I/O MODULE
Can contain:
Up to 8 PCI cards
A DVD-ROM unit
A DAT unit
Up to 4 HDDs (up to two HDDs when DAT is used)

- POWER BAY
Can contain to 3 DPSs (AC/DC converters).

The iSP of the base module supports the following interfaces as standard equipment:

- (1) 10/100Base-TX Ethernet interface for the SP console
- (2) Serial (RS-232C) interface for the SP console

Layout of the base module components and system specifications are shown in the subsequent pages.

■ Front View

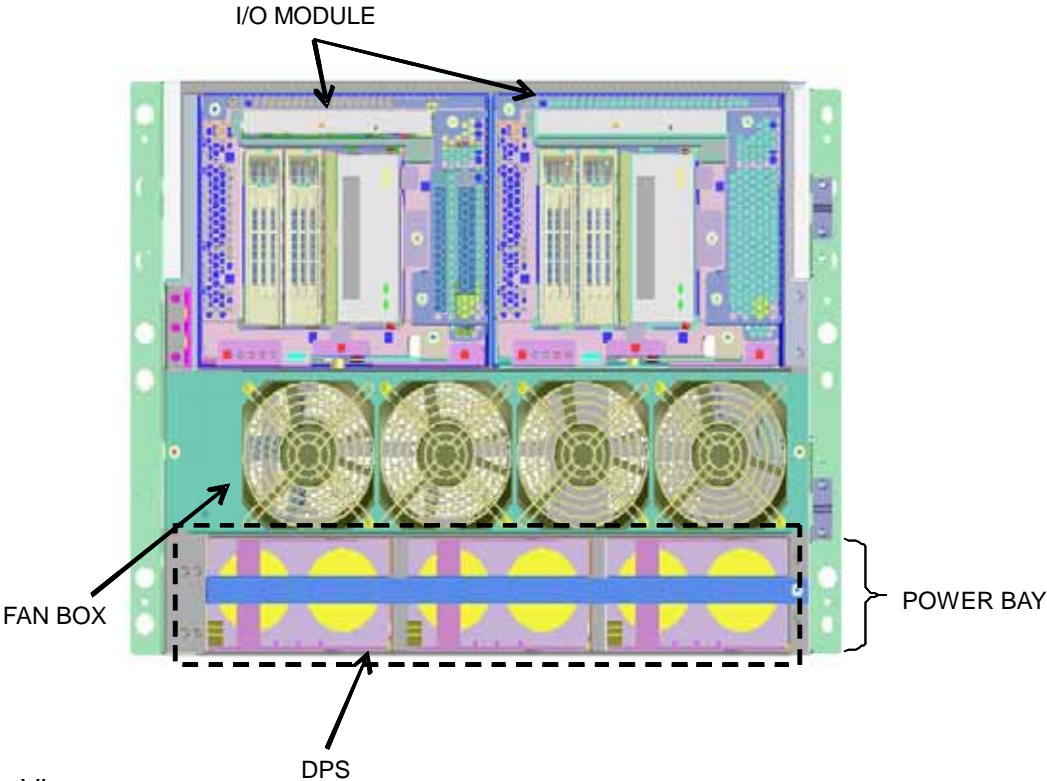

■ Rear View

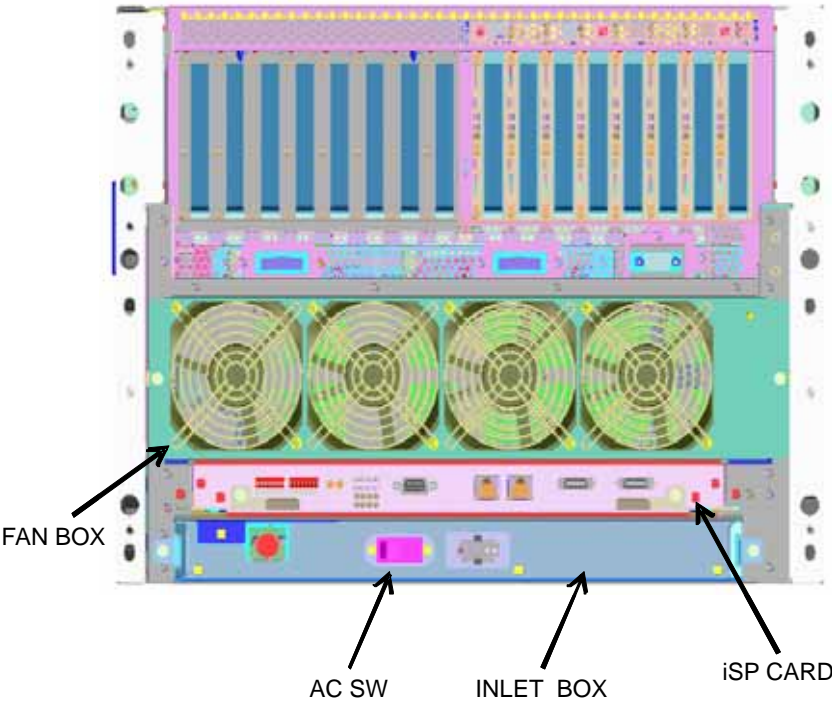

Figure. Layout of Parts in the Base Module

Table. Base Module Specifications

BASE MODULE		
Cell (Max. 2 cells can be installed in the base module.)		
CPU		
Max. No. of processors	8 (Max. 4 processors/cell)	
Main memory		
Expansion unit	2GB/4GB/8GB	
Main memory capacity	2GB to 128GB	
I/O module (Max. 2 modules can be installed.)		
Max. No. of PCI slots	16 slots (133MHz)	
Max. I/O bandwidth	67GB/s	
DVD-ROM unit	One unit can be installed in the I/O module. DVD-ROM/CD-ROM mode	
DAT unit	One unit can be installed in the I/O module. DDS-4 4mm DAT unit	
Magnetic disk unit	Max. 4 units can be installed in the I/O module (2 units when DAT is installed). Selection from 73GB/146GB/300GB	
POWER BAY (One unit can be installed in the base module.)		
DPS (Max. 3 units can be installed.)		

Note) Components are installed in the cabinet in units of the base module (an expansion power bay will be mounted depending on the form of power supply). A maximum of four base modules can be installed in a cabinet.

The expansion power bay is mounted under the base module when power is supplied from two systems or 100VAC. It depends on the form of power supply.

Table. Base Module Specifications (Cont'd)

Main Cabinet	
Cabinet size/weight Note 2)	
Width	600mm
Height	1265/1620/1975mm
Depth Note 1)	1050mm
Weight (in max. configuration)	545Kg
Power supply	
Voltage	Single-phase, 200 to 240V±10%
Frequency	50/60Hz±1Hz
Power consumption (in max. configuration)	13.2kVA
Environmental conditions	
Temperature	
Operating	+5°C to +32°C
Storage	+5°C to +45°C
Humidity	
Operating	20% to 80% (no condensation)
Storage	8% to 80% (no condensation)

Note 1) Three types of cabinets are provided, each having a different height.

Note 2) The depth including the handle of the back door is 1070mm.

1.2. Expandability

This section explains the expandability of this system and available configurations.

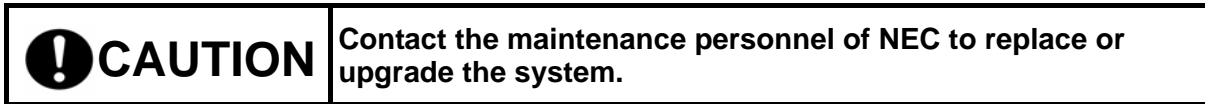

1.2.1. Adding Processors

At least one processor is required for the base module. Using the CPU expansion feature, the Itanium2 processor can be added one by one. Up to four processors can be installed for each cell. To install more than four processors, the cell must be added first using the cell expansion feature. A maximum of 8 processors can be installed in the base module.

1.2.2. Expanding Memory Capacity

The minimum required memory capacity for the base module is 2GB. This memory capacity can be expanded up to 64GB for each cell. This means a maximum of 128GB of memory can be installed in the base module.

2GB, 4GB and 8GB memories are supported at present. For other memories, inquire the sales personnel of NEC.

1.2.3. Adding Cells

At least one cell is required for the base module. For system expansion, such as the addition of processors, the cell must be added first using the cell expansion feature. Up to 2 cells can be installed in the base module.

1.2.4. Adding I/O Modules

At least one I/O module is required for the base module. A maximum of two I/O modules can be installed in the base module.

A maximum of four magnetic disk units can be mounted on the built-in device bay of the I/O module. The magnetic disk units supported at present are 73GB, 146GB and 300GB HDD. For other types, contact the sales personnel of NEC.

1.2.5. Adding Peripheral Units

The iSP is installed in the base module to satisfy various customer's requirements for system configurations. The system is designed to connect a wide variety of peripheral units through this iSP. Peripheral units can also be connected through various types of PCI cards available on the I/O module.

BASE MODULE

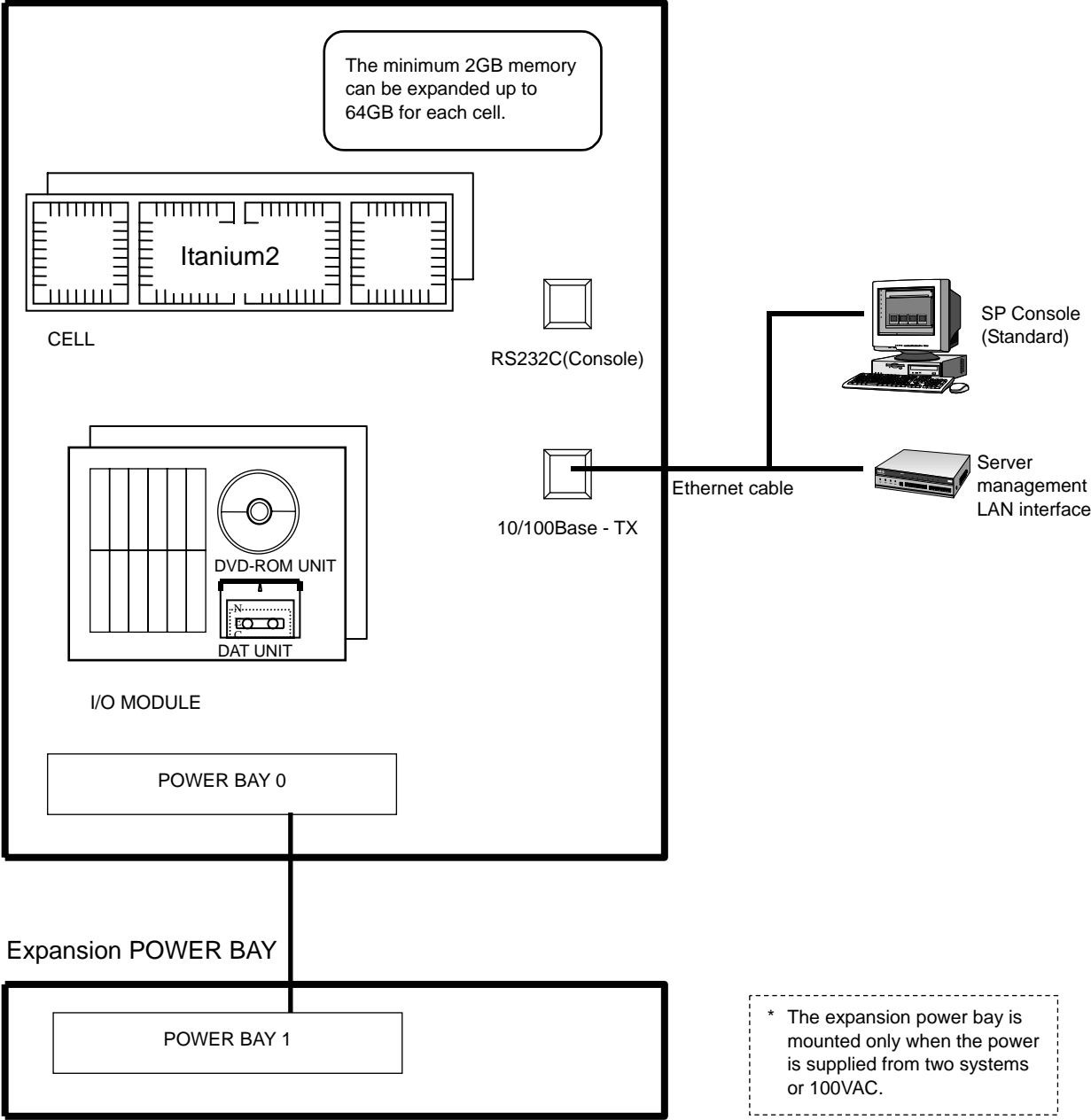

Figure. System Configuration

Chapter 2 Base Module

This chapter covers operations required on the base module of this system.

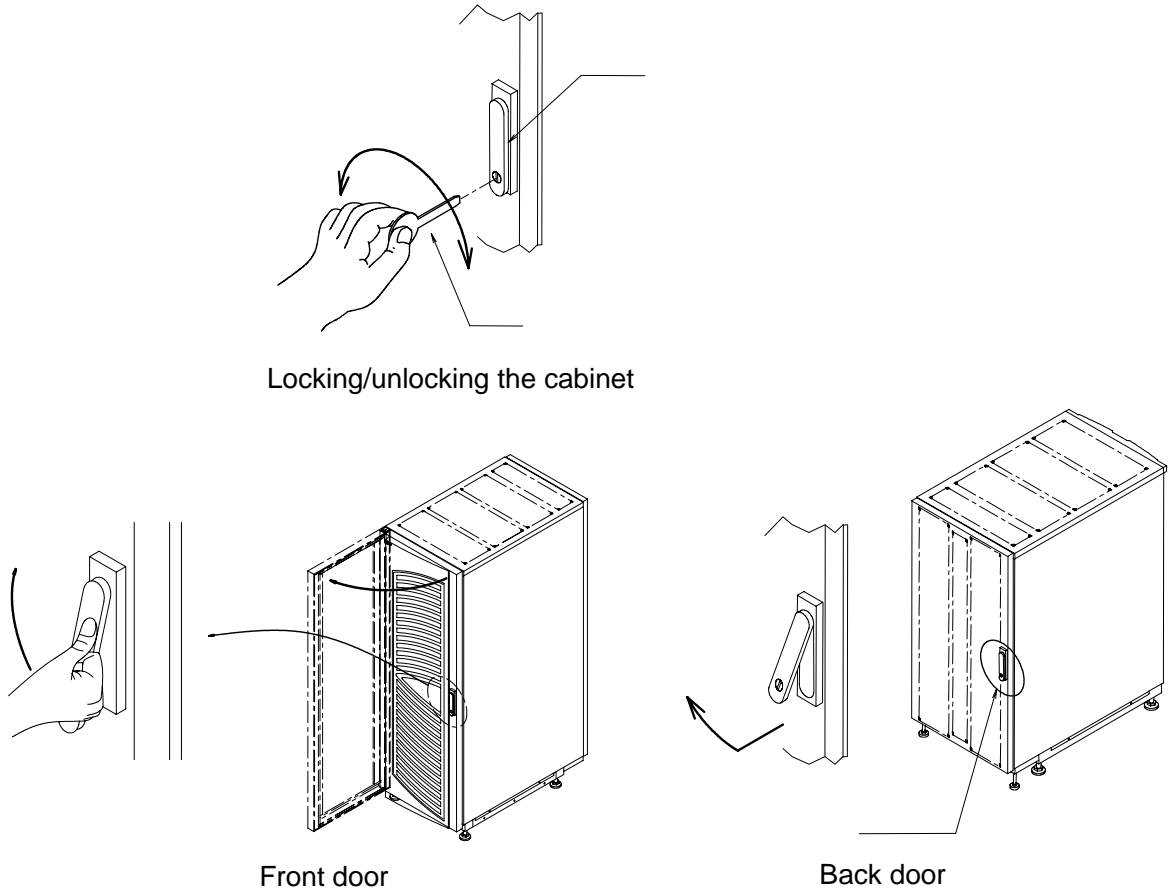

Figure. Doors of Cabinet

2.1. Partition Function

The base module has the partition function which enables the system to operate as if multiple units are present on one unit.

The system is capable of partitioning in units of the cell or I/O module within the same base module. For example, in a system consisting of two cells and two I/O modules, partitioning shown in the figure below is possible.

Note that each partition should contain at least one cell card and one I/O module (including the core module).

The partition structure in the base module can be changed with the "hc" command of the SP command. (For details of the SP command, see 2.4.6 SP Command Reference.)

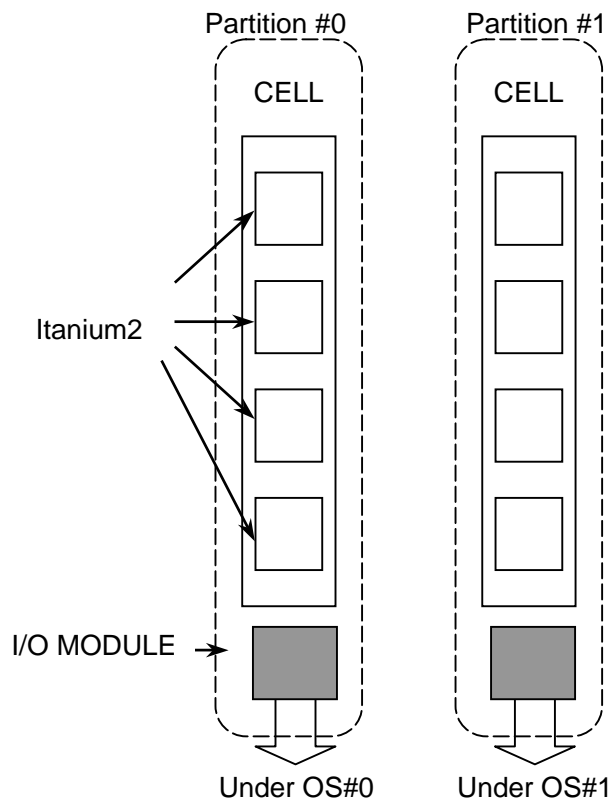

Figure. Image of Partitions

2.2. Name and Function of Components

2.2.1. Cabinet (Primary Cabinet)

The base module and expansion power bay (POWBAY#1) are installed in the cabinet. The number of installable base modules depends on the size of the cabinet. A maximum of four base modules can be installed in the largest cabinet.

The example below shows that the system is installed in the 1620mm high cabinet.

M-zz indicates “U” (unit size) from the bottom is zzU [1U is about 44mm].

The base module is 8U, and POWBAY#1 is 2U in height.

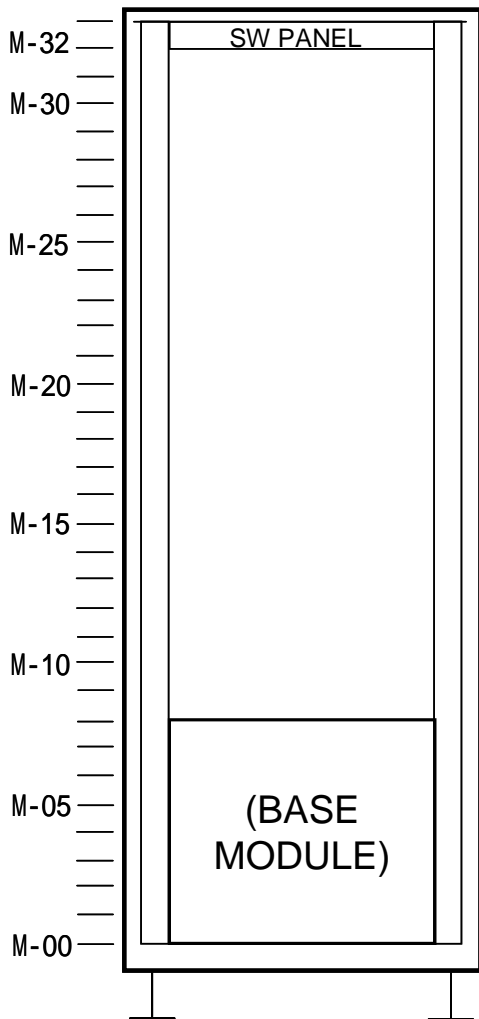

(a) Installation of the Base Module

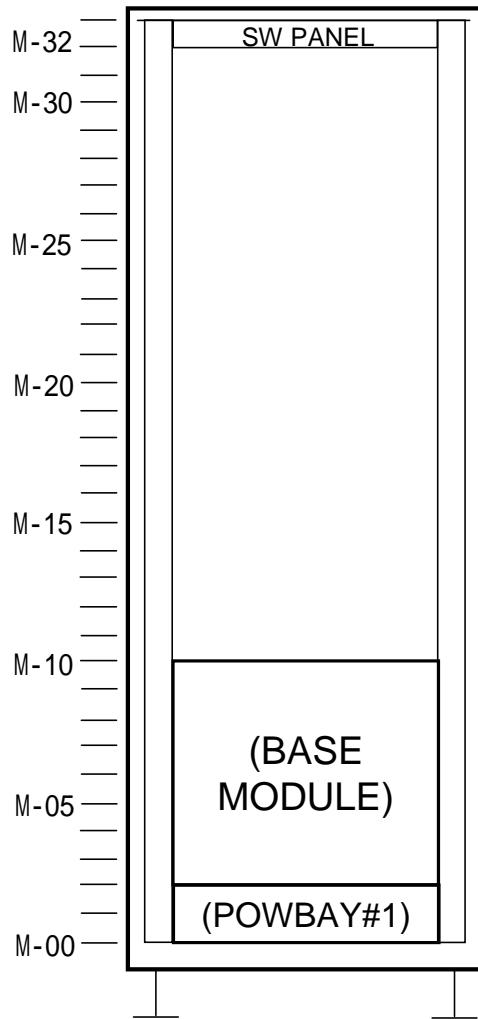

(b) Installation of the Base Module + Power Bay

2.2.2 Base Module

A base module is composed of cells, iSP cards, I/O modules, power bays, and DPSs.

2.2.3 Expansion Power Bay

The expansion power bay is used only when the power is supplied from two systems or 100VAC. It is never used for a single power supply system.

2.2.4 Cell

A cell is composed of up to four processors, a CPU node controller, a memory controller, and main memory. The main memory can vary from the minimum 2GB to the maximum 64GB. At least one cell needs to be installed for the base module. Up to two cells can be installed.

2.2.5. I/O Module

The I/O module provides 8 PCI slots corresponding to 133MHz PCI-X buses, allowing up to 8 PCI cards to be used.

The PCI card can be inserted or taken out in online mode (hereafter called the “hot swap”) with some exceptions. Consequently, the base module need not be shut down or rebooted each time the PCI card is added or replaced. High availability is achieved with this implementation (note that the OS that supports this implementation is required).

One core module or HDD module is mounted on the I/O module. At least one core module is required for each partition.

A DVD-ROM unit is installed in the I/O module as standard equipment. In addition, a DAT unit and up to four 73GB/146GB/300GB magnetic disk units can be installed as optional units.

At least one I/O module is required for the base module.

2.2.6. Power Bay

The power bay supplies power to the system. A maximum of three DPSs (a DPS is a system power supply with a fan) can be installed in the power bay.

The expansion power bay is used only when the power is supplied from two systems or 100VAC.

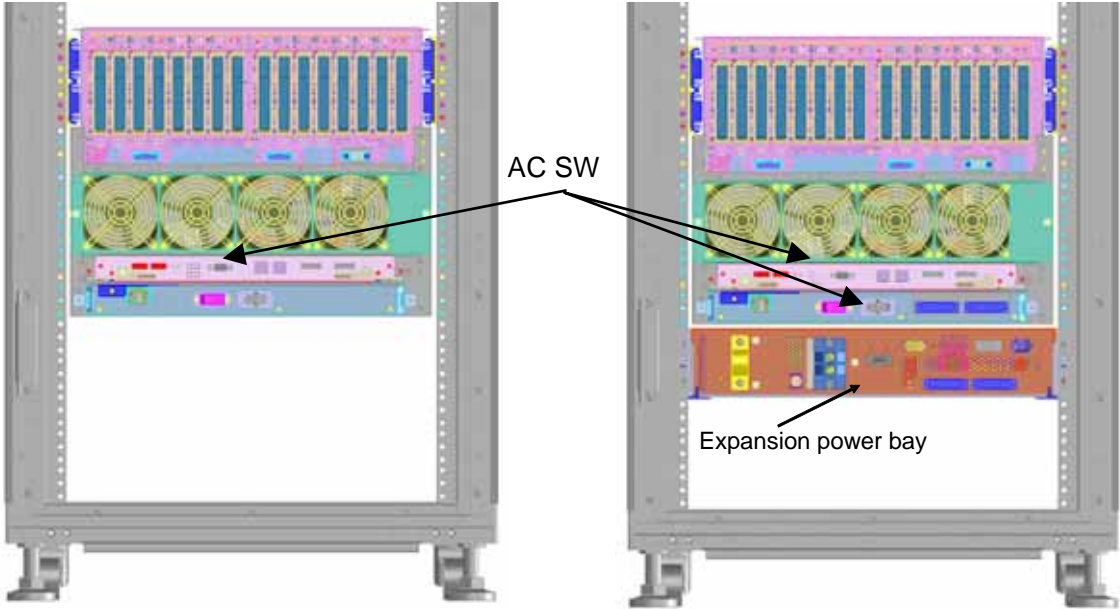

(a) Power supply from a single system (N+1) [200VAC] (Rear View)

(b) Power supply from two systems (2N) [200VAC] (Rear View)

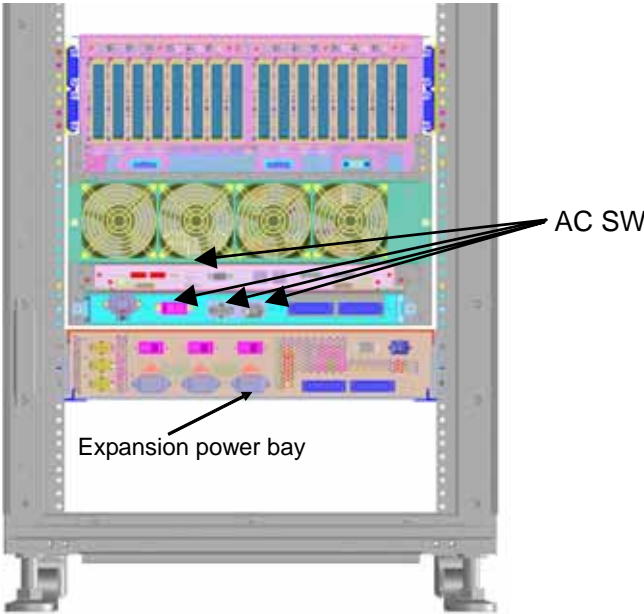

(c) Power supply from 100VAC (Rear View)

2.2.7. iSP

One iSP-C card is mounted on the base module as standard equipment. It contains the following interfaces:

- 1) 10/100Base-TX Ethernet interface (x1) for SP console
- 2) Serial (RS-232C) interface (x1) for SP console

The iSP-C card is shown below.

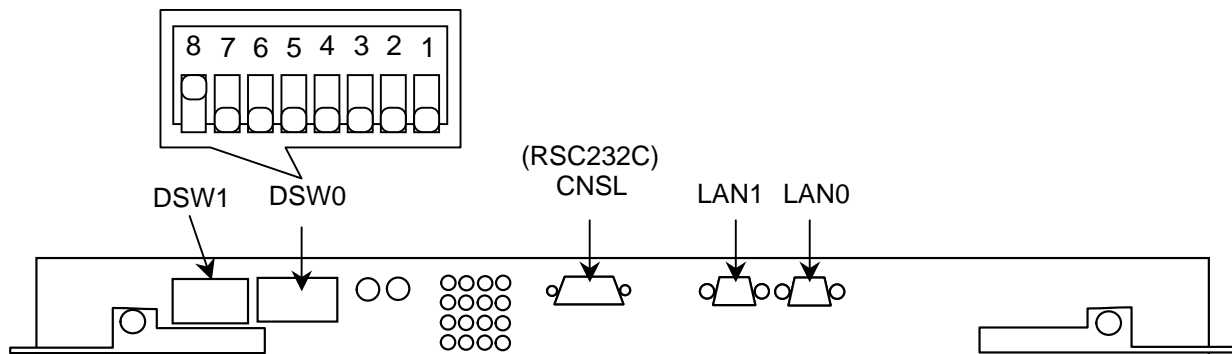

Figure. Rear panel of iSP (Installed in the Base Module)

2.2.8. DVD-ROM Unit

One DVD-ROM unit can be installed for each I/O module. A DVD-ROM unit is mounted on each I/O module as standard equipment. The DVD-ROM and CD-ROM media can be used on the DVD-ROM unit.

2.2.8.1. Loading and Unloading Media

(1) Loading DVD-ROM/CD-ROM

- 1) Open the front cover, and remove the mask. (loosen the hand screw).
- 2) Push the Eject button lightly, and the tray pops out.
- 3) Place DVD-ROM/CD-ROM securely on the tray.
- 4) Push the Eject button lightly, and the tray goes back in the drive.

(2) Unloading DVD-ROM/CD-ROM

- 1) Be sure that the DVD-ROM drive access indicator LED (orange) goes off.
- 2) Push the Eject button lightly, and the tray pops out.
- 3) Take out DVD-ROM/CD-ROM.

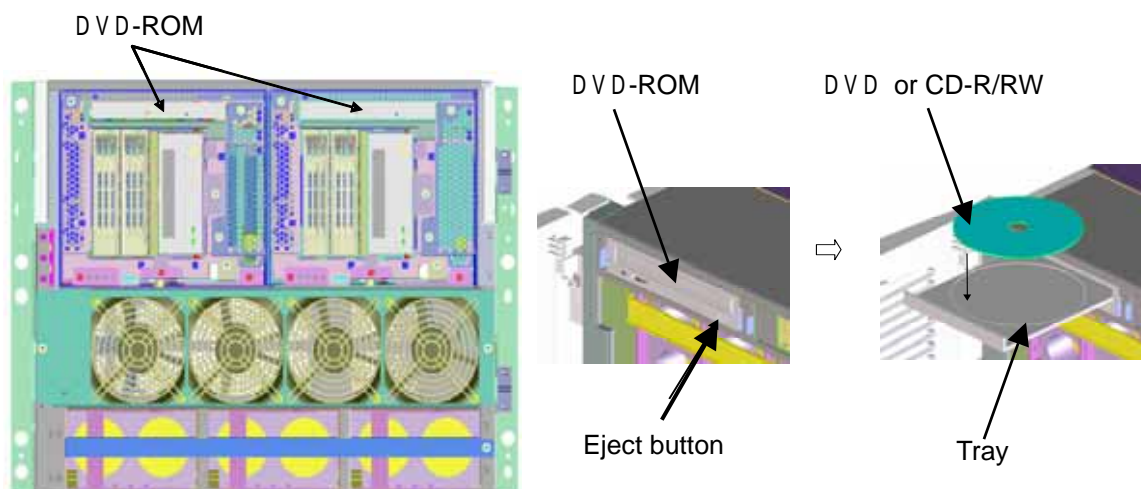

Figure. Loading and Unloading DVD-ROM/CD-ROM

2.2.9. DAT Unit

An optional DAT unit can be installed in the I/O module.

2.2.9.1. Location of Index Labels

The figure below shows the location of index labels attached to the digital audio tape.

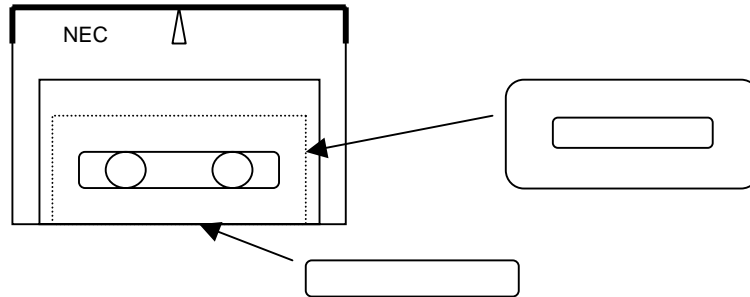

Figure. Index Labels on the Digital Audio Tape

2.2.9.2. Notes on Index Labels

- (1) Attach index labels properly as shown in 2.2.9.1. Be sure to write the start date on these labels.
- (2) Change the labels when the DAT is used for other purpose. Remove the old labels before attaching the new labels.
- (3) When using index labels other than those supplied by NEC, make sure that they are in the right size and easy to remove without remnant paste.

2.2.9.3. Preventing Accidental Erasure of Data

Open the write protect slider next to the side label of the cartridge to prevent data on the DAT from being erased by accident. Write on the DAT is permitted by closing the write protect slider.

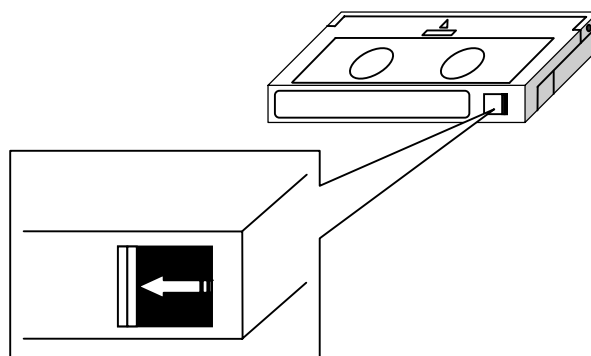

Figure. Preventing Accidental Erasure of Data on DAT (Write Protect)

2.2.9.4. Cleaning the DAT Unit

Wipe off the dusts on the DAT unit. See 2.2.9.5 to 2.2.9.7 for how to clean the DAT unit.

2.2.9.5. Cleaning Schedule

How often the DAT unit should be cleaned depends on the operating environment. The table below will be of some help.

Frequency of using data cartridge	Cleaning schedule
Use of one cartridge per day	Once a week
Use of 2 to 3 cartridges per day	Twice a week
Use of more than 3 cartridges per day	Everyday

Cleaning is important to remove accumulated dust on the magnetic head caused by running tapes and surrounding environment. Periodic cleaning is recommended.

2.2.9.6. Cleaning Medium for the DAT Unit

The cleaning cartridge can be used approximately 50 times.

Clean the drive head with this cartridge before using the new data cartridge. It is recommended to clean the head prior to writing or reading the DAT. Clean the head once a month even though the DAT unit is not used.

2.2.9.7. Life of Data Cartridge (Tape) for the DAT Unit

The life of data cartridge according to the frequency of use is shown below. It may be shortened depending on the operating environment (temperature, humidity, dust, etc.).

Frequency of using data cartridge	Life
Once a week/volume	Approx. one year
Three times a week/volume	Approx. half a year
Everyday	Approx. three months

The data cartridge is worn out every time it is read or written. It should be noted that using the worn-out cartridge will cause trouble. To prevent trouble caused by aged deterioration, storage of the data cartridge should not exceed five years.

2.2.9.8. Handling of the DAT Unit

Keep the following in mind for proper operation of the DAT unit:

- Do not move the DAT unit with the cleaning or data cartridge loaded.
- Take out the cleaning or data cartridge before turning off the DAT unit.
- Do not leave the DAT unit for a prolonged period of time with the cleaning or data cartridge loaded.

2.2.9.9. Notes on the DAT Unit

Avoid placing the DAT unit in the following locations as much as possible to prevent trouble in the DAT unit:

- Near the printer (to prevent toner or paper powder dusts)
- By the window or near the passage way (to prevent soil dusts)
- On the carpet (to prevent dust generation)

2.2.9.10. Loading and Unloading Digital Audio Tapes

How to load and unload a digital audio tape is explained below.

(1) Loading a digital audio tape

- 1) Remove the front filter cover of the I/O enclosure (loosen the hand screw).
- 2) Hold the DAT lengthwise with the DAT label oriented to the left, and insert it into the drive vertically and slowly.
- 3) Keep pushing the tape slowly until you feel it touching the stopper inside the drive and being locked in the drive. When the tape is locked, a clicking sound is heard.

(2) Unloading a digital audio tape

- 1) Be sure that the DAT drive access indicator LED (green) goes off.
- 2) Push the Eject button at the lower part of the DAT unit lightly.
- 3) The DAT slides out from the drive.
- 4) Take out the DAT from the drive vertically and slowly.

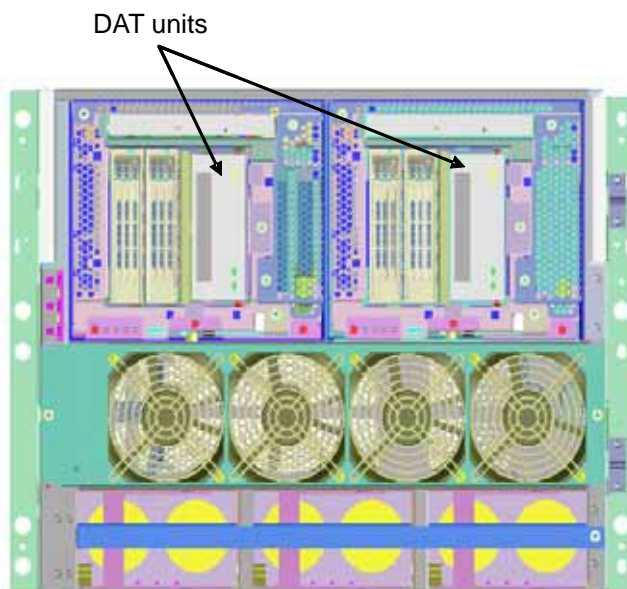

Figure. DAT Units

2.2.10. Notes on Installing the UPS

To installed the UPS, remove the signal cable for power control (on/off), and mount a jumper connector (shown in the figure below).

This system has three forms of power supplies [a), b) and c) below]. It should be noted that the location of the jumper connector differs depending on the form of power supply.



Figure. Jumper Connector for Installing the UPS

a) Power supply from a single system

Location on the inlet box: P1

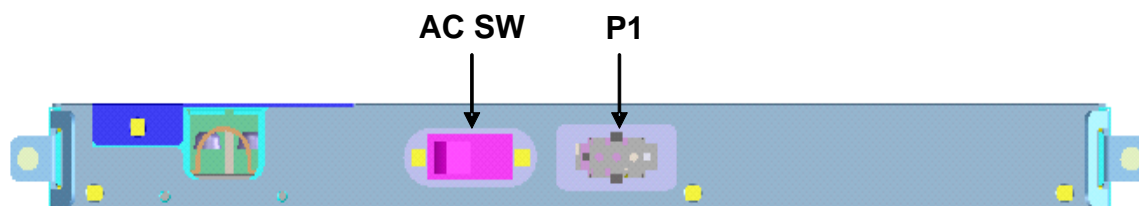

Base Module

- b) Power supply from two systems

Location on the inlet box: P1

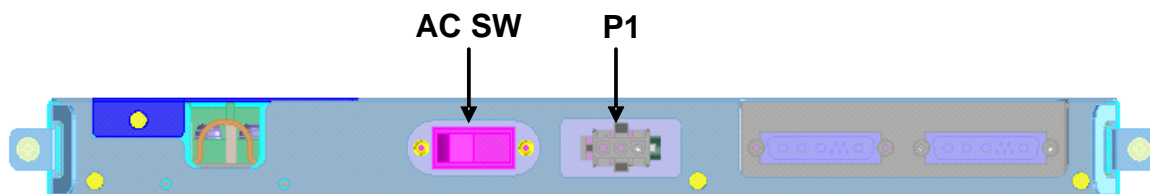

Location on the expansion power bay: P3

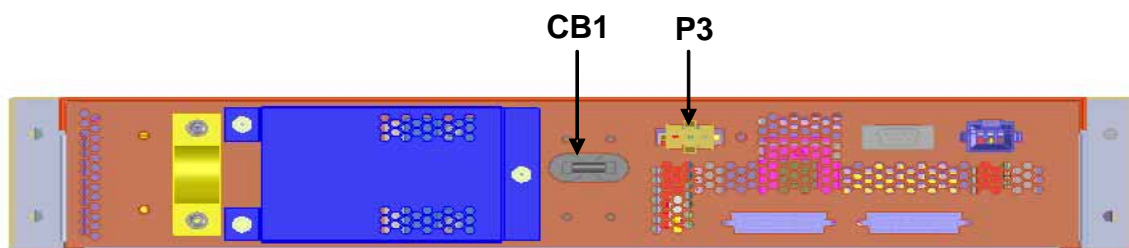

- c) Power supply from 100VAC

Location on the inlet box: P1

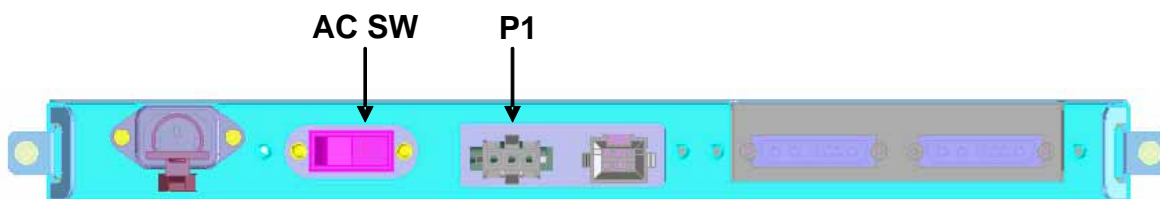

Location on the expansion power bay: P5, P6, P7

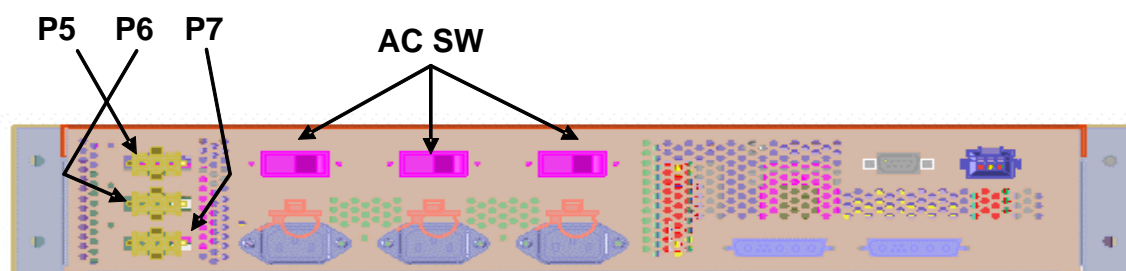

2.2.11. System LEDs

System LEDs are located at the upper left of the front panel of the base module and indicate the system status. The views when the front panel is opened (a) and closed (b) are shown below.

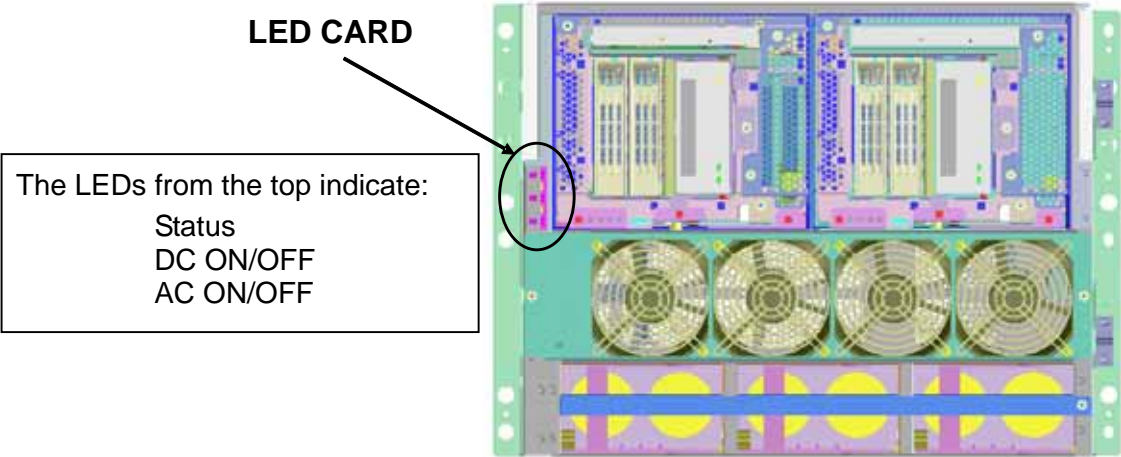

(a) LEDs with the front panel opened

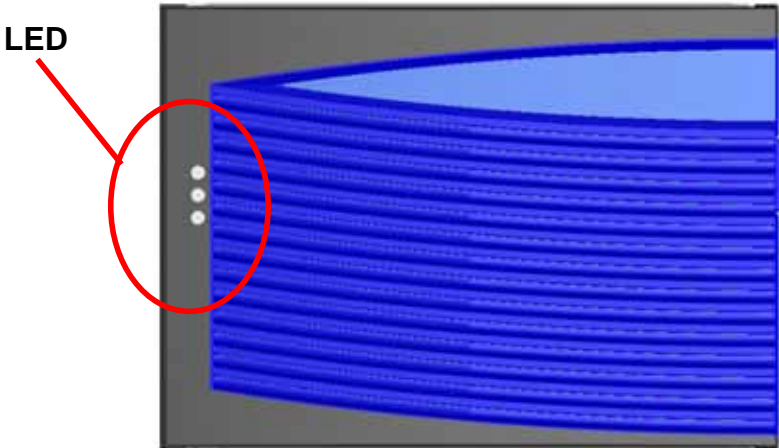

(b) LEDs with the front panel closed

■ LED Indication

LED name	Color & status		Description
AC ON/OFF	Green	ON	AC ON
		OFF	AC OFF
DC ON/OFF	Green	ON	DC ON (48VDC is supplied.)
		OFF	DC OFF
Status LED	Green	ON	System is online.
		Flash	System is in maintenance mode.
		OFF	Other (error, offline)

2.3. Consoles

The base module contains console interfaces as standard equipment. The consoles connected to the interfaces provided by the iSP are roughly classified into two:

- OS console (also called the system console or SW console) to display BIOS/OS messages
- SP console (also called the HW console) to display SP messages

2.3.1. SP Console

The SP console required:

- Recommended Windows2003 operation environment
- One LAN port

The console connection diagram is shown in the subsequent page. The iSP-C standard I/O interface connected to "Console PC" in this figure is:

- Ether Port (10/100Base-TX)

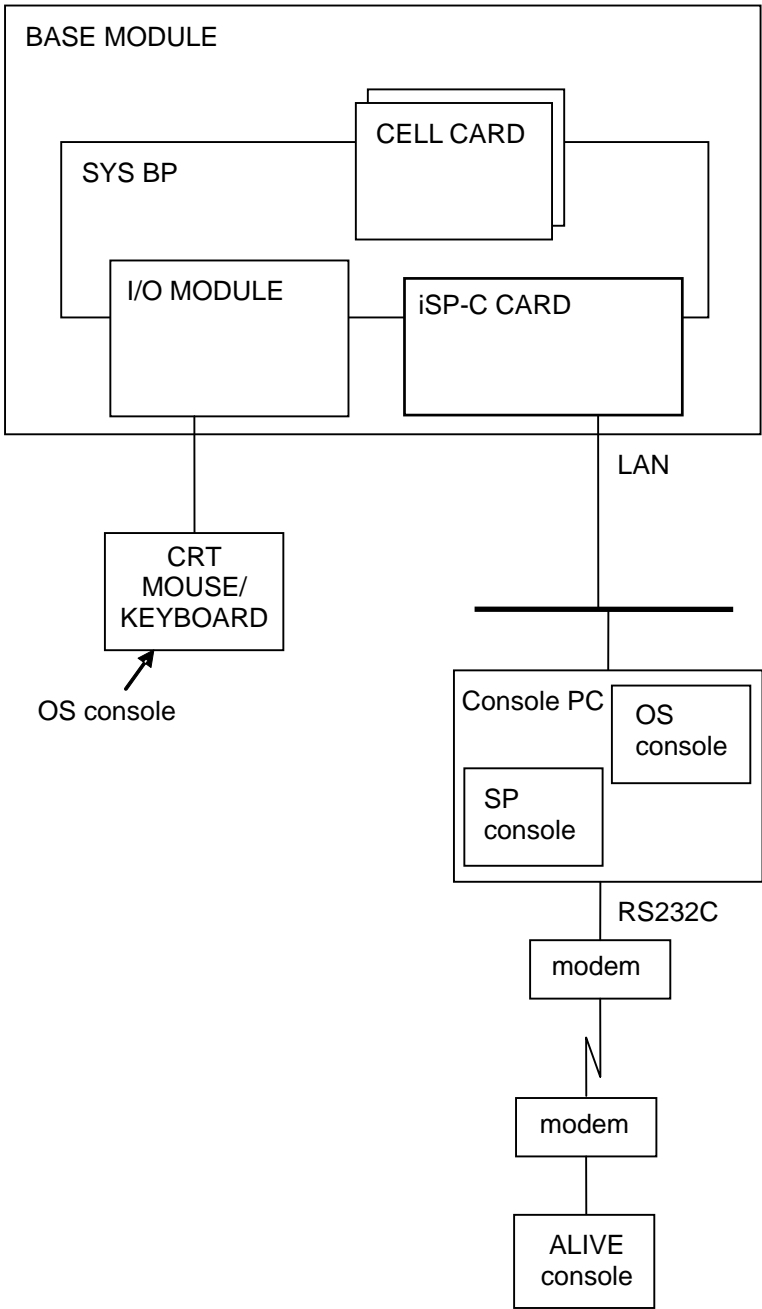

Figure. Console Connection Diagram

2.4. Service Processor (SP)

This system contains interfaces to offer advanced system management and RAS function to the user. The service processor (hereafter called the “SP”) in the iSP implements these capabilities.

2.4.1. Console Connection and Login

2.4.1.1. Type of Console Connections

The iSP supports two types of console connections: i.e. local console connection via serial port and LAN console connection via TCP port 5001.

Either type of connection provides completely identical user interface, except that all LAN configuration such as IP address setting can only be done from the local console.

For the details of serial port and LAN configuration, refer to the “SG Command Reference.”

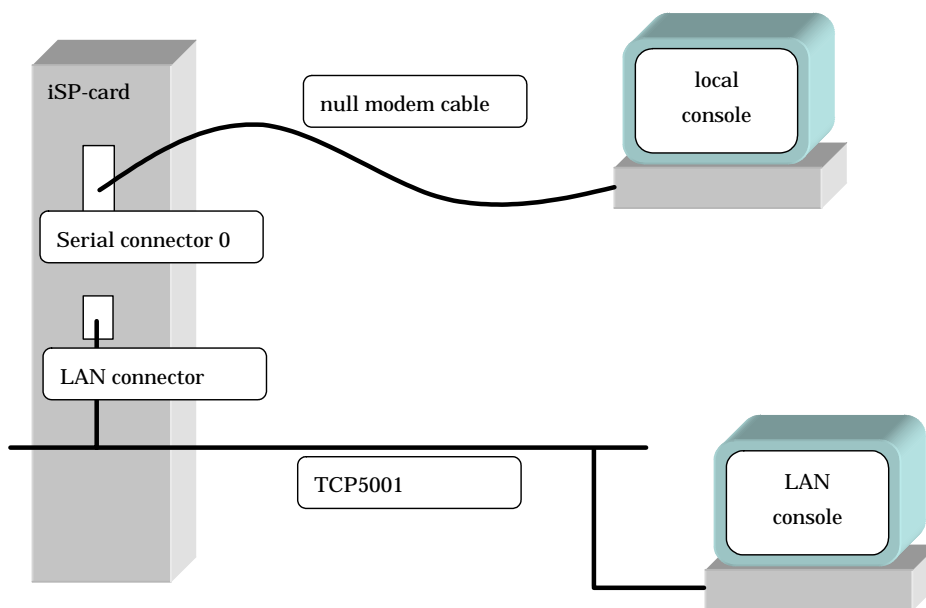

Figure. Type of Console Connections

2.4.1.2. Accessible Console Functions

The console operator has access to the following console operations:

- iSP operation using SP commands
- Redirection of OS (BIOS) serial (inside the CPU) console
- Virtual SOP display

2.4.1.3. Console Status and Login Authentication

To gain access to console operation, you must first login to the iSP.

When you login to the iSP, the Main Menu opens. The Main Menu has three options: i.e. Virtual SOP, OS Console, and SP Command Console.

- Virtual SOP provides periodical updates to system operation status for each partition.
- OS Console redirects serial I/Os as viewed from the OS (including BIOS).
- SP Command Console lets you monitor iSP messages for system or maintenance operations and enter commands into the iSP. Only the commands required for system operation can be executed on the SP Command Console.

Factory default login account and password

Type	Default
Login account	spfw
Login password	nec

The numbers of consoles that can be attached to the system at a time are: Up to one OS Console for each partition; up to nine Virtual SOPs and up to one SP Command Console throughout the entire system.

OS Console and SP Command Console include two types: i.e. one that allows console input (with operational authority) and the other that only allows message displays (with no operational authority). The OS Console that is first attached to the specified partition is given operational authority. Similarly, the SP Command Console that is first attached to the system is given operational authority. Once a console is attached with no operational authority given to it, it cannot acquire operational authority until the existing console with operational authority is disconnected or its operational authority is removed in the Main Menu.

If key entry is attempted on a console without operational authority, it will output the message, "This console is mirror console."

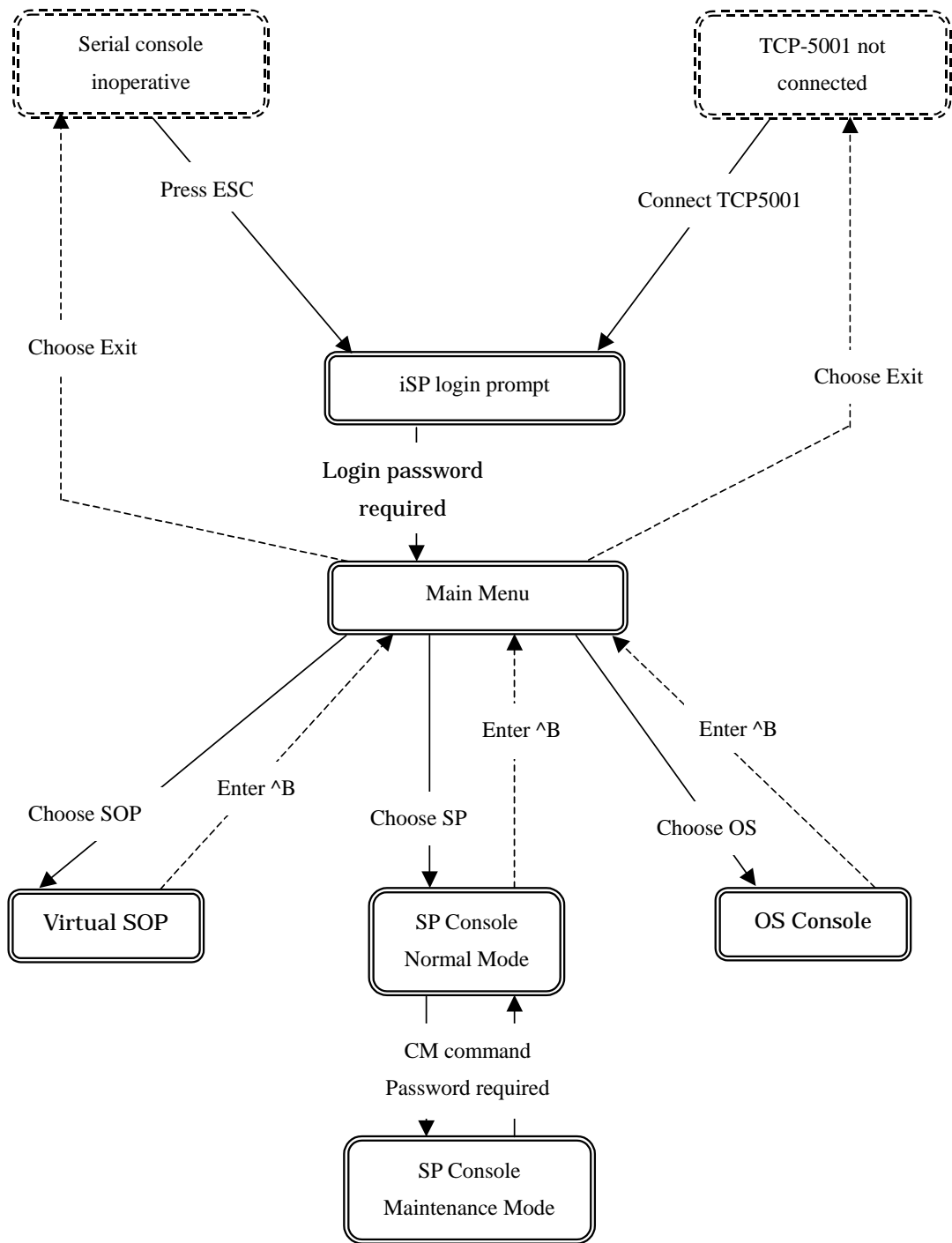

Figure. Console Mode Status Transitions

2.4.1.4. Login and Main Menu

Immediately after a console is attached to the iSP, login prompts appear on the console, waiting for user login. When you enter your login account name and password, the Main Menu opens.

Login account and password are both case-sensitive. Alphabetic letters used in the Main Menu are not case-sensitive, however (e.g. “e” and “E” are interpreted as the same character).

(Screen Example)

	Description No.
Integrated Service Processor. Cabinet-ID:xx, Location:iSPy, State:ssssss	(a)
iSP login: spfw<ENTER> iSP password: xxxxxxxx<ENTER>	(b)
Copyright (C) 2005 NEC Corporation, All Rights Reserved. Welcome to Integrated Service Processor. iSP FW version : 01.00 generated on 01/01/2005 19:20:33	(c)
iSP MAIN MENU 0) OS(BIOS) serial console of partition#0 (INITIALIZING) 1) OS(BIOS) serial console of partition#1 (RUNNING) 2) OS(BIOS) serial console of partition#2 (STOPPED) 3) OS(BIOS) serial console of partition#3 (FAULT) 4) OS(BIOS) serial console of partition#4 (POWER OFF) 5) OS(BIOS) serial console of partition#5 (RUNNING) 6) OS(BIOS) serial console of partition#6 (NOT CONFIGURED) 7) OS(BIOS) serial console of partition#7 (NOT CONFIGURED) V) Virtual System Operator Panel S) iSP commands E) Exit DISCONNECTALL) disconnect all console connections	(d)
iSPyz>	(e)

(Description)

Description No.	Description
(a)	xx is a cabinet ID identifying a particular cabinet in a multi-cabinet system ("system number" itself set with an SG command). y is the location of the iSP Card (0 or 1). ssssss represents "master" if the SP is assigned as master, "backup"* if it is assigned as backup, and "undetermined" if it is assigned as neither master nor backup.
(b)	Enter your login account and password at these prompts. The password is not echoed.
(c)	Version information for iSPFW
(d)	The Main Menu. OS Console and Virtual SOP can be chosen only if the iSP is assigned as the master. The OS Console menu includes the summary status of partitions.
(e)	Main Menu prompt. y is the location of the iSP Card (0 or 1). z is "m" if the SP is assigned as the master, "b" if it is assigned as the backup, and "u" if it is assigned as neither master nor backup.

* The "backup" indicator will not appear if no backup SP exists.

If maintenance operation or SPFW fails, the BOOT FW may boot up. In this case, the screen information is only limited to that needed for the BOOT FW (no login entry fields appear).

(Screen Example...BOOT FW)

	Description No.
<pre>iSP BOOT MAIN MENU S) iSP commands E) Exit DISCONNECTALL) disconnect all console connections iSPy*></pre>	

• Possible Events (including operator entries) and System Responses

Event	System Response
Login account or password was wrong.	The login prompt reappears after the message "incorrect" comes on.
Login account or password rejected 3 times consecutively.	The console is disconnected.
No operations made for 5 minutes on the login account or password prompt screen.	The console is disconnected after the message "timeout" appears.
A letter not specified in the menu was entered.	The menu reopens.
No operation made for 5 minutes on the Menu screen.	The console is disconnected after the message "timeout" appears.
The menu became invalid after iSP master assignment has been changed.	The invalid menu or prompt is not identified immediately. If you make a selection in the invalid menu, that selection is rejected and a new menu opens.
A value from 0 to 7 selected. (valid only on the master iSP)	OS (BIOS) Serial Console Redirection is chosen.
S selected. (valid regardless of master/backup assignment)	SP Command Console is chosen.
V selected. (valid only on the master iSP)	Virtual SOP is chosen.
E selected.	The current console connection is disconnected.
DISCONNECTALL selected.	All TCP connections to the iSP other than the current console connection are disconnected and the screen is forcibly returned to the Main Menu in case of serial connection console. This emergency action might be needed if console operation is prohibited when actually disconnected TCP connections remain alive under the iSP management due to client's illegal access.
The number of simultaneous connections allowable for the selected mode was exceeded.	The screen returns to the Main Menu after showing a message "N connections to the selected mode are already established. Try it later."

2.4.2. Note

While in serial or OS console connection, characters that are shown on the console screen may be disturbed due to redirection made in a half way of ESC sequence.

2.4.3. OS (BIOS) Console

If OS (BIOS) Console is chosen from the iSP Main Menu, I/O to/from the serial controller is redirected as viewed from the OS (BIOS).

To return to the Main Menu, enter “^B” (press the B key while holding down the CTRL key).

While the OS (BIOS) Console I/O is redirected, the screen displays and operations depend solely on the BIOS or OS that runs in that partition, and not on the iSPFW.

OS (BIOS) Console redirection is only allowed for the master iSP.

(Screen Example)

	Description No.
<pre>iSP MAIN MENU 0) OS(BIOS) serial console of partition#0 (INITIALIZING) 1) OS(BIOS) serial console of partition#1 (RUNNING) 2) OS(BIOS) serial console of partition#2 (STOPPED) 3) OS(BIOS) serial console of partition#3 (FAULT) 4) OS(BIOS) serial console of partition#4 (POWER OFF) 5) OS(BIOS) serial console of partition#5 (RUNNING) 6) OS(BIOS) serial console of partition#6 (NOT CONFIGURED) 7) OS(BIOS) serial console of partition#7 (NOT CONFIGURED) V) Virtual System Operator Panel S) iSP commands E) Exit DISCONNECTALL) disconnect all console connections</pre>	
<pre>iSPyz> 0<ENTER></pre>	(a)
<pre>***** redirection of serial console 0 *****</pre>	(b)
<pre>***** enter CTRL+B to quit *****</pre>	
<pre> : : :</pre>	(c)
<pre> : : :</pre>	
<pre><CTRL>+</pre>	(d)
<pre>***** returned from serial console 0 redirection *****</pre>	(e)

(Description)

Description No.	Description
(a)	If a value (0 to 7) is entered, I/O is redirected to OS Console within the corresponding partition.
(b)	An opening message for OS Console redirection
(c)	All I/Os made in OS Console redirection depends on the OS or BIOS.
(d)	Enter ^B to quit OS Console redirection.
(e)	An end of redirection message. The screen returns to the Main Menu after this message.

- Possible Events (including operator entries) and System Responses

Event	System Response
^B (CTRL+B) entered.	The screen shows an "Exit OS (BIOS) Console" message, and then returns to the Main Menu and prompts.
OS (BIOS) Console became invalid after iSP master assignment changed.	The screen shows an "Exit OS (BIOS) Console" message, and then returns to the Main Menu and prompts.
There are no partitions on display after an SP command was entered.	The screen shows an "Exit OS (BIOS) Console" message, and then returns to the Main Menu and prompts.

2.4.4. Virtual SOP

If Virtual SOP (Virtual System Operator Panel) is chosen from the Main Menu, Virtual SOP appears on the console screen. Virtual SOP periodically lists outlined status information of all the existing partitions.

To return from Virtual SOP to Main Menu, enter “^B” (press the B key while holding down the CTRL key).

Virtual SOP is selectable only if the iSP is assigned as the master.

(Screen Example)

	Description No.
<pre> iSP MAIN MENU 0) OS(BIOS) serial console of partition#0 (INITIALIZING) 1) OS(BIOS) serial console of partition#1 (RUNNING) 2) OS(BIOS) serial console of partition#2 (STOPPED) : : 7) OS(BIOS) serial console of partition#7 (NOT CONFIGURED) V) Virtual System Operator Panel S) iSP commands E) Exit DISCONNECTALL) disconnect all console connections </pre>	
<pre> iSPyz> V<ENTER> ----- Virtual System Operator Panel ----- 01/31/2005,19:30:20 ----- </pre>	(a)
<pre> 00 0 HW INITIALIZING yyyyyy 00 1 RUNNING yyyyyy BIOS messages BIOS messages SP messages SP messages </pre>	
<pre> 00 2 STOPPED yyyyyy 00 3 FAULT yyyyyy BIOS messages BIOS messages SP messages SP messages </pre>	(b)
<pre> 00 4 POWER OFF yyyyyy 00 5 RUNNING yyyyyy BIOS messages BIOS messages SP messages SP messages </pre>	
<pre> 00 6 NOT CONFIGURED yyyyyy 00 7 NOT CONFIGURED yyyyyy BIOS messages BIOS messages SP messages SP messages </pre>	
<pre> ----- Enter CTRL+B to quit ----- </pre>	
<pre> : <CTRL>+ </pre>	(c) (d)

(Description)

Description No.	Description
(a)	Virtual SOP appears if V is entered at this prompt.
(b)	Virtual SOP screen.
(c)	SP messages shared for all the partitions or those not concerned with partitions appear here.
(d)	Virtual SOP periodically appears until these keys are pressed.
(e)	Entering ^B quits Virtual SOP. The screen returns to the Main Menu.

- Possible Events (including operator entries) and System Responses

Event	System Response
^B (CTRL+B) entered.	The screen returns to the Main Menu and prompts.
Virtual SOP became invalid after iSP master assignment was changed.	The screen shows a message "Exit Virtual SOP," and then returns to the Main Menu and prompts.

2.4.4.1. Details of Partition Status Display

The status information for each partition consists of the following items:

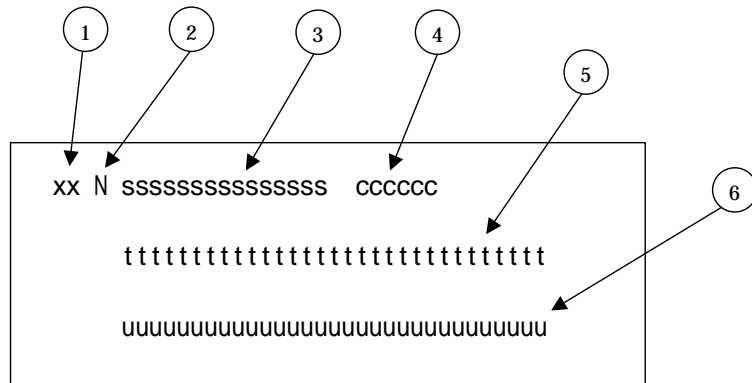

No.	Item	Description
(1)	Numeral	Represents the system No. Fixed to 00 for all other models.
(2)	Numeral (0-7)	Denotes the partition number.
(3)	Character string	Represents partition states.
	POWER OFF	Indicates DC OFF state.
	STOPPED	Indicates DC ON, No Failure, and Halt state.
	HW INITIALIZING	Means that the iSP is initializing the HW. BIOS is still not booted.
	SW INITIALIZING	Means that the system is being initialized by BIOS.
	OS BOOTING	Means that the OS is being booted (HP-UX only).
	RUNNING	Means that control is passed to EFI after system initialization by BIOS is complete.
	FAULT	Means that the system is in Halt state due to failure.
	SHUT DOWN	Means that the ISP is shutting down the HW.
	NOT CONFIGURED	Means "Not Configured."
(4)	6 digit hex number	Represents the latest chassis code sent from the BIOS or OS.
(5)	Character string	Four-digit error code provided by BIOS. It is cleared when the system is booted next time, or with the CS command.
(6)	Character string	Warning or error message provided by the SP, shown in the same format as Activity logs. For long messages, their tail part will be omitted. It is cleared when the system is booted next time, or with the CS command.

2.4.5. SP Command Console

If SP Command is chosen from the iSP Main Menu, SP Command Console appears on the console screen.

To return from SP Command Console to the Main Menu, enter “^B” (press the B key while holding down CTRL).

Some SP commands are only valid on the master iSP.

(Screen Example)

	Description No.
<pre> iSP MAIN MENU 0) OS(BIOS) serial console of partition#0 (INITIALIZING) 1) OS(BIOS) serial console of partition#1 (RUNNING) 2) OS(BIOS) serial console of partition#2 (STOPPED) 3) OS(BIOS) serial console of partition#3 (FAULT) 4) OS(BIOS) serial console of partition#4 (POWER OFF) 5) OS(BIOS) serial console of partition#5 (RUNNING) 6) OS(BIOS) serial console of partition#6 (NOT CONFIGURED) 7) OS(BIOS) serial console of partition#7 (NOT CONFIGURED) V) Virtual System Operator Panel S) iSP commands E) Exit DISCONNECTALL) disconnect all console connections iSPyz> S<ENTER> : : : : : : <CTRL>+ </pre>	<p>(a)</p> <p>(b)</p> <p>(c)</p>

(Description)

Description No.	Description
(a)	SP Command Console appears if S is entered at this prompt.
(b)	You can enter SP commands and monitor SP messages until ^B is entered.
(c)	CTRL+B quits SP Command Console. The screen returns to the Main Menu.

2.4.5.1. SP Command Console Buffer

The output from SP Command Console may contain some critical information such as causes of system status changes. Also when the iSP is running in LAN Console mode, it is not possible to monitor the console output until LAN Console connection is established after the iSP boots up. For these reasons, the iSP is provided with a buffering capability that buffers a certain amount of messages that are output before SP Command Console connection is established.

The buffer has a size of approx. 1000 lines, capable to save the latest 1000 lines of output messages.

The buffer contents can be listed with the “ML command.”

2.4.5.2. SP Command Prompt

When in SP Command mode, pressing the [ESC] key shows either of the following command prompts.

Prompt
iSPyz:--->

2.4.5.3. SP Message Header

SP messages are, in general, output with the following headers attached to them.

No message headers are attached to interactive prompts or messages used in SP commands, however.

Message Header	Description
[iSPyz:INFO.ccccc] string	Information message: cccc represents a message ID. string represents the message body.
[iSPyz:WARN.ccccc] string	Warning message
[iSPyz:ERRORcccccc] string	Error message

2.4.5.4. SP Command List

The following tables contain SP command lists by category:

System Control

CMD	command name	function	iSP state
DF	Shut down System power (override)	The iSP turns off the DC power of the specified partition without notifying the SW (OS) even if it is running.	m
DN	Shut down System power	If the specified partition is in S0 state, the iSP only generates the SCI (POWBTN). Otherwise, the iSP turns off the DC power directly.	m
DP	System Dump	The iSP generates the INIT signal to the specified partition. SW (OS) will enter its dump routine.	m
PC	Power Cycle	The iSP turns off the DC power of the specified partition without notifying the SW (OS) even if it is running, turns on the DC power, initializes HW and hands off the control to the BIOS.	m
RS	Cold Reset System	The iSP initializes the specified partition without notifying the SW (OS) even if it is running.	m
UB	Bring up BIOS	The iSP turns on the DC power of the specified partition and initializes HW and hands off the control to the BIOS.	m
UP	Bring up System	The iSP turns on the DC power of the specified partition and initializes HW and hands off the control to the BIOS. The BIOS will boot the Operating System.	m

“m”: Commands can be executed only on the master iSP.

(Reference) System Status Transitions and System Control Commands

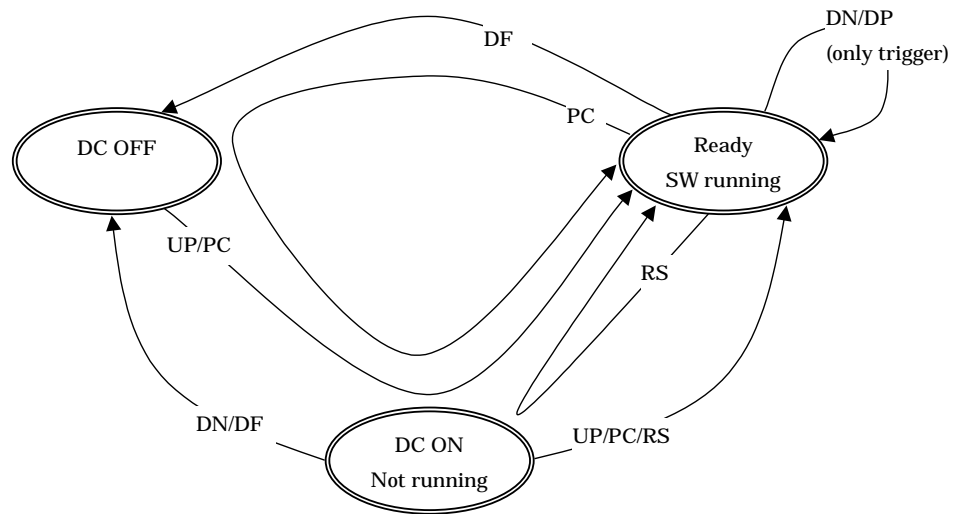

Figure. System Status Transitions and System Control Commands

Note) When the UB command is used for system boot, the system always halts at the EFI Shell screen. Operation cannot therefore be continued if the system is started and stopped using, for example, the automatic power control feature, or rebooted following error detection. If the system halts at the EFI Shell screen, the OS cannot boot. Be sure to use the UP command to boot the OS. When you use the UB command for changing the EFI settings, shut down the system and then reboot it with the UP command.

Configuration

CMD	command name	function	iSP state
HC	Hardware Configuration	Display and/or modify the hardware configuration including the configuration about partitioning.	m

Normal mode other commands

CMD	command name	function	iSP state
DT	SP Date and Time	Display the SP RTC (Real Time Clock) and set it.	m/b/u
EN	Environmental Information	Display the environmental information such as the power status and the temperature sensors.	m
FV	Firmware Version	Display the iSP FW version and BIOS version.	m/b/u
HE	Help	Display the help information.	m/b/u
ML	Message Log	Display the iSP's message buffer.	m/b/u

Settings

CMD	command name	function	iSP state
SG	SP/System Setting	Set up the settings about the iSP, system and partitions. Some settings are only available in MNT mode.	m/b/u
SR	Save system CMOS/NvRAM	Save and/or restore the system CMOS/NvRAM.	m

2.4.6. SP Command Reference

This section provides command reference describing the details of SP commands.

Command availability on the master iSP, backup iSP, and undetermined iSP is indicated on the first page of each command.

(Legend)

m	b	u
X		

- m: Command validity on the master iSP. X denotes "valid."
- b: Command validity on the backup iSP. X denotes "valid."
- u: Command validity on the undefined iSP. X denotes "valid."

The example above indicates that the commands are valid only if the iSP is assigned as the master.

The SP commands and subcommands are not case-sensitive. For this reason, case-sensitive data such as accounts and passwords is clearly indicated.

[Note]

* When the following list (a list of codes indicating the system configuration) is included in the command description, this system corresponds to **8Way**:

- 8Way
- 32Way
- ISPF

If the above indication is omitted, this description is common across the system.

2.4.6.1. DF (Shut down System Power <override>)

m	b	u
X		

* The command is executable to the active partition (after automatic system boot/UP command execution).

Function:

This command is used to shut down the system DC power.

It shuts down the system power overriding the current OS or BIOS state, notifying nothing to them. (It is equivalent to a Power button override on systems having a physical Power button.)

(Screen Example)

	Description No.
iSPyz:---> df<ENTER>	
CAUTION: System power will be turned off without any notice to the softwares even if they are running.	
Enter partition number (0-7/all/CR=exit) : all<ENTER>	(a)
Execute OK? (y/[n]) y<ENTER>	(b)
DF command was accepted. System power of all partitions will be turned off soon.	(c)
mm/dd/yyyy HH:MM:SS 0----- System shutdown started. (SPFW:Rxx.xx)	(d)
:	

* Waiting 2 minutes for cooling components. *	
* DC power is still active. *	(e)

* DO NOT turn off AC power. *	

mm/dd/yyyy HH:MM:SS 0----- System shutdown completed. (SPFW:Rxx.xx)	
[iSP0m:INFO.2042]	

* All DC power has been turned off. *	(f)
* You can turn off AC power. *	

(Description)

Description No.	Description
(a)	Enter the target partition number at this prompt. If "all" is specified, all the existing partitions are the target of this command. The partition numbers that can be specified depend on models.
(b)	A confirmation message appears. If you are sure to continue command execution, enter "y."
(c)	A "DF command accepted" message appears. Actual processing will progress in the background.
(d)	Shows background command execution in progress.
(e)	The message here indicates that you have to wait for 2 minutes for the system to cool off before the Power Bay is shut down. It won't appear if there are active partitions somewhere.
(f)	The message here indicates that the DC power in the Power Bay is shut down and you are ready to shut off the system AC power. It won't appear if there are active partitions somewhere.

2.4.6.2. DN (Shut down System Power)

m	b	u
X		

* The command is executable to the active partition (after automatic system boot/UP command execution).

Function:

This command is used to shut down the system DC power.

It shuts down the system DC power only if the software is not running (not in S0 state).

If the system software (OS or BIOS) is running (S0 state), this command only reports a Power Button interrupt to the software. The interrupt service depends on the software (the software may ignore the interrupt or perform a shut-down).

The software may not be able to service the power button interrupt due to stall or other cause even if the iSP recognizes that the software is running. In this case use the DF command to force a system power shut-down.

(Screen Example)

	Description No.
iSPyz:---> dn<ENTER> System power will be turned off if the software(OS) is NOT running. Only power button interrupt will be generated if the software(OS) is running. If you want to turned off the system power in any system state, use DF command.	
Enter partition number (0-7/all/CR=exit) : 0<ENTER>	(a)
Execute OK? (y/[n]) y<ENTER>	(b)
DN command was accepted. System power of all partitions will be turned off or power button interrupt will be generated soon.	(c)
[iSPyz:INFO.ccc] partition 0 : power button interrupt. mm/dd/yyyy HH:MM:SS 0----- System shutdown started. (SPFW:Rxx.xx) : : mm/dd/yyyy HH:MM:SS 0----- System shutdown completed. (SPFW:Rxx.xx)	(d)

(Description)

Description No.	Description
(a)	Enter the target partition number here. If "all" is specified, all the existing partitions are the target of this command.
(b)	A confirmation message appears. If you are sure to continue command execution, enter "y."
(c)	A "DN command accepted" message appears. Actual processing progresses in the background.
(d)	The same message as that shown in Section 1.5.2, "DN Command Screen Example" appears.

2.4.6.3. DP (System Dump)

m	b	u
X		

* The command is executable to the active partition (after automatic system boot/UP command execution).

Function:

This command causes a Dump interrupt to the system after a system dump is taken.

Whether a system dump is actually taken or not, or a system reset is subsequently activated or not, depends on the system software (OS or BIOS). This command only causes a Dump interrupt.

Nothing will happen, of course, if the software is not running.

(Screen Example)

	Description No.
iSPyz:---> dp<ENTER> Dump button interrupt will be generated.	
Enter partition number (0-7/all/CR=exit) : all<ENTER>	(a)
Execute OK? (y/[n]) y<ENTER>	(b)
DP command was accepted. Dump button interrupt will be generated soon.	(c)
[iSPyz:INFO.ccc] partition 0 : dump button interrupt. [iSPyz:INFO.ccc] partition 1 : dump button interrupt. : : :	(d)

(Description)

Description No.	Description
(a)	Enter the target partition number here. If "all" is specified, all the existing partitions are the target of this command.
(b)	A confirmation message appears. If you are sure to continue command execution, enter "y."
(c)	A "DP command accepted" message appears. Actual processing progresses in the background.
(d)	Shows progress in the background.

2.4.6.4. DT (SP Data and Time)

m	b	u
X	X	X

* Always valid without regard to the current system status.

Function:

This command is used to show iSP's internal real-time clock.

(Screen Example ... Normal Mode)

	Description No.
iSPyz:---> dt <ENTER> current iSP RTC : 19:20:57,03/31/2005 +09:00 synchronized with NTP server (10.20.30.40) DT command terminated.	(a)

(Description)

Description No.	Description
(a)	This command shows the present time before quitting.

2.4.6.5. EN (Environmental Information)

m	b	u
X		

* Always valid without regard to the current system status.

Function:

This command is used to list system environmental data including temperature sensor data, FAN error, and so on.

Note that part of the environmental monitoring functions are not available to inactive components.

The temperature sensor threshold shown in the following Screen Example may not reflect the actual threshold.

(Screen Example)

		Description No.
<pre> iSPyz:---> en<ENTER> select display mode? (i[nteractive per page]/a[ll]/CR=exit) : i<ENTER> (32Way: For one or two AC power receiving systems) ----- Power Bay Units ----- 19:20:57,01/31/2005 ----- state DPS0 DPS1 DPS2 DPS3 DPS4 DPS5 * MAIN POWBAY0 ON --- --- ALARM --- * POWBAY1 ON --- --- NORESP --- EXT POWBAY2 OFF --- --- --- --- POWBAY3 OFF --- --- --- --- </pre>		(a)
<pre> (8Way/ISPF: For one or two AC power receiving systems) ----- Power Bay Units ----- 19:20:57,01/31/2005 ----- state DPS0 DPS1 DPS2 DPS3 DPS4 DPS5 * MAIN POWBAY0 ON --- --- ALARM --- --- --- * EXT POWBAY1 ON --- NORESP --- </pre> <p>ISPF does not have two AC power receiving systems.</p> <pre> (8Way/ISPF receiving 48 VDC) ----- Power Bay Units ----- 19:20:57,01/31/2005 ----- state EXT POWBAY1 ON </pre>		(b)

```
(32Way)
---- MAIN cabinet FANs ----- 19:20:57,01/31/2005 ----
Location  FR00  FR01  FR02      FR10  FR11  FR12
          HIGH  HIGH  HIGH      HIGH  HIGH  HIGH

Location  FF00  FF01  FF02      FF11  FF12
          ALARM HIGH  HIGH      HIGH  HIGH
```

```
(8Way)
---- MAIN Chassis FANs ----- 19:20:57,01/31/2005 ----
Location  FR0          FF0
          low          low
```

(c)

```
(ISPF)
---- MAIN Chassis FANs ----- 19:20:57,01/31/2005 ----
Location  FR0  FR1  FF0
          low  low  low
```

Next page? (n[ext]/e[xit]/CR=next) : <ENTER>

(d)

(The numbers of CELL and XBx cards depend on 32Way/8Way and ISPF models.)

```
---- Power state of CELL cards and PROCs ----- 19:20:57,01/31/2005 ----
                                PROC state
                                state  x0  x1  x2  x3
CELL0      ON      ON  ON  OFF  ---
CELL1      OFF     ---  ---  ---  ---
CELL2      ON      ON  ON  OFF  OFF
CELL3      OFF     ---  ---  ON  ON
CELL4      ON      ---  ---  ON  ON
CELL5      ON      ---  ---  ON  ON
CELL6      ON      ON  ON  ---  ---
CELL7      ---     ---  ---  ---  ---
```

(e)

(The following information will be missing for 8Way:)

```
---- XBx card power state ----- 19:20:57,01/31/2005 ----
                                state
XBx_C0     ON
* XBx_C1   ON
XBx_C2     OFF
XBx_C3     ---
```

Previous/Next page? (p[revious]/n[ext]/e[xit]/CR=next) : <ENTER>

(The numbers of PCI Bays to be shown depend on 32Way/8Way and ISPF models.)

```
---- PCIBAY power state/FAN alarm ----- 19:20:57,01/31/2005 ----
                                state          FANs
                                COREM/HDDM  PCIM
PCIBAY0(D) ON
PCIBAY1(D) ---          ---          ---
* PCIBAY2(D) ON          ALARM
PCIBAY3(D) OFF
PCIBAY4(D) ON
PCIBAY5(D) ON
PCIBAY6(E) 未定
PCIBAY7(E) 未定
```

(f)

Previous/Next page? (p[revious]/n[ext]/e[xit]/CR=next) : <ENTER>

(The total number of pages and page numbers depend on 32Way/8Way and ISPF models.)

---- Temperature (Celsius) [1/7] ----- 19:20:57,01/31/2005 ----

	current	threshold			S.D.	comment
		FAN	IPMI	ACPI		
CELL0	46	-	55	57	65	
PROC00	50	77/ 80	89	91	120	
* PROC01	82	77/ 80	89	91	120	FAN High-speed
PROC02	24	77/ 80	89	91	120	
PROC03	-	-	-	-	-	
CELL1	24	-	55	57	65	
PROC10	-	-	-	-	-	
PROC11	-	-	-	-	-	
PROC12	24	77/ 80	89	91	120	
PROC13	24	77/ 80	89	91	120	

(g)

Previous/Next page? (p[revious]/n[ext]/e[xit]/CR=next) : <ENTER>

---- Temperature (Celsius) [2/7] ----- 19:20:57,01/31/2005 ----

	current	threshold			S.D.	comment
		FAN	IPMI	ACPI		
CELL2	46	-	55	57	65	
PROC20	50	77/ 80	89	91	120	
* PROC21	82	77/ 80	89	91	120	FAN High-speed
PROC22	24	77/ 80	89	91	120	
PROC23	24	77/ 80	89	91	120	
* CELL3	26	-	55	57	65	
PROC30	27	77/ 80	89	91	120	
PROC31	27	77/ 80	89	91	120	
PROC32	27	77/ 80	89	91	120	
PROC33	27	77/ 80	89	91	120	

(g)

Previous/Next page? (p[revious]/n[ext]/e[xit]/CR=next) : <ENTER>

---- Temperature (Celsius) [3/7] ----- 19:20:57,01/31/2005 ----

	current	threshold			S.D.	comment
		FAN	IPMI	ACPI		
CELL4	46	-	55	57	65	
PROC40	50	77/ 80	89	91	120	
* PROC41	82	77/ 80	89	91	120	FAN High-speed
PROC42	-	-	-	-	-	
PROC43	-	-	-	-	-	
* CELL5	52	-	55	57	65	
PROC50	-	-	-	-	-	
PROC51	-	-	-	-	-	
PROC52	70	77/ 80	89	91	120	
* PROC53	103	77/ 80	89	91	120	reported to the software

(g)

Previous/Next page? (p[revious]/n[ext]/e[xit]/CR=next) : <ENTER>

```

----- Temperature (Celsius) [4/7] ----- 19:20:57,01/31/2005 -----
              current                threshold                comment
                   FAN      IPMI  ACPI  S.D.
CELL6           46          -      55   57   65
  PROC60        50      77/ 80    89   91  120
*  PROC61        82      77/ 80    89   91  120    FAN High-speed
  PROC62         -          -      -    -    -
  PROC63         -          -      -    -    -
CELL7           -          -      -    -    -
  PROC70         -          -      -    -    -
  PROC71         -          -      -    -    -
  PROC72         -          -      -    -    -
  PROC73         -          -      -    -    -
    
```

(g)

Previous/Next page? (p[revious]/n[ext]/e[xit]/CR=next) : <ENTER>

(The numbers of XBx and Cx cards are changed on 32Way/8Way and ISPF.)

```

----- Temperature (Celsius) [5/7] ----- 19:20:57,01/31/2005 -----
              current                threshold                comment
                   FAN      IPMI  ACPI  S.D.
XBX_C0          52          -      55   57   65
* XBX_C1         61          -      55   57   65    reported to the software
XBX_C2          24          -      55   57   65
XBX_C3          -          -      -    -    -
    
```

(g)

```

                   FAN      WARN          S.D.
* AIR FLOW IN   23      23/ 25    37          40    FAN High-speed
    
```

Previous/Next page? (p[revious]/n[ext]/e[xit]/CR=next) : <ENTER>

(The numbers of PCI Bay cards are changed on 32Way/8Way and ISPF.)

```

----- Temperature (Celsius) [6/7] ----- 19:20:57,01/31/2005 -----
              current                threshold                comment
                   FAN      IPMI  ACPI  S.D.
PCI -
BAY0(D)  A      45          -      55   57   65
          -B     45          -      55   57   65
          IOX_C  52          -      55   57   65
BAY1(D)  -A     -          -      -    -    -
          -B     -          -      -    -    -
          IOX_C  -          -      -    -    -
BAY2(D)  -A     45          -      55   57   65
          -B     45          -      55   57   65
          IOX_C  63          -      55   57   65    reported to the software
BAY3(D)  -A     45          -      55   57   65
          -B     45          -      55   57   65
          IOX_C  52          -      55   57   65
    
```

(g)

Previous/Next page? (p[revious]/n[ext]/e[xit]/CR=next) : <ENTER>

Base Module

(The numbers of PCI Bay cards are changed on 32Way/8Way and ISPF.)

----- Temperature (Celsius) [7/7] ----- 19:20:57,01/31/2005 -----

	current		threshold			comment
PCI -		FAN	IPMI	ACPI	S.D.	
BAY4(D) -A	45	-	55	57	65	
-B	45	-	55	57	65	
IOX_C	52	-	55	57	65	
BAY5(D) -A	*	-	55	57	65	
-B	45	-	55	57	65	
IOX_C	52	-	55	57	65	
BAY6(E) -A	45	-	55	57	65	(tentative)
-B	45	-	55	57	65	(tentative)
IOX_C	52	-	55	57	65	(tentative)
BAY7(E) -A	45	-	55	57	65	(tentative)
-B	45	-	55	57	65	(tentative)
IOX_C	52	-	55	57	65	(tentative)

(g)

Previous page? (p[revious]/e[xit]/CR=back) : <ENTER>

select display mode? (i[nteractive per page]/a[ll]/CR=exit) : <ENTER>

EN command terminated.

(Description)

Description No.	Description
(a)	Allows to choose environmental data formats from page format of 24 lines each or online format.
(b)	<p>Indicates the states of the Power Bay within the cabinet. If an alarm condition exists, this line is prefixed with an asterisk (*). state</p> <p>ON : A DC power (48V) is applied to the components inside the cabinets. OFF : No DC power (48V) is applied to the components inside the cabinets. --- : The Power Bay itself is not existent (not visible from the iSP). DPSx (blank) : Indicates the normal state. ALARM : Indicates an alarm state. --- : Indicates that the DPS is not existent (not visible from the iSP). NORESP : Indicates that the DPS is existent but not visible from the iSP. No DPS exists on a 48-VDC supply.</p>
(c)	<p>Shows the states of the fans located in the CPU cage or main chassis in the Main Cabinet. If an alarm condition exists, this line is prefixed with an asterisk (*). --- : Indicates that no fan exists. ALARM : Indicates an alarm state. low : Indicates that the fan is running at low speed. HIGH : Indicates that the fan is running at high speed. "HIGH" will appear if any cause of high-speed fan exists even when the system is in Halt.</p>
(d)	Press <ENTER> to go to the next page.
(e)	Power On/Off state of the CELL and XBX Cards in the CPU cage or main chassis within the Main Cabinet.
(f)	<p>Power and fan states within the PCI Bay. If a fan alarm exists, this line is prefixed with an asterisk (*) PCI Bay types (D) and (E) are added for PCID Bay and PCIE Bay, respectively.</p>
(g)	<p>Temperature detected by the card's temperature sensor is shown here. If a temperature sensor failure exists, an asterisk (*) is shown in place of a temperature readout. If a temperature alarm exists, the pertinent line is prefixed with an asterisk (*) The threshold information hardwire-coded in the iSPFW is also shown here. "FAN" gives the temperature thresholds where fan speed is switched from low to high and vice versa. The values on the right side give the threshold to switch from low to high speed, and those on the left side from high to low speed. "IPMI" gives the threshold over which temperature information is reported to the software through the IPMI interface. "ACPI" gives the threshold over which temperature information is reported to the software through the ACPI interface. "S.D." specifies the temperature threshold for the SPFW to force system shut down. If AIR FLOW IN (intake temperature) reaches the S.D. threshold, all the running partitions are forcibly shut down. The WARN column on AIR FLOW IN (intake temperature) gives the threshold rejecting to boot currently inactive partitions.</p>

2.4.6.6. FV (Firmware Versions)

m	b	u
X	X	X

* Always valid without regard to the current system status.

Function:

This command is used to show version information for the iSPFW and BIOS.

This command also provides checksum test on the FW storage areas.

Note that, in a duplicated iSP environment, information is managed separately for each of the duplicated iSPs.

Also the display information may slightly change from one SPFW version to another.

(Screen Example)

	Description No.
<pre>iSPyz:---> fv<ENTER> Firmware Versions : (currently running firmware is Rxx.xx) iSP BOOT (*) : xx.xx generated on mm/dd/yyyy hh:mm:ss iSP FW bank (*) : xx.xx generated on mm/dd/yyyy hh:mm:ss BIOS bank0 (012) : xx.xx generated on mm/dd/yyyy hh:mm:ss BIOS bank1 (345) : xx.xx generated on mm/dd/yyyy hh:mm:ss BIOS bank2 (67) : xx.xx generated on mm/dd/yyyy hh:mm:ss</pre>	(a)
<pre>Do you want to check the flash memory? (y/[n]) : y<ENTER> checking iSP BOOT bank... passed. checking iSP FW bank... passed. checking BIOS bank0... passed. checking BIOS bank1... passed. checking BIOS bank2... passed. FV command terminated.</pre>	(b)
	(c)

(Description)

Description No.	Description
(a)	Lists the current states of the FW storage areas.
(b)	If a checksum test on the FW storage area is needed, enter "y."
(c)	Lists the results of checksum test.

2.4.6.7. HC (Hardware Configuration)

m	b	u
X		

* For system states and subcommand validity, read the description of subcommands.

Function:

This command is used to show the hardware configuration and enable to change it.

It is also used to configure, show, or change partitions.

In a duplicated iSP environment, the hardware configuration is automatically matched between the duplicated iSPs.

Description of Subcommands

cmd	arg1	arg2	arg3	arg4	Description
help	-	-	-	-	Show a list of subcommands. This subcommand is always valid without regard to the current system state.
quit exit	-	-	-	-	Quit the HC command. Before the HC command quits, the check subcommand is automatically run. These subcommands are always valid without regard to the current system state.
disp	-	-	-	-	Show the system's hardware configuration. If no argument is specified or has an error, the disp subcommand help opens. This subcommand is always valid without regard to the current system state.
	all	-	-	-	Argument "all" shows all the configuration information.
	part	-	-	-	Show the current partitioning. The following information is given for each partition: State summary Physical CELL No. and logical CELL No. Physical IOX No. and logical IOX No. Size of shared memory (ISPF only)
	main	-	-	-	Show the Main Cabinet or Main Chassis configuration. For the 8Way/ISPF model, the configurations of external PCI Bay and Power Bay are also shown.
	exp	-	-	-	Valid only for the 32Way model. Use this argument to show the expansion cabinet configuration.
	cellx	-	-	-	Show the CELL configuration. X denotes a physical CELL number (0-7).

cmd	arg1	arg2	arg3	arg4	Description
	mmxxy	-	-	-	Show the detailed configuration of the ROW under the MMX specified by xy , and in the case of the 32Way(H) model, show detailed configuration of the DIR. x is the physical CELL number where the MMX is installed (0-7). y is the MMX number within the CELL (0-3).
	tagxs	-	-	-	Show the detailed configuration of the TAG for the 32Way(B)/8Way/ISPF models. This argument is invalid for the 32Way(H) model. x is the physical CELL number where the TAG is installed (0-7). s is either 'e' (EVEN side) or 'o' (ODD side).
	xbxcx	-	-	-	Show the XBX Card configuration and XBX LSI configuration on that card. x is a physical XBX Card number (0-3).
	xbxy	-	-	-	Show the XBX configuration. x is an XBX Card number (0-3). y specifies an XBX number on the XBX Card (0-1).
	pcibx ioxx	-	-	-	Show the PCI Bay (IOX) configuration. x is the DGI/I2C cable port number (0-7) that connects iSP to PCI Bay.
	pcix	-	-	-	Show the configurations and information of the PCI Cards that are under the PXH within the PCI Bay. x is the DGI/I2C cable port number (0-7) that connects iSP to PCI Bay.
	cpcix	-	-	-	Show the configurations and information of the PCI Cards on the Core Card within the PCI Bay. x is the DGI/I2C cable port number (0-7) that connects iSP to PCI Bay.
	pbayx	-	-	-	Show the Power Bay configuration. x is a Power Bay number. The allowable range of x is as follows: For 32Way: 0, 1: Power Bay numbers within the Main Cabinet 2, 3: Power Bay numbers within the Expansion Cabinet For 8Way: 0: Power Bay No. inside the chassis 1: Power Bay No. outside the chassis For ISPF: 0: Power Bay No. inside the chassis
attach	-	-	-	-	Use this command to attach partition numbers to CELL or IOX Cards. If no argument is specified or an argument has an error, the attach command help opens. This command is not valid while the partition is booting up, shutting down, or handling an error.

cmd	arg1	arg2	arg3	arg4	Description
	cell x	n	m	-	<p>Attach the CELL Card having physical CELL number x to partition number n, using logical CELL number m (which is visible to the software or BIOS).</p> <p>This command may also be used to change a logical CELL number for an already attached CELL.</p> <p>A logical CELL number must be unique to every 8 CELL Cards.</p> <p>The logical CELL number of an online CELL Card is unable to be altered.</p>
	io xx	n	m	[p/s]	<p>Attach the IOX Card having physical IOX number x to partition number n, using logical IOX number m (which is visible to the software or BIOS).</p> <p>Specify p for arg4 if the PCI Bay with BIO is to use that BIO. Specify s for arg4 if the PCI Bay having duplicated BIOS is to use the secondary BIO.</p> <p>This command may also be used to change a logical IOX number for an already attached IOX.</p> <p>A logical IOX number must be unique within a partition.</p> <p>The logical IOX number of an online IOX Card cannot be altered.</p>
detach	-	-	-	-	<p>Use this command to detach partition numbers from CELL or IOX Cards.</p> <p>If no argument is specified or an argument has an error, the detach command help opens.</p> <p>Online components are unable to be detached.</p> <p>It is not allowed to detach components either when the partition is booting up, shutting down, or handing an error.</p>
	cell x	-	-	-	Detach the CELL Card with physical CELL number x from the partition to which it is currently attached.
	io xx	-	-	-	Detach the IOX Card with physical IOX number x from the partition to which it is currently attached.
	part x	-	-	-	Detach all the CELL and IOX Cards from the partitions to which they are currently attached. x : Partition number

cmd	arg1	arg2	arg3	arg4	Description
swap	-	-	-	-	<u>This command is currently not supported.</u> This command can be used to swap a CELL with another CELL while the software is running (it is not a combination of attach/detach commands, but provides a function exclusive to this command). If no argument is specified or an argument has an error, the swap command help opens. While this command is valid to running partitions, it is only functional when it is used with the OS that supports online attach/detach capability. This command is supported on the 32Way(B) and 8Way models.
	cell <i>x</i>	cell <i>y</i>	-	-	Swap a running CELL having physical CELL number <i>x</i> with another CELL having physical CELL number <i>y</i> . CELL <i>y</i> must be the one that is not attached to any partition. For CELL swapping, an invalid partition is needed to which no CELLS or IOXs belong. When swapping is complete, CELL <i>x</i> is detached from the partition, while CELL <i>y</i> is attached to it. Logical CELL number is transferred from CELL <i>x</i> to CELL <i>y</i> .
smem	-	-	-	-	This command is only supported on the ISPF model. It is not supported on any other models. Use this command to set the size of the memory area shared by partitions. If no argument is specified or an argument has an error, the smem command help opens. This command is valid to partitions that are not running.
	<i>n</i>	<i>mmm</i>	-	-	Set the shared memory size for the partition with partition number <i>n</i> , in a GB increment. It is not allowed to change the shared memory size for active partitions. No shared memory is used if 0 is specified.
cmem	-	-	-	-	This command is only supported on the 32Way(B) model. It is not supported on any other models. Use this command to set the size of the memory used for inter-CELL interleaving. If no argument is specified or an argument has an error, the cmem command help opens. This command is valid to inactive partitions.
	<i>n</i>	<i>mmm</i>	-	-	Set the memory size for inter-CELL interleaving for partition number <i>n</i> , in a GB increment. No interleaving is used if 0 is specified. Numbers that are not multiples of 16 GB will be rounded to multiples of 16 GB.

cmd	arg1	arg2	arg3	arg4	Description
add	-	-	-	-	Use this command to manually inform the iSP of an addition of components. iSP's management state will change from "nonexist." to "power-off." If no argument is specified or an argument has an error, the add command help opens. This command is always valid without regard to the current system state (with the exception of the PBAY, to which this command is valid only if none of the partitions is active). This command is not valid to the CELL Cards, XBX Cards, PCI Bay, or their subcomponents if any of the partitions within the system is booting up, shutting down, or handling an error.
	pbayx	-	-	-	Add Power Bays. x is a Power Bay number. The allowable value of x is as follows: For 32Way: 0, 1: Power Bay No. in the Main Cabinet 2, 3: Power Bay No. in the Expansion Cabinet For 8Way: 0: Power Bay No. inside the chassis 1: Power Bay No. outside the chassis For ISPF: 0: Power Bay No. inside the chassis
	dpsxy	-	-	-	Add DPS's to Power Bays. The meaning of x is identical to that for argument pbay. y is a DPS No. within a Power Bay (0-5).
	isp x	-	-	-	Add backup iSPs. x is the physical number of an iSP (0 or 1). Backup iSPs can only be added to the 32Way model.
	clk x	-	-	-	Add CLK Cards. x is the physical number of the CLK Card (0 or 1). The CLK Card can only be added to the 32Way model.
	xbcx	-	-	-	Add XBX Cards. x is an XBX Card number (0-3). The SP will automatically recognize the number of XBX LSI chips installed on the XBX Card.
	cell x	-	-	-	Add CELL Cards. x is the physical number of the CELL Card (0-7).
	proc xy	-	-	-	Add processors. x is the physical number of the CELL Card (0-7). y is the location of the processor on the CELL Card (0-3).

cmd	arg1	arg2	arg3	arg4	Description
	memdx	-	-	-	This command is only valid to the 32Way model. Use it to add MMX (2-3) and ROW to the memory daughter card. The DIMM capacity is automatically read when it is being initialized. x is the physical number of the CELL Card (0-7).
	pcibx	d e	[core]	-	Add PCI Bays. x is a DGI/I2C port number on the iSP side (0-7). Use arg2 to specify the type of the PCI Bay (mandatory). Specify "d" for PCID-Bays, and "e" for PCIE-Bays. Specify "core" for arg3 if Core Cards (GXB) are installed. If the type of the PCI Bay (PCID/PCIE) or the presence of the Core Card has been changed, the SP will know that change from the revision information for that PCI Bay.
delete	-	-	-	-	Use this command to delete components from iSP management. If physically removed components are left under iSP management, they will be handled as an "INVISIBLE" error indefinitely. If no argument is specified or an argument has an error, the delete command help opens. Components in DC-ON state are unable to be deleted (with the exception of the CLK and DPS). The CELL Card, XBX Card, PCI Bay, or their subcomponents is unable to be deleted if any of the partitions within the system is booting up, shutting down, or handling an error.
	<arg1>	-	-	-	<arg1> is identical to that for the add command.
enable	-	-	-	-	Use this command to enable the components that are currently "DISABLED." If no argument is specified or an argument has an error, the enable command help opens. This command is valid only if the partition to which the pertinent components belong is not active. The CELL Card, XBX Card, PCIX, and their subcomponents can be enabled unless any of the partitions within the system is booting up, shutting down, or handling an error. The Power Bay can be enabled only if none of the partitions within the system is active.

cmd	arg1	arg2	arg3	arg4	Description
	pbayx	-	-	-	Enable the Power Bay. x is a Power Bay number. The allowable value of x is as follows: For 32Way: 0, 1: Power Bay numbers within the Main Cabinet 2, 3: Power Bay numbers within the Expansion Cabinet For 8Way: 0: Power Bay number inside the chassis 1: Power Bay number outside the chassis For ISPF: 0: Power Bay number inside the chassis
	clkx	-	-	-	Enable the CLK. x is a CLK number (0 or 1). The CLK is installed only in the 32Way model.
	xbxcx	[all]	-	-	Enable the XBX Card. x is an XBX Card number (0-3). If arg2 is omitted, only the XBX Card is enabled, with its subcomponents left disabled. If "all" is specified for arg2, XBX Card is enabled including all of its subcomponents.
	xbxxy	[all]	-	-	Enable the XBX LSI. x is an XBX Card number (0-3). y is an XBX LSI number (0-1) on an XBX Card. If arg2 is omitted, only the XBX Card is enabled, with its subcomponents left disabled. If "all" is specified for arg2, the XBX Card is enabled including all of its subcomponents.
	cellx	[all]	-	-	Enable the CELL Card. x is a physical CELL number (0-7). If arg2 is omitted, only the CELL Card is enabled, with its subcomponents left disabled. In this case, console operation will be rejected if essential components are disabled. If "all" is specified for arg2, the CELL Card is enabled including all of its subcomponents.
	cnxxy	-	-	-	Enable the CNX LSI. x is a physical CELL number (0-7). y is a CNX number (0-1) within a CELL. CNX1 exists only in the 32Way(H) model.
	procxy	-	-	-	Enable the Processor. x is a physical CELL number (0-7). y is a Processor number (0-3) within the CELL.
	mmxxy	[all]	-	-	Enable the MMX. x is a physical CELL number (0-7). y is an MMX number (0-3) within the CELL. If arg2 is omitted, only the MMX is enabled, with its subcomponents left disabled. If "all" is specified for arg2, the MMX is enabled including all of its subcomponents.

cmd	arg1	arg2	arg3	arg4	Description
	row xzz	-	-	-	Enable the ROW. x is a physical CELL number (0-7). zz is a ROW number (00-15), which must always be specified with a 2-digit number. For the 32Way(H) model, the corresponding Directory memory is also enabled. There is no individual DIMM control. The DIMM is automatically detected on boot-up.
	dir xzz	-	-	-	For the 32Way(H) model, use this argument to enable the Directory memory and the corresponding ROW memory. This command is invalid to the 32Way/8Way/ISPF models. x is a physical CELL number (0-7). zz is a Directory number (00-15), which must always be specified with a 2-digit number. There is no individual DIMM control. The DIMM is automatically detected on boot-up.
	tag x[sy z]	-	-	-	Enable the TAG for 32Way(B)/8Way/ISPF models. x is a physical CELL number (0-7). s should be either 'e' (EVEN side) or 'o' (ODD side). y is a TAG Bank number (0-1). z is a TAG Bank level number (0-5). If s , y , and z are all omitted, all the TAGs under the CELL Card specified by x are enabled.
	pcib x	[all]	-	-	Enable the PCI Bay. x is the DGI/I2C cable port number (0-7) that connects iSP to PCI Bay. Always specify "all" for arg2, so that all the subcomponents including the PCI Bay itself are enabled.
	io xx	[all]	-	-	Enable the IOX. x is a physical IOX number (0-7). If arg2 is omitted, only the IOX is enabled, with its subcomponents left disabled. If "all" is specified for arg2, the IOX Card is enabled including all of its subcomponents.
		io cy	-	-	Enable the IOC. y is an IOC number (0 or 1) within an IOX.
	gxb xy	-	-	-	Enable the GXB on the Core IO Card. x is the DGI/I2C cable port number (0-7) that connects iSP to PCI Bay. y is a GXB number (0).
	cp cixy	-	-	-	Enable the slots (1-2) on the Core IO Card. x is a PCI Bay number (0-7). y is a slot number (1-2).
	pxh xy	-	-	-	Enable the PXH. x is the DGI/I2C cable port number (0-7) that connects iSP to PCI Bay. y is a PXH number (0-3).
	pc ix0y	-	-	-	Enable the slots (1-8) on the PXH. x is a PCI Bay number (0-7). y is a slot number (1-8).

cmd	arg1	arg2	arg3	arg4	Description
disable	-	-	-	-	Use this command to manually "DISABLE" the components that are currently enabled. If no argument is specified or an argument has an error, the disable command help opens. Online components are unable to be disabled. It is not allowed to disable the CELL Card, XBX Card, PCI Bay, and their subcomponents when any of the partitions within the system is booting up, shutting down, or handling an error.
	<arg1>	<arg2>	-	-	<arg1> and <arg2> are the same as those for the enable command. Argument "all" is not allowed for this command.
online	-	-	-	-	<u>This command is currently not supported.</u> This command can be used to dynamically connect currently offline components (CELL, XBX Card, and PCI Bay) to the system while the OS is running. It remains invalid while any of the partitions within the system is booting up, shutting down, or handling an error. The CELL and PCI Bay are functional only if they are used in online conjunction with the OS that supports this command function. If no argument is specified or an argument has an error, the online command help opens. This command is supported on the 32Way(B), 8Way, and ISPF models. It is not supported on the 32Way(H) model.
	cellx	-	-	-	Connect CELL Cards to the partition to which they belong. A vacant partition to which no CELL or IOX belongs is needed. This command is supported on the 32Way(B) and 8Way models.
	xbxcx	-	-	-	Connect XBX Cards to the system. On the 32Way(B) model, XBX Cards need be connected to the system in pairs: i.e. XBX Cards 0 and 2 or 1 and 3. A single XBX Card alone is not accepted. The XBX Card is not connectable to the 8Way model.
	xbxc0	portx			Connect inter-XBX external interface ports to the system, to which cabinets are connected. x: XBX port number (4-5) This command is supported on the ISPF system. It is valid when the operating systems are running (ACPI S0 State) on both systems.

cmd	arg1	arg2	arg3	arg4	Description
	pcibx	-	-	-	Connect PCI Bays to the partitions to which they belong. x: Physical PCI Bay number (0-7) This command is supported on the 32Way(B) model.
offline	-	-	-	-	<u>This command is currently not supported.</u> This command can be used to dynamically disconnect currently online components (CELL, XBX Card, and PCI Bay) from the system while the OS is running. If this command attempts to disrupt the current system operation, it will be rejected. This command remains invalid while any of the partitions within the system is booting up, shutting down, or handling an error. The CELL and PCI Bay are functional only if they are used in conjunction with the OS that supports this command. If no argument is specified or an argument has an error, the offline command help opens. This command is supported on the 32Way(B), 8Way, and ISPF models. It is not supported on the 32Way(H) model.
	cellx	-	-	-	Disconnect the CELL Cards from the system and shut off their power. The CELL that controls the Compatibility PCI is unable to be disconnected. The ISPF is not the target of this command.
	xbxcx	-	-	-	Disconnect the XBX Cards from the system. On the 32Way(B) model, they must always be disconnected in pairs: i.e. XBX Cards 0 and 2 or 1 and 3. It is not allowed to disconnect a single XBX Card alone. The XBX Cards are unable to be disconnected on the 8Way model.
	xbxc0	portx			Disconnect the inter-XBX external interface that connects cabinets. x: XBX port number (4-5) This command is supported on the ISPF System on which the OS is running (ACPI S0 State).
	pcibx	-	-	-	Disconnect the PCI Bay from the system and shut off its power. It is not allowed to disconnect the PCI Bay that contains the Compatibility PCI. This command is supported on the 32Way(B) model.
led	-	-	-	-	Use this command to turn on/off the LEDs used for device location checkout. If no argument is specified or an argument has an error, the led command help opens. This command is always valid to the CLK, XBX, and CELL Cards along with the PCI Bay regardless of the current system state. It is valid to the PCI slot only if the host GXB or PXH is online.

cmd	arg1	arg2	arg3	arg4	Description
	clk x	on off	-	-	Turn On/Off the LED on the CLK Card. x is a CLK Card number (0-1).
	xbxc x	on off	-	-	Turn On/Off the LED on the XBX Card. x is a XBX Card number (0-3).
	cell x	on off	-	-	Turn On/Off the LED on the CELL Card. x is a physical CELL number (0-7).
	pcib x	on off	-	-	Turn On/Off the LED on the PCI Bay. x is a PCI Bay number (0-7).
	pci x0y	on off	-	-	Turn On/Off the LEDs on the PCI Bay's PXH PCI slots by specifying the slot numbers printed on the back of the box. x is a PCI Bay number (0-7). y is a slot number (PXH slot number (1-8) printed on the back of the box).
	fn	on off	-	-	Turn On/Off the Fan-Box LEDs by specifying their locations.
	ffn				Argument fn specifies the rear-side Fan-Box, and ffn the front-side Fan-Box.
loc	-	-	-	-	This command is supported on the 8Way and ISPF models. Use this command to manually specify devices' location information. If no argument is specified or an argument has an error, the loc command help opens. This command is valid only if all the partitions are inactive.
	main	d			This command is supported on the 8Way and ISPF models. It sets the vertical position of the main chassis within the cabinet. Argument d specifies the position (U) of the bottom of the main chassis with a decimal number (0-40). The default value is null (0).
	pbay x	d	h	-	Set the vertical position and height of Power Bay No.1 that is installed outside the main chassis of the 8Way model. x is only valid if it specifies Power Bay No.1. Argument d specifies the position (U) of the bottom of the unit with a decimal number (0-40). Argument h specifies the height of the unit (2). This command is not supported on the 32Way, ISPF, or Power Bay No. 0 for the 8Way model as the Power Bay position and height are uniquely determined on those models.

cmd	arg1	arg2	arg3	arg4	Description
check	-	-	-	-	<p>This command is used to check the current system configuration focusing on the following points:</p> <ul style="list-style-type: none"> • Presence of units with unspecified locations • Presence of DISABLED components • Presence of INVISIBLE units <p>This command is always valid without regard to the current system state. The "DISABLE." components are not the target of this command.</p>
clear	rowxyy dirxzz	-	-	-	<p>Use this command to clear the ROW or Directory memory bit error counters. x is a physical CELL number (0-7). yy is a ROW number (00-15) within a CELL, which must be specified with a 2-digit number. zz is a Directory number (00-15) within a CELL, which must be specified with a 2-digit number.</p> <p>This command clears the 3 counters - the single-bit error counter that counts errors for every DIMM and the multibit error counter that counts errors for every ROW - at a time, along with the page deallocation entry table. Argument dirxzz is only supported on the 32Way(H) model.</p> <p>This command is always valid without regard to the current system state.</p>
bio	ioxy	[ioxz]	-	-	<p>Use this command to specify the BIO to be used on the IOX (PCI Bay) that is attached to a partition.</p> <p>For partitions with duplicated BIOs, use <arg2> to specify the IOX (PCI Bay) with a secondary BIO. If <arg2> is omitted, the secondary BIO is regarded to be non-existent.</p> <p>The IOX (PCI Bay) specified in this command must be attached to a partition. This command is valid only if the partition is inactive.</p> <p>It is not supported on the ISPF.</p>
scsi_split	pcibx	on off	-	-	<p>Use this command to specify the SCSI split mode (split mode ON or OFF) for PCI Bay No. x.</p> <p>Split mode is set to OFF by default. Split mode setting can be changed when the partition to which the pertinent PCI Bay belongs is inactive or the power to the PCI Bay is left off. Split mode setting cannot be changed while the partition is booting up or shutting down.</p>

Description of Status Indicator Strings

Indicator string	Description
nonexist.	Indicates that a resource is defined to be non-existent (the iSP does not assume that it "should" be existent).
INVISIBLE	The iSP assumes that the resource "should" be existent, but actually the resource is not visible to the iSP due to a failure or removal of a card. Once a resource is visible to the iSP (whether it is automatically detected or manually configured), it is subsequently assumed to be "existent" unless it is explicitly deleted with the delete command.
power-off	Indicates that the DC power is Off. On some components, the DC power is activated immediately when the AC power is applied.
power-ON	Indicates that the DC power is On. On some components, this indicator may be overwritten with any of the following indicators.
offline	Indicates that the component's DC power is On but it is not connected to the system as viewed from the software (OS or BIOS).
ONLINE	Indicates that the component's DC power is On and it is connected to the system as viewed from the software (OS or BIOS).
MASTER	This indicator is only valid for iSP/CLK status display. It indicates that the component is assigned as the master. When the CLK is assigned as the master, it means that it supplies the CELL and XBK Cards with the clocks.
backup	This indicator is only valid for iSP/CLK status display. It indicates that the component is assigned as backup. The CLK, if assigned as backup, is supplying the CELL or XBK Cards with no clocks. The backup indicator is active when the system is in Halt mode.
enable	Indicates that the component itself is valid (used for system operation).
enable-	Indicates that the component itself is valid but is reserved by software, etc. so it will not be used for system operation on a next boot.
enable*	Indicates that the component is invalid on a next shut-down due to component's own failure.
DISABLE	Indicates that the component itself is invalid (not used for system operation). The component is manually disconnected with the disable command.
DISABLE*	Indicates that the component itself is invalid (not used for system operation). The component is disconnected due to component's own failure. It should not be connected to the system until the failure is serviced.
DISABLE&	Indicates that the component itself is made invalid by a software request, and is to stay invalid on a next boot.
DISABLE+	Indicates that the component itself is made invalid by a software request, and is reversed to become valid on a next boot.
DISABLE .	Indicates that the component is invalid because it cannot be made valid due to its upper-level components or system configuration restrictions, but is reserved to be made valid on a next boot.
not used	Indicates an unused subcomponent.
DEG	Indicates that there are one or more subcomponents that are in DISABLE or DISABLE. state.
RUN	Indicates that the partition (BIOS) is already booted.
INIT	Indicates that the partition is being booted.
FAIL	Indicates that the partition is in a fatal fault.
SHUT	Indicates that the partition is being shut down.
DIAG	Indicates that the partition is running an auxiliary CELL diagnosis.
P-ON	Indicates that the partition is powered On for expanded diagnosis.
stop	Indicates that the partition is inactive (DC power off).

(Screen Example ... Help Screen)

	Description No.
<pre>iSPyz:---> hc<ENTER> iSP FW version is Rxx.xx. HC> help<ENTER> HC command help : help : print this message. disp : display current status. smem : set size of shared memory of a partition. attach : attach CELLS and IOXs to a partition. detach : detach CELLS and IOXs from a partition. swap : swap CELLS in a partition. add : add a component. delete : delete a component. enable : enable a component. disable : disable a component. online : make a component online. offline : make a component offline. led : turn on/off maintenance LED of a component. loc : set location info. clear : clear memory bit error counters. check : check illegal configuration. bio : add and set a bio to a pcibay. scsi_split : set/reset split mode of SCIS on PCIBAY quit : quit from HC command prompt.</pre>	<p>(a)</p> <p>(b)</p>

(Description)

Description No.	Description
(a)	If "help" is entered, the HC command help opens.
(b)	An HC command list appears.

(Screen Example ... ALL Screen)

	Description No.
<pre>iSPyz:---> hc<ENTER> iSP FW version is Rxx.xx. HC> disp all<ENTER> (32Way) The CIMB-CELL interleave memory size is only shown for the 32Way(B) model. When operating in inter-CELL interleave mode, an asterisk "*" appears. ==== Partitioning ===== 19:20:23,07/31/2005 === part0(RUN) CELL:01-----7 (01-----2) IOX:0-----67 (0-----12) CIMB: 32GB* part1(INIT) CELL:--2----- (--5-----) IOX:-1----- (-0-----) CIMB:128GB part2(stop) CELL:---3---- (-4----) IOX:--2---- (-0----) CIMB:---- part3(stop) CELL:-----6- (------3-) IOX:--3---- (-0----) CIMB:---- part4(----) CELL:----- (------) IOX:----- (------) CIMB:---- part5(----) CELL:----- (------) IOX:----- (------) CIMB:---- part6(----) CELL:----- (------) IOX:----- (------) CIMB:----</pre>	<p>(a)</p>

```

part7(----) CELL:----- (-) IOX:----- (-) CIMB:-----
=====
(8Way)
==== Partitioning ===== 19:20:23,07/31/2005 ===
part0(RUN ) CELL:01 (01) IOX:0- (0-)
part1(INIT) CELL:-- (-- ) IOX:-1 (-0)
=====

(ISPF)
==== Partitioning ===== 19:20:23,07/31/2005 ===
part0(RUN ) CELL:01 (01) IOX:0- (0-) SM: 4096MB
part1(INIT) CELL:-- (-- ) IOX:-1 (-0) SM: -----
=====
The SM size is shown for the ISPF.
(32Way)
==== Main cabinet ===== 19:20:23,07/31/2005 ===
POWBAY0 (loc=M-00/03) power-ON enable DEG
POWBAY1 (loc=M-03/03) power-ON enable DEG
---- CPU/Memory sub-chassis (loc=M-14/23) ----- 19:20:23,07/31/2005 ---
iSPO (loc=M-14/23) MASTER -----
iSP1 (loc=M-14/23) backup -----
CLK0 (loc=M-14/23) MASTER enable ---
CLK1 (loc=M-14/23) backup DISABLE* ---
XBX_C0(loc=M-14/23) offline enable
XBX_C1(loc=M-14/23) power-off DISABLE
XBX_C2(loc=M-14/23) ONLINE enable
XBX_C3(loc=M-14/23) ONLINE enable
CELL0 (loc=M-14/23) ONLINE enable DEG part.0 (LCN=0)
CELL1 (loc=M-14/23) power-off DISABLE DEG part.0 (LCN=1)
CELL2 (loc=M-14/23) ONLINE enable part.1 (LCN=5)
CELL3 (loc=M-14/23) power-off enable part.2 (LCN=4)
CELL4 (loc=M-14/23) nonexist. -----
CELL5 (loc=M-14/23) nonexist. -----
CELL6 (loc=M-14/23) power-off DISABLE* part.3 (LCN=3)
CELL7 (loc=M-14/23) INVISIBLE ----- part.0 (LCN=2)
---- PCIBAYs (Main) ----- 19:20:23,07/31/2005 ---
PCIBAY0(D) (loc=M-06/04) ONLINE enable DEG part.0 (LIN=2,-,S) *1
PCIBAY1(D) (loc=M-06/04) ONLINE enable part.1 (LIN=0,-,N) *1
PCIBAY2(D) (loc=M-16/04) ONLINE enable part.1 (LIN=1,P,N) *1
PCIBAY3(D) (loc=M-10/04) power-off enable part.2 (LIN=0,-,S) *1
==== End of Main cabinet =====

==== Expansion cabinet ===== 19:20:23,07/31/2005 ===
POWBAY2 (loc=E-00/03) power-ON enable
POWBAY3 (loc=E-03/03) power-ON enable
---- PCIBAYs (Expansion) ----- 19:20:23,07/31/2005 ---
PCIBAY4(D) (loc=E-06/04) power-off enable part.0 (LIN=0,-,N) *1
PCIBAY5(D) (loc=E-06/04) power-off enable part.0 (LIN=0,-,N) *1
PCIBAY6(D) (loc=E-10/04) power-off DISABLE DEG part.0 (LIN=0,-,N) *1
PCIBAY7(D) (loc=E-10/04) ONLINE enable DEG part.0 (LIN=1,-,N) *1
==== End of Expansion cabinet =====

```

(b)

(c)

(d)

(e)

```
(8Way)
==== Summary (loc=M-00/08) ===== 19:20:23,07/31/2005 ===
POWBAY0 (loc=M-00/08)    power-ON  enable

iSP0 (loc=M-00/08)      MASTER   -----   ---
CELL0 (loc=M-00/08)     ONLINE   enable     part.0 (LCN=0)
CELL1 (loc=M-00/08)     power-off DISABLE   DEG   part.0 (LCN=1)

PCIBAY0(D) (loc=M-00/08) ONLINE   enable     part.0 (LIN=0,P,N) *1
PCIBAY1(D) (loc=M-00/08) ONLINE   enable     part.0 (LIN=0,S,N) *1
==== End of Summary =====
```

(b)

```
(ISPF)
==== Summary (loc=M-00/10) ===== 19:20:23,07/31/2005 ===
POWBAY0 (loc=M-00/10)    power-ON  enable

iSP0 (loc=M-00/10)      MASTER   -----   ---
XBX_C0(loc=M-00/10)     power-off enable     DEG
CELL0 (loc=M-00/10)     ONLINE   enable     part.0 (LCN=0)
CELL1 (loc=M-00/10)     power-off DISABLE   DEG   part.0 (LCN=1)

PCIBAY0(D) (loc=M-00/10) ONLINE   enable     part.0 (LIN=0,P,N) *1
PCIBAY1(D) (loc=M-00/10) ONLINE   enable     part.0 (LIN=0,-,N) *1
==== End of Summary =====
```

(b)

*1 (LIN=x,y,z):
x: Logical IOX number
y: "P" for Primary BIO configuration, and "S" for Secondary BIO configuration
z: "S" if SCSI SPLIT Mode is selected, and "N" if it is deselected.

```
(For 32Way(H))
---- CELL0 ----- 19:20:23,07/31/2005 ---
CELL0 (loc=M-14/23)     ONLINE   enable     DEG   part.0 (LCN=2)
  CNX00                  ONLINE   DISABLE    ---
  PROC00                 offline  DISABLE    ---
  PROC01                 ONLINE   enable     ---
  CXI port0              ONLINE   enable     --- --->XBX00 CXI_P0
  CXI port2              offline  DISABLE    --- --->XBX00 CXI_P1
  CNX01                  ONLINE   DISABLE    ---
  PROC02                 offline  DISABLE*   ---
  PROC03                 nonexist.
  CXI port0              offline  DISABLE    --- --->XBX10 CXI_P0
  CXI port2              offline  DISABLE    --- --->XBX10 CXI_P1
  MMX00                  ONLINE   enable     DEG
  MMX01                  offline  enable     DEG
  MMX02                  offline  enable     DEG
  MMX03                  offline  enable     DEG
```

(f)

(For 32Way(B))

```

----- CELL0 ----- 19:20:23,07/31/2005 ---
CELL0 (loc=M-14/23)    ONLINE   enable   DEG   part.0 (LCN=2)
  CNX00                ONLINE   DISABLE  ---
  PROC00               offline  DISABLE  ---
  PROC01               ONLINE   enable   ---
  PROC02               offline  DISABLE* ---
  PROC03               nonexist.
  TAGO_e0              -----  -----  DEG
  TAGO_e1              -----  -----  DEG
  TAGO_o0              -----  -----  DEG
  TAGO_o1              -----  -----  DEG
  CXI port0            ONLINE   enable   ---   --->XBX00 CXI_P0
  CXI port1            offline  DISABLE  ---   --->XBX01 CXI_P0
  CXI port2            offline  DISABLE  ---   --->XBX10 CXI_P0
  CXI port3            offline  DISABLE  ---   --->XBX11 CXI_P0
  MMX00                ONLINE   enable   DEG
  MMX01                offline  enable   DEG
  MMX02                offline  enable   DEG
  MMX03                offline  enable   DEG

```

(For 8Way)

```

----- CELL0 ----- 19:20:23,07/31/2005 ---
CELL0 (loc=M-00/08)   ONLINE   enable   DEG   part.0 (LCN=2)
  CNX00                offline  enable   ---
  PROC00               offline  DISABLE  ---
  PROC01               ONLINE   enable   ---
  PROC02               offline  DISABLE* ---
  PROC03               nonexist.
  TAGO_e0              -----  -----  DEG
  TAGO_e1              -----  -----  DEG
  TAGO_o0              -----  -----  DEG
  TAGO_o1              -----  -----  DEG
  CXI port0            ONLINE   enable   ---   --->PCIBAY0_P0
  CXI port1            ONLINE   enable   ---   --->PCIBAY1_P1
  CXI port2            ONLINE   enable   ---   --->CELL1 CXI_P2
  CXI port3            ONLINE   enable   ---   --->CELL1 CXI_P3
  MMX00                ONLINE   enable   DEG
  MMX01                offline  DISABLE  DEG

```

(f)

(For ISPF)

```

----- CELLO ----- 19:20:23,07/31/2005 ---
CELL0 (loc=M-00/10)      ONLINE  enable  DEG  part.0 (LCN=2)
  CNX00                  ONLINE  enable  ---
    PROC00               offline  DISABLE ---
    PROC01               ONLINE  enable  ---
    PROC02               offline  DISABLE* ---
    PROC03               nonexist.
    TAG0_e0              -----  -----  DEG
    TAG0_e1              -----  -----  DEG
    TAG0_o0              -----  -----  DEG
    TAG0_o1              -----  -----  DEG
    CXI port0            ONLINE  enable  --- --->PCIBAY0_P0
    CXI port1            ONLINE  enable  --- --->XBX00 CXI_P0
    CXI port2            ONLINE  enable  --- --->CELL1 CXI_P2
    CXI port3            ONLINE  enable  --- --->CELL1 CXI_P3
  MMX00                  ONLINE  enable  DEG
  MMX01                  ONLINE  enable  DEG
    
```

(f)

(For 32Way(B), 8Way, or ISPF)

```

----- MMX00 ----- 19:20:23,07/31/2005 ---
  MMX00                  ONLINE  enable  DEG
    ROW00[DIMM00:01]    2GB  -----  enable  ---  SBE=000:000 MBE=000
    ROW01[DIMM02:03]    2GB  -----  enable  ---  SBE=000:000 MBE=000
    ROW02[DIMM04:05]    8GB  -----  enable  ---  SBE=000:000 MBE=000
    ROW03[DIMM06:07]    8GB  -----  enable  ---  SBE=000:000 MBE=000
    
```

(g)

```

----- MMX01 ----- 19:20:23,07/31/2005 ---
  MMX01                  ONLINE  enable
    ROW04[DIMM08:09]    2GB  -----  enable  ---  SBE=000:000 MBE=000
    ROW05[DIMM10:11]    2GB  -----  enable  ---  SBE=000:000 MBE=000
    ROW06[DIMM12:13]    8GB  -----  enable  ---  SBE=000:000 MBE=000
    ROW07[DIMM14:15]    8GB  -----  enable  ---  SBE=000:000 MBE=000
    
```

(MMXx2 and MMXx3 are only shown for 32Way(B).)

```

----- MMX02 ----- 19:20:23,07/31/2005 ---
  MMX02                  ONLINE  enable  DEG
    ROW08[DIMM16:17]    2GB  -----  enable  ---  SBE=000:000 MBE=000
    ROW09[DIMM18:19]    8GB  -----  enable  ---  SBE=000:000 MBE=000
    ROW10[DIMM20:21]    2GB  -----  enable  ---  SBE=000:000 MBE=000
    ROW11[DIMM22:23]    --GB  -----  DISABLE ---  SBE=000:000 MBE=000
    
```

(h)

```

----- MMX03 ----- 19:20:23,07/31/2005 ---
  MMX03                  ONLINE  enable  DEG
    ROW12[DIMM24:25]    2GB  -----  enable  ---  SBE=000:000 MBE=000
    ROW13[DIMM26:27]    8GB  -----  enable  ---  SBE=000:000 MBE=000
    ROW14[DIMM28:29]    2GB  -----  enable  ---  SBE=000:000 MBE=000
    ROW15[DIMM30:31]    --GB  -----  DISABLE ---  SBE=000:000 MBE=000
    
```

(For 32Way(H))

----- MMX00 ----- 19:20:23,07/31/2005 ---

MMX00	ONLINE	enable	DEG		
DIR00	8GB	-----	enable	---	SBE=000 MBE=000
ROW00[DIMM00:01]	16GB	-----	enable	---	SBE=000:000 MBE=000
DIR01	8GB	-----	enable	---	SBE=000 MBE=000
ROW01[DIMM02:03]	16GB	-----	enable	---	SBE=000:000 MBE=000
DIR02	1GB	-----	enable	---	SBE=000 MBE=000
ROW02[DIMM04:05]	1GB	-----	enable	---	SBE=000:000 MBE=000
DIR03	--GB	-----	DISABLE	---	SBE=000 MBE=000
ROW03[DIMM06:07]	--GB	-----	DISABLE	---	SBE=000:001 MBE=000

(g)

----- MMX01 ----- 19:20:23,07/31/2005 ---

MMX01	ONLINE	enable	DEG		
DIR04	8GB	-----	enable	---	SBE=000 MBE=000
ROW04[DIMM08:09]	16GB	-----	enable	---	SBE=000:000 MBE=000
DIR05	8MB	-----	enable	---	SBE=000 MBE=000
ROW05[DIMM10:11]	16GB	-----	enable	---	SBE=000:000 MBE=000
DIR06	1GB	-----	enable	---	SBE=000 MBE=000
ROW06[DIMM12:13]	1GB	-----	enable	---	SBE=000:000 MBE=000
DIR07	--GB	-----	DISABLE	---	SBE=000 MBE=000
ROW07[DIMM14:15]	--GB	-----	DISABLE	---	SBE=000:000 MBE=000

----- MMX02 ----- 19:20:23,07/31/2005 ---

MMX02	ONLINE	enable			
DIR08	2GB	-----	enable	---	SBE=000 MBE=000
ROW08[DIMM16:17]	4GB	-----	enable	---	SBE=000:000 MBE=000
DIR09	--GB	-----	enable	---	SBE=000 MBE=000
ROW09[DIMM18:19]	--GB	-----	enable	---	SBE=000:000 MBE=000
DIR10	2GB	-----	enable	---	SBE=000 MBE=000
ROW10[DIMM20:21]	4GB	-----	enable	---	SBE=000:000 MBE=000
DIR11	--GB	-----	enable	---	SBE=000 MBE=000
ROW11[DIMM22:23]	--GB	-----	enable	---	SBE=000:000 MBE=000

(h)

----- MMX03 ----- 19:20:23,07/31/2005 ---

MMX03	ONLINE	enable			
DIR12	2GB	-----	enable	---	SBE=000 MBE=000
ROW12[DIMM24:25]	4GB	-----	enable	---	SBE=000:000 MBE=000
DIR13	--GB	-----	enable	---	SBE=000 MBE=000
ROW13[DIMM26:27]	--GB	-----	enable	---	SBE=000:000 MBE=000
DIR14	2GB	-----	enable	---	SBE=000 MBE=000
ROW14[DIMM28:29]	4GB	-----	enable	---	SBE=000:000 MBE=000
DIR15	--GB	-----	enable	---	SBE=000 MBE=000
ROW15[DIMM30:31]	--GB	-----	enable	---	SBE=000:000 MBE=000

(For 32Way(B), 8Way, or ISPF)

```

----- TAGO_e ----- 19:20:23,07/31/2005 ---
TAGO_e0 -----
TAGO_e0 TAGL0 ----- enable ---
TAGO_e0 TAGL1 ----- enable ---
TAGO_e0 TAGL2 ----- DISABLE* ---
TAGO_e0 TAGL3 ----- enable ---
TAGO_e0 TAGL4 ----- enable ---
TAGO_e0 TAGL5 ----- enable ---
TAGO_e1 -----
TAGO_e1 TAGL0 ----- enable ---
TAGO_e1 TAGL1 ----- enable ---
TAGO_e1 TAGL2 ----- DISABLE* ---
TAGO_e1 TAGL3 ----- enable ---
TAGO_e1 TAGL4 ----- enable ---
TAGO_e1 TAGL5 ----- enable ---

```

(i)

```

----- TAGO_o ----- 19:20:23,07/31/2005 ---
TAGO_o0 -----
TAGO_o0 TAGL0 ----- enable ---
TAGO_o0 TAGL1 ----- enable ---
TAGO_o0 TAGL2 ----- enable ---
TAGO_o0 TAGL3 ----- enable ---
TAGO_o0 TAGL4 ----- enable ---
TAGO_e0 TAGL5 ----- enable ---
TAGO_o1 -----
TAGO_o1 TAGL0 ----- enable ---
TAGO_o1 TAGL1 ----- enable ---
TAGO_o1 TAGL2 ----- enable ---
TAGO_o1 TAGL3 ----- enable ---
TAGO_o1 TAGL4 ----- enable ---
TAGO_e1 TAGL5 ----- enable ---

```

(Subsequently listed to the max. CELL number.)

```

----- CELL1 ----- 19:20:23,07/31/2005 ---
:
:
:

```

(For 32Way(B))

```

----- XBX_C0 ----- 19:20:23,07/31/2005 ---
XBX_C0(loc=M-14/23)      ONLINE  enable  DEG
  XBX00 (loc=M-14/23)    ONLINE  enable  DEG
    CXI port00           ONLINE  enable  --- --->CELL0 CXI_P0
    CXI port01           offline  DISABLE* --- --->CELL1 CXI_P0
    CXI port02           ONLINE  enable  --- --->CELL2 CXI_P0
    CXI port03           offline  DISABLE* --- --->CELL3 CXI_P0
    IB_CABLE port04      ONLINE  enable  --- --->PCIBAY0_P0
    IB_CABLE port05      ONLINE  enable  --- --->PCIBAY2_P0
    XXI port06           ONLINE  enable  --- --->XBX_C2_P06
    XXI port07           offline  DISABLE* --- --->XBX_C2_P07

    XBX01 (loc=M-14/23)  ONLINE  enable  DEG
      CXI port10          ONLINE  enable  --- --->CELL0 CXI_P1
      CXI port11          offline  DISABLE* --- --->CELL1 CXI_P1
      CXI port12          ONLINE  enable  --- --->CELL2 CXI_P1
      CXI port13          offline  DISABLE* --- --->CELL3 CXI_P1
      IB_CABLE port14     ONLINE  enable  --- --->PCIBAY1_P0
      IB_CABLE port15     ONLINE  enable  --- --->PCIBAY3_P0
      XXI port16          ONLINE  enable  --- --->XBX_C2_P16
      XXI port17          offline  DISABLE* --- --->XBX_C2_P17

```

(j)

(For 32Way(H))

```

----- XBX_C0 ----- 19:20:23,07/31/2005 ---
XBX_C0(loc=M-14/23)      ONLINE  enable  DEG
  XBX00 (loc=M-14/23)    ONLINE  enable  DEG
    CXI port00           ONLINE  enable  --- --->CELL0 CXI_P00
    CXI port01           offline  DISABLE* --- --->CELL0 CXI_P10
    CXI port02           ONLINE  enable  --- --->CELL2 CXI_P00
    CXI port03           offline  DISABLE* --- --->CELL2 CXI_P10
    IB_CABLE port04      ONLINE  enable  --- --->PCIBAY0_P0
    IB_CABLE port05      ONLINE  enable  --- --->PCIBAY2_P0
    XXI port06           ONLINE  enable  --- --->XBX_C2_P06
    XXI port07           offline  DISABLE* --- --->XBX_C2_P17
    XXI port08           offline  DISABLE* --- --->XBX_C0_P18

    XBX01 (loc=M-14/23)  ONLINE  enable  DEG
      CXI port10          ONLINE  enable  --- --->CELL1 CXI_P00
      CXI port11          offline  DISABLE* --- --->CELL1 CXI_P10
      CXI port12          ONLINE  enable  --- --->CELL3 CXI_P00
      CXI port13          offline  DISABLE* --- --->CELL3 CXI_P10
      IB_CABLE port14     ONLINE  enable  --- --->PCIBAY1_P0
      IB_CABLE port15     ONLINE  enable  --- --->PCIBAY3_P0
      XXI port16          ONLINE  enable  --- --->XBX_C2_P16
      XXI port17          offline  DISABLE* --- --->XBX_C2_P07
      XXI port18          offline  enable  --- --->XBX_C0_P08

```

(j)

The XBX is non-existent on the 8Way.

(For ISPF)

```

----- XBX_C0 ----- 19:20:23,07/31/2005 ---
XBX_C0(loc=M-00/10)      ONLINE  enable  DEG
  XBX00 (loc=M-00/10)    ONLINE  enable  DEG
    CXI port00           ONLINE  enable  --- --->CELL0 CXI_P1
    CXI port01           offline  DISABLE* --- --->CELL1 CXI_P1
    IB_CABLE port04      ONLINE  enable  --- --->SYS1 XBX_C0_P04
    IB_CABLE port05      ONLINE  enable  --- --->SYS1 XBX_C0_P05

```

(j)

Base Module

```

(For 32Way, subsequently listed to the max. XBX Card number.)
---- XBX_C1 ----- 19:20:23,07/31/2005 ---
:
:
:

(32Way)
---- PCIBAY0(D) ----- 19:20:23,07/31/2005 ---
PCIBAY0(D) (loc=M-00/uu) ONLINE enable DEG part.0 (LIN=2,P,S)
  IOX00 ONLINE enable DEG
    IB_CABLE port0 ONLINE enable --- -->XBX_C0_P04
    IB_CABLE port1 ONLINE enable --- -->XBX_C2_P04
    IOC00 ONLINE enable DEG
    IOC01 ONLINE enable DEG
  GXB00 ONLINE enable --- BIO(primary) *2
    CORE PC1001 ONLINE enable --- *2
    CORE PC1002 ONLINE enable --- *2
  PXH00 ONLINE enable DEG
    PC1001 ONLINE enable ---
    PC1002 offline DISABLE ---
  PXH01 ONLINE enable ---
    PC1003 ONLINE enable ---
    PC1004 ONLINE enable ---
  PXH02 ONLINE enable ---
    PC1005 ONLINE enable ---
    PC1006 ONLINE enable ---
  PXH03 offline DISABLE ---
    PC1007 offline enable ---
    PC1008 offline enable ---
*2: Listed for the PCI Bay in which the Core Cards are installed.
(iSPF)
---- PCIBAY0(D) ----- 19:20:23,07/31/2005 ---
PCIBAY0(D) (loc=M-00/uu) ONLINE enable DEG part.0 (LIN=2,P,N)
  IOX00 ONLINE enable DEG
    IXI port0 ONLINE enable --- -->XBX_C0_P05
    IOC00 ONLINE enable DEG
    IOC01 ONLINE enable DEG
  GXB00 ONLINE enable --- BIOS(primary) *3
    CORE PC1001 ONLINE enable --- *3
    CORE PC1002 ONLINE enable --- *3
  PXH00 ONLINE enable DEG
    PC1001 ONLINE enable ---
    PC1002 offline DISABLE ---
  PXH01 ONLINE enable ---
    PC1003 ONLINE enable ---
    PC1004 ONLINE enable ---
  PXH02 ONLINE enable ---
    PC1005 ONLINE enable ---
    PC1006 ONLINE enable ---
  PXH03 offline DISABLE ---
    PC1007 offline enable ---
    PC1008 offline enable ---
*3: Listed for the PCI Bay in which the Core Cards are installed.

```

(k)

(k)

```

(8Way's internal PCIBAY)
----- PCIBAY0(D) ----- 19:20:23,07/31/2005 ---
PCIBAY0(D) (loc=M-00/uu)  ONLINE  enable  DEG  part.0 (LIN=2,S,S)
  IOX00                    ONLINE  enable  DEG
  IXI port0                ONLINE  enable  ---  --->CELL0 CXI_P0
  IXI port1                ONLINE  enable  ---  --->CELL1 CXI_P1
  IOC00                    ONLINE  enable  DEG
  IOC01                    ONLINE  enable  DEG
  GXB00                    ONLINE  enable  ---  BIO(secondary)  *4
  CORE PCI001              ONLINE  enable  ---  *4
  CORE PCI002              ONLINE  enable  ---  *4
  PXH00                    ONLINE  enable  DEG
  PCI001                   ONLINE  enable  ---
  PCI002                   offline  DISABLE ---
  PXH01                    ONLINE  enable  ---
  PCI003                   ONLINE  enable  ---
  PCI004                   ONLINE  enable  ---
  PXH02                    ONLINE  enable  ---
  PCI005                   ONLINE  enable  ---
  PCI006                   ONLINE  enable  ---
  PXH03                    offline  DISABLE ---
  PCI007                   offline  enable  ---
  PCI008                   offline  enable  ---

*4: Listed for the PCI Bay in which the Core Cards are installed. When the Duplicated BIO
mode is inactive, the GXB with a secondary BIO becomes invalid at the time of boot. Also
the GXB with unused BIO becomes invalid at the time of boot.
  GXB00                    offline  disable. ---
  CORE PCI001              offline  disable. ---  BIO(not used)
  CORE PCI002              offline  disable. ---

If no Core Cards are installed, the GXB00 and its subcomponent PCIs are not listed.

(Subsequently listed to the max. PCI Bay number.)
----- PCIBAY1(D) ----- 19:20:23,07/31/2005 ---
  :
  :
  :
  
```

(k)

```

----- PCIBAY0(D) ----- 19:20:23,07/31/2005 ---
PCI001: VID:xxxx DID:xxxx PCI err_rec.: no IO mapping: no
No.:xxxxxxxxxyyyyyzzzzzzwwwwvvvvvuuuuu Type:000001111122222333334444455555
PCI002: VID:xxxx DID:xxxx PCI err_rec.: no IO mapping: no
No.:xxxxxxxxxyyyyyzzzzzzwwwwvvvvvuuuuu Type:000001111122222333334444455555

PCI003: VID:xxxx DID:xxxx PCI err_rec.: no IO mapping: no
No.:xxxxxxxxxyyyyyzzzzzzwwwwvvvvvuuuuu Type:000001111122222333334444455555
PCI004: VID:xxxx DID:xxxx PCI err_rec.: no IO mapping: no
No.:xxxxxxxxxyyyyyzzzzzzwwwwvvvvvuuuuu Type:000001111122222333334444455555

PCI005: VID:xxxx DID:xxxx PCI err_rec.: no IO mapping: no
No.:xxxxxxxxxyyyyyzzzzzzwwwwvvvvvuuuuu Type:000001111122222333334444455555
PCI006: VID:xxxx DID:xxxx PCI err_rec.: no IO mapping: no
No.:xxxxxxxxxyyyyyzzzzzzwwwwvvvvvuuuuu Type:000001111122222333334444455555

PCI007: VID:xxxx DID:xxxx PCI err_rec.: no IO mapping: no
No.:xxxxxxxxxyyyyyzzzzzzwwwwvvvvvuuuuu Type:000001111122222333334444455555
PCI008: VID:xxxx DID:xxxx PCI err_rec.: no IO mapping: no
No.:xxxxxxxxxyyyyyzzzzzzwwwwvvvvvuuuuu Type:000001111122222333334444455555

In case the PCI Card is not existent:
PCI007: nonexist.

In the case where PCI Card's upper level components are disconnected:
PCI007: not available

----- PCIBAY0(D) ----- 19:20:23,07/31/2005 ---
Core_PCI001: VID:xxxx DID:xxxx PCI err_rec.: no IO mapping: no
No.:xxxxxxxxxyyyyyzzzzzzwwwwvvvvvuuuuu Type:000001111122222333334444455555
Core_PCI002: VID:xxxx DID:xxxx PCI err_rec.: no IO mapping: no
No.:xxxxxxxxxyyyyyzzzzzzwwwwvvvvvuuuuu Type:000001111122222333334444455555

(Subsequently listed to the max. PCI Bay number.)
----- PCIBAY1(D) ----- 19:20:23,07/31/2005 ---
:
:

(The number of DPS's depends on models)
(For 32Way)
----- POWBAYs (Main cabinet) ----- 19:20:23,07/31/2005 ---
POWBAY0 (loc=M-00/03) power-ON enable DEG
DPS00
DPS01 INVISIBLE
DPS02
DPS03 INVISIBLE
DPS04 nonexist.
DPS05 nonexist.
POWBAY1 (loc=M-03/03) power-ON enable DEG
DPS10
DPS11 INVISIBLE
DPS12 ALARM
DPS13
DPS14 nonexist.
DPS15 nonexist.

----- POWBAYs (Expansion cabinet) ----- 19:20:23,07/31/2005 ---
POWBAY2 (loc=E-00/03) power-ON enable DEG
DPS20

```

(l)

(m)

(n)

(n)

DPS21					
DPS22	INVISIBLE				
DPS23					
DPS24	nonexist.				
DPS25	nonexist.				
POWBAY3 (loc=----/---)	nonexist.				
DPS30	nonexist.				
DPS31	nonexist.				
DPS32	nonexist.				
DPS33	nonexist.				
DPS34	nonexist.				
DPS35	nonexist.				
(For 8Way/ISPF)					
----- POWBAYs ----- 19:20:23,07/31/2005 ---					
POWBAY0 (loc=M-03/uu)	power-ON	enable	DEG		
DPS00					
DPS01	INVISIBLE				
DPS02					
DPS03					
DPS04					
POWBAY1 (loc=M-00/03)	power-ON	enable	DEG		(o)
DPS10					
DPS11	INVISIBLE				
DPS12	ALARM				
DPS13					
DPS14	nonexist.				
DPS15	nonexist.				
* For the 8Way/ISPF model, there are three DPSs in Power Bay 0.					
* For the ISPF, Power Bay1 for dual AC systems is not configured.					

(Description)

Description No.	Description
(a)	Lists partition configuration information.
(b)	Lists the configuration of the components located in the Main Cabinet or Main Chassis.
(c)	Lists the configurations of the PCI Bays located in the Main Cabinet.
(d)	Lists the information of the Power Bays located in the Expansion Cabinet.
(e)	Lists the configuration of the PCI Bays located in the Expansion Cabinet.
(f)	Lists the configuration of CELL's subcomponents.
(g)	Lists the configuration of MMX's subcomponents.
(h)	Lists the configuration of Memory Daughter Card's subcomponents.
(i)	Lists the configuration of TAG's subcomponents.
(j)	Lists the configuration of XBX Card's subcomponents.
(k)	Lists the configuration of PCI Bay's subcomponents.
(l)	Lists the information of the PCI Cards placed under PXH within the PCI Bay.
(m)	Lists the information of the PCI Cards on the Core Card, if any Core Card exists in the PCI Bay.
(n)	Lists the configuration of the subcomponents of the Power Bays located in the 32Way model's Main and Expansion Cabinets.
(o)	Lists the configuration of the subcomponents of the Power Bay located in the 8Way/ISPF model.

2.4.6.8. HE (Help)

m	b	u
X	X	X

* Always valid without regard to the current system status.

Function:

This command is used to show a command list.

(“HELP” is also usable as well as “HE.”)

(Screen Example)

	Description No.
<pre>iSPyz:---> he<ENTER> iSP commands : System Control (both customers and maintenance persons) DF Shut down the system (override) DN - Shut down the system DP - Generate the system dump interrupt PC - Power cycle RS - Cold reset the system UB Bring up BIOS UP - Bring up the System Configuration (both customers and maintenance persons) HC - Hardware configuration and partitioning Miscellaneous (both customers and maintenance persons) CM - Change SP command mode to maintenance mode DT - SP Date and Time EN - Display environmental information FV - Display firmware versions HE - Display this help ML - Display message log Settings (both customers and maintenance persons) SG SP/System settings SR - Save and restore system CMOS/NvRAM to/from FTP server HE command terminated.</pre>	(a)

(Description)

Description No.	Description
(a)	Shows the help for commands.

2.4.6.9. ML (Message Log)

m	b	u
X	X	X

* Always valid without regard to the current system status.

Function:

This command is used to show the contents of the iSP's message buffer.

(Messages that are output as a result of message buffer log display itself are not stored to the message buffer.)

(Screen Example)

	Description No.
<pre>iSPyz:--> ml <ENTER> ML command displays iSP s message log buffer. Select interactive mode? (i[nteractive per page]/a[ll]/CR=exit) : i<ENTER> ***** start of message logs ***** XXXXXXXXXXXXXXXXXXXX XX : : XXXXXXXXXXXXXXXXXXXX Next ? (n[ext]/CR=exit) : n<ENTER> XXXXXXXXXXXXXXXXXXXX XX : : XXXXXXXXXXXXXXXXXXXX Previous/Next ? (p[revious]/n[ext]/CR=exit) : n<ENTER> XXXXXXXXXXXXXXXXXXXX XX : : XXXXXXXXXXXXXXXXXXXX Previous ? (p[revious]/CR=exit) : <ENTER> ***** end of message logs ***** ML command terminated.</pre>	<p>(a)</p> <p>(b)</p> <p>(c)</p> <p>(d)</p> <p>(e)</p>

(Description)

Description No.	Description
(a)	Allows to choose from two modes: one that prompts operator entry for each log page display, and the other that shows the entire buffer log at a time.
(b)	You are prompted entry if a next page exists.
(c)	You are prompted entry if a previous and next pages exist.
(d)	You are prompted entry if a previous page exists.
(e)	Shows a command terminated message.

2.4.6.10. PC (Power Cycle)

m	b	u
X		

* The command is executable to the active partition (after automatic system boot/UP command execution).

Function:

This command is used to cycle system power (system reboot after system DC power off).

Note that this command shuts off system power without regard to the current OS or BIOS status or notifying nothing to the OS or BIOS.

Partitions that are already off or those being shut down are not the target of this command.

(Screen Example)

	Description No.
iSPyz:---> pc<ENTER> CAUTION: System power will be turned off without any notice to the softwares even if they are running.	
Enter partition number (0-7/all/CR=exit) : 0<ENTER>	(a)
Execute OK? (y/[n]) y<ENTER>	(b)
PC command was accepted. System power of all partitions will be turned off soon and then will be turned on.	(c)
mm/dd/yyyy HH:MM:SS 0----- System shutdown started. (SPFW:Rxx.xx) :	
mm/dd/yyyy HH:MM:SS 0----- System shutdown completed. (SPFW:Rxx.xx)	
mm/dd/yyyy HH:MM:SS 0----- System initialization started. (SPFW:Rxx.xx) :	
mm/dd/yyyy HH:MM:SS 0----- System initialization completed. (SPFW:Rxx.xx) [iSP0m:INFO.2129] partition 0 : handed off the control to BIOS. (DIPSW = 00000000)	(d)

(Description)

Description No.	Description
(a)	Prompts a partition number. If "all" is specified, all the existing partitions are the target of this command.
(b)	Enter y at this confirmation message if you are sure to continue command execution.
(c)	A "PC command accepted" message appears. The actual processing progresses in the background.
(d)	Shows the progress in the background.

2.4.6.11. RS (Cold Reset System)

m	b	u
X		

* The command is executable to the active partition (after automatic system boot/UP command execution).

Function:

This command causes the system to be cold-reset.

Note that this command could reset the system while the OS (BIOS) is running, notifying nothing to the software.

Partitions that are already off or those being shut down are not the target of this command.

(Screen Example)

	Description No.
iSPyz:---> rs<ENTER>	
CAUTION: System will be resetted without any notice to the softwares even if they are running.	
Enter partition number (0-7/all/CR=exit) : 0<ENTER>	(a)
Execute OK? (y/[n]) y<ENTER>	(b)
RS command was accepted. All partitions will be reset soon.	(c)
mm/dd/yyyy HH:MM:SS 0----- System shutdown started. (SPFW:Rxx.xx)	
:	
mm/dd/yyyy HH:MM:SS 0----- System shutdown completed. (SPFW:Rxx.xx)	
mm/dd/yyyy HH:MM:SS 0----- System initialization started. (SPFW:Rxx.xx)	(d)
:	
mm/dd/yyyy HH:MM:SS 0----- System initialization completed. (SPFW:Rxx.xx)	
[iSP0m:INFO.2129] partition 0 : handed off the control to BIOS. (DIPSW = 00000000)	

(Description)

Description No.	Description
(a)	Prompts a partition number. If "all" is specified, all the existing partitions are the target of this command.
(b)	Enter y at this confirmation message if you are sure to continue command execution.
(c)	An "RS command accepted" message appears. The actual processing progresses in the background.
(d)	Shows the progress in the background.

2.4.6.12. SG (SP/System Setting)

m	B	u
X	X	X

* Always valid without regard to the current system status.

Function:

This command is used to make various system settings and configure the iSP operation environment.

Main Menu	Sub Menu	Config. Parameter	Remarks
System configuration settings	System common settings (maintenance only) (*1)	System common	
	Partition settings (maintenance only) (*1)	Partition configuration	Valid after a next partition boot
	Partition boot methods and Hot-Plug permission	Setting for the means of partition boot and hot plug enable	Valid after a next partition boot
	display all settings	Show all system settings on console.	
iSP settings (*2)	LAN/Serial settings	LAN/serial port configuration	After a configuration change, iSP need be reset.
	FTP server settings	FTP server settings	
	SNMP settings	SNMP-related configuration	After a configuration change, iSP need be reset.
	display all setting	Show all iSP settings on the console.	
display all settings	N/A	Show all system and iSP settings on the console.	

(*1) Changes to configuration parameters are only allowed in the Maintenance mode.

(*2) In a duplicated iSP environment, iSP configuration must be done on each of the duplicated iSPs.

Setting partition boot method and hot-plug permission:

Category		Configuration Parameter	Default Setting
For each partition	AC Link	[AC LINK MODE] Specifies whether or not the partition is to be booted immediately when an AC power is applied.	off
	Wake on LAN	[Wake on LAN] Specifies whether partition boot by Wake on LAN is enabled or not.	off

Category	Configuration Parameter	Default Setting
Hot Plug permission	[Hot Plug permission] Specifies whether Hot-Plug is enabled or not, for each of the target components. Target components: CELL, PCIDBAY, PCIEBAY, PCI(X) card, and PCI-Ex card The 8Way model has no PCIDBAY or PCIEBAY settings. The 32Way(H) and ISPF require PCI(X) card and PCI-Ex card settings.	off

SP LAN/Serial Port Setting:

Category	Configuration Parameter	Default Setting	
LAN/Serial	The following parameter settings are needed depending on the other device (terminal emulator) to which the SP is connected as a local console.	-	
	Baud rate	9600	
	Data bit width is only listed. It is unable to be changed.	8	
	Stop bit width is only listed. It is unable to be changed.	1	
	Parity is only listed. It is unable to be changed.	None	
	Flow control is only listed. It is unable to be changed.	RTS/CTS	
	LAN0	IP address for LAN0	192.168.119.100 or 192.168.119.101
		Subnet mask	255.255.255.0
		Gateway IP address	N/A
	LAN1 [ISPF only]	IP address for LAN1. LAN1's subnet must be different from LAN0's subnet.	192.168.119.200
		Subnet mask	255.255.255.0
		Gateway IP address	N/A
	NTP server	NTP server's IP address. If the server IP address is set, iSP's internal clock is corrected every 1 hour. If the IP address is omitted, the iSP clocks on its own.	N/A
	ISPF Cluster	System number (*3) [ISPF only]	[Self SYSTEM NUMBER] System number (0 or 1). It is used as part of cabinet location numbers. Different system numbers must be set for the 2 cabinets that constitute a cluster.
Cabinet clustering (*3) [ISPF only]		Specifies whether cabinet clustering is used or not.	no
Cabinet-clustered SP LAN0/1 (*3) [ISPF only]		For cabinet clustering, the other iSP's IP address is specified. LAN1's subnet must be different from LAN0's subnet.	LAN0: 192.168.119.110 LAN1: 192.168.119.210

(*3): If any of these configuration parameters has been changed, reset the SP in ISPF System 2.

SP default FTP Server Configuration:

Category	Configuration Parameter	Default Setting
FTP Server	IP address for the default FTP server	N/A
	Account for the default FTP server (up to 20 characters) [Account is case-sensitive.]	N/A
	Password for the default FTP server, used in pair with the account (password is not echoed. Up to 78 characters may be used.) [Password is case-sensitive.]	N/A
	Name of the folder to save auto notification messages (up to 30 characters). Two-byte characters or space character are not allowed for the folder name. Characters that are not usable as folder names on the FTP server are not allowed either.	N/A

SP SNMP Configuration:

Category	Configuration Parameter	Default Setting	
SNMP	Manager IP address [0] IP address for SNMP manager. Up to two managers can be configured.	N/A	
	Manager IP address1 [ISPF only] IP address for SNMP manager. Up to two managers can be configured, and up to two IP addresses are assignable for each manager. Two IP addresses, if assigned to a manager, must have different subnet addresses.	N/A	
	Community name	Community names for use on the SNMP. (Up to 3 community names are usable for TRAP, information acquisition, and information setting purposes. Up to 16 characters are usable for a community name.) [Community name is case-sensitive.]	"public"
		Specifies whether message authentication with higher security using MD5 is to be used with the SNMP manager.	off
		Key data for message authentication with higher security using MD5 used with the SNMP manager (key data has a 16-byte length). [Key data is not echoed.]	N/A
		System ID used for communications with the SNMP manager (up to 8 characters are usable). This system ID is also used for ESMPRO and for collaboration between ESMPRO and VOE (*1). A system ID must be set in advance to ESMPRO installation.	N/A
	VOE (*4) collaboration Specifies whether or not collaboration is made with VOE (*1), if it exists in the system.	no	

(*4) VOE represents SystemGlobe GlobalMaster.

Screen examples for partition boot method and hot-plug permission	Description No.
<pre> iSPyz:MNT> sg<ENTER> Display and modify settings of system and iSP. s) System settings i) iSP settings a) display all settings Select ? (s/i/a/CR=exit) : s<ENTER> System setting menu: c) system common settings (maintenance only) p) partition settings (maintenance only) b) partition boot methods and Hot-plug permission a) display all settings Select ? (c/p/b/a/CR=back) : b<ENTER> (For 32Way(B)) Partition boot methods and Hot-plug permissions: Wake Hot-Plug permission part. AC- On PCI-card CELL PCI-D PCI-E LINK LAN PCI(X) PCI-EX add remv swap add remv add remv -----+-----+-----+-----+-----+-----+-----+-----+-----+-----+-----+-----+----- 0 off off YES no YES no YES no YES no no 1 off off YES no YES no YES no YES no no 2 off off YES no YES no YES no YES no no 3 off off YES no YES no YES no YES no no 4 off off YES no YES no YES no YES no no 5 off off YES no YES no YES no YES no no 6 off off YES no YES no YES no YES no no 7 off off YES no YES no YES no YES no no Modify? (y/[n]) : <ENTER> (For 8Way) Partition boot methods and Hot-plug permissions: Wake Hot-Plug permission part. AC- On PCI-card CELL LINK LAN PCI(X) PCI-EX add remv swap -----+-----+-----+-----+-----+-----+-----+-----+-----+-----+-----+-----+----- 0 off off YES no YES no YES 1 off off YES no YES no YES 2 off off YES no YES no YES 3 off off YES no YES no YES 4 off off YES no YES no YES 5 off off YES no YES no YES 6 off off YES no YES no YES 7 off off YES no YES no YES Modify? (y/[n]) : y<ENTER> (For 32Way(H) or ISPF) </pre>	<p>(a)</p> <p>(b)</p> <p>(c)</p> <p>(c)</p> <p>(c)</p>

```

Partition boot methods and Hot-plug permissions:
  |      |Wake |Hot-Plug permission
part.| AC-  | On  | PCI-card
  | LINK| LAN | PCI(X)|PCI-EX
-----+-----+-----+-----+-----
  0 | off | off | YES  | no
  1 | off | off | YES  | no
  2 | off | off | YES  | no
  3 | off | off | YES  | no
  4 | off | off | YES  | no
  5 | off | off | YES  | no
  6 | off | off | YES  | no
  7 | off | off | YES  | no

Modify? (y/[n]) : y<ENTER>
Enter partition number? (0-7/CR=back) : 2<ENTER>
AC link mode (on/off/CR=skip)       : <ENTER>
Wake on LAN (on/off/CR=skip)        : on<ENTER>
Hot plug permission:
  PCI(X) card? (yes/no/CR=skip) : <ENTER>
  PCI-Ex card? (yes/no/CR=skip) : <ENTER>
  CELL Hot-add ? (yes/no/CR=skip) : <ENTER> *2
  CELL Hot-remove ? (yes/no/CR=skip) : <ENTER> *2
  CELL Hot-swap ? (yes/no/CR=skip) : <ENTER> *2
  PCID BAY Hot-add ? (yes/no/CR=skip) : <ENTER> *2 *3
  PCID BAY Hot-remove ? (yes/no/CR=skip) : <ENTER> *2 *3
  PCIE BAY Hot-add ? (yes/no/CR=skip) : <ENTER> *2 *3
  PCIE BAY Hot-remove ? (yes/no/CR=skip) : <ENTER> *2 *3
*2: For the 32Way(B) model, an inquiry appears.
    For the 32Way(H) or ISPF model, no inquiry will appear.
*3: For the 8Way model, no inquiry will appear either.
Enter partition number? (0-7/CR=back) : <ENTER>
(For 32Way(B))
Partition boot methods and Hot-plug permissions:
  |      |Wake |Hot-Plug permission
part.| AC-  | On  | PCI-card |      CELL      |      PCI-D      |      PCI-E
  | LINK| LAN | PCI(X)|PCI-EX| add |remv |swap | add |remv | add |remv
-----+-----+-----+-----+-----+-----+-----+-----+-----+-----+-----+-----
  0 | off | off | YES  | no | YES | no | YES | no | YES | no | no
  1 | off | off | YES  | no | YES | no | YES | no | YES | no | no
  2 | off | off | YES  | no | YES | no | YES | no | YES | no | no
  3 | off | off | YES  | no | YES | no | YES | no | YES | no | no
  4 | off | off | YES  | no | YES | no | YES | no | YES | no | no
  5 | off | off | YES  | no | YES | no | YES | no | YES | no | no
  6 | off | off | YES  | no | YES | no | YES | no | YES | no | no
  7 | off | off | YES  | no | YES | no | YES | no | YES | no | no

Modify? (y/[n]) :
System setting menu:

  c) system common settings (maintenance only)
  p) partition settings (maintenance only)

```

(d)

(e)

<p>b) partition boot methods and Hot-plug permission a) display all settings</p> <p>Select ? (c/p/b/a/CR=back) : <ENTER> Display and modify settings of system and iSP.</p> <p>s) System settings i) iSP settings a) display all settings</p> <p>Select ? (s/i/a/CR=exit) : <ENTER></p>	
---	--

(Description)

Description No.	Description
(a)	The Main Menu appears. In the screen example above, option s) System setting is chosen.
(b)	The Sub-Menu for System Setting opens. Option b) partition boot methods is chosen here.
(c)	The current setting for partition boot methods appears. If you wish to change the setting, enter "y."
(d)	Enter values at the prompts.
(e)	The modified parameter settings are listed. Pressing <ENTER> returns the screen to Sub-Menu.

Screen Example for iSP LAN/Serial Parameter Setting:	Description No.
<p>iSPyz: MNT> sg<ENTER> Display and modify settings of system and iSP.</p> <p>s) System settings i) iSP settings a) display all settings</p> <p>Select ? (s/i/a/CR=exit) : i<ENTER> iSP setting menu:</p> <p>c) LAN/Serial settings f) FTP server settings s) SNMP settings a) display all settings</p> <p>Select ? (c/s/f/a/CR=back) : c<ENTER> iSP LAN/Serial console settings :</p> <p>Console Port baud rate : 9600 parity : none data bits : 8 flow control : RTS/CTS stop bit : 1</p> <p>LAN LAN0 IP address : 192.168.100.31 LAN0 subnet mask : 255.255.255.128</p>	<p>(a)</p> <p>(b)</p> <p>(c)</p>

<pre> LAN1 IP address : 192.168.100.231 (ISPF only) LAN1 subnet mask : 255.255.255.128 (ISPF only) gateway IP : N/A NTP server IP : N/A Self system number : 0 (ISPF only) Cooperation with SysX : yes (ISPF only) SysX iSP LAN0 IP address : 192.168.100.41 (ISPF only) SysX iSP LAN1 IP address : 192.168.100.241 (ISPF only) Modify? (y/[n]) : y<ENTER> </pre>	
<pre> Serial baud rate (9600/19200/38400/CR=skip) : <ENTER> LAN0 IP address (xxx.xxx.xxx.xxx/n[ot use]/CR=skip) : <ENTER> LAN0 subnet mask (xxx.xxx.xxx.xxx/CR=skip) : <ENTER> LAN1 IP address (xxx.xxx.xxx.xxx/n[ot use]/CR=skip) : <ENTER> (ISPF only) LAN1 subnet mask (xxx.xxx.xxx.xxx/CR=skip) : <ENTER> (ISPF only) gateway IP (xxx.xxx.xxx.xxx/n[ot use]/CR=skip) : <ENTER> NTP server IP (xxx.xxx.xxx.xxx/n[ot use]/CR=skip) : <ENTER> Self system number (0-1/CR=skip) : <ENTER> (ISPF only) cooperation with SysX (y/n/CR=skip) : <ENTER> (ISPF only) SysX iSP LAN0 IP address (xxx.xxx.xxx.xxx/CR=skip) : <ENTER> (ISPF only) SysX iSP LAN1 IP address (xxx.xxx.xxx.xxx/CR=skip) : <ENTER> (ISPF only) iSP LAN/Serial console settings : Console Port baud rate : 9600 parity : none data bits : 8 flow control : RTS/CTS stop bit : 1 LAN LAN0 IP address : 192.168.100.31 LAN0 subnet mask : 255.255.255.128 LAN1 IP address : 192.168.100.231 LAN1 subnet mask : 255.255.255.128 gateway IP : N/A NTP server IP : N/A Self system number : 0 cooperation with SysX : YES SysX iSP LAN0 IP address : 192.168.100.41 SysX iSP LAN1 IP address : 192.168.100.241 </pre>	<p>(d)</p> <p>(e)</p>
<pre> Modify? (y/[n]) : <ENTER> iSP setting menu: c) LAN/Serial settings f) FTP server settings s) SNMP settings a) display all settings Select ? (c/s/f/a/CR=back) : <ENTER> </pre>	<p>(f)</p>

<pre> default FTP account (CR=skip) : <ENTER> default FTP password (CR=skip) : <ENTER> Re-enter default FTP password : <ENTER> Enter folder name (CR=skip) : <ENTER> iSP FTP server settings : default FTP server IP : 192.168.100.30 default FTP account : asamasp folder name for autocall : Modify? (y/[n]) : <ENTER> iSP setting menu: c) LAN/Serial settings f) FTP server settings s) SNMP settings a) display all settings Select ? (c/s/f/a/CR=back) : <ENTER> Display and modify settings of system and iSP. s) system settings i) iSP settings a) display all settings Select ? (s/i/a/CR=exit) : <ENTER> SG command terminated. </pre>	<p>(e)</p> <p>(f)</p> <p>(g)</p>
--	----------------------------------

(Description)

Description No.	Description
(a)	The Main Menu appears. In the screen example above, option i) iSP settings is chosen.
(b)	The Sub-Menu for iSP Settings opens. Option f) FTP server settings is chosen here.
(c)	The current FTP server setting appears. If you wish to change the setting, enter "y."
(d)	Enter values at the prompts.
(e)	The modified parameter settings are listed. Pressing <ENTER> returns the screen to Sub-Menu.
(f)	The Sub-Menu opens. Pressing <ENTER> returns the screen to Main Menu.
(g)	Pressing <ENTER> quits this command.

Screen Example for iSP SNMP Setting:	Description No.
<pre> iSPyz:MNT> sg<ENTER> Display and modify settings of system and iSP. s) System settings </pre>	<p>(a)</p>

<pre> i) iSP settings a) display all settings Select ? (s/i/a/CR=exit) : i<ENTER> iSP setting menu: c) LAN/Serial settings f) FTP server settings s) SNMP settings a) display all settings </pre>	(b)
<pre> Select ? (c/s/f/a/CR=back) : s<ENTER> iSP SNMP settings : Manager1 LAN0 IP : 192.168.100.30 (ISPF only) Manager1 LAN1 IP : N/A (ISPF only) Manager2 LAN0 IP : N/A (ISPF only) Manager2 LAN1 IP : N/A (ISPF only) Manager IP 1 : N/A (Other than ISPF) Manager IP 2 : N/A (Other than ISPF) community(Trap) : public community(Get) : public community(Set) : public security option : off system ID : N/A cooperation with VOE : no </pre>	(c)
<pre> Do you want to edit these settings? (y/[n]) : y<ENTER> Serial baud rate (9600/19200/38400/CR=skip) : <ENTER> Manager1 LAN0 IP (xxx.xxx.xxx.xxx/n[ot use]/CR=skip) : <ENTER> (ISPF only) Manager1 LAN1 IP (xxx.xxx.xxx.xxx/n[ot use]/CR=skip) : <ENTER> (ISPF only) Manager2 LAN0 IP (xxx.xxx.xxx.xxx/n[ot use]/CR=skip) : <ENTER> (ISPF only) Manager2 LAN1 IP (xxx.xxx.xxx.xxx/n[ot use]/CR=skip) : <ENTER> (ISPF only) Manager IP 1 (xxx.xxx.xxx.xxx/n[ot use]/CR=skip) : <ENTER> (Other than ISPF) Manager IP 2 (xxx.xxx.xxx.xxx/n[ot use]/CR=skip) : <ENTER> (Other than ISPF) </pre>	(d)
<pre> community(Trap) (CR=skip) : <ENTER> community(Get) (CR=skip) : <ENTER> community(Set) (CR=skip) : <ENTER> security option (o[n]/of[f]/CR=skip) : o<ENTER> SNMP key code (CR=skip) : 00112233445566778899aabbccddeeff<ENTER> re-enter key code : 00112233445566778899aabbccddeeff<ENTER> system ID (CR=skip) : <ENTER> cooperation with VOE (y/n/CR=skip) : <ENTER> </pre>	
<pre> iSP SNMP settings : Manager1 LAN0 IP : 192.168.100.30 (ISPF only) Manager1 LAN1 IP : N/A (ISPF only) Manager2 LAN0 IP : N/A (ISPF only) Manager2 LAN1 IP : N/A (ISPF only) Manager IP 1 : N/A (Other than ISPF) </pre>	(e)

2.4.6.13. SR (Save System CMOS/NvRAM)

m	b	u
X		

* For cautions for using this command, read the following description of function.

Function:

This command is used to read the contents of the system CMOS/NvRAM and save them to the FTP Server, or in turn, restore them from FTP Server files.

The target partitions of this command must be in the EFI shell prompt state, with their BIOS booted up. In any other states, not only the correct system operation is not guaranteed, but the contents of the system CMOS/NvRAM might be destroyed.

RTC data will not be saved to or restored from the CMOS memory.

(Screen Example)

	Description No.
iSPyz:---> sr <ENTER> CAUTION: This command MUST be used when target system is in EFI shell prompting. Otherwise CMOS/NvRAM may be DESTROYED or this command do NOT work properly.	
Enter partition number? (0-7/CR=exit) : 1 <ENTER>	(a)
Save of Restore? (s/r/CR=back) : s <ENTER> getting CMOS/NvRAM from partition 1... got.	(b)
----- ERROR: cannot get CMOS/NvRAM from partition 1. Check the state of partition 1. Enter partition number? (0-7/CR=exit) :	(c)
----- IP of FTP server [default=10.0.0.2] (CR=skip) : 10.0.0.3 <ENTER> account [default=necuser] : necuser <ENTER> password [default=*****] : xxxxxxx <ENTER> file path : cmossave/cmos1.bin <ENTER>	(d)
Save OK? (y/[n]) : y <ENTER> connecting... uploaded.	(e) (f)
Enter partition number? (0-7/CR=exit) : 2 <ENTER> Save or Restore? (s/r/CR=back) : r <ENTER> IP of FTP server [default=10.0.0.2] (CR=skip) : 10.0.0.3 <ENTER> account [default=necuser] : necuser <ENTER> password [default=*****] : xxxxxxx <ENTER> file path : cmossave/cmos2.bin <ENTER>	(h)
Restore OK? (y/[n]) : y <ENTER> connecting... connected. downloaded.	(i) (j)

ERROR: cmossave/cmos2.bin does not exist. Enter partition number? (0-7/CR=exit) :	(k)
checking downloaded file. passed. restoring CMOS/NvRAM... completed. You need to reset the target partition.	(l)
Enter partition number? (0-7/CR=exit) : <ENTER> SR command terminated.	(m)

(Description)

Description No.	Description
(a)	Enter the target partition No., and then choose "s" to start saving.
(b)	Shows data reading from the specified partition in progress.
(c)	If a read error occurred, an error message appears and the screen returns to the partition No. prompt.
(d)	Enter the save destination FTP Server information. [Account, password, and file path name are all case-sensitive.] Up to 20 characters are usable for an account, up to 78 characters for a password, and up to 100 characters for a file path. If any of them exceeds these limits, reconfigure the FTP Server as needed.
(e)	If you are sure that the server information you entered is correct, enter "y."
(f)	Shows data saving to the FTP Server in progress.
(h)	Shows an example of restore procedure.
(i)	Enter FTP Server information for confirmation.
(j)	Shows data restoration from the FTP Server in progress.
(k)	If data restoration failed, an error message appears, and the screen returns to the partition No. prompt.
(l)	Shows data restoration to the specified partition in progress.
(m)	Pressing <ENTER> quits the SR command.

2.4.6.14. UB (Bring up BIOS)

m	b	u
X		

* The command is executable to the active partition (after automatic system boot/UP command execution).

Function:

This command is used to boot the BIOS without booting the OS.

It turns the system DC power On, initializes the hardware, and boots up the BIOS, but the EFI Shell will not boot the OS.

The UP command is needed to boot up the OS.

(Screen Example)

	Description No.
iSPyz:---> ub <ENTER> This command will bring up the specified partition.	
Enter partition number (0-7/all/CR=exit) : all <ENTER>	(a)
Execute OK? (y/[n]) y <ENTER>	(b)
UB command was accepted. All partitions will run soon.	(c)
mm/dd/yyyy HH:MM:SS 0----- System initialization started. (SPFW:Rxx.xx) [iSP0m:INFO.2094] partition 0 : turning on POWBAY(s)... :	
mm/dd/yyyy HH:MM:SS 0----- System initialization completed. (SPFW:Rxx.xx) :	(d)
[iSP0m:INFO.2129] partition 0 : handed off the control to BIOS. (DIPSW = 00000000)	

(Description)

Description No.	Description
(a)	Enter partition number. If "all" is specified, all the existing partitions are the target of this command.
(b)	A confirmation message appears. If you are sure to continue, enter "y." If the first 1 byte of the BIOS virtual DIPSW is not zero, the following confirmation message will appear: Partition x BIOS virtual DIPSW is ON. (DIPSW=xyyyyyyy) Continue? ([y]/n) If you are sure to continue BIOS boot, enter "y." If you wish to abort, enter "n."
(c)	A "UB command accepted" message appears. The actual boot is performed in the background.
(d)	Shows boot progress in the background.

2.4.6.15. UP (Bring up System)

m	b	u
X		

* This command is valid to inactive partitions (DC Off).

Function:

This command is used to turn the system DC power On, initialize the hardware, and boot up the BIOS. Whether to subsequently boot the OS depends on the BIOS/EFI settings.

(Screen Example)

	Description No.
iSPyz:---> up<ENTER> This command will bring up the specified partition.	
Enter partition number (0-7/all/CR=exit) : all<ENTER>	(a)
Execute OK? (y/[n]) y<ENTER>	(b)
UP command was accepted. All partitions will run soon.	(c)
mm/dd/yyyy HH:MM:SS 0----- System initialization started. (SPFW:Rxx.xx) [iSP0m:INFO.2094] partition 0 : turning on POWBAY(s)... :	
mm/dd/yyyy HH:MM:SS 0----- System initialization completed. (SPFW:Rxx.xx) [iSP0m:INFO.2129] partition 0 : handed off the control to BIOS. (DIPSW = 00000000)	(d)

(Description)

Description No.	Description
(a)	Enter partition number. If "all" is specified, all the existing partitions are the target of this command.
(b)	A confirmation message appears. If you are sure to continue, enter "y." If the first 1 byte of the BIOS virtual DIPSW is not zero, the following confirmation message will appear: Partition x BIOS virtual DIPSW is ON.(DIPSW=xyyyyyy) Continue? ([y]/n) If you are sure to continue the boot process, enter "y." If you wish to abort, enter "n."
(c)	A "UP command accepted" message appears. The actual boot is performed in the background.
(d)	Shows boot progress in the background.

End of SEC2

Chapter 3 Operation Procedure

3.1. System Startup

3.1.1. System Startup Procedure

When all installation is completed, the system can be started by following the system startup procedure. The procedure to turn on the AC power with the AC switch is explained in this section. When a UPS is connected, turn on the AC power from the UPS. Refer to the UPS manual for the AC power-on procedure. The system startup flowchart is shown in the next page.



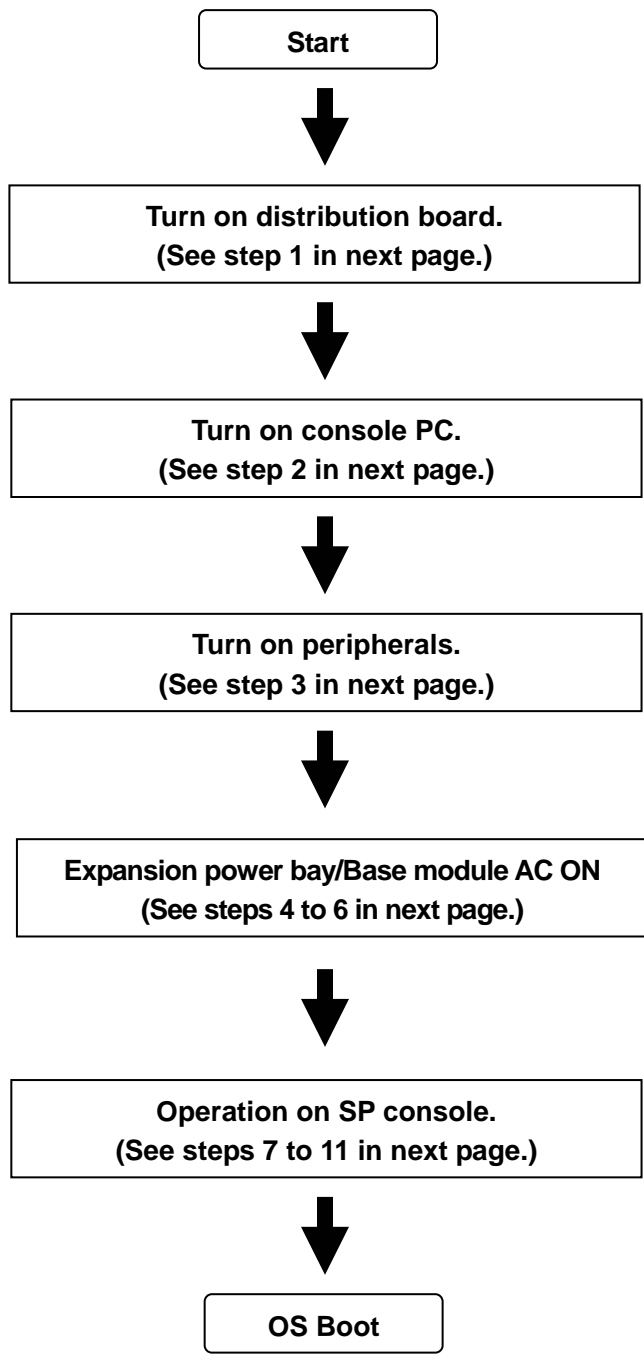

Startup Flowchart

Step	Operation
1	Turn on the power distribution board.
2	Turn on the console PC.
3	Turn on the peripheral units excluded from power control via the cabinet. Check that they are turned on normally.
4	Check that the AC switch at the top of the front panel of the main cabinet is OFF. If not, turn it off. Note) When a UPS is connected, use the AC switch of the USP for power control instead of the above switch panel.
5	When the expansion power bay is installed, turn on the AC switch at the back of the expansion power bay. Then, turn on the AC switch at the lower part of the rear of the base module.
6	Turn on the AC switch on the switch panel at the front top of the cabinet. Note) When a UPS is connected, use the AC switch of the USP for power control instead of the above switch panel.
7	On the SP console, enter: login name: spfw Password: nec iSP Main Menu is displayed. * The above login name and password are default settings. If you changed the password, enter that password.
8	Enter "s" on the SP console (for selecting S) iSP commands on iSP Main Menu.
9	Press the ESC key on the SP console (for entering the SP command console).
10	Check BIOS DIPSW settings and settings in each mode. Enter SP command "sg" on the SP console to check the settings for each OS. <u>See 3.4 AC-LINK (auto control) for what to be checked.</u> See 2.4.6.12 for the "sg" command.
11	Enter SP command "up" on the SP console (for turning on the DC power and initiating the system startup procedure). See 2.4.6.15 for the "up" command.

[Remark]

When the initial system startup is complete, be sure to backup CMOS/NVRAM. It is the responsibility of the user to backup CMOS/NVRAM. Use SP command "sr" for backup while the EFI Boot Manager is active. See 2.4.6.13 for the "sr" command.

[Note]

See 2.2.1 Cabinet for the location of the switch panel. See 2.2.6 Power Bay for the location of the AC switch on the base module and expansion power bay. The number of switches on the switch panel depends on the number of installed base modules and expansion power bays. Take care

Operation Procedure

of the association between these switches and base modules and expansion power bays during switch operation. The switches on the switch panel are used for immediate power shutdown for emergency purposes. When a switch on this panel is turned off, data may be destroyed.

3.1.2. SP Console Messages

SP console messages displayed during system startup are explained below.

- 1) Example of SP console screen during SPFW boot

```

Integrated Service Processor.
Cabinet-ID:xx, Location:iSPy, State:ssssss

iSP login: spfw                               <= Enter spfw and press Enter
iSP password: xxx                             <= Enter nec and press Enter

Copyright (C) 2006 NEC Corporation, All Rights Reserved.

Welcome to Integrated Service Processor.

    iSP FW version : 01.00 generated on 01/01/2006 19:20:33

iSP MAIN MENU
0) OS(BIOS) serial console of partition#0 (SW INITIALIZING)
1) OS(BIOS) serial console of partition#1 (NOT CONFIGURED )
2) OS(BIOS) serial console of partition#2 (NOT CONFIGURED )
3) OS(BIOS) serial console of partition#3 (NOT CONFIGURED )
4) OS(BIOS) serial console of partition#4 (NOT CONFIGURED )
5) OS(BIOS) serial console of partition#5 (NOT CONFIGURED )
6) OS(BIOS) serial console of partition#6 (NOT CONFIGURED )
7) OS(BIOS) serial console of partition#7 (NOT CONFIGURED )
V) Virtual System Operator Panel
S) iSP commands
E) Exit

DISCONNECTALL) disconnectall console connections

iSPyz> s                                       <= Enter s and press Enter
***** SP Command Mode                       *****
***** enter ESC to do the command input effectively *****
***** enter CTRL+B to quit                   *****
                                               <= Press ESC
iSPyz:---->                                  => To SP Command Console
    
```

2) Example of SP console screen during system startup

```
iSPyz:---> up                                     <= Enter up and press 
This command will bring up the specified partition.

Enter partition number (0-7/all/CR=exit) : all     <= Enter all and press 
Execute OK? (y/[n]) y                             <= Enter y and press 

UP command was accepted. All partitions will run soon.

[iSPyz:INFO.ccc] partition 0 : turning on POWBAY(s)...
[iSPyz:INFO.ccc] partition 0 : turning on XBX_C(s)...
[iSP0m:INFO.ccc] XBX00 SD completed normally.
[iSP0m:INFO.ccc] XBX01 SD completed normally.
      :
[iSPyz:INFO.ccc] partition 0 : turning on PCI_BAY(s)...
[iSP0m:INFO.ccc] IOX00 SD completed normally.
      :
[iSP0m:INFO.ccc] partition 0 : turning on CELL(s)...
[iSP0m:INFO.ccc] MMX00 SD completed normally.
      :

>> SP LOG MESSAGE START (07:6L) <<
11/28/2005 11:31:18 0----- System initialization completed. (SPFW:R00.35)
>> SP LOG MESSAGE END <<
[iSP0m:INFO.ccc] partition 0 : handed off the control to BIOS.
                    (DIPSW = 00000000)
```

Note: When multiple partitions are defined, a particular partition can be selected by entering its partition number instead of entering "all."

3.2. System Shutdown

3.2.1. System Shutdown Procedure

The procedure to turn off the AC power with the AC switch is explained in this section. When a UPS is connected, turn off the AC power from the UPS. Refer to the UPS manual for the AC power-off procedure. The system shutdown flowchart is shown in the next page.

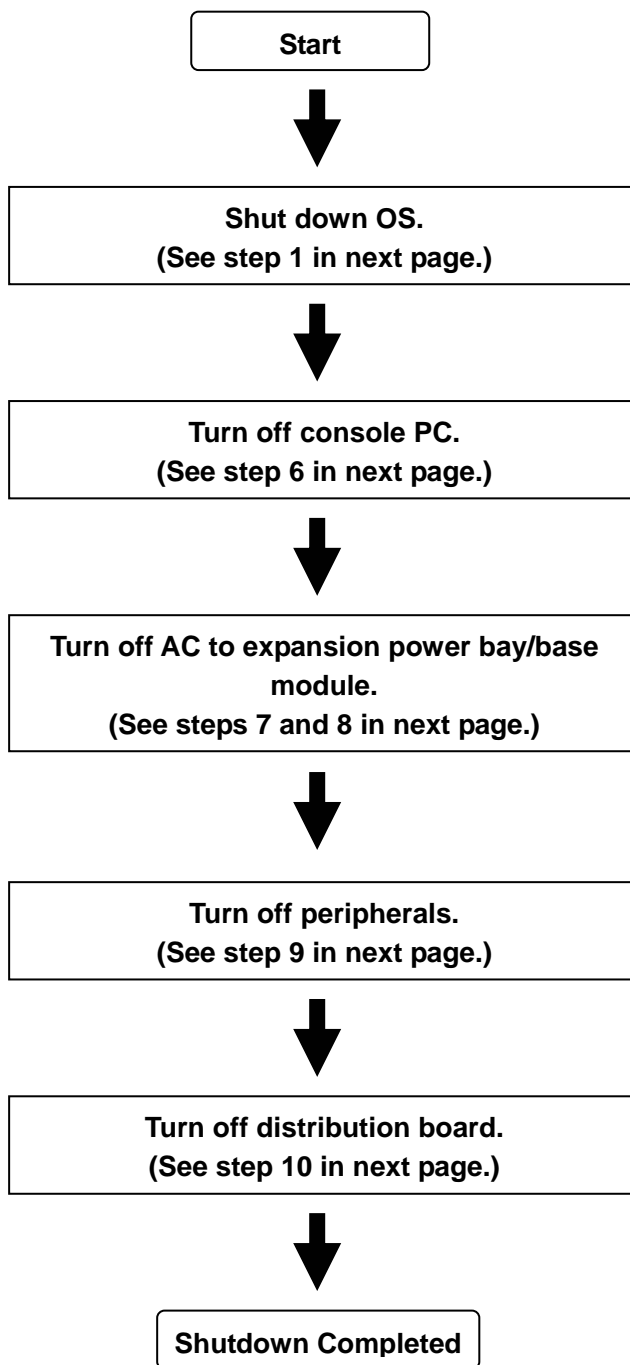

Shutdown Flowchart

Step	Operation
1	Enter "shutdown -h now" on the OS console.
2	Check that "Power down." is displayed. For details of the shutdown command, refer to the OS manual.
3	When multiple partitions have been selected, repeat steps 1 and 2 for all partitions.
4	Check that the following is displayed on the SP console: ***** * All DC power has been turned off. * * You can turn off AC power. * *****
5	Check that the base module fan stops turning.
6	Turn off the console management PC.
7	Turn off the AC switch on the switch panel at the front top of the cabinet. Note) When a UPS is connected, use the AC switch of the USP for power control instead of the above switch panel.
8	When the expansion power bay is used, turn off the AC switch at the rear of the expansion power bay. Then, turn off the AC switch at the lower part of the rear of the base module.
9	Turn off the peripheral units excluded from power control via the cabinet.
10	Turn off the distribution board.

[Note]

See 2.2.1 Cabinet for the location of the switch panel. See 2.2.6 Power Bay for the location of the AC switch on the base module and expansion power bay. The number of switches on the switch panel depends on the number of installed base modules and expansion power bays. Take care of the association between these switches and base modules and expansion power bays during switch operation. The switches on the switch panel are used for immediate power shutdown for emergency purposes. When a switch on this panel is turned off, data may be destroyed.

3.2.2. SP Console Messages

The SP console messages displayed during system shutdown are explained in this section.

1) Example of DC power off display on SP console screen

```
>> SP LOG MESSAGE START (07:6M) <<
11/28/2005 10:52:09 0----- System shutdown started. (SPFW:R00.35)
>> SP LOG MESSAGE END <<
[iSP0m:INFO.ccc] partition 0 : start-up processing was canceled due to shutdown
request.
[iSP0m:INFO.ccc] partition 0 : turning off CELL(s)...
[iSP0m:INFO.ccc] partition 0 : turning off PCIBAY(s)...
[iSP0m:INFO.ccc] partition 0 : turning off XBX_C(s)...
[iSP0m:INFO.ccc] partition 0 : turning off POWBAY(s)...

>> SP LOG MESSAGE START (07:6M) <<
11/28/2005 10:52:16 0----- System shutdown completed. (SPFW:R00.35)
>> SP LOG MESSAGE END <<
[iSP0m:INFO.ccc]
*****
* All DC power has been turned off. *
* You can turn off AC power. *
*****
=> DC is off now, and
AC can be turned off.
```

3.3. Emergency System Shutdown with AC SW

The switches on the switch panel are provided for forced power off in the event that an emergency power shutdown is required. Do not use these switches in normal operation.

See 2.2.1 Cabinet for the location of the switch panel. See 2.2.6 Power Bay for the location of the AC switch on the base module and expansion power bay. The number of switches on the switch panel depends on the number of installed base modules and expansion power bays. Take care of the association between these switches and base modules and expansion power bays during switch operation.

The power can be shut down by pressing the AC switch on the switch panel at the front top of the cabinet. See 2.2.1 Cabinet for the location of the AC switch. When a UPS is connected, the power switch of the UPS does the same as the AC switch on the switch panel.

Use the power switch of the UPS for emergency power shutdown. Refer to the UPS manual for the power-off procedure. With basic configuration, if a UPS is connected, do not operate the switch panel.

 CAUTION	Data may be destroyed when the AC switch is turned off during operation.
---	---

 CAUTION	Provide criteria for operating the AC switch and use the switch according to the criteria.
--	---

3.4. AC-LINK (Auto Control)

When connecting a UPS or a new AOC to the system, you need to decide whether it is controlled automatically or manually, and if you select automatic control, ask our maintenance personnel to enable automatic control.

SP command	AC link mode	Description
SG	On	AC LINK is enabled (it is disabled by default).

The SP console screen for confirming and executing AC LINK is shown below.

 CAUTION	<p>When an automatic control system such as the rack management system is installed, wait for more than two minutes after OS shutdown to perform AC power-off control.</p> <p>* If the AC power-off control starts within two minutes after OS shutdown, an error will occur during system shutdown, or the system will not start normally next time.</p>
--	---

1) SP console screen and operation during AC LINK setup

```

iSPyz:---> sg<ENTER>                                     <= Enter sg and press Enter

Display and modify settings of system and iSP.

  s) System settings
  i) iSP settings
  a) display all settings

Select ? (s/i/a/CR=exit) : s                               <= Enter s and press Enter
System setting menu:

  c) system common settings (maintenance only)
  p) partition settings (maintenance only)
  b) partition boot methods and Hot-plug permission
  a) display all settings

Select ? (c/p/b/a/CR=back) : b                             <= Enter b and press Enter

Partition boot methods and Hot-plug permissions:
  |      |Wake |Hot-Plug permission
part.|AC-  | On  | PCI-card  |      CELL
  |LINK | LAN | PCI(X)|PCE-EX| add |remv |swap
-----+-----+-----+-----+-----+-----+-----+-----
  0 | off | off | YES  | no  | no  | no  | no
  1 | off | off | YES  | no  | no  | no  | no

Modify? (y/[n]) : y                                       <= Enter y and press Enter

Enter partition number? (0-7/CR=back) : 0
AC link mode (o[n]/of[f]/CR=skip)      :
Wake on LAN (o[n]/of[f]/CR=skip)      :
Hot plug permission:
  PCI(X) card? (y[es]/n[o]/CR=skip) :
  PCI-Ex card? (y[es]/n[o]/CR=skip) :
(Omitted)
Enter partition number? (0-7/CR=back) :
  
```

3.5. OS Boot

 CAUTION	Use the OS console to operate the EFI Shell. Inputs from the VGA console (PS2 keyboard) may be rejected.
--	--

3.5.1. OS Boot with Boot Manager (Before Installing the OS)

The EFI Boot Manager is automatically activated as the BIOS boots. From the EFI Boot Manager, you can go to the EFI Shell prompt, start the EFI application, and displays the Boot Maintenance Menu or EFI System Configuration Menu.

An image of the Menu screen before the OS is installed is shown below. **For how to installing the OSs, refer to the installation guide attached to each OS.**

- Image of the EFI Boot Manager screen (Initial screen prior to OS installation)

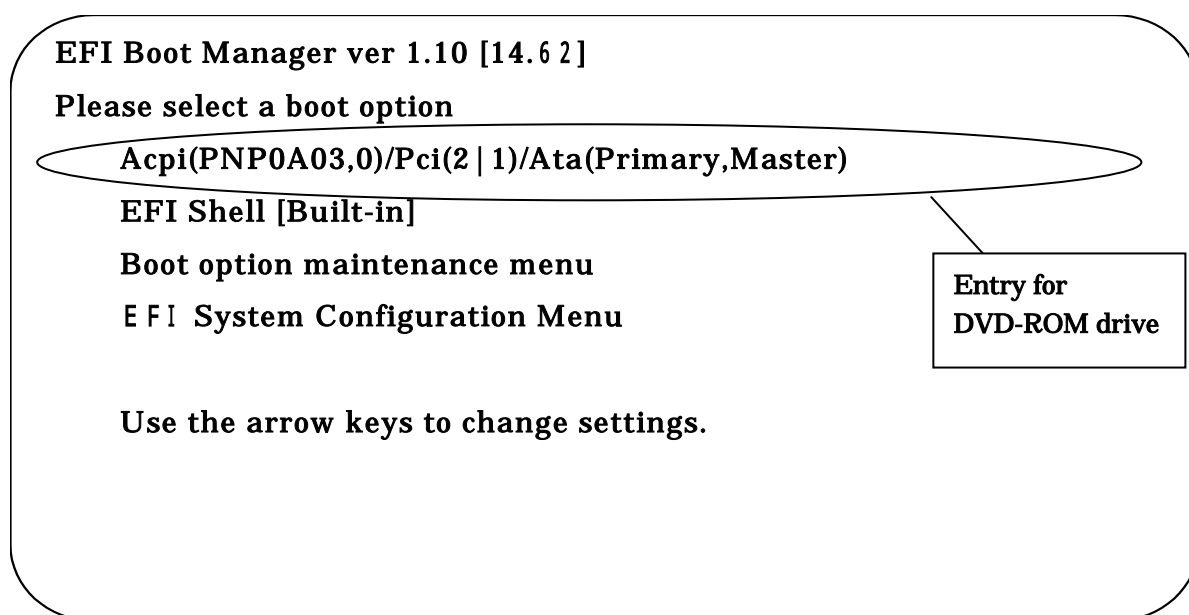

3.5.2. OS Boot from the EFI (Extensible Firmware Interface) Boot Manager

OS boot options are automatically entered in the EFI Boot Manager as the OS is installed. The OS can be booted by selecting an OS boot option in the EFI Boot Manager.

The following is an image of EFI Menu screen after SLES9 SP3 is installed:

- Image of the OS Boot screen displayed by the EFI Boot Manager

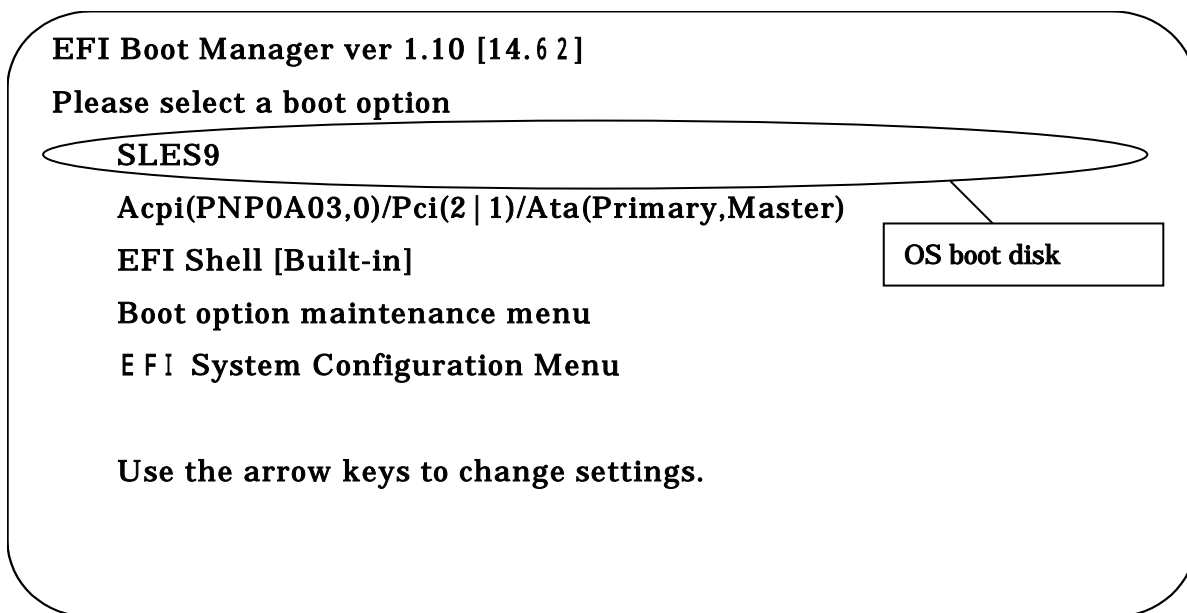

The OS can be booted by selecting the boot path with the cursor keys and pressing the Enter key in the EFI Boot Manager.

3.5.3. EFI Shell

The EFI Shell can be activated from the EFI Boot Manager. The EFI Shell provides Shell commands for viewing the file system of the boot device, copying the file and various other operations.

The following is an image of the EFI screen.

■ Image of the EFI screen

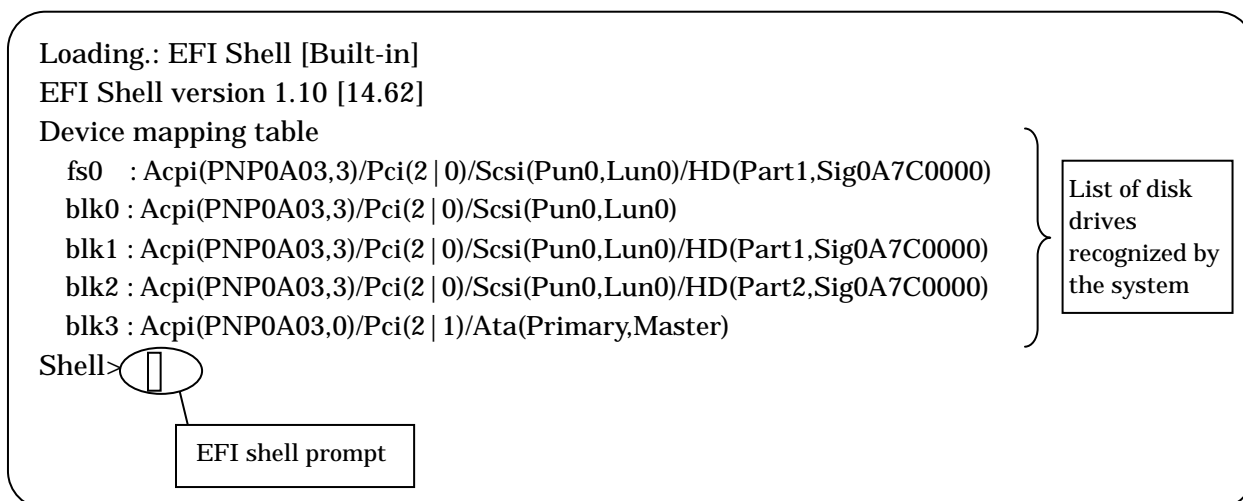

3.5.4. EFI Shell Commands

The shell commands that can be executed at the EFI Shell and their usage are explained in this section. The EFI shell command is executed by entering the command and pressing the Enter key.

EFI Shell Commands

Command		Description
alias	alias [-d -v -b] [sname] [value]	Display/create/delete an alias definition in the EFI Shell environment.
attrib	attrib [+a -a] [+s -s] [+h -h] [+r -r] [-b] [file ...] [directory ...]	Display/change the file/directory attribute.
bcfg	bcfg driver boot [dump -v] [add # file "desc"] [rm #] [mv # #]	Display/change the driver/boot configuration.
break	Break	Run the debugger until the breakpoint is reached.

Command		Description
cd	cd [path]	Display/change the current directory.
child	child Handle	Display the device tree under the handle.
cls	cls [color]	Clear standard outputs.
comp	comp file1 file2	Compare two files.
connect	Connect [-r] Handle# DeviceHandle# DriverHandle#	Bind a driver to a device and start the driver.
cp	cp [-r] src [src ...] [dst]	Copy a file/directory.
date	date [mm/dd[yy]yy]	Display/set the date.
dblk	dblk device [Lba] [blocks]	Dump a block device.
dh	dh [-p prot_id] [-b] [handle]	Display the handle in the EFI environment.
disconnect	disconnect DeviceHandle# [DriverHandle# [ChildHandle#]] [-r]	Disconnect the driver from the device.
dmem	dmem [Address] [Size] [;MMIO]	Dump memory.
dmpstore	dmpstore	Display NVRAM variables.
echo	echo [-on -off] echo [message]	Display message, or switch echo on/off.
edit	edit [file]	Edit the ASCII/UNICODE file.
EfiCompress	EfiCompress [InFile] [OutFile]	Compress a file.
EfiDecompress	EfiDecompress [InFile] [OutFile]	Decompress a file.
err	err [ErrorLevel]	Display/change the error level.
exit	exit	Exit the EFI Shell.
getmtc	getmtc	Display the current counter value.
guid	guid [-b]	Display GUID in the EFI environment.
help	help [-b] [cmd]	Display help.
hexedit	hexedit [[-f] FileName [-d DiskName Offset Size] [-m Offset Size]	Edit file in hex mode.
load	load file [file ...]	Load the EFI driver.
LoadPciRom	LoadPciRom [FileName]	Load PCI option ROM image from file.

Command		Description
ls	ls [-b] [-r] [-a [attrib]] [file]	Display directories/file lists.
map	map [-r -v -d] [sname] [handle] [-b]	Display/define mapping information.
memmap	memmap [-b]	Display memory map.
mkdir	mkdir dir [dir ...]	Create a directory.
mm	mm Address [Width 1 2 4 8] [;MMIO ; MEM ; IO ;PCI] [:Value] [-n]	Display/change MEM/IO/PCI.
mode	mode [row col]	Display/change the console output device mode.
mount	mount BlkDevice [sname]	Mount the file system on the block device.
mv	mv src [src ...] [dst]	Move a file/directory.
OpenInfo	OpenInfo Handle	Display the handle/agent protocol.
pause	pause	Pause for an entry with a message displayed.
pci	pci [Bus Dev [Func] [-i] [-s [Seg]]]	Display the PCI device configuration space.
reset	reset [-w [string]]	Reset the system.
rm	rm [-q] file [file ...] rm [-q] directory [directory ...]	Delete file/directory.
set	set [-d -v -b] [sname [value]]	Display/create/change/delete the EFI environmental variable.
setsize	setsize newsize file	Set the file size.
stall	stall microseconds	Stall the processor in microseconds.
time	time [hh:mm[:ss]]	Display the current time, or set time.
touch	touch [-r] filename	Set the current time and date in the time and date attribute of a file.
type	type [-a -u] [-b] file [file ...]	Display contents of a file.
unload	unload [-n] [-v] HandleIndex	Unload the protocol image.
ver	ver	Displays version information.

3.5.5. OS Boot from EFI Shell

In addition to OS boot from the EFI Boot Manager, the OS can be booted by entering a command at the EFI Shell. An example of booting the OS from the EFI Shell is shown below.

Example: OS boot from the SCSI disk with the following hardware connection:

- IDE DVD-ROM (Master)
- SCSI HDD (OS boot disk)

(1) Specifying the file system

Change the current file system to the file system connected to the boot device. "fs0" is the boot device in the screen image shown below.

■ Image of the EFI Shell screen

The screenshot shows the EFI Shell interface. At the top, it displays the command `Shell> map` and the title `Device mapping table`. Below this, a list of devices is shown: `fs0 : Acpi(PNP0A03,3)/Pci(2 | 0)/Scsi(Pun0,Lun0)/HD(Part1,Sig0A7C0000)`, `fs1 : Acpi(PNP0A03,0)/Pci(2 | 1)/Ata(Primary,Master)/CDROM(Entry1)`, `blk0 : Acpi(PNP0A03,3)/Pci(2 | 0)/Scsi(Pun0,Lun0)`, `blk1 : Acpi(PNP0A03,3)/Pci(2 | 0)/Scsi(Pun0,Lun0)/HD(Part1,Sig0A7C0000)`, `blk2 : Acpi(PNP0A03,3)/Pci(2 | 0)/Scsi(Pun0,Lun0)/HD(Part2,Sig0A7C0000)`, `blk3 : Acpi(PNP0A03,0)/Pci(2 | 1)/Ata(Primary,Master)`, and `blk4 : Acpi(PNP0A03,0)/Pci(2 | 1)/Ata(Primary,Master)/CDROM(Entry1)`. The `fs0` entry is circled in red, and a callout box labeled "Boot device" points to it. Below the list, the command `Shell> fs0:` is shown, with `fs0:` circled in red and a callout box labeled "Enter 'fs0:'" pointing to it.

```
Shell> map
Device mapping table
fs0 : Acpi(PNP0A03,3)/Pci(2 | 0)/Scsi(Pun0,Lun0)/HD(Part1,Sig0A7C0000)
fs1 : Acpi(PNP0A03,0)/Pci(2 | 1)/Ata(Primary,Master)/CDROM(Entry1)
blk0 : Acpi(PNP0A03,3)/Pci(2 | 0)/Scsi(Pun0,Lun0)
blk1 : Acpi(PNP0A03,3)/Pci(2 | 0)/Scsi(Pun0,Lun0)/HD(Part1,Sig0A7C0000)
blk2 : Acpi(PNP0A03,3)/Pci(2 | 0)/Scsi(Pun0,Lun0)/HD(Part2,Sig0A7C0000)
blk3 : Acpi(PNP0A03,0)/Pci(2 | 1)/Ata(Primary,Master)
blk4 : Acpi(PNP0A03,0)/Pci(2 | 1)/Ata(Primary,Master)/CDROM(Entry1)
Shell> fs0:
```

(2) Booting the OS loader

Boot OS loader SuSE Linux (elilo).

■ Image of OS loader boot screen

```
fs0:¥> cd os
fs0:¥os> ls
Directory of fs0:¥
  11/10/05  09:14a <DIR>          512  EFI
                0 File           0 bytes
                1 Dirs

fs0:¥> cd efi
fs0:¥efi¥> cd suse
fs0:¥efi¥Suse> elilo
```

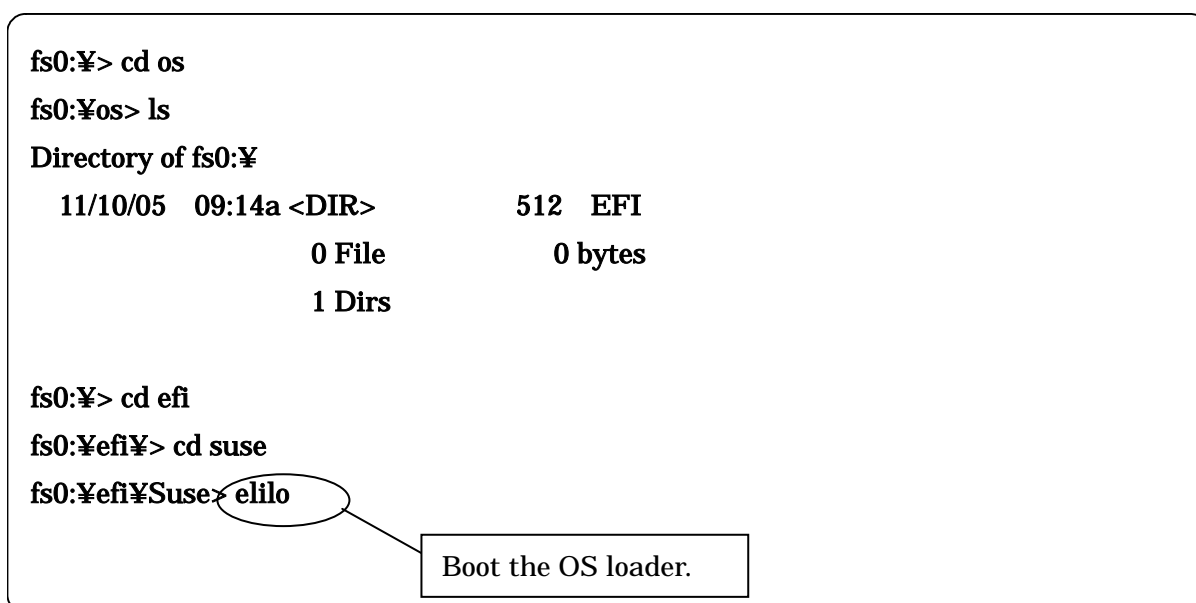

Boot the OS loader.

- * Confirm the storage location of the OS loader and the boot file name by referring to the disk from which the OS has been installed.

3.5.6. EFI Devices

The device connected to the system is managed as “EFI device path.” This section explains the EFI device path.

1) DVD-ROM device

When the DVD-ROM drive is connected to the IDE secondary channel:
Acpi(PNPA03,0)/Pci(2|1)/Ata(Secondary,Master)

2) SCSI device

Acpi(PNP0A03,1)/Pci(2|0)/xxx/xxx/Scsi(Pun0,Lun0)/HD(Part1,SigFF050000)

Description:

SCSI(Puny,Lunz): Mounting location of the SCSI device (DISK) connected to the SCSI card.

y: Physical location of the SCSI device

z: Identifier for a logical unit when an SCSI device has multiple accessible logical units (“0”: Origin)

HD(Part1,SigFF050000): SCSI DISK drive information

Part1: Information on partition 1

SigFF050000: The signature is “FF050000.”

Device path (former part of SCSIxxx):

Example: To install the boot device in the PCI bay (core module):

Host Bus	Slot
----------	------

Acpi(PNP0A03,?)/Pci(?!?)

^UID

^^Slot Dev#/Func#

Location in PCI bay	Device path description on the EFI Menu
C_PCI01	Acpi(PNP0A03,x)/Pci(3 z)
C_PCI02	Acpi(PNP0A03,x)/Pci(2 z)

x = UID: PCI module number identifier

Computing UID:

$$\text{UID } x = \text{LIOC} * 16$$

LIOX=Logical IOX Number :Logical IOX number:

LIOX=0-7

LIOC=Logical IOC Number :Logical IOC number:

LIOC for IOC0=LIOX*2+0

LIOC for IOC1=LIOX*2+1

LIOC=0-15

LIOX	LIOC	UID
0	0	0
	1	16
1	2	32
	3	48
2	4	:
	5	:
3	6	:
	7	:
4	8	:
	9	:
5	10	:
	11	:
6	12	:
	13	:
7	14	:
	15	:

Z: Function number:

Operation Procedure

Example: To install the boot device on the PCI bay (PCI module):

Host Bus PEX PXH Slot

Acpi(PNP0A03,?)/Pci(?|?)/Pci(?|0)/Pci(?|?)

 ^UID

 ^^Slot Dev#/Func#

Location in PCI bay	Device path description on the EFI Menu
PCI01	Acpi(PNP0A03,x)/Pci(2 0)/Pci(0 0)/Pci(2 z)
PCI02	Acpi(PNP0A03,x)/Pci(2 0)/Pci(0 2)/Pci(2 z)
PCI03	Acpi(PNP0A03,x)/Pci(4 0)/Pci(0 0)/Pci(2 z)
PCI04	Acpi(PNP0A03,x)/Pci(4 0)/Pci(0 2)/Pci(2 z)
PCI05	Acpi(PNP0A03,y)/Pci(2 0)/Pci(0 0)/Pci(2 z)
PCI06	Acpi(PNP0A03,y)/Pci(2 0)/Pci(0 2)/Pci(2 z)
PCI07	Acpi(PNP0A03,y)/Pci(4 0)/Pci(0 0)/Pci(2 z)
PCI08	Acpi(PNP0A03,y)/Pci(4 0)/Pci(0 2)/Pci(2 z)

x,y = UID : PCI module number identifier

Computing UID: Same as the PCI bay (core module).

3.5.7. EFI Boot Option Maintenance

A boot option can be selected on the Boot Option Maintenance Menu which is activated from the EFI Boot Manager screen by selecting [Boot option maintenance menu] after the power-on procedure.

■ Image of the EFI Boot Manager screen

```
EFI Boot Manager ver 1.10 [14.62]
Please select a boot option
  SLES9
  Acpi(PNP0A03,0)/Pci(2 | 1)/Ata(Secondary,Master)
  EFI Shell [Built-in]
  Boot option maintenance menu
  EFI System Configuration Menu

Use the arrow keys to change settings.
```

See the description of each boot option on the Boot Option Maintenance Menu. “Boot Maintenance Menu Options” below lists the options that are explained in the subsequent pages. When you change the settings from the EFI Boot Maintenance Menu, save the new settings with SP command “sr.” For the “sr” command, see 2.4.6.13.

■ Image of the EFI Boot Option Maintenance screen

```
EFI Boot Maintenance Manager ver 1.10 [14.62]

Main Menu. Select an Operation
  Boot from a File
  Add a Boot Option
  Delete Boot Option(s)
  Change Boot Order

  Manage BootNext setting
  Set Auto Boot TimeOut

  Cold Reset
  Exit
```

Boot Maintenance Menu Options

Option	Description
Boot from a File	Boot the OS directly from the EFI application.
Add a Boot Option	Add a boot option to the EFI Boot Manager menu.
Delete Boot Option(s)	Delete a boot option or all options.
Change Boot Order	Change the order of boot options according to the HELP screen by pressing the HELP key.
Manage Boot Next Setting	Select a boot option for the next boot only.
Set Auto Boot Timeout Value	Set a timeout value until the next auto boot (in seconds). When "0" is specified, the timeout option is disabled. If nothing is entered, the default "10" seconds is set.
Cold Reset	Hard reset the system.
Exit	Return to the EFI BOOT Manager menu.

3.5.7.1. Boot from a File

A boot file can be selected from a list of device files by selecting [Boot from a File] on the Main Menu.

■ Image of the Boot from a File screen

EFI Boot Maintenance Manager ver 1.10 [14.62]

Boot From a File. Select a Volume

IA64_EFI [Acpi(PNP0A03,3)/Pci(2 | 0)/Scsi(Pun0,Lun0)/HD(Part1,Sig0
NO VOLUME LABEL [Acpi(PNP0A03,0)/Pci(2 | 1)/Ata(Primary,Master)]
Removable Media Boot [Acpi(PNP0A03,0)/Pci(2 | 1)/Ata(Primary,Maste
Removable Media Boot [Acpi(PNP0A03,0)/Pci(2 | 1)/Ata(Secondary,Mas
Load File [EFI Shell [Built-in]]
Exit

3.5.7.2. Add a Boot Option

To add a new boot option to the EFI Shell, select [Add a Boot Option] on the Main Menu, and follow the steps below.

1. Select a device containing the boot file.
2. Select a file in the device.

■ Image of the Add a Boot Option screen

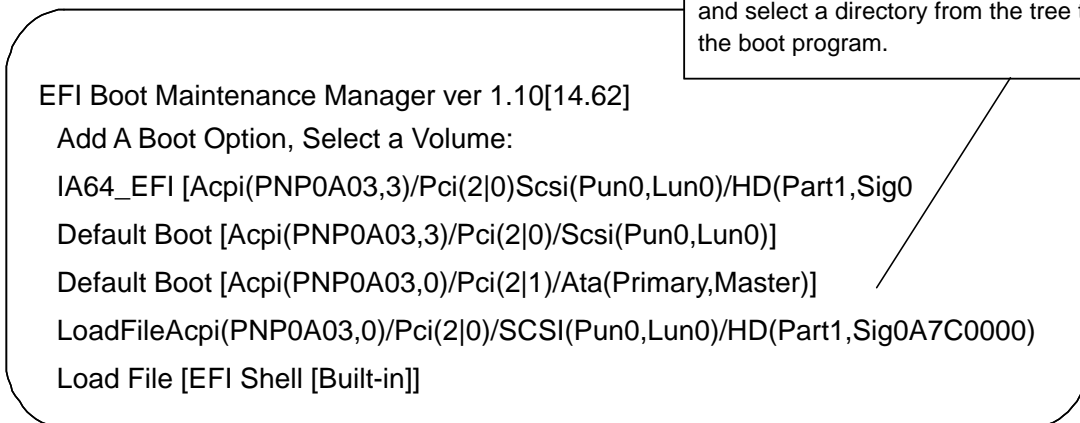

3. Enter a file name (prerequisite: a ASCII or Unicode file name within 240 characters).
4. Select A, U or N, and press the <Enter> key.
5. Confirm that the new boot option was added, and save the change.
6. The new description is entered in the EFI Boot Menu screen.

■ Image of the Add a Boot Option screen

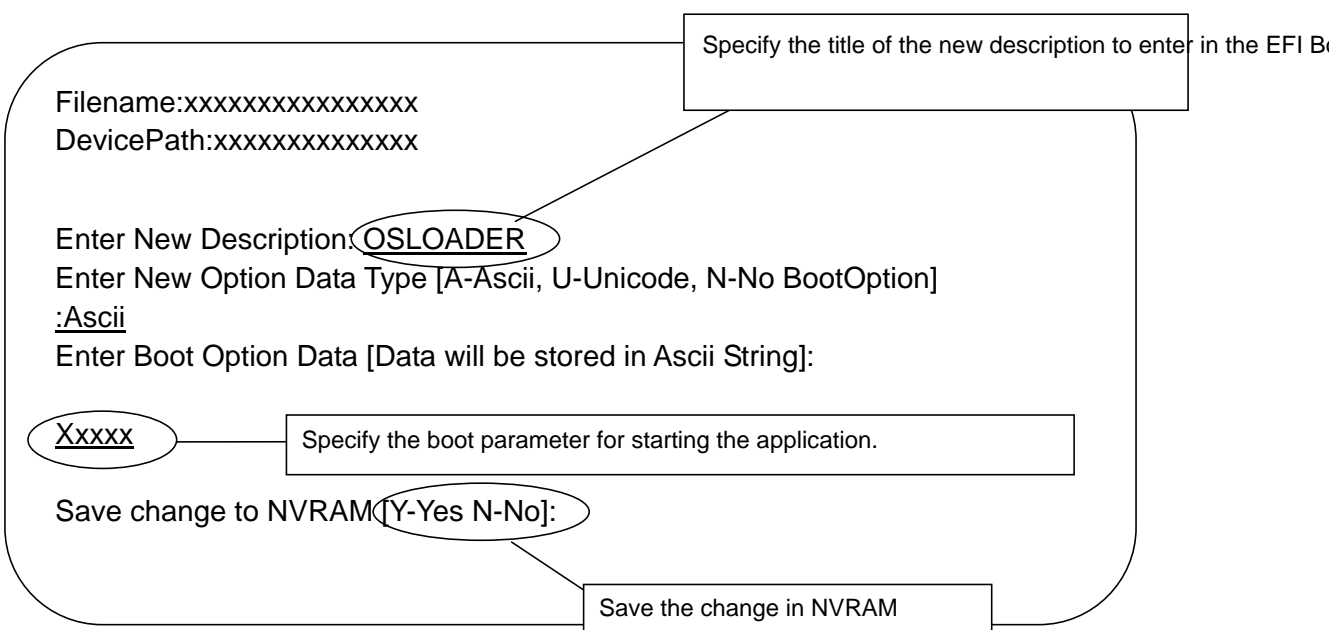

3.5.7.3. Add Boot Option(s)

To delete a boot option or all options, select [Delete Boot Option(s)] from the Main Menu. Highlight a boot option to delete by placing the cursor on the boot option, and press the <Enter> key. The selected boot option can also be deleted by pressing the <d> or <D> key. When the boot option is selected, confirmation message [Delete selected Boot option [Y-Yes N-No] :] appears. Enter <Y> to delete, or <N> to cancel operation. To delete all boot options, select [Delete All Boot Options] from the menu. After deletion, select [Save Settings to NVRAM] on the menu screen, save the change, and exit this menu.

3.5.7.4. Change Boot Order

To change the order of boot options, select [Change Boot Order] from the Main Menu. On the Change Boot Order screen, highlight a boot option to move by placing the cursor on the boot option. The selected boot option moves up by one line each time you hit the <U> or <u> key, and moves down by one line each time you press the <d> or <D> key. Select [Save Settings to NVRAM] on the menu screen to save the change, and exit this menu. The OS is automatically booted after ten seconds with the boot option listed at the top on the EFI Boot Manager screen by default.

■ Image of the Change Boot Order screen

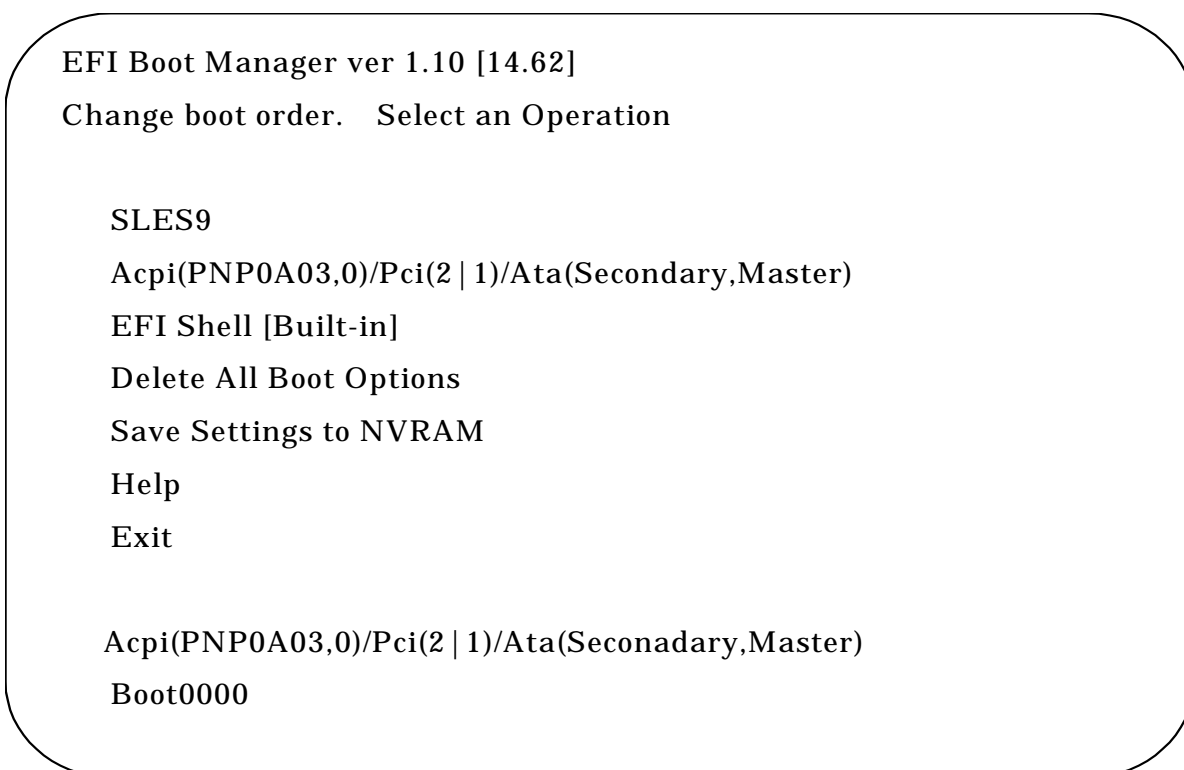

3.5.7.5. Manage BootNext Setting

To set the most favored boot option for the next boot or reset the BootNext option, select [Manage BootNext Setting] from the Main Menu. On the Manage BootNext Setting screen, highlight a boot option by placing the cursor on the boot option, and press the or key to make this option as "BootNext." To remove the BootNext setting, select [Reset BootNext Setting], and press the <R> or <r> key. Select [Save Settings to NVRAM] on the menu screen, save the change, and exit this menu.

■ Image of the Manage BootNext Setting screen

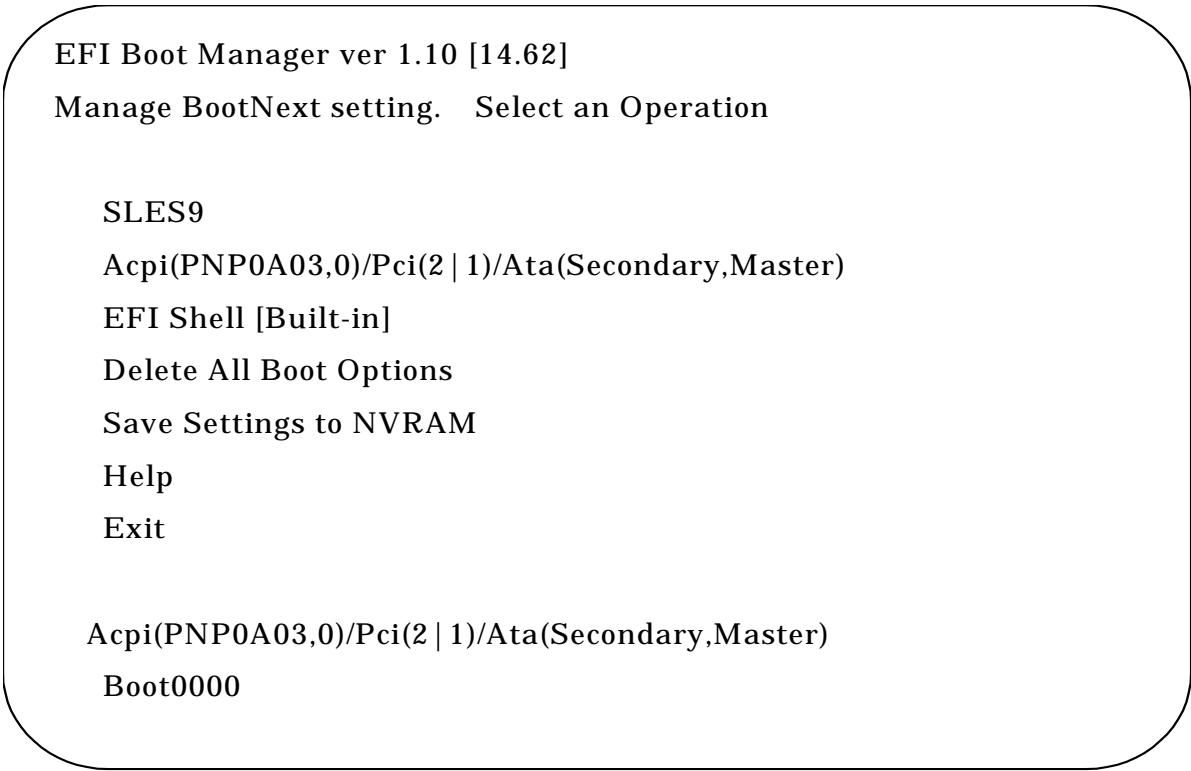

EFI Boot Manager ver 1.10 [14.62]
Manage BootNext setting. Select an Operation

SLES9
Acpi(PNP0A03,0)/Pci(2 | 1)/Ata(Secondary,Master)
EFI Shell [Built-in]
Delete All Boot Options
Save Settings to NVRAM
Help
Exit

Acpi(PNP0A03,0)/Pci(2 | 1)/Ata(Secondary,Master)
Boot0000

3.5.7.6. Set Auto Boot Timeout

To change the timeout value until the next auto boot (TimeValue) from the default setting (10 seconds), select [Set Auto Boot Timeout] from the Main Menu. Specify the timeout value (in seconds) in the Set Timeout Value option. If the value 0 (zero) is specified, the OS is booted immediately. There are three ways to disable auto boot:

- Using the Delete/Disable Timeout menu.
- Setting the timeout value to 65535<0xFFFF>.
- Pressing a key when EFI is booting to disable the timeout count down. The timeout value selected on the Set Timeout Value menu has been saved.

■ Image of the Set Auto Boot Timeout screen

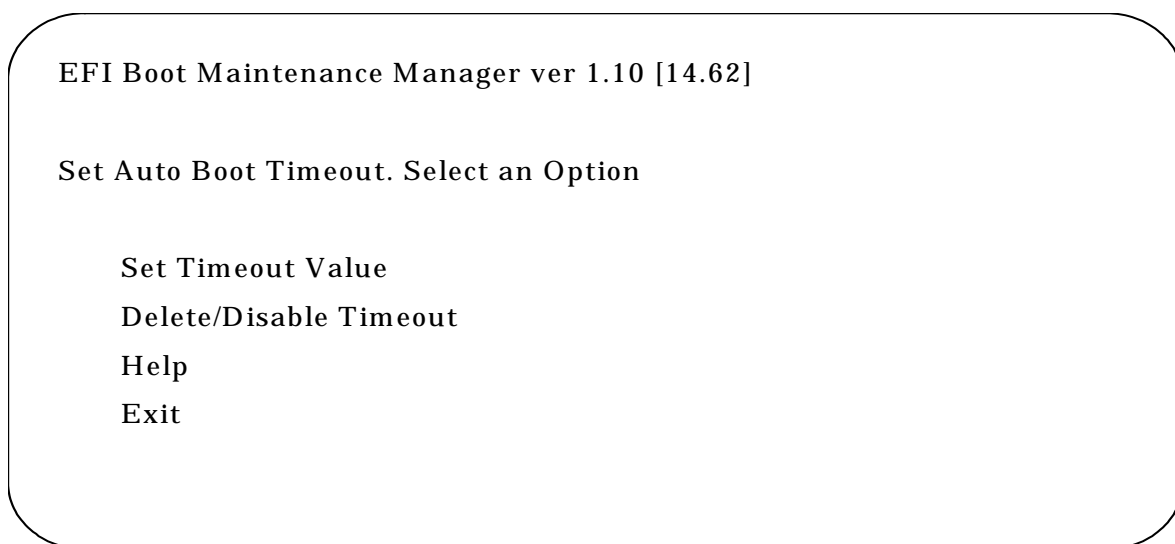

3.5.7.7. Setting the Network Boot

To enable PXE Boot, change the EFI Boot Manager using the EFI Boot Option Maintenance menu. This section explains how to change the EFI Boot Manager with an example of changing the network installation menu for HP-UX.

Before change: Example) Immediately after HP-UX is installed.

EFI Boot Manager ver 1.10 [14.62]

Please select a boot option

HP-UX Primary Boot: 8/0/7/2/0.8.0.255.1.0.7

Acpi(PNP0A03,0)/Pci(2 | 1)/Ata(Secondary,Master)

EFI Shell [Built-in]

Boot option maintenance menu

EFI System Configuration Menu

Use the arrow keys to change settings.

Before change

After change: After the menu is changed.

EFI Boot Manager ver 1.10 [14.62]

Please select a boot option

HP-UX Primary Boot: 8/0/7/2/0.8.0.255.1.0.7

Acpi(PNP0A03,0)/Pci(2 | 1)/Ata(Secondary,Master)

Acpi(PNP0A03,0)/Pci(3 | 0)/Mac(00004C717743)

EFI Shell [Built-in]

Boot option maintenance menu

EFI System Configuration Menu

Use the arrow keys to change settings.

After change

Changing procedure:

- 1) Activate the EFI Boot Manager.
- 2) Select Boot Option Maintenance Menu.
- 3) Select Add Boot Option.
 - a) When Add Boot Option is chosen, the device paths containing the boot file are listed. The entry "Mac(xxxx)" corresponds to the LAN card for PXE Boot. Select the entry of a card used for PXE BOOT according to the MAC address.

Example) To use a card having MAC address: 00004C717743 for PXE BOOT:

Select the entry Acpi(PNP0A03,0)/Pci(3|0)/Mac(00004C717743).

Note 1: When multiple LAN cards are provided for multiple PXE network cards of PXE having multiple ports, the corresponding number of entries are displayed with each having a unique MAC address. Select the LAN cards according to their MAC addresses.

Note 2: It is recommended to write down the LAN cards MAC addresses for this work.

- b) Save the selected entry as a new boot option of the EFI Boot Manager.
 - Any character string can be used for the New Description, but a name easy to identify the LAN card and the system is preferable.
 - Boot Option Data is not required.
- c) Enter "Y" for Save Change to NVRAM[Y/N].
- 4) Return to the EFI Boot Manager and select Boot Option Maintenance Menu again.
- 5) Change the order of boot options on the Change Boot Order screen.



Select Save Settings to NVRAM, and save the change.

3.5.7.8. Changing BIOS Settings

The BIOS settings may need to be changed using the EFI System Configuration Menu.

After changing the BIOS settings, save the change using SP command “sr.” For the “sr” command, see 2.4.6.13.

(1) System interrupt

Check the BIOS settings for the hardware components shown below before installing Windows 2003 Server. Part of the BIOS settings is required for operating Windows 2003 Server. Be sure to set the proper system interrupt for the OS to install.

Confirmation and setting:

Select EFI System Configuration Menu from the EFI Boot Manager.

↓

Select Boot Configuration.

↓

The screen below appears.

View Shrink total number of interrupt vector up to 256.

When the set value does not correspond to the OS, change it to a correct value.

↓

Select Exit, save the change, and reboot the OS to validate the change.

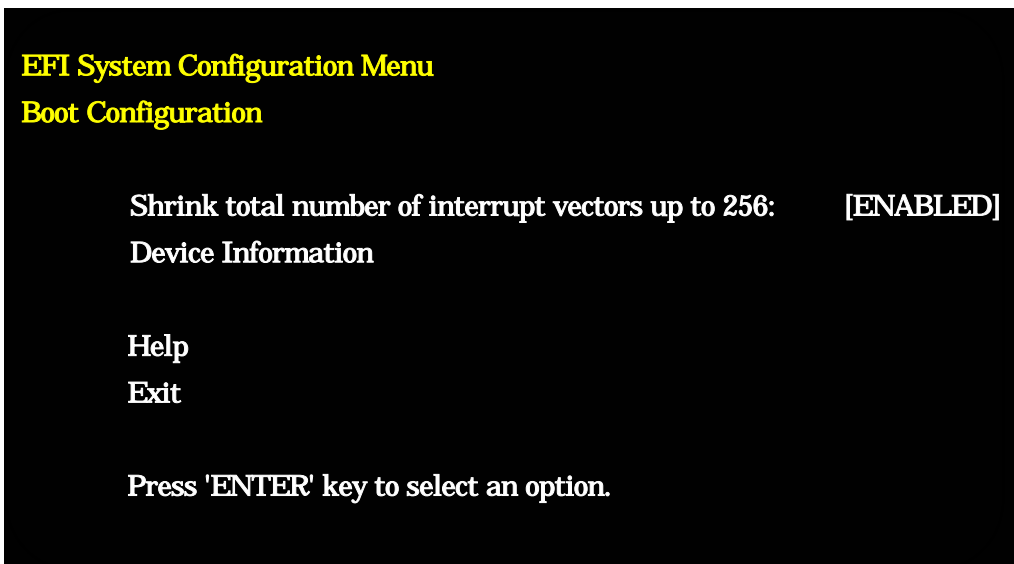

OS	Setting (Note)
Windows Server 2003 Datacenter Edition	DISABLED
Windows Server 2003 Enterprise Edition	ENABLED

Note: DISABLED is set at the factory by default.

(2) Hyper-Threading mode

For the OS supporting the Hyper-Threading mode, you can enable or disable the Hyper-Threading mode.

Refer to the relevant OS manual to know if the OS supports the Hyper-Threading mode.

DISABLED is set at the factory by default.

Confirmation and setting:

Select EFI System Configuration Menu from the EFI Boot Manager.

↓

Select Processor Configuration.

↓

The screen below appears.

View Hyper Threading Technology.

When the set value does not correspond to the OS, change it to a correct value.

↓

Select Exit, save the change, and reboot the OS to validate the change.

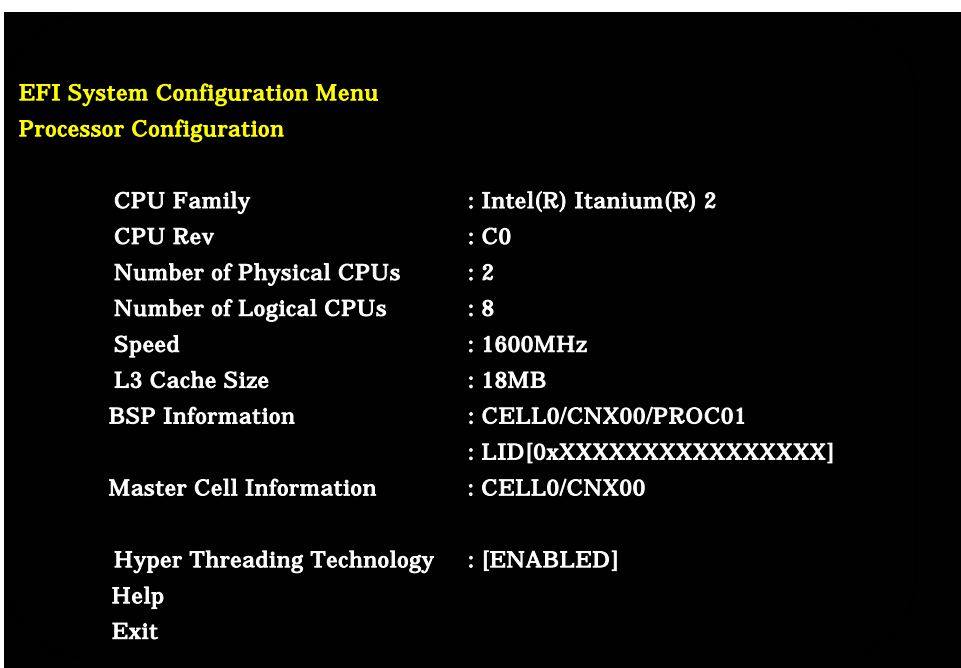

3.6. System Dump

The system dump can be produced by following the procedure explained below if the OS is corrupt (e.g., OS stall), or OS information needs to be collected. Note that this operation requires the OS to be active. System dump cannot be produced if the trouble involves hardware failure (e.g., HDD containing the OS crashed).

- * To produce system dump, OS settings/disk configuration that allow system dump are required. Some OS does not support system dump. For system dump settings, refer to the installation/setup manual of each OS.

System dump procedure

- (1) Open the SP console, and check that the SP console prompt is present.
- (2) Enter SP command “dp,” specify the partition number to produce dump, and enter “yes” (for the “dp” command, see 2.4.6.3).
- (3) After logs of the processors in the selected partition are collected, the OS starts the dump operation.
- (4) After finishing the dump operation, the OS reboots. Log in the OS again and check the dump file.

- * For the location of the system dump file (directory), refer to the installation/setup manual of the OS.

Chapter 4 Troubleshooting

This chapter shows general actions to errors in the base module and peripheral units. If a particular error persists to occur despite the actions you have taken, record the error state and contact the maintenance personnel of NEC. See Section 1.1 for the mounting image of the base module components, and Section 2.2 for the external view of the cabinet.

4.1. Troubleshooting

- (1) Power is not supplied when the AC switch on the switch panel at the front top of the cabinet is turned on.
 - Check that the distribution board is turned on.
 - Check that AC power is connected to the base module.
 - Check that the AC switches for POWBAY#0 and POWBAY#1 are on.
 - Check that power cables are connected to POWER BAY#0 and POWER BAY#1.
 - Check that the DPSs are mounted on POWER BAY#0 and POWER BAY#1, and operate normally.
 - Note that the switch panel is not used in principle when the UPS is connected.
- (2) Nothing is displayed on the SP console.
 - Check that the SP console is turned on.
 - Check that the iSP card and the SP console in the cabinet are connected properly.
 - Is the right cable used?
 - Are the connectors firmly inserted?
 - Is the IP address set correctly?
 - Check that the software does not disable screen display by moving the cursor and pressing the SHIFT key on the screen.
 - Check that the console brightness is set to the proper level.
- (3) Nothing is displayed on the VGA console (when the VGA is mounted).
 - Check that the VGA console is turned on.
 - Check that the VGA card on the I/O module and the VGA console are connected properly.
 - Is the right cable used?
 - Are the connectors firmly inserted?
 - Check that the software does not disable screen display by moving the cursor and

pressing the SHIFT key on the screen.

- Check that the VGA console brightness is set to the proper level.

(4) Console commands cannot be entered.

- Check that the keyboard and mouse are connected properly.
- Check that the keyboard and mouse are connected to the I/O module properly.
 - Are the right cables used?
 - Are the connectors firmly inserted?

(5) The OS does not boot.

- Check that the Power LED of each package turns on.
- Check that the SP console does not display errors.
- When the OS is booted from the DVD-ROM unit on the I/O module, check that DVD-ROM/CD-ROM unit is connected properly.
- When the OS is booted from the DAT unit on the I/O module, check that the digital audio tape is loaded correctly.
- When the OS is booted from the HDD on the I/O module (core module), check that the HDD is connected properly.

(6) The DVD-ROM/CD-ROM medium cannot be read.

- Check that the orange LED on the DVD-ROM unit lights.
- Check that the medium is loaded on the DVD-ROM unit properly.
- Check that data is saved on the medium properly.
 - Use more than one medium for confirmation.
- Check that the DVD-ROM unit operates normally.

(7) The digital audio tape cannot be read.

- Check that the green LED on the DAT unit lights.
- Check that data is saved on the digital audio tape properly.
 - Use more than one tape for confirmation.
- Check that the DAT unit operates normally.

(8) The system does not recognize the SCSI or HDD.

- Check the settings in BIOS Setup.

Chapter 5 Notes on Handling

5.1. Transportation

When the product is transported, pack it with the packing materials used at the time of delivery. Be sure to turn off the power before moving or packing the product.

5.2. DVD-ROM/CD-ROM

- (1) Do not touch the recording surface (the surface with nothing printed).
- (2) Press the center of the case to take the medium out.
- (3) Put the medium carefully on the tray with the printed surface facing up.
- (4) Do not put anything on the DVD-ROM/CD-ROM or bend it.
- (5) Do not attach labels on the medium.
- (6) Do not scratch the surface or write letters.
- (7) Be careful not to drop the medium. Strong impacts will damage the medium.
- (8) Wipe finger marks and dust on the surface with soft cloth from the inner to the outer portion.
- (9) Use a DVD/CD cleaner for cleaning DVD/CD.
Do not use spray or liquid cleaners for vinyl records, benzines, thinners and other chemical agents.
- (10) Do not operate or store the medium at dusty places.
- (11) Do not put the medium at places exposed to direct sunlight or excessive heat (e.g., near a heater).
- (12) Put the medium in the case when it is not used.
- (13) Keep the CD-ROM attached to the product in a safe place.
If you lost the CD-ROM, contact the maintenance or sales personnel of NEC.

5.3. Digital Audio Tape

- (1) Do not use damaged or deformed digital audio tape.
- (2) Do not touch the tape or turn the roller.
- (3) Protect the tape from exposure to sources of magnetism. Otherwise, data may be destroyed.
- (4) Do not put the tape at places exposed to direct sunlight or excessive heat (e.g., near a heater).
- (5) Do not give strong impacts or shocks to the tape.
- (6) Put the tape in the case when it is not used.

5.4. Cleaning

- Wipe the surface of the main and peripheral units with soft cloth.
- Take out the power plug of the main and peripheral units from outlets prior to cleaning.
- Do not use detergents containing polishing materials, cleaning solvents, thinners and other chemical agents.
- Remove the top cover and clean the parts like air filters using a vacuum cleaner during inspection or parts replacement.

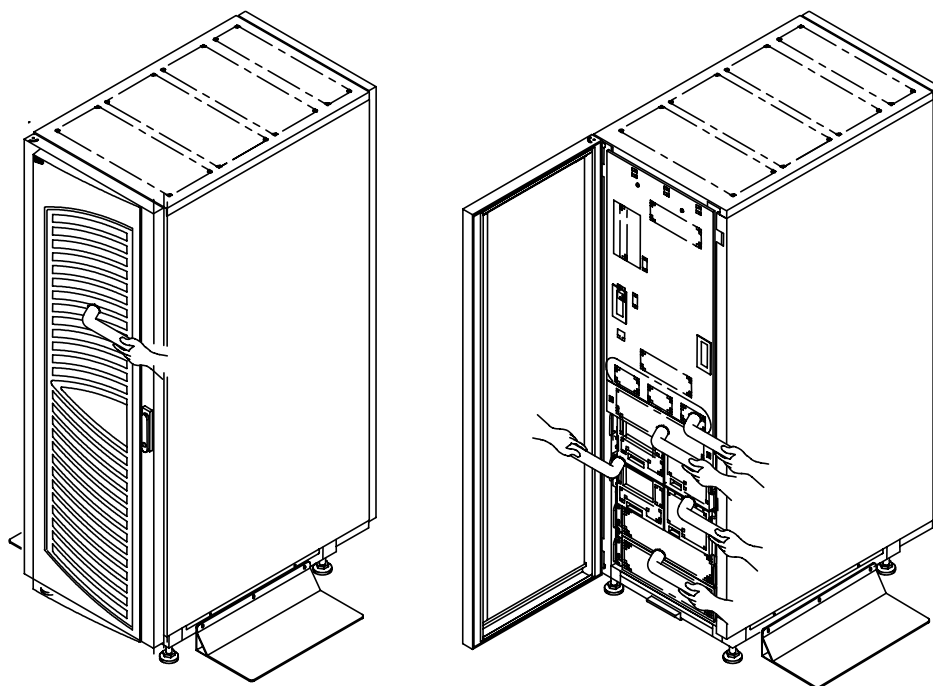

Front View

Figure 5-1 Cleaning Locations

5.5. Notes on Installation

- Do not put things on the cabinet. It does not have safety measures to prevent things put on the cabinet from falling down.
- Do not block the exhaust vent at the top of the cabinet.
- Provide 50cm of ventilation space above the exhaust vent.
- Provide 1m clearance on the front and rear of the cabinet for maintenance. Also keep 60cm clearance at both sides of the cabinet as maintenance area.
- In Japan, connect the product to a 30A overcurrent protector for indoor wiring in compliance with the Electrical Appliance and Material Control Law. Overseas, connect the product to a 30A overcurrent protector in accordance with the relevant electric wiring laws and regulations.



Notes on Handling

----- Memo -----

Free Manuals Download Website

<http://myh66.com>

<http://usermanuals.us>

<http://www.somanuals.com>

<http://www.4manuals.cc>

<http://www.manual-lib.com>

<http://www.404manual.com>

<http://www.luxmanual.com>

<http://aubethermostatmanual.com>

Golf course search by state

<http://golfingnear.com>

Email search by domain

<http://emailbydomain.com>

Auto manuals search

<http://auto.somanuals.com>

TV manuals search

<http://tv.somanuals.com>