

Express5800 140He

	■	■	■	■	■	■	■
	■	■	■	■	■	■	■
	■	■	■	■	■	■	■
	■	■	■	■	■	■	■
	■	■	■	■	■	■	■
	■	■	■	■	■	■	■
	■	■	■	■	■	■	■
	■	■	■	■	■	■	■
	■	■	■	■	■	■	■
	■	■	■	■	■	■	■
	■	■	■	■	■	■	■
	■	■	■	■	■	■	■
	■	■	■	■	■	■	■
	■	■	■	■	■	■	■
	■	■	■	■	■	■	■
	■	■	■	■	■	■	■
	■	■	■	■	■	■	■
	■	■	■	■	■	■	■
	■	■	■	■	■	■	■
	■	■	■	■	■	■	■
	■	■	■	■	■	■	■
	■	■	■	■	■	■	■
User's Guide	■	■	■	■	■	■	■

Proprietary Notice and Liability Disclaimer

The information disclosed in this document, including all designs and related materials, is the valuable property of NEC Computers International and/or its licensors. NEC Computers International and/or its licensors, as appropriate, reserve all patent, copyright and other proprietary rights to this document, including all design, manufacturing, reproduction, use, and sales rights thereto, except to the extent said rights are expressly granted to others.

The NEC Computers International product(s) discussed in this document are warranted in accordance with the terms of the Warranty Statement accompanying each product. However, actual performance of each product is dependent upon factors such as system configuration, customer data, and operator control. Since implementation by customers of each product may vary, the suitability of specific product configurations and applications must be determined by the customer and is not warranted by NEC Computers International.

To allow for design and specification improvements, the information in this document is subject to change at any time, without notice. Reproduction of this document or portions thereof without prior written approval of NEC Computers International is prohibited.

Trademarks

NEC ESMPRO and NEC EXPRESSBUILDER are trademarks of NEC Corporation.

Microsoft, Windows, Windows Server, and MS-DOS are registered trademarks or trademarks of Microsoft Corporation in the United States and other countries.

Intel and Pentium are registered trademarks of Intel Corporation.

Xeon is a trademark of Intel Corporation.

Novell and NetWare are registered trademarks of Novell, Inc. of the United States.

Datalight is a registered trademark of Datalight, Inc.

ROM-DOS is a registered trademark of Datalight, Inc.

AT is a registered trademark of International Business Machines Corporation in the United States and other countries.

Adaptec and its logo is a registered trademark of Adaptec, Inc. of United States.

SCSISelect is a trademark of Adaptec, Inc. of the United States.

Adobe, Adobe logo, and Acrobat are trademarks of Adobe Systems Incorporated.

DLT and DLTape are trademarks of Quantum Corporation of the United States.

All other product, brand, or trade names used in this publication are the trademarks or registered trademarks of their respective trademark owners.

rev 0.0 September 2005

Copyright 2005
NEC Computers International B.V.
Nieuweweg 279
6603 BN Wijchen
The Netherlands
All Rights Reserved

This page is intentionally left blank.

Keep this User's Guide at hand for quick reference at anytime necessary.



SAFETY INDICATIONS

Follow the instructions in this User's Guide for your safety to use the server.



The server contains components with possible danger, hazards that may cause by ignoring warnings, and preventive actions against such hazards.

Server components with possible danger are indicated with a warning label placed on or around them as well as described in this User's Guide.

In the User's Guide or warning labels, "WARNING" or "CAUTION" is used to indicate a degree of danger. These terms are defined as follows:

 WARNING	Indicates the presence of a hazard that may result in death or serious personal injury.
 CAUTION	Indicates the presence of a hazard that may cause minor personal injury, including burns, or property damage.

Precautions and notices against hazards are presented with one of the following three symbols. The individual symbols are defined as follows:





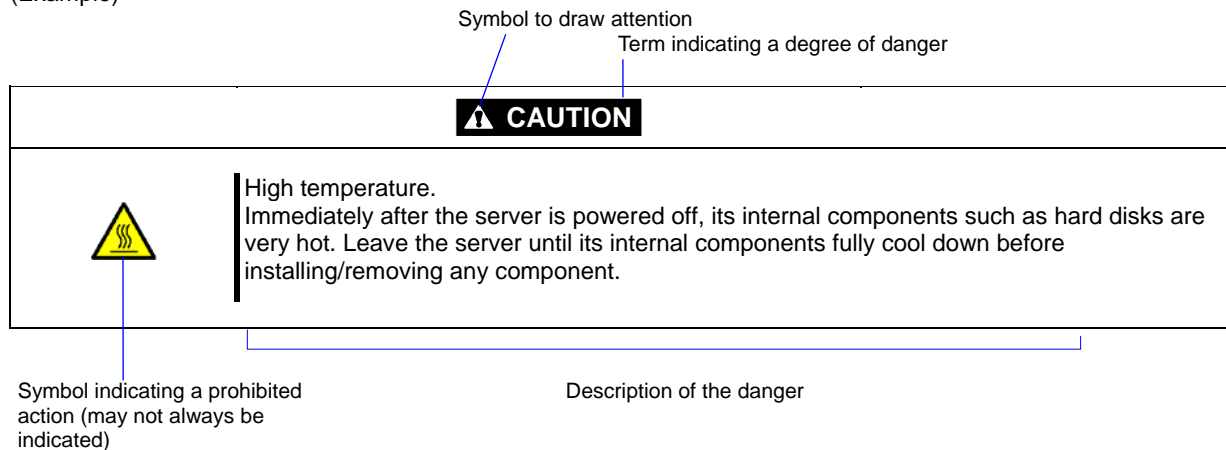

	This symbol indicates the presence of a hazard. An image in the symbol illustrates the hazard type. (Attention)
	This symbol indicates prohibited actions. An image in the symbol illustrates a particular prohibited action. (Prohibited Action)
	This symbol indicates mandatory actions. An image in the symbol illustrates a mandatory action to avoid a particular hazard. (Mandatory Action)

(Example)





SYMBOLS USED IN THIS USER'S GUIDE AND WARNING LABELS



Attentions

	Indicates that improper use may cause an electric shock.
	Indicates that improper use may cause personal injury.
	Indicates that improper use may cause fingers to be caught.
	Indicates that improper use may cause the clip of a hand.
	Indicates that improper use may cause fumes or fire.
	Indicates a general notice or warning that cannot be specifically identified.
	Indicates that improper use may cause loss of eyesight due to laser beam.

Prohibited Actions

	Indicates a general prohibited action that cannot be specifically identified.
	Do not disassemble, repair, or modify the server. Otherwise, an electric shock or fire may be caused.

Mandatory Action

	Unplug the power cord of the server. Otherwise, an electric shock or fire may be caused.
	Indicates a mandatory action that cannot be specifically identified. Make sure to follow the instruction.

SAFETY INDICATIONS BY COLOUR OF THE PARTS

Only green area is available for hot swap or hot plug operation. To avoid electric shock, disconnect all AC power cords before accessing to other parts especially blue area inside the system.

NOTE: This equipment has been tested and found to comply with the limits for a Class A digital device, pursuant to Part 15 of the FCC Rules. These limits are designed to provide reasonable protection against harmful interference when the equipment is operated in a commercial environment. This equipment generates, uses, and can radiate radio frequency energy and, if not installed and used in accordance with the instruction manual, may cause harmful interference to radio communications. Operation of this equipment in a residential area is likely to cause harmful interference in which case the user will be required to correct the interference at his own expense.

CE Statement

Warning: This is a Class A product. In domestic environment this product may cause radio interference in which case the user may be required to take adequate measures (EN55022).

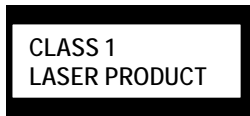

This system is classified as a CLASS 1 LASER PRODUCT. This label is located on the internal CD-ROM installed in your system.

Momentary voltage drop prevention:

This product may be affected by a momentary voltage drop caused by lightning. To prevent a momentary voltage drop, an AC uninterruptible power supply (UPS) unit should be used.

Notes:

- (1) No part of this manual may be reproduced in any form without the prior written permission of NEC Corporation.
- (2) The contents of this User's Guide may be revised without prior notice.
- (3) The contents of this User's Guide shall not be copied or altered without the prior written permission of NEC Corporation.
- (4) All efforts have been made to ensure the accuracy of all information in this User's Guide. If you notice any part unclear, incorrect, or omitted in this User's Guide, contact the service representative where you purchased this product.
- (5) NEC assumes no liability arising from the use of this product, nor any liability for incidental or consequential damages arising from the use of this User's Guide regardless of Item (4).

PREFACE

Welcome to the Express5800/140He server.

The Express5800 server holds powerful performance and employs the latest technology to implement a computer for the next generation. With its potential capabilities, the server may be used as the workstation PC that configures a client-server system and provides high-speed processing and superior reliability.

Read this User's Guide thoroughly to fully understand handling of the server and appreciate its functions to the maximum extent.

ABOUT THIS USER'S GUIDE

This User's Guide is a guide for proper setup and use of the server.

This User's Guide also covers useful procedures for dealing with difficulties and problems that may arise during setup or operation of the server. Keep this manual for future use.

The following describes how to proceed with this User's Guide.

How to Use This User's Guide

To aid you in finding information quickly, this User's Guide contains the following information:

Chapter 1 Notes on Using Your Server

includes information that needs attention to use the server. Make sure to read this chapter before setting up and using the server.

Chapter 2 General Description

includes information necessary to use the server, such as names and functions of its components, handling of the floppy disk and CD-ROM drives. It also includes requirements and advisory information for transfer and disposal of the server.

Chapter 3 Setting Up Your Server

tells you how to select a site, unpack the system, make cable connections, and power on your system.

Chapter 4 Configuring Your Server

tells you how to configure the system and provides instructions for running the BIOS Setup Utility and the MegaRAID Configuration Utility, which is used to configure SCSI devices in your system. This chapter also provides information on I/O board jumper settings.

Chapter 5 Installing the Operating System with Express Setup

describes how to install the operating system.

Chapter 6 Installing and Using Utilities

describes how to install the utilities for the server. It also includes a description on using the attached "NEC EXPRESSBUILDER" CD-ROM.

Chapter 7 Maintenance

provides you with all the information necessary to maintain successful operation of the server. This chapter also includes a description on relocating and storing the server.

Chapter 8 Troubleshooting

contains helpful information for solving problems that might occur with your system.

Chapter 9 Upgrading Your Server

provides you with instructions for upgrading your system with an additional processor, optional memory, optional add-in cards, hard disk drives, peripheral devices, and power supply.

Appendix A Specification

provides specifications for your server.

Appendix B Other Precautions

provides supplementary notes on using the server.

Appendix C IRQ and I/O Port Address

provides a list of factory-set IRQs and I/O port addresses assigned.

Appendix D Installing Windows Server™ 2003 x64 Editions

describes how to install Microsoft® Windows Server™ 2003 x64 Editions without using Express Setup. Using the Express Setup tool is recommended for installing Windows Server™ 2003 x64 Editions. See Chapter 5 for details.

Appendix E Installing Windows Server 2003

describes how to install Microsoft® Windows Server™ 2003 without using Express Setup. Using the Express Setup tool is recommended for installing Windows Server™ 2003. See Chapter 5 for details.

Appendix F Product Configuration Record Table

provides a table to be filled with your server configuration.

Text Conventions

The following conventions are used throughout this User's Guide. For safety symbols, see "SAFETY INDICATIONS" provided earlier.

IMPORTANT: Items that are mandatory or require attention when using the server.

NOTE: Notes give important information about the material being described.

IN THE PACKAGE

The carton contains various accessories, as well as the server itself. See the packing list to make sure that you have everything and that individual components are not damaged. If you find any component missing or damaged, contact your service representative.

- Store the provided accessories in a designated place for your convenience. You will need them to install optional devices or troubleshoot the server, as well as to set it up.
- Make a backup copy of each provided floppy disk, if any. Store the original disk as the master disk in a designated place, and use its copy.
- Improper use of any provided floppy disk or CD-ROM may alter your system environment. If you find anything unclear, immediately ask your service representative for help.

CONTENTS

Preface	i
About This User's Guide	ii
In the Package	iii
Chapter 1	1-1
Notes on Using Your Server	1-1
Warning Labels	1-2
Safety Notes	1-3
General	1-3
Power Supply and Power Cord Use.....	1-4
Installation, Relocation, Storage, and Connection.....	1-5
Cleaning and Working with Internal Devices	1-6
During Operation.....	1-7
For Proper Operation	1-8
Transfer to Third Party.....	1-9
Consumables.....	1-10
Disposal of the Server.....	1-10
User Support	1-11
Chapter 2	2-1
General Description.....	2-1
Overview.....	2-2
External View	2-3
Front View (with the Front Door Open)	2-4
Front View (Switch and LED Panel)	2-5
Rear View	2-6
Internal View	2-8
I/O Board.....	2-9
Processor Board.....	2-10
Memory Board.....	2-11
Management LAN Board	2-11
Standard Features.....	2-12
Power Supplies	2-13
Peripheral Bays.....	2-13
Recovering BIOS Data	2-15
SAF-TE Logic	2-15
System Cooling	2-15
System Board Features	2-16
Security.....	2-18
EXPRESSBUILDER.....	2-19
ESMPRO.....	2-20
Off-line Maintenance Utility	2-20
System Diagnostic Utility.....	2-20
DianaScope.....	2-20
Using Your Server.....	2-21
Security Lock (Locking the Front Cover).....	2-21
POWER Switch.....	2-22
POST	2-22
SLEEP Switch	2-26
Floppy Disk Drive	2-27
CD-ROM Drive.....	2-28
Chapter 3	3-1

Setting Up Your Server	3-1
Setup Flow.....	3-2
Selecting a Site	3-3
Unpacking the System	3-5
Connecting Peripheral Devices.....	3-6
Connecting Power Cord.....	3-8
Turning On the Server	3-10
Installing Operating System	3-12
Installing Utilities	3-12
Making Backup Copies of System Information.....	3-12
 Chapter 4	 4-1
Configuring Your Server	4-1
System BIOS ~ SETUP ~	4-1
Starting SETUP Utility	4-2
Description of On-Screen Items and Key Usage.....	4-3
Configuration Examples.....	4-4
Menu and Parameter Descriptions	4-7
Disk Array Configuration – MegaRAID Configuration Utility –	4-29
Notes on Using	4-29
Starting Configuration Utility.....	4-30
Menu Tree	4-31
Operating Procedures for Configuration Utility	4-34
Remote Management Function.....	4-49
Default Network Settings.....	4-49
Server Setup	4-49
Configuring Management PC.....	4-50
Using Remote Management Console.....	4-51
Configuring I/O Board Jumpers	4-77
 Chapter 5	 5-1
Installing the Operating System with Express Setup	5-1
About Express Setup	5-2
Microsoft® Windows Server™ 2003	5-3
Installation Notice	5-3
Setup Flow	5-6
Installing Windows Server 2003	5-7
Installing and Setting Device Drivers.....	5-10
Setting for Solving Problems	5-15
Installing Maintenance Utilities	5-18
Updating the System	5-18
Making Backup Copies of System Information	5-18
Exceptional Setup.....	5-19
 Chapter 6	 6-1
Installing and Using Utilities	6-1
EXPRESSBUILDER.....	6-2
EXPRESSBUILDER for DOS-Based with Local Console.....	6-4
EXPRESSBUILDER for DOS-based with Remote Console	6-8
EXPRESSBUILDER for Windows-Based (Master Control Menu).....	6-10
Configuration Diskette Creator.....	6-11
ESMPRO	6-15
Functions and Features.....	6-15
DianaScope.....	6-16

Power Console Plus	6-17
Major Functions.....	6-17
Components.....	6-17
Server Setup	6-18
Management PC Setup	6-19
BMC Online Update	6-20
Hardware Requirement.....	6-20
Installation	6-20
Startup	6-22
Uninstallation	6-24
Error Messages	6-26
Chapter 7	7-1
Maintenance	7-1
Making Backup Copies.....	7-1
Also make a backup copy of the disk array configuration data if your system is in the array configuration. When your hard disks have been auto-rebuilt due to a failure, it is recommended to make a backup copy of the configuration data. To make a backup copy of the configuration data, use the configuration utility that is resident in the FLASH memory on the optional disk array controller board. Refer to the manual supplied with the board.....	7-1
Cleaning	7-1
Cleaning the Server	7-2
Cleaning the Interior.....	7-2
Cleaning the Keyboard and Mouse.....	7-3
Cleaning CD-ROM.....	7-4
System Diagnostics	7-5
Test Items.....	7-5
Starting and Ending the System Diagnostics.....	7-5
Relocating/Storing the Server	7-8
Chapter 8	8-1
Troubleshooting.....	8-1
System Viewers.....	8-2
Lamps	8-3
POWER/SLEEP Lamp	8-3
STATUS Lamp	8-3
DISK ACCESS Lamp.....	8-5
LAN1/LAN2 ACCESS Lamp	8-5
UID Lamp.....	8-5
Attention Lamp.....	8-6
Processor Board Error Lamp	8-6
Memory Board Error Lamp.....	8-7
I/O Board Error Lamp	8-8
Power Unit Error Lamp	8-9
Fan Error Lamp	8-10
Thermal Error Lamp.....	8-10
Access Lamps.....	8-10
Memory Board Lamps.....	8-11
Hard Disk Drive Lamp (DISK Lamp).....	8-12
LAN Connector Lamps	8-13
PCI Slot Lamps.....	8-14
FAN Fault Lamps	8-15
Error Messages	8-16
Error Messages after Power-on	8-16
POST Error Messages	8-17
Beep Codes.....	8-23
Error Messages on Virtual LCD	8-24

Solving Problems.....	8-29
Problems with Server	8-29
Problems with Windows Server 2003 x64 Editions	8-35
Problems with Windows Server 2003 and Windows 2000.....	8-36
Problems with EXPRESSBUILDER	8-40
Problems with Express Setup.....	8-41
Error Message during Disk Array Configuration	8-44
Problems with Master Control Menu	8-45
Problems with Configuration Diskette Creator	8-45
Collecting Event Log.....	8-46
Collect Configuration Information	8-47
Collecting Dr. Watson Diagnostic Information.....	8-48
Memory Dump	8-48
Preparing for Memory Dumping.....	8-48
Saving the Dump File.....	8-49
Recovery for Windows 2000 System.....	8-50
Off-Line Maintenance Utility	8-52
Starting the Off-line Maintenance Utility.....	8-52
Features of Off-line Maintenance Utility	8-53
Resetting the Server.....	8-54
Forced Shutdown.....	8-54
Chapter 9	9-1
Upgrading Your Server	9-1
Safety Notes.....	9-2
Anti-static Measures	9-3
Preparing for Installation and Removal	9-4
Device Installation or Removal Procedure	9-5
3.5-inch Hard Disk Drive	9-5
Power Supply Unit	9-10
5.25-inch Device	9-14
Rear Access Cover	9-17
PCI Access Cover.....	9-19
PCI Board.....	9-20
Memory Board	9-42
DIMM	9-45
Processor Board	9-55
Processor	9-58
Appendix A.....	A-1
Specifications	A-1
Appendix B.....	B-1
Other Precautions	B-1
Transfer Rate of the On-board LAN Controller	B-1
Server Management Software	B-1
Floppy Disk.....	B-1
CD-ROM.....	B-3
Tape Media.....	B-3
Keyboard.....	B-4
Mouse.....	B-5
Appendix C.....	C-1

IRQ and I/O Port Address.....	C-1
Appendix D.....	D-1
Installing Windows Server™ 2003 x64 Editions	D-1
Before Installing Windows Server 2003 x64 Editions	D-1
Optional Boards Supported by NEC EXPRESSBUILDER	D-1
Updating System	D-1
Re-installing to the Hard Disk Which Has Been Upgraded to Dynamic Disk	D-1
MO Device	D-1
Media such as DAT	D-2
Partition Size	D-2
Installing Windows Server™ 2003 x64 Editions	D-3
Creating "Windows Server 2003 x64 Edition OEM-DISK for NEC EXPRESSBUILDER"	D-3
Windows Server™ 2003 x64 Editions Clean Installation	D-5
Updating the System.....	D-6
Driver Installation and Advanced Settings.....	D-7
PROSet	D-7
Network Driver.....	D-8
Optional Network Board Driver	D-8
Graphics Accelerator Driver.....	D-9
Installing SCSI Controller Driver (Adaptec 29320 / SCSI U160 PCI-ATX-64b)	D-9
Installing Disk Array Controller Driver (SecuRAID 321).....	D-9
Setting for Collecting Memory Dump (Debug Information)	D-9
Appendix E	E-1
Installing Windows Server™ 2003	E-1
Before Installing Windows Server™ 2003	E-1
Optional Boards Supported by NEC EXPRESSBUILDER	E-1
Updating System	E-1
Re-installing to the Hard Disk Which Has Been Upgraded to Dynamic Disk	E-1
MO Device	E-1
Media such as DAT	E-2
Partition Size	E-2
Installing Windows Server 2003	E-3
Creating "Windows Server 2003 OEM-DISK for NEC EXPRESSBUILDER"	E-3
Windows Server 2003 Clean Installation	E-5
Updating the System.....	E-6
Upgrade Installation	E-7
Driver Installation and Advanced Settings.....	E-9
PROSet	E-9
Network Driver.....	E-10
Re-install the Network Driver	E-10
Installing SCSI Controller Driver (Initio 101 / Adaptec 29320).....	E-11
Installing SCSI Controller Driver (SCSI U160 PCI-ATX-64b).....	E-11
Installing Disk Array Controller Driver (SecuRAID 321).....	E-11
Setting for Collecting Memory Dump (Debug Information)	E-11
Appendix F	E-1
Product Configuration Record Table.....	E-1
Hardware	E-1
Software.....	E-4

Chapter 1

Notes on Using Your Server

This chapter includes information necessary for proper and safe operation of your server.

WARNING LABELS

A warning label is attached to components with possible danger or their vicinity in your server to inform the user that a hazardous situation may arise when operating the server. (Do not intentionally remove or damage any of these labels.)

If you find any label totally/partially removed or illegible due to damage, contact your sales representative.

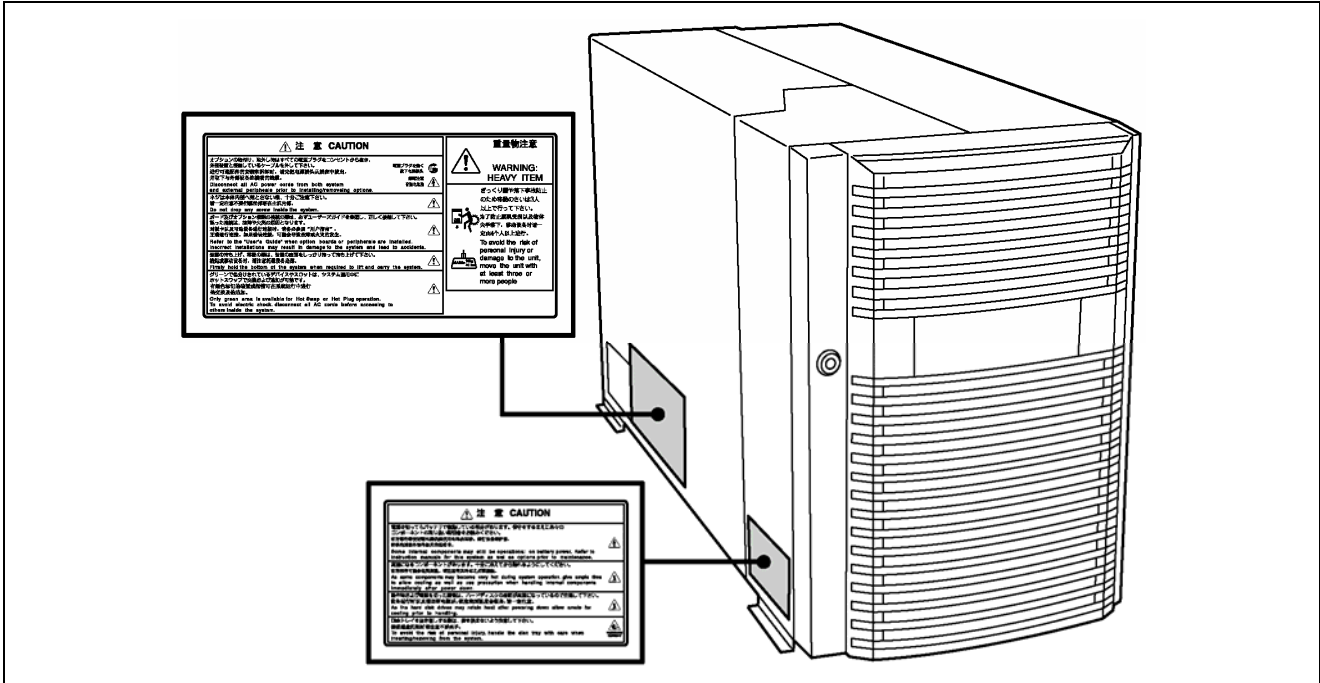

SAFETY NOTES

This section provides notes on using your server safely. Read this section carefully to ensure proper and safe use of the server. For symbols, see "SAFETY INDICATIONS" provided earlier.

General

WARNING



Do not use the server for services where critical high availability may directly affect human lives.

Your server is not intended to be used with or control facilities or devices concerning human lives, including medical devices, nuclear facilities and devices, aeronautics and space devices, transportation facilities and devices; and facilities and devices requiring high reliability. We assume no liability for any accident resulting in personal injury, death, or property damage if the server has been used in the above conditions.



Do not use the server if any smoke, odour, or noise is present.

If smoke, odour, or noise is present, immediately turn off the POWER switch and disconnect the power plug from the outlet, then contact your service representative. Using the server in such conditions may cause a fire.



Keep needles or metal objects away from the server.

Do not insert needles or metal objects into ventilation holes in the server or openings in the floppy disk or CD-ROM drive. Doing so may cause an electric shock.

CAUTION



Keep water or foreign matter away from the server.



Do not let any form of liquid (water etc.) or foreign matter (e.g., pins or paper clips) enter the server. Failure to follow this warning may cause an electric shock, a fire, or a failure of the server. When such things accidentally enter the server, immediately turn off the power and disconnect the power plug from the outlet. Do not disassemble the server. Contact your service representative.

Power Supply and Power Cord Use

⚠ WARNING



Do not hold the power plug with a wet hand.

Do not disconnect/connect the plug while your hands are wet. Failure to follow this warning may cause an electric shock.

⚠ CAUTION



Plug in to a proper power source.

Use a proper wall outlet. Use of an improper power source may cause a fire or a power leak. Do not install the server where you need an extension cord. Use of a power cord that does not meet the power specifications of your server may heat up the cord and cause a fire.



Do not connect the power cord to an outlet that has an illegal number of connections.

The electric current exceeding the rated flow overheats the outlet, which may cause a fire.



Insert the power plug into the outlet as far as it goes.

Heat generation resulting from a halfway inserted power plug (imperfect contact) may cause a fire. Heat will also be generated if condensation is formed on dusty blades of the halfway inserted plug, increasing the possibility of fire.



Use an authorized power cord only.

Use only the power cord that comes with your server. Use of an unauthorized power cord may cause a fire when the electric current exceeds the rated flow.

Also, observe the following to prevent an electric shock or fire caused by a damaged cord.

Do not stretch the cord harness.

Do not pinch the power cord.

Do not bend the power cord.

Keep chemicals away from the power cord.

Do not twist the power cord.

Do not place any object on the power cord.

Do not bundle power cords.

Do not alter, modify, or repair the power cord.

Do not secure the power cord with staples or equivalents.

Do not use any damaged power cord. (Replace a damaged power cord with a new one of the same specifications. Ask your service representative for replacement.)



Do not use the attached power cord for any other devices or usage.



The power cord that comes with your server is designed aiming to connect with this server and to use with the server, and its safety has been tested. Do not use the attached power cord for any other purpose. Doing so may cause a fire or an electric shock.

Installation, Relocation, Storage, and Connection

⚠ CAUTION



Never attempt to lift the server only by three persons or less.

Your server weighs 75 kg (depending on its hardware configuration). Carrying the server only by three persons or less may strain your back. Hold the server firmly by its bottom with four persons or more to carry it. Do not hold the front door to lift the server. The front door may be disengaged from the server, causing personal injury.



Do not install the server in any place other than specified.

Do not install the server in the following places or any place other than specified in this manual. Failure to follow this instruction may cause a fire.

- a dusty place
- a humid place such as near a boiler
- a place exposed to direct sunlight
- an unstable place



Do not connect any interface cable with the power cord of the server plugged to a power source.



Make sure to power off the server and unplug the power cord from the power outlet before installing/removing any optional internal device or connecting/disconnecting any interface cable to/from the server. If the server is off-powered but its power cord is plugged to a power source, touching an internal device, cable, or connector may cause an electric shock or a fire resulted from a short circuit.



Do not use any unauthorized interface cable.

Use only interface cables provided by us and locate a proper device and connector before connecting a cable. Using an authorised cable or connecting a cable to an improper destination may cause a short circuit, resulting in a fire.

Also, observe the following notes on using and connecting an interface cable.

- Do not use any damaged cable connector.
- Do not step on the cable.
- Do not place any object on the cable.
- Do not use the server with loose cable connections.



Do not use the equipment in the place where corrosive gases exist.

Make sure not to locate or use the server in the place where corrosive gases (sulphur dioxide, hydrogen sulphide, nitrogen dioxide, chlorine, ammonia, ozone, etc) exist. Also, do not set it in the environment where the air (or dust) includes components accelerating corrosion (ex. sulphur, sodium chloride) or conductive metals. There is a risk of a fire due to corrosion and shorts of an internal printed board.



Do not provide the wiring for the server to exceed the rating of the power supply.



To prevent burns, fires, and device damages, the power supplied to the server shall not exceed the rating load of the power branch circuit. The server requires three or four Power Cords (depending on your configuration). Connect each power cord to each appropriate Wall Outlet provided with 20A branch circuit. Contact your electric constructor or the local power company for the requirements on the wiring and installation of electric facilities.

Cleaning and Working with Internal Devices

⚠ WARNING



Do not disassemble, repair, or alter the server.



Never attempt to disassemble, repair, or alter the server on any occasion other than described in this manual. Failure to follow this instruction may cause an electric shock or fire as well as malfunctions of the server.



Do not look into the CD-ROM drive.

A laser beam used in the CD-ROM drive is harmful to the eyes. Do not look into or insert a mirror into the drive while the drive is powered. If a laser beam is caught in your eyes, you may lose your eyesight (the laser beam is invisible).



Do not remove the lithium and NiMH batteries.

Your server contains lithium and NiMH batteries. Do not remove the battery. Danger of explosion if the battery is incorrectly replaced. Placing the battery close to a fire or in the water may cause an explosion.

When the server does not operate appropriately due to dead lithium and/or NiMH batteries, contact your service representative to replace it only with the same or equivalent type recommended by us. Do not disassemble the server to replace or recharge the battery by yourself.



Disconnect all the power plugs before accessing inside the server, or connecting the peripherals.

The server has two power cords.

Make sure to power off the server and disconnect all power plugs from the power outlets before cleaning or installing/removing internal optional devices. Touching any internal device of the server with its power cords connected to a power source may cause an electric shock even if the server is off-powered.

Disconnect all the power plugs from the outlet occasionally and clean the plug with a dry cloth. Heat will be generated if condensation is formed on a dusty plug, which may cause a fire.

⚠ CAUTION



High temperature

Immediately after the server is powered off, its internal components such as hard disks are very hot. Leave the server until its internal components fully cool down before installing/removing any component.



Make sure to complete board installation.

Always install a board firmly. An incompletely installed board may cause a contact failure, resulting in smoke or fire.



Protect the unused connectors with a protective cap.

The unused power supply cable connectors are covered with a protective cap to prevent short circuits and electrical hazards. When removing the power supply cable connector from the internal devices, attach a protective cap to the connector. Failure to follow this warning may cause a fire or an electric shock.



Do not touch any electrical component inside the server during the hot-swap replacement.

All power flows inside the server during the hot-swap of replaceable components (PCI add-in cards, hard disk, cooling fan, and power supply). Do not touch the electrical components inside the server to avoid an electric shock.

During Operation

⚠ CAUTION

Avoid contact with the server during thunderstorms.

Disconnect all power plugs from the outlets when a thunderstorm is approaching. If it starts thundering before you disconnect the all power plugs, do not touch any part of the server including the cables. Failure to follow this warning may cause a fire or an electric shock.



Keep animals away from the server.



Failure to follow this warning may cause a fire or an electric shock.



Do not place any object on top of the server.

An object placed on top of the server may fall down, resulting in damage to your property around the server.



Do not use a cellular phone or pager around the server.

Turn off the cellular phone or pager. Radio interference may cause malfunctions of the server.



Do not remove the cooling fans.

Only an authorized service technician can remove the cooling fans from the server.

FOR PROPER OPERATION

Observe the following notes for successful operation of the server. Use of the server ignoring these notes will cause malfunctions or failures of the server.

- Install the server in a place that meets requirements for successful operation. For details, see Chapter 3, "Setting Up Your Server."
- Do not delete the hard disk partition exclusively provided for maintenance of the server although it may appear on the operating system.
- Make sure to power off the server before connecting or disconnecting cables between the server and peripheral devices.
- Verify that the access lamp on the server is unlit before turning off the server or ejecting the floppy disk.
- The server management logic on your system board monitors and logs system voltage changes. When plugging the power cord to the system, you may experience 10 seconds delay from the time you press the POWER switch on the front panel. This is normal system operation and is required by the server management logic.
- When you have just turned off the server, wait at least 30 seconds before turning it back on.
- Do not turn off the server until characters following our logo appear on the screen.
- Turn off the power and unplug the power cord from the outlet before relocating the server.
- Some software includes a command to eject the CD-ROM tray. Make sure that the front door is opened before running the command. Running this command with the front door closed may cause the CD-ROM tray or the media to hit against the front door, resulting in a failure of the server.
- Clean the server on a regular basis. (See Chapter 7 for cleaning.) Regular cleaning proactively prevents various failures of the server.
- Lightning may cause a momentary voltage drop. To prevent this problem, it is recommended to use an uninterruptible power supply unit.
- Check and adjust the system clock before the operation if any of the following conditions is applicable.
 - After transport of the server
 - After storage of the server
 - After the server is entered into the pause state under the environmental condition enduring the server operation (temperature: 10°C to 35°C, humidity: 20% to 80%)
- Check the system clock at the rough rate of once per month. When the system clock is installed in a system requiring high time precision, it is recommended to use a time server (NTP server). If the system clock is remarkably delayed or advanced as the passage of time in spite of adjustment, contact your service representative to ask for maintenance.
- Store the unit under the storage condition (temperature: -10°C to 55°C, humidity: 20% to 80%, without condensation) to allow built-in devices and the unit to operate correctly in the next operation.
- Make sure to use optional devices supported by the server. Some non-supported devices may be physically installed/connected but cause failures of the server as well as malfunctions of the server.
- We recommend you use our genuine products. Some third-party products claim that they support the server. However, repair of the server due to a failure or damage resulting from use of such third-party products will be charged.
- Playback of disks that do not conform to CD-ROM standards with the CD-ROM drive is not guaranteed.

TRANSFER TO THIRD PARTY

The following must be observed when you transfer (or sell) the server or software provided with the server to a third party:

Express server

Make sure to provide this manual along with the server to a third party.

IMPORTANT: About data on the hard disk

Be sure to take appropriate measures not to leak important data (e.g., customers' information or companies' management information) on the removed hard disk to any third parties.

Data seems to be erased when you empty "Recycle Bin" of Windows or execute the "format" command of the operating system. However, the actual data remains written on the hard disk. Data not erased completely may be restored by special software and used for unexpected purposes.

It is strongly recommended that the software or service (both available at stores) for data erasure should be used in order to avoid the trouble explained above. For details on data erasure, ask your sales representative.

Provided software

To transfer or sell any software application that comes with the server to a third party, the following requirements must be satisfied:

- All provided software applications must be transferred and no backup copies must be retained.
- Transfer requirements listed in "Software License Agreement" that comes with each software application must be satisfied.
- Software applications that are not approved for transfer must be uninstalled before transferring the server.

CONSUMABLES

Your server contains some components that are only good for a limited period of time and require replacement, such as batteries, fans, the internal CD-ROM drive, the floppy disk drive, and the mouse. For stable operation of the server, we recommend you replace these components on a regular basis. Contact your service representative for replacement or the product.

DISPOSAL OF THE SERVER

Dispose of the server, all the internal devices, floppy disks, and CD-ROMs according to all national laws and regulations. Also dispose of the power cord provided with the server to avoid diversion to some other devices.

IMPORTANT: For disposal (or replacement) of the battery on the IO board of the server, contact your service representative.

NOTE: If the real-time clock battery on the I/O board reaches its life, the following message appears on the display while running the POST. Contact your service representative to replace the battery.

0250 System battery is dead –Replace and run SETUP

⚠ WARNING



Do not remove the lithium and NiMH batteries.

Your server contains lithium or NiMH batteries. Do not remove any battery. Danger of explosion if the battery is incorrectly replaced. Placing the lithium or NiMH battery close to a fire or in the water may cause an explosion.

When the server does not operate appropriately due to the failure of lithium and/or NiMH batteries, contact your service representative to replace it only with the same or equivalent type recommended by us. Do not disassemble the server to replace or recharge the battery by yourself.

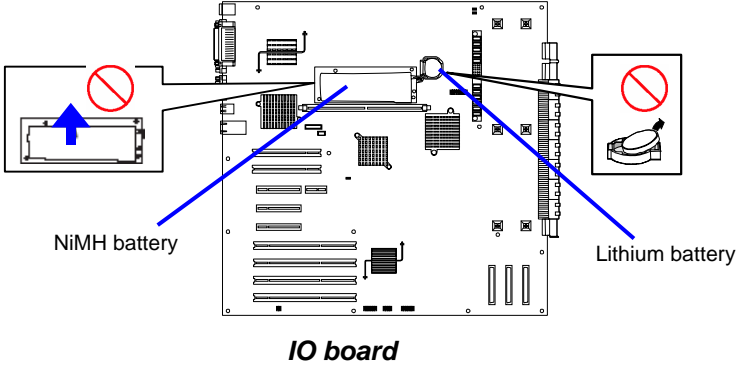

IO board

USER SUPPORT

When the server needs after-sales service, check if the warranty is still valid, and determine which service is necessary as indicated on the "Certificate".

Before asking for repair, do the following when the server appears to fail:

1. Check if the power cord and the cables to other devices are properly connected.
2. See Chapter 8 to find if your problem fits the description. If it does, take the recommended measure for it.
3. Check if the software required for operation of the server is properly installed.
4. Check the server using a computer virus detection program. Computer virus detection programs are available for purchase in stores.

If the server still appears to fail after you have taken the above actions, contact your service representative immediately. Take notes on lamp indications of the server and alarm indications on the display unit before, it may provide a significant help to your service representative.

When Having Your Server Repaired

Prepare the following when having your server repaired:

- Certificate
- Notes of the messages displayed on the display unit
- Error information*
- Records of the Express server and peripheral equipment

* Error information includes the Error Message shown in Chapter 8.

Prepare the error information only when required by your service representative.

Setting Up a Healthy Work Environment

The longer you keep using the computer equipment, the more you become tired, which may cause disorders of your body. When you use a computer, observe the following to keep yourself from getting tired:

Good Working Posture

You have good posture if the following are satisfied when you use a computer:

- You sit on a chair with your back straight.
- Your hands are parallel with the floor when you put them on the keyboard.
- You look at the screen slightly lower than your eye height.

You have "good working posture" as described in the above when no part of your body is under excess strain, in other words when your muscles are most relaxed.

You have "bad posture" when you sit with your back hunched up or you operate a display unit with your face close to the screen. Bad working posture may cause eye strain or poor eyesight.



Display Unit Angles Adjustment

Most display units are designed for adjustment of the horizontal and vertical angles. This adjustment is important to prevent the screen from reflecting bright lights and to make the display contents easy to see. You will not be able to keep "good working posture" and you will feel more tired than you should if you operate a display unit without adjusting horizontal and vertical angles.

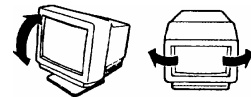

Screen Brightness and Contrast Adjustment

The display unit has brightness and contrast adjustment functions. The most suitable brightness and contrast depend on the individual and the working environment (well-lighted room or insufficient light). Adjust brightness and contrast so that the screen will be easy to see. An extremely bright or dark screen will give a bad effect to your eyes.

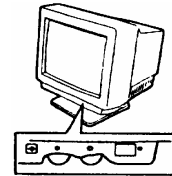

Keyboard slope Adjustment

The keyboard provided with the server is designed for slope adjustment. Adjust the keyboard angle at which the keyboard is easy to operate. The adjustment assists in reducing strain on your shoulders, arms, and fingers.

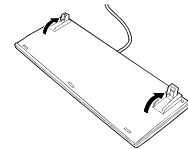

Equipment Cleaning

Clean equipment regularly. It is difficult to see the display contents on a dusty screen. Keeping equipment clean is also important for your sight.

Fatigue and Rest

If you feel tired, you should stop working and do light exercises.



Chapter 2

General Description

This chapter provides information that you should be familiar with before using the server. It includes names and functions of the components and features of the server.

OVERVIEW

Your server is a highly reliable, high-powered, fault-tolerant, high-capacity, multiprocessing server based on the 64-bit Intel® Xeon™ Processor MP. It is a solid performer and offers the latest technology. The combination of computing performance, memory capacity, and integrated I/O provides a high performance environment for many server market applications. These range from large corporations supporting remote offices to small companies looking to obtain basic connectivity capability such as file and print services, e-mail, web access, web site server, etc.

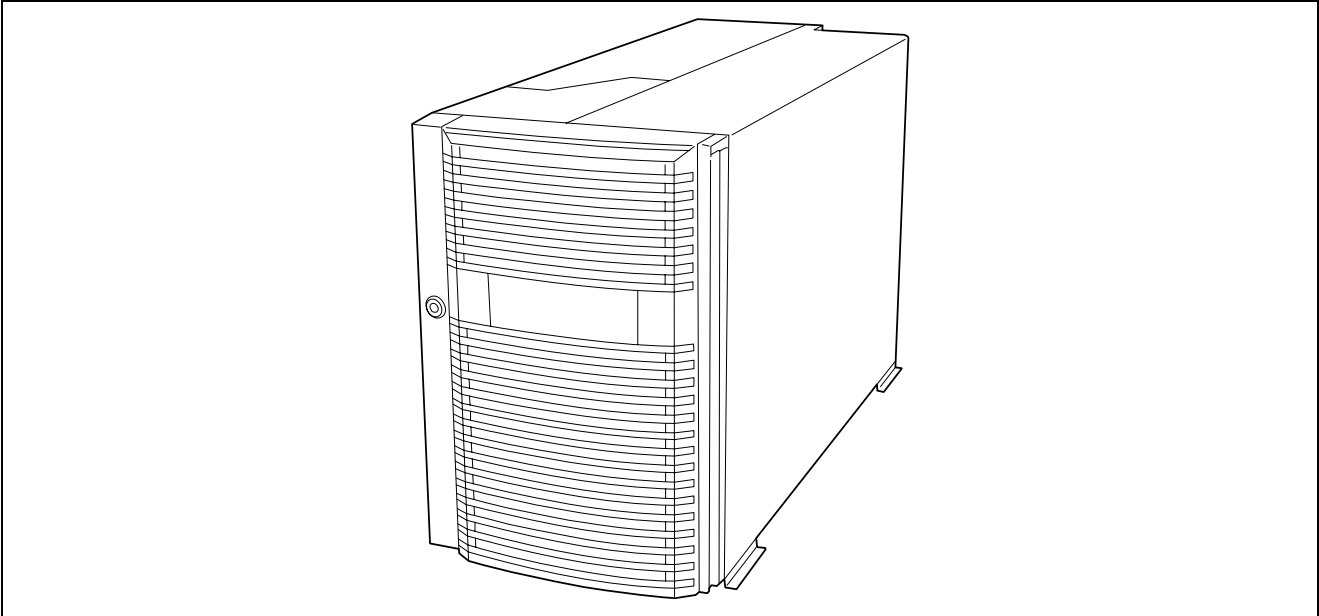

Your server includes a 3.5-inch diskette drive, a CD-ROM drive, a 3.5-inch hard disk bay, and removable media device bay. In the basic configuration, the 3.5-inch hard disk bay supports up to five 1.0-inch height SCSI hard disk drives that can be swapped in or out of the system without powering it down, if RAID functionality is configured in the system. If the additional hard disk drive cage is installed in your server, the 3.5-inch hard disk bay supports up to thirteen 1.0-inch height SCSI hard disk drives.

As application requirements increase, you can expand your server with an additional processor, additional memory, add-in boards and peripheral devices: tape devices, CD-ROM, and hard disk drives.

External View

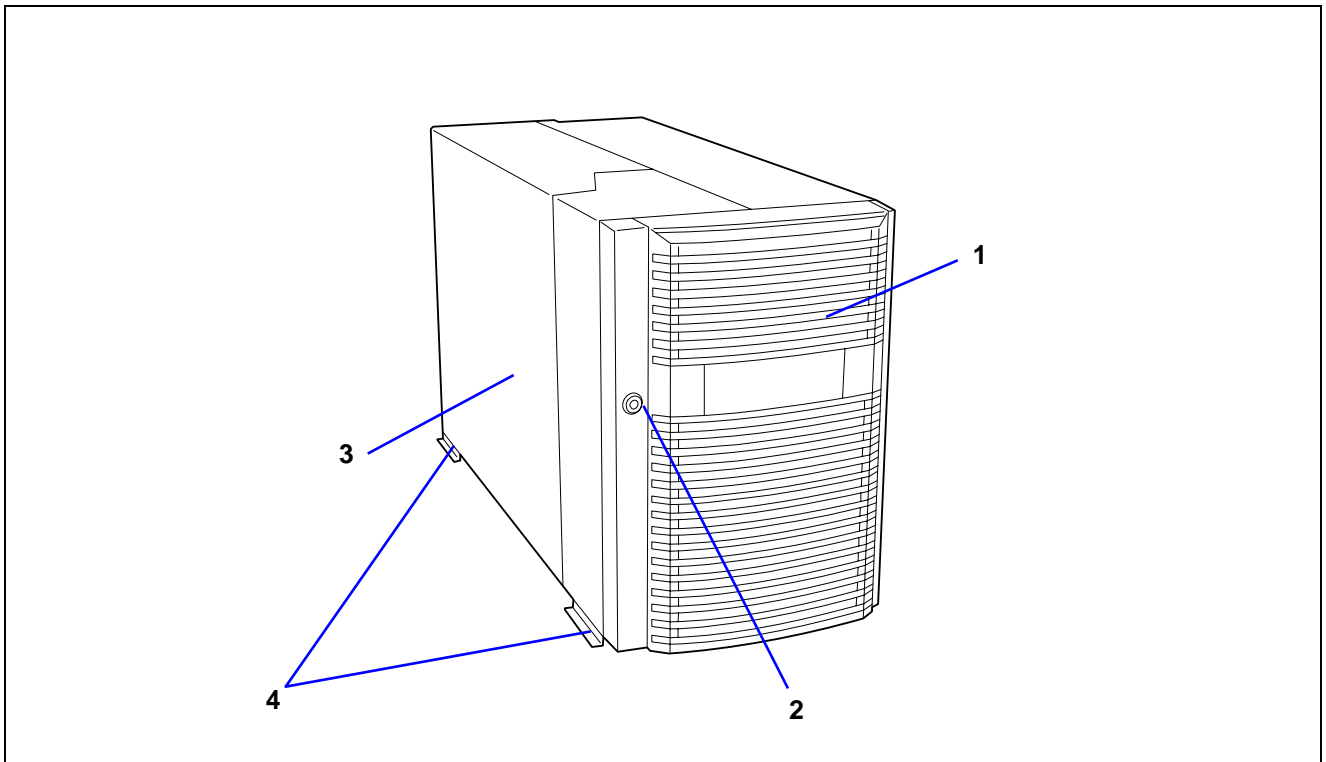

1 Front door

Open the front door when you access to the POWER switch, the 5.25-inch device, the CD-ROM drive, or the optional USB floppy disk drive or install or remove a hard disk drive, processor, memory board, and/or the DIMM.

2 Key slot

Insert the security key to lock or unlock the front door.

3 Rear access cover

Open the rear access cover to install or remove the PCI boards and fans.

4 Stabilizer (2 each side at front and rear)

Remove the stabilizers when converting the server to rack-mounting model.

Front View (with the Front Door Open)

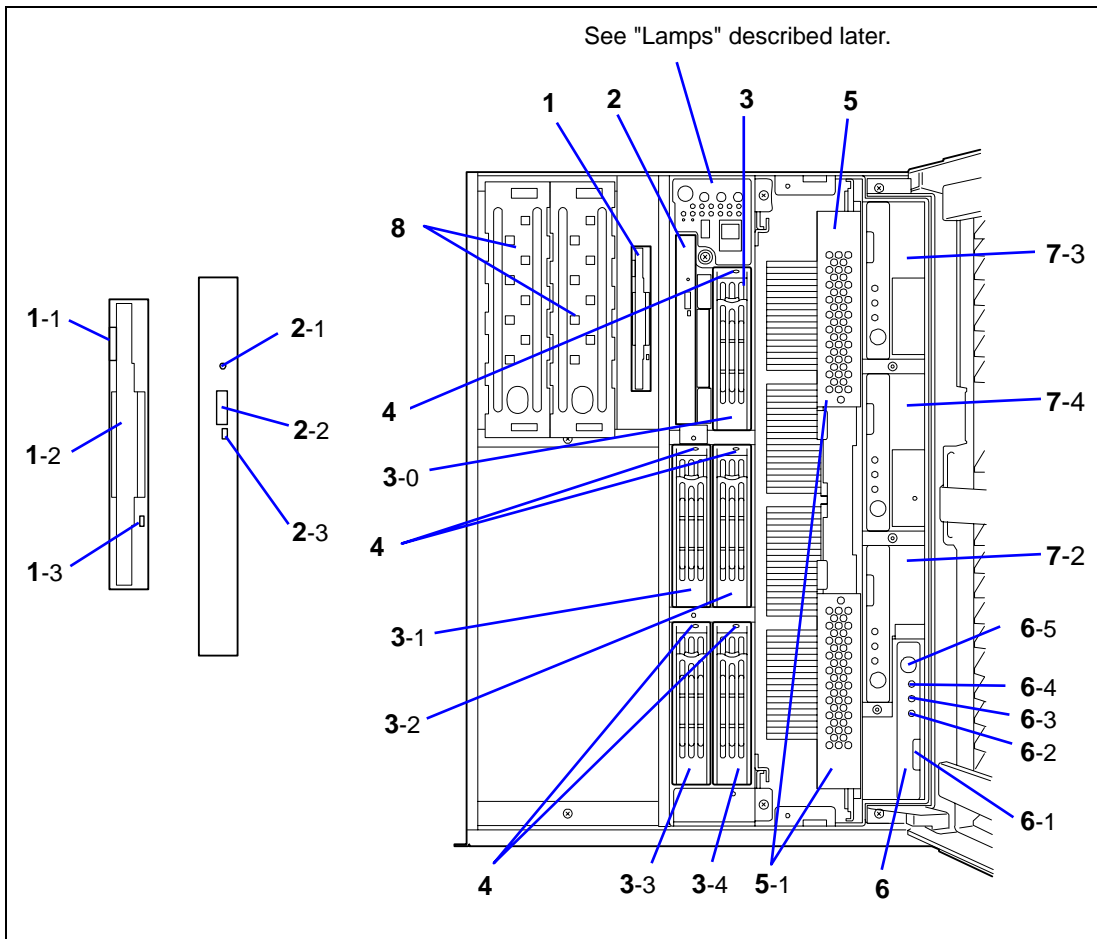

1 3.5-inch floppy disk drive

Insert a 3.5-inch floppy disk to the 3.5-inch floppy disk drive to read data from the disk or write data to the disk.

1-1: Eject button

1-2: Disk slot

1-3: Floppy disk access lamp (lits green when accessing)

2 CD-ROM drive

The CD-ROM drive reads data from the inserted CD-ROM.

2-1: Emergency eject hole - 2-2: CD Tray eject button - 2-3: Access lamp lits orange when accessing)

3 3.5-inch disk bay

The 3.5-inch hard disk bay contains additional hard disk slots. Hard disk drives having the thickness of 1 inch can be inserted into the slots. The number following the bold-faced character indicates the SCSI ID.

4 DISK lamp

5 Processor board

5-1: Processor board ejector

6 Memory board

6-1: Memory board ejector - 6-2: Memory board power lamp - 6-3: Memory board attention lamp

6-4: Memory board redundancy lamp - 6-5: Memory board attention switch

7 Additional memory board slot

The number following the bold-faced character indicates the slot number.

Additional memory board shall be installed in the slot #2, #3, and then #4 in this order.

8 5.25-inch device bay

DAT (digital audio tape) drive or optical disk drive may be installed in the 5.25-inch device bays. Slot #1 (right) and slot #2 (left).

9 Additional 3.5-inch disk bay

Install the optional HotSwap HDD cage 3-drive SCSI Media Bay in this bay. With the cage, up to thirteen hard disk drives can be connected to the server.

Front View (Switch and LED Panel)

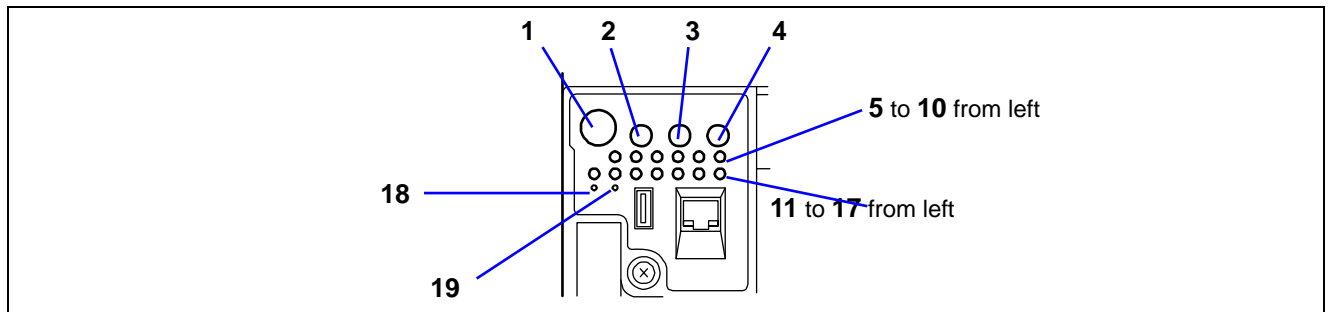

- 1 POWER switch**
The power switch is used to turn on/off the power. If you press the switch once, then the POWER/SLEEP lamp goes on and the power is turned on. If you press the switch again, the power is turned off. The system is forcibly shut down when the power switch is pressed continuously for four seconds or longer.
- 2 RESET switch**
The reset switch is used to reset the server.
- 3 SLEEP switch**
If you press the sleep switch once, the server enters into the sleep state (power saving mode). If you press the switch again, the server recovers to the normal state. Windows Server 2003/Windows 2000 support this feature.
- 4 UID (Unit ID) switch**
Pressing the UID switch turns UID lamp (blue) located on the front panel and the rear panel on and off.
- 5 POWER/SLEEP lamp**
- 6 STATUS lamp**
- 7 DISK ACCESS lamp**
- 8 LAN1 access lamp**
- 9 LAN2 access lamp**
- 10 UID (Unit ID lamp)**
- 11 DUMP lamp**
- 12 Processor board error lamp**
- 13 Memory board error lamp**
- 14 I/O board error lamp**
- 15 Power unit error lamp**
- 16 Fan error lamp**
- 17 Thermal error lamp**
- 18 DUMP switch**
The dump switch is used to collect the event logs having occurred in the server.
- 19 CLEAR switch**

Rear View

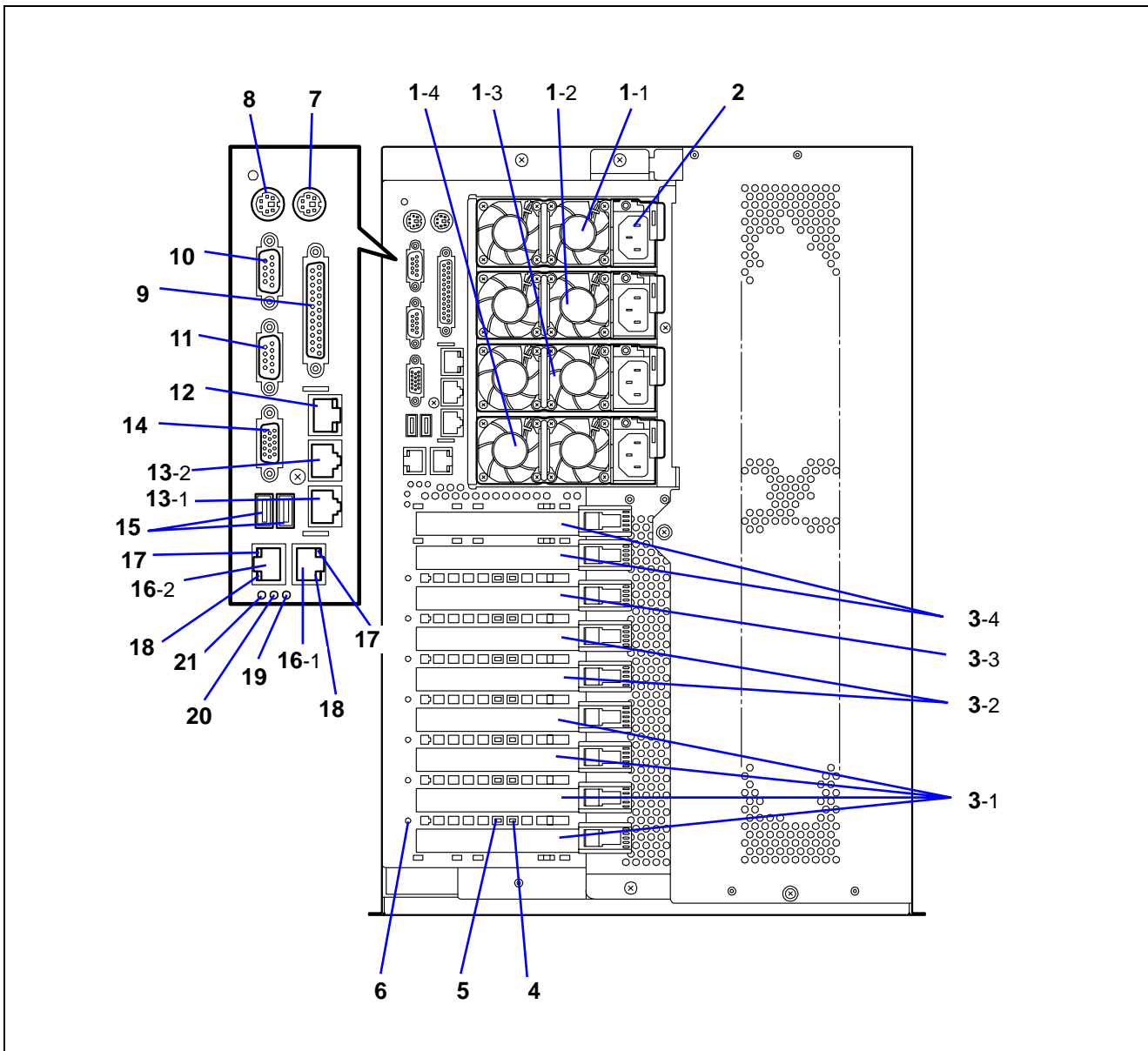

- 1 Power supply unit**

The power supply unit supplies DC powers to the server. The factory-installed power supply units are installed in slots 1 and 2 and slots 3 and 4 are for optional power supply units for power redundant configuration.
- 2 AC inlet**

The AC inlet is connected with the power cord. Each power supply unit has one socket. Use the provided power cord.
- 3 Additional PCI board slot**

3-1: 64bit/100MHz, hot-plug PCI-X
3-2: Hot-plug PCI-Express (x8)
3-3: Non-hot-plug PCI-Express (x4)
3-4: 32-bit/33MHz, non-hot-plug PCI
- 4 PCI slot Fault lamp**
- 5 PCI slot POWER lamp**
- 6 PCI slot error lamp**
- 7 Mouse connector**

Used to connect the optional mouse.
- 8 Keyboard connector**

Used to connect the optional keyboard.
- 9 Printer port connector**

Used to connect a printer with Centronics interface.
- 10 Serial port A connector**

Serial port A connector is used to connect the server to a device with serial interface. The server cannot be directly connected to a leased line through this connector.
- 11 Serial port B connector**

To be used exclusively with the serial port B connector on the front panel.
- 12 Management LAN Port**
- 13 ICMB connector**

Used to connect a device having ICMB interface. The number following the bold-faced character shows the port number.
- 14 Monitor connector**

Used to connect the display unit.
- 15 USB connector**

Used to connect a device with USB interface.
- 16 LAN connector**

Used to connect a network system on LAN.
The number following the bold-faced character shows the port number.
- 17 LINK/ACT lamp**
- 18 1000/100/10 lamp**
- 19 BMC error lamp**
- 20 Processor board error lamp**
- 21 I/O board error lamp**

Internal View

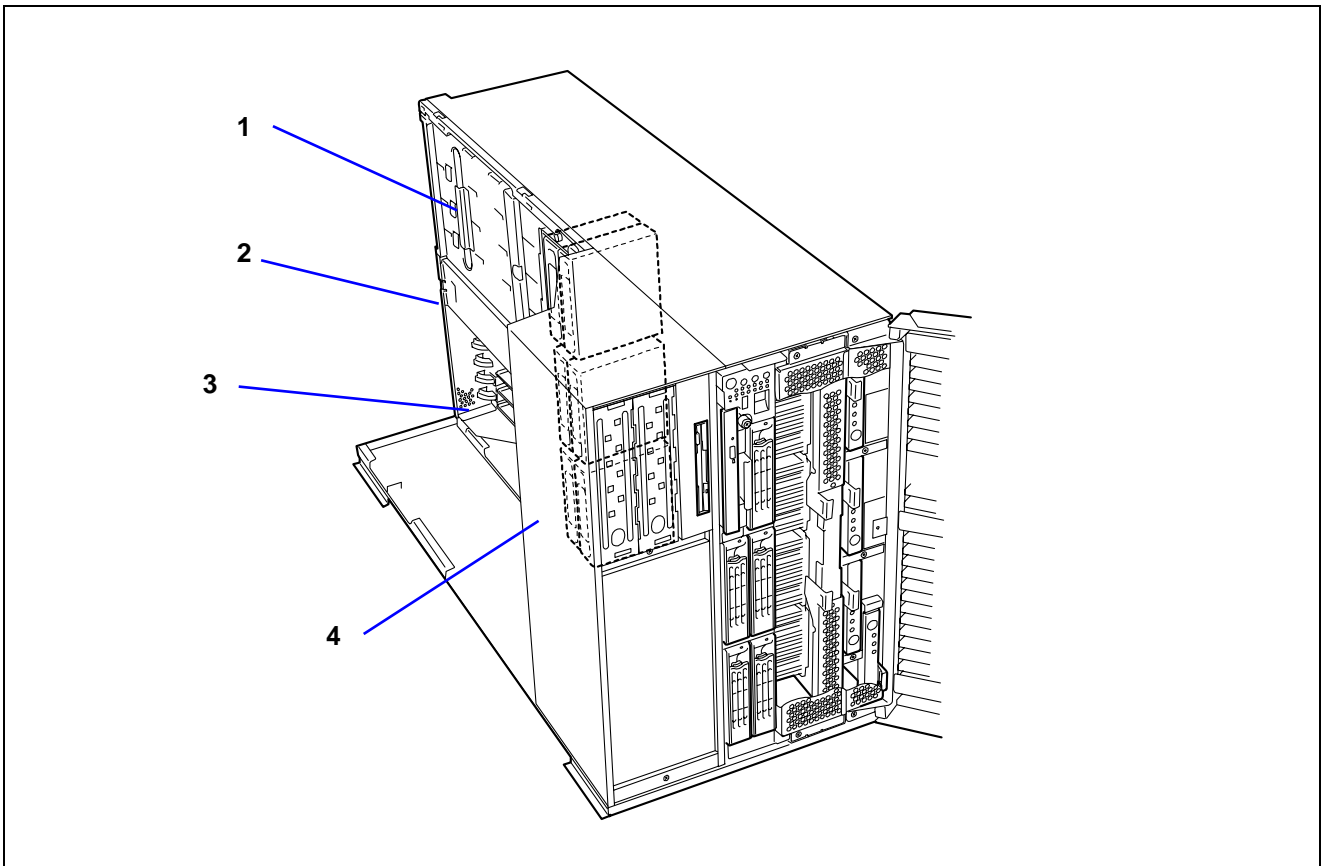

- 1 Power supply cage
- 2 Non-hot-plug PCI slot
- 3 Hot-plug PCI slot
- 4 Fan bay

I/O Board

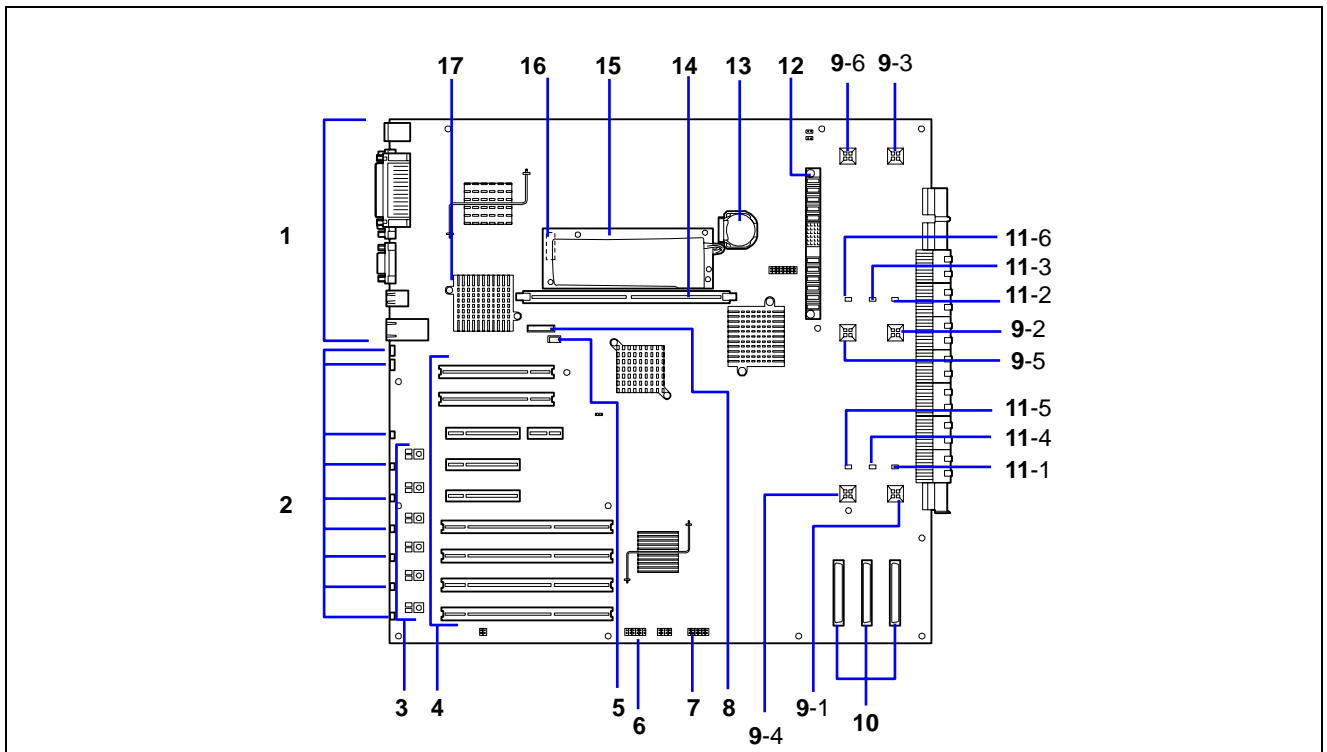

- 1 Connectors for external devices**
- 2 PCI slot error lamp** (corresponds to PCI slots #1 to #9 from top)
- 3 PCI slot power lamp (upper) / PCI slot Fault lamp (lower)**
(corresponds to PCI slots #4 to #9 from top)
- 4 PCI board slot** (PCI slots #1 to #9 from top)
Slots 1, 2: Non-hot-plug PCI, 5V, 33MHz Slots 4 and 5: (Hot-plug PCI-Express (x8)
Slot 3: Non-hot-plug PCI-Express (x4) Slots 6 to 9: Hot-plug PCI-X, 3.3V, 100MHz
- 5 IPMB connector**
- 6 BMC configuration jumper block**
- 7 Jumper switch for CMOS/Password clear**
- 8 Management LAN board connector**
- 9 Fan connector**
Number following the bold-faced number indicates port number.
- 10 SCSI connector**
Ch-2, Ch-1, and HDD cage from left
- 11 Fan error lamp**
Number following the bold-faced number indicates fan number.
- 12 Power BP connector**
- 13 Lithium battery**
- 14 DIMM connector for RAID**
- 15 NiMH battery module for RAID**
- 16 Battery module connector**
- 17 LAN controller**

Processor Board

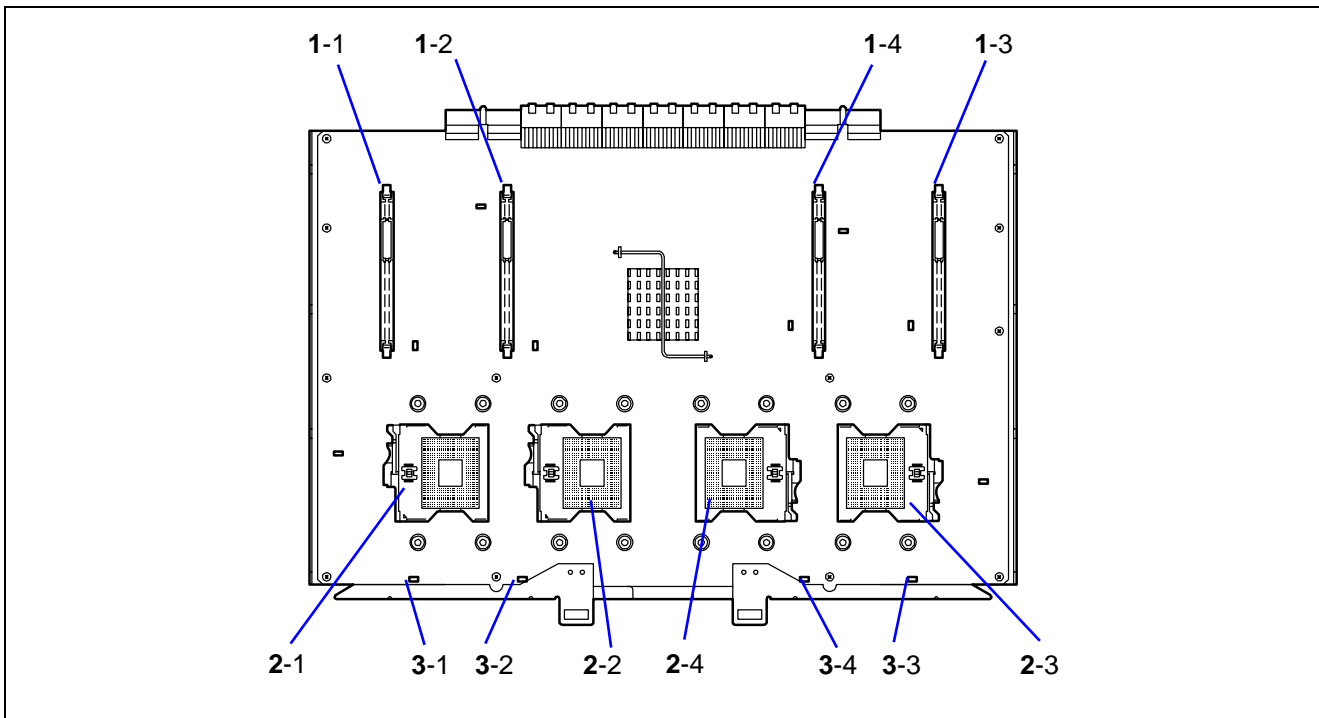

- 1 **VRM** (Number following the bold-faced character indicates the socket number.)
- 2 **Processor** (Number following the bold-faced character indicates the socket number.)
- 3 **Processor/VRM error lamp**
(Number following the bold-faced character indicates the lamp number.)

Memory Board

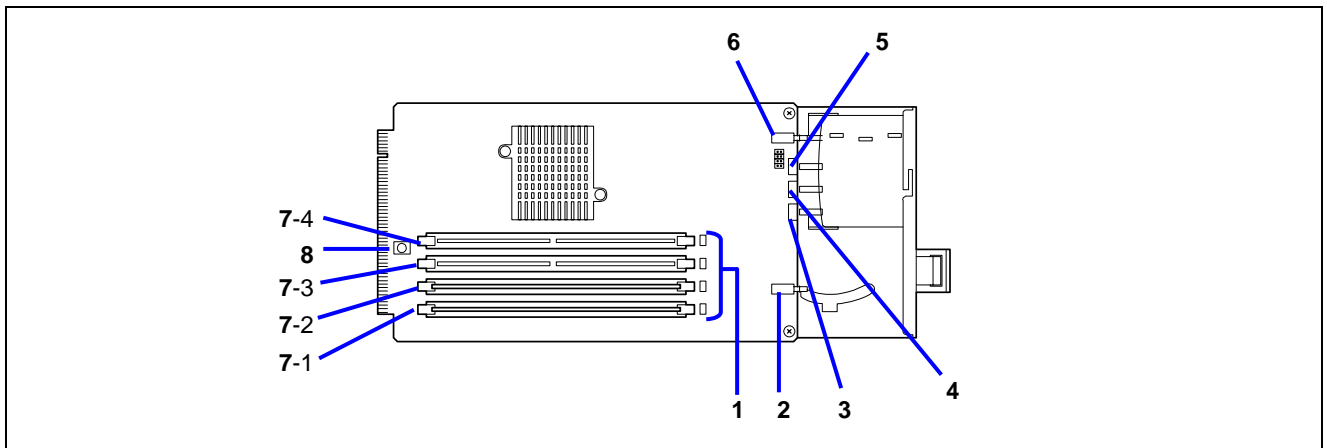

- 1 **DIMM slot error lamp** (DIMM slot #1 to 4 from bottom)
- 2 **Memory board Eject switch**
- 3 **Memory board Power lamp**
- 4 **Memory board Attention lamp**
- 5 **Memory board Redundancy lamp**
- 6 **Memory board Attention switch**
- 7 **DIMM slot** (Number following the bold-faced character indicates the socket number.)
The factory-installed memory board contains at least 2 x 512MB DIMM in slots 1 and 2.
- 8 **Switch to turn on DIMM slot error lamp**

Management LAN Board

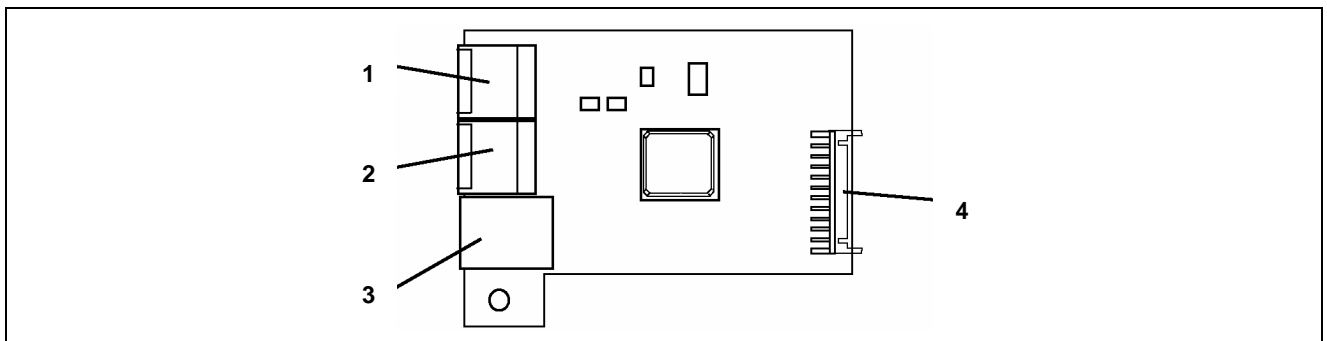

- 1 **ICMB #1 connector**
- 2 **ICMB #2 connector**
- 3 **Management LAN Port**
- 4 **I/O board connector**

STANDARD FEATURES

High performance

- 64-bit Intel® Xeon™ Processor MP
3.16GHz/1MB
3.66GHz/1MB
3.33GHz/8MB (on specific configurations only)
- High-speed memory access
(Supports DDRII 400-compliant interleaved memory)
- High-speed 1000BASE-T/
100BASE-TX/10BASE-T interface
(1000Mbps/100Mbps/10Mbps supported)
- High-speed disk access
(Ultra320 SCSI x 2)

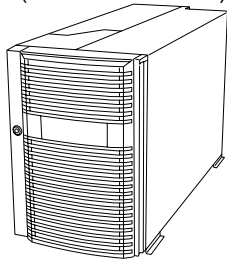

Expandability

- Wide variety of optional I/O slots
Two 32-bit/33 MHz PCI slots
Four 64-bit/100 MHz PCI-X slots (support hot-plug)
Two PCI EXPRESS(x8) slots (support hot-plug),
One PCI EXPRESS(x4) slot.
- Large memory of up to 32 GB
- 3.5-inch hard disk drive bay holds five hot-swap SCSI hard disk drives. If additional hard disk drive cage is installed, system can support up to 13 hot-swap SCSI hard disk drives.
- Remote power-on feature
- Up to four multi-processors are available for upgrade.
- USB interface

Many Available Features

- Graphic accelerator "Radeon7000M" support
- El Torito Bootable CD-ROM (no emulation mode) format support
- POWER switch mask
- Software power-off
- Remote power-on feature
- AC-LINK feature
- Intelligent Platform Management Interface (IPMI) feature
- Baseboard Management Controller (BMC)
- Remote console feature

High-reliability

- Memory mirroring feature
- Online sparing memory feature
- Memory hot-swap feature
- MemoryRAID feature
- Memory monitoring feature (single-bit error correction/ double-bit error detection)
- Memory/processor degradation feature
(logical isolation of a failed device)
- Bus parity error detection
- Thermal sensor
- Error notification
- Internal cooling fan monitoring feature
- Internal voltage monitoring feature
- BIOS password feature
- Security feature (security lock)
- Redundant power supply
- Disk array (onboard)
- Recovering BIOS Data

Management Utilities

- ESMPRO
- DianaScope
- Advanced Remote Management

Self-diagnosis

- Power On Self-Test (POST)
- Test and Diagnosis (T&D)

Maintenance Features

- Off-line Maintenance Utility
- Memory dump feature using the DUMP switch

Power Saving Feature

- Sleep feature (available for Windows Server 2003/Windows 2000)

Easy and Fine Setup

- EXPRESSBUILDER (system setup utility)
- Express Setup
- Configuration Diskette Creator
- SETUP (BIOS setup utility)
- SCSI Configuration Utility (SCSI device utility)

Power Supplies

When the additional power supply units are installed and system operates with four power supply units, the server can continue its operation without interruption even if one of these power supply units fails (in the redundant configuration).

If an additional power supply unit is installed while the system is operating with three power supply units, a log that represents "power recovery" is recorded in the system event log. This indicates that the power supply is in redundant configuration and maximum configuration.

Peripheral Bays

The system supports a variety of standard PC AT-compatible peripheral devices. The chassis includes the following peripheral bays:

- Media bay for installing the standard 3.5-inch floppy disk drive (supports 720 KB and 1.44 MB floppy disk media) and the standard CD-ROM drive.
- A 5.25-inch device bay for installing up to two half-height 5.25-inch peripheral devices or a full-height 5.25-inch peripheral device such as an optional tape drive.
- The SCSI hard disk drive bay for installing up to five SCSI hard disk drives. If you install the additional hard disk drive cage, you can install up to thirteen SCSI hard disk drives.
- The SCSI disk drives can be easily installed or removed. The drive carrier allows you to access to disk drives from the front of the system. If disk drives are provided with RAID configuration within the system, a disk drive can be swapped with another without power interruption in the system (hot-swap).

NOTE: The SCSI hard disk drive bays contain a hot-swap back plane that requires an 80-pin single connector attachment (SCA) connector on the drives that you install.

Memory Mirroring / Memory RAID Feature

Memory Mirroring Feature

The memory mirroring feature places a memory board as spare memory in standby state. If the current memory board encounters an uncorrectable error, the memory mirroring feature switches to the standby memory board. When this feature is used, the current memory board and the standby memory board should be combined. Available combinations are:

- Mirroring with memory boards 1 and 2
- Mirroring with a pair of memory boards 1 and 2 and a pair of memory boards 3 and 4

To enable the memory mirroring feature, the combined memory boards must have DIMMs of same capacity.

The table below shows combinations of memory boards installed.

	Memory board 1	Memory board 2	Memory board 3	Memory board 4
A	2GB (1GB*2)	2GB (1GB*2)	2GB (1GB*2)	2GB (1GB*2)
B	8GB (2GB*4)	8GB (2GB*4)	8GB (2GB*4)	8GB (2GB*4)
C	4GB (1GB*4)	4GB (1GB*4)	–	–

Memory RAID Feature

If one of the four memory boards encounters an uncorrectable error, the memory RAID feature switches to the other memory board to continue operation. To use this feature, four memory boards must be installed. Each memory board must have DIMMs of same capacity.

The table below shows combinations of memory boards installed.

	Memory board 1	Memory board 2	Memory board 3	Memory board 4
A	2GB (1GB*2)	2GB (1GB*2)	2GB (1GB*2)	2GB (1GB*2)
B	8GB (2GB*4)	8GB (2GB*4)	8GB (2GB*4)	8GB (2GB*4)
C	4GB (1GB*4)	4GB (1GB*4)	4GB (1GB*4)	4GB (1GB*4)

Setting BIOS

Start SETUP and select [Advanced] → [Memory Configuration] → [Memory RAS Feature] in order and set as follows:

- To enable the memory mirroring feature: Select [Mirror].
- To enable the memory RAID feature: Select [RAID].

Others

- Memory capacity displayed on the operating system = total capacity of physically installed memory – capacity for standby memory
Memory mirroring feature: 1/2 of actually installed memory capacity
Memory RAID feature: 3/4 of actually installed memory capacity
- Enabling the memory mirroring or memory RAID feature does not influence the operations of applications.
- Each feature is automatically disabled when an error message is displayed:

The following indicates that the memory mirroring /memory RAID feature has worked:

- a) The Redundancy lamp on the front panel of the server lights green.
- b) The failing DIMM group is degraded when the server restarts.
- c) If an ESMPRO Agent has been installed, the following log is registered as a system log of Event Viewer:
 - Source name: ESMCommonService
 - Event ID: 2313
 - Explanation: Part of the DIMM was isolated due to a memory error.

Memory number: XX

Date/time: XX

- d) If report setting is made through the ESMPRO Agent, Manager reporting and ALIVE reporting is performed. The report contents are as follows:

Explanation: Part of the DIMM was isolated due to a memory error.

Memory number: XX

Date/time: XX

Recovering BIOS Data

Two system BIOSes, primary and secondary, are used to realize the duplex configuration.

Normally, the system operates with the primary BIOS. If a primary BIOS data error occurs or if the device containing the system BIOS fails, control is immediately transferred to the secondary BIOS. Thus, the activation of the system is ensured.

At shipment, the latest version of system BIOS is stored both in the primary and the secondary BIOS. If you execute the system BIOS update, the secondary BIOS is updated, and the updated BIOS becomes the primary BIOS. Thereafter, the system is activated from that primary BIOS.

SAF-TE Logic

The SCSI backplane includes SAF-TE (SCSI Accessed Fault Tolerant Enclosure) logic that provides an interface to the disk subsystem that supports status signals, hot swapping drives, and enclosure monitoring.

The transport mechanism for the standardized alert detection and status reporting is the SCSI bus. Disk drives, power supplies, cooling fans, and temperature are continually monitored and the conditions then reported over the SCSI bus to the system. When used with RAID management software the user can be alerted of impending or imminent disk conditions requiring attention. This allows the user to react to conditions that could normally go unnoticed until data loss.

System Cooling

The chassis includes a hot-swappable fan module with six fans for cooling the processor(s), hard drives, and PCI cards. The fan system is located in the middle of the chassis to pull cooling air through the chassis.

System Board Features

The following subsections describe the system board major components.

Processor

The processor board accommodates one to four 64-bit Intel® Xeon™ MP processors with 1 MB cache in an FC-PGA2 package.

DIMM Memory

To install or replace a DIMM, remove the memory board first.

One memory board is factory-installed in the server. Up to four memory boards (32 GB maximum) can be installed in the server.

Install the DIMM (Dual Inline Memory Module) into the DIMM socket on the memory board of the server. DIMMs are installed in the ascending order of DIMM socket numbers in the unit of two modules.

The controller automatically detects, sizes, and initializes the memory array, depending on the type, size, and speed of the installed DIMMs, and reports memory size and allocation to the server via configuration registers.

NOTE: Use DIMMs that have been provided by us. Contact your service representative or dealer for a current list of approved memory modules.

Onboard Video

The I/O board incorporates an ATI® Radeon® 7000M graphics accelerator with 16 MB of video SDRAM that supports all standard IBM VGA modes. The embedded SVGA video subsystem supports:

- Pixel resolutions up to 1024 × 768
- CRT and LCD monitors up to 100 Hz vertical refresh rate

The I/O board supports disabling of the onboard video through BIOS Setup or when a plug-in video card is installed in any of the PCI slots.

On Board RAID Controller

The I/O board includes an on-board RAID controller, which is composed of NQ80332 I/O processor and 53C1030 SCSI host adapter. The on-board RAID controller supports the following features:

- Dual-channel Ultra320 SCSI interface (CH0 and CH1)
Connect the HDD cage to CH0, and HDD cage or tape device to CH1.
- RAID levels 0, 1, 5, and spanning of RAID1 and RAID5
- 256 MB of cache memory
- Battery-backup cache memory

Network Interface Controllers

NOTE: To ensure EMC product regulation compliance, the system must be used with shielded LAN cables.

The I/O board includes Intel® 82546GB network interface controller (NIC). The Intel® 82546GB network interface controller supports the following features:

- Two channels of 10Base-T, 100Base-TX, and 1000BASE-T networks.
- Direct 64-bit, 133 MHz interface to the PCI-X bus
- 82546GB provides standard IEEE 802.3 Ethernet Interface for 1000Base-T, 100Base-TX, and 10Base-T (802.3, 802.3u, 802.3ab).

System Board Management Controller (BMC)

Server management is concentrated in the System Board Management Controller (BMC). The BMC and associated circuitry are powered from a 5Vdc standby voltage, which remains active when system power is switched off, but the AC power source is still on and connected.

The BMC supports DianaScope, which allows remote server management through networks.

See Chapter 6 or online document in the EXPRESSBUILDER CD-ROM for DianaScope.

One major function of the BMC is to autonomously monitor system management events, and log their occurrence in the non-volatile System Event Log (SEL). The events being monitored include overheating and overvoltage conditions, fan failure, or chassis intrusion. To enable accurate monitoring, the BMC maintains the non-volatile Sensor Data Record (SDR), from which sensor information can be retrieved. The BMC provides an ISA host interface to SDR sensor information, so that software running on the server can poll and retrieve the server's current status.

The BMC performs the following:

- Monitors server board temperature and voltage
- Monitors processor presence and controls Fault Resilient Boot (FRB)
- Detects and indicates fan failure
- Manages the SEL interface
- Manages the SDR Repository interface
- Monitors the SDR/SEL timestamp clock
- Monitors the system management watchdog timer
- Monitors the periodic SMI timer
- Monitors the event receiver
- Controls secure mode, including video blanking, diskette write-protect monitoring, and front panel lock/unlock initiation
- Controls Wake On LAN via Magic Packet support.

Degradation Feature

The degradation feature automatically isolates a failed DIMM, processor, or cooling fan to assure continuous operation of the server when the POST (Power On Self-Test, self-diagnosis program after power on) detects such a DIMM, processor, or cooling fan.

Failed DIMMs, processors, and cooling fans may be identified on the screen that the POST displays, or with the BIOS setup utility, "SETUP." They may also be identified on the system that has ESMPRO installed.

Remote Power-On Feature (Wake On LAN/PME)

The remote power-on function turns on the server through a network. It sends a special packet from the management computer to a remote server to turn it on if the server is off-powered.

To enable this feature, you must select "Enabled" for "Wake On LAN/PME" in the Advanced Chipset Control of the Advanced menu of the BIOS setup utility, "SETUP." (See Chapter 4.)

The remote power-on feature is not available in the following cases. Press the POWER switch once to start the operating system, and turn off the server in an appropriate procedure.

- Abnormal previous system shut-down
- No power supply to the server (due to turned-off breaker, disconnected power cord, power blackout, etc.)

NOTE: Wake On LAN feature is supported in 100BASE-TX/1000BASE-T adapter on the I/O board.

AC-LINK Feature

When the power cord of the server is connected to an uninterruptible power supply (UPS) unit, the server supports the power linkage feature that enables control over the power supply from the UPS to the server. AC-LINK feature can be enabled or disabled with "AC-LINK" in the Server menu of the BIOS setup utility, "SETUP." (See Chapter 4.)

Security

To help prevent unauthorized entry or use of the system, the system includes a full lockable front door and Server Management software that monitors the system intrusion switches.

Security with Mechanical Locks and Monitoring

The front door of the server contains a mechanical lock to prevent access to the front of the computer chassis.

The server includes an intrusion switch for the rear access cover. When this cover is opened, the switch transmits an alarm signal to the system board, where server management software processes the signal.

Software Locks via the System Setup Utility

The BIOS SETUP Utility provides a number of security features to prevent unauthorized or accidental access to the system. Once the security measures are enabled, access to the system is allowed only after the user enters the correct password(s). For example:

- Enable the keyboard lockout timer so that the server requires a password to reactivate the keyboard and mouse after a specified time-out period – 2 to 120 minutes.
- Set and enable an administrative password.
- Set and enable a user password
- Set secure mode to prevent keyboard or mouse input and to prevent use of the front panel reset, power and sleep switches.
- Activate a hot-key combination to enter secure mode quickly.
- Disable writing to the floppy disk drive when secure mode is set.

EXPRESSBUILDER

The CD-ROM that comes with your server contains a setup utility called " EXPRESSBUILDER." When you have first installed the server or append features to the server, use the EXPRESSBUILDER to set up your server.

Refer to Chapter 6 for details.

The major functions of the EXPRESSBUILDER are:

- To install the Operating System.

"Express Setup" helps you to install Windows system. (See Chapter 5)

- To diagnose the system.

EXPRESSBUILDER includes the System Diagnostics to check your server. (See Chapter 6)

- To create a support disk.

Use this function to create the support disks used to boot the utilities from the floppy disk, or the OEM floppy disk used for a manual installation of Windows. (See Chapter 6)

- To update the BIOS.

Use this function to update the system BIOS or firmware of the server. (See Chapter 6)

- To update the Windows System*

"Update Express5800 System" in Master Control Menu (Windows-based EXPRESSBUILDER feature) updates several resources of Microsoft® Windows Server™ 2003 or Microsoft® Windows® 2000. (See Chapter 6)

- To install the utilities.

EXPRESSBUILDER CD-ROM includes some management software for Windows (ESMPRO, DianaScope, etc.) and maintenance utilities for DOS (System diagnostics, Off-line Maintenance Utility, etc.).

You can install the applications for Windows from Master Control Menu and install the utilities for DOS from Tools menu. (See Chapter 6)

- To read the online documents*

You can refer to the online documents from Master Control Menu. (See Chapter 6)

NOTE: Some features among those listed above can be used from the remote computer via cross cable, modem, or LAN (remote console). See Chapter 6 for details.

* These functions are available under Windows system.

ESMPRO

ESMPRO is a server management software application that runs on the operating system. ESMPRO includes ESMPRO Manager for the server monitoring terminal and ESMPRO Agent for the server.

NOTE: For details of major functions of ESMPRO, system configuration and setups with ESMPRO, see Chapter 6.
Available functions of ESMPRO depend on the operating system you install. Ask your service representative for details.

Off-line Maintenance Utility

The Off-line Maintenance Utility is used for proactive maintenance and fault analysis of the server. Normally this utility is used by the maintenance engineer.

Refer to Chapter 8 for details.

System Diagnostic Utility

The system diagnostic utility contained in EXPRESSBUILDER is useful to prevent hardware failures. See Chapter 7 for details.

DianaScope

DianaScope is a software application for remote management of the Express5800 series.

DianaScope can control the managed server even if operating system is not running on the managed server.

See Chapter 6 and online documentation in the EXPRESSBUILDER.

USING YOUR SERVER

This section describes basic operations of your server including how to use devices such as floppy disk drive and CD-ROM drive. See Appendix B for notes on using the floppy disk, CD-ROM, and accessories including keyboard and mouse.

Security Lock (Locking the Front Cover)

The security lock on the front of the server is used to lock the front door.

Open the front door when turning on/off the server, accessing the floppy disk drive, CD-ROM drive, and/or 5.25-inch device, and installing/removing the hard disk drive into/from the 3.5-inch disk bay.

IMPORTANT:

- Use the security key coming with the server to release the security lock.
- Some software applications have a command to eject a media in the CD-ROM drive or 5.25-inch device bay. Make sure that the front door is open before executing such a command. If the command is executed while the front door is closed, the tray of the CD-ROM drive or a media in the 5.25-inch device will strike the front door causing the server failure.

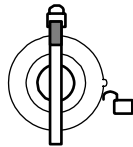

Lock the front door

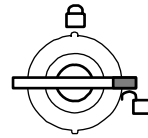

Unlock the front door.

Unlock the front door, hold the handle half height on the left side of the front door and pull it toward you to open. When you close the front door, lock it with security key.

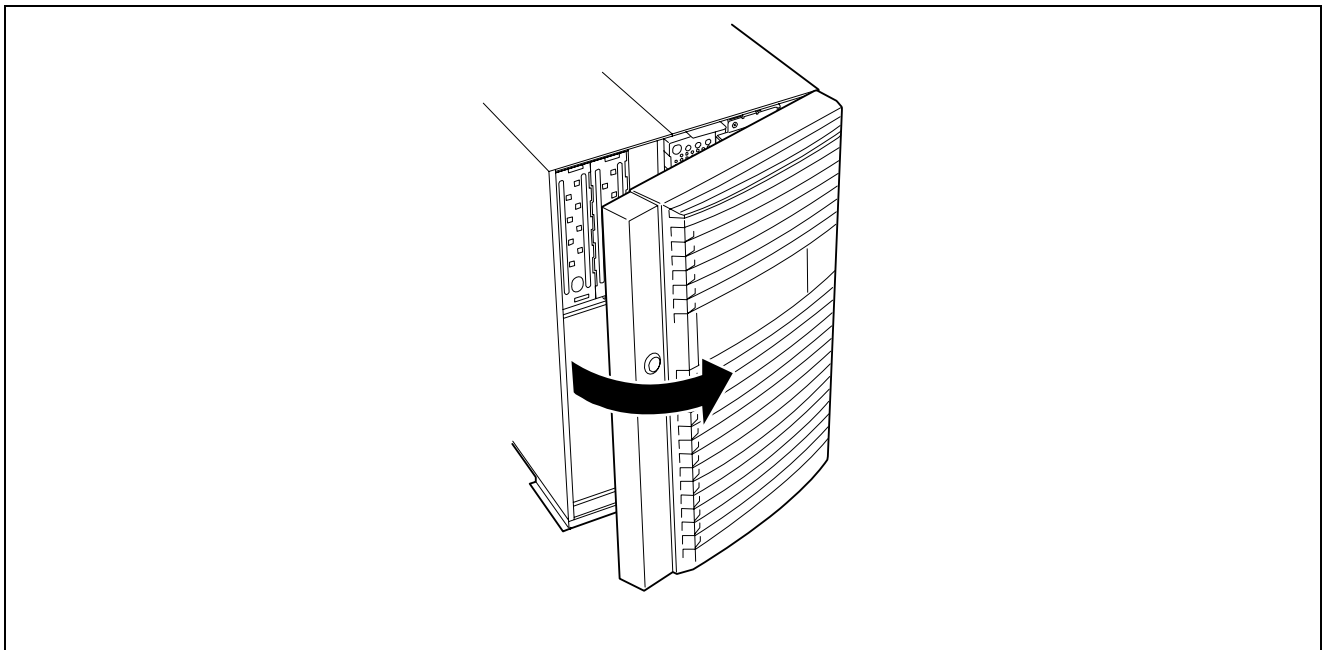

POWER Switch

Use the POWER switch to turn on/off the server.

Power On

Press the POWER switch on the front of the computer chassis.

The POWER/SLEEP lamp lights green.

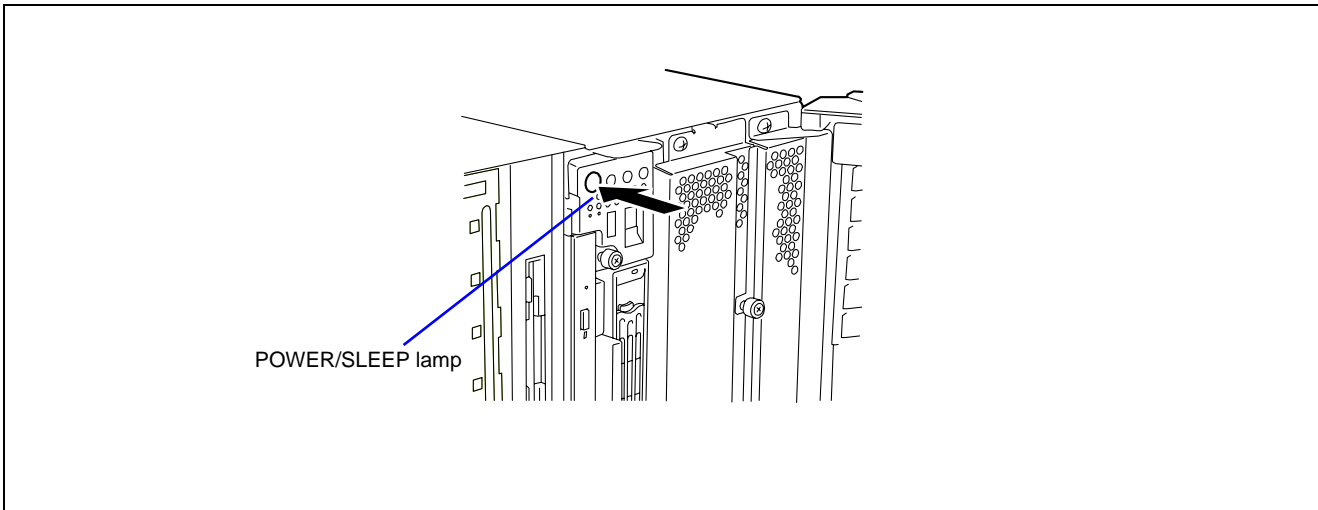

IMPORTANT:

- If the power cord is connected to a power control device such as a UPS (Uninterruptible Power Supply), make sure that the power control device is powered.
 - If the power cord is connected to the server, an initial diagnosis of the hardware starts. The POWER switch does not work while in diagnosis. Wait for about 30 seconds, then press the POWER switch.
 - Do not turn off the server until characters following our logo appear on the screen. The time until the characters appear depends on your system configuration. Approximately, it may take one to five minutes.
-

POST

POST (Power On Self-Test) is the self-diagnosis feature saved in the I/O board of the server.

When the power of the server is turned on, POST automatically runs to check the I/O board, memory board, processor, keyboard, and mouse. During POST messages indicating the starts of several BIOS setup utilities may also appear.

At shipment of the server, it is set to have our logo appear on the display unit during POST. Pressing **Esc** allows the information on the execution of POST to be displayed.

NOTE: The information on the result of diagnosis by POST can be displayed from the start without the depression of **Esc** on the BIOS menu. If you desire it, change the setting of "Boot-time Diagnosis Screen" on "Advanced" of the BIOS SETUP to "Enabled."

It may not always necessary to check the result of POST. Check the messages which may appear during POST in the following cases:

- Installation of the server

- Suspicion of failure
- Beep for many times in the period from power-on to operating system start
- Appearance of an error message on the display unit

POST Flow

The flow of operations executed by POST is sequentially described below:

IMPORTANT: Depending on the system configuration, the message "Press Any Key" requesting key entry may appear on the display screen. This is requested by BIOS on an installed optional board. See the explanation described in the manual for the option and press any key.

1. After power-on, POST is activated to start memory check. The message indicating the counted size of base memory and that of additional memory appears at the upper left corner of the display screen. In addition, the following message appears at the bottom of the screen.

Press <F2> to enter SETUP, <F4> Service Partition, <F12> Network

NOTE: If you change the factory-default for [Extended RAM Step] in [Advanced] menu of BIOS SETUP and execute the memory test, pressing **Space** allows the memory test to be skipped.

It may take several minutes to complete memory check depending on the size of the memory installed in the server. Similarly, it may take about a minute to display the proper information on the screen at rebooting.

2. Detects the RAID controller built in the server and displays the message prompting the start of the MegaRAID Configuration utility (without any key entry for several seconds, POST is automatically continued). Press the proper keys according to the screen display.

```

LSI MegaRAID BIOS                Version XXX (Build XXX XX XXXX)
Copyright(C) 2005 LSI Logic Corp.
HA-X (Bus XX  Dev XX) MegaRAIS SCSI 320-2E
Standard FW XXXX DRAM = 256MB (SDRAM)
Battery module is present on adapter
Channel-0 ID-14 -- XXX  XXXXX
Channel-1 ID-14 -- XXX  XXXXX
X Logical Drive(s) found on the host adapter.
X Logical Drive(s) handled by BIOS
Press <Ctrl><M> or <Enter> to Run Config Utility
Or Press <Ctrl><H> for WebBIOS

```

Now press **Enter** to start the utility. Do not use **Ctrl + M** to start the utility.

For example, the SCSI BIOS setup utility must be used in the following cases:

- Installation of an SCSI device in the 5.25-inch device bay
- Connection of an external SCSI device (The removal of the SCSI cable for 5.25-inch device in the server and the connection of the SCSI cable coming with the server (for external connection) are required.)
- Modification of SCSI device connections within the server

When the SCSI BIOS setup utility is terminated, the server runs POST from its start again.

When more than one SCSI controller boards are installed on the PCI bus of the server, the messages indicating the starts of the SCSI BIOS setup utilities for the installed boards appear in the following order:

PCI slot number PCI #3, PCI #4, PCI #5, PCI #8, PCI #9, PCI #6, PCI #7, PCI #1 and PCI #2. See Chapter 9, List of Optional Devices and their Available Slots for details about boot priority.

- 3. Displays the SCSI ID numbers used by the connected SCSI devices on the screen.
- 4. If one or more disk array controllers are installed, displays the message prompting you to start the Disk Array BIOS setup utility.

Start the utility according to the message if you need to change the settings. Refer to the manuals of the disk array controllers for details.

Without any entry, any of the following messages appears.

Notes when pressing **Ctrl** and any other keys during POST:

When you press **Ctrl** and any other keys during POST to start configuration utility or others, the key entry rarely becomes invalid. If it occurs, press **Ctrl** again to resume the operation.

- 5. Displays the message notifying you the detection of the processor and the connected keyboard and mouse.
- 6. Displays any of the following messages.

Pattern 1:

Press <F2> to enter SETUP or <F12> to Network

Pattern 2:

Press <F2> to enter SETUP, <F4> Service Partition, <F12> to Network

Or Pattern 3:

Press <F1> to resume, <F2> to enter Setup, <F12> to Network

Pattern 4:

Press <F1> to resume, <F2> to enter Setup, <F4> Service Partition, <F12> Network

* The displayed message may vary depending on the device status.

NOTE: The operation or utility to be started at each key entry is described below. These operations or utilities may not always be started.

■ **Esc**

Press **Esc** to display the boot menu at the end of POST. This menu allows you to select the device to boot from.

Boot Menu
1. CD-ROM Drive
2. +Removable Devices
3. +Hard Drive
4. IBA GE Slot 0B20 v1222
5. IBA GE Slot 0B21 v1222
<Enter Setup>

■ **F2**

Press **F2** to start the BIOS setup utility. Start the utility to change the setting of the server to that fit to the environment in which the server is used. In general, the setting may not be particularly changed by starting the utility excluding the case in which the previous message accompanied by an error message appears. See Chapter 4 for setting procedures and features of the parameters.

■ **F4**

Press **F4** to start the Off-line Maintenance Utility from the maintenance partition. See Chapter 6 for the maintenance partition.

■ **F12**

Press **F12** to run the network boot.

■ F1

If message "Press <F1> to resume" appears, an error is detected during POST. See "Error messages during POST" for the information on the messages and the proper actions against the errors. If an error message appears, pressing **F1** allows the BIOS setup utility to be started.

7. When a password is set in the BIOS setup utility **SETUP**, the screen prompting you to enter the password appears after the normal termination of POST.

The password can be entered for up to three times. If you enter the password incorrectly all the time, the server cannot be started. In this case, turn off the power of the server, wait for about 10 seconds, and then turn on the power to start the server again.

IMPORTANT: Set the password only after operating system is installed.

8. Starts operating system at the termination of POST.

POST Error Messages

When POST detects an error, it displays an error message on the screen. See Chapter 8 for POST error codes.

IMPORTANT: Take a note on the messages displayed before contacting your service representative. Alarm messages are useful information for maintenance.

Power Off

Follow the procedure below to power off the server. If the power cord of the server is connected to a UPS, refer to the manual that comes with the UPS or the manual for the application that controls the UPS.

IMPORTANT: Always allow POST to complete before turning off the server.

1. Shut down the operating system.
2. Press the **POWER** switch on the front of the server.
The **POWER/SLEEP** lamp goes off.
3. Power off peripheral devices.

SLEEP Switch

The SLEEP switch allows you to save almost all power of the server (power-saving mode or sleep mode).

NOTE: To use the SLEEP switch, an operating system supporting the sleep feature is required. (Available for Windows Server 2003/Windows 2000.)

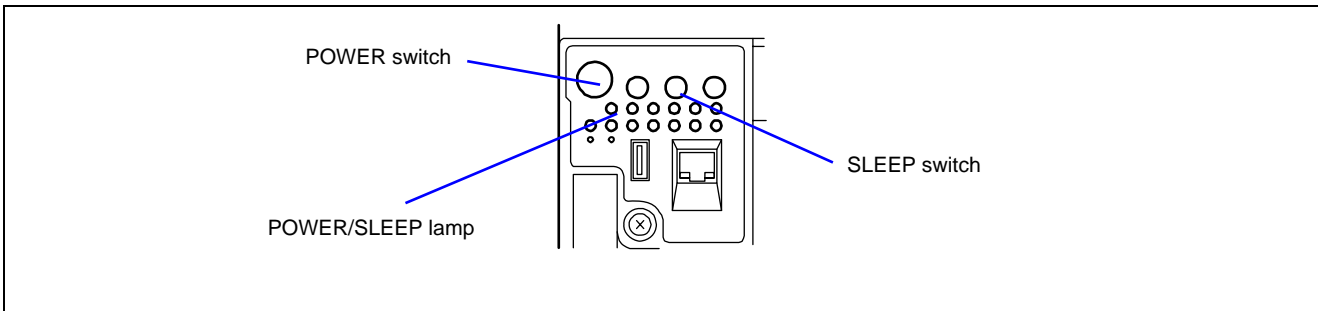

Press the SLEEP switch on the front of the server to place the server in the power-saving mode. (The POWER/SLEEP lamp blinks.) In the power-saving mode, the server retains the memory data and the status of the previous operations.

To resume the original state, press the POWER switch. (It may take a little time to resume the original state.)

NOTE: The operational level in the power-saving mode depends on the operating system in use. (Available for Windows 2000.)

IMPORTANT: Do not change system configuration while turning into the power-saving mode or in the power-saving mode. Otherwise, you may fail to resume the original state.

Floppy Disk Drive

Your server is equipped with the 3.5-inch floppy disk drive on its front to write/read data to/from a floppy disk.

Your server supports the following 3.5-inch floppy disks:

- 2HD floppy disk (double-sided high-density track type)
Stores data of 1.44 MB.
- 2DD floppy disk (double-sided double-density track type)
Store data of 720 KB.

Make sure that the server is powered (the POWER/SLEEP lamp is lit) before inserting a floppy disk into the floppy disk drive.

When you completely insert the floppy disk into the floppy disk drive, the drive clicks and the eject button on the floppy disk is slightly pushed out.

NOTES:

- You cannot use a 1.2 MB-formatted floppy disk.
 - When an unformatted floppy disk is inserted, the message notifying that data read is not available and the message prompting formatting are displayed. Refer to the manual that comes with the operating system to format the floppy disk.
 - If the floppy disk contains a system, powering on or restarting the server with the floppy disk inserted boots the system from the floppy disk.
-

To eject the floppy disk from the floppy disk drive, press the eject button.

NOTE: Make sure that the floppy disk access lamp is unlit before ejecting the floppy disk. Ejecting the disk when the access lamp is lit may destroy the disk data.

NOTE: Use of the floppy disk

The floppy disk is an important data storage media with delicate structure and requires care. Keep the following notes in mind to use it:

- Insert the floppy disk into the floppy disk drive gently as far as it goes.
- Attach the label to the correct position.
- Do not write anything directly onto the disk surface with a pencil or ball-point pen.
- Do not open the shutter.
- Do not use the floppy disk in a dusty place.
- Do not place anything on the floppy disk.
- Do not leave the floppy disk in a high-temperature place (e.g., place exposed to direct sunlight or close to a heater).
- Keep the floppy disk away from cigarette smoke.
- Keep the floppy disk away from any liquid (e.g., water) and chemicals.
- Keep the floppy disk away from any magnetic objects (e.g., magnet).
- Do not pinch the floppy disk with a paper clip or drop it.
- Keep the floppy disk in a floppy disk case that protects it from magnetism and dust.
- A floppy disk has a write-protect switch that prevents the stored data from accidental erasure. You can read data from a write-protected floppy disk, but you cannot save data into the floppy disk or format it. We recommend that you should write-protect any floppy disk containing valuable data unless you are about to save data. To write-protect a 3.5-inch floppy disk, use the write-protect switch provided on its back.

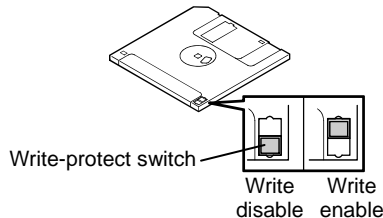

- The floppy disk is a very delicate storage media. Dust or thermal changes, as well as operator's misconduct or sever failures, may cause loss of data. To avoid loss of data, we recommend that you should make a back-up copy of your valuable data on a regular basis. (Make sure to make a back-up copy of every floppy disk provided with the server.)

CD-ROM Drive

Your server is equipped with the CD-ROM drive on its front to read data from a CD-ROM (read-only compact disk). The CD-ROM provides larger and faster data read than the floppy disk.

⚠ CAUTION



Observe the following instructions to use the server safely. Failure to follow these instructions may cause a fire, personal injury, or property damage. See pages 1-3 to 1-8 for details.

Do not leave the tray ejected from the CD-ROM drive.

Set a CD-ROM on the CD-ROM drive as follows:

1. Confirm that the power of the server is on (with the POWER/SLEEP lamp being lit green) before inserting the

CD-ROM in the CD-ROM drive.

2. Press the Eject button on the front of the CD-ROM drive.

The tray comes out a little.

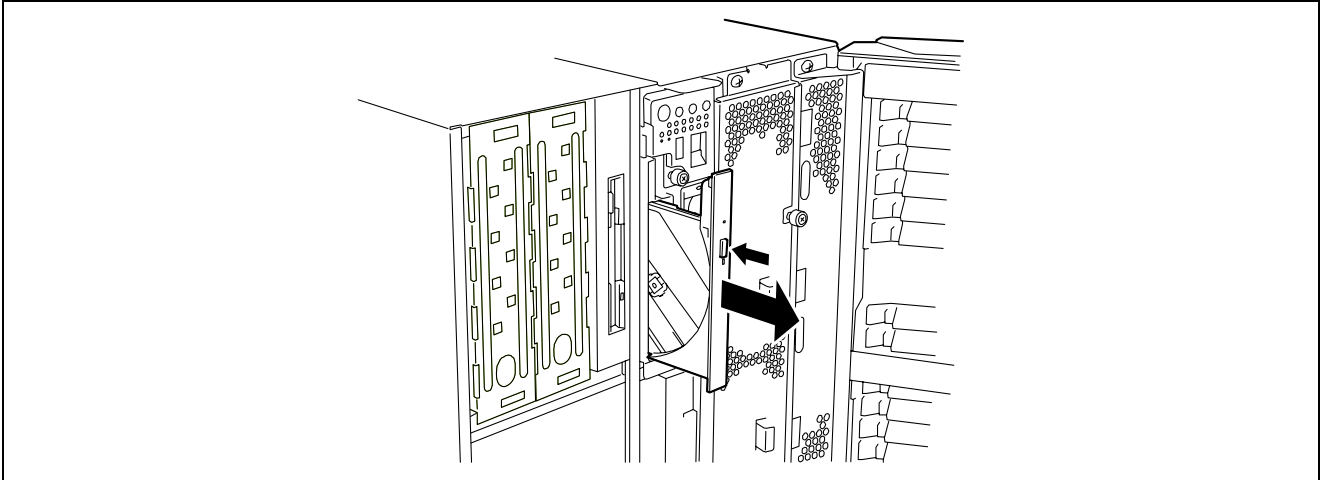

3. Hold the tray lightly and pull it out toward you until the tray stops.

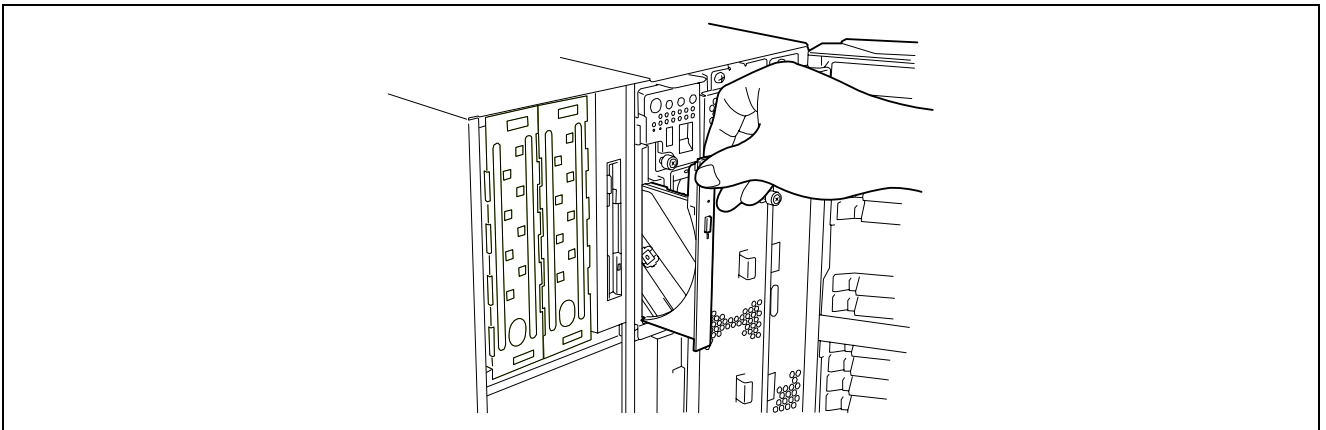

4. Put the CD-ROM on the tray carefully and securely with the data recorded surface facing toward the tray.
5. As shown in the figure below, hold the tray with a hand and press the CD-ROM with fingers of another hand to make the hole of the CD-ROM fit to the rotor at the centre of the tray.

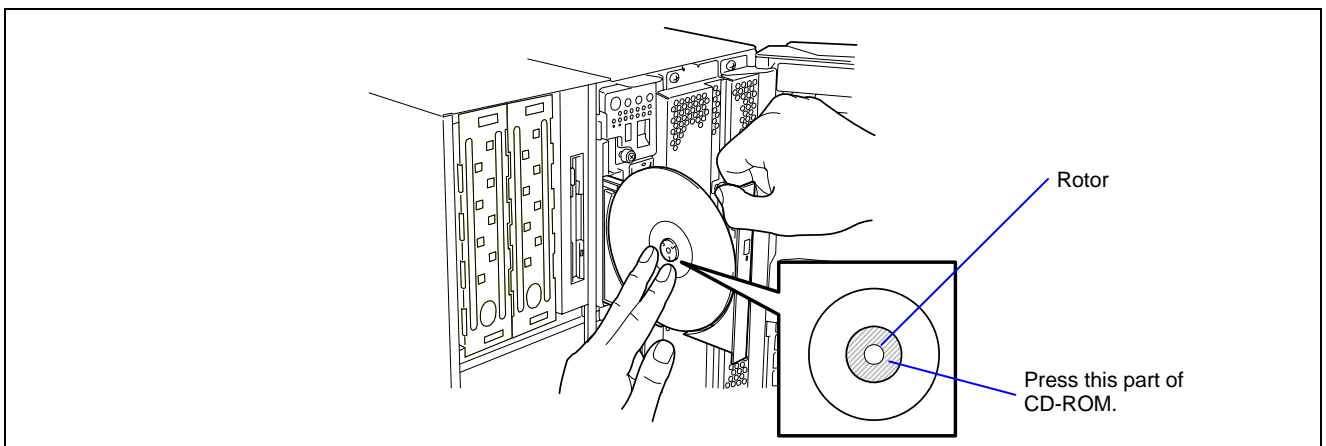

6. Push the front of the tray lightly to retract it into the drive.

IMPORTANT: If a noisy sound in driving the CD-ROM drive occurs after setting a CD-ROM, set it again correctly.

To take out the CD-ROM from the CD-ROM drive, press the Eject button in the similar way in setting the CD-ROM to make the tray go out.

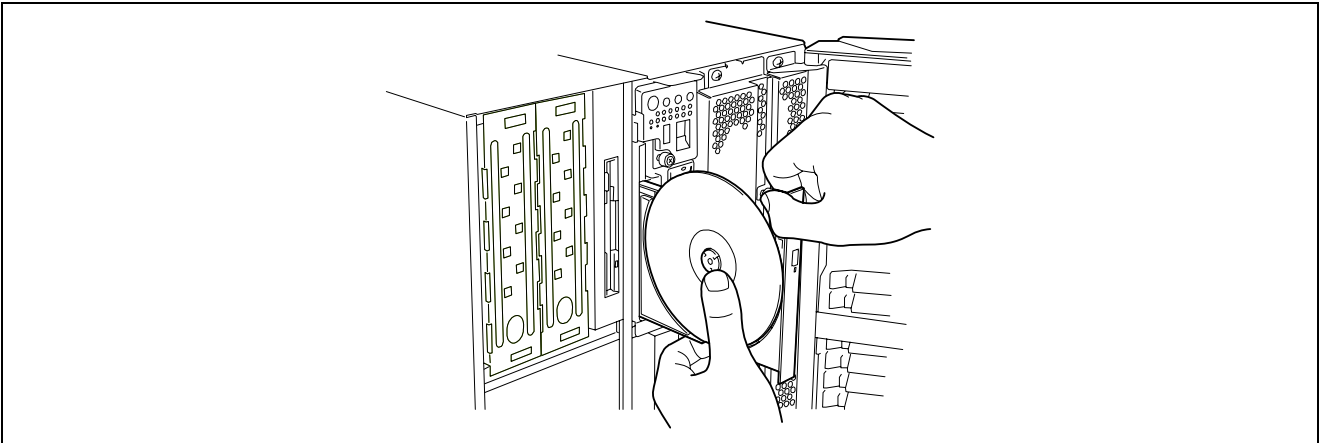

If the access lamp is lit in orange, the CD is being accessed. Confirm that the access lamp is not lit before pressing the Eject button.

As shown in the figure above, hold the tray with a hand and take the end of the CD-ROM lightly by the fingers of another hand with the suppression of the rotor at the center of the tray to remove the CD-ROM from the tray.

After taking out the CD-ROM, return the tray into the drive.

When you fail to eject the CD-ROM tray with the Eject button and take out the CD-ROM from the server, follow the procedure below.

1. Press the POWER switch to power off the server. (The POWER/SLEEP lamp goes off.)
2. Insert a metal pin of approximately 1.2 mm in diameter and 100 mm in length (a straightened large paper clip will make a substitute) into the emergency hole on the upper front of the CD-ROM drive and gently push it in until the tray is ejected.

IMPORTANT:

- Do not use a toothpick or plastic stick that is easy to break.
 - If the above procedure does not let you take out the CD-ROM, contact your service representative.
-

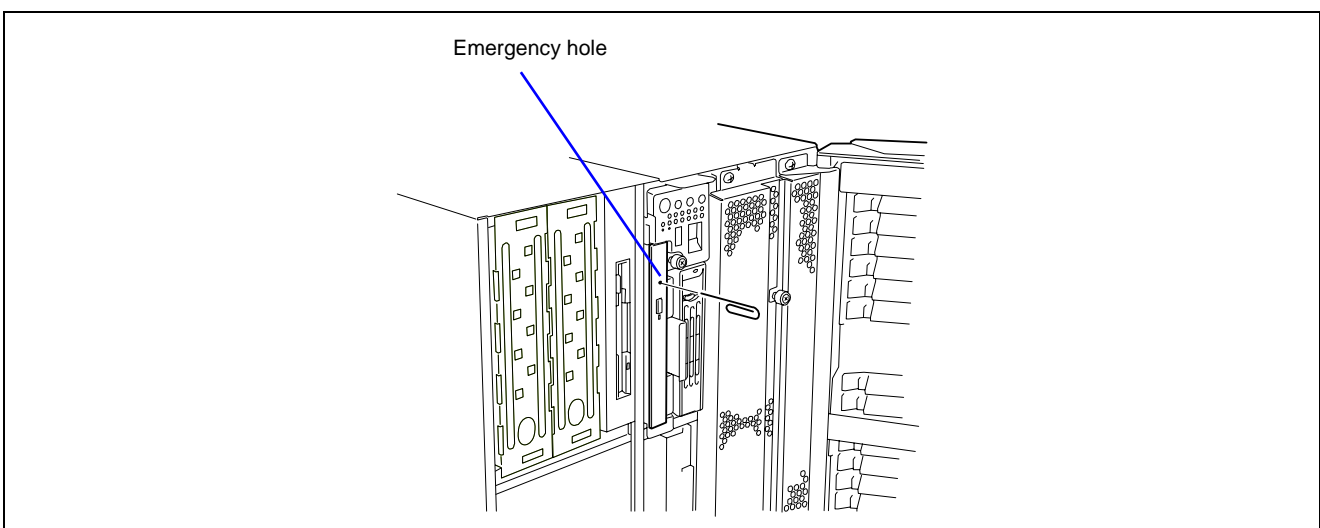

3. Hold the tray and pull it out.
4. Take out the CD-ROM.
5. Push the tray back into position.

NOTE: Use of the CD-ROM

Keep the following notes in mind to use the CD-ROM for the server:

- The playback of disks that do not conform to the CD-ROM standards with the CD-ROM drive is not guaranteed.
 - Do not drop the CD-ROM.
 - Do not place anything on the CD-ROM or bend the CD-ROM.
 - Do not attach any label onto the CD-ROM.
 - Do not touch the signal side (nothing is printed on this side) with your hand.
 - Place the CD-ROM with its printed side upward and gently put it on the tray.
 - Do not scratch the CD-ROM or write anything directly on it with a pencil or ball-point pen.
 - Keep the CD-ROM away from cigarette smoke.
 - Do not leave the CD-ROM in a high-temperature place (e.g., place exposed to direct sunlight or close to a heater).
 - When dust or fingerprints are attached on the CD-ROM, wipe the CD-ROM from its centre to edge with a dry soft cloth slowly and gently.
 - Use CD cleaner to clean the CD-ROM. Do not use record spray/cleaner, benzene, or thinner.
 - Keep the CD-ROM in a CD-ROM case when not in use.
 - If the CD-ROM emits loud noise in the CD-ROM drive, remove the CD-ROM and insert it back again.
-

This page is intentionally left blank

Chapter 3

Setting Up Your Server

This chapter describes how to set up your server appropriate for your system, on a step-by-step basis.

SETUP FLOW

Follow the flowchart below to set up the server.

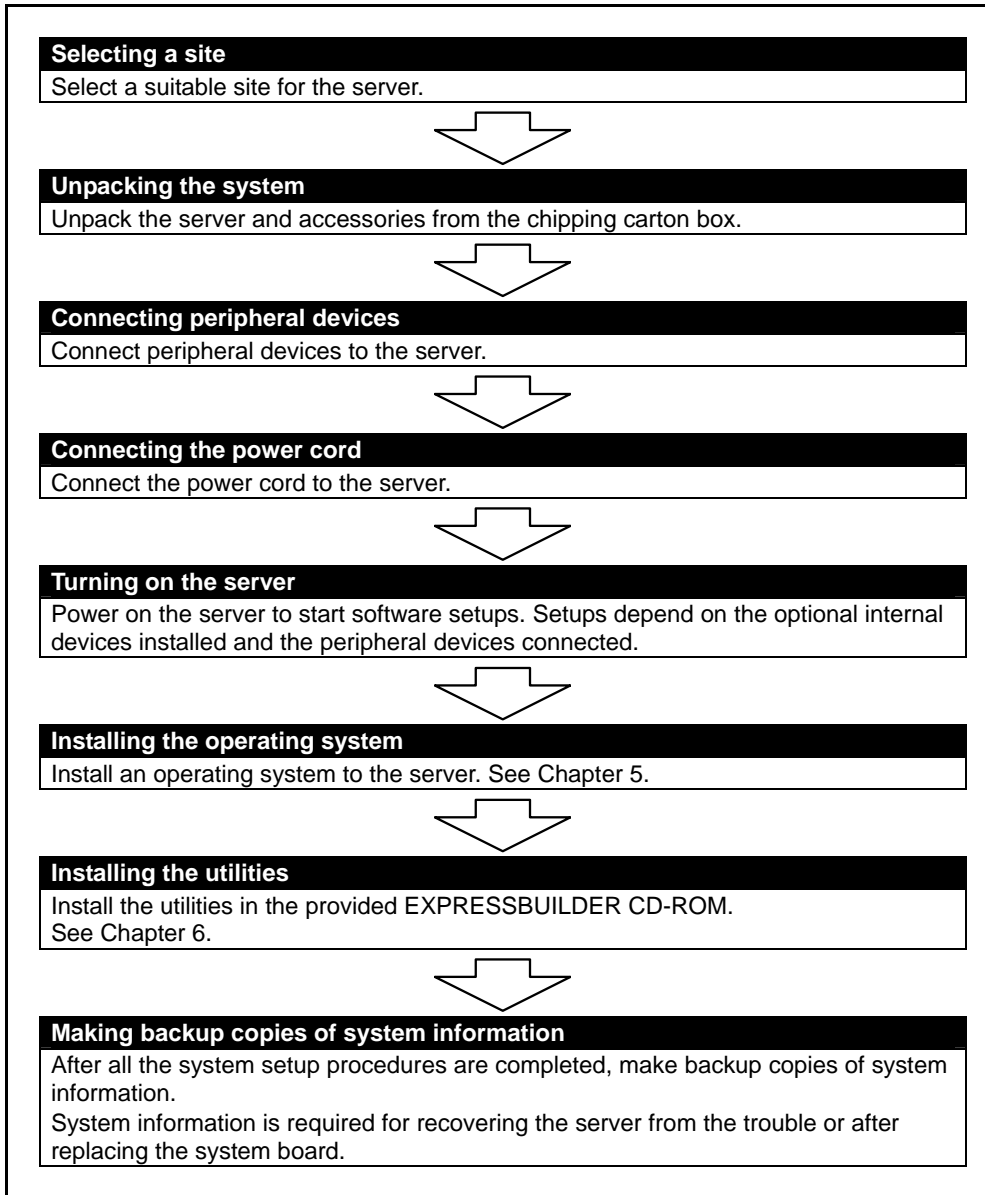

SELECTING A SITE

Read the following precautions before selecting a suitable site for your server. The following describes installation of the server and connections to the server.

⚠ CAUTION	
	<p>Observe the following instructions to use the server safely. Failure to follow these instructions may cause a fire, personal injury, or property damage. See pages 1-3 to 1-8 for details.</p> <p>Never attempt to lift the server with three or less persons. Do not install the server in any place other than specified.</p>

The following figure illustrates a site suitable for installing the server.

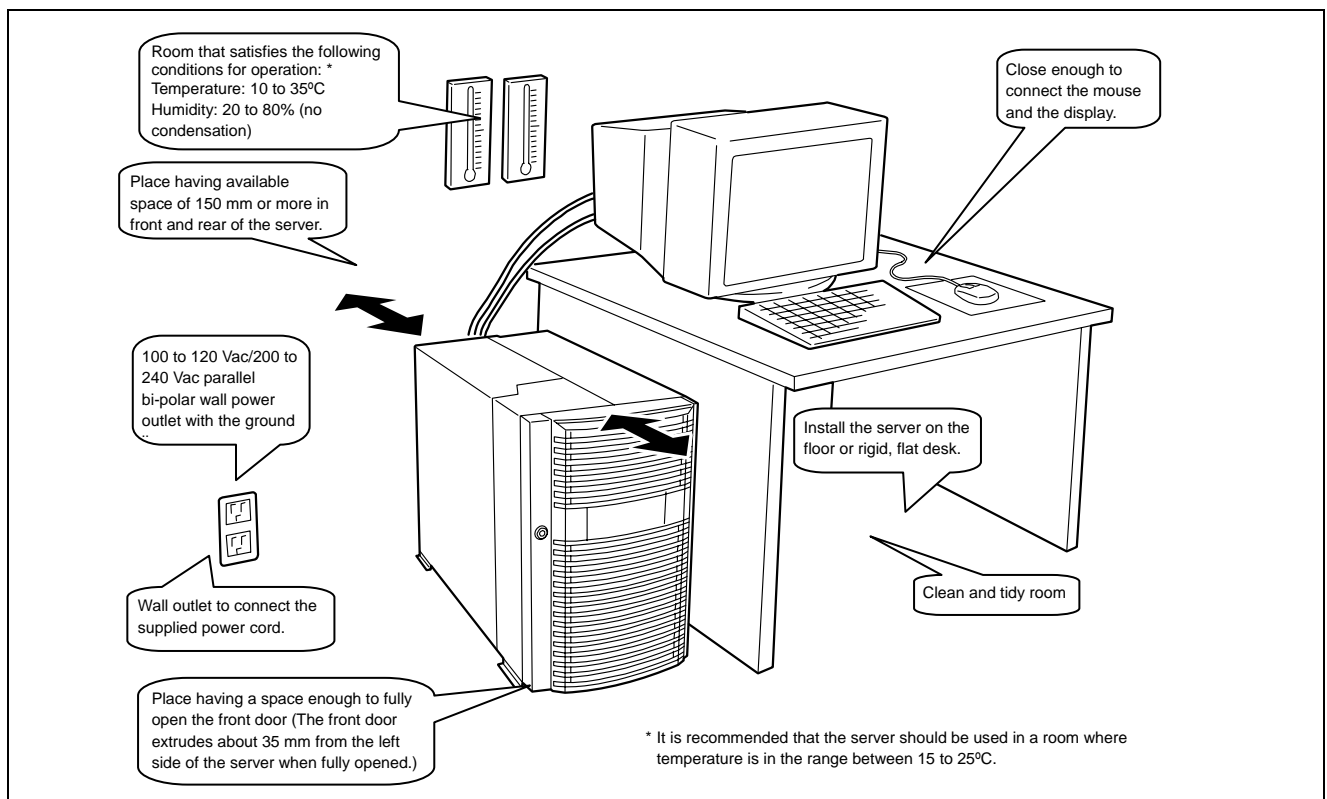

When you have selected a server site, hold the server by its bottom with at least four persons and carry it to the site, then place it slowly and gently.

IMPORTANT: Do not hold the server by its front door to lift the server. The front door may be disengaged and damage the server.

Do not place the server in the following places. Placing the server in such places may cause malfunctions of the server.

- Places with drastic changes in temperature (e.g., near a heater, air conditioner, or refrigerator)
- Places with strong vibration
- Places where corrosive gases (sulphur dioxide, hydrogen sulphide, nitrogen dioxide, chlorine, ammonia, ozone, etc) exist.
And also, places where the air (or dust) includes components accelerating corrosion (ex. sulphur, sodium chloride) or conductive metals.
- On a non-anti-static carpet
- Places with possibilities of falling objects
- Places near a device generating intense magnetic field (such as a TV, radio, broadcast/communication antenna, power transmission wire, and electromagnetic crane) is placed (If unavoidable, contact your service representative to request proper shield construction.)
- Places where a power outlet that shares the ground line with another (especially the one to which a device with large power consumption is connected) must be used for the server
- Places near equipment that generates power noise (e.g., contact spark at power-on/power off of commercial power supply through a relay). If you must install the server close to such equipment, contact your service representative for separate power cabling or noise filter installation.

UNPACKING THE SYSTEM

When you receive your system, inspect the shipping containers prior to unpacking. If the shipping boxes are damaged, note the damage, and if possible, photograph it for reference. After removing the contents of the containers, keep the cartons and the packing materials. If the contents appear damaged when you unpack the boxes, file a damage claim with the carrier immediately.

CONNECTING PERIPHERAL DEVICES

Connect peripheral devices to the server. The server is provided with connectors for a wide variety of peripheral devices on its rear panel. The figures on the next pages illustrate available peripheral devices for the server in the standard configuration and locations of the connectors for the devices.

WARNING



Observe the following instructions to use the server safely. Failure to follow these instructions may result in death or serious personal injury. See pages 1-3 to 1-8 for details.

Do not hold the power plug with a wet hand.

CAUTION



Observe the following instructions to use the server safely. Failure to follow these instructions may cause a fire, personal injury, or property damage. See pages 1-3 to 1-8 for details.

Plug in to a proper power source.

Do not connect the power cord to an outlet that has an illegal number of connections.

Insert the power plug into the outlet as far as it goes.

Do not use any unauthorized power cord.

Do not connect any interface cable with the power cord of the server plugged to a power source.

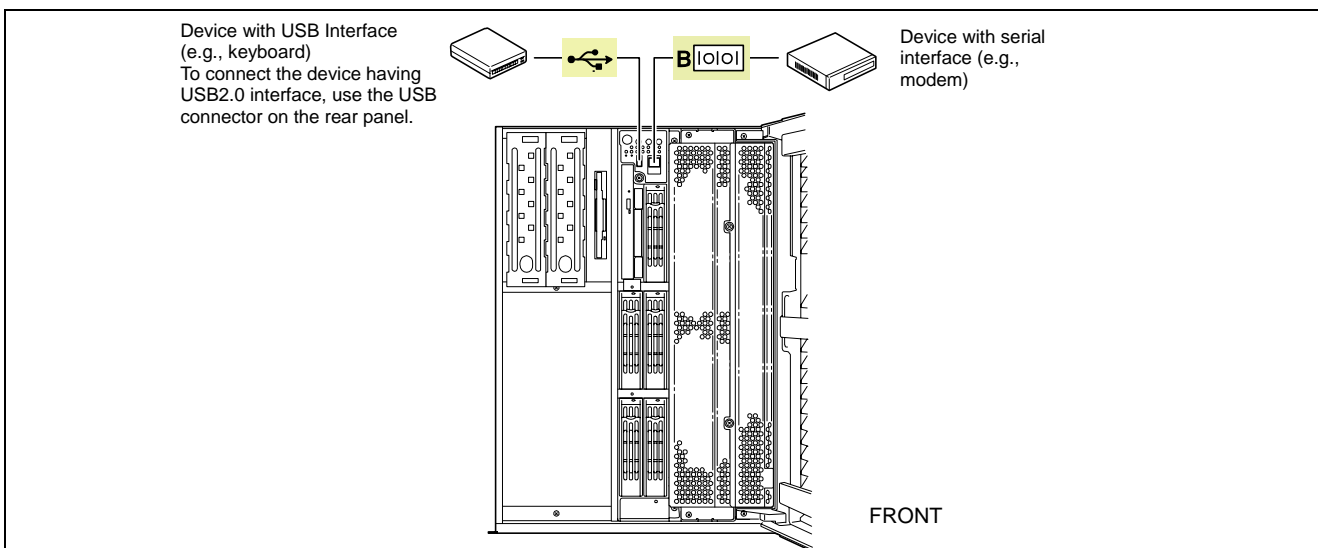

NOTE: Make sure of the cable you are going to connect. The ICMB connector and the front serial port B connector of this server have the same shape as the LAN connector. Be careful not to connect a cable to a wrong connector.

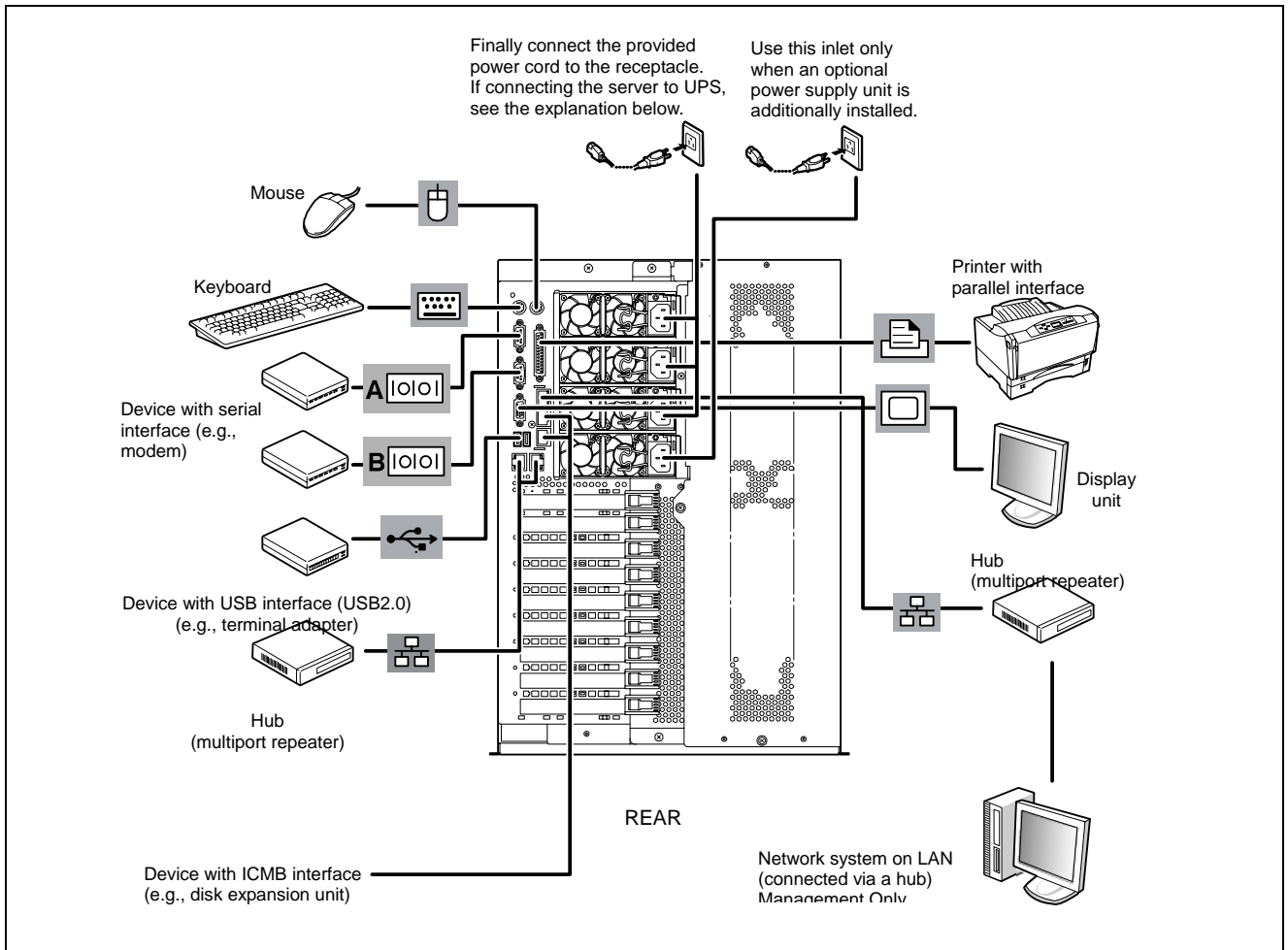

IMPORTANT:

- Power off the server and a peripheral device before connection. Connecting a powered peripheral device to the powered server will cause malfunctions and failures.
- To connect a third-party peripheral device or interface cable to the server, contact your service representative for availability of such a device or cable. Some third-party devices may not be used for the server.
- A leased line cannot be connected directly to the serial port connectors.

CONNECTING POWER CORD

Connect the provided power cord to the server.

⚠ WARNING



Observe the following instructions to use the server safely. Failure to follow these instructions may result in death or serious personal injury. See pages 1-3 to 1-8 for details.

Do not hold the power plug with a wet hand.

⚠ CAUTION



Observe the following instructions to use the server safely. Failure to follow these instructions may cause a fire, personal injury, or property damage. See pages 1-3 to 1-8 for details.

Do not plug the power cord in to an improper power source.
Do not connect the power cord to an outlet that has an illegal number of connections.
Insert the power plug into the outlet as far as it goes.
Use the authorized power cord only.

1. Plug the provided power cord into the AC inlet on the rear of the server.
2. Plug the other end of the power cord into the wall outlet.
3. Secure the power cord with a cable tie.

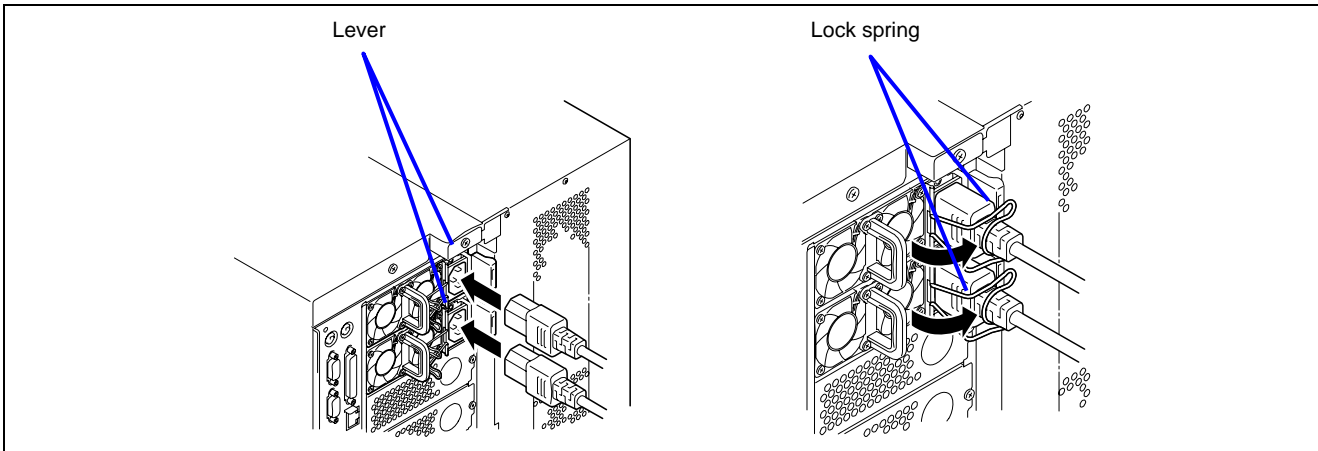

To connect the power cord from the server to an uninterruptible power supply (UPS), use service outlets on the rear of the UPS.

The UPS service outlets are categorized into two groups: SWITCH OUT and UN-SWITCH OUT. (They may be called "OUTPUT1" and "OUTPUT2".)

To control power supply with an application (ESMPRO UPS Controller) that controls the UPS, connect the power cord to a SWITCH OUT outlet.

For constant power supply, connect the power cord to an UN-SWITCH OUT outlet. (Plug a modem that has a permanent connection to this outlet.)

<Example>

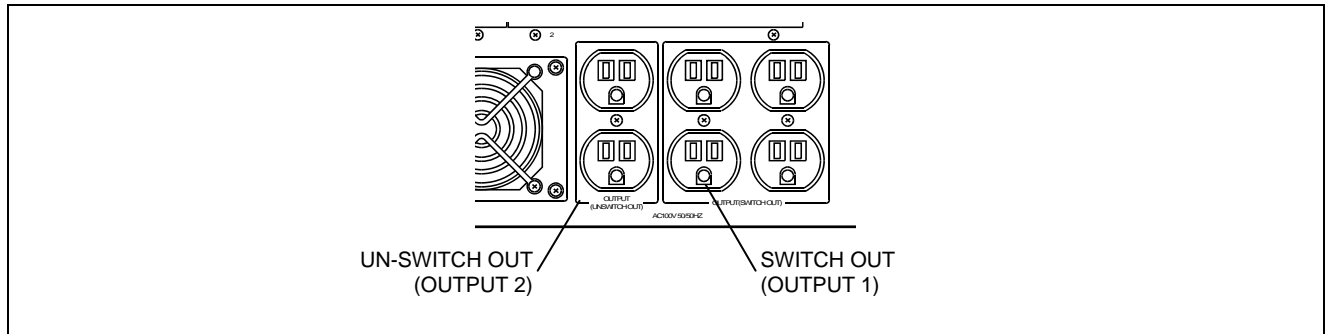

When the power cord is connected from the server to a UPS, change the BIOS setup of the server to link with power supply from the UPS.

Change a parameter for "AC-LINK" under the Server menu of the BIOS setup utility. See Chapter 4 for details.

TURNING ON THE SERVER

Turn on the server and follow the on-screen instructions for setup.

IMPORTANT: Before turning on the server:

- Some optional boards require setups with the **SETUP** utility before installation. If the server has a PCI board with the PCI-to-PCI bridge installed, the **SETUP** utility is enabled to launch. Check on the board specifications to find out whether it requires pre-installation setups before actually installing the board.
- Some installed optional devices or connected peripheral devices require setups before proceeding to the next step.

To use the server with no optional devices installed besides the graphic board, install the desired operating system to the server.

1. Make sure that the floppy disk drive contains no floppy disk and the CD-ROM drive contains no bootable CD-ROM.
2. Press the **POWER** switch.

NOTES:

- If the power cord is connected to the power control unit such as the UPS, turn on the power control unit.
 - Connect the power cord and wait for about 30 seconds before pressing the **POWER** switch. The **POWER** switch does not work for about 30 seconds after connecting the power cord due to BMC (Baseboard Management Controller) firmware start-up.
 - Do not turn off the server until characters following our logo appear on the screen. The time until the characters appear depends on your system configuration. Approximately, it may take one to five minutes.
-

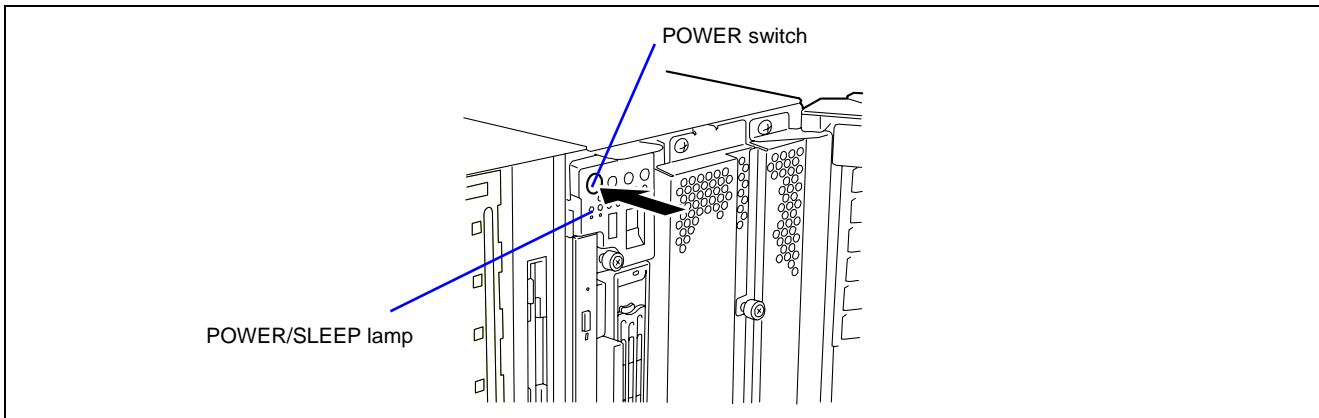

The POWER/SLEEP lamp on the front of the server comes on.

In a few seconds, our logo appears on the screen and the Power On Self-Test (POST) begins.

The POST runs automatically when you power on the server or reset it with a keyboard operation (**Ctrl + Alt + Delete**). The POST runs diagnostics, initializes the server, sets interrupt vectors, detects installed peripheral devices, and boots the operating system (if installed). See Chapter 2 for detailed description on POST.

If the server halts before completing the POST, the POST emits a beep code indicating a fatal system error requiring immediate attention. (See Chapter 8, "Troubleshooting," for troubleshooting information.)

During memory test, the POST displays the amount of memory it was able to access and test. Depending on the amount of installed memory, it may take several minutes to complete the memory test.

NOTE: The factory-set is defined to hide the POST screen with our logo screen. You can always change our logo screen to the POST screen by pressing **Esc**. To change the start-up screen, use the BIOS setup utility, "SETUP." (See Chapter 4 for details.)

During the POST, you will see the banner message to prompt you to launch the BIOS SETUP utility stored in ROM on system board or on an installed option board.

Start the BIOS SETUP utility appropriate to your system environment to change the BIOS setup. For the BIOS SETUP for the server, see Chapter 4. For the BIOS SETUP for the option board, refer to the manual that comes with the option board.

INSTALLING OPERATING SYSTEM

See Chapter 5 for installing the Microsoft® Windows Server™ 2003.

To install other operating systems than listed above, contact your service representative.

IMPORTANT: Before installing the operating system, adjust the system date and time by using the BIOS setup utility "SETUP". See Chapter 4 detail.

INSTALLING UTILITIES

Install the utilities that come with the server. See Chapter 6 for details.

MAKING BACKUP COPIES OF SYSTEM INFORMATION

The system information includes the current BIOS settings and any specific information for the server.

Save the information after completing the system setup.

Without the backup data, you will not be able to recover the information.

You can save the information as follows:

1. Insert the EXPRESSBUILDER CD-ROM in the CD-ROM drive and reboot the system.
2. Select [Tools].
3. Select [Off-line Maintenance Utility].
4. Select [System Information Management].
5. Insert a floppy disk in the floppy disk drive.
6. Select [Save].

Chapter 4

Configuring Your Server

This chapter describes Basic Input Output System (BIOS) configuration.

When you install the server for the first time or install/remove optional devices, thoroughly read this chapter for better understanding and correct setups.

SYSTEM BIOS ~ SETUP ~

The SETUP utility is provided to make basic hardware configuration for the server. This utility is pre-installed in the flash memory of the server and ready to run.

The server is configured with the correct parameters using the SETUP utility and shipped in the best conditions. Thus, you do not need to use the SETUP utility in most cases. However, you might wish to use the SETUP utility in the cases described below.

IMPORTANT:

- The SETUP utility is intended for system administrator use only.
 - The SETUP utility allows you to set a password. The server is provided with two levels of password: Supervisor and User. With the Supervisor password, you can view and change all system parameters of the SETUP utility. With the User password, system parameters available for viewing and changing are limited.
 - Do not set any password before installing the operating system.
 - The server contains the latest version of the SETUP utility. Dialog boxes appear on your SETUP utility, thus, may differ from descriptions in this manual. If you find anything unclear, see the online help or ask your service representative.
-

Starting SETUP Utility

To run the SETUP utility, do as follows:

1. Power on the server.

Our logo appears on the screen (the POST screen may appear depending on the setting in SETUP).

After a while, any of the following messages appears at the bottom of the screen.

Pattern 1:

Press <F2> to enter SETUP or <F12> to Network

Pattern 2:

Press <F2> to enter SETUP, <F4> Service Partition, <F12> to Network

Or

Pattern 3:

Press <F1> to resume, <F2> to enter Setup, <F12> to Network

Pattern 4:

Press <F1> to resume, <F2> to enter Setup, <F4> Service Partition, <F12> Network

* The displayed message varies depending on the device status.

2. Press **F2** to start the SETUP utility and display its Main menu.

If you have previously set a password with the SETUP utility, the password entry screen appears. Enter the password.

Up to three password entries will be accepted. If you fail to enter the password correctly for three consecutive times, the server halts. (You can no longer proceed.) Power off the server.

NOTE: The server is provided with two levels of password: Supervisor and User. With the Supervisor password, you can view and change all system parameters. With the User password, system parameters available for viewing and changing are limited.

Description of On-Screen Items and Key Usage

Use the following keyboard keys to work with the SETUP utility. (Key functions are also listed at the bottom of the screen.)

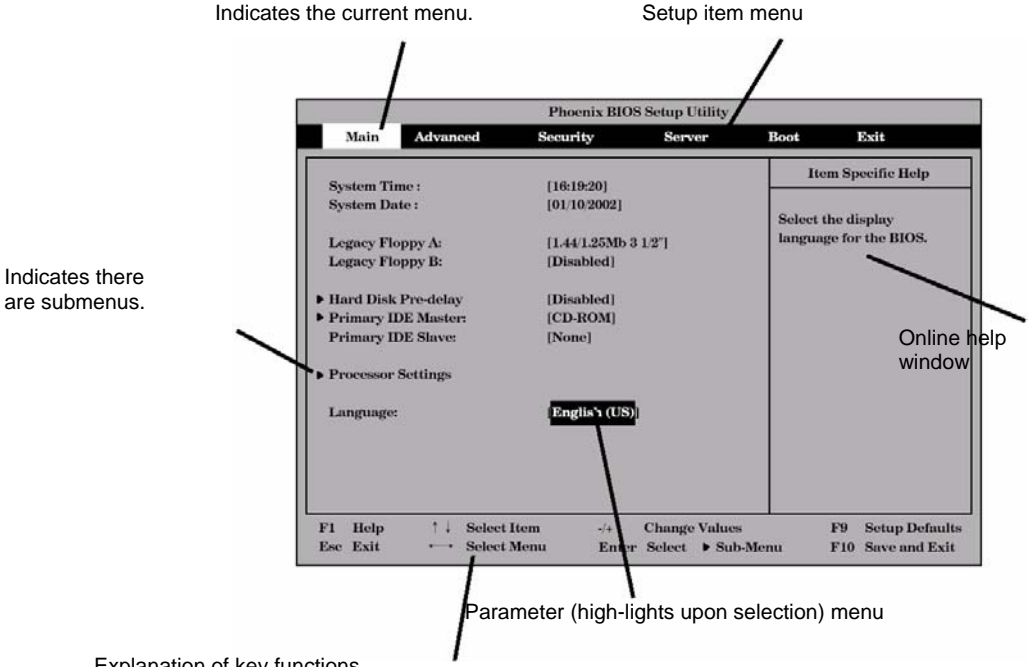

- Cursor (↑, ↓):** Selects an item on the screen. The highlighted item is currently selected.
- Cursor (←, →):** Selects the Main, Advanced, Security, System Hardware, Boot, or Exit menu.
- and +:** Changes the value (parameter) of the selected item. When a submenu option (an option preceded by "►") is selected, these keys are disabled.
- Enter** Press **Enter** to select (determine) parameters.
- Esc** Displays the previous screen.
- F1:** Press **F1** when you need help on SETUP operations. The help screen for SETUP operations appears. Press **Esc** to return to the previous screen.
- F9:** Sets the parameter of the currently displayed item back to the factory set parameter.
- F10:** Saves the modifications and exits Setup.

Configuration Examples

The following describes examples of configuration required to use software-link features or for system operations.

Link with Management Software

To link with the temperature monitoring feature of ESMPRO Agent

Select [Server] - [Thermal Sensor] - [Enabled].

To control power supply of the server with ESMPRO Manager via the network

Select [Advanced] - [Advanced Chipset Control] - [Wake On Lan/PME] - [Enabled].

Select [Server] - [AC-LINK] - [StayOff].

UPS

To link power supply with the UPS

- To power on the server when power is supply from the UPS

Select [Server] - [AC-LINK] - [Power On].

- To keep the server off-powered even when power is supplied from the UPS if the POWER switch was used to power off

Select [Server] - [AC-LINK] - [Last State].

- To keep the server off-powered even when power is supplied from the UPS

Select [Server] - [AC-LINK] - [StayOff].

Boot

To change the boot order of devices connected to the server

Select [Boot] and specify the boot order.

To display POST check results

Select [Advanced] - [Boot-time Diagnostic Screen] - [Enabled].

You can also press **Esc** while our logo is on the screen to display POST check results.

To control from the HW console

Select [Server] - [Console Redirection] and set each item.

Memory

To enable the memory degradation feature

Select [Advanced] - [Memory/Processor Error] - [Halt].

To check the installed memory (DIMM board) status

Select [Advanced] - [Memory Configuration] and check the status indications.

The on-screen DIMM group numbers and socket locations on the IO board are associated as shown in the following figure.

To clear the memory (DIMM board) error information

Select [Advanced] - [Memory Configuration] - [Memory Retest] - [Yes] and reboot.

Select [Server] - [Clear FRU LED] - [Yes] and reboot.*

* Only when [Server] - [FRU LED Feature] - [Enabled] has been selected.

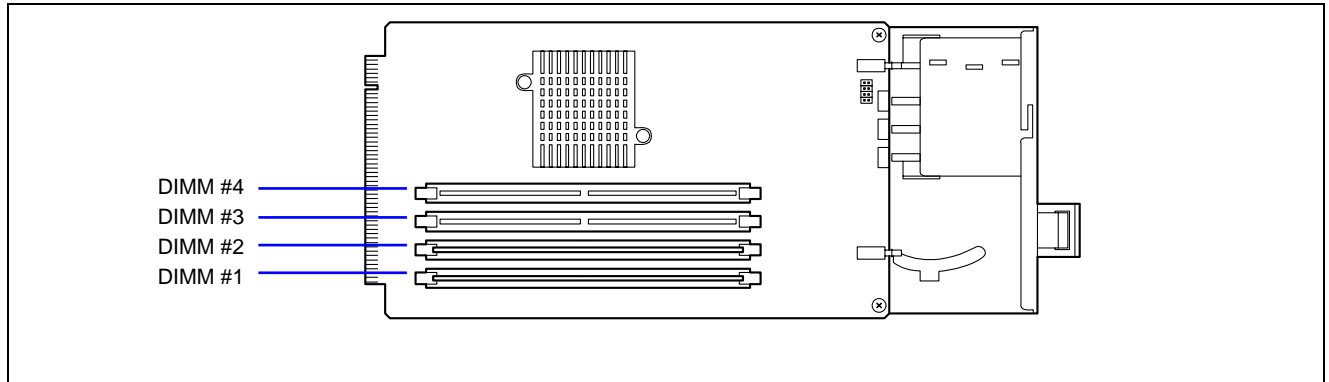

To enable the memory mirroring feature or memory RAID feature

Select [Advanced] - [Memory Configuration] - [Memory RAS Feature], and select [Mirror] or [RAID].

Processor

To enable the processor degradation feature

Select [Advanced] - [Memory/Processor Error] - [Halt].

To check the installed processor status

Select [Main] - [Processor Settings] and check the status indications.

The on-screen processor numbers and socket locations on the IO board are associated as shown in the following figure.

To clear the processor error information

Select [Main] - [Processor Settings] - [Processor Retest] - [Yes] and reboot.

Select [Server] - [Clear FRU LED] - [Yes] and reboot.*

* Only when [Server] - [FRU LED Feature] - [Enabled] has been selected.

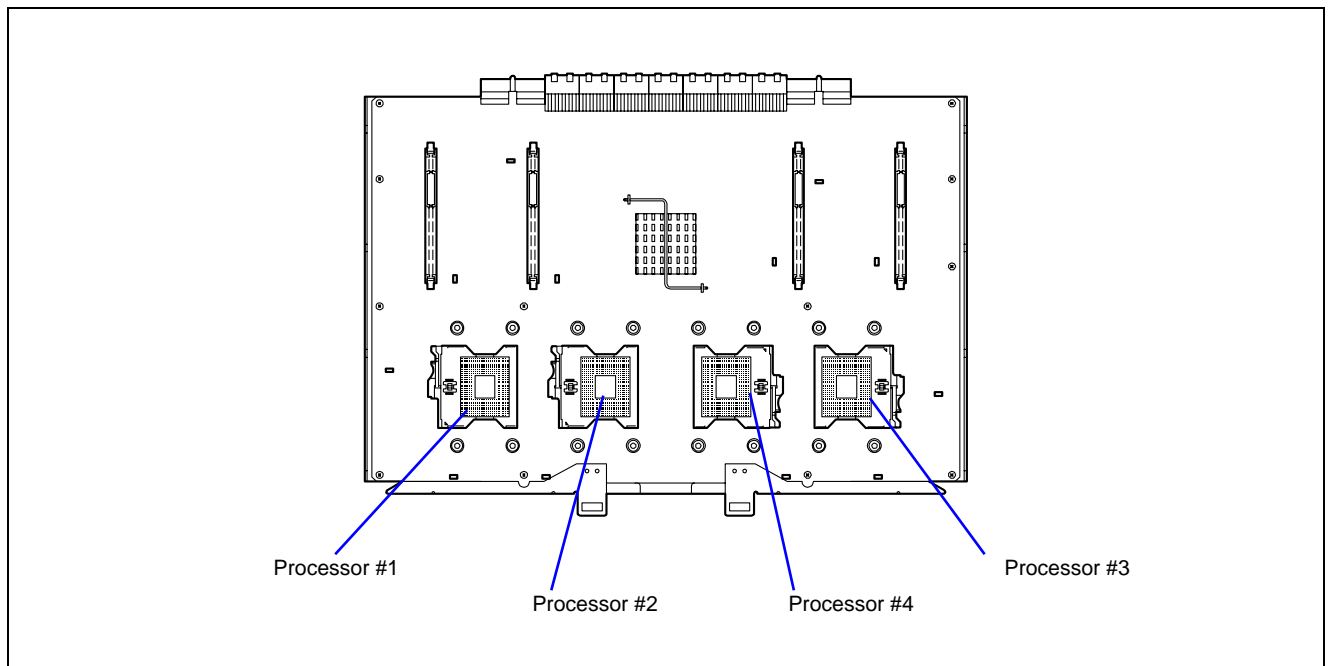

Security

To set passwords on the BIOS

Select [Security] - [Set Supervisor Password] and enter a password.

Supervisor password and User password can be set separately, and only User password has a restriction to access to SETUP utility.

To enable/disable the POWER switch and SLEEP switch

- To disable
Select [Security] - [Power Switch Inhibit] - [Enabled].
- To enable
Select [Security] - [Power Switch Inhibit] - [Disabled].

IMPORTANT: Enabling [Power Switch Inhibit] disables forced shutdown (see Chapter 8) as well as power on/off using the POWER switch.

To set the secure mode

Select [Security] - [Secure Mode] and set each item.

External Devices

To set up external devices

Select [Advanced] - [Peripheral Configuration] and set up each device.

Internal Devices

To set up internal PCI devices of the server

Select [Advanced] - [PCI Configuration] and set up each device.

To clear the hardware configuration data (after installing/removing internal devices)

Select [Advanced] - [Reset Configuration Data] - [Yes].

PCI Hot Plug

To install the PCI board with the PCI hot plug

Select [Advanced] - [PCI Configuration] - [Hot Plug PCI Control] - [Minimum/Middle/Maximum*]

* The setting varies depending on the PCI board subject to the hot plug. See the table below.

Board name	Setting Value
100BASE-TX Adapter	Minimum
1000BASE-T Adapter	Minimum
1000BASE-TX Adapter	Minimum

Saving the Configuration Data

To save the BIOS configuration data

Select [Exit] - [Exit Saving Changes] or [Save Changes].

To discard changes to the BIOS configuration data

Select [Exit] - [Exit Discarding Changes] or [Discard Changes].

To resume the default BIOS configuration data (may differ from factory-set value)

Select [Exit] - [Load Setup Defaults].

To save the current value as user default

Select [Exit] - [Save Custom Defaults].

To load the user-defined default

Select [Exit] - [Load Custom Defaults].

Menu and Parameter Descriptions

The SETUP utility has the following six major menus:

- Main
- Advanced
- Security
- Server
- Boot
- Exit

To set minute functions, select a submenu from the above menus. The following describes available functions and parameters, as well as the factory-set, for each menu.

Main

After entering SETUP, the Main menu appears first. To display a submenu, position the cursor on a selection that has a submenu (preceded by symbol ►) and press **Enter**.

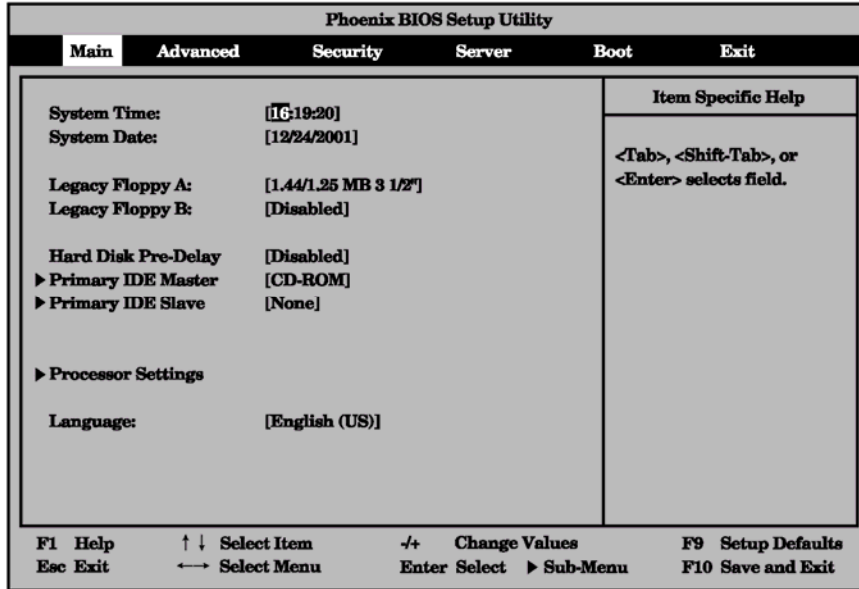

The items which can be set on the Main menu screen and their functions are described below.

Option	Parameter	Description	Your Setting
System Time	HH:MM:SS	Set the time.	
System Date	MM/DD/YYYY	Set the date.	
Legacy Floppy A	Disabled 1.2MB 5 1/4" 720Kb 3 1/2" [1.44/1.25MB 3 1/2"] 2.88MB 3 1/2"	Set the settings of floppy disk drive A (standard configuration). Normally set to "1.44/1.25 MB 3.5".	
Legacy Floppy B	[Disabled] 1.2MB 5 1/4" 720Kb 3 1/2" 1.44/1.25MB 3 1/2" 2.88MB 3 1/2"	Set the settings of floppy disk drive B. Set to "Disabled" since the server does not support drive B.	
Hard Disk Pre-Delay	[Disabled] 3 seconds 6 seconds 9 seconds 12 seconds 15 seconds 21 seconds 30 seconds	Wait for the specified time until the first access to the IDE device during POST.	
Primary IDE Master/Primary IDE Slave	-	Displays the information on the device connected to each channel on the submenu. (Display only)	
Language	[English (US)] French German Spanish Italian	Select the language used for SETUP.	

[]: Factory-set

Processor Settings

Selecting "Processor Settings" on the Main menu shows the following submenu.

Phoenix BIOS Setup Utility			
Main			
Processor Settings		Item Specific Help	
Processor Retest	[No]	Select 'Yes', BIOS will clear historical processor status and retest all processors on next boot.	
Processor Speed Setting :	3.16 GHz		
Processor 1 CPUID :	0F41		
Processor 1 L2 Cache Size :	1024 KB		
Processor 2 CPUID :	0F41		
Processor 2 L2 Cache Size :	1024 KB		
Processor 3 CPUID :	0F41		
Processor 3 L2 Cache Size :	1024 KB		
Processor 4 CPUID :	0F41		
Processor 4 L2 Cache Size :	1024 KB		
F1 Help ↑ ↓ Select Item -/+ Change Values F9 Setup Defaults Esc Exit ← → Select Menu Enter Select ► Sub-Menu F10 Previous Value			

See the table below for the items.

Option	Parameter	Description	Your Setting
Processor Retest	[No] Yes	Clears the error information on the processor.	
Processor Speed Setting	–	Indicates the frequency of the processor.	
Processor 1-4 CPUID	–	A numeral indicates the ID of processor. "Disabled" indicates that the processor is defected by BMC. "Not Installed" indicates that the processor is not installed. (Display only)	
Processor 1-4 L2 Cache Size	–	Indicates the L2 cache of processor.	
Processor 1-4 L3 Cache Size	–	Indicates the L3 cache size if the processor has L3 cache memory.	
Hyper-Threading Technology	Disabled [Enabled]	Setting this item to "Enabled" allows the hyper-threading technology to be used in the ACPI mode. From operating system that supports Hyper-Threading Technology feature, the specified number of processors is twice as many as the actual number of the installed processors.	
Execute Disable Bit	[Disabled] Enabled	Disables or enables the Execute Disable Bit feature of the processor.	

[]: Factory-set

Advanced

The Advanced menu appears if you move the cursor to the position of "Advanced."

To display a submenu, position the cursor on a selection that has a submenu (preceded by symbol ►) and press **Enter**.

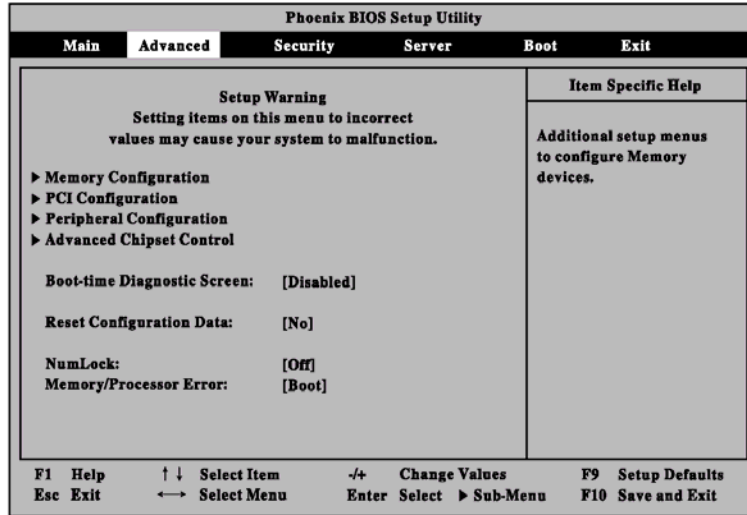

See the table below for the items.

Option	Parameter	Description	Your Setting
Boot-time Diagnostic Screen	[Disabled] Enabled	Specify whether the self-diagnosis (POST) running screen is displayed or not on booting. If this item is set to "Disabled," our logo appears during POST. (Pressing Esc in the status causes the screen display to be switched to the POST execution screen. The Boot-time Diagnostic Screen is automatically enabled if the Console Redirection is enabled.	
Reset Configuration Data	[No] Yes	Select "Yes" to clear the extended system configuration data area (system information stored by POST). The parameter is changed to "No" after the system is booted.	
NumLock	On [Off]	Specify whether the NumLock is enabled or disabled on booting.	
Memory/Processor Error	[Boot] Halt	Indicates whether POST is paused at the occurrence of a processor or memory error during the execution of POST. When processor error or Memory error is encountered, the utility is not paused at the end of POST if this item is set to "Halt" and even though "POST Error Pause" of "Server" menu is "Enabled".	

[]: Factory-set

Memory Configuration

Selecting "Memory Configuration" on the Advanced menu shows the following screen.

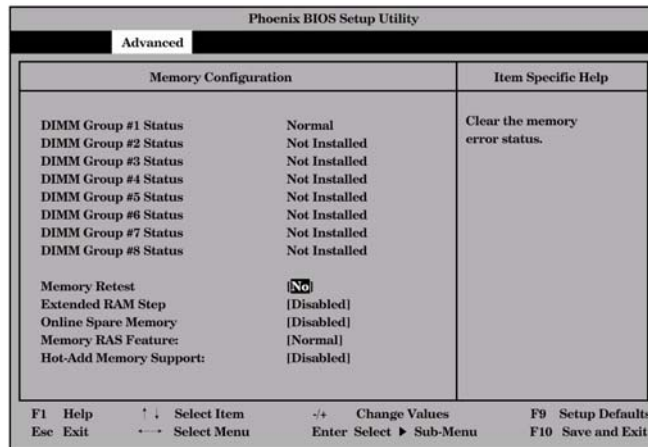

See the table below for the items.

Option	Parameter	Description	Your Setting
DIMM Group #1 - #8 Status	Normal Not installed Disabled	Indicates the current memory status. "Normal" indicates that the memory devices operate normally. "Disabled" indicates that one or more memory devices are defected. "Not Installed" indicates that no memory devices are installed. (Display only)	
Memory Retest	[No] Yes	Clears the DIMM group error status information. Run this menu when the failed DIMM(s) are replaced.	
Extended RAM Step	1MB 1KB Every Location [Disabled]	"1MB" indicates that the memory test is done in the unit of 1MB. "1KB" indicates that the memory test is done in the unit of 1KB. "Every-Location" indicates that every memory device is tested. "Disabled" indicates that only memory initialization is done.	
Online Spare Memory	[Disabled] Enabled	Select "Enabled" to enable the Online Spare Memory feature.	
Memory RAS Feature	[Normal] Mirror RAID	Set the memory configuration. Select "Mirror" to enable the memory mirroring function. Select "RAID" to enable the memory RAID function.	
Hot-Add Memory Support	[Disabled] Enabled	Specify whether to use the Hot-Add Memory feature on Windows Server™ 2003 Enterprise Edition or Datacenter Edition. Select "Enabled" to use the Hot-Add Memory feature.	

[]: Factory-set

PCI Configuration

Selecting "PCI Configuration" on the Advanced menu shows the following screen. Selecting an item on the screen allows the proper submenu to appear.

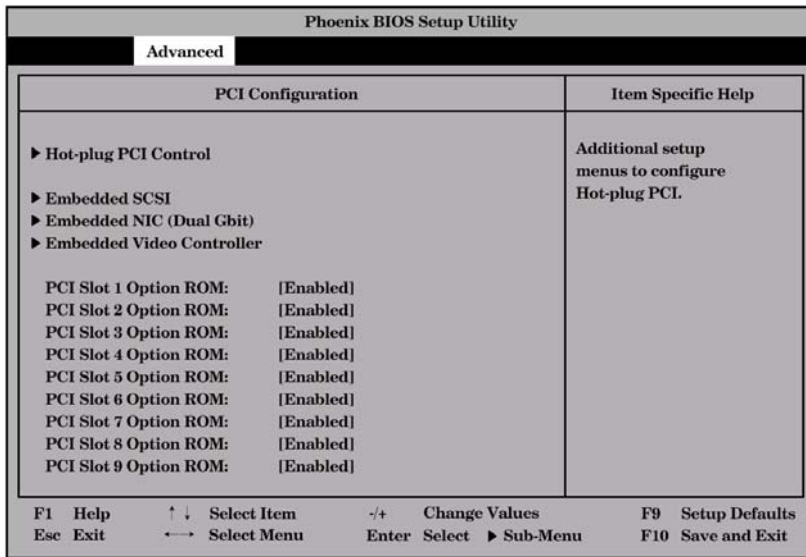

See the table below for the items.

Option	Parameter	Description	Your Setting
PCI Slot 1-9 Option ROM	[Enabled] Disabled	Disables/enables the Option ROM BIOS on the PCI bus. When the graphic accelerator board is installed or the disk array controller or SCSI controller boards to be installed are connected to the hard disk in which operating system is installed, set this item to "Enabled." When the LAN controller board with installation of the option ROM BIOS is used but the board does not provide network booting, set this item to "Disabled."	

[]: Factory-set

Hot-plug PCI Control

Selecting "Hot-plug PCI Control" on the PCI Configuration submenu shows the following screen.

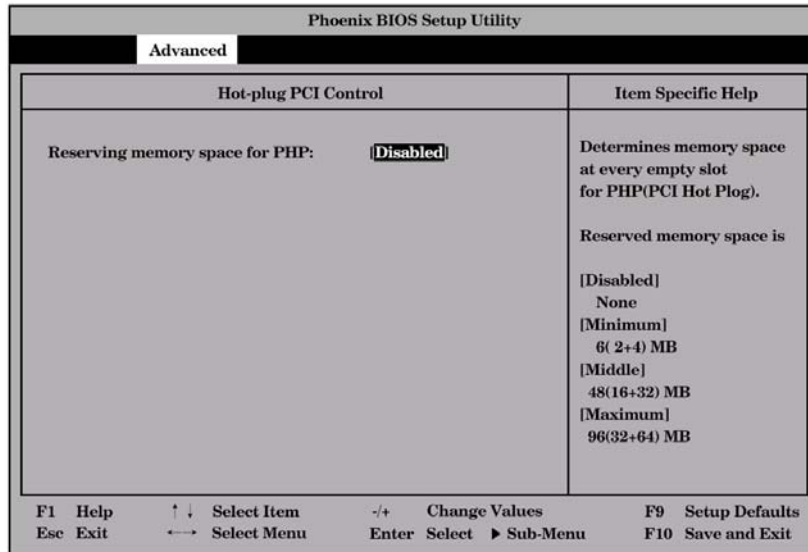

See the table below for the items.

Option	Parameter	Description	Your Setting
Reserving memory space for PHP	[Disabled] Minimum Middle Maximum	Determines memory space at every empty slot for PHP (PCI Hot-plug). Reserved memory space is: [Disabled] None [Minimum] 6 (2+4) MB [Middle] 48 (16+32) MB [Maximum] 96 (32+64) MB	

[]: Factory-set

NOTE: The bus number of PCI slot varies depending on whether this parameter is set to "Disabled" or others. Pay attention when you need to setup the program again.

Embedded SCSI/Embedded NIC/Embedded Video Controller

Selecting "Embedded SCSI", "Embedded NIC", or "Embedded Video Controller" on the PCI Configuration submenu shows the following screen.

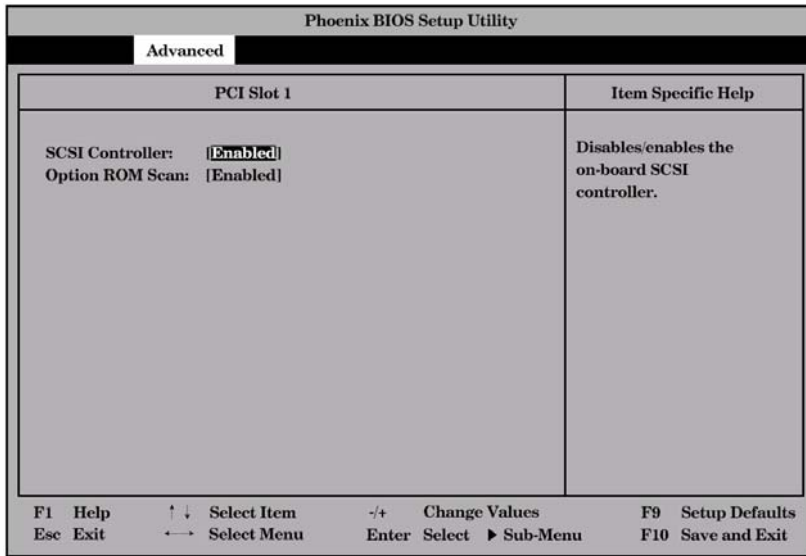

See the table below for the items.

Option	Parameter	Description	Your Setting
SCSI Controller LAN Controller Video Controller	[Enabled] Disabled	Indicates whether the on-board controller is enabled or disabled.	
Option ROM Scan*	[Enabled] Disabled	Displays the submenu for indicating whether the expansion of BIOS of on-board controller is enabled or disabled. Do not set this option to "Disabled".	

[]: Factory-set

* Only displayed for SCSI and LAN controllers.

Peripheral Configuration

Selecting "Peripheral Configuration" on the Advanced menu shows the following screen..

Phoenix BIOS Setup Utility		
Advanced		
Peripheral Configuration	Item Specific Help	
Serial port A:	[Enabled]	Configure serial port A using options: [Disabled] No configuration [Enabled] User configuration [Auto] BIOS or OS chooses configuration
Base I/O address:	[3F8]	
Interrupt:	[IRQ 4]	
Serial port B:	[Enabled]	
Base I/O address:	[2F8]	
Interrupt:	[IRQ 3]	
Parallel port:	[Enabled]	
Mode:	[ECP]	
Base I/O address:	[378]	
Interrupt:	[IRQ 7]	
DMA channel:	[DMA 1]	
PS/2 Mouse	[Enabled]	
USB Controller:	[Enabled]	
Legacy USB Support:	[Enabled]	
F1 Help	↑ ↓ Select Item	+/- Change Values
Esc Exit	← → Select Menu	Enter Select ► Sub-Menu
		F9 Setup Defaults
		F10 Save and Exit

See the table below for the items.

IMPORTANT: Note that the interrupt and/or base I/O address are not overlapped with others. If the value set for the interrupt or base I/O address is used in another resource, the yellow asterisk (*) appears. Reset any item with the yellow asterisk properly.

Option	Parameter	Description	Your Setting
Serial Port A	Disabled [Enabled]	Specify whether serial port A is enabled or disabled.	
Base I/O Address	[3F8] 2F8 3E8 2E8	Selects the base address and interrupt (IRQ) for serial port A. These menus are displayed when the Serial port A is enabled.	
Interrupt	IRQ 3 [IRQ 4]		
Serial Port B	Disabled [Enabled]	Specify whether serial port B is enabled or disabled.	
Base I/O Address	3F8 [2F8] 3E8 2E8	Selects the base address and interrupt (IRQ) for serial port B. These menus are displayed when the Serial port B is enabled.	
Interrupt	[IRQ 3] IRQ 4		
Parallel Port	Disabled [Enabled]	Specify whether the parallel port is enabled or disabled.	
Mode	Output Only Bi-directional EPP [ECP]	Selects the parallel port operation mode, base address, interrupt (IRQ), and DMA channel. These menus are displayed when the Parallel Port is enabled.	
Base I/O Address	[378] 278		
Interrupt	IRQ 5 [IRQ 7]		
DMA channel	[DMA 1] DMA 3		
PS/2 Mouse	Disabled [Enabled]	Specify whether the mouse is enabled or disabled.	
USB Controller	Disabled [Enabled]	Specify whether the USB controller is enabled or disabled.	
Legacy USB Support	Disabled [Enabled]	Specify whether the USB keyboard is made available in operating system which does not support USB formally.	

[]: Factory-set

Advanced Chipset Control

Selecting "Advanced Chipset Control" on the Advanced menu shows the following screen. Positioning the cursor on a menu (item preceded by symbol "►") and pressing **Enter** opens the corresponding submenu.

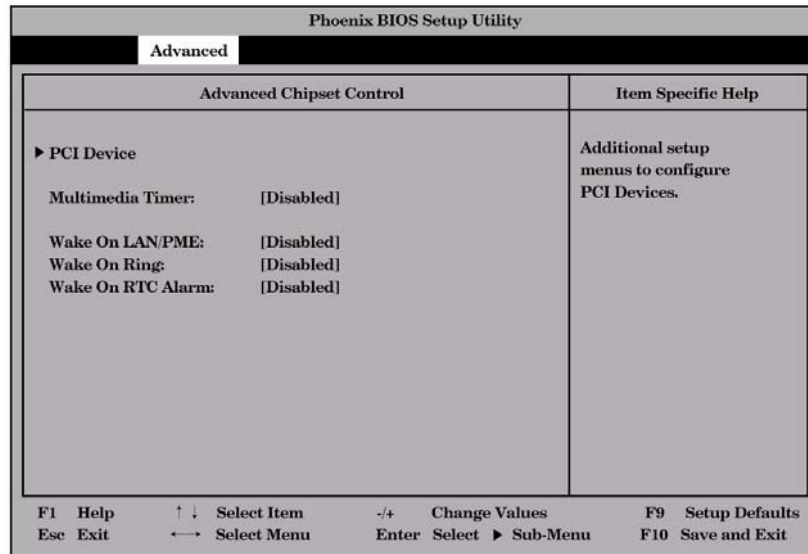

See the table below for the items.

Option	Parameter	Description	Your Setting
Multimedia Timer	[Disabled] Enabled	Selecting "Enabled" enables this function if the operating system supports HPET feature.	
Wake On LAN/PME	[Disabled] Enabled	Specify whether the remote power-on function through network is enabled or disabled.	
Wake On Ring	[Disabled] Enabled	Specify whether the remote power-on function through a serial port is enabled or disabled.	
Wake On RTC Alarm	[Disabled] Enabled	Specify whether the remote power-on function through an RTC alarm is enabled or disabled.	

[]: Factory-set

PCI Device

Selecting "PCI Device" on "Advanced Chipset Control" of the Advanced menu shows the following screen.

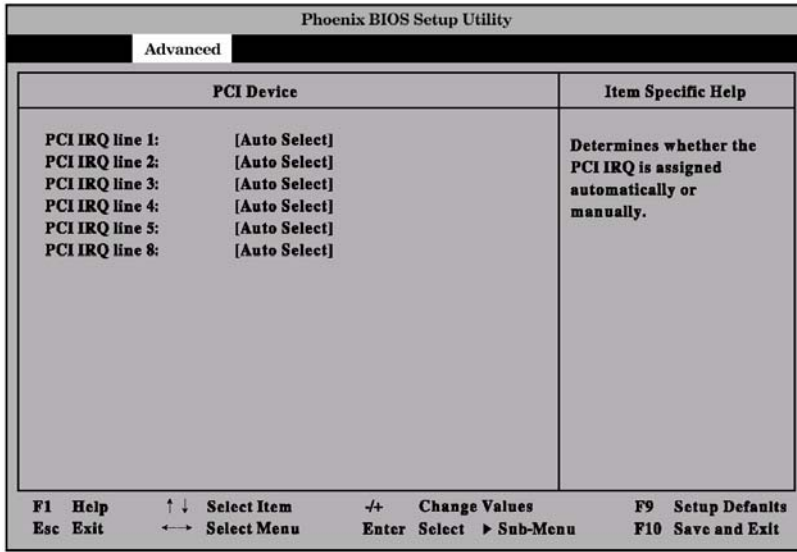

See the table below for the items.

Option	Parameter	Description	Your Setting
PCI IRQ line 1 - 5 PCI IRQ line 8	Disabled [Auto Select] 3 5 6 7 9 10 11 12 14 15	Set the assignment of each of 7 interrupt signals on the PCI bus to a specific IRQ request. Parameter "11" cannot be selected if they are the same as those set for BMC IRQ in the Server menu.	

[]: Factory-set

Security

Positioning the cursor to "Security" shows the following screen.

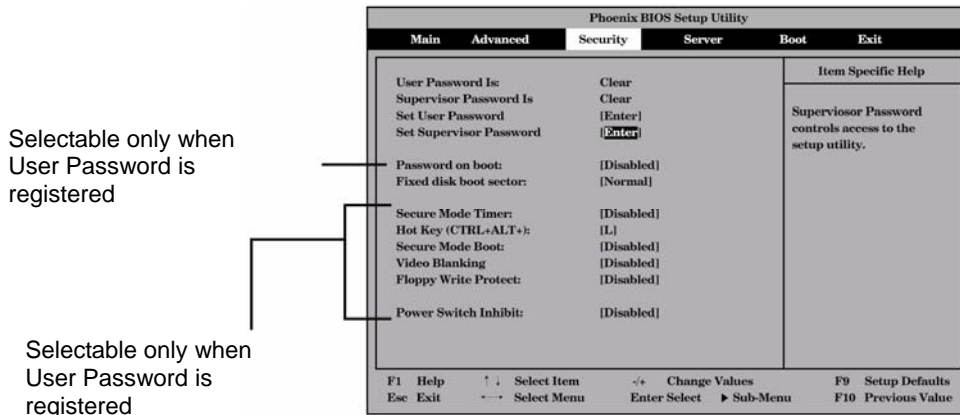

If you press **Enter** with the selection of either "Set Supervisor Password" or "Set User Password," such a screen as shown below appears (the screen shown in the figure below appears when "Set Supervisor Password" is selected).

Specify the passwords on the dialog box. Enter each of the passwords with up to seven characters including alphanumeric characters and symbols.

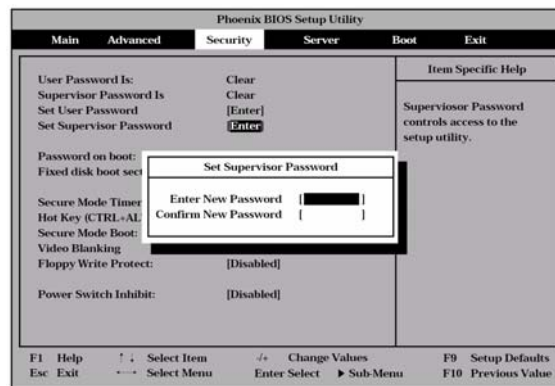

IMPORTANT:

- Set the passwords only after operating system is installed.
- If you forget the passwords, contact your service representative.

See the table below for the items.

Option	Parameter	Description	Your Setting
Set User Password	Up to seven alphanumeric	Press Enter to display the user password input screen. For this password, accessing to the SETUP menu is restricted.	
Set Supervisor Password	Up to seven alphanumeric	Press Enter to display the supervisor password input screen. This password enables all the SETUP menus to be accessed. This setting can be done only on login with the password input of "Supervisor" at start of SETUP.	
Password on boot	[Disabled] Enabled	Specify whether the passwords are entered or not on booting. At first the supervisor password must be set. If the supervisor password is set and this option is invalid, BIOS determines that a user is booting.	
Fixed disk boot sector	[Normal] Write Protect	Prevents data from being written to hard disks.	
Secure Mode Timer	[Disabled] 1 minute 2 minutes 5 minutes	Specify the period from no input from the keyboard or mouse to the point at which the system enters into the secure mode.	

Option	Parameter	Description	Your Setting
	10 minutes 20 minutes 60 minutes 120 minutes		
Hot Key (CTRL+ALT+)	[L] Z	Specify the key with which the secure mode is started. Press the selected key with the Ctrl and Alt pressed to start the secure mode.	
Secure Mode Boot	[Disabled] Enabled	Specify whether the server is operated in the secure mode at the start of the server.	
Video Blanking	[Disabled] Enabled	Specify whether the monitor is disconnected if the server is entered into the secure mode.	
Floppy Write Protect	[Disabled] Enabled	Specify whether data write to the floppy disk inserted into the floppy disk drive is enabled or disabled in the secure mode.	
Power Switch Inhibit	[Disabled] Enabled	Specify whether the power switch is enabled or disabled. If this item is set to "Enabled," the power cannot be turned off by using the POWER switch (including the forced shutdown). The system cannot also enter the power saving mode by pressing the SLEEP switch.	

[]: Factory-set

NOTE: The Secure Mode is used to restrict access from unauthorized users. In the Secure Mode, the POWER switch, SLEEP switch, RESET switch, keyboard and mouse are disabled. The lamps on the keyboard flash in order from the ScrollLock lamp, the CapsLock lamp, and the NumLock lamp. To resume server operation in the normal state from the Secure Mode, enter the user password from the keyboard and press **Enter** key.

Server

Positioning the cursor on "Server" shows the Server menu.

The items which can be set on the Server menu and their functions are described below. For the setting, first select "System Management" or "Console Redirection" and press **Enter** to display the proper submenu.

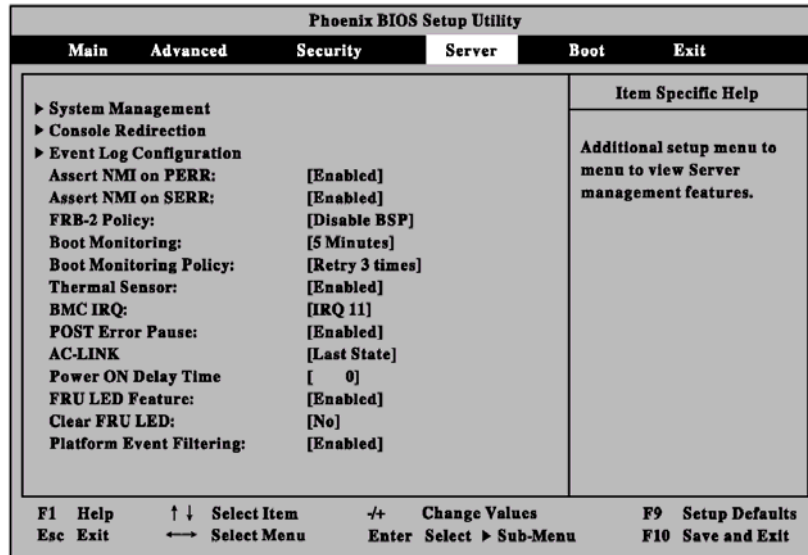

See the table below for the items.

Option	Parameter	Description	Your Setting
Assert NMI on PERR	Disabled [Enabled]	Indicates whether PCI PERR is supported or not. If this item is set "Enabled", the system offers an error through the NMI when an error occurred.	
Assert NMI on SERR	Disabled [Enabled]	Indicates whether PCI SERR is supported or not. If this item is set "Enabled", the system offers an error through the NMI when an error occurred.	
FRB-2 Policy	Disable FRB2 Timer [Disable BSP] Do Not Disable BSP Retry 3 Times	Set this item to "Disable BSP".	
Boot Monitoring	[Disabled] 5 minutes 10 minutes 15 minutes 20 minutes 25 minutes 30 minutes 35 minutes 40 minutes 45 minutes 50 minutes 55 minutes 60 minutes	Indicates whether the boot monitoring function is enabled or disabled on booting. To use this function, install ESMPRO Agent. Do not use this function if the system is booted from operating system without installation of ESMPRO Agent or CD-ROM. Set this item to "Disabled" if ARCserve uses the Disaster Recovery Option.	

Option	Parameter	Description	Your Setting
Boot Monitoring Policy	[Retry 3 Times] Retry Service Boot Always Retest	Appears when the boot monitoring feature is enabled. This item indicates the processing at the occurrence of timeout during boot monitoring. If [Retry 3 times] is selected, the system is reset after the occurrence of timeout and operating system boot is retried up to three times. The failure in the third boot causes the boot to be tried from the service partition. If [Retry Service Boot] is selected, the system is reset after the occurrence of timeout and operating system boot is retried up to three times. Then the boot is tried from the service partition for three times. If [Always Retest] is selected, the system is reset after the occurrence of timeout and operating system boot is retried repeatedly.	
Thermal Sensor	Disabled [Enabled]	Indicates whether the temperature sensor monitoring function is enabled or disabled.	
BMC IRQ	Disabled [IRQ 11]	Indicates the IRQ of the BMC interrupt.	
Post Error Pause	Disabled [Enabled]	Indicates whether POST is aborted once at the end of POST if an error occurs during the execution of POST.	
AC-LINK	Stay Off [Last State] Power On	Indicates the AC-LINK function. Shows the state of the power of the server.	
Power ON Delay Time	[0] - 255	Sets the power on delay time when "Power On" or "Last State" is specified for AC LINK.	
FRU LED Feature	Disabled [Enabled]	Select "Enabled" to turn on the error lamp to identify the location if the system detects a failure.	
Clear FRU LED	[No] Yes	Select "Yes" to turn off the FRU LED. When the faulty component is replaced, turn off the FRU LED.	
Platform Event Filtering	Disabled [Enabled]	Enables or disables the Platform Event Filtering feature of the baseboard management controller (BMC).	

[]: Factory-set

The table below shows the operation when the AC power to the server is turn off once and then on again, depending on the setting of "AC-LINK."

System status before AC power off	Setting of AC-LINK		
	Stay Off	Last State	Power On
Operating	Off	On	On
Aborting (DC power being off also)	Off	Off	On
Forced shutdown	Off	Off	On

* Press the power switch continuously at least four seconds. This forcibly turns off the power.

IMPORTANT: Set this item to "Power on" in order to link the AC power source supplied from UPS when the server is connected to UPS.

System Management

Selecting "System Management" on the Server menu shows the following screen.

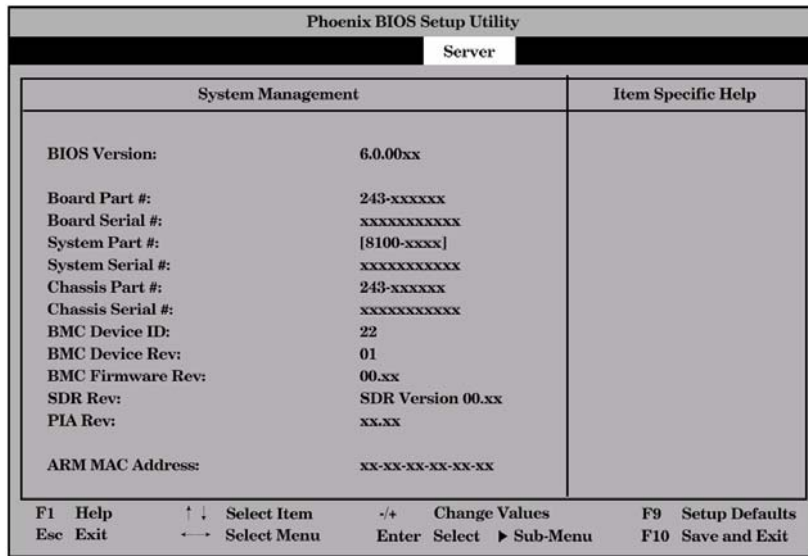

See the table below for the items.

Option	Parameter	Description	Your Setting
BIOS Version	–	Indicates the version of BIOS. (Display only)	
Board Part #	–	Indicates the IO board information. (Display only)	
Board Serial #	–		
System Part #	–	Indicates the system information. (Display only)	
System Serial #	–		
Chassis Part #	–	Indicates the chassis information. (Display only)	
Chassis Serial #	–		
BMC Device ID	–	Indicates the BMC (Baseboard Management Controller) information. (Display only)	
BMC Device Rev	–		
BMC Firmware Rev	–		
SDR Rev	–	Indicates the revision of SDR (Sensor Data Record). (Display only)	
PIA Rev	–	Indicates the revision of PIA. (Display only)	
ARM MAC Address	–	Indicates the default DNS (Hostname) of Management LAN Port. (Display only)	

[]: Factory-set

Console Redirection

Selecting "Console Redirection" on the Server menu shows the following screen.

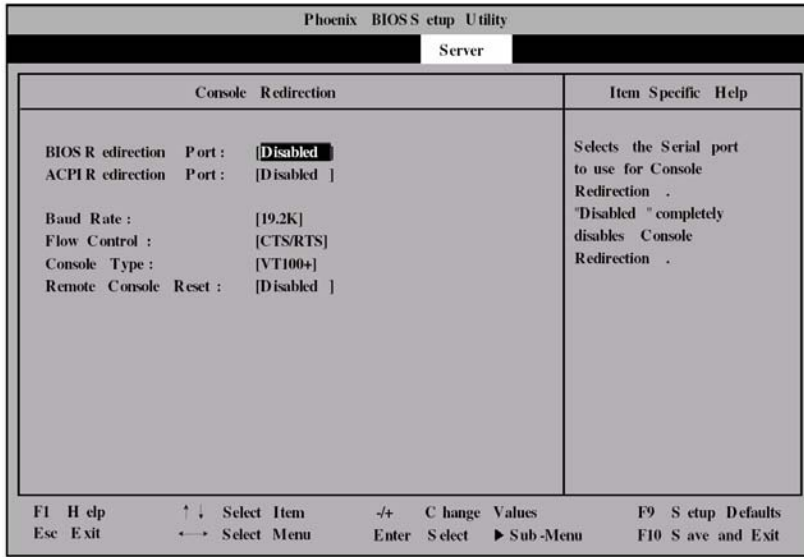

See the table below for the items.

Option	Parameter	Description	Your Setting
BIOS Redirection Port	[Disabled] Serial Port A Serial Port B	Selects the port to be used as the redirection port. The parameters specified in Peripheral Configuration submenu is used as address and interrupt.	
ACPI Redirection Port	[Disabled] Serial Port A Serial Port B	Specify the I/O port address or interrupt level used in ACPI headless console redirection. If [Disabled] is selected, console redirection feature is disabled.	
Baud Rate	9600 [19.2K] 38.4K 57.6K 115.2K	Specify the baud rate used for the interface with successive hardware consoles.	
Flow Control	None XON/XOFF [CTS/RTS] CTS/RTS+CD	Specify the flow control method.	
Console Type	PC ANSI [VT100+] VT-UTF8	Specify the console type.	
Remote Console Reset	[Disabled] Enabled	Specify whether the reset from remote console is enabled or disabled.	

[]: Factory-set

Event Log Configuration

Selecting "Event Log Configuration" on the Server menu and pressing **Enter** shows the following screen.

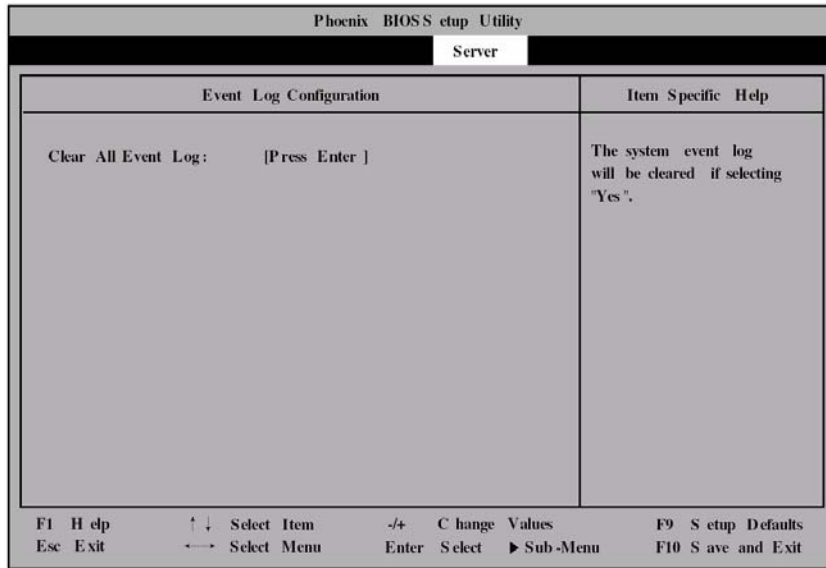

See the table below for the items.

Option	Parameter	Description	Your Setting
Clear All Event Log	–	Press Enter and select "Yes" to clear the system event log.	

[]: Factory-set

Boot

Positioning the cursor on "Boot" shows the Boot menu which is used to set the boot priority.

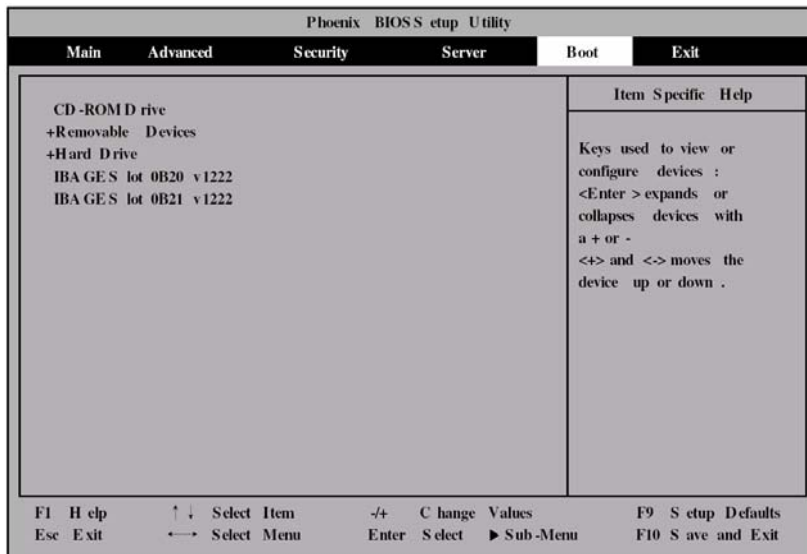

The server searches for devices in the order set in this menu on booting. Finding the boot software, the server starts the software.

The priority of the boot devices can be changed by using the ↑, ↓, +, and - keys. Move the cursor to the desired device with the ↑ or ↓ key and change the priority with the + or - key.

IMPORTANT: To boot EXPRESSBUILDER, set the priority of the devices as shown in the figure above.

Exit

Positioning the cursor to "Exit" shows the Exit menu.

The options on the menu are described below.

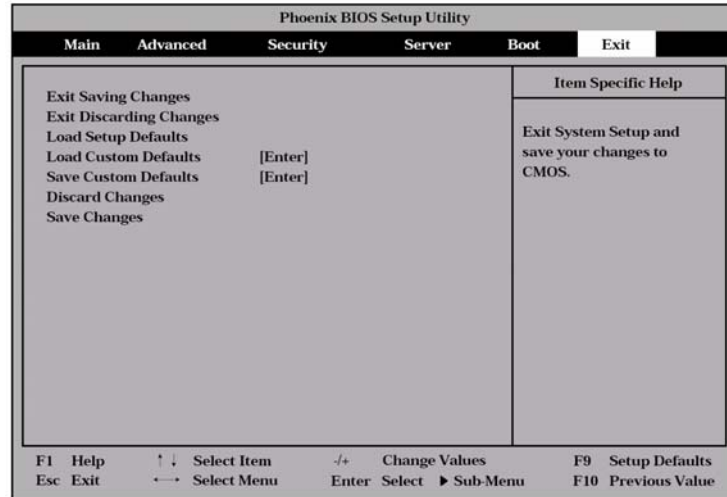

Exit Saving Changes

Select this item to terminate SETUP after saving the newly selected information in CMOS (non-volatile memory). The selection of "Exit Saving Changes" causes the confirmation screen to appear.

If you select "Yes," SETUP is terminated with the newly selected information saved in CMOS (non-volatile memory). Then the server automatically reboots the system.

Exit Discarding Changes

Select this item to terminate SETUP without saving the newly selected information in CMOS (non-volatile memory).

Selecting "Yes" allows SETUP to be terminated without storage of the modified information. If the setting value is modified, the confirmation screen will appear.

Selecting "No" allows SETUP to be terminated without storage of the modified information. If you select "Yes" in the next screen, SETUP is terminated with the modified information saved in CMOS. Then the server automatically reboots the system.

Load Setup Defaults

Select this item to return all the values of SETUP to the default values. Selecting "Load Setup Defaults" causes the confirmation screen to appear.

Select "Yes" to return the values to the default values. Select "No" to return to the Exit menu screen.

Save Custom Defaults/Load Custom Defaults

Running the Save Custom Defaults menu saves the current SETUP parameters as the user-defined SETUP defaults. The Load Custom Defaults menu is used to restore the user-defined SETUP defaults.

Discard Changes

Select this item to return the values modified currently to the previous values before saving the values to CMOS. Selecting "Discard Changes" causes the confirmation screen to appear.

Select "Yes" to discard the newly selected information and return to the previous values.

Save Changes

Select this item to save the newly selected information to CMOS (non-volatile memory) without the termination of SETUP. Selecting "Save Changes" causes the confirmation screen to appear.

Select "Yes" to save the newly selected information to CMOS (non-volatile memory)

DISK ARRAY CONFIGURATION – MegaRAID Configuration Utility –

MegaRAID Configuration Utility is a software application to configure the built-in hard disk drives in disk array configuration using the onboard disk array controller.

Notes on Using

Note the followings to correctly configure the disk array:

- There are different levels of recording RAID. This system supports RAID0, RAID1 and RAID5.

- RAID 0

Stores data on hard disks by dividing it (striping.)

Striping is a technology to store data on disks according to some rules.

Data is divided to be stored on multiple hard disks.

Where is the figure? All hard disks can be accessed at the same time. This improves disk access performance compared with using a single hard disk.

IMPORTANT: RAID0 does not have data redundancy. When hard disk failure occurs, data cannot be restored.

- RAID 1

Stores the data being saved to one hard disk drive to another hard disk drive.

This method is called "mirroring." When storing data onto one hard disk drive, the same data is simultaneously stored onto another hard disk drive. When a hard disk drive becomes faulty, the one with the same data can be used.

This provides operation without the system going down.

- RAID 5

Stores data onto hard disk drives by dividing it (striping) in the same way as RAID0. With RAID5, parity (redundant data) is also divided and stored on multiple hard disks. This is called "distributed parity."

Distributed parity uses one section of a line divided with the set stripe size on hard disks in order.

Data is saved in the following order: Stripe1, Stripe2, created parity. Disk space allocated as a parity section is the same as one hard disk within the RAID5 configuration.

Even if one of the configured hard disks becomes faulty, data can be used without any problem.

- When you have configured or changed the disk array configuration, make a backup copy of the configuration information. You can use the Power Console Plus to make a backup copy. See the online document "Power Console Plus User's Guide" stored in the EXPRESSBUILDER CD-ROM.
- Check the consistency of disk array system on a regular basis.

Consistency check is available for RAID5 or RAID1 only. Use one of the following three methods to check consistency.

 - Check by using this utility (described later in this section).
 - Perform scheduled task from the command prompt after operating system start-up. (Refer to the online document "Power Console Plus User's Guide" stored in the EXPRESSBUILDER CD-ROM or the manual that comes with the option board.)
 - Check by using the Power Console Plus. (Refer to the online document "Power Console Plus User's Guide" stored in the EXPRESSBUILDER CD-ROM.)
- You can use the Power Console Plus to rebuild the failed hard disk drive as well as this utility. (Refer to the online document "Power Console Plus User's Guide" stored in the EXPRESSBUILDER CD-ROM.)
- If a hard disk drive is specified as the standby disk, the data in the failed hard disk drive can be automatically

recovered by using the auto rebuild feature. The hard disk drive to be used as a standby disk must have the same capacity and the same rotational speed as those of the other hard disk drives.

- The following 5 types of hard disk status are displayed by MegaRAID Configuration Utility. Each status is explained below:

[READY] Not yet configured.

[ONLIN] The disk is turned on and ready for normal operation. Configured into a pack.

[HOTSP] The disk is on and in Hot spare disk status.

[FAIL] Judged to be faulty by the controller. Cannot be used.

[REBLD] Being rebuilt.

Starting Configuration Utility

MegaRAID Configuration Utility is stored in the BIOS of RAID controller on I/O board and started during POST activation.

Starting MegaRAID Configuration Utility

Check that the following is displayed when you turn the power on your server

- The manufacturer's logo
- The message " Press <F2> to enter Setup, <F4> Service Partition, <F12> Network"

Then press **Esc**, POST screen is displayed.

Check that the following is displayed in the POST screen, then press **Enter**.

```
LSI MegaRAID SCSI 320 BIOS                               Ver x.xx MMM DD,YYYY
Copyright(c) LSI Logic Corp.
HA-x(Bus x Dev x) MegaRAID SCSI 320-2
Standard FW xxx DRAM=128MB(SDRAM)
x Logical Drives found on the Host Adapter.
x Logical Drive(s) handled by BIOS
Press <Ctrl><M> or <Enter> to Run MegaRAID Configuration Utility
or Press <Ctrl><H> for WebBIOS
```

NOTE: When **Ctrl + H** is blinking onscreen, do not press **Ctrl + H**. If you press these keys, WebBIOS starts after POST is completed. When WebBIOS is started, click [Control-M] at the upper right of the screen to start MegaRAID Configuration Utility.

MegaRAID Configuration Utility: TOP menu (Management Menu) screen

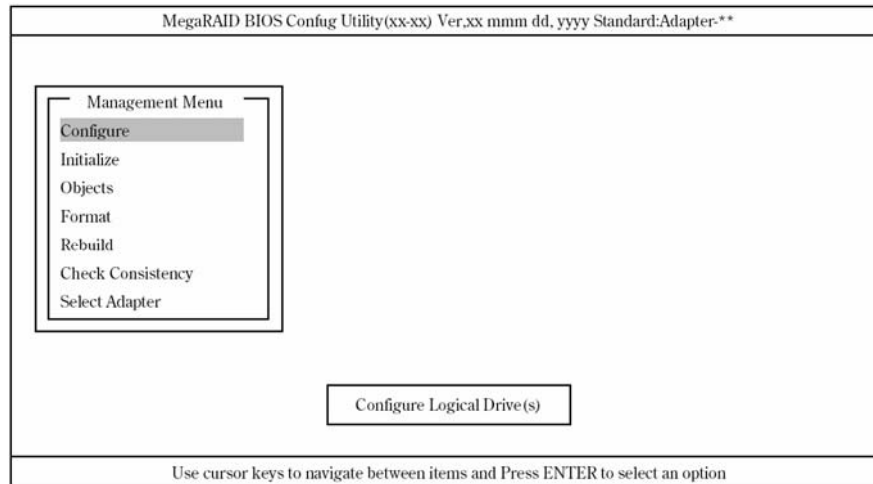

NOTE: In some cases, the following display appears in the POST screen after replacing the I/O board. This indicates that both the disk array controller and hard disk have configuration information, and they do not match. (Shown below is a sample display.)

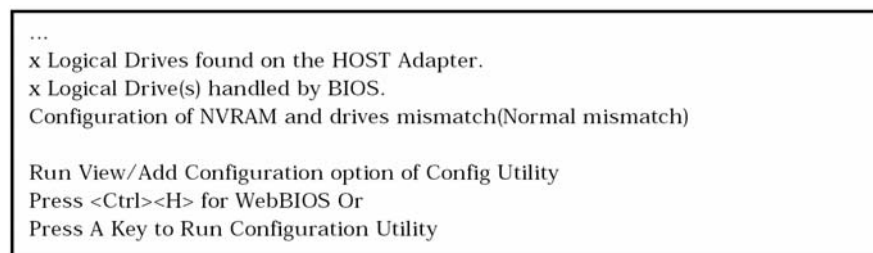

Exiting from MegaRAID Configuration Utility

Press **Esc** in the TOP menu of MegaRAID Configuration Utility.

When a confirmation message appears, select [Yes].

Please Press Ctrl-Alt-Del to REBOOT the system.

When the above message appears, press **Ctrl+Alt+Delete**.

The server is rebooted.

Menu Tree

Setting list

+: Selection/execution parameter * : Setting parameter. • : Information display
> : Can be set (modified) after creation of logical drive, #: Cannot be executed

Menu	Description
+Configure	Performs Configuration settings
+Easy Configuration	Set configuration (Using fixed value)
+New Configuration	Set new configuration
+View/Add Configuration	Additional setting / viewing configuration
+Clear Configuration	Clear configuration
+Specify Bootable Logical Drive	Chose Bootable Logical Drive
+Initialize	Initialize logical drive
+Objects	Various settings

Menu	Description
+Adapter	Set disk array controller
+Clear Configuration	Clear configuration
*1 *FlexRAID PowerFail	Set whether to restart after rebuilding
*2 *Fast Initialization	Set high-speed initialization
*3 *Disk Spin up Timing	Set hard disk spin-up
*4 *Cache Flush Timing	Set cache flush timing
*5 *Rebuild Rate	Set rebuild rate
*6 *Alarm Control	Set alarm sound (ON / OFF)
+Other Adapter Information	Board information display (FW version, etc.)
• FW Supports	FW type
• FW Ver	FW version
• BIOS Ver	BIOS version
• DRAM	Memory capacity
• Adapter Type	Board series NO.
+Factory Default	Set default value
*7 *Disable (Enable) BIOS	Set BIOS Enable / Disable
+Battery Information	Battery information
• Backup Module	Existence of battery module
• Battery Pack	Existence of battery pack
• Temperature	Battery temperature
• Voltage	Battery voltage
• Fast Charging	Set fast charging status
• No of Cycles	The number charge cycle
+Reset Battery Charge Counter	Clear battery charge counter
+Other Adapter Options	Adapter detailed options
*8 *Emulation	Set control mode
*9 *Auto Rebuild	Set auto rebuilding Enable / Disable
• Initiator ID	Indicate Initiator ID No.
*10 *Cluster Mode	Set cluster mode
*11 *Multiple PCI Delayed Trans	Set PCI bus bridge
*12 *Force Boot	Forced setting of configuration information(HDD)
*13 *Coercion Algorithm	Setting parameter for maximum hard disk capacity
*Abort BI & CC Activities	Abort Background initialize or Check Consistency
*14 *CC Restoration	Select CC Restoration mode
*15 *Temporary Offline RAID	Set Temporary offline Enable / Disable
+Logical Drive	Logical drive operation
+Logical Drives	Select logical drive
+Initialize	Initialize logical drive
+Check Consistency	Check logical drive redundancy
+View/Update Parameters	Display logical drive information
• RAID	Display RAID level
• SIZE	Display logical drive capacity
• Stripe SIZE	Display stripe size
+√ Write Policy	Set write mode
+√ Read Policy	Set read mode
+√ Cache Policy	Set cache mode
+√ FlexRAID Virtual Sizing	Set virtual sizing Enable / Disable *Do not set to Enable
• #Stripes	Display stripe size
• State	Display logical drive status
+Physical Drive	Physical drive menu
+Physical Drive Selection Menu	Physical drive operation
+Rebuild	Perform rebuilding
+Format	Perform low level format *Do not use
+Make Online	Set the disk online

Menu	Description
+Fail Drive	Set the disk offline
+Make HotSpare	Set as stand-by disk for auto rebuilding
+View Drive Information	Display hard disk information
• Device Type	Hard disk type
• Capacity	Hard disk capacity
• Vender ID	Hard disk vender name
• Product ID	Hard disk model
• Revision	Hard disk revision
• SCSI Standard	SCSI standard
• Media Errors	The number of media errors
• Other Errors	The number of other errors
*16 *Synchronous Negotiation	SCSI synchronous negotiation
*17 *SCSI Command Q Tagging	Set SCSI command Q Tag
+Channel	Set channel
+Channels	Chose SCSI channel
*18 *Termination State	Set termination state
*19 *Enable Auto Termination	Set auto termination state
*20 *SCSI Transfer rate	Set transfer rate
+Format	Perform low level format *Do not use
+Rebuild	Perform rebuilding
+Check Consistency	Perform logical drive redundancy check
+Select Adapter	Select disk array controller * This menu item does not appear if no disk array controller is installed in the computer.

Setting values

No.	Setting parameter	Factory setting	Setting change
*1	FlexRAID PowerFail	ENABLED	Do not change
*2	Fast Initialization	ON	Variable setting
*3	Disk Spin-up Timing	2 disks every 6 secs	Do not change
*4	Cache Flush Timing	Every 4 Seconds	Do not change
*5	Rebuild Rate	30%	Variable setting
*6	Alarm Control	Disable Alarm	Do not change
*7	Disable(Enable) BIOS	Enable (Display: Disable BIOS)	Do not change
*8	Emulation	MASS STORAGE	Do not change
*9	Auto Rebuild	ENABLED	Do not change
*10	Cluster Mode	DISABLED	Do not change
*11	Multiple PCI Delayed Trans	ENABLED	Do not change
*12	Force Boot	ON	Do not change
*13	Coercion Algorithm	NONE	Do not change
*14	CC Restoration	ENABLED	Variable setting
*15	Temporary Offline RAID	ENABLED	Do not change
*16	Synchronous Negotiation	Enabled	Do not change
*17	SCSI Command Q Tagging	Enhanced QTAG Scheduling	Do not change
*18	Termination State	Enabled	Do not change
*19	Enable Auto Termination	No	Do not change
*20	SCSI Transfer rate	320M	Do not change

Changing factory settings

The settings for the following items can be changed. Follow each explanation:

- | | | |
|-----|---------------------|--|
| *2 | Fast Initialization | A setting of "On" is recommended.
This initializes the top area of the disk only. |
| *5 | Rebuild Rate | A setting of "30%" is recommended. |
| *14 | CC Restoration | Factory setting is "ENABLED". |

IMPORTANT:

- Notice status display of "Disable (Enable) BIOS".
Selected Enable : Indicate "Disable BIOS"
Selected Disable: Indicate "Enable BIOS"
- When "Factory Default" is executed, the setting values are changed.
Set each parameter after executing "Factory Default."
- Some versions of MegaRAID Configuration Utility change the "Factory Default" setting value.
Check each parameter setting after executing "Factory Default."
- The server must be restart after executing "Factory Default."

Operating Procedures for Configuration Utility

Creating/adding configuration

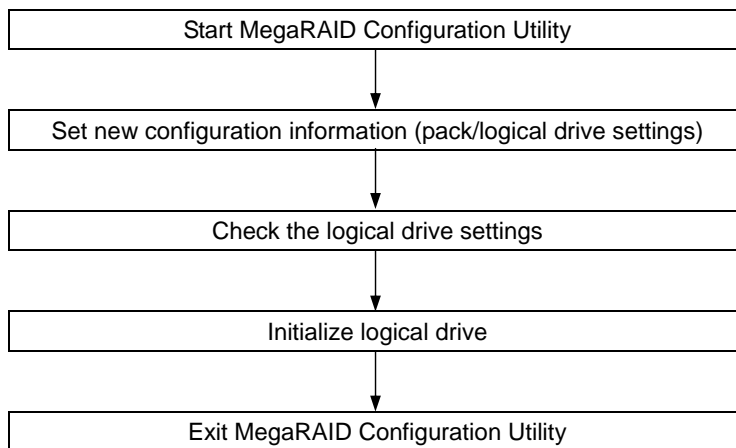

Procedures

1. Start MegaRAID Configuration Utility to check each setting parameter.
2. Select "Configure" → "New Configuration" from the TOP menu (Management Menu).
Select "View/add Configuration" to add configuration.

IMPORTANT:

- When a new configuration is created by selecting "New Configuration," the existing configuration information is cleared. To add configuration information to that existing, select "View/add Configuration."
- "Easy Configuration" cannot set logical drive capacity or create SPANNING OF RAID1. Select "New Configuration" or "View/add Configuration" to execute these.

3. When a confirmation message (Proceed?) is displayed, select "Yes."

4. When SCAN DEVICE is started (scanning information is displayed at the bottom of the screen) and ends, the "New Configuration - ARRAY SELECTION MENU" screen appears.

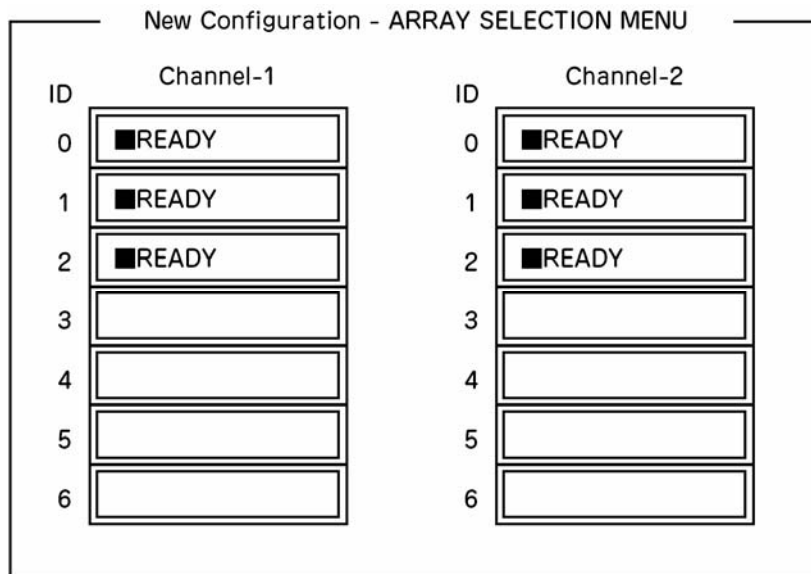

5. Move the cursor onto the hard disk to be packed by using cursor key and then press **Space** to select the hard disk. (The display for the selected hard disk changes from READY to ONLIN and Axx-xx blinks.)

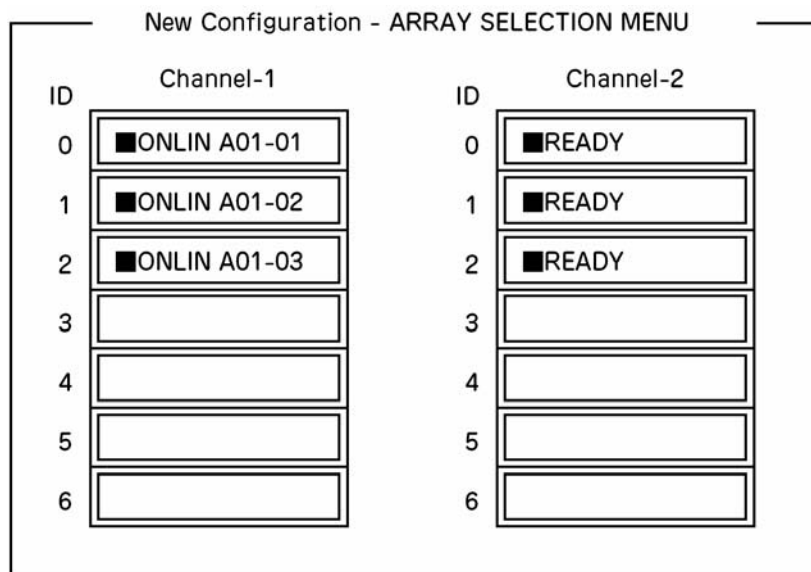

IMPORTANT: The channel number displayed on MegaRAID Configuration Utility is different from hardware channel number printed on the controller board.

Channel number printed on the board	CH0	CH1
Channel number displayed on MCU	Channel-1	Channel-2

6. When the hard disk is selected, press **Enter** to fix the selection (blinking stops.)

7. Press **F10** to create logical drive. The "Logical Drives Configure" screen appears.

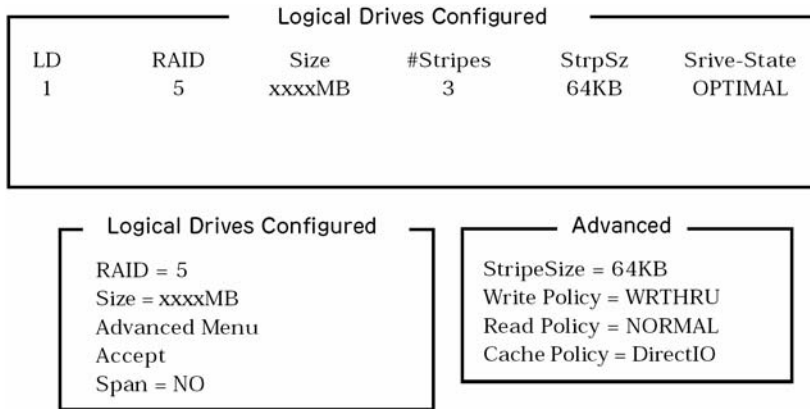

8. Select "RAID," "Size" or "Advanced Menu" by using cursor keys. Then press **Enter** to fix the selection and set each value. Selecting "Advanced" displays the Advanced screen.

– "RAID": Sets RAID level.

Parameter	Remarks
0	-
1	-
5	-

The selectable RAID level varies depending on the number of hard disks that configure a pack.

– "Size": Sets logical drive size.

Up to 40 logical drives can be created per disk array controller.

– "Advanced Menu"

(a) "Stripe Size": Sets stripe size.

Parameter	Remarks
248	–
16	–
32	–
64	Default display: recommended set value
128	

(b) "Write Policy": Sets write policy.

Parameter	Remarks
WRTHRU	Write through
WRBACK	Write back (Default display)

(c) "Read Policy": Sets read policy.

Parameter	Remarks
NORMAL	Does not perform read ahead. Default display: recommended set value
READAHEAD	Read ahead
ADAPTIVE	Performs read ahead when sequential sectors are accessed twice consecutively.

(d) "Cache Policy": Sets cache policy.

Parameter	Remarks
Cached IO	Caches the data read from a hard disk and then transfers it to the server.
Direct IO	Default display: recommended set value

(e) "Span": Sets Span.

Parameter	Remarks
CANSPAN	SPAN=YES
NOSPAN	SPAN=NO

When SPAN setting is available for the hard disk configuration of the pack, "YES" is displayed by default.

When performing SPAN, create 2 or more sets of the same pack at pack creation. (For SPANNING OF RAID1 creation; refer to "Setting SPAN" described later for detailed procedures.)

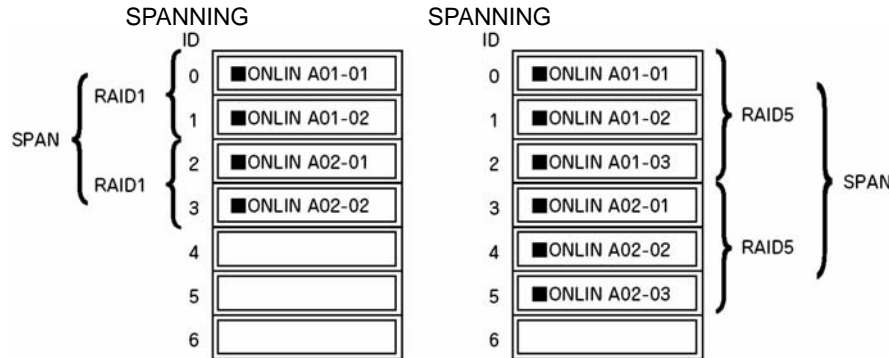

9. When all settings are completed, select "Accept" and then press **Enter** to create logical drive. The created logical drive is displayed in the "Logical Drive Configured" screen.
10. After creating logical drive, press **Esc** to close the screen. Go back to the "Save Configuration?" screen and then select "Yes" to save the configuration.
11. When the confirmation message shows that the configuration was saved, press **Esc** to return to the TOP menu screen.
12. In the TOP menu screen, select "Objects" → "Logical Drive" → "View/Add Parameters" to check logical drive information. Setting values for "Write Policy," "Read Policy" and "Cache Policy" can be changed.

IMPORTANT: Be sure to check that "FlexRAID Virtual Sizing" is set to "DISABLED."

Do not set it to "ENABLED."

The virtual sizing function shows the operating system a large disk capacity virtually. Improper operation thus may disable operating system installation or disk capacity allocation.

13. Select "Initialize" in the TOP menu screen.
14. The "Logical Drives" screen appears to select the logical drive to be initialized. Pressing **F2** selects all logical drives displayed.
15. After selecting logical drive, press **F10** to start initialization. A confirmation screen for execution appears. Select "Yes" to start initialization.
16. When the meter display in the "Initialize Logical Drive Progress" screen indicates 100%, initialization is completed.
17. Press **Esc** to return to the TOP menu and exit MegaRAID Configuration Utility.

Manual rebuilding

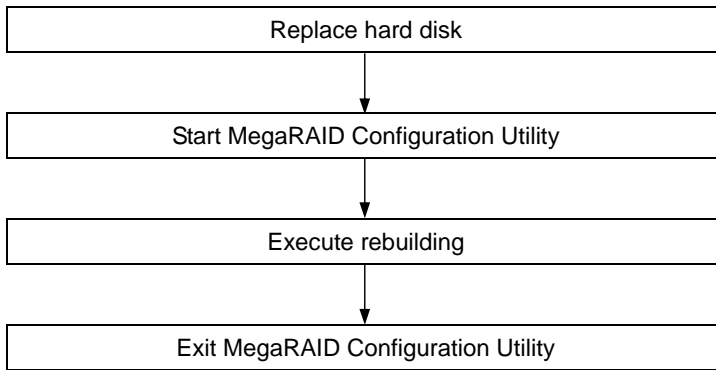

Procedures

1. Replace a hard disk and turn on the controller.
2. Start MegaRAID Configuration Utility to check each setting parameter.
3. Select "Rebuild" from the TOP menu to display the "Rebuild – PHYSICAL DRIVES SELECTION MENU" screen shown below.

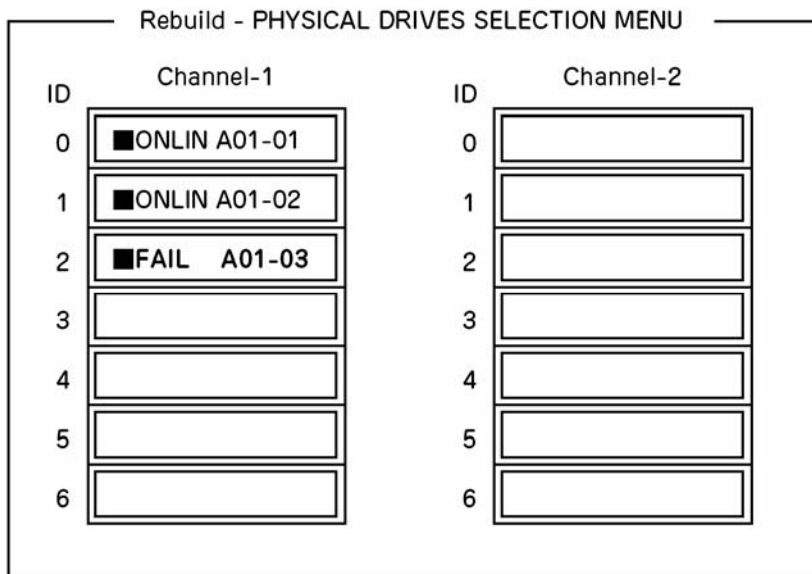

4. Move the cursor onto the hard disk displaying "FAIL," and then press **Space** to select it. Multiple hard disks can be selected (simultaneous rebuilding.)
5. The "FAIL" display for the hard disk selected starts blinking.
6. When hard disk selection is completed, press **F10** to start rebuilding.
7. A confirmation screen for execution appears. Select "Yes" to start rebuilding.
8. When the meter display in the "Rebuild Physical Drives in Progress" screen indicates 100%, rebuilding is completed.
9. Press **Esc** to return to the TOP menu and exit MegaRAID Configuration Utility.

Setting hot spare

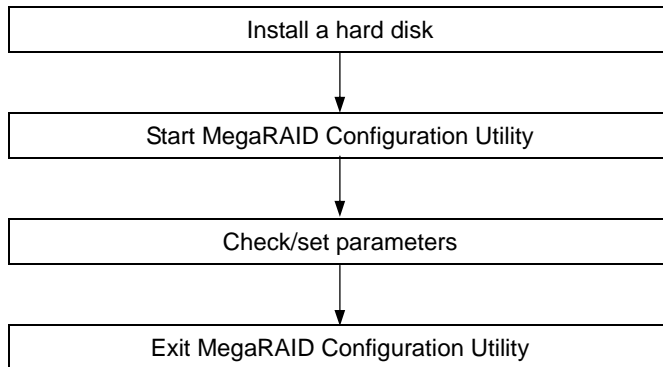

Procedure

1. Install a hard disk to be used as hot spare, and then turn the server on.
2. Start MegaRAID Configuration Utility to check each setting parameter.
3. Select "Objects" → "Physical Drive" from the TOP menu to display the "Objects - PHYSICAL DRIVE SELECTION MENU" screen shown below.

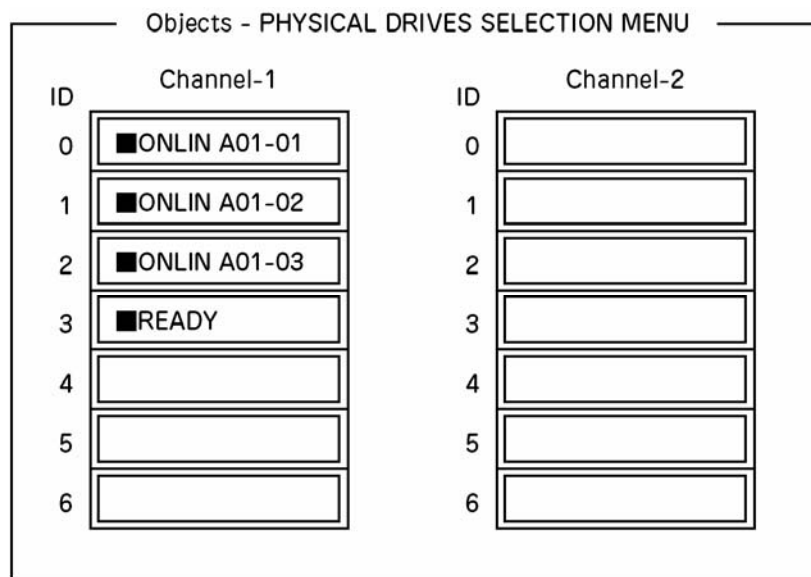

4. Move the cursor onto the hard disk to be used as hot spare and press **Enter**.
5. The "Channel X,Target X" screen appears. Select "Make HotSpare."
6. A confirmation screen appears. Select "Yes."
7. The hard disk display is changed to "HOTSP."

8. Press **Esc** to return to the TOP menu and exit MegaRAID Configuration Utility.

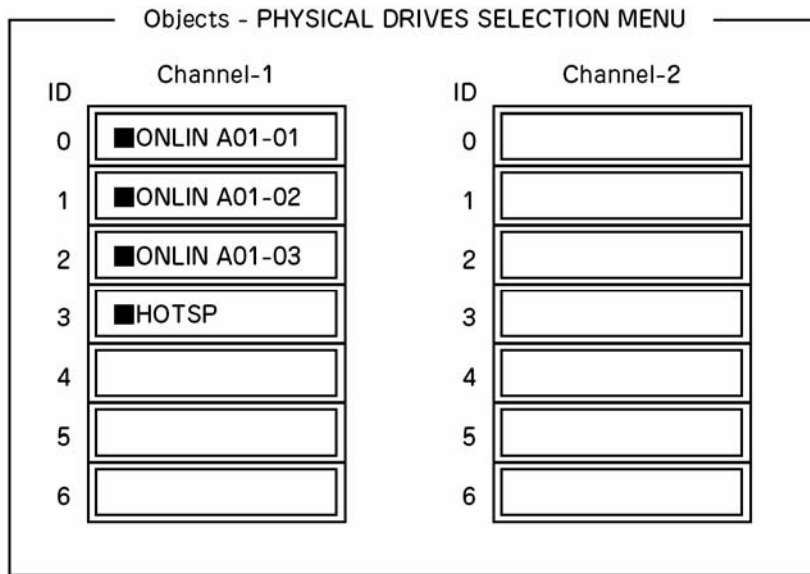

NOTES:

- Select "Objects" → "Physical Drive" → "Fail Drive" to cancel the hot spare setting.
- When there are 2 or more hard disks (of the same capacity) set as hot spare, rebuilding is performed in order starting from the one with the smaller CH number/ID number.

Checking consistency

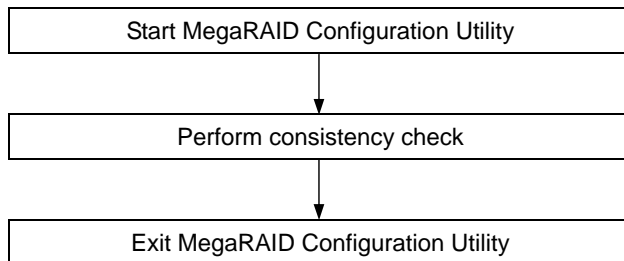

Procedure

1. Start MegaRAID Configuration Utility.
2. Select "Check Consistency" from the TOP menu.
3. The "Logical Drives" screen appears. To run the consistency check, move the cursor onto the logical drive and press **Space** to select it. Pressing **F2** selects all logical drives.
4. When logical drive selection is completed, press **F10** to start consistency check.
A confirmation screen for execution appears. Select "Yes" to start consistency check.
5. When the meter display in the "Check Consistency Progress" screen indicates 100%, the consistency check is completed.
6. Press **Esc** to return to the TOP menu and exit MegaRAID Configuration Utility.

IMPORTANT: Be sure to perform consistency check after creating configuration.

Setting SPAN

The setting procedure for SPANNING OF RAID1 and SPANNING OF RAID5 are shown below

SPANNING OF RAID1

1. Open the configuration creation screen.

Select "Configure" → "New Configuration" from the TOP menu to display the screen shown below. This is the Channel-1 menu screen where the cursor is put on ID=0 position:

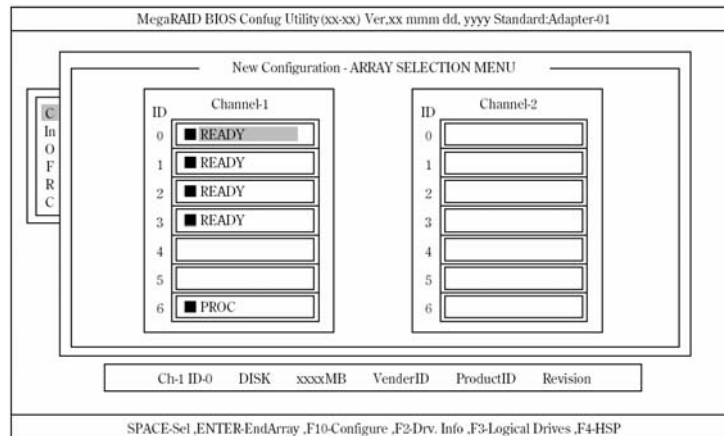

2. Select ID-0/1 hard disks.

Pressing **Space** changes the display for Channel-1, ID=0 to "ONLIN A01-01" where "A01-01" is blinking. (The cursor automatically moves to Channel-1, ID=1.) In the same way, press **Space** on Channel-1, ID=1. (Where "A01-02" is blinking, the cursor moves to Channel-1, ID=2.) After selecting 2 hard disks (Channel-1, ID=0/Channel-1, ID=1), press **Enter** to determine the settings. (Display on each hard disk stops blinking.)

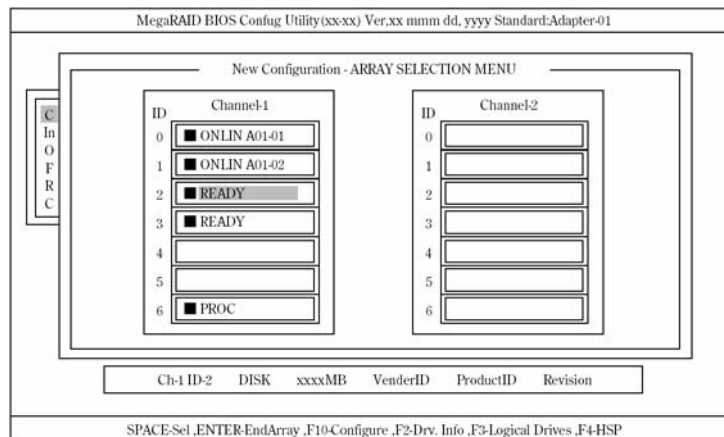

3. Select ID-2/3 hard disks.

Same as for Channel-1 for ID-0/1, press **Space** in the status described in 2 to select Channel-1 for ID-2/3 and then press **Enter** to determine the selection. ("ONLIN A02-01/02" is then displayed.)



4. Set logical drive.

Pressing **F10** in the status described in 3 displays a screen shown below. Set each item. Then select "Advance Menu" to display the "Advanced" sub menu screen.

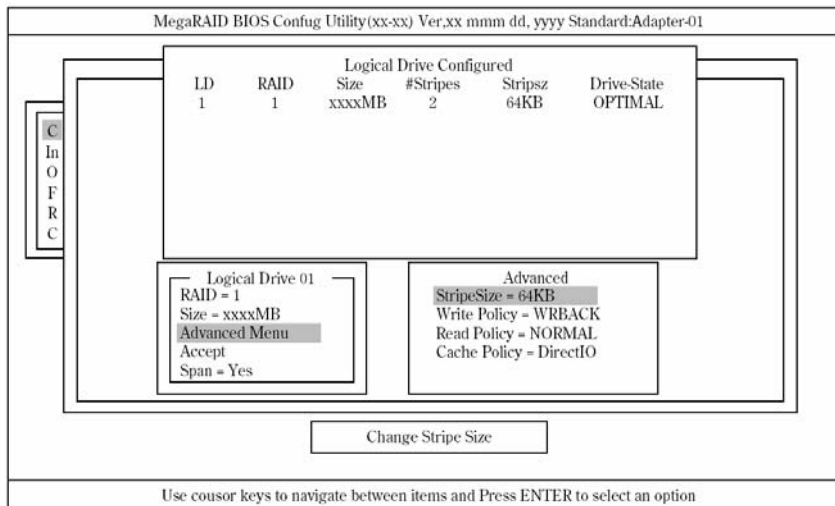

The setting contents are shown below:

Setting item		Default (initial value)	Setting range
RAID		1	0, 1
Size		Full capacity (logical drive)	Full capacity
Advanced	Stripe Size	64 KB	2/4/8/16/32/64/128
	Write Policy	WRBACK	WRTHRU WRBACK
	Read Policy	NORMAL	NORMAL READAHEAD ADAPTIVE
	Cache Policy	Direct IO	Direct IO Cache IO
Span		YES	CANSPAN (YES) NOSPAN (NO)

- To open the "Advanced" sub menu screen from the "Logical Drive XX" menu screen, select "Advanced Menu" and then press **Enter**. Press **Esc** to move to the "Logical Drive XX" menu screen. In this case, the cursor moves to "Accept."

- When creating SPANNING OF RAID1 system, set logical drive size to full capacity. SPAN setting is disabled when the logical drive size is changed.

5. Fix the settings

After settings explained in 4 are completed, select "Accept" in the "Logical Drive X" screen and then press **Enter** to fix the settings. When settings are fixed, logical drive display in the "Logical Drive Configured" screen changes from green (not fixed) to light blue (fixed). The display color for the drive reveals whether a setting is fixed or not.

To change the determined settings, press **Esc** to display the "Save Configuration?" screen and select "No." Start over from "New Configuration."

6. Save the settings

After fixing the settings in 5, press **Esc** or **Enter**. The "Save Configuration?" screen appears.

Select "YES" and press **Enter**.

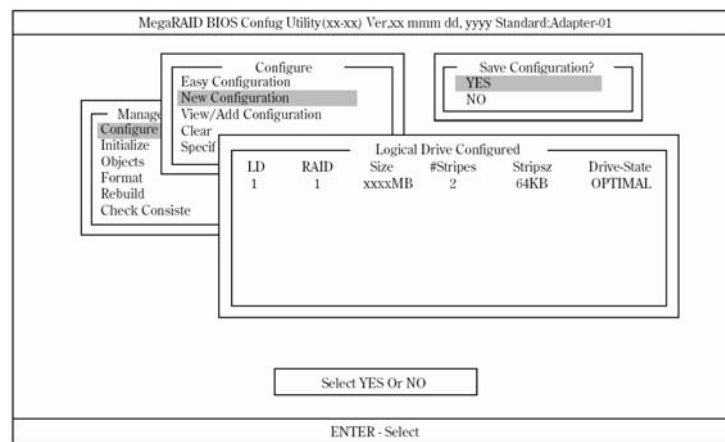

After saving is completed, a pop-up window displays a save completion message. Press any key to return to the "Configure" screen. This completes the SPANNING OF RAID1 logical drive creation procedure.

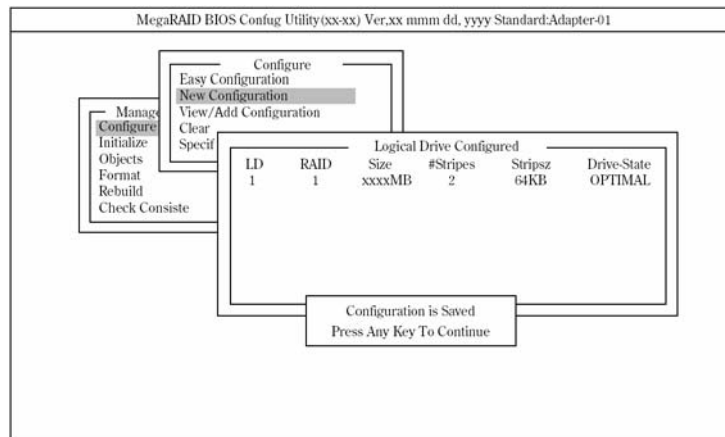

IMPORTANT: Be sure to perform "Initialize" and "Check Consistency" after logical drive creation.

SPANNING OF RAID5

1. Open the configuration creation screen.

Select "Configure" → "New Configuration" from the TOP menu to display the screen shown below. This is the Channel-1 menu screen where the cursor is put on ID=0 position:

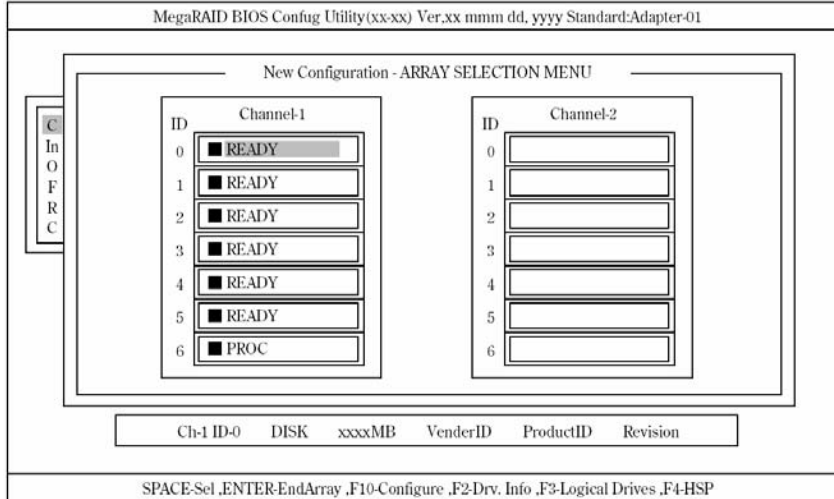

2. Select ID-0/1/2 hard disks.

Pressing **Space** changes the display for Channel-1, ID=0 to "ONLIN A01-01" where "A01-01" is blinking. (The cursor automatically moves to Channel-1, ID=1.) In the same way, press **Space** on Channel-1, ID=1. (Where "A01-02" is blinking, the cursor moves to Channel-1, ID=2.) In the same way, press **Space** on Channel-1, ID=2. (Where "A01-03" is blinking, the cursor moves to Channel-1, ID=3.) After selecting 3 hard disks (Channel-1, ID=0/Channel-1, ID=1/Channel-1, ID=2), press **Enter** to determine the settings. (Display on each hard disk stops blinking.)

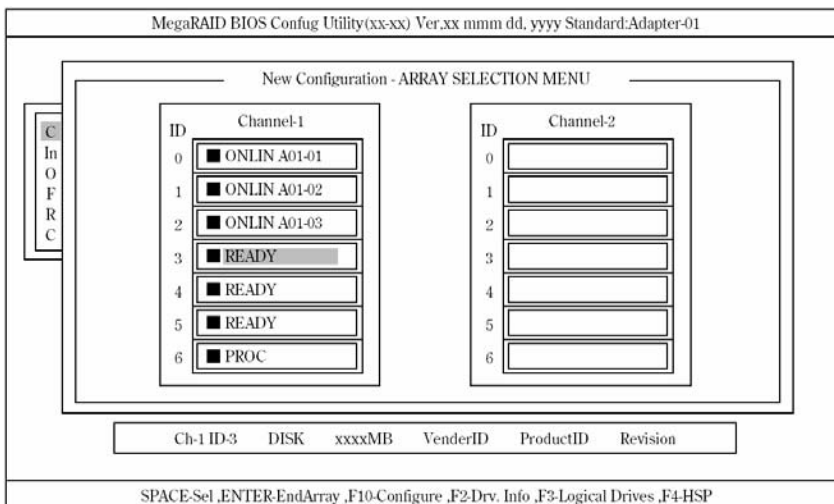

3. Select ID-3/4/5 hard disks

Same as for Channel for ID-0/1/2, press **Space** in the status described in 3 to select Channel for ID-3/4/5 and then press **Enter** to determine the selection. ("ONLIN A02-01/02/03" is then displayed.)

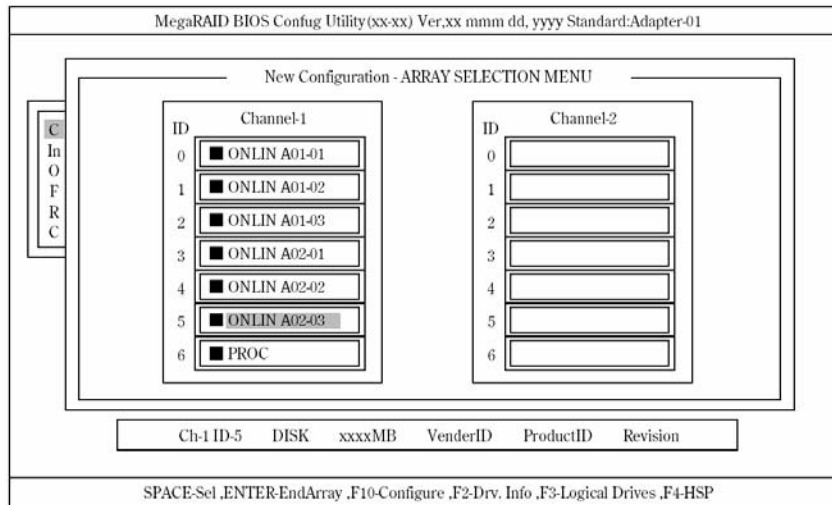

4. Set logical drive

Pressing **F10** in the status described in 3 displays a screen shown below. Set each item. Then select "Advance Menu" to display the "Advanced" sub menu screen.

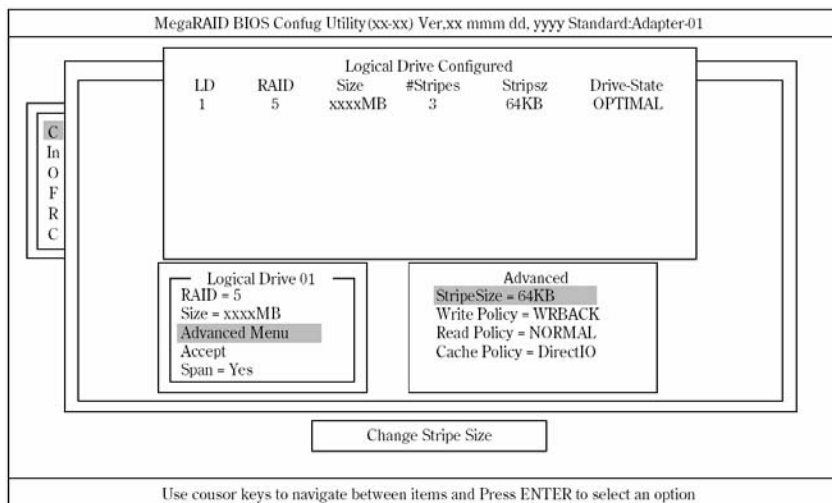

The setting contents are shown below:

Setting item		Default (initial value)	Setting range
RAID		5	0, 5
Size		Full capacity (logical drive)	Full capacity
Advanced	Stripe Size	64 KB	2/4/8/16/32/64/128
	Write Policy	WRBACK	WRTHRU WRBACK
	Read Policy	NORMAL	NORMAL READAHEAD ADAPTIVE
	Cache Policy	DirectIO	DirectIO CacheIO
Span		YES	CANSPAN (YES) NOSPAN (NO)

- To open the "Advanced" sub menu screen from the "Logical Drive XX" menu screen, select "Advanced Menu" and then press **Enter**. Press **Esc** to move to the "Logical Drive XX" menu screen. In this case, the cursor moves to "Accept."
- When creating SPANNING OF RAID5 system, set logical drive size to full capacity. SPAN setting is disabled when the logical drive size is changed.

5. Fix the settings.

After settings explained in 6 are completed, select "Accept" in the "Logical Drive X" screen and then press **Enter** to fix the settings. When settings are fixed, logical drive display in the "Logical Drive Configured" screen changes from green (not fixed) to light blue (fixed). The display color for the drive reveals whether a setting is fixed or not.

To change the determined settings, press **Esc** to display the "Save Configuration?" screen and select "No." Start over from "New Configuration."

6. Save the settings.

After fixing the settings in 5, press **Esc** or **Enter**. The "Save Configuration?" screen appears.

Select "YES" and press **Enter**.

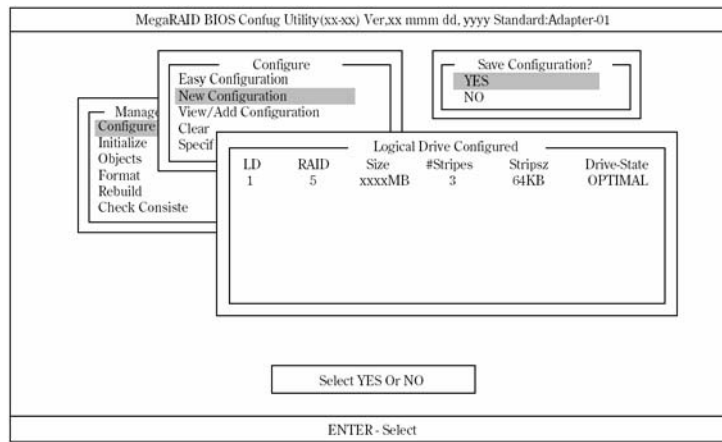

After saving is completed, a pop-up window displays a save completion message. Press any key to return to the "Configure" screen. This completes the SPANNING OF RAID5 logical drive creation procedure.

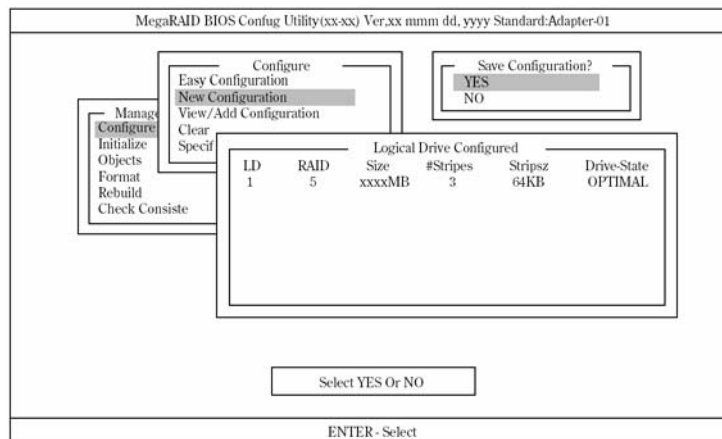

IMPORTANT: Be sure to perform "Initialize" and "Check Consistency" after logical drive creation.

Others

1. Select Adapter.

This menu item appears only if more than one MegaRAID host adapter is installed in the computer. Each configuration is executed in increments of controller. Number of adapter is defined by PCI slot location.

2. Clear Configuration.

Clears configuration information.

Select "Configure" → "Clear Configuration" from the TOP menu.

All configuration information on the disk array controller and hard disks is cleared when this function is executed.

Configuration information on all channels of the disk array controller is also cleared with this function.

NOTES:

- When configuration information on the disk array controller and the hard disk do not match (excluding at replacement of faulty disk array controller), configuration cannot be performed by selecting the configuration information on the disk array controller. In this case, perform "Clear Configuration" to create configuration again.
 - MegaRAID Configuration Utility cannot delete each logical drive. Use Power Console Plus.
-

3. Make Online.

Puts a hard disk in the FAIL status online.

Select "Objects" → "Physical Drive" → (select hard disk) → "Make Online" from the TOP menu.

4. Battery

- Indicate battery information

Select "Objects" → "Adapter" → "Battery Information" from the top menu.

Backup Module	PRESENT
	ABSENT
Battery Pack	PRESENT
	ABSENT
Temperature	GOOD
	HIGH
Voltage	GOOD
	LOW
Fast Charging	COMPLETED
	IN_PROGRESS
No of Cycle	***

- Clear battery charge counter

Select "Objects" → "Adapter" → "Reset Battery Charge Counter" from the top menu. Popup message appears. Select "Yes" and press **Enter**.

NOTES:

- Clear Battery Charge Counter when you exchange the battery.
 - The battery backup module must be replaced every two years or 500 times of charge and discharge.
-

5. Rebuild Rate

Sets rebuild rate.

Select "Objects" → "Adapter" → "Rebuild Rate" from the TOP menu.

Can be set in a range from 0% to 100%. The default value (recommended setting value) is "30%."

6. Hard disk information

Checks hard disk information.

Select "Objects" → "Physical Drive" → (select disk) → "View Drive Information" from the TOP menu.

REMOTE MANAGEMENT FUNCTION

Remote Management Function enables your system to monitor the status of power supply unit, fan and temperature of servers by BMC (Baseboard Management Controller) and a remote KVM (Keyboard, Video, Mouse) console feature by communicating through a management LAN PORT feature.

NOTE: The screen which can be displayed by the remote KVM side becomes resolution 1024x768 and less than refresh rate 75Hz.

Since a screen is not displayed by remote PC when a setup beyond this is performed, please set it as less than this.

Moreover, if many numbers of colours of a screen are set up, an exact colour may be unable to be displayed by remote PC.

When your server is connected to the network where broadcasting occurs frequently, the performance about remote control may be affected.

Default Network Settings

When linking the management LAN port at the rear of the server to a network, refer to the following for default settings.

IP Address	: 192.168.1.1
User Name	: administrator
Password	: (None)
Host Name	: ARMCXXXXXXXXXXXXXX

- Using a DHCP function, the host name in the case of performing automatic registration to a DNS server turns into the above-mentioned host name.

Host Name: ARMCXXXXXXXXXXXXXX, where the 12 Xs are the MAC address of the Management Card.

- When you link without a DHCP server, please access the above-mentioned IP address in the local network which can use a default IP address "192.168.1.1."

NOTE: For security reasons, change these default settings (Password, an IP address, host name) by your network environment. See "BMC Configuration" described later for the setting method.

Server Setup

This section explains the operations which must be carried out on the server side, when using the Remote Management Feature.

Initial Setup

To use the Web server feature, change settings as shown below.

Start the EXPRESSBUILDER from CD-ROM, and select [System Management] → [Set Advanced Remote Management Card] from the Tools menu.

On the [Set Advanced Remote Management Card], select [Remote Management Console] → [Enabled], and then select [Register].

IMPORTANT: For security, the Web server feature of BMC is disabled at the shipment.

Setting of Graphics Accelerator Driver

- When your server's operating system is Windows

Use the driver which is installed at initial setup by Express Setup or system update.

- When a server's operating system is Linux

Since it may be automatic and a setup of a monitor/Driver/video memory may not be able to be performed by composition when operating system is Linux. We recommend you to use it in text mode.

Setting of Mouse Properties

Clear the "Enhance pointer precision" check box in "Motion" in "Pointer Options" in "Mouse properties", when the server operating system is Windows Server 2003.

Please adjust "Select a pointer speed", when you cannot move a mouse pointer up to the bottom right side of the host server screen via the remote KVM console.

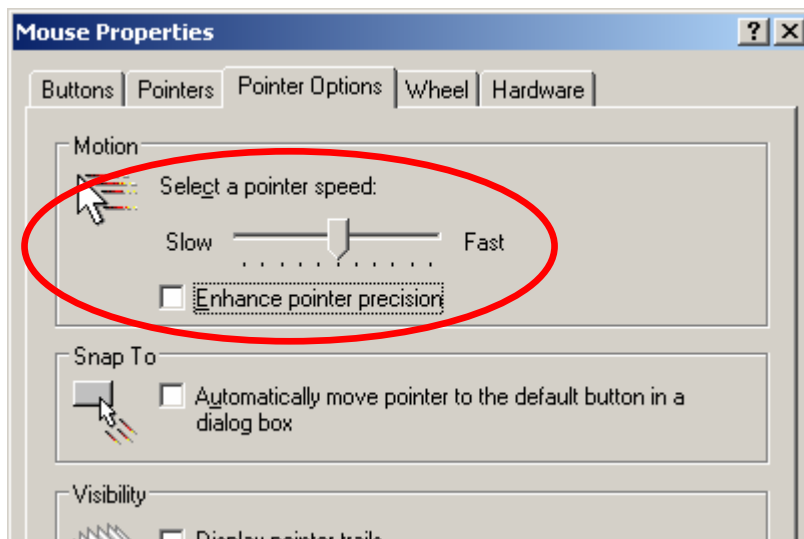

Configuring Management PC

This section provides information on what you need to do for management PCs and requirements of the browsers to establish connection.

Setting Your Browser

Make the following settings.

- Enable SSL.

Supported Browsers

The following browsers are supported.

- Microsoft® Internet Explorer 6.0
- Netscape 7.0
- Mozilla 1.6

Java2 Runtime Environment

Java2 Runtime Environment, Standard Edition 1.4.2_04 or later, which you can download from the following, is required.

<http://java.sun.com/j2se/>

If you access the login page without installing the product mentioned above, you may see a dialog box for security warning. Read the message and take actions according to the message.

Using Remote Management Console

Overview

You can control power-on/off of a server and use Remote KVM Console from a web browser by using the web server functions of BMC.

This function is achieved through Java Applet.

Connecting to the Web Server from a Web Browser on the Management PC

Access the following URL from the web browser in the management PC.

URL: http://BMC_HostPort/index.htm

NOTES:

- "BMC_HostPort" is a colon and port number added after the BMC address or host name. If the http port number is 80h (default), you can skip the port number.
- When you use DHCP functions as well as performing auto registration to the DNS server, the BMC default name is "ARMC"+MAC Address. There is the MAC address on the Management Main Card.

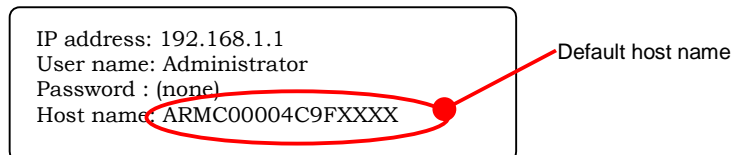

- If you want to use the Remote Management Function with DHCP disabled, first use the default IP address "192.168.1.1" and make access in a local network where this IP address is available, and then adjust configurations such as IP address according to your network environment. For information on configuration, see "BMC Configuration" described later in this section.
-

When you use the Remote Management Function for the first time, you may see a dialogue box for security warning as shown below. Read the message well and click either "Yes" or "Always." If you are not sure about the information, select "No."

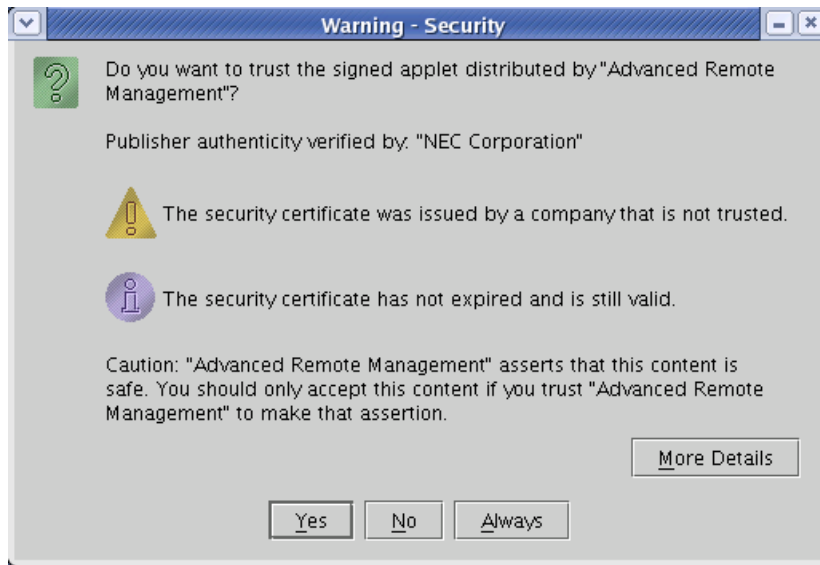

NOTE: When a connection is done with SSL, you may see some dialogue boxes for security warning.

Login and Logout

Login

When the login page appears, enter the user name and password, and then click [Login].

If you are logging in for the first time, use the following default user name and password.

Default user name: administrator

Default password: None (enter no information)

IMPORTANT: Because no password is set by default, make sure to configure a password immediately after you log in.

For security reasons, it is recommended to change the default user name as well.

For information on configuration and modification, see "BMC Configuration" described later in this section.

When the password you entered is authorized, the following licensing agreement appears.

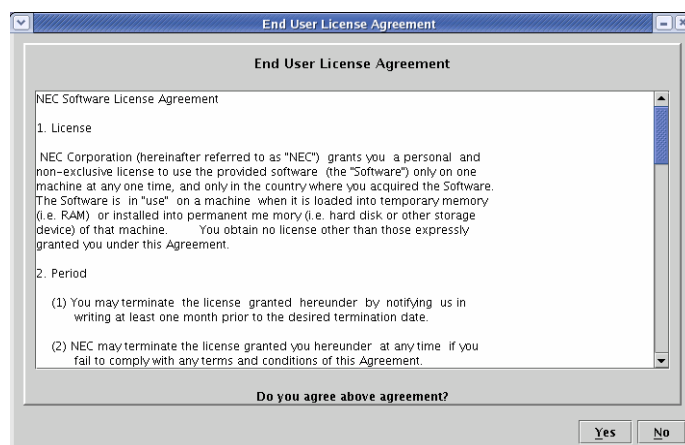

Read the information well and click "Yes" If you cannot agree, click "No", and you will return to the login window.

Logout

To log out, select "Exit" on the File menu.

When you log out, the main window closes and the login window for the browser appears.

Main Window

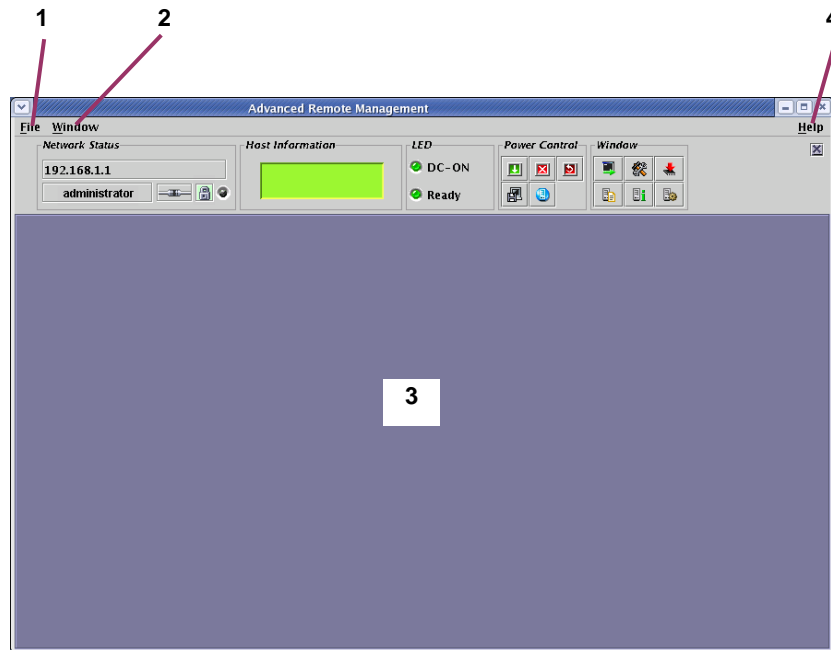

- 1 File menu**
The File menu allows you to quit this applet.
- 2 Window menu**
The Window menu allows you to open various windows including Remote KVM Console window.
- 3 Main frame**
Various windows open here.
- 4 Help menu**
With the Help menu, you can check the version of the Remote Management Console.

Control Panel

You can use Control Panel to see server status and to control power-on/off.

Control Panel also starts up various windows including Remote KVM Console.

Functions of Control Panel

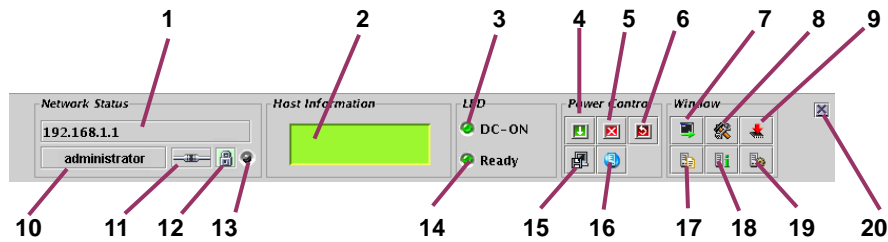

- 1 Shows the BMC host name.
- 2 Shows the server LCD.
- 3 Server power lamp that shows the server power-supply status.
- 4 Server power switch (provides the same function as achieved by pressing the server POWER switch)
- 5 Forcefully powers off the server.
- 6 Forcefully resets the server.
- 7 Starts up Remote KVM Console.
- 8 Starts up BMC Configuration.
- 9 Starts up Firmware Update.
- 10 Displays a user name.
- 11 Indicates status of connection with BMC.
- 12 Indicates status of communication security.
- 13 Indicates network access status.
- 14 Server status lamp that shows server status.
- 15 Makes the server collect memory dump (provides the same functionality as achieved by pressing the DUMP switch in the server.)
- 16 Makes the server unit ID lamp flash.
- 17 Opens the window to show system event logs (SEL.)
- 18 Opens the window to show sensor data records (SDR).
- 19 Opens the window to show field replaceable unit (FRU) information.
- 20 Hides Control Panel.

Remote KVM Console

By using Remote KVM Console functions of BMC, you can transfer local console of a server to the browser in the management PC over network.

You can make full access from the management PC to the server by using video, keyboard and mouse.

NOTES:

- The following five types of resolution are supported for a server.
 - 1024×768
 - 800×600
 - 640×480
 - 720×400
 - 720×350
 - KVM is an acronym for Keyboard, Video, and Mouse.
Unlike using a conventional serial console remotely, KVM allows you to remotely use graphics as they are.
 - The remote KVM console cannot be used for connection via proxy.
-

Starting Up Remote KVM Console

When you click [], the icon to start up Remote KVM Console, on Control Panel, the Remote KVM Console window opens.

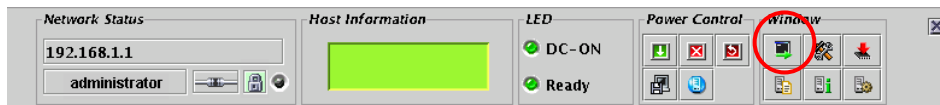

IMPORTANT: Never open Remote KVM Console if you have logged in BMC of the local server from the local console of a server. Otherwise entry by keyboard or mouse becomes disabled.

Names of Components in the Remote KVM Console Window

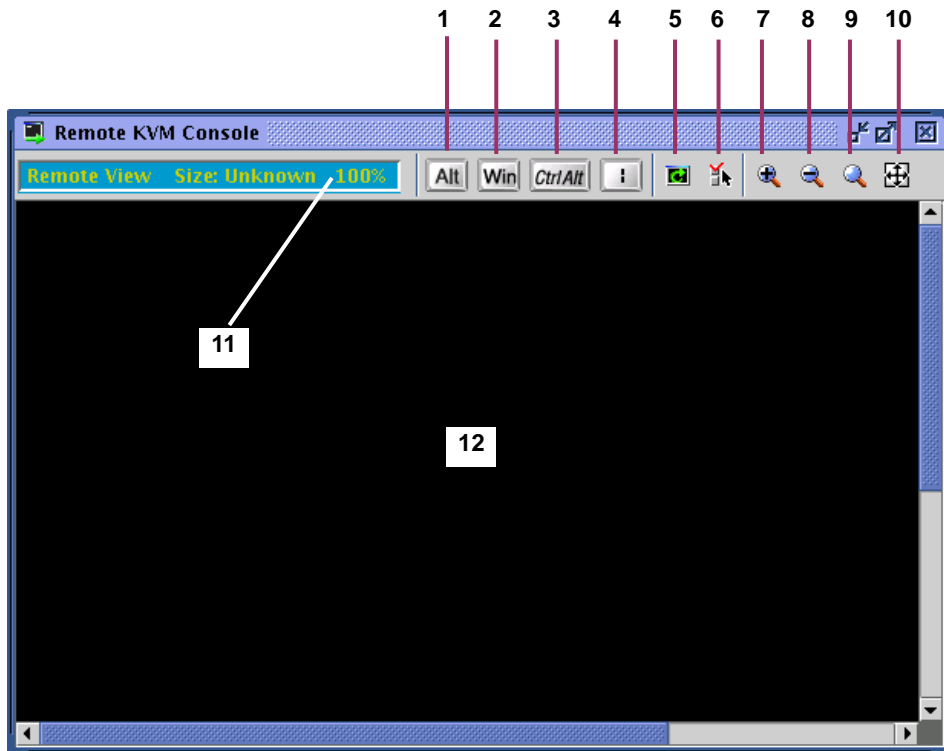





- 1, 2, 3, 4 Special key icon
- 5 Screen refresh icon
- 6 KVM properties icon
- 7 Zoom in icon
- 8 Zoom out icon
- 9 Default size icon
- 10 Window resize icon
- 11 KVM indicator
- 12 Remote KVM Console screen

IMPORTANT: When pressing Shift + CapsLock on the remote KVM console, the indication may not be the same as the CapsLock LED on the management PC. In addition, the CapsLock status on the management PC may change after the remote KVM console has been used.

Entry via Special Keys

For special keys, even if you press these keys in a remote keyboard, it will not take effect in the host server. Using the following three special key icons will take effect in the host server.

 (raised state) and  (pressed-in state): toggles whenever clicked.

 (raised state) and  (pressed-in state): toggles whenever clicked.

IMPORTANT: For example, to enter "**Ctrl + Alt + Del**", press the [CtrlAlt] icon and press **Delete** on your keyboard. By doing so "**Ctrl + Alt + Del**" takes effect in the host server. When this takes effect, click the [CtrlAlt] icon again to release the effect of entry of this special key. If you press **Delete** on the keyboard while the [CtrlAlt] icon has been selected, "**Ctrl + Alt + Del**" also takes effect in the host server.

 (Windows key icon)

 ("|" pipe key icon)

Zoom In and Zoom Out

When you click  to zoom in, what is shown becomes larger.

When you click  to zoom out, what is shown becomes smaller.

When you click , the default size icon, what is displayed will be the same size as the host server.

When you click , the window resize icon, the size of the Remote KVM Console window is adjusted to the remote screen size.

Screen Refresh

When you click , the screen refresh icon, the Remote KVM Console screen will be refreshed. When the screen display is disturbed, refresh the screen.

Modifying Properties

When you click , the KVM properties icon, the KVM properties window appears. In this window, you can specify the screen refresh interval which is executed automatically.

NOTE: By having a shorter refresh interval, garbage on the screen will be reduced. However, note that screen refresh will give burden. A too short refresh interval can slow response speed of terminals or affect traffic performance of the network.

IPMI Information

You can see system event logs (SEL), sensor data records (SDR), and field replaceable units (FRU) information, which are called IPMI information. By using the IPMI information, you can see and examine troubles and events on the host server, and determine a part to be replaced.

Displaying System Event Logs (SEL)

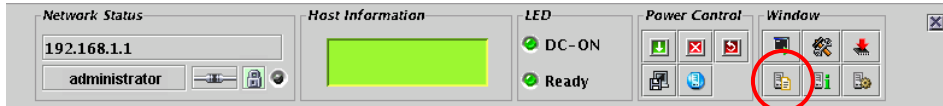

When you click [SEL] to display system event logs (SEL) on Control Panel, SEL information is loaded from BMC, and the following window showing system event logs (SEL) opens.

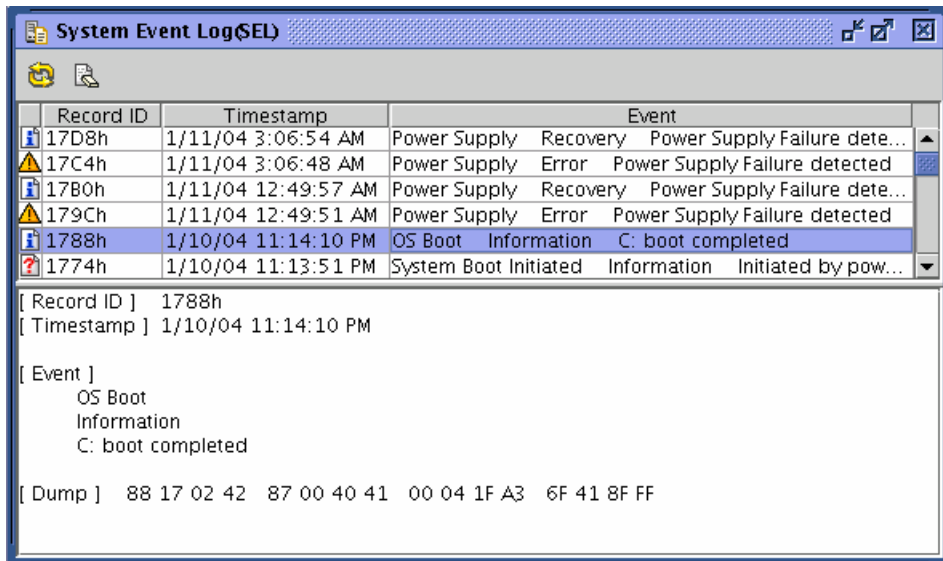

On the upper part of the window, a list of logs appears. On the lower part of the window, detailed information of the entry selected from the list appears.

When you click [Refresh] for reloading, the SEL information is reloaded from BMC, and you can update the information to latest.

Clearing SEL Information

You can clear the SEL information on BMC by clicking [Clear], the icon for SEL clearing. When you see the message for confirmation, click [Yes] if you want to clear SEL. If not, click [No] so that SEL clearing will not be performed.

Displaying Sensor Data Records (SDR)



When you click [SDR] to display sensor data records on Control Panel, SDR information is loaded from BMC, and the following window showing sensor data records appears.

Record ID	Sensor Type	Owner
1h	Voltage(Processor 1 VCCP)	Basbrd Mgmt Ctlr
2h	Voltage(Processor 2 VCCP)	Basbrd Mgmt Ctlr
3h	Voltage(Baseboard 3.3V)	Basbrd Mgmt Ctlr
4h	Voltage(Baseboard 3.3VSB)	Basbrd Mgmt Ctlr
5h	Voltage(Baseboard 5V)	Basbrd Mgmt Ctlr
6h	Voltage(Baseboard 5VSB)	Basbrd Mgmt Ctlr
7h	Voltage(Baseboard 12V)	Basbrd Mgmt Ctlr
8h	Voltage(Baseboard VBAT)	Basbrd Mgmt Ctlr

```

[ Record ID ] 1h
[ Sensor Type ] Voltage(Processor 1 VCCP)
[ Entity ] Processor1
[ Owner ] Basbrd Mgmt Ctlr
[ Upper non-recoverable Threshold ] ---
[ Upper critical Threshold ] 1.64Volts (Hysteresis: 1.63Volts)
[ Upper non-critical Threshold ] 1.56Volts (Hysteresis: 1.55Volts)
[ Lower non-critical Threshold ] 1.15Volts (Hysteresis: 1.16Volts)
[ Lower critical Threshold ] 1.06Volts (Hysteresis: 1.07Volts)
[ Lower non-recoverable Threshold ] ---

[ Dump ]
01 00 51 01 3B 20 00 10 03 01 7F E9 02 01 85 32
85 32 1B 1B 00 04 00 00 EB 42 07 01 00 B4 07 82
B0 5B FF 00 00 BF B0 00 49 5B 02 02 00 00 00 D0
50 72 6F 63 65 73 73 6F 72 20 31 20 56 43 43 50

```

On the upper part of the window, a list of sensor data records appears. On the lower part of the window, detailed information of the entry selected from the list appears.

NOTE: SDR information is information on definitions for each sensor on the server. BMC monitors server sensors according to this information.

Displaying Field Replaceable Units (FRU) Information



When you click [FRU icon] to display field replaceable units (FRU) information on Control Panel, FRU information is loaded from BMC, and the following window showing field replaceable units (FRU) information appears.

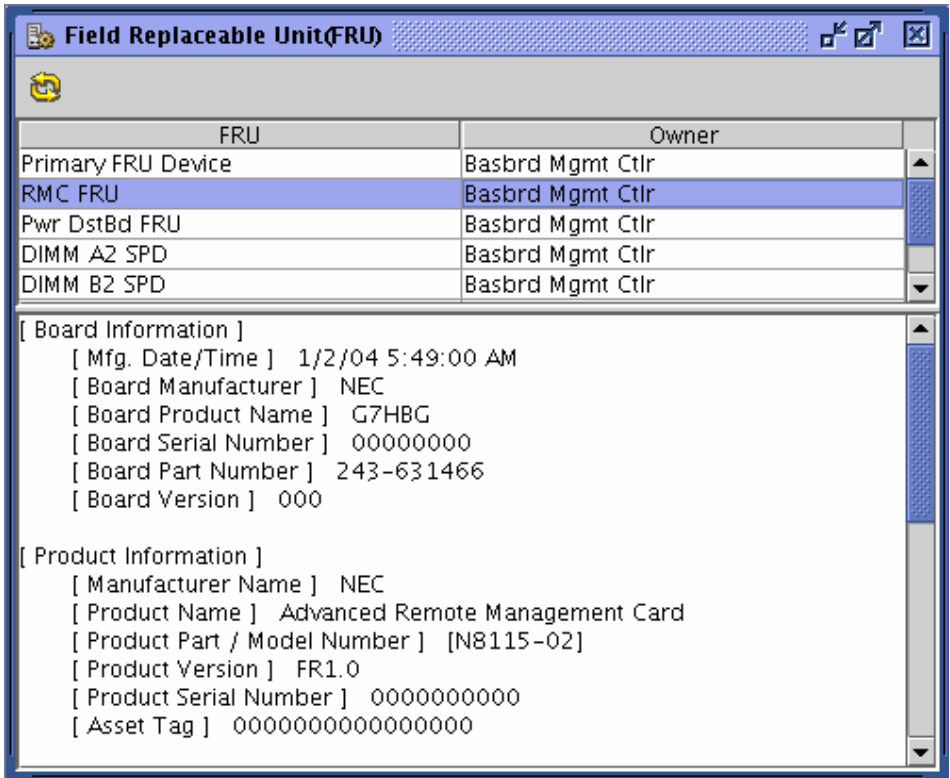



On the upper part of the window, a list of FRUs appears. On the lower part of the window, detailed information of the entry selected from the list appears.

BMC Configuration

You can configure BMC settings.

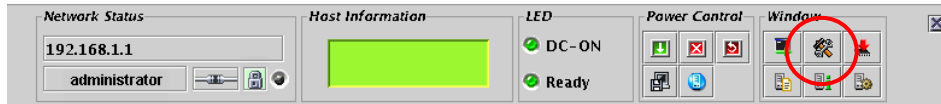
Starting Up the BMC Configuration Window



When you click [], the icon to start up BMC Configuration on Control Panel, the BMC Configuration window appears as shown below.

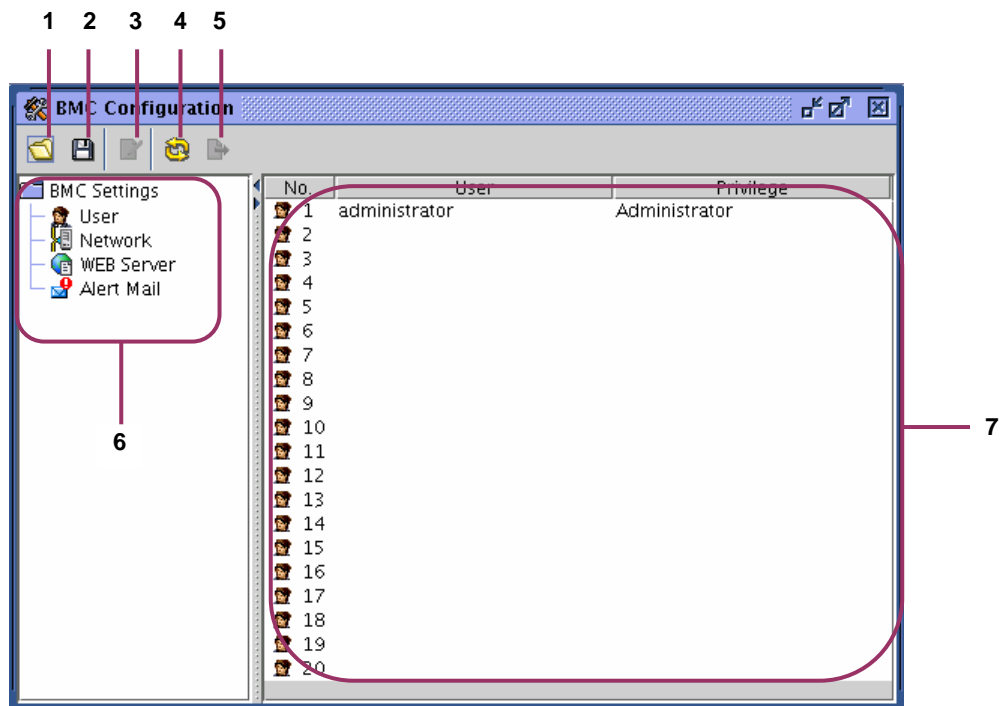

- 1 Loads a file
- 2 Saves the file
- 3 Edits information
- 4 Reloads from BMC
- 5 Makes global settings of BMC
- 6 Item selection tree
- 7 Currently configured values

NOTE: Use "Global settings of BMC" when configuration information is loaded from a file.

User Configuration

By clicking [User Configuration] in the left pane of the BMC Configuration window, a list to show 20 accounts opens in the right pane and you can set up user accounts.

Choose the account you want to modify or add and click [] to edit information. The User Configuration window to edit a user account as shown below opens.

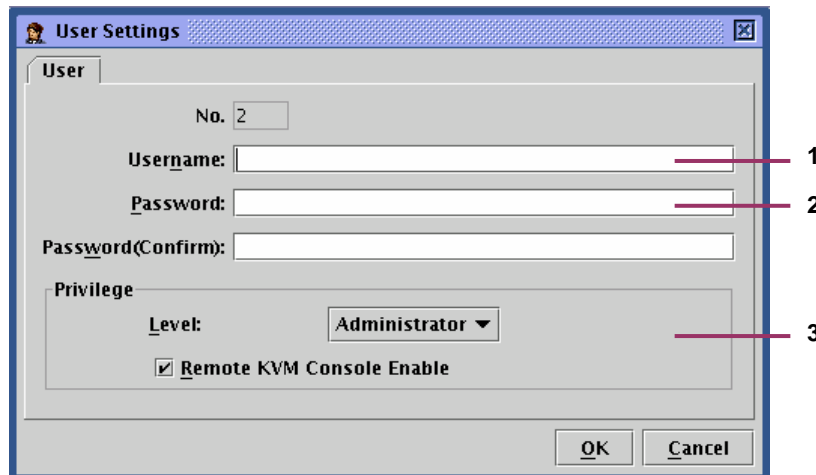

- 1 Enter a user name.
- 2 Enter a password. To avoid a mistake, enter the password in the two boxes.
- 3 Configure an access privilege.

Level :

Administrator: the user is allowed to do all operations.

User: the user can see information but is not allowed modify settings.

Remote KVM Console: Specify whether or not to enable Remote KVM Console.

If you select this check box, you can make Remote KVM Console enabled (permit settings).

NOTE: You can make settings of Remote KVM Console regardless of the access privilege levels. You can make "disable" settings for Administrator and "enable" settings for User.

When you click [OK], all the information in the User Configuration window will be written into BMC.

When you click [Cancel], the User Configuration window closes discarding what you have configured in the window.

Network Configuration

By clicking [Network Configuration] in the left pane of the BMC Configuration window, you will see a window as shown below and you can make network-related settings for BMC including IP address.

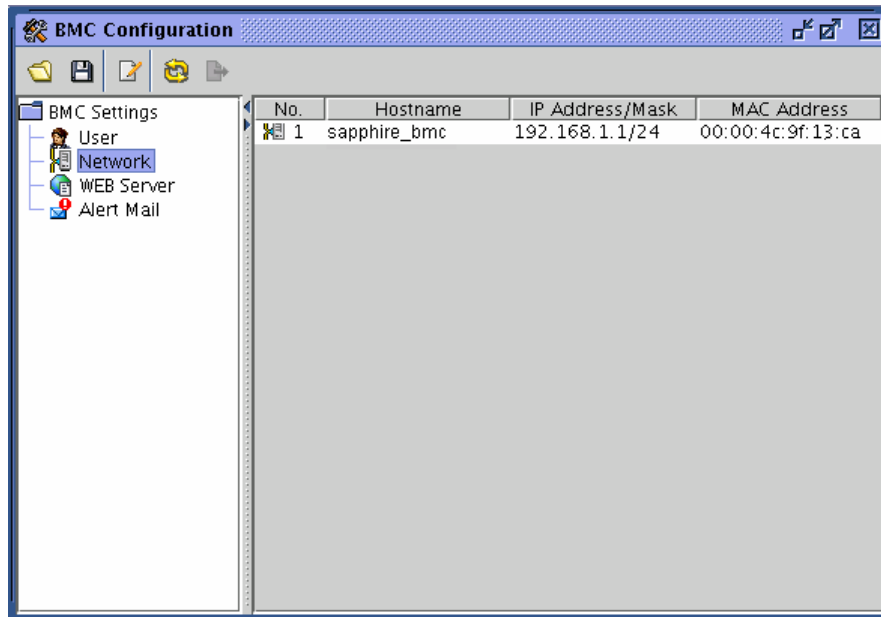

When you click [edit icon], the icon for editing information, in this window, the Network Configuration window as shown below appears.

The Network Configuration window has three tabs.

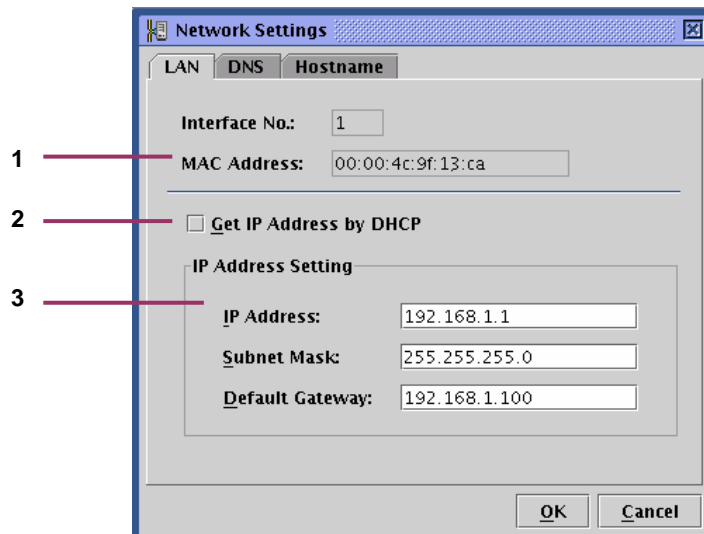

- 1 The MAC address owned by BMC appears in this box.
- 2 Choose whether or not to acquire an IP address automatically by DHCP.
- 3 If DHCP is not used to automatically acquire an IP address, make settings here. If DHCP is used, information automatically acquired appears here.

IMPORTANT: When you change the IP address, the current connection will be disconnected after you click OK and settings of BMC is completed. Close the window once, and then enter the IP address (or host name) that has been newly configured in the browser to log in.

Because the login page that remains to be displayed in the browser has been accessed by the old address, you cannot use it to log in.

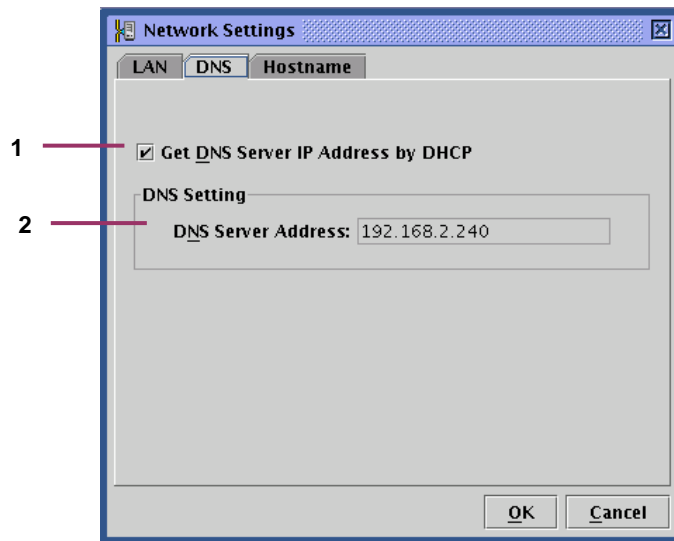

- 1 Choose whether or not to acquire the IP address of the DNS server automatically by DHCP.
- 2 If DHCP is not used to automatically acquire the IP address of the DNS server, make settings here. If DHCP is used, information automatically acquired appears here.

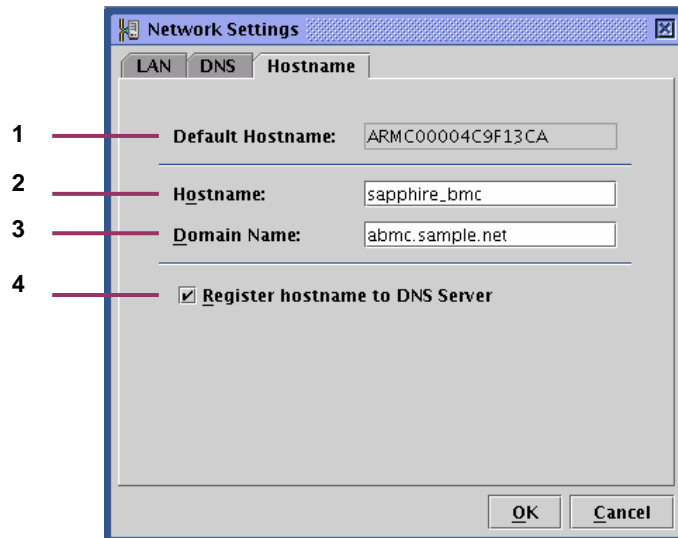

- 1 The default host name to be used when no host name is configured for using DHCP
- 2 Enter the host name of BMC. If nothing is set here, the default host name in the previous step will be used.
- 3 Enter the domain name of the network to which BMC belongs.
- 4 Choose whether or not to register the host name to the DNS server.

NOTE: It is recommended to specify a name that is easy to imagine the host name in the server operating system (for Windows, a computer name) for a BMC host name. For example, if the host name on the server operating system is "sapphire", you may set BMC "sapphire_bmc" for a BMC host name.

IMPORTANT: Because BMC uses a LAN controller independent of the server operating system, a BMC host name and a domain name cannot be exactly the same as those on the server operating system. If BMC belongs to a different network domain, you can have the same host name.

When you click [OK], all the information in the Network Configuration window with three tabs will be written into BMC.

When you click [Cancel], the Network Configuration window closes discarding what you have configured.

HTTP Configuration

By clicking [HTTP Configuration] in the left pane of the BMC Configuration window, you will see a window as shown below and you can make web server-related settings for BMC such as HTTP port.

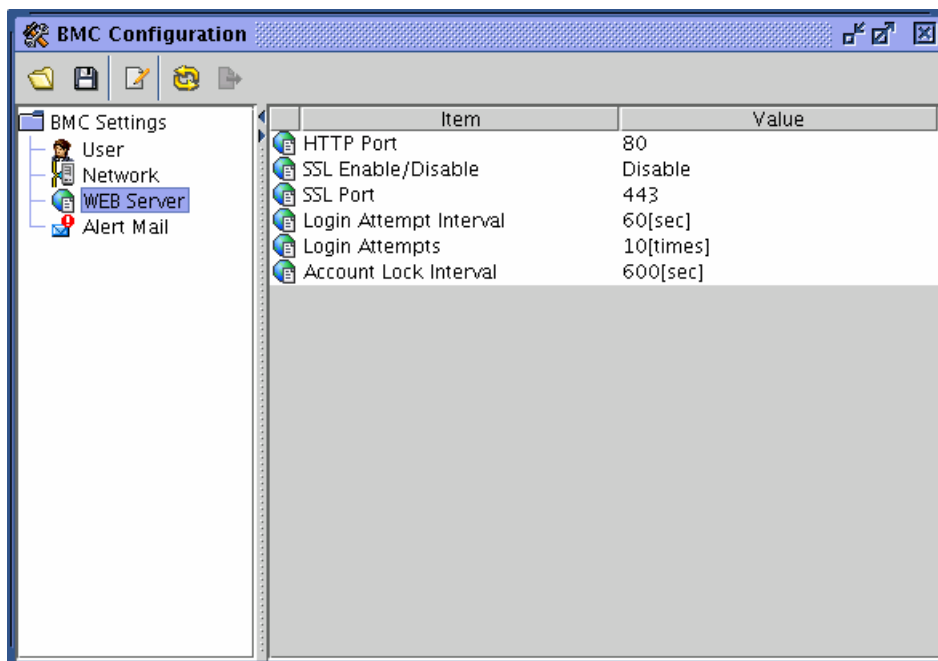

IMPORTANT: If you change the settings of HTTP port number, Enable SSL, or SSL Port Number, the current connection will be disconnected.

Close the window once, and then enter the port number that has been newly configured in the browser to log in.

Because the login page that remains to be displayed in the browser has been accessed by the old address, you cannot use it to log in.

When you click [], the icon for editing information, in this window, the HTTP Configuration window as shown below appears.

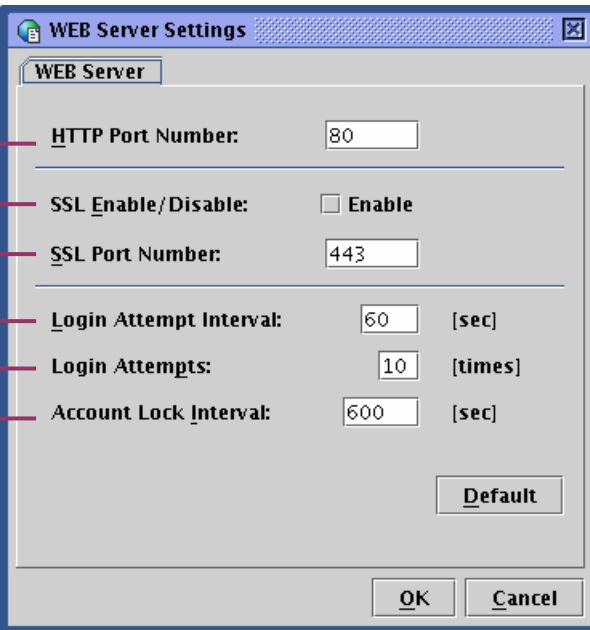

1 — HTTP Port Number: 80

2 — SSL Enable/Disable: Enable

3 — SSL Port Number: 443

4 — Login Attempt Interval: 60 [sec]

5 — Login Attempts: 10 [times]

6 — Account Lock Interval: 600 [sec]

Default

OK Cancel

- 1 Specify an HTTP port number
- 2 Choose enable/disable SSL communication. If you select this check box, you can make SSL enabled settings. And, if you clear this check box, you can make SSL disabled settings.

NOTE: Unless there is any specific reason such use of SSL not being allowed, it is recommended to use the HTTPS protocol, which is encrypted.
By default, SSL is disabled.

- 3 Specify an SSL port number in this box.
- 4 In Login attempt period, specify a time period during which you can retry login if your attempt to log in has failed.
- 5 In Failed login attempts, specify the number of login attempts during the period specified in the previous step, exceeding which prompts to deny login as specified in the following step.
- 6 In Account lock period, enter a time period during which login is denied.

NOTE: The three configuration items mentioned above are effective to deny unauthorized login accesses that are attempted automatically. However, they cannot prevent such accesses completely.

When you click [Default], default values for HTTP port number, SSL port number, Login attempt interval, Login attempts, and Account lock interval appear. But, SSL Enable/Disable check box is not changed.

When you click [OK], all the information in the HTTP Configuration window will be written into BMC.

When you click [Cancel], the HTTP Configuration window closes discarding what you have configured in the window.

Alert Mail Configuration

By clicking [Alert Main Configuration] in the left pane of the BMC Configuration window, you will see a window as shown below and you can make alert mail-related settings.

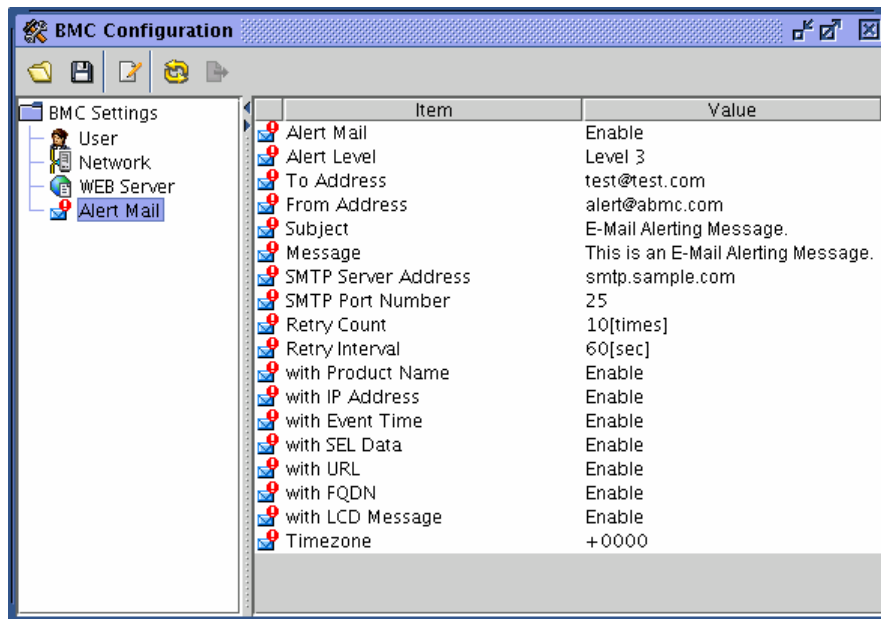

When you click [✎], the icon for editing information, in this window, the Alert Mail Configuration window as shown below appears. The Alert Mail Configuration window has four tabs.

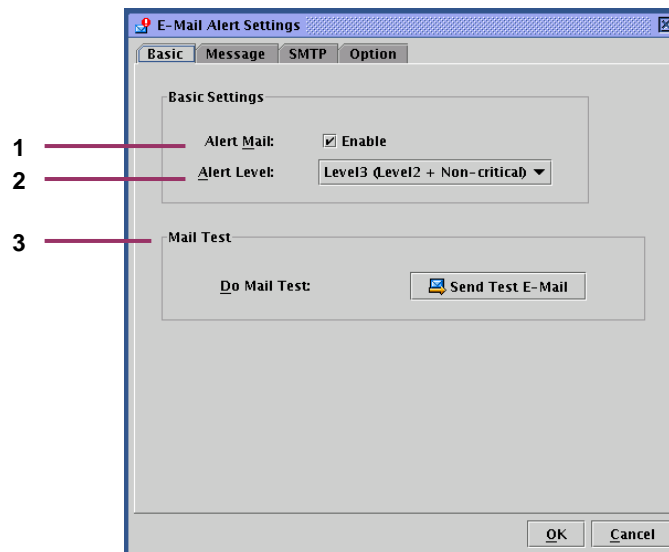

- 1 You can choose to enable or disable alert mail functions. If you select this check box, you can make mail-related settings.
- 2 Specify an alert level from six levels. Alert levels are categorized according to severity of event causing an alert.
- 3 You can send a test mail by clicking the button in this box.

IMPORTANT: If you want to send a test mail, complete all alert mail settings detailed in the following pages.

Note that entering information in the Alert Mail Configuration window does not complete settings. When you have entered all the information you need to enter, click [OK], and the information will be written into BMC and settings will be completed.

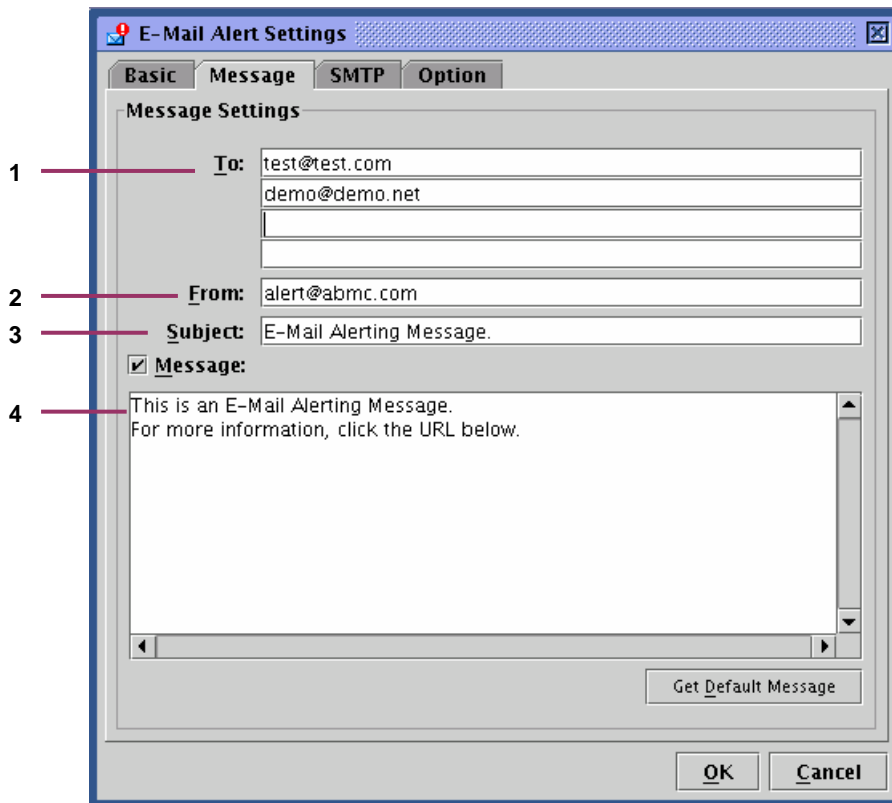

- 1 Specify email addresses of alert mail. You can specify up to four addresses.
- 2 Specify the sender's email address.
- 3 Type in the subject of the alert mail.
- 4 Type in a message that appears in the message body of all alert mails. If you do not need such message, you can clear the check box. If you click "Acquire default message", the recommended message appears.

NOTE: The subject and message you configure here will be attached to all alert mails.

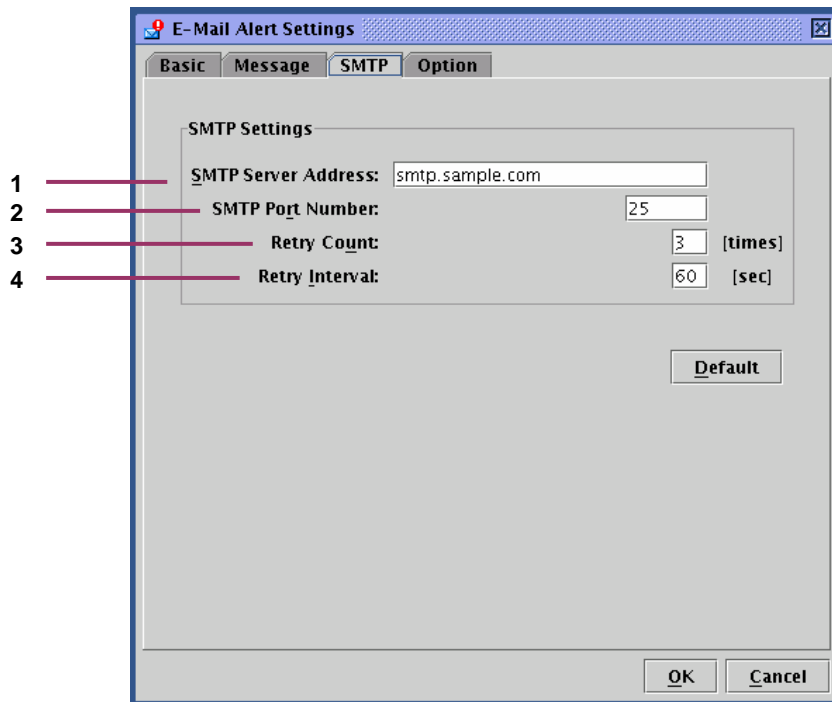

- 1 Specify the SMTP server address. You can use the IP address as well.
- 2 Specify the port number of the SMTP server.
- 3 Specify how many retries can be made when attempt to send the mail has failed.
- 4 Specify a retry interval that waits for the next retry when attempt to send the mail has failed.

When you click [Default], default values for SMTP port number, retry count, and retry interval appear. Unless there is any specific reason not to, it is recommended to use the default values.

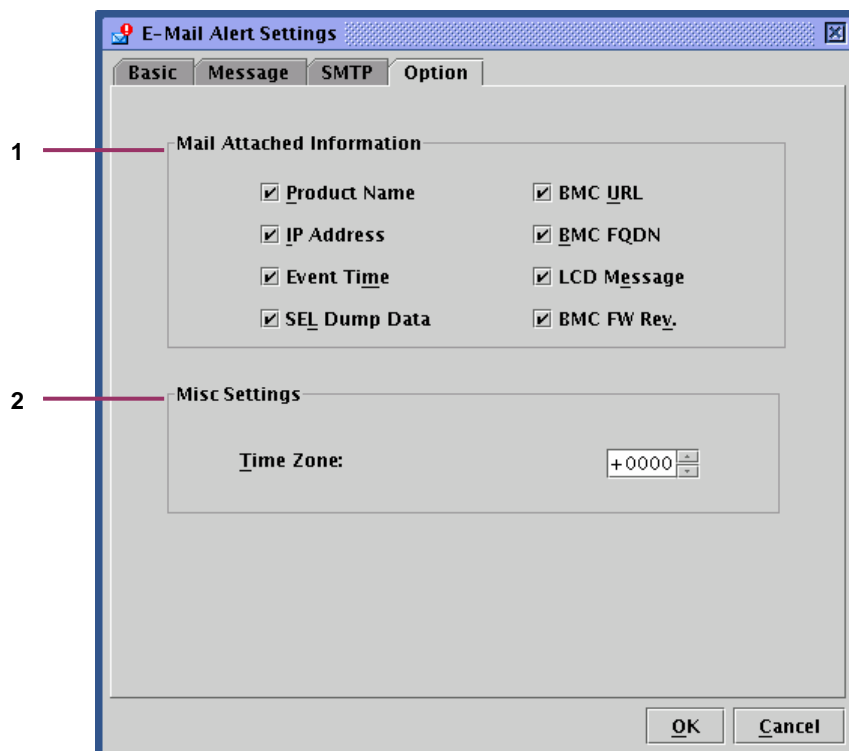

- 1 Specify information to be included in the body of alert mails.

Product Information	The product name, code and number of the server
IP Address	IP address of BMC

Event Time	The time the event occurred
SEL Dump Data	Data representing system event logs (SEL) in hexadecimal
BMC URL	URL of the ARMC login page
BMC FQDN	Full domain name of BMC
LCD Message	LCD message in the server at the time of event occurrence
BMC FW Rev.	Revision information of BMC firmware/SDR/PIA

2 The information here will appear in the Date field in the header of alert mails.

Firmware Update

You can update applet, KVM firmware, BMC firmware, sensor data records (SDR), and platform information (PIA)

Starting the Firmware Update Window

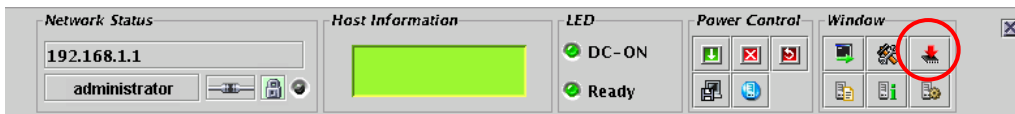

When you click [], the icon to start Firmware Update, on Control Panel, revision information is loaded from BMC, and the Firmware Update window as shown below appears.

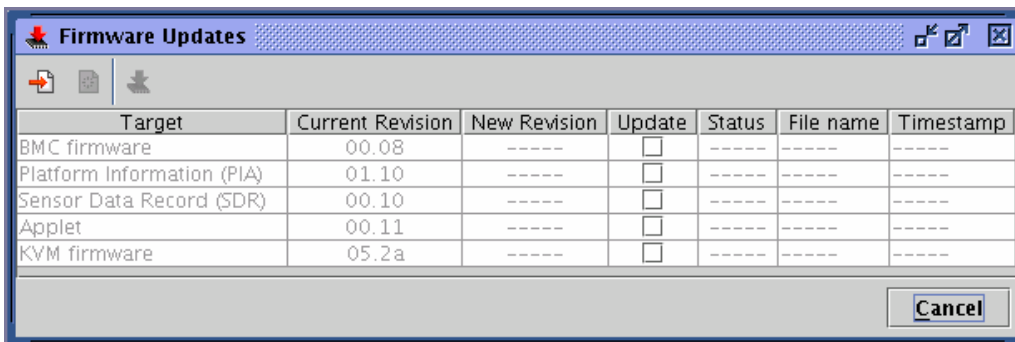

When you click [Cancel], the Firmware Update window closes without any changes made.

The following pages provide information about update procedures.

Loading Update Data Files

When you click [] to add update files, a window as shown below opens prompting you to select files.

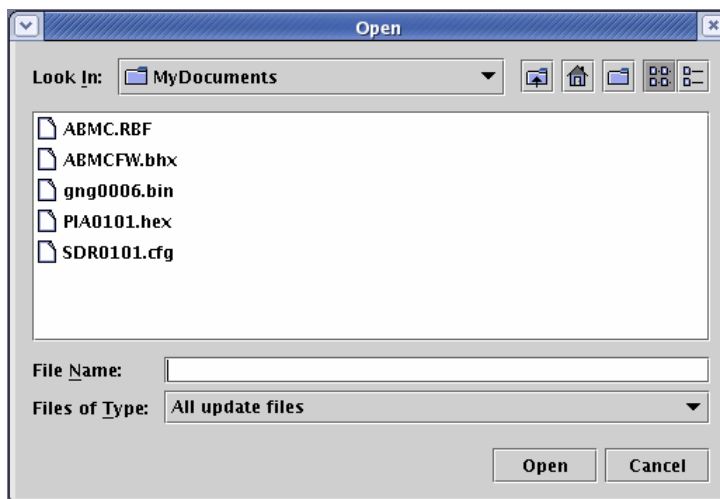

Select update data files.

When you click [Open] after selecting files, loading of the files begins.

It will take a little while for loading to be completed.

NOTE: Because update can be made globally for each update target, make sure to load everything you need.
You can specify multiple files to be loaded simultaneously.

Checking Revisions

When loading of data files is completed, the current revision and new revisions appear with information on files (file names and time stamps) in the Firmware Update window.

Check the revisions and information.

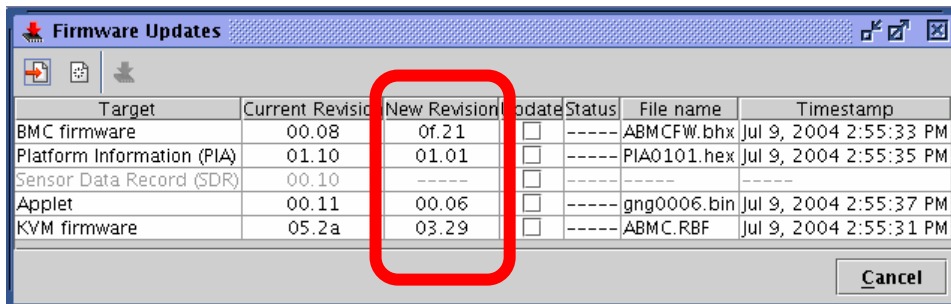

NOTE: Check each revision well because downgrade can be performed as well.

If you click [] to clear update data, all data that has been loaded will be discarded. If you click [Cancel], the Firmware Update window closes discarding all information that has been loaded.

Selecting Update Target

Select update targets in the Update check boxes.

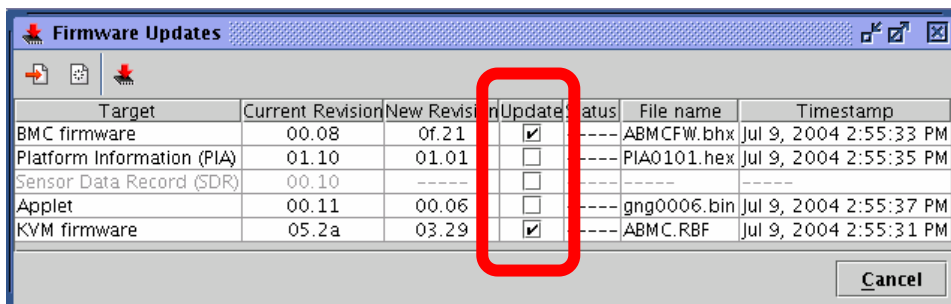

NOTE: Only what you specify here will be written into BMC.

Data will not be written for those items with file loaded but not specified here.

IMPORTANT: If you want to update both SDR and PIA, perform writing simultaneously. If you update SDR and PIA separately, the first update data will be cleared when the second update is performed.

Writing Update Data into BMC

When you click [], update data will be written into BMC.

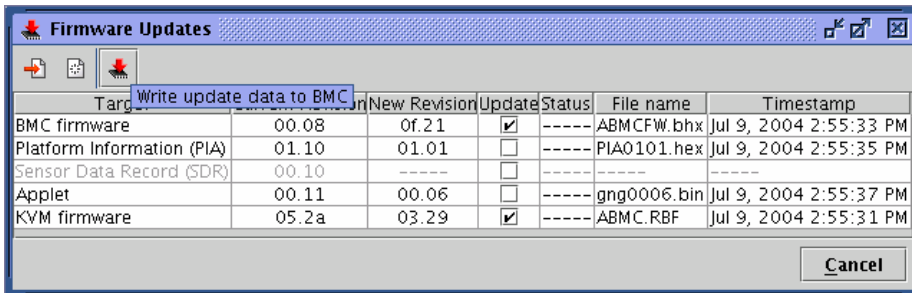

For each update target, the window showing update progress appears.

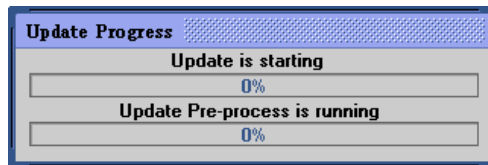

If any error is detected during update, an error message appears and the update is terminated.

Completion of Writing

When writing is completed, results appear in the [Status] column per [Target].

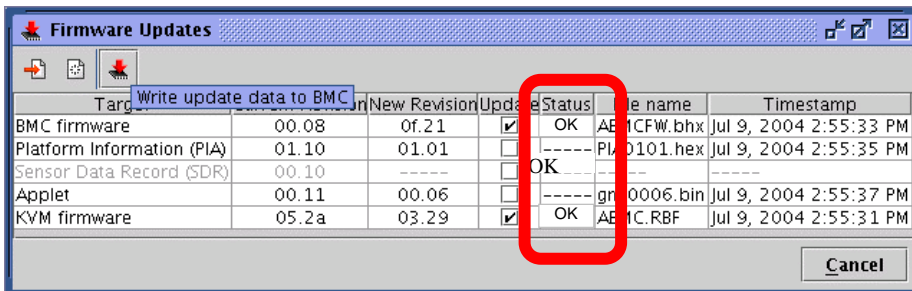

NOTES:

- For targets other than applet, reboot the server or power off and then on the server to apply the update.
- If you reboot the server or power on the server to apply the BMC firmware update, connection to BMC is disconnected. To continue using, log in again.
- To apply applet update, log out and shut down all browsers, and then log in again. You do not need to reboot the server.

Troubleshooting

Error messages

Fatal errors

No	Error Message	What to do
1	Fatal error. JavaVM quits.	Try logging in again. If the same message continues to appear, contact your service representative.
2	A fatal software error has occurred.	Try logging in again. If the same message continues to appear, contact your service representative.

Login error

No	Error Message	What to do
1	Authentication error	Check the user name and password, and then enter them again.

Access privilege error

No	Error Message	What to do
1	Unauthorized operation. You have no privilege to perform the operation.	Try performing the operation with administrator's privileges. Consult your administrator.

Network errors

No	Error Message	What to do
1	The HTTP communication failed.	Check the network environment and try again. Contact your service representative if the error persists.
2	Could not resolve the IP address.	Check the network environment. You cannot use Remote KVM Console for connections via proxy.
3	Unable to reach the target host.	Check the network environment. You cannot use Remote KVM Console for connections via proxy.
4	A network error occurred.	Check the network environment and try again. Contact your service representative if the error persists.
5	Failed to download applet.	Check the network environment and try again. When SSL has been enabled, more than one client cannot connect to the network simultaneously. Try again after a connection from other client is finished. Contact your service representative if the error persists.
6	The RMCP+ session is closed.	Check the network environment. If there is no network problem, contact your service representative.
7	Failed to establish the RMCP+ session.	Check the network environment. If there is no network problem, contact your service representative.
8	The RMCP+ transmission failed.	Check the network environment. If there is no network problem, contact your service representative.
9	The specified RMCP+ protocol cannot be used.	Check the network environment. If there is no network problem, contact your service representative.
10	BMC resources to establish a new RMCP+ session are insufficient.	Try again after a connection from other client is finished.
11	The RMCP+ session time-out occurred.	Check the network environment and server. If you do not find the problem, contact your service representative.

BMC-related errors

No	Error Message	What to do
1	The IPMI request was aborted.	The network may be busy. Try again. If the error persists, contact your service representative because a failure may have occurred in BMC.
2	Received bad response from BMC.	Check the server. A failure may have occurred in BMC. If you do not find the problem, contact your service representative.
3	BMC does not support IPMI 2.0 functions.	Contact your service representative.

No	Error Message	What to do
4	Failed to run the IPMI command.	Check the server. A failure may have occurred in BMC. If you do not find the problem, contact your service representative.
5	Failed to send the IPMI message.	Check the network environment. If the network has no problem, contact your service representative.
6	Illegal IPMI message was requested.	Contact your service representative.
7	Specified target is not present.	Check the server. A failure may have occurred in BMC. If you do not find the problem, contact your service representative.

Remote KVM Console errors

No	Error Message	What to do
1	Failed to disable Remote KVM Console.	Check the network environment and try again. Contact your service representative if the error persists.
2	Failed to enable Remote KVM Console.	Check the network environment and try again. Contact your service representative if the error persists.
3	KVM packet transmission failed.	Check the network environment and server. If you do not find the problem, contact your service representative.
4	The KVM request was aborted.	This is not a problem. Click OK and close the message box.
5	UDP packet transmission failed.	Check the network environment and server. If you do not find the problem, contact your service representative.
6	Remote KVM console can not activate because it is disabled.	Make a remote KVM console enable. See "Remote KVM Console" in Chapter 4.
7	Remote KVM Console is used by other client.	Try again after the client has finished using Remote KVM Console.
8	Failed to shut down Remote KVM Console.	Use Remote KVM Console after waiting 3 or more minutes.
9	Failed to make settings.	Check the network environment and try again. Contact your service representative if the error persists.
10	The UDP connection is closed.	Check the network environment and server. If you do not find any problem, contact your service representative.

System event logs (SEL) display errors

No	Error Message	What to do
1	Failed to clear session event logs of BMC.	The network may be busy. Try again. If the error persists, contact your service representative because a failure may have occurred in BMC.
2	Failed to acquire system event logs.	The network may be busy. Try again. If the error persists, contact your service representative because a failure may have occurred in BMC.

Sensor data records (SDR) display error

No	Error Message	What to do
1	Failed to acquire sensor data records.	The network may be busy. Try again. If the error persists, contact your service representative because a failure may have occurred in BMC.

Field replaceable unit (FRU) information display error

No	Error Message	What to do
1	Failed to acquire field replaceable units information.	The network may be busy. Try again. If the error persists, contact your service representative because a failure may have occurred in BMC.

BMC configuration errors

No	Error Message	What to do
1	Failed to make settings:	Check the network environment and try again. Contact your service representative if the error persists.
2	Failed to acquire BMC Configuration:	
3	Used by other software program. Try again after a while.	Try again after a while.
4	Invalid BMC configuration file.	The BMC configuration file may be corrupted. Check the file.

No	Error Message	What to do
5	The required XML tag is not found.	The BMC configuration file may be corrupted. Check the file.
6	Failed to write the file.	The BMC configuration file is not saved successfully. Change the location to save the file and try again.
7	Invalid user name	You can use only alphanumeric characters, minus sign (-), and underscore (_) for a user name. A user name should be 32 characters or less.
8	The user name is too long	A user name should be 32 characters or less.
9	The password is too long.	Use 16 or less characters.
10	Passwords are not matched.	Again, input passwords.
11	Invalid HTTP port number	You can use only numeric values.
12	Invalid SSL port number	You can use only numeric values.
13	HTTP/SSL should not be the same.	The same port number cannot do them. Specify different value.
14	Invalid login attempt period	You can use only numeric values.
15	Invalid failed login attempts	You can use only numeric values.
16	Invalid account lock period	You can use only numeric values.
17	Invalid IP address	Use numerals and periods to specify an IP address.
18	Invalid subnet mask	Use numerals and periods to specify a subnet mask.
19	Invalid default gateway	Use numerals and periods to specify a default gateway.
20	Invalid DNS server IP address	Use numerals and periods to specify the IP address of DNS server.
21	Invalid host name	You can use only alphanumeric characters, minus sign (-), and underscore (_) for a host name. A host name should be 64 characters or less.
22	Invalid domain name	You can use only alphanumeric characters, minus sign (-), and underscore (_) for a domain name. A domain name should be up to 256 characters.
23	The SMTP server address is too long.	Specify within 256 characters.
24	Invalid SMTP port number.	You can use only numeric values.
25	Invalid retry count	You can use only numeric values.
26	Invalid retry interval	You can use only numeric values.
27	"To" is too long.	Specify within 256 characters.
28	"From" is too long.	Specify within 256 characters.
29	"Subject" is too long.	Specify within 512 characters.
30	The message is too long.	The message should be up to 4064 characters.
31	Failed to open the file:	The specified file may not exist. Check the file name.
32	Failed to close the file:	The specified file may be corrupted.
33	Can't open the file:	The specified file may not exist. Check the file name.
34	Timeout has occurred.	Try again. If the error persists, contact your service representative because a failure may have occurred in BMC.

Firmware update errors

No	Error Message	What to do
1	There are uncompleted update images on BMC as follows:	Reboot the server and complete the update.
2	Failed to acquire status of the update area.	The network may be busy. Try again. If the error persists, contact your service representative because a failure may have occurred in BMC.
3	Update data is too large:	Some update files may be corrupted. Acquire update files again.
4	Failed to prepare update	The network may be busy. Try again. If the error persists, contact your service representative because a failure may have occurred in BMC.
5	Invalid file size:	The update file may be corrupted. Acquire the update file again.
6	Could not find the revision information:	Some update files may be corrupted. Acquire update files again.
7	Failed to create rollback image.	Try again. If the error persists, contact your service representative because a failure may have occurred in BMC.
8	Failed to erase.	Try again. If the error persists, contact your service representative because a failure may have occurred in BMC.
9	Unsupported format version:	Some update files may be corrupted. Acquire update files again.

No	Error Message	What to do
10	Failed to load the update image file.	Some update files may be corrupted. Acquire update files again.
11	Update has failed.	Try again. If the error persists, contact your service representative because a failure may have occurred in BMC.
12	Could not switch to the update mode.	Try again. If the error persists, contact your service representative because a failure may have occurred in BMC.
13	Could not find the update targets:	Some update files may be corrupted. Acquire update files again.
14	Invalid address:	Some update files may be corrupted. Acquire update files again.
15	Writing has failed.	Try again. If the error persists, contact your service representative because a failure may have occurred in BMC.
16	Unsupported token is detected:	Some update files may be corrupted. Acquire update files again.
17	Invalid segment information:	Some update files may be corrupted. Acquire update files again.
18	Invalid data length:	Some update files may be corrupted. Acquire update files again.
19	Failed to open the file:	The specified file may not exist. Check the file name.
20	Failed to close the file:	The specified file may be corrupted.
21	Invalid file checksum:	Some update files may be corrupted. Acquire update files again.
22	Failed to parse files.	Some update files may be corrupted. Acquire update files again.
23	Failed to parse files:	Some update files may be corrupted. Acquire update files again.
24	Failed to load files:	Some update files may be corrupted. Acquire update files again.
25	Could not find files:	Some update files may be corrupted. Acquire update files again.
26	Failed to verify	Try again. If the error persists, contact your service representative because a failure may have occurred in BMC.
27	Update will be stopped because interruption has occurred.	Check clients. A software program other than you are using may have interrupted.
28	Online update is now being used.	Try again as necessary after online update performed by other tool is completed.
29	Failed to acquire the current revision.	The network may be busy. Try again. If the error persists, contact your service representative because a failure may have occurred in BMC.
30	Failed to acquire lines:	Some update files may be corrupted. Acquire update files again.
31	Invalid line length:	Some update files may be corrupted. Acquire update files again.
32	Unexpected EOF is detected:	Some update files may be corrupted. Acquire update files again.
33	Unexpected token is detected:	Some update files may be corrupted. Acquire update files again.
34	PIA does not suit this server.	It is not Platform Information (PIA) of this server. Acquire update files again.

CONFIGURING I/O BOARD JUMPERS

With the pre-installed SETUP utility, you can set desired passwords to protect the data stored in the server against access from unauthorized users. When you forget the passwords, however, you may want clear them. The following describes how to clear these passwords. You can also use the following procedure to clear the CMOS data in the server.

IMPORTANT: Clearing the CMOS data resumes the factory-set configuration data.

To clear passwords or the CMOS data, use the jumper switch on the I/O board of the server.

The following describe the clearing procedure.

⚠ WARNING	
	<p>Do not disassemble, repair, or alter the server.</p> <p>Never attempt to disassemble, repair, or alter the server on any occasion other than described in this manual. Failure to follow this instruction may cause an electric shock or fire as well as malfunctions of the server.</p>

1. Record the current BIOS settings.
2. Power off the server and unplug the power cord.
3. Remove the rear access cover from the server (see Chapter 9).
4. Remove the processor access cover from the server (see Chapter 9).
5. Change the desired jumper switch setting.

IMPORTANT:

- Do not change any other switch settings. Any change may cause the server to fail or malfunction.
- Use the clip over jumper pins (pins 1 and 2) on the I/O board.
- Do not lose the clip.

The following figure illustrates the jumper switch location.

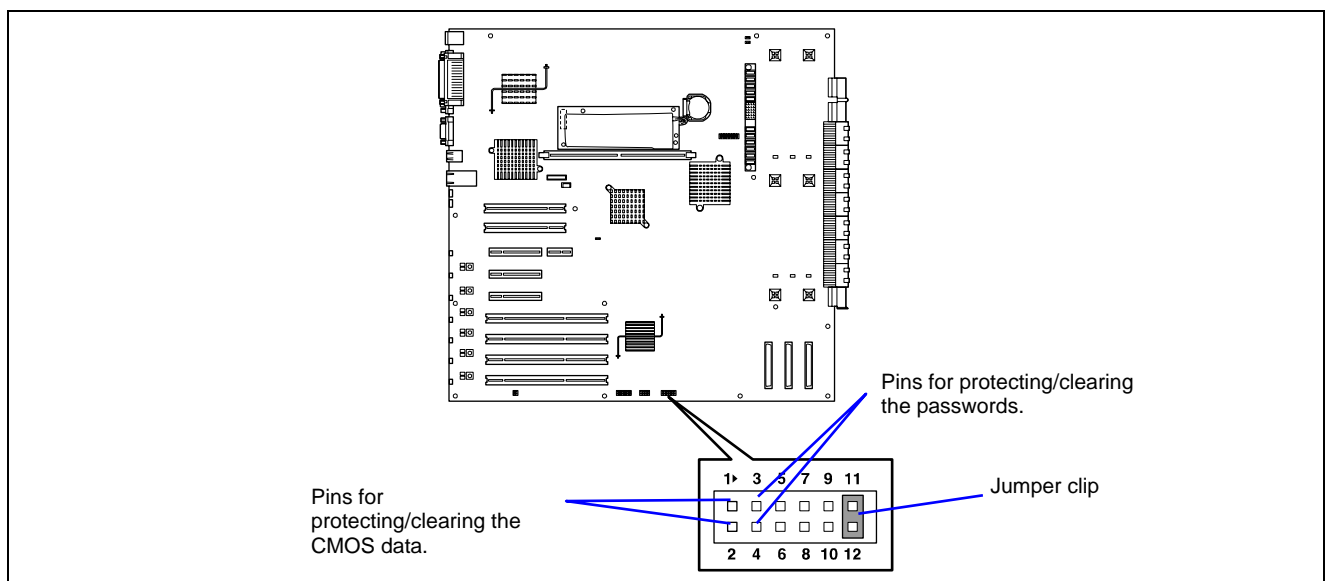

- Pins for protecting/clearing the passwords

Short-circuit these two pins to clear the passwords.
Open these two pins to protect the passwords (factory-set).

- Pins for protecting/clearing the CMOS data

Short-circuit these two pins to clear the CMOS data.
Open these two pins to protect the CMOS data (factory-set).

6. Reassemble the server and press the POWER switch.
7. When the POST screen appears, power off the server and unplug the power cord.
8. Restore the jumper switch setting.

NOTE: Place the clip over the jumper pins 11 and 12 after use to keep the pin. Placing the clip over any other pins may cause malfunction of the server.

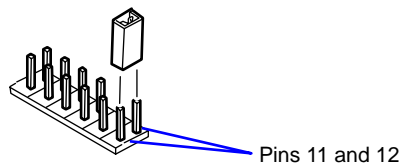

-
9. Reassemble the server and press the POWER switch.
 10. Run BIOS setup utility and restore the parameter settings recorded in Step 1.
If you have cleared the password, set it again as needed.
 11. Save and exit the utility.

Chapter 5

Installing the Operating System with Express Setup

This section describes information on using Express Setup to install and configure the following operating systems to the server.

- Microsoft® Windows Server™ 2003

To use the server with another operating system than described in this section, contact your service representative.

IMPORTANT: Before installing the operating system, adjust the system date and time by using the BIOS set up utility "SETUP." See Chapter 4 for detail.

About Express Setup

"Express Setup" contained in your EXPRESSBUILDER CD-ROM is intended for initial setup of the server. Its automatic installation mode guides the user easily through the process by detailing specific hardware features and providing screen prompts for software selection and configuration. The program loads the utilities and drivers, applies RAID settings, partitions the disk, and installs the desired operating system.

IMPORTANT: Executing the Express Setup erases all data on the hard disk.



For Microsoft® Windows Server™ 2003 and Windows® 2000, Express Setup automatically configures your server and installs the operating system. After a few tasks are completed, all that remains to be done is to remove the EXPRESSBUILDER CD-ROM and insert the Windows CD-ROM, input a product ID number, and acknowledge the license agreement.

For the other operating systems, Express Setup initializes the target disk(s), creates the maintenance partition, and installs the various maintenance utilities from the EXPRESSBUILDER CD-ROM to lead your server to ready-to-install for the desired operating system.

You can also use "Configuration disk" at "Express Setup" in order to save or backup parameters for installation.

The Configuration disk is able to have some parameter files that include the configuration information for the server setup.

If you want to set up the server as before, execute the Express Setup with the parameter file you have saved before.

NOTES:

- The parameters file is not mandatory to set up the system.
 - If you want to create a parameters file, have a blank floppy disk (MS-DOS 1.44 MB format) ready.
 - If you want to use the drivers located on the "OEM-Disk for Mass Storage Device" that ships with optional boards, a parameters file is mandatory.
 - You can create a parameters file in advance using "Configuration Diskette Creator" included in EXPRESSBUILDER.
-

Microsoft® Windows Server™ 2003

This subsection provides information on installing Microsoft® Windows Server™ 2003 in the server. Read instruction in this section before proceeding the installation.

NOTES:

- Express Setup does not support the installation of Windows Server™ x64 Editions. If you want to install it, see Appendix D.
 - If you install Windows Server 2003 without using Express Setup, see Appendix E.
-

Installation Notice

This section explains precautions and matters you should be aware of before beginning installation in order to install Windows Server 2003 correctly.

Supported operating system on this model

The server supports the following edition:

- Microsoft® Windows Server™ 2003 Standard Edition
(Described as "Windows Server 2003" from now on.)
- Microsoft® Windows Server™ 2003 Enterprise Edition
(Described as "Windows Server 2003" from now on.)

On installing other operating system, contact sales dealer or the maintenance service representative.

BIOS Specification

Before installing Windows Server 2003, confirm if the BIOS specification of the hardware is correct. See Chapter 4 to specify them.

ESMPRO Agent

ESMPRO Agent requires installing the necras.sys driver on your Windows system.

If you install the Windows without using the Express Setup, run the Update Express5800 system in Master Control Menu.

Optional Board Supported by EXPRESSBUILDER

EXPRESSBUILDER CD-ROM attached to your system supports the following optional boards:

NOTE: If you want to install the other boards except ones listed below by using a driver floppy disk ("OEM-FD for Mass storage device"), see "Exceptional setup" and "Installing Optional Mass Storage Driver" of "Configuration Diskette Creator" in Chapter 6.

- Supporting installation of operating system in EXPRESSBUILDER
 - On Board RAID (Controller on the I/O board)
 - SecuRAID 321 Disk Array Controller (SCSI 2ch)
- Other optional boards
 - Initio 101 SCSI Controller
 - Adaptec 29320 SCSI Controller
 - SCSI U160 PCI-ATX-64b 1 Disk Controller

IMPORTANT: If you want to set up for the SecuRAID 321, you cannot use "Express Setup". See Appendix E, and set it up.

Windows Server 2003

Express Setup can install Windows Server 2003 operating system. However, note the following issue:

IMPORTANT:

- Before starting the installation, complete all the process of adding the optional device and the setup of Express server mainframe (BIOS and optional board specification)
 - A document for installing Windows Server 2003 is also attached to the other software package which is sold separately, but refer to this document when you install Windows Server 2003 on this model.
 - After completing Express Setup, see "Setup for Solving Problems" described later to specify the settings for trouble recovery such as "Specifying Memory Dump".
-

Installing on the Mirrored Volume

If you want to install Windows Server 2003 on the volume that is mirrored using "Disk Management", invalid the mirroring before operating the installation to set back to the basic disk, and valid the mirroring again after the installation has completed.

Creating, invalid, delete mirror volume can be operated from "Disk Management" in "Computer Management".

Connecting MO Device

If you are installing Windows Server 2003 with MO device connected, the installation may not be completed normally. In such case, disconnect the MO device and then re-install the system from the beginning.

Media such as DAT

During the operating system installation, do not attach the unnecessary media for operating system installation to the system, such as DAT.

Connecting Hard Disk

Connect the hard disk that operating system is not going to be installed on after installing the operating system.

NOTE: If you connect the N8103-81F board as a data disk, clear disk array controller's configuration information before you perform the Express Setup. The process for clearing configuration information is described in the manual attached to the N8103-81F board.

Creating Partition Size

The size for the partition that the system is to be installed can be calculated from the following formula.

Size necessary to install the system	+ Paging File Size + Dump File Size + Application Size
Size necessary to install the system	= 2900 MB
Paging File Size (Recommended)	= Mounted Memory Size * 1.5
Dump File Size	= Mounted Memory Size + 12 MB
Application Size	= Required Size

IMPORTANT:

- The above-mentioned paging file size is recommended for collecting debug information (memory dump). The paging file with initial size large enough to store the dump file in the boot drive is required.
It may not be possible to collect correct debug information due to virtual memory shortage when the paging file is insufficient, so set a paging file size large enough for the entire system.
 - The maximum paging file size which can be set on one partition is 4095 MB. If the above paging file size exceeds 4095 MB, specify 4095 MB for the paging file size.
 - The maximum dump file size for the system with more than 2 GB memory mounted is '2048 MB + 12 MB'.
 - If you install any application program or the like, add necessary space to the partition to install these programs.
-

For example, if the mounted memory size is 512 MB, the partition size will be calculated by the above formula as follows:

$$2900 \text{ MB} + (512 \text{ MB} * 1.5) + (512 \text{ MB} + 12 \text{ MB}) + \text{Application Size} = 4192 \text{ MB} + \text{Application Size}$$

Re-installing to the hard disk which has been upgraded to Dynamic Disk

You cannot re-install Windows Server 2003 with the current partition of the hard disk upgraded to Dynamic Disk kept remained.

If you want to keep the current partition remained, see Appendix E to re-install the system.

About maintenance partition (the area displayed as "MAINTE_P")

The maintenance partition for server maintenance is reserved in the head of Hard Disk Drive (a partition of approximately 55 MB). This area is for saving some maintenance utilities. Do not delete the maintenance partition.

Setup Flow

This section visually describes Express Setup setup flow.

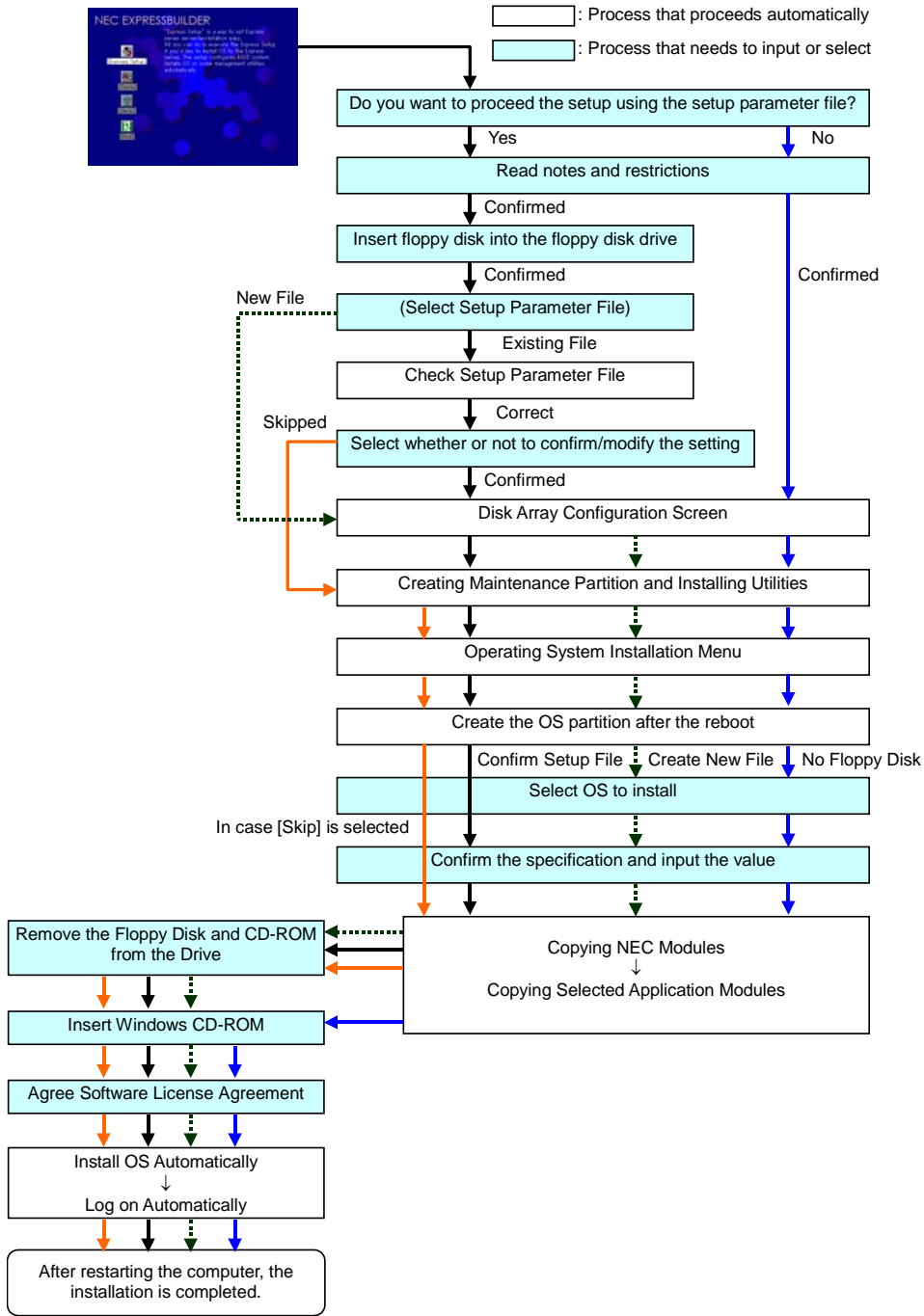

Installing Windows Server 2003

Express Setup proceeds to the setup by specifying the necessary information in the wizard. You can also save the setup information created in the wizard on a floppy disk as a setup file.

NOTE: One floppy disk formatted by MS-DOS 1.44 MB is necessary to save the setup information. Please prepare a floppy disk by yourself before the installation.

Using the same setup file you saved and used before allows you to omit specifying the setup information in the wizard.

And if you use a floppy disk which is attached to the optional device such as disk array controller and contains device driver to install optional mass storage driver while processing the Express Setup, you have to save the setup information in the setup file. Please prepare one empty floppy disk for setup file in this case, too.

1. Turn the power of peripheral devices on, and then turn on the server.

NOTES:

- If you are installing Windows Server 2003 with an MO device connected, the installation may not be completed normally. In such case, detach the MO device and then re-install the system from the beginning.
 - Connect the hard disk drive that operating system is not going to be installed to after installing operating system.
 - If you create multiple logical drives in your system, refer to "Reinstalling the operation system when multiple logical drives exist" (Appendix E).
-

2. Insert the EXPRESSBUILDER CD-ROM into the CD-ROM drive of the server.
3. Press the RESET switch or press **Ctrl, Alt, and Delete** to reboot from the EXPRESSBUILDER. (You may also turn off and then on again to reboot the server.)

The system will boot from the CD-ROM and EXPRESSBUILDER starts.

4. Click [Express Setup].
5. The message, "Do you want to use the parameter file in order to set up the Express Server or Workstation", will be displayed.

If you use the setup parameter file, click [Yes] and if you do not use the setup parameter file, click [No].

6. "Note" will be displayed. Read the instruction carefully and click [Confirm].
7. Notes and restrictions are displayed.

Read the messages carefully and click [Confirm].

NOTE: If some operating system has already been installed on the hard disk, a message asking if you want to continue the installation appears.

If you wish to continue the installation, click [Continue].

8. If you selected "Yes" at step 5, place a floppy disk into the floppy disk drive mounted on the server. If not, go to next step.

NOTE: If you set the floppy disk at this step, do not remove the floppy disk from the server until the message as removing the floppy disk appears.

[Using the existing Configuration Disk]

The parameters files in the floppy disk are listed in the dialog box.

- 1) Select a parameters file to use in the Express Setup, and then click [Use].

After the parameters file is specified, the message "Do you want to review or modify the Setup File parameters?" appears.

- 2) If you want to modify or confirm the parameters file, click [Review]. If not, click [Skip].

Click [Review] → Go to next step.

Click [Skip] → Go to step 10.

[Using a blank disk]

- 1) Click the box under [Setup File Name: (A)] or press **A**.

The dialog box appears.

- 2) Type the file name and click [Use].

9. Confirm or modify the parameters of disk array configuration.

[Configure RAID] screen appears. Confirm the specification, modify if necessary, and then click [OK].

NOTE: Choose RAID0 when you install it in one hard disk.

When the dialog box is closed, the Express setup automatically performs the RAID configuration, creating Maintenance partition and installing several utilities.

10. Select the installing Operating system.

Select "Windows" from the menu.

11. Select the Windows family.

Select "Microsoft Windows Server 2003 Standard Edition / Microsoft Windows Server 2003 Enterprise edition" category.

NOTE: If you selected "Skip" at step 8, this menu does not appear, go to step 13.

12. Next, [Basic Information] wizard appears. Confirm the parameters, modify if necessary, and then click [Next].

After that, click [Next], [Back], or [Help] to continue. Modify the parameters each time necessary.

IMPORTANT:

- Reserve the partition to install the operating system more than the minimally required size.
- If you select "Use Existing Array" at "New/Existing RAID Configuration", the information included in the first partition (excluding maintenance partition) will all be formatted and deleted. The information included in the other partition will be retained. The figure below describes the partition which information will be deleted when maintenance partition exists.

First Partition <Maintenance Partition> Retained	Second Partition Deleted	Third Partition Retained	Fourth Partition Retained
--	--------------------------------	--------------------------------	---------------------------------

- You cannot re-install the system with the existing partition that is upgraded to Dynamic Disk remained. Do not select "Use Existing Array" at "New/Existing RAID Configuration".
- If you specify other than 4095 MB for the "Installing Partition", it is necessary to convert to NTFS.
- If "Use Existing Array" at "New/Existing RAID Configuration" is selected but the partition other than the one to install Windows Server 2003 does not exist (excluding

maintenance partition), Express Setup will reserve the maximum area of the hard disk to install Windows Server 2003.

- You cannot go to the next screen if the specification is incorrect.
 - On specification, an error may occur in relationship with the specified contents of the former screen and require to go back to modify the specification.
 - During the setup, the screen to specify the partition that Windows Server 2003 is to be installed appears. The first 55 MB area displayed on the screen is a partition that is used to store the configuration information or utilities unique of the server. We do not recommend to delete this area, but if you do not want to reserve this 55 MB area, perform the installation by manual setup. It is not possible to delete this area by Express Setup.
-

NOTES:

- If you click [Cancel] in [Basic Information] screen, the screen will go back to select the operating system. [Cancel] exists only in [Basic Information] screen.
 - If you click [OK] in [Role of Computer] screen, the setup automatically selects default value for the later specification to continue the installation.
-

13. Copy the modules for the optional mass storage driver.

If you want to install the optional mass storage driver, insert the floppy disk attached to mass storage driver into the floppy disk drive and follow the message to perform the installation.

NOTE: You can use this function only when the floppy disk drive is attached to the system.

14. Remove EXPRESSBUILDER CD-ROM from the CD-ROM drive according to the message.

If you proceed to the setup by using setup parameter file, remove the floppy disk from the floppy disk drive.

Insert Windows Server 2003 CD-ROM into the CD-ROM drive.

[Agree Software License Agreement] screen appears.

15. Read the contents carefully and click [I agree.] or press **F8** if you do agree. If you do not agree, click [I disagree] or press **F3**.

IMPORTANT:

- If you do not agree to this agreement, the setup terminates and Windows Server 2003 will not be installed.
 - If "NetWare Gateway (and Client) Service" is specified to install, the window to specify the details of "NetWare Gateway (and Client) Service" pops up on the first logon. Specify the appropriate value.
-

Now the Setup using Express Setup has completed.

Installing and Setting Device Drivers

Follow these steps to install and configure the device drivers.

PROSet

PROSet is a utility that confirms the function of network contained in network driver.

Utilizing PROSet enables the following items:

- Confirm detailed information about the adapter.
- Diagnose loop back test, packet transmission test, etc.
- Setup of teaming.

Configuring several network adapters as one team provides the server a tolerant environment on any trouble and enhance throughput between the switches.

PROSet is necessary to use these features.

Follow the procedure below to install PROSet.

1. Insert the EXPRESSBUILDER CD-ROM into the CD-ROM drive.
2. The [Windows Explorer] dialog starts.
 - * Procedure with the standard start menu
Click Start menu and click [Windows Explorer].
 - * Procedure with the classic start menu
Click Start menu, point to [Programs], [Accessories] and click [Windows Explorer].
3. Run "PROSET.EXE" in the following directory.
CD-ROM DriveLetter:\WINNT\DOTNET\BC5\PROSET\WS03XP32
The [Intel(R) PROSet - InstallShield Wizard] dialog starts.
4. Click [Next].
5. Choose "I accept the terms in the license agreement" and click [Next].
6. Choose "Typical" and click [Next].
7. Click [Install].
8. When [InstallShield Wizard Completed] window is displayed, click [Finish].
9. Restart the system.

Network Driver

Specifying the details of network driver.

Two standard network drivers that are mounted will be installed automatically, but the link speed and Duplex mode need to be specified manually.

[When PROSet is not installed]

1. The [Local Area Connection Properties] dialog box appears.
 - * Procedure with the standard start menu
 1. Click Start menu, then [Control Panel], [Network Connections], and finally [Local Area Connection].
 - * Procedure with the classic start menu
 1. Click Start menu, [Settings] and then [Network Connections].

The [Network Connections] dialog box appears.
 2. Right-click [Local Area Connection] and click [Properties] from the drop-down menu.
2. Click [Configure].

The property dialog box for network adapter appears.
3. Click [Advanced] and specify [Link Speed & Duplex] value the same as the value specified for the HUB.
4. Click [OK] on the property dialog box for network adapter.

[When PROSet is installed]

1. The [Intel PROSet] dialog box appears.
 - * Procedure with the standard start menu

Click Start menu, point to [Control Panel] and click [Intel PROSet].
 - * Procedure with the classic start menu
 1. Click Start menu, point to [Settings] and click [Control Panel].
 2. Double-click [Intel(R) PROSet] on the [Control Panel] window.
2. Click [(Network Adapter Name)] in the list.
3. Click [Speed] and specify [Link Speed & Duplex Settings] value the same as the value specified for the HUB.
4. Click [Apply] and click [OK].

Specify the other network driver with the same process as above.

Also, add or delete any protocols and services if necessary.

You can operate the process on the property dialog box for local area network which can be appeared from [Network and Dial-up Connection].

NOTE: We recommend you to add [Network Monitor] at [Adding Services]. [Network Monitor] can monitor the frame (or the packet) that the computer installing [Network Monitor] sends or receives. This tool is valuable when analyzing network trouble. For information on how to install the tool, see the "Setting for Solving Problems" described later in this chapter.

Optional Network Board Driver (INTEL PRO/1000 TX 64-BIT PCI / INTEL PRO/1000 F 64-BIT PCI / 64B PCI-X PRO 1000MT DUAL)

If you want to use an optional Network Board, the network driver will be installed automatically.

Therefore, the driver attached to the Network board should not be used.

IMPORTANT: If you want to use optional Network Board INTEL PRO/1000 TX 64-BIT PCI, open [Advanced] in PROSet window and change [Offload TCP Segmentation] value to "Off".

Installing SCSI Controller Driver (Initio 101 / Adaptec 29320)

If you use SCSI controller driver (Initio 101 / Adaptec 29320), install it according to the following procedure:

1. Start [Device Manager] from [Start] menu → [Control Panel] → [Administrative Tools] → [Computer Management].
2. Double-click the SCSI Controller driver which Device Manager lists as unknown device.
3. Click [Update Driver].
4. When the "Update Device Driver Wizard" appears, select "Install from a list or specific location [Advanced]" and click [Next].
5. Select "Don't search. I will choose the driver to install" and click [Next].
6. Click [Have Disk..].
7. Insert "Windows Server 2003 OEM-DISK for EXPRESSBUILDER" into the floppy disk drive, enter "a:\" into "copy manufacturer's file from:" and click [OK].
8. Specify the following driver and click [Next].
 - [INITIO INI-A10XU2W PCI SCSI Controller](When Initio 101 board is installed.)
 - [Adaptec SCSI Card 29320ALP - Ultra320 SCSI](When Adaptec 29320 board is installed.)

The installation of the driver is completed.

Restart the system according to the message appeared on the screen.

Installing SCSI Controller Driver (SCSI U160 PCI-ATX-64b 1)

If you use SCSI controller driver (SCSI U160 PCI-ATX-64b 1), update your system with EXPRESSBUILDER CD-ROM attached to your system.

The SCSI controller driver will be installed automatically.

Installing Disk Array Controller Driver (SecuRAID 321)

To additionally install the SecuRAID 321 in a system containing Windows Server 2003, connect the controller and install the driver as follows:

1. When the [Found New Hardware Wizard] dialog box appears, click [Next].
2. When the [Install Hardware Device Drivers] dialog box appears, select [Search for a suitable driver for my device (Recommended)], and click [Next].
3. When the [Locate Driver Files] dialog box appears, select [Floppy disk drives], insert "Windows Server 2003 OEM-DISK for EXPRESSBUILDER" into the floppy disk drive, and click [Next].
4. When the [Driver Files Search Results] dialog box appears, click [Next].
5. Copying of the driver is completed, and the [Completion of the new hardware detection wizard] dialog box appears; click [Complete].

Graphics Accelerator Driver

Standard graphics accelerator drivers that are mounted will be installed automatically. The following is the procedure when it is necessary to install manually.

If you want to use optional Graphics Accelerator Driver board, follow the document attached to the board to install the driver.

1. Insert the EXPRESSBUILDER CD-ROM into the CD-ROM drive.
2. Click Start menu, point to [Programs], [Accessories] and click [Windows Explorer].
3. Run "SETUP.EXE" in the following directory.
<CD-ROM Drive Letter>:\WINNT\DOTNET\VIDEO\SETUP.EXE.
4. Follow the on-screen instructions to continue the installation.
If the dialog message "Digital Signature could not be found." appears, select [Yes] to continue.
5. Remove the EXPRESSBUILDER CD-ROM from the CD-ROM drive, follow the on-screen instructions and restart the system.

Available Switch Options for Windows Server 2003 Boot.ini File.

Many different switches will be available if you edit Boot.ini file.

For the available switch options, refer to the following information:

- Microsoft Knowledge Base - Article ID: 833721

"Available switch options for the Windows XP and the Windows Server 2003 Boot.ini files"

If your system has a memory capacity in excess of 4 GB in its installing, adding /PAE switch in Boot.ini file will enable the system to be installed with over 4 GB of memory.

However, the Microsoft operating system products which support /PAE switch option are limited.

Refer to the following article in Microsoft Knowledge Base to check the supported products.

- Microsoft Knowledge Base - Article ID: 291988

"A description of the 4 GB RAM tuning feature and the Physical Address Extension switch"

Below is the example on how to add /PAE switch to Boot.ini file.

1. Click [Start], point to [Settings], and then click [Control Panel].
2. In [Control Panel], double-click [System].
3. Click the [Advanced] tab, and then click [Settings] under [Setup and Recovery].
4. Under [System Setup], click [Edit] to open [Boot.ini].
5. Add "/PAE" to [Operating Systems] section in [Boot.ini] file, and then save it.

<Example of Boot.ini file>

```
[boot loader]
timeout=30
default=multi(0)disk(0)rdisk(0)partition(2)\WINDOWS
[operating systems]
multi(0)disk(0)rdisk(0)partition(2)\WINDOWS="Windows Server
2003, Standard" /fastdetect
multi(0)disk(0)rdisk(0)partition(2)\WINDOWS="Windows Server
2003, Standard, PAE" /fastdetect /PAE
C:\CMDCONS\BOOTSECT.DAT="Microsoft Windows Recovery Console" /cmdcons
```

This is the end of editing Boot.ini file.

NOTE: If you choose one of the items in the "Default operating system" drop-down list box in [Setup and Recovery] group box, you can make your system start automatically from the switch you specified.

Setting for Solving Problems

Setup the following issue in advance so that your computer can recover from any trouble precisely and as soon as possible when it should occur.

Memory Dump (Debug Information)

This section describes the procedures for collecting memory dump (debug information) in the server.

IMPORTANT: Cautions for the Memory Dump

- The staff of your maintenance service representative is in charge of collecting memory dump. Customers need only to specify the memory dump.
 - If any trouble occurs after specifying the process below, the message to inform that the system is in short of virtual memory may appear, but continue to start the system. If you re-start the system in such case, memory dump may not be stored correctly.
-

Follow the procedure below to specify.

1. Select [Control Panel] and click [System].
The [System Properties] dialog box appears.
2. Select [Advanced] tab.
3. Click [Settings] on the [Startup and Recovery] group box.

IMPORTANT:

Windows Server 2003 x64 Editions

- Specifying "Complete Memory Dump" to write the debug information is recommended.
If the mounted memory size is larger than 2 GB, "Complete Memory Dump" cannot be specified, in this case specify "Kernel Memory Dump" instead.
- Specify a drive where there is a free area greater than the size of "the memory capacity mounted on Express server + 1 MB".
- In case the mounted memory size exceeds 2 GB due to the added memory, change the write debugging information to [Kernel Memory Dump] before adding memory. The size of debugging information (memory dump) to be taken also changes due to adding memory. Verify the size of the empty space in the debugging information (memory dump) write destination drive.

Windows Server 2003

- Specifying "Complete Memory Dump" to write the debug information is recommended.
If the mounted memory size is larger than 2 GB, "Complete Memory Dump" cannot be specified, in this case specify "Kernel Memory Dump" instead.
 - Specify a drive where there is a free area greater than the size of "the memory capacity mounted on Express server + 12 MB".
 - In case the mounted memory size exceeds 2 GB due to the added memory, change the write debugging information to [Kernel Memory Dump] before adding memory. The size of debugging information (memory dump) to be taken also changes due to adding memory. Verify the size of the empty space in the debugging information (memory dump) write destination drive.
-

4. Specify "Complete memory dump" and modify [Dump file:] in the [Write debugging information] group box.
e.g. Write the debug information in D drive write the file name "MEMORY.DMP".
D:\MEMORY.DMP
5. Click [Settings] on the [Performance] group box.
The [Performance Options] window appears.
6. Click [Advanced] tab on the [Performance Options] window.
7. Click [Change] on the [Virtual memory] group box.
8. Modify [Initial Size] in the [Paging file size for selected drive] box to a value larger than [Recommended], and click [Set].

IMPORTANT:

- The above-mentioned paging file size is recommended for collecting debug information (memory dump). The paging file with initial size large enough to store the dump file in the boot drive is required.
Correct debug information might not be able to be collected due to virtual memory shortage when the paging file is insufficient, so set the paging file size large enough for the entire system.
 - For more information on "Recommended" value, see "Partition Size to be Created" described earlier.
 - In case the memory is expanded, re-specify the paging file to suit the new memory size.
 - To prepare for the situation when any trouble occurred, we recommend you to press dump switch to confirm that the dump will be collected normally in advance.
-

9. Click [OK].

The message to restart the system may appear according to the modified specification. In such case, follow the message to restart the system.

Windows Dr. Watson

Windows Dr. Watson is a debugger for application errors. If any application error is detected, Dr. Watson diagnoses the server and logs diagnostic information (log). Follow the procedure below and specify Dr. Watson to collect diagnostic information.

1. Click [Run] on Start menu.
2. Type "drwtsn32.exe" in the [Open] box, and click [OK].
The [Dr. Watson for Windows] dialog box appears.
3. Specify the location to store the diagnostic information in the [Log File Path] box.
The diagnostic information will be stored with the file name "DRWTSN32.LOG".

NOTE: You cannot specify network path. Specify the path on local computer.

4. Specify the location of crash dump file in the [Crash Dump] box.

NOTE: "Crash Dump File" is a binary file that can be read with Windows Debugger.

5. Check the following check boxes on the [Option] box.

- Dump Symbol Table
- Dump All Thread Contexts
- Add To Existing Log File
- Create Crash Dump File

For more information on each function above, refer to Online Help.

6. Click [OK].

Network Monitor

Using Network Monitor helps you to investigate and manage network troubles. To use Network Monitor, you need to restart the system after the installation has completed, we recommend to install Network Monitor before any network trouble may occur.

1. Point to [Settings] from Start menu and click [Control Panel].
The [Control Panel] dialog box appears.
2. Double-click [Add/Remove Programs].
The [Add/Remove Programs] dialog box appears.
3. Click [Add/Remove Windows Component].
The [Windows Components Wizard] dialog box appears.
4. Check the [Management and Monitoring Tools] check box of the component ON and click [Next].
5. If the setup asks to install the disk, insert Windows Server 2003 CD-ROM into CD-ROM drive and click [OK].
6. Click [Complete] in the [Windows Component Wizard] dialog box.
7. Click [Close] in the [Add/Remove Application] dialog box.
8. Close the [Control Panel] dialog box.

To start Network Monitor, point to [Program] → [Administrative Tools] and click [Network Monitor]. For information on how to operate Network Monitor, refer to Online Help.

Installing Maintenance Utilities

Various maintenance utilities are contained in your EXPRESSBUILDER CD-ROM. See Chapter 6 for installing the utilities to your server or management workstations.

Updating the System

Update the system in the situation below:

- Processor is expanded (expanded from single processor to multi-processor).
- Modified system configuration.
- Recovered the system using recovery process.

Log on to the system with an account that has administrative authority (e.g. Administrator) and insert the EXPRESSBUILDER CD-ROM into the CD-ROM drive of the server.

[Setup Software] in [Master Control Menu] screen appears, so left-click the item. Click [Update Express5800 System] from the menu and the setup will start. After that, follow the message to continue the setup process.

Making Backup Copies of System Information

The system information includes the current BIOS settings and any specific information for the server.

Save the information after completing the system setup.

Without the backup data, you will not be able to recover the information.

You can save the information by the following process.

1. Insert the EXPRESSBUILDER CD-ROM in the CD-ROM drive and reboot the system.
2. Select [Tools].
3. Select [Off-line Maintenance Utility].
4. Select [System Information Management].
5. Set a floppy disk in the floppy disk drive.
6. Select [Save].

Exceptional Setup

This section explains how to setup by the exceptional way. You usually do not have to do as follows. The detailed information is provided by the manual of the Mass Storage Device.

Installation of Mass Storage Device not Supported by ExpressSetup

If you would like to install or re-install the operating system when the system has new mass storage device not supported by EXPRESSBUILDER, you have to set as follows.

1. Read the manual supplied with the mass storage device before setting the server.
2. If the mass storage device is a disk array controller, configure the RAID system before running EXPRESSBUILDER.
3. Boot the system from EXPRESSBUILDER CD-ROM.
4. (a) When the Disk Array Configuration dialog box appears, check "Use Existing Array".
(b) Check "Apply OEM-FD for Mass storage device".
5. Copy the driver for the mass storage device in the ExpressSetup.
Insert the floppy disk attached the mass storage device into the floppy disk drive.
Continue the ExpressSetup, referring to the on-screen messages.

This page is intentionally left blank

Chapter 6

Installing and Using Utilities

This section describes how to use the EXPRESSBUILDER CD-ROM that comes with your server and to install the utilities stored on the EXPRESSBUILDER.

EXPRESSBUILDER

EXPRESSBUILDER is an automated software integration tool to help simplify the process of installing and configuring your server. Shipped with all our servers, the EXPRESSBUILDER CD-ROM provides a flexible, guided installation process for system administrators to install Microsoft Windows Server 2003, Microsoft Windows 2000 or other operating systems (contact your service representative for the server certified operating systems).

NOTE: Before using EXPRESSBUILDER for initial setup, complete the hardware configuration.

EXPRESSBUILDER includes three distinct programs. Two can be booted under DOS for initial setup, and one is for use under Windows operating system.

- DOS-based with local console

Used to set up the server at the first time. This program is also used to diagnose the server and to install/uninstall the management utilities on the maintenance partition of the system drive.

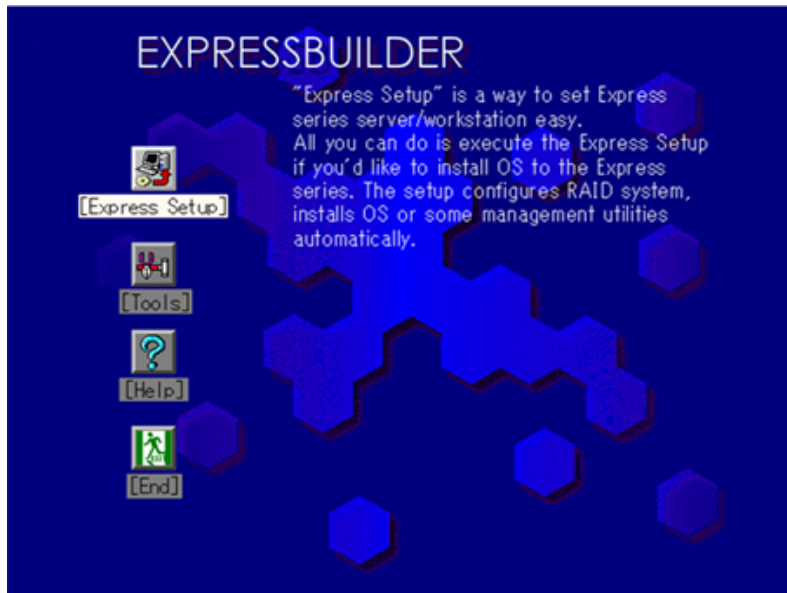

- DOS-based with remote console

Used to set up the server from the management workstation by accessing the server over the network or via COM B (serial) port.

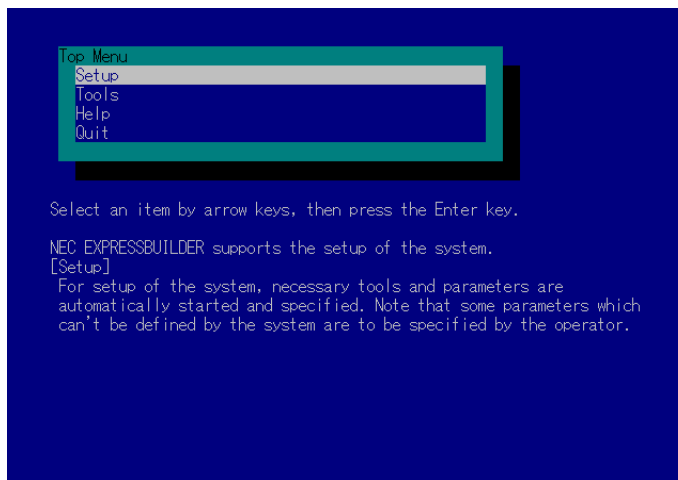

NOTE: No keyboard connected to the server is permitted to run this program.

- Windows-based

This program is called as "Master Control Menu" that can run under the Microsoft Windows system (Windows 95 or later and Windows NT 4.0 or later). You can install the several applications and read the documentation from the menu.

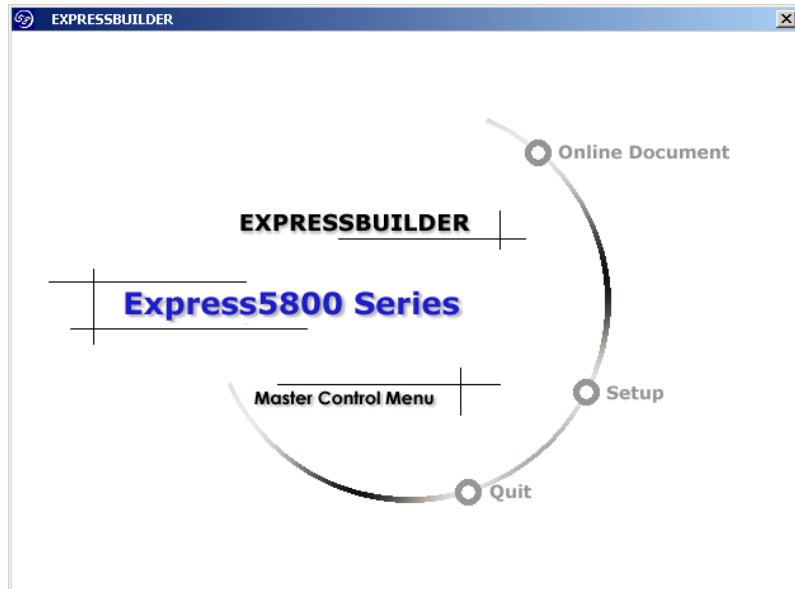

EXPRESSBUILDER for DOS-Based with Local Console

This subsection describes the procedures for using EXPRESSBUILDER for DOS-based with local console.

Starting EXPRESSBUILDER

The following procedure instructs you to start EXPRESSBUILDER.

IMPORTANT: Do not remove the EXPRESSBUILDER CD-ROM while EXPRESSBUILDER is running.

1. Turn on peripheral devices and the server in this order.
2. Insert the EXPRESSBUILDER CD-ROM supplied with your server into the CD-ROM drive of your server.
3. Ensure that the floppy disk drive is empty.
4. Press the RESET switch or press **Ctrl, Alt,** and **Delete** to reboot from the EXPRESSBUILDER. (You may also turn off and then on again to reboot the server.)

EXPRESSBUILDER boots up displaying the top menu.



Express Setup

"Express Setup" is intended for initial setup of the server. Its automatic installation mode guides the user easily through the process by detailing specific hardware features and providing screen prompts for software selection and configuration. The program loads the utilities and drivers, applies RAID settings, partitions the disk, and installs the desired operating system.

If you install Windows Server 2003 or Windows 2000, after a few tasks are completed, all that remains to be done is to remove the EXPRESSBUILDER CD-ROM and insert the Windows CD-ROM, input a product ID number, and acknowledge the license agreement.

IMPORTANT:

- Express Setup is intended for the initial setup of the server system and, therefore, Express Setup clears the contents of the hard disk.
 - When the setup is started, do not turn off the server until the setup is completed, and also make sure not to remove the "Configuration Diskette" from the floppy disk drive until the message that allow you to remove it appeared.
-

Tools

"Tools" is also intended for initial setup of the server. It provides more installation options than Express Setup and permits the user to quickly create utility support disks, run the Off-line Maintenance Utility and system diagnostic utility, set up a maintenance partition, and update the various BIOS programs.

Tools Menu	RAID Board: Present
Save/Restore RAID Configuration Data	Total Drives: 1
Off-line Maintenance Utility	Drives in Group: 1
System Diagnostics	Hot Spares: 1
Create Support Disk	RAID Level: 7
Setup Maintenance Partition	Write Mode: WRITE_THRU
BIOS/FW/etc. Update	Maint Part: Present
System Management	
Help	
Return to the Top Menu	

- **Save/Restore RAID Configuration Data**

The item allows the configuration information on the disk array system to be saved or restored from the floppy disk.

- Save Disk Array Configuration Data

The configuration information on the disk array controller is saved into the floppy disk. If you set or change RAID, always use this function to save the configuration information into a floppy disk.

- Restore Disk Array Configuration Data

The configuration information saved in a floppy disk is restored to NVRAM and hard disk on the disk array controller.

If the configuration information is broken or changed by mistake, restore the configuration information.

When the defected disk array controller is replaced, the configuration information on the hard disk must be saved into the disk array controller.

However, if the configuration information on the new disk array controller is saved into a hard disk, use this function to restore the configuration information.

IMPORTANT: Some Disk Array Controllers do not support this function. In that case, this menu will not be shown.

- Off-line Maintenance Utility

Off-line Maintenance Utility is an operating system independent maintenance program that performs preventive maintenance and error analysis for your server. See Chapter 8 or online help for details.

- System Diagnostics

System Diagnostics runs various tests on the server system to check if the server functions are normal and if the connection between the server and additional board is normal.

After the System Diagnostics is run, a system check program assigned to each model starts. See Chapter 7 for details.

- Create Support Disk

EXPRESSBUILDER CD-ROM contains a number of device drivers and utilities that you can put on floppy disks and load onto your system.

Using this menu creates a support disk by copying from the EXPRESSBUILDER CD-ROM. If your system has Windows operating system, you may find it more convenient to use EXPRESSBUILDER for Windows-based to make support disks

Write the displayed title on the floppy disk label, which is useful for management in the future. Customers are to provide a floppy disk to create a support disk.

- Windows Server 2003 x64 Edition OEM-DISK for EXPRESSBUILDER

- Creates a support disk for installing Windows Server 2003 x64 Editions.

- Windows Server 2003 OEM-DISK for EXPRESSBUILDER

- Creates a support disk for installing Windows Server 2003 Standard Edition and Windows Server 2003 Enterprise Edition. (No need to create this disk when installing the operating system with the Express Setup.)

- Windows 2000 OEM-DISK for EXPRESSBUILDER

- Creates a support disk for installing Windows 2000 Server and Windows 2000 Advanced Server. (This disk is used for Windows 2000 clean installation and for Recovery for Windows 2000 system.) (No need to create this disk when installing the operating system with the Express Setup.)

- ROM-DOS Startup FD

- Creates a support disk for starting the ROM-DOS system.

- Off-line Maintenance Utility Bootable FD

- Creates a support disk for activating the Off-line Maintenance Utility.

- System Management FD

- Creates a support disk for activating the System Management.

- Setup Maintenance Partition

Maintenance partition is a specific partition for the server and created on your system disk. About 55 MB of the maintenance partition includes the various maintenance utilities and executable commands.

In this menu, you can create the maintenance partition, install the various utilities, and update the utilities. The maintenance utilities installed in the maintenance partition are system diagnostics, System Management, and Off-line Maintenance Utility.

IMPORTANT:

- Do not reset or turn off the server while the running this menu. If the processing is discontinued, the system becomes unable to start.
 - The existence of the maintenance partition may be identified from the operating system. In order to retain the Configuration Data, do not delete the partition.
-

NOTES:

- The maintenance partition, once created, will not be recreated again.
 - When the maintenance partition does not exist, some menu items do not appear.
-

– Create Maintenance Partition

EXPRESSBUILDER creates about 55 MB of the maintenance partition on the system disk (or disk array system) as work area. The various utilities are installed when the maintenance partition is created successfully or when the maintenance partition is already created.

– Install Maintenance Partition Utilities

Various utilities are installed in the maintenance partition from the CD-ROM.

– Maintenance Partition Update

Various utilities are copied in the Maintenance Partition from the update disk. This menu is only used when the update disk is supplied from your service representative or attached with your system.

– FDISK

Execute FDISK command of ROM-DOS system. You can create/delete partitions, etc.

■ BIOS/FW/etc. Update

This menu allows you to update software modules such as BIOS and firmware of the server by using the update disk (3.5-inch floppy disk) that is distributed from our customer service representative.

After rebooting the system, an update program is started automatically from the floppy disk, and the various BIOS and firmware programs are updated.

IMPORTANT: Do not turn off the server while the update program is running. If the update processing is discontinued, the system becomes unable to start.

■ System Management

The parameters of BMC (Baseboard Management Controller) are set for remote control and alert.

■ Help

Displays explanations about various functions of EXPRESSBUILDER.

■ Return to the Top Menu

Choosing this menu returns to the Top Menu.

EXPRESSBUILDER for DOS-based with Remote Console

This subsection describes the procedures for using EXPRESSBUILDER for DOS-based with remote console.

EXPRESSBUILDER contains the remote console feature that allows the system administrator to set up the server from the management workstation (management PC) via the network or the server's COM2 (serial) port.

IMPORTANT:

- Do not use this feature on any other computer than the server, or on any other server obtained without EXPRESSBUILDER. Doing so may cause a failure of the server.
 - When a keyboard is connected to the server, the remote console feature is disabled. EXPRESSBUILDER determines that the server has a console. (Nothing is displayed on the management PC.)
-

Starting

The following two methods are available to start the server.

- Running EXPRESSBUILDER from the management PC via LAN
- Running EXPRESSBUILDER from the management PC via direct connection (COM2)

For the procedure for starting EXPRESSBUILDER for DOS-based with Remote Console, see "DianaScope".

IMPORTANT: Do not change the boot device order in BOOT menu in BIOS SETUP. EXPRESSBUILDER cannot be used if the CD-ROM drive is not the first device to launch the system.

To use this feature, you need a 3.5-inch floppy disk. Please prepare a floppy disk.

NOTE: The following items of BIOS setup information will be set as shown below.

- LAN Controller 1 (10/100): [Enabled]
 - Serial Port A: [Enabled]
Base I/O address: [3F8]
Interrupt: [IRQ 4]
 - Serial Port B: [Enabled]
Base I/O address: [2F8]
Interrupt: [IRQ 3]
 - Serial Port Address: [On-board COM B]
 - Baud Rate: [19.2k]
 - Flow Control: [CTS/RTS]
 - Console Type: [PC ANSI]
-

Top Menu

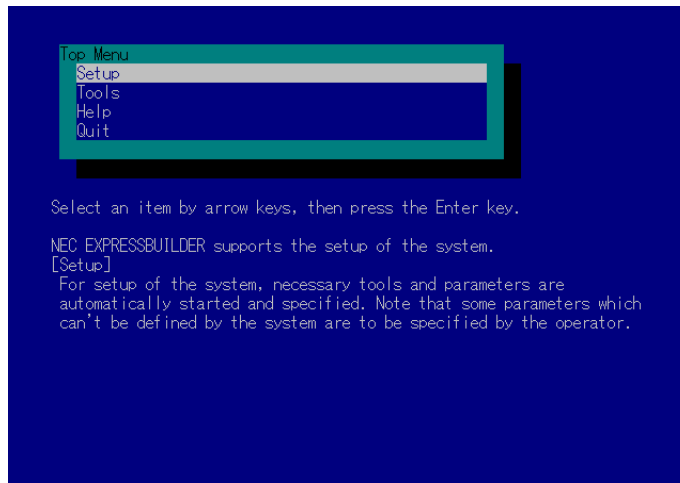

Shown below are the top menu items.



- Setup
Automatically sets up the server.
- Tools
Launch the features of EXPRESSBUILDER individually.
- Help
Help message on EXPRESSBUILDER.
- Quit
Quit EXPRESSBUILDER.

Setup

The EXPRESSBUILDER checks the hardware configuration of the server. The disk array and maintenance partition are automatically configured.



Tools

When you select the [Tools] on the Top Menu, the following screen appears.

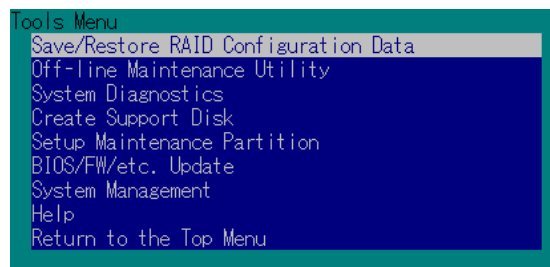

The menu items available only in remote console operation among those described in section "EXPRESSBUILDER for DOS-Based with Local Console" are displayed. See the previous subsection for detailed explanation of menu items.

EXPRESSBUILDER for Windows-Based (Master Control Menu)

The Master Control Menu is used to,

- Read the User's Guide or the other documents,
- Update the Express5800 system, and
- Install the management software.

NOTES:

- Master Control Menu requires Microsoft Windows 95 (or later) or Windows NT 4.0 (or later).
 - Some documents are provided in the PDF format. Use the Adobe Reader to view or print these documents.
-

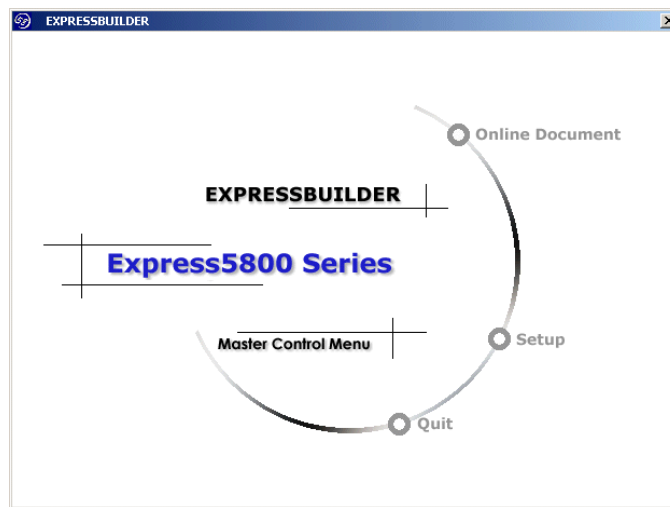

Insert the EXPRESSBUILDER CD-ROM into the CD-ROM drive.

Master Control Menu appears on the screen automatically. If the CD-ROM Autorun function is invalid in your system, run the \MC\1ST.EXE file in the CD-ROM directly.

Some items are greyed-out if the logon user does not have the administrator authority or the item is not proper for the system.

To use Master Control Menu,

- Click [Online Document],[Setup] or [Quit], or
- Click the right mouse button on the Master Control Menu window.

CONFIGURATION DISKETTE CREATOR

"Configuration Diskette Creator" is a tool to create [Configuration Diskette] that is used for configuring the server with the Express Setup (see Chapter 5 for details).

If you use the Configuration Diskette created by the Express Setup and Configuration Diskette Creator to run the setup, you can setup from the installation of operating system to several utilities automatically except for a few key input to confirm the specification. Also, you can install the system with the same specification as before when re-installing the system. We recommend you to create [Configuration Diskette] to setup the servers from EXPRESSBUILDER.

IMPORTANT: You can not create [Configuration Diskette] for Microsoft® Windows Server™ 2003 x64 Editions.

NOTE: You can install Windows Server 2003 and Windows 2000 without [Configuration Diskette]. Also, you can modify/newly create [Configuration Diskette] during the setup with EXPRESSBUILDER.

Creating Configuration Diskette

This section describes about specifying setup information that is necessary for operating system installation and creating [Configuration Diskette]. Follow the procedure below.

NOTE: In the procedure below, the folder name that is specified when installing Trekking command is assumed as [Configuration Diskette Creator].

1. Start the operating system.
2. Insert the EXPRESSBUILDER CD-ROM into the CD-ROM drive.
Master Control Menu will appear.
3. Right-click on the screen or left-click [Software Setup]. The menu will appear.
4. Click [Configuration Diskette Creator].
Configuration Diskette Creator window is displayed.

5. Click [Create New Information files] from the [File] menu.

The [Disk Environment] dialog box will be displayed.

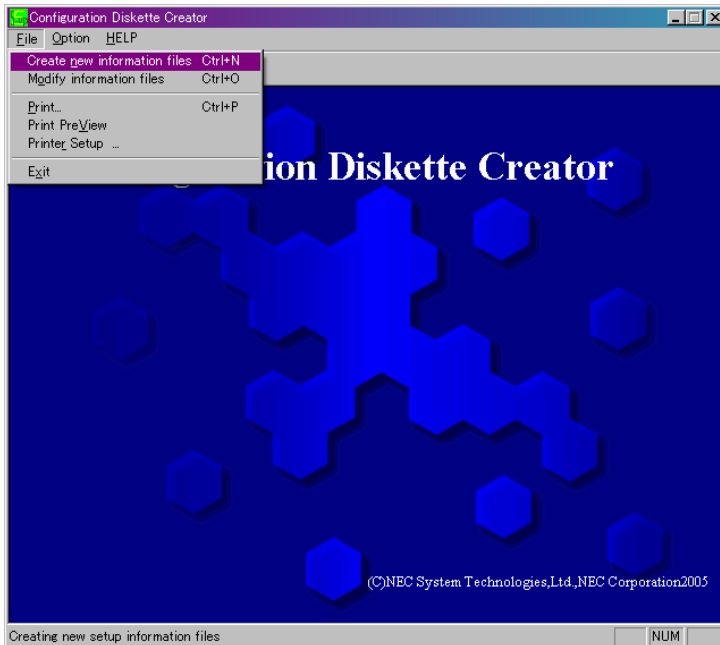

6. Specify each item and click [OK].

The dialog boxes to specify setup information will be displayed in order, such as [Basic Information] dialog box.

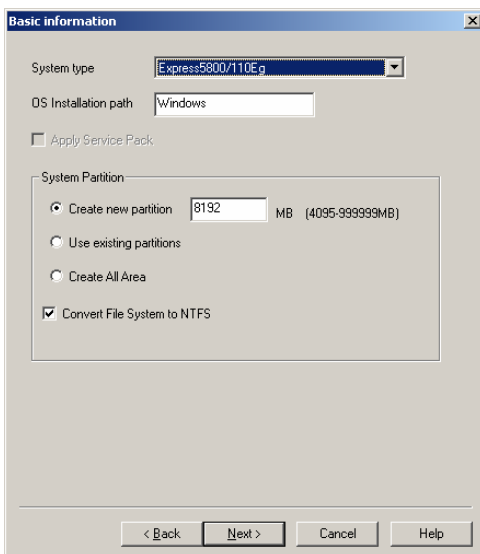

7. Follow the message to specify each item on the dialog box and click [Next].

NOTE: If you click on [Cancel], all the input value will be deleted.

When completing the specification of setup information, the [Save Setup Information] dialog box will appear.

8. Confirm that the [Configuration Diskette] check box is checked and type the file name for the Setup File in [File Name].

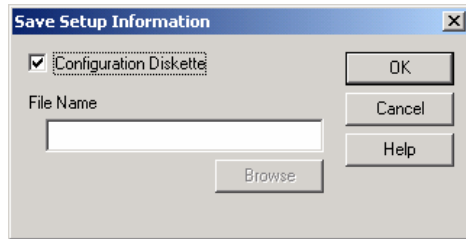

9. Insert the floppy disk formatted by 1.44 MB into the floppy disk drive and click [OK].

Now [Configuration Diskette] has been created. [Configuration Diskette] is used when you install Windows Server 2003 or Windows 2000. Put a label and keep it in a safe place.

NOTE: For information on the contents of each item, refer to the Online Help.

If you want to modify the information file that already exists, click [Modify information files] on Configuration Diskette Creator window. Refer to the Help to modify the inf file.

Installing Optional Mass Storage Driver

To install an optional Mass Storage Driver that is supported by Express Setup, follow the procedure below to create [Configuration Diskette]:

1. Display Configuration Diskette Creator window.
2. From the [File] menu, click [Create new information files].
[Disk Environment] dialog box will be displayed.
3. Specify each item and click [OK].

The dialog boxes to specify setup information will be displayed in order, such as [Disk Environment] dialog box.

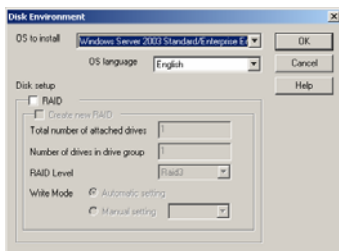

4. Follow the message to specify each item on the dialog box and click [Next].

NOTE: If you click [Cancel], all the input value will be deleted.

5. When [User and application setup] is displayed, check [Apply OEM-FD for mass storage device].

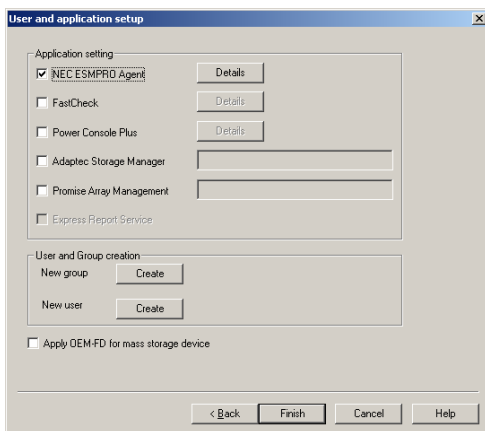

6. When the [Save Setup Information] dialog box is displayed, confirm that the [Configuration Diskette] check box is checked and input file name for the Setup File in [File Name].
7. Insert the floppy disk formatted by 1.44 MB into the floppy disk drive and click on [OK].

ESMPRO

ESMPRO (referred to as ESM PRO hereafter) lets a system administrator manage remote servers across a network. ESM PRO monitors server hardware and software configurations, failures, and performance. With log data collected by ESM PRO, a system administrator can track long-term and short-term performance, monitor server usage, create graphs to record trends, and check server failure rates. The administrator can use the information collected to create more efficient data routing procedures and optimize server usage.

Functions and Features

ESM PRO offers many functions and features for managing remote servers across a network. These features help the system administrator perform daily system operation, system extension, and transfer tasks. Some features of ESM PRO Manager include:

- Hardware and software server configuration
 - Hardware resources mounted in servers, such as the processor, memory, disks, disk arrays, and LAN boards.
 - Software resources, such as operating system information and drivers running on each server.
- Server failures
 - On-screen real-time displays provide the system administrator with the failure type, location, cause, and suggested corrective action.
 - Failure data includes hardware failure information such as system board temperature, memory failure, crashes, and software failure information.
- Performance
 - ESM PRO monitors server performance and displays server usage on the screen and displays information, such as the rate of processor load, memory usage, disk usage, and LAN traffic. Usage threshold values can help the system administrator monitor and prevent server overloads.

For installation procedure and detailed explanations on ESM PRO, refer to the online document in the EXPRESSBUILDER CD-ROM.

Supplement

Note the following in addition to the NOTE that has been described to the online document for ESM PRO.

- Indication on ESM PRO Data Viewer after Hot-Add/Remove Memory
 - If you add or remove a memory board dynamically by using hot-add/remove feature, the added or removed memory size will not be indicated correctly on Data Viewer of ESM PRO Manager unless the system is rebooted.

DianaScope

DianaScope is a software application for remote management of the Express5800 series.

See the online documents for details on the functions and installation of DianaScope.

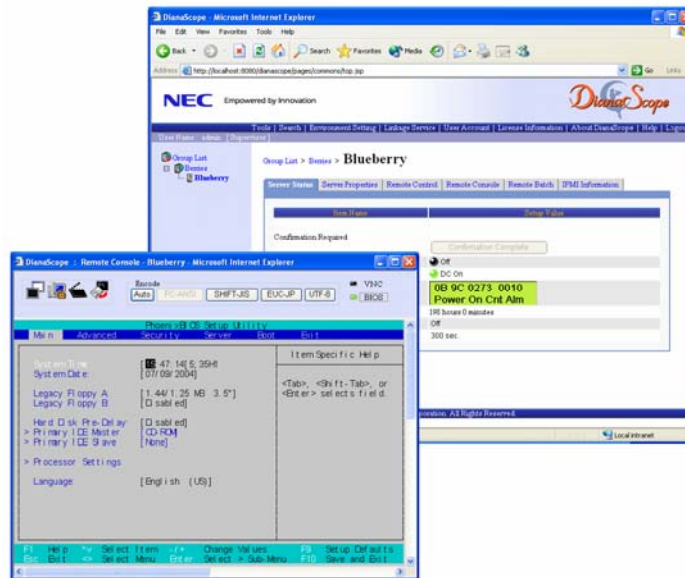

NOTES:

- One server license is required for each server to be managed remotely by using DianaScope.
- Please contact your service representative in order to purchase this accessory.

Power Console Plus

Power Console Plus is a utility to control the RAID system. Use of Power Console Plus enables operations (e.g., monitoring and maintenance) of RAID systems that are constructed on local Express servers and Express servers connected through networks (TCP/IP). The operations can be done online on graphical screens without the system being stopped.

Major Functions

Power Console Plus has the following features:

- Supporting the Wizard function to facilitate configuration
- Enabling the change of RAID levels
- Being compatible with SAF-TE
- Supporting the performance monitor
- Supporting enclosure functions such as temperature monitoring, power monitoring, and fan monitoring
- Enabling the settings of Write, Read, and Cache policies for each logical drive
- Supporting the save and restore functions for configuration
- Enabling the display of the SCSI transfer rate

Components

Power Console Plus consists of the following five components:

- **SNMP Agent**
This function is not yet supported. Do not install SNMP Agent.
- **MegaRAID Service Monitor**
This function enables ESMPRO to monitor the MegaRAID controller by registering event logs. Install MegaRAID Service Monitor in the Express server in which the MegaRAID controller is mounted.
- **MegaRAID Client**
This function controls the RAID system on graphical screens. Install MegaRAID Client in the Express server in which the MegaRAID controller mounted or in the management PC that is connected through the Express server and network.
- **MegaRAID Server**
Enables control of the MegaRAID controller via the network. Install MegaRAID Server in the Express server in which the MegaRAID controller mounted.
- **MegaRAID Registration Server**
Enables control of the MegaRAID controller via the network. Install in one of Express servers and management PCs that are connected through network. The above components must be installed correctly for establishing the environment to use Power Console Plus.

Power Console Plus components to be installed are different between the target servers and management PC.

- **Server:**
Express server in which the MegaRAID controller is mounted
Install the following two components in this server:
 - MegaRAID Service Monitor
 - MegaRAID Client

- Management PC:

Management PC that monitors and controls servers via the network (TCP/IP)

When managing array on Terminal Server working on Windows NT Server Version 4.0 Terminal Server Edition, prepare PC, and install Management PC component. Management PC does not guarantee operation on Client, which used Terminal Server, Terminal Server Emulator, WBT.

Start Power Console Plus of management PC, after powering on the machines where "Server" and "Management Server" are installed.

Install the following component in this PC:

- MegaRAID Client

- Management server:

Machine that manages all servers that are monitored and controlled by management PCs

Install the following components in one of the servers or management PCs:

- MegaRAID Server
- MegaRAID Registration Server

Server Setup

Operating Environment

This section explains the operating environment required for Power Console Plus to operate on a server.

- Hardware

- Memory:

Size large enough for operating system operation + 10 MB or more

- Free space of the hard disk:

10 MB or more

- Display unit:

Screen size 1024 × 768 or larger

- Required peripheral equipment:

Network Interface card

CD-ROM unit

Pointing device such as a mouse

Management PC Setup

This section explains Power Console Plus setup in a computer that manages servers via the network (TCP/IP).

Operating Environment

This section explains the operating environment required for Power Console Plus to operate on a management PC.

- Hardware
 - Machine:
 - Express5800 series
 - PC/AT-compatible machine (which contains Intel Pentium or a processor at least equivalent to it)
 - Memory:
 - Size large enough for operating system operation + 10 MB or more
 - Free space of the hard disk:
 - 10 MB or more
 - Display unit:
 - Screen size 1024 × 768 or larger
 - Required peripheral equipment:
 - Network Interface card
 - CD-ROM unit
 - Pointing device such as a mouse

BMC ONLINE UPDATE

The BMC firmware is updated with the BMC Firmware file.

IMPORTANT: Do not turn off the DC power during while updating the BMC Firmware.
The updated BMC firmware becomes valid after restarting the system.

Hardware Requirement

- Hard disk drive
2MB
- Supported operating systems:
Windows® 2000 Server
Windows® 2000 Advanced Server
Windows Server™ 2003 Standard Edition
Windows Server™ 2003 Enterprise Edition
Red Hat Linux Enterprise Linux ES 3
Red Hat Linux Enterprise Linux AS 3

Installation

Windows Server 2003 / Windows 2000

1. Insert the EXPRESSBUILDER CD-ROM into the CD-ROM drive.
Master Control Menu of EXPRESSBUILDER starts automatically.
2. Select [BMC Online Update].
BMC Online Update installer starts. Follow the installer instructions to install.

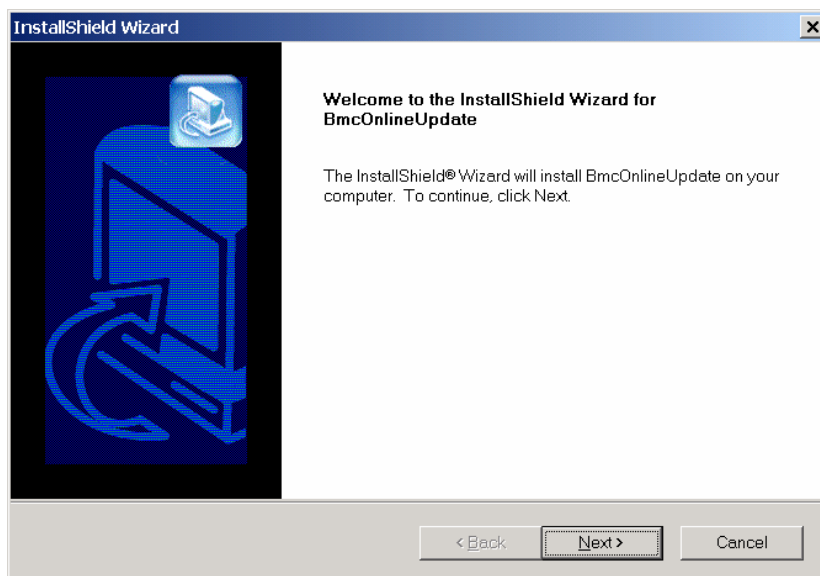

Linux

1. Copy the following file in the suitable directory from CD-ROM.

`cp /mnt/cdrom/BMCTOOL/OnlineUp/BmcOnlineUpdate.i386.`

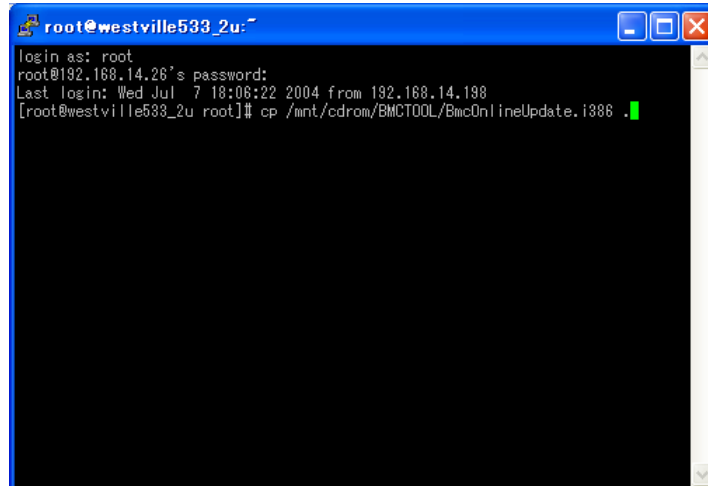

```
root@westville533_2u:~  
login as: root  
root@192.168.14.26's password:  
Last login: Wed Jul 7 18:08:22 2004 from 192.168.14.198  
[root@westville533_2u root]# cp /mnt/cdrom/BMCTOOL/BmcOnlineUpdate.i386 .
```

2. Expand the rpm file.

`rpm -ivh BmcOnlineUpdate.i386`

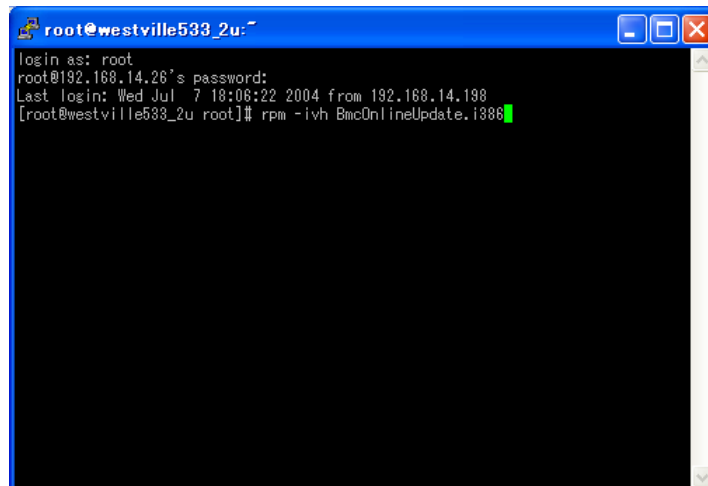

```
root@westville533_2u:~  
login as: root  
root@192.168.14.26's password:  
Last login: Wed Jul 7 18:08:22 2004 from 192.168.14.198  
[root@westville533_2u root]# rpm -ivh BmcOnlineUpdate.i386
```

Startup

Windows Server 2003

Select [All Programs] → [BmcOnlineUpdate] → [BmcOnlineUpdate].

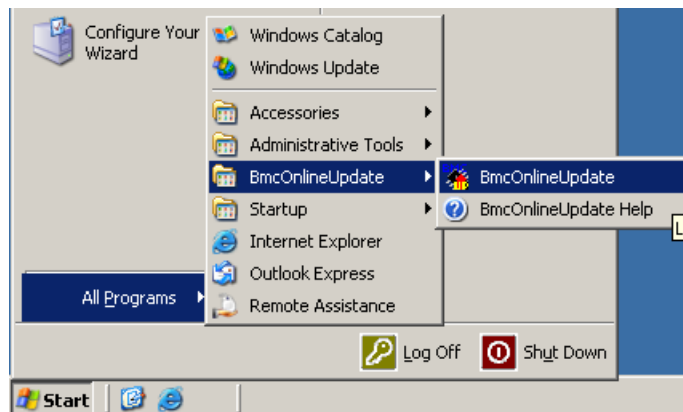

Windows 2000

Click [Programs] → [BmcOnlineUpdate] → [BmcOnlineUpdate].

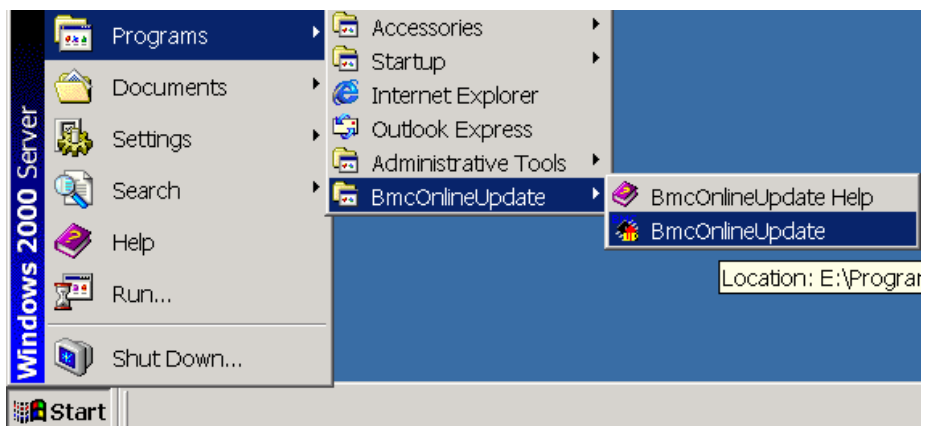

Linux

Enter the following command to start the program.

```
cd /usr/BmcOnlineUpdate
```

```
./BmcOnlineUpdate
```

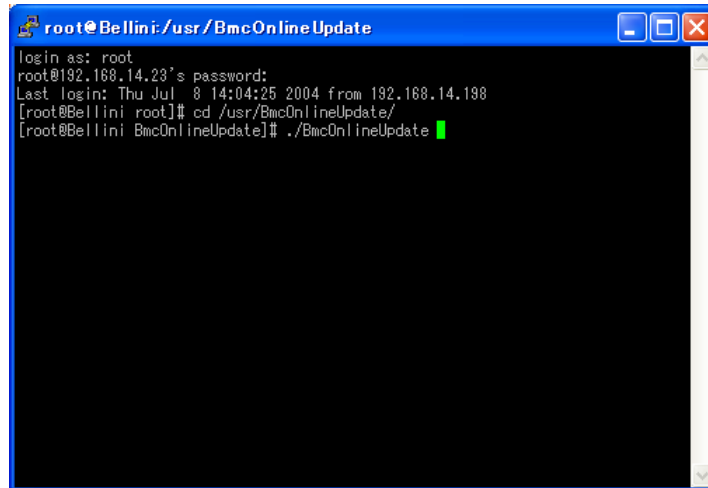

```
root@Bellini: /usr/BmcOnlineUpdate
login as: root
root@192.168.14.23's password:
Last login: Thu Jul  8 14:04:25 2004 from 192.168.14.198
[root@Bellini root]# cd /usr/BmcOnlineUpdate/
[root@Bellini BmcOnlineUpdate]# ./BmcOnlineUpdate █
```

Uninstallation

Windows Server 2003

1. Select [All Programs] → [Control Panel] → [Add or Remove Programs].

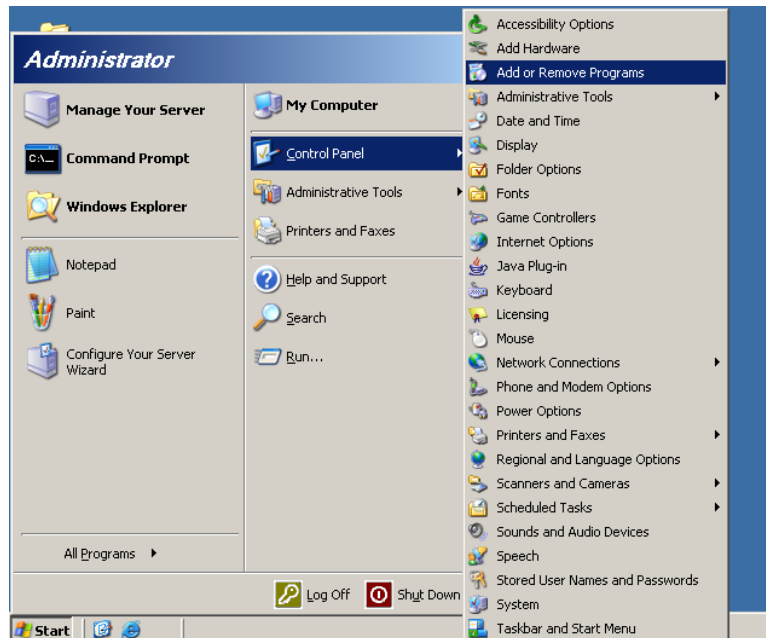

2. Click [BmcOnlineUpdate].

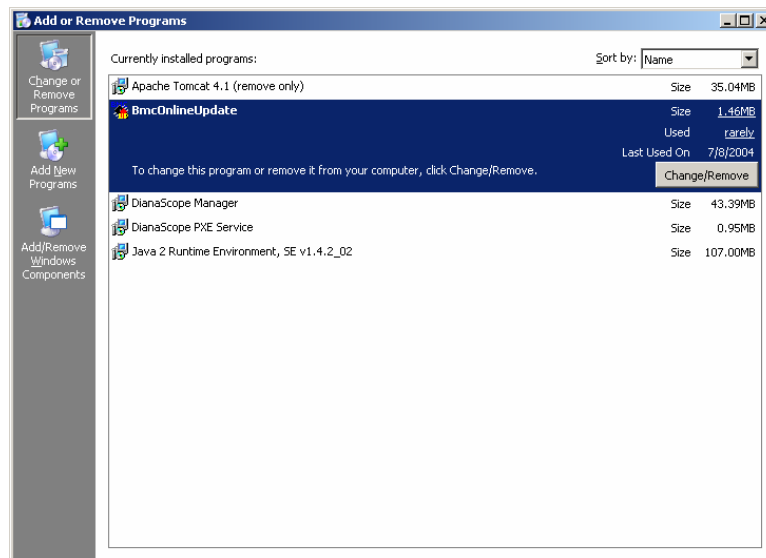

Windows 2000

1. Select [Setting] → [Control Panel] → [Add or Remove Programs].

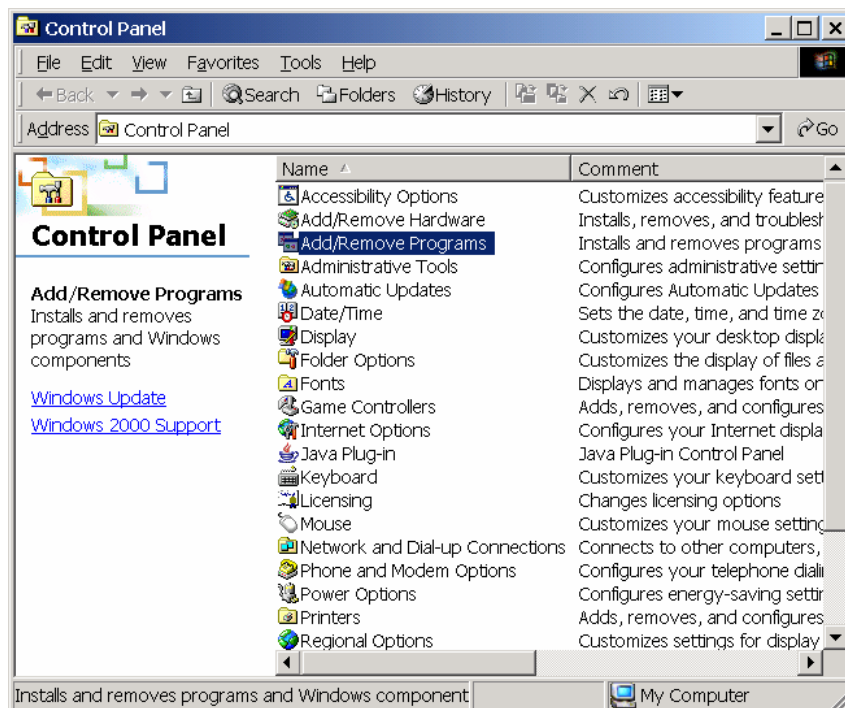
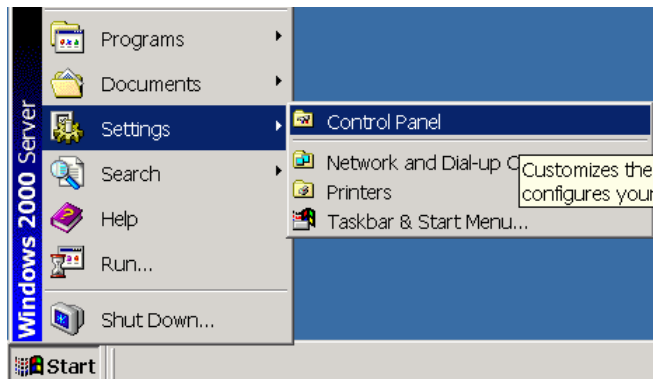

2. Click [BmcOnlineUpdate].

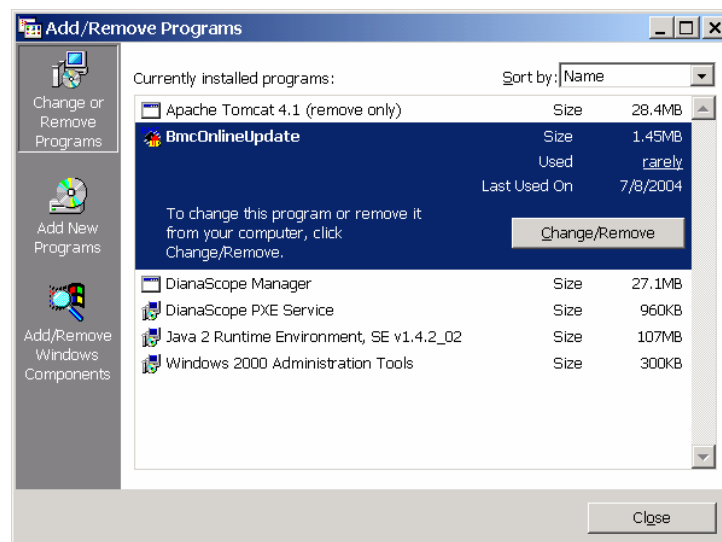

Chapter 7

Maintenance

This chapter describes the daily maintenance of the server and precautions when relocating or storing the server.

MAKING BACKUP COPIES

It is recommended that you make backup copies of your valuable data stored in hard disks of the server on a regular basis. For backup storage devices suitable for the server and backup tools, contact your service representative.

When you have changed the hardware configuration or BIOS configuration, select "System Information Management" and then "Save" of the Off-line Maintenance Utility to make a backup copy of the system information.

ALSO MAKE A BACKUP COPY OF THE DISK ARRAY CONFIGURATION DATA IF YOUR SYSTEM IS IN THE ARRAY CONFIGURATION. WHEN YOUR HARD DISKS HAVE BEEN AUTO-REBUILT DUE TO A FAILURE, IT IS RECOMMENDED TO MAKE A BACKUP COPY OF THE CONFIGURATION DATA. TO MAKE A BACKUP COPY OF THE CONFIGURATION DATA, USE THE CONFIGURATION UTILITY THAT IS RESIDENT IN THE FLASH MEMORY ON THE OPTIONAL DISK ARRAY CONTROLLER BOARD. REFER TO THE MANUAL SUPPLIED WITH THE BOARD.

Clean the server on a regular basis to keep the server in a good shape.

⚠ WARNING	
	<p>Observe the following instructions to use the server safely. Failure to follow these instructions may result in death or serious personal injury. See pages 1-3 to 1-8 for details.</p> <ul style="list-style-type: none">Do not disassemble, repair, or alter the server.Do not look into the CD-ROM drive.Do not remove the lithium battery.Disconnect the power plug before cleaning with the server.

⚠ CAUTION	
	<p>Observe the following instructions to use the server safely. Failure to follow these instructions may cause a fire, personal injury, or property damage. See pages 1-3 to 1-8 for details.</p> <ul style="list-style-type: none">High temperatureMake sure to complete board installation.

Cleaning the Server

For daily cleaning, wipe the external surfaces of the server with a dry soft cloth. Follow the procedure below if stains remain on the surfaces:

IMPORTANT:

- To avoid altering the material and colour of the server, do not use volatile solvents such as thinner and benzene to clean the server.
- The power receptacle, the cables, the connectors on the rear panel of server, and the inside of the server must be kept dry. Do not moisten them with water.

1. Make sure that the server is off-powered (the POWER/SLEEP lamp goes off).
2. Unplug the power cord of the server from the power outlet.
3. Wipe off dust from the power cord plug with a dry cloth.
4. Soak a soft cloth in neutral detergent that is diluted with cold or lukewarm water, and squeeze it firmly.
5. Rub off stains on the server with the cloth prepared in Step 4.
6. Soak a soft cloth in water, squeeze it firmly, and wipe the server with it once again.
7. Wipe the server with a dry cloth.
8. Wipe off dust from the fan exhaust opening on the rear of the server with a dry cloth.

Cleaning the Interior



One of the most important items in a good maintenance program is regular and thorough cleaning of the interior of the server, especially around the I/O board.

Dust build-up inside the server can lead to several problems. As dust acts as a thermal insulator, a build-up can prevent proper system cooling. Excessive heat will shorten the life of server components. Also, dust may contain conductive or corrosive materials that can cause short circuits or corrosion of electrical contacts.

How often you should clean the interior of the server depends on the environment in which it is located. For most office environments, you probably should clean the server every 12 months. For more severe environments, clean the interior every 6 months.

Cleaning the interior of the server entails powering off the server and removing the left side cover. You will need a small vacuum cleaner (with plastic tipped nozzle and electrostatic protection), computer grade canned air, and a small brush for cleaning the interior.

Follow the procedure below to clean the interior of the server.

 WARNING	
 	<p>Unplug all power cords.</p> <p>Unplug all power cords before performing any maintenance. Voltage is present inside the server and display unit even after the power is turned off. All voltage is removed only when the power cord is unplugged.</p>

1. Turn off the server and unplug all power cables.
2. Remove the top cover. (See Chapter 9.)
3. Use a small brush to loosen any dust and debris on the I/O board.
4. Use computer grade canned air to blow dust off components on the I/O board.

5. Use a small vacuum cleaner with plastic tip to vacuum out dust and debris from the interior of the server.
6. Reinstall the top cover. (See Chapter 9.)
7. Reconnect all power cables and turn on the server.

Cleaning the Keyboard and Mouse

Make sure that the server and peripheral devices are all off-powered (the POWER lamp goes off), and then wipe the keyboard surface with a dry cloth.

The mouse operation depends on the degree of smoothness of the internal ball rotation. To keep the mouse ball clean, use the mouse in a place with little dust. Follow the steps below to clean the mouse regularly:

1. Prepare cold or lukewarm water, neutral detergent, alcohol, two dry soft clothes, and cotton swabs.
2. Make sure that the server is off-powered (the POWER/SLEEP lamp goes off).
3. Turn the mouse upside down, and rotate the mouse ball cover counter clockwise to remove it.
4. Take out the ball from the mouse. Cover the bottom of the mouse with your hand, and turn your hand holding the mouse (the mouse is on your palm with the button upward). The mouse ball is released onto your palm.

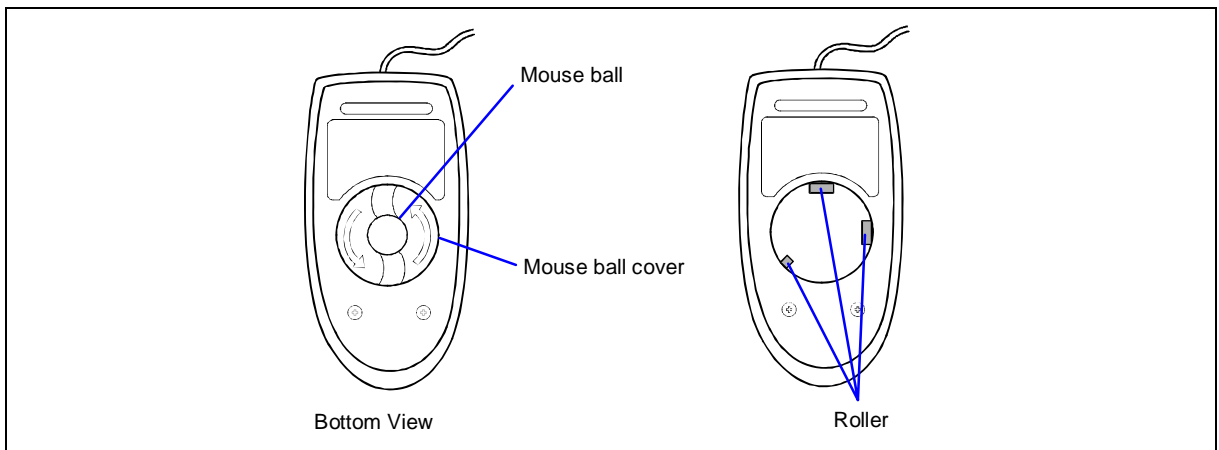

5. Soak a soft cloth in neutral detergent that is diluted with cold or lukewarm water, and squeeze it firmly.
6. Rub off stains on the mouse ball. Softly wipe the mouse ball with the cloth prepared in Step 5.
7. Wipe the mouse ball with a dry soft cloth.
8. Wipe three small rollers inside the mouse with a cotton swab soaked with alcohol. Wipe stains slowly and carefully by rotating rollers with the tip of the cotton swab.
9. Blow out any dust from the mouse. Protect your eyes from the dust.
10. Put the mouse ball back into the mouse.
11. Place the mouse ball cover, and rotate it clockwise until it is locked.

Cleaning CD-ROM

A dusty CD-ROM or dust-accumulated tray causes the device to fail to read data correctly.

Follow the procedure below to clean the tray and CD-ROM regularly:

1. Make sure that the server is powered (the POWER/SLEEP lamp is lit).
2. Press the Open/Close button on the front of the CD-ROM drive.
The tray comes out.
3. Hold the CD-ROM lightly and take it out from the tray.

NOTE: Do not touch the signal side of the CD-ROM with your hand.

4. Wipe the tray with a dry soft cloth.

IMPORTANT: Do not wipe the lens of the CD-ROM drive. Doing so may damage the lens and may cause a malfunction of the drive.

5. Press the Open/Close button or gently push on the tray front to close the tray.
6. Wipe the signal side of the CD-ROM with a dry soft cloth.

IMPORTANT: Wipe CD-ROMs from the centre to the outside. Use CD-ROM cleaner only if necessary. Cleaning a CD-ROM with record spray/cleaner, benzene, or thinner causes damage to the CD-ROM contents. At worst, inserting the CD-ROM into the server may cause failure.

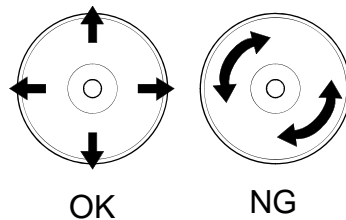

SYSTEM DIAGNOSTICS

The System Diagnostics runs several tests on the server.

Use the System Diagnostics program in EXPRESSBUILDER provided with the server to diagnose the server.

Test Items

The following items are tested in system diagnostics.

- Memory
- Processor cache memory
- Hard disk used as a system

IMPORTANT: When running the System Diagnostics, make sure to remove the LAN cable. When running the System Diagnostics with the LAN cable connected, the network may be influenced.

NOTE: On checking the hard disk, no data is written into the disk.

Starting and Ending the System Diagnostics

There are two ways to diagnose the server: using the local console (keyboard) of the server itself, and using the management PC via serial port (remote console).

IMPORTANT: Two methods (LAN and serial port) are mentioned in the Chapter 6 "EXPRESSBUILDER" as the way of communicating in remote console. Use the serial port to run System Diagnostics with remote console. The LAN connection is not for System Diagnostics.

Start the diagnostics program as follows:

1. Shutdown the operating system, and turn off the server. Then, unplug the power cord.
2. Disconnect all the LAN cables from the server.
3. Plug the power cord and turn on the server.
4. Use the EXPRESSBUILDER CD-ROM to reboot the server.

See Chapter 6 "EXPRESSBUILDER" for details.

The following menu appears when starting the server using the EXPRESSBUILDER.



Local console

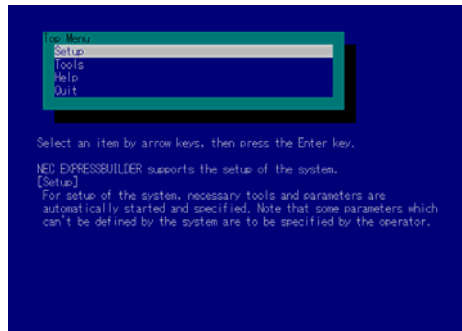

Remote console

5. Select [Tools].
6. Select [System Diagnostics].

The System Diagnostics starts and completes in approximately three minutes.

When the diagnosis completes, the display changes as shown in the figure below.

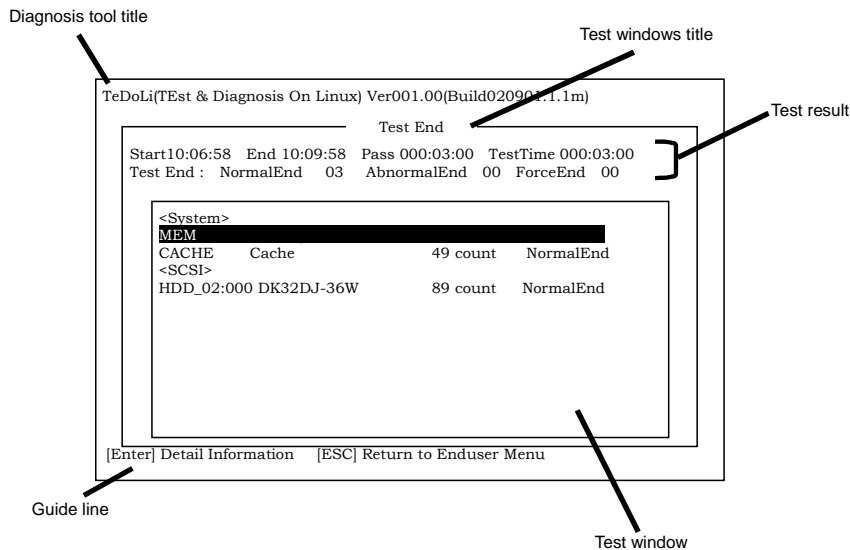

Diagnosis tool title: shows a name of this diagnosis and version information.

Test windows title: shows the progress of diagnosis. When it completes, it shows "Test End"

Test Result: shows the information including time of start, end and progress, and result of the diagnosis.

Guide line: shows a description of keys to navigate the window.

Test window: Move the cursor and press **Enter** to view the detail of the diagnosis.

If an error is detected during the System Diagnostics, the test result shows "Abnormal End" in red colour. Move the cursor and press **Enter** on the diagnosis where the error occurred. Take a note of the error message showed, and contact your service representative.

7. Follow the Guide line shown at the bottom of the screen and press **ESC** to show the End user Menu shown below.

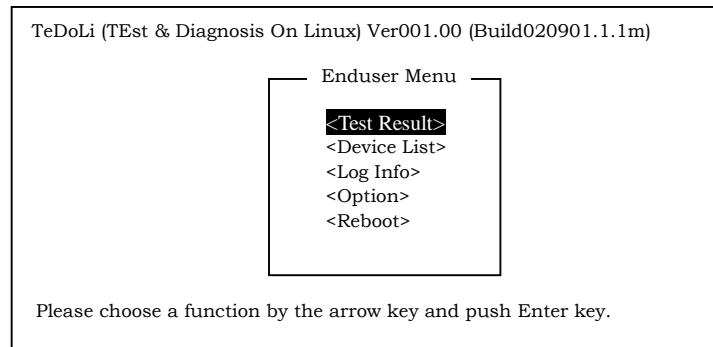

- <Test Result> shows the diagnosis completed screen aforementioned.
- <Device List> shows the information of all the devices connected.
- <Log Info> shows the log information and error messages of the diagnosis. It can be saved to a floppy disk. To save the log information to a floppy disk, insert a formatted floppy disk in a floppy disk drive and select <Save[F]>.
- <Option> change where to output log
- <Reboot> Restarts the Express Server.

8. Select <Reboot> in the End user Menu above.
The Express Server restarts and EXPRESSBUILDER boot the system.
9. Exit EXPRESSBUILDER, and remove the CD-ROM from the CD-ROM drive.
10. Turn off the server and unplug the power cord from the receptacle.
11. Reconnect all the LAN cables to the server.
12. Plug the power code.

This completes the System Diagnostics.

RELOCATING/STORING THE SERVER

Follow the procedure below to relocate or store the server:

⚠ CAUTION	
	<p>Observe the following instructions to use the server safely. Failure to follow these instructions may cause a fire, personal injury, or property damage. See pages 1-3 to 1-8 for details.</p> <p>Never attempt to lift the server only by yourself. Do not install the server in any place other than specified. Do not connect/disconnect any interface cable with the power cord of the server plugged to a power source.</p>

IMPORTANT:

- If the server needs to be relocated or stored due to a change in the floor layout to a great extent, contact your service representative.
 - Make sure to make a backup copy of your valuable data in the hard disk, if any.
 - Make sure not to apply a shock to hard disks when relocating the server if it contains any.
 - It is recommended that the server and the internal devices should be stored in a place where the room temperature can be maintained. It is important for the server or internal devices to work normally after storage. Store the device in a place where temperature ranges between -10 to 55°C and humidity ranges between 20 to 80% without dew condensation.
 - If you use the server after transported or relocated, check the system timer and adjust it if necessary. If the system timer advances or delays remarkably with the passage of time, contact your service representative to repair it. The server or internal option device may be dewed if it is brought to a warm place from a cold place suddenly. Using a server or an internal device with dew attached may cause malfunction or failure. Make sure to adapt them to the operating environment before using them.
-
1. Take floppy disk and CD-ROM out of the server, if any.
 2. Power off the server (the POWER lamp goes off).
 3. Unplug the power cord of the server from a power outlet.
 4. Remove all the cables from the server.
 5. Hold the server by its bottom with at least four persons to carry the server.
 6. Protect the server with the shock-absorbing materials, and pack it securely.

Chapter 8

Troubleshooting

If your server does not operate as expected, read this chapter before assuming a failure.

NOTE: For provision against an unexpected failure, it is recommended to install the Off-line Maintenance Utility, ESMPRO, on the server and client computers.

SYSTEM VIEWERS

Monitor the occurrence of fault by ESMPRO during system operation.

Especially take note on whether any alert is reported to ESMPRO Manager on the language PC. Check whether any alert is reported on the Operation Window, Data Viewer, or Alert Viewer of ESMPRO Manager.

[Example]

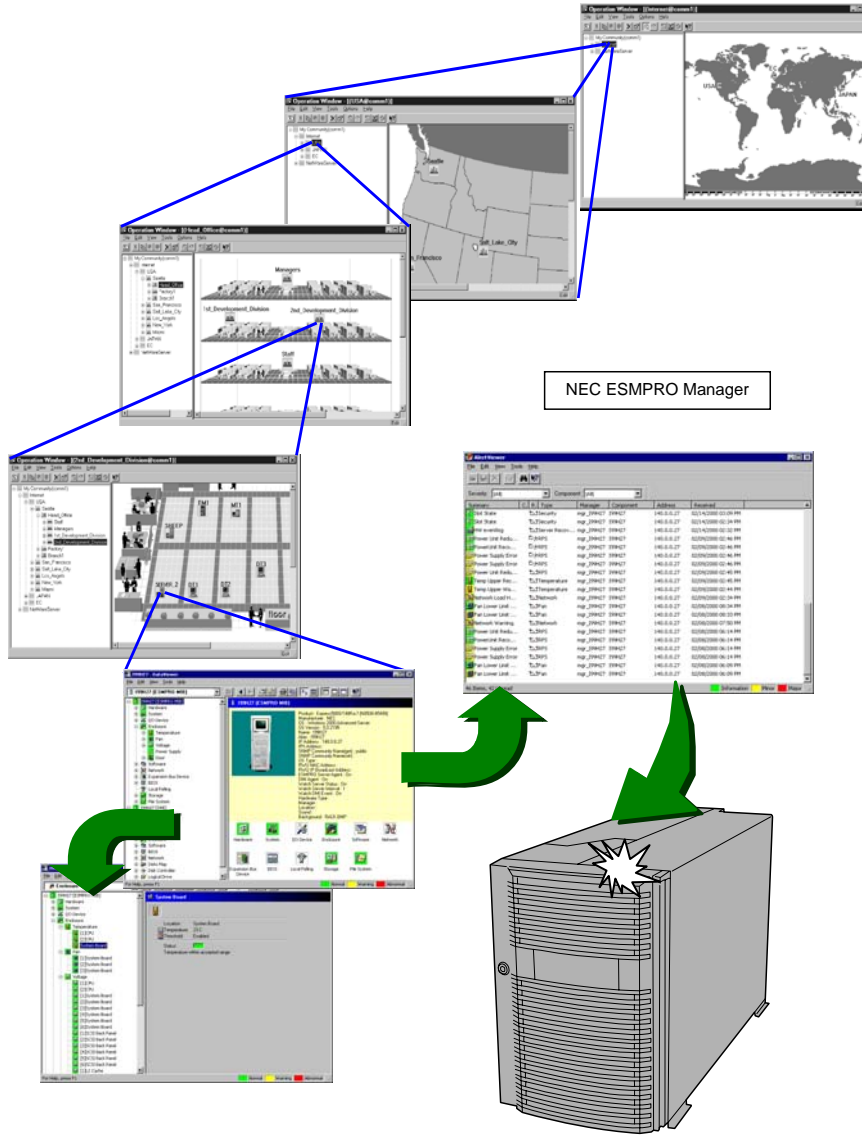

LAMPS

The following describes lamps on the server and their indications.

POWER/SLEEP Lamp

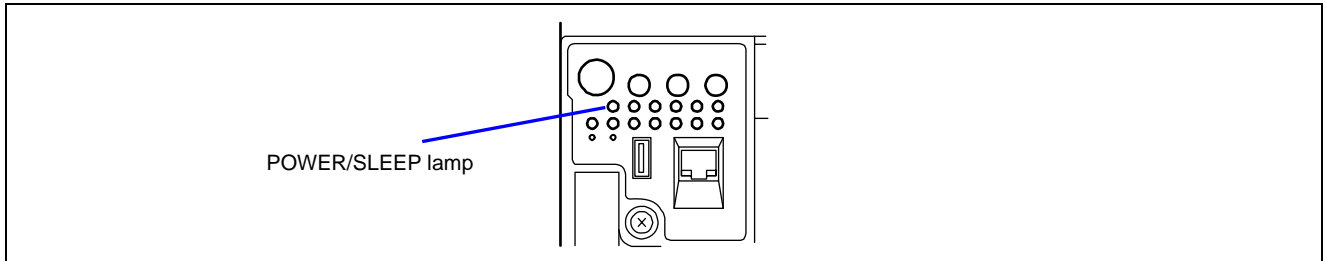

The green POWER/SLEEP lamp lights to indicate normal operation while the server is powered. When the server is off-powered, the POWER/SLEEP lamp stays unlit.

The POWER/SLEEP lamp indicates that the server is running in the power-saving mode (sleep mode). If the operating system supports the power-saving mode such as Windows 2000, pressing the SLEEP switch blinks the POWER/SLEEP lamp in green and places the server in the power-saving mode. Press the POWER switch to turn out the POWER/SLEEP lamp and place the server back in the normal mode.

The power-saving mode is only available when the operating system supports the power-saving feature. Some operating systems allow you to set the server to automatically turn in the power-saving mode when no access is made to the server for a certain period of time or to select the power-saving mode with a command.

STATUS Lamp

The STATUS lamp stays lit green when the server is in successful operation. When the STATUS lamp is unlit, flashing green or lit/flashing amber, it indicates that the server has failed.

The following table lists indications of the STATUS lamp, descriptions, and actions to take.

NOTES:

- If the server has ESM (Event System Monitor) or Off-line Maintenance Utility installed, you can view the System Event Log (SEL) to identify the cause of a trouble.
- To cycle power to the server, shut down the server from the operating system and reboot it, if available. If the shutdown from the operating system is not available, reset or execute the forced shut down or disconnect and connect the power cord to reboot the server.

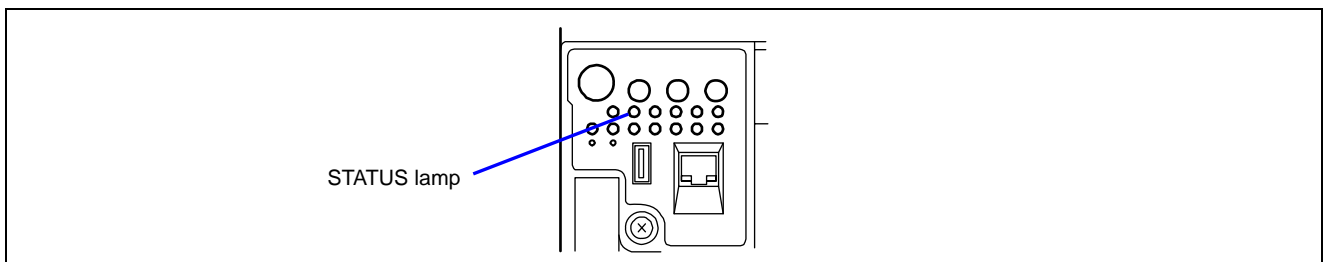

STATUS lamp indication	Description	Action
Flashing green	The server is in operation with its processor degraded.	Contact your service representative. Start the BIOS SETUP and select [Main] - [Processor Settings] to identify the degraded processor and replace it as soon as possible. Or, start the BIOS SETUP and select [Main] - [Processor Settings] - [Processor Retest] - [Yes], and then select [Exit] - [Exit Saving Changes] to solve the problem.
	The server is in operation with its memory degraded.	Contact your service representative. Start the BIOS SETUP and select [Advanced] - [Memory Configuration] to identify the degraded memory (DIMM) and replace it as soon as possible. Or, start the BIOS SETUP and select [Advanced] - [Memory Configuration] - [Memory Retest] - [Yes], and then select [Exit] - [Exit Saving Changes] to solve the problem.
	A correctable memory or bus error was detected.	The system can continue operation if the status lamp flashes green. However, consult with your service representative.
Unlit	The server is powered off.	Power on the server.
	POST is in progress.	Wait for a while. The STATUS lamp will light in a few seconds after POST completion.
	A processor error occurred (IERR).	Cycle power to the server. If POST displays an error message, take a note on the message and contact your service representative.
	A processor thermal error was detected. (Thermal-Trip)	
	A watchdog timer has timed out.	
	A PCI system error occurred.	
	A PCI parity error occurred.	
	An uncorrectable memory error was detected.	
	An uncorrectable bus error was detected.	
	POST terminates with error.	
Memory dumping is requested.	Wait until memory dumping completes.	
Lit amber	A thermal error (critical) was detected.	Check internal fans for dust or debris. Also make sure that the fans are firmly connected. If this error indication persists, contact your service representative.
	A voltage error (critical) was detected.	Contact your service representative.
	A power supply(ies) failed to operate.	Contact your service representative.
Flashing amber	A power alarm was detected in a power supply unit.	Identify the failed power supply unit and contact your service representative.
	A fan alarm was detected.	Make sure that the fan units are firmly connected. If this error indication persists, contact your service representative.
	A thermal error (warning) was detected.	Check internal fans for dust or debris. Also make sure that the fan units are firmly connected. If this error indication persists, contact your service representative.
	A voltage error (warning) was detected.	Contact your service representative.

DISK ACCESS Lamp

The DISK ACCESS lamp indicates the state of hard disks in the 3.5-inch disk bay.

This lamp lights green every time any of such hard disk is accessed.

When the DISK ACCESS lamp is lit amber, it indicates that a hard disk error occurred. To identify a failed hard disk, see the lamps provided for each hard disk.

When the DISK ACCESS lamp flashes green or amber alternately, the hard disk drive connected to an internal disk array controller is under rebuilding.

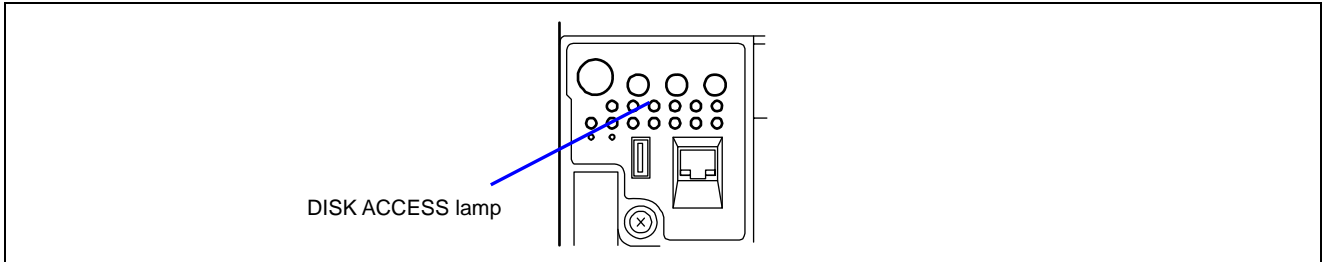

LAN1/LAN2 ACCESS Lamp

The LAN1/LAN2 ACCESS lamp is lit green when the server is connected to LAN. The lamp blinks while the server is accessed through the LAN (for packet transmission). The value next to the icon indicates the number of the network port on the rear panel.

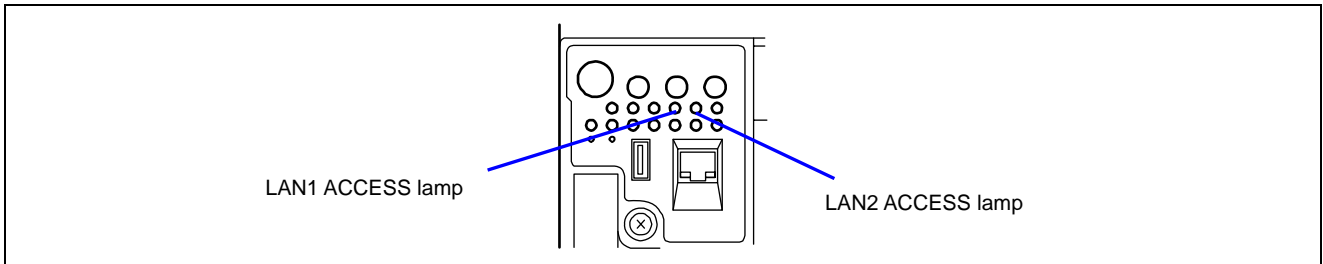

UID Lamp

The UID is located on the front and rear panel of the server. Pressing the UID switch on the front panel turns UID lamp blue, and allows you to locate the server you are working on. Use this switch when several servers are installed in the system.

Pressing the UID switch again turns off the UID lamp.

You can make ESMPRO Manager, DianaScope, or the remote management feature of Web server to flash the UID lamp. When you finished working, turn off the UID lamp.

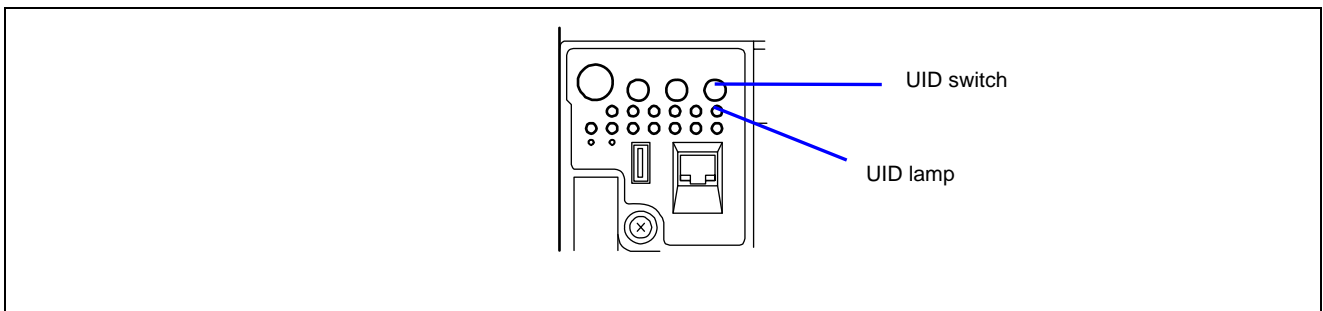

Attention Lamp

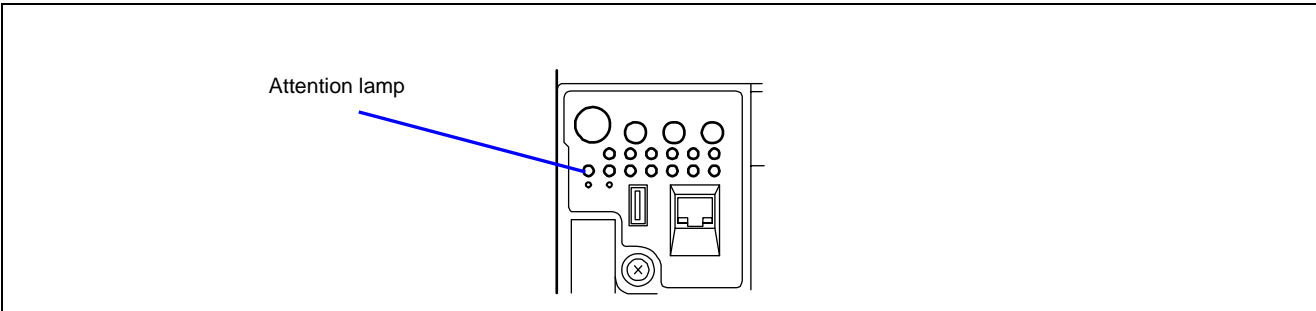

The Attention lamp lights amber when location where an error occurred cannot be identified automatically or errors occurred in two or more locations. Check the error log to identify the location.

Processor Board Error Lamp

Two processor board error lamps are located at the front and the rear of the server. These lamps light amber when an error occurs on the processor board. If the lamp lights, check the lamp indication on processor/VRM error lamp in front of the processor board. The lamp being lit amber indicates that the relevant processor or VRM fails.

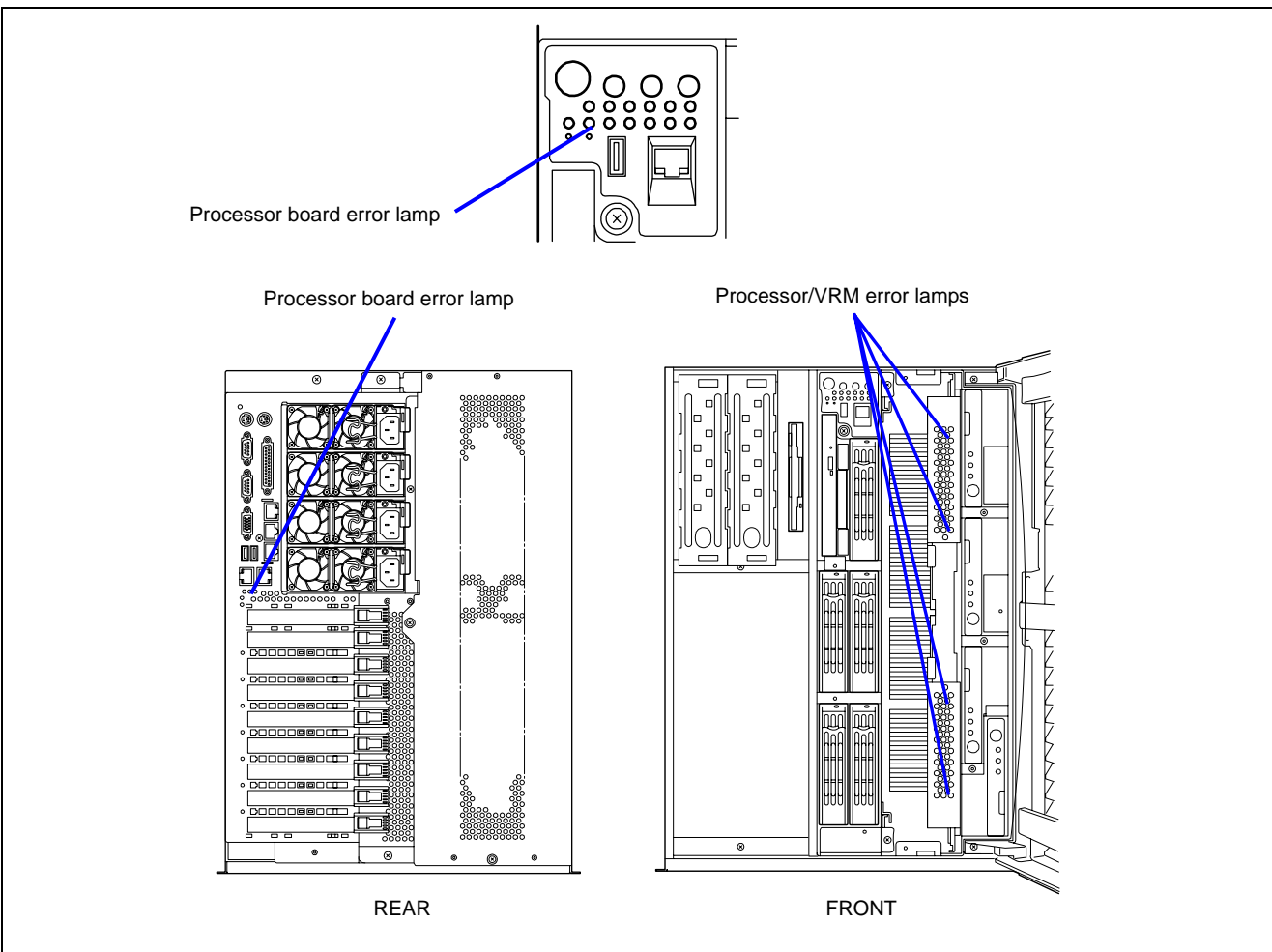

Memory Board Error Lamp

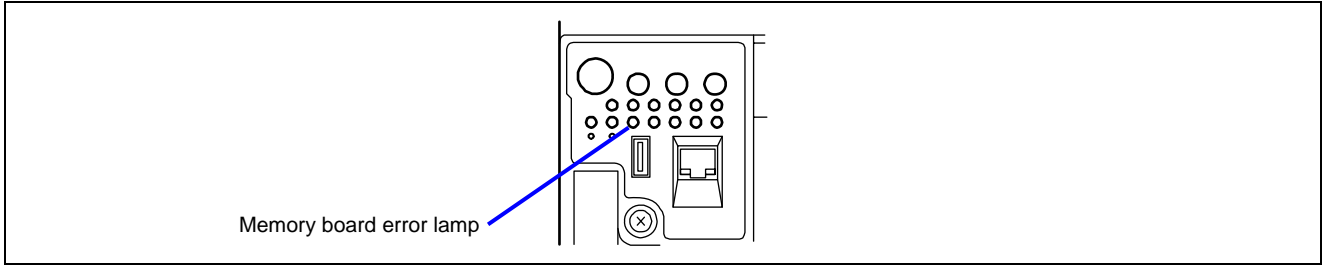

The memory board error lamp lights amber if an error occurs on memory board or on DIMM installed in memory board. Check the memory board Attention lamp being lit amber to identify the failed memory board. In addition, when you press the switch for DIMM slot error lamp on the failed memory board, the DIMM slot error lamp lights amber. Then, you can identify the slot containing the failed DIMM.

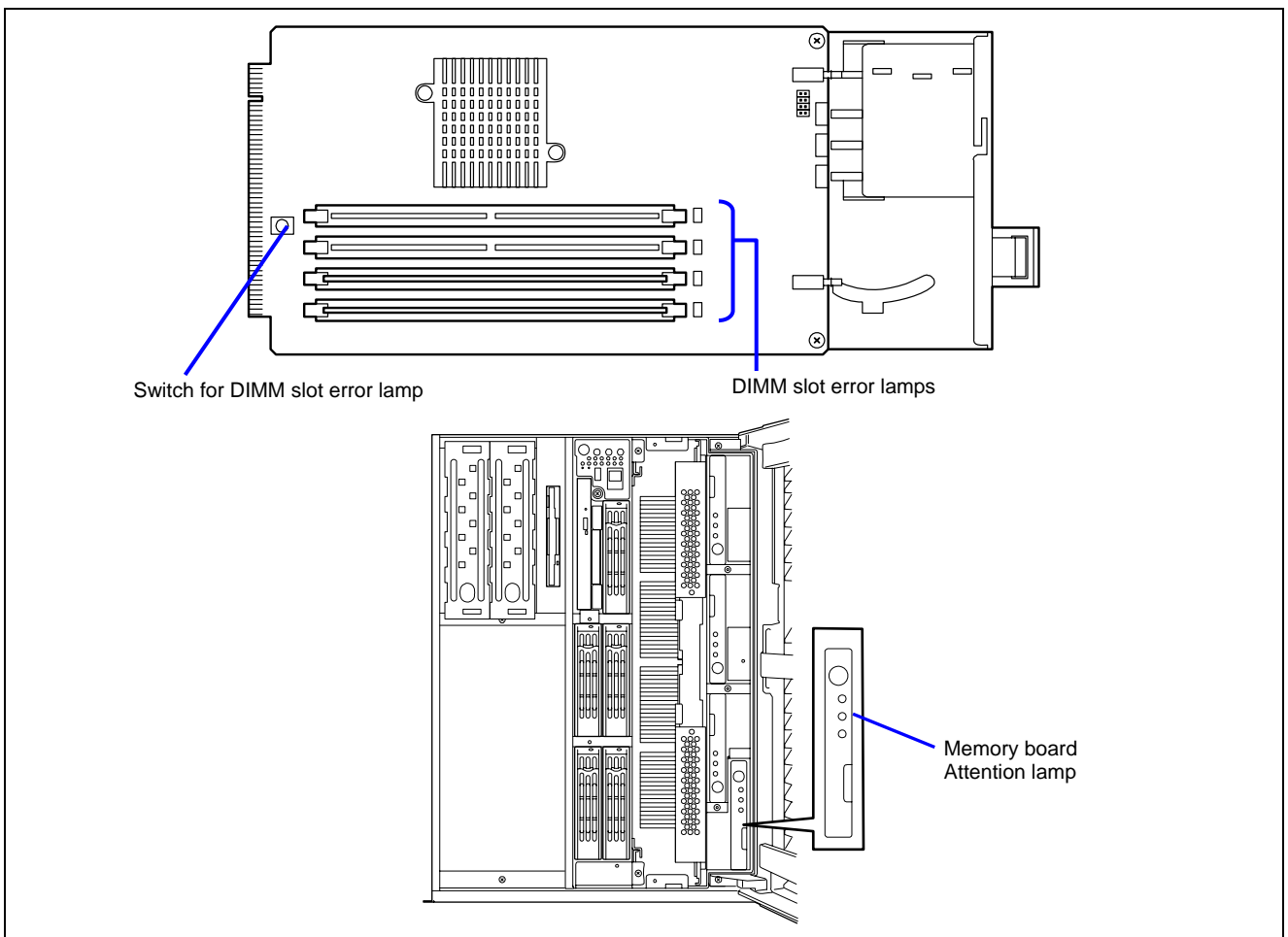

I/O Board Error Lamp

The front I/O board error lamp lights amber when an error occurs on I/O board or PCI board installed in your server. Check the lamp indication on the rear of the server.

When the rear I/O board lamp lights amber, the I/O board may be failed. When any of the PCI slot error lamps below the PCI slots light amber, the relevant PCI board or I/O board slot itself may be failed.

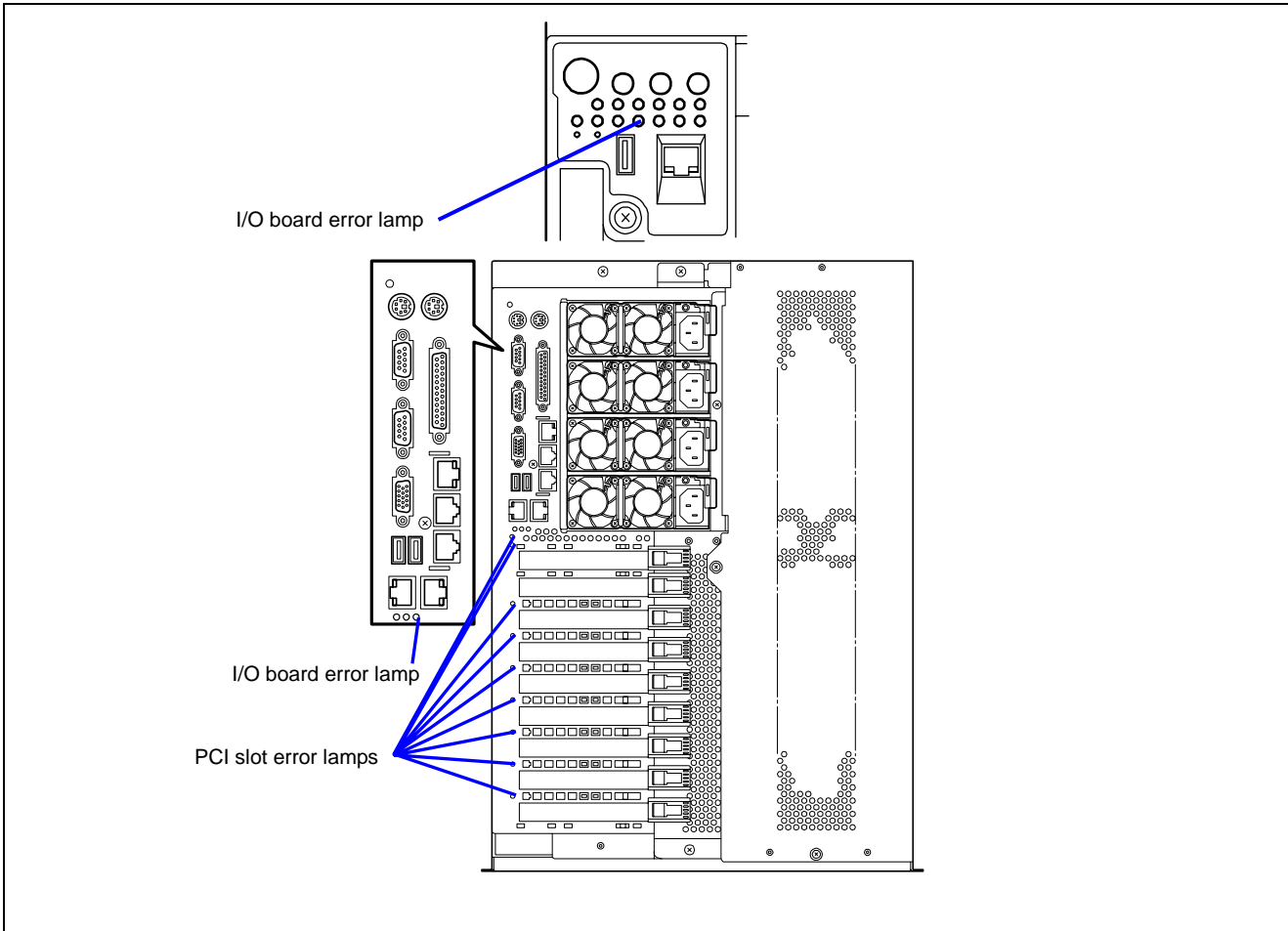

Power Unit Error Lamp

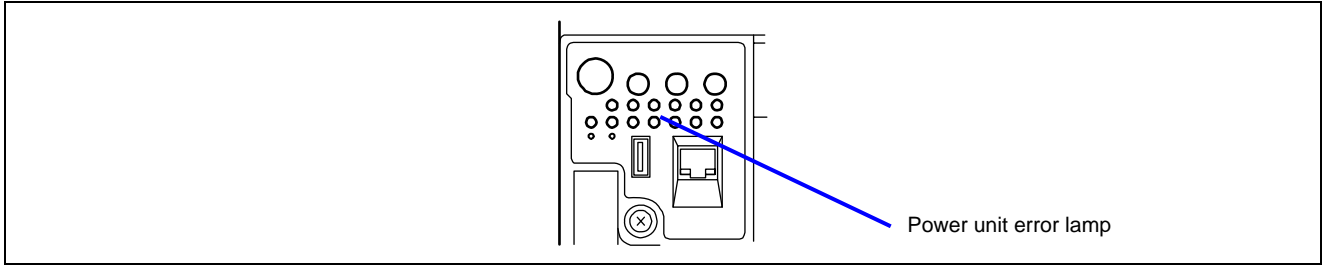

The Power unit error lamp lights amber when an error occurs on the power supply unit. Check the power unit error lamp to identify the failed power supply unit.

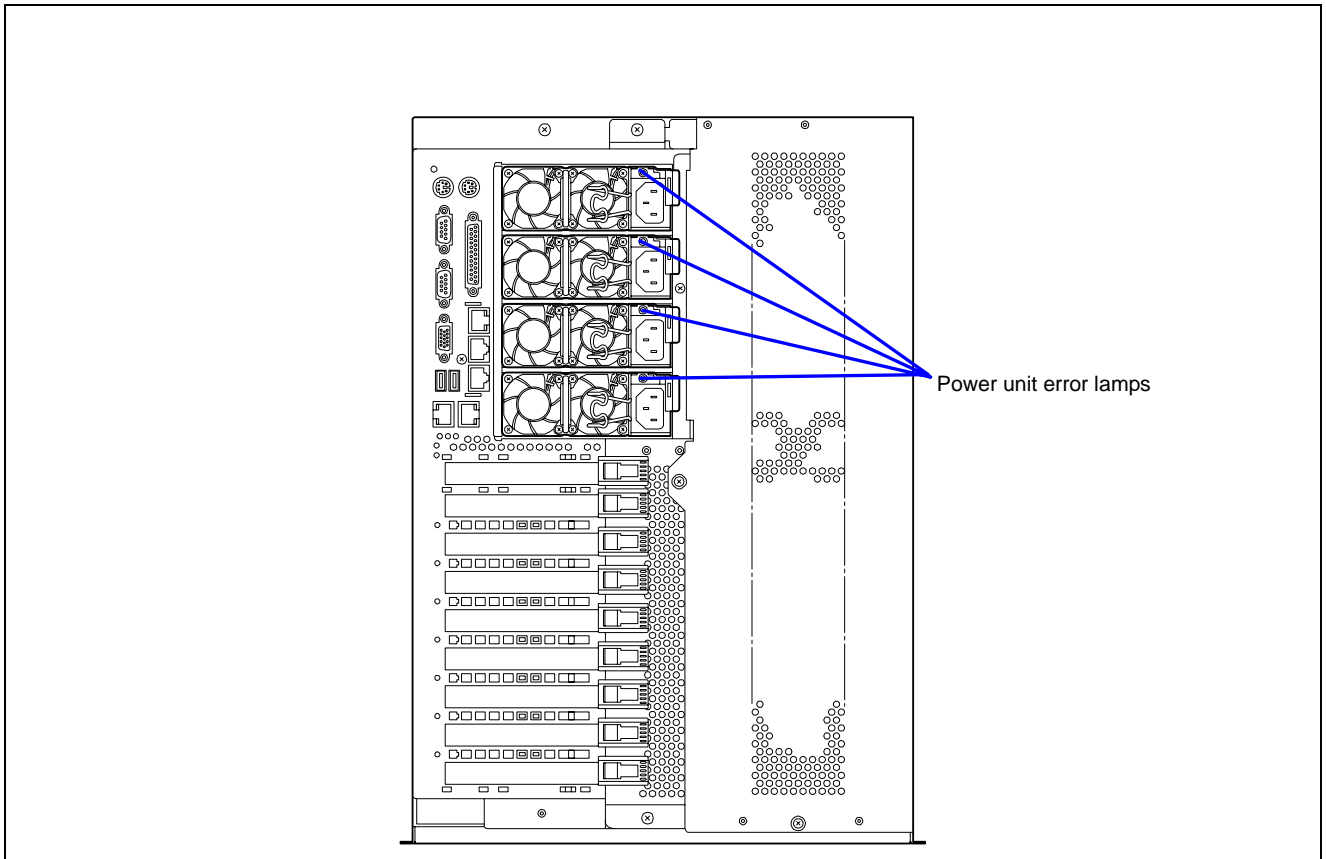

Fan Error Lamp

The fan error lamp lights amber when an error occurs on the fan. Check the Fan Fault lamp being lit red to identify the failed fan (see "FAN Fault Lamps" described later).

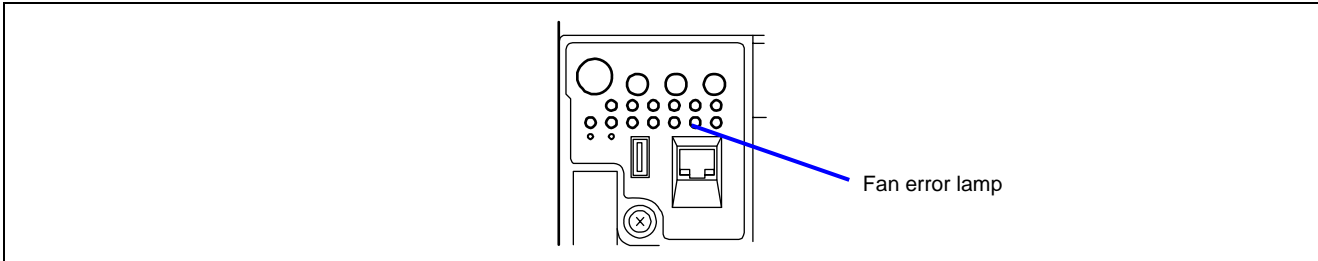

Thermal Error Lamp

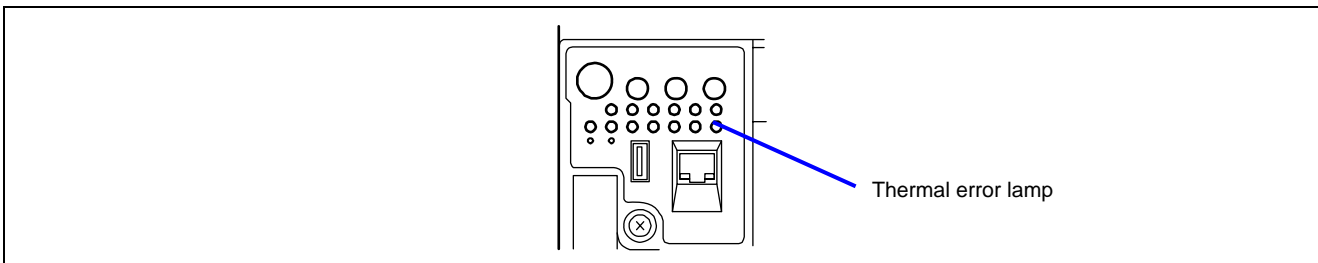

The thermal error lamp lights amber when an abnormal temperature in the server is detected. Check the room temperature where the server is installed.

Access Lamps

The access lamps for the floppy disk drive and the CD-ROM drive light when access is made to a media in the drive.

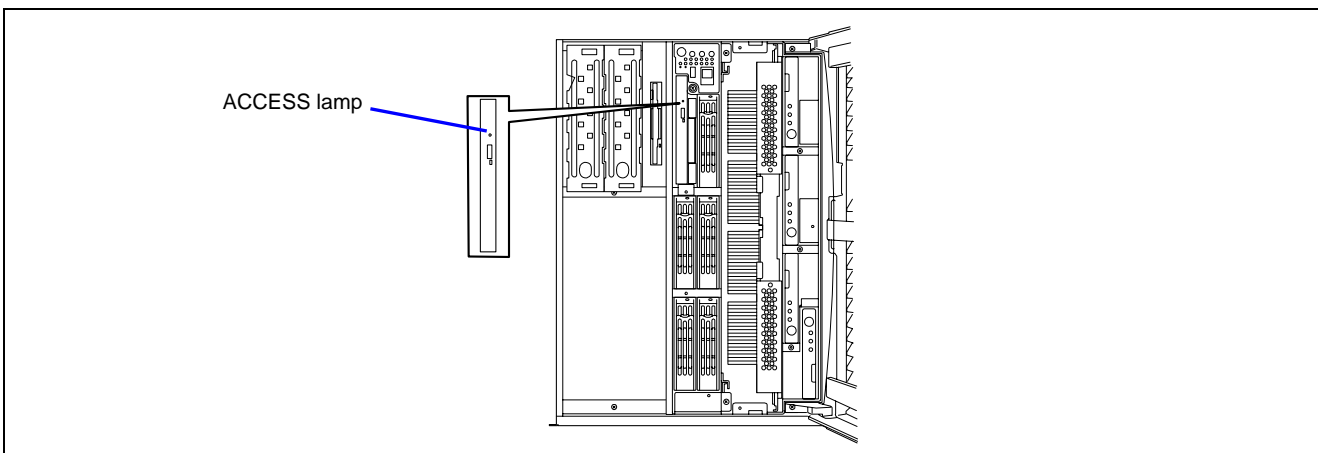

Memory Board Lamps

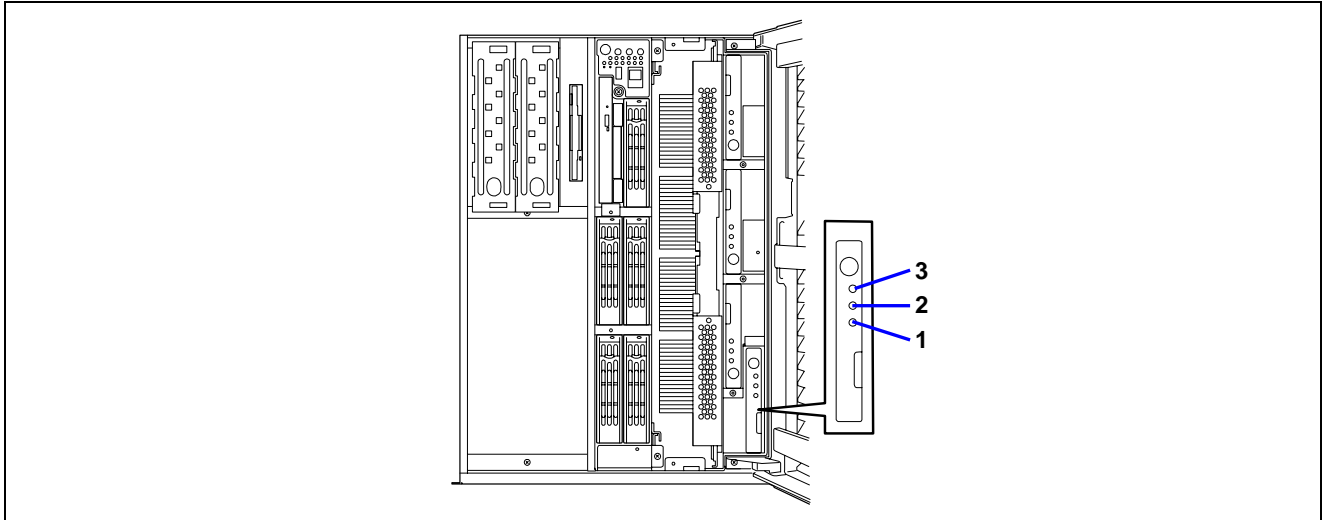

- 1 Memory board POWER lamp**
Lights green during power-on. Flashes green during rebuilding (e.g., memory board is hot-added).
- 2 Memory board Attention lamp**
Lights amber when an error occurred on memory board or DIMM.
- 3 Memory board Redundancy lamp**
Lights green in memory mirroring or memory RAID configuration.

Hard Disk Drive Lamp (DISK Lamp)

The disk lamp on the 3.5-inch disk bay has different meanings depending on the display status.

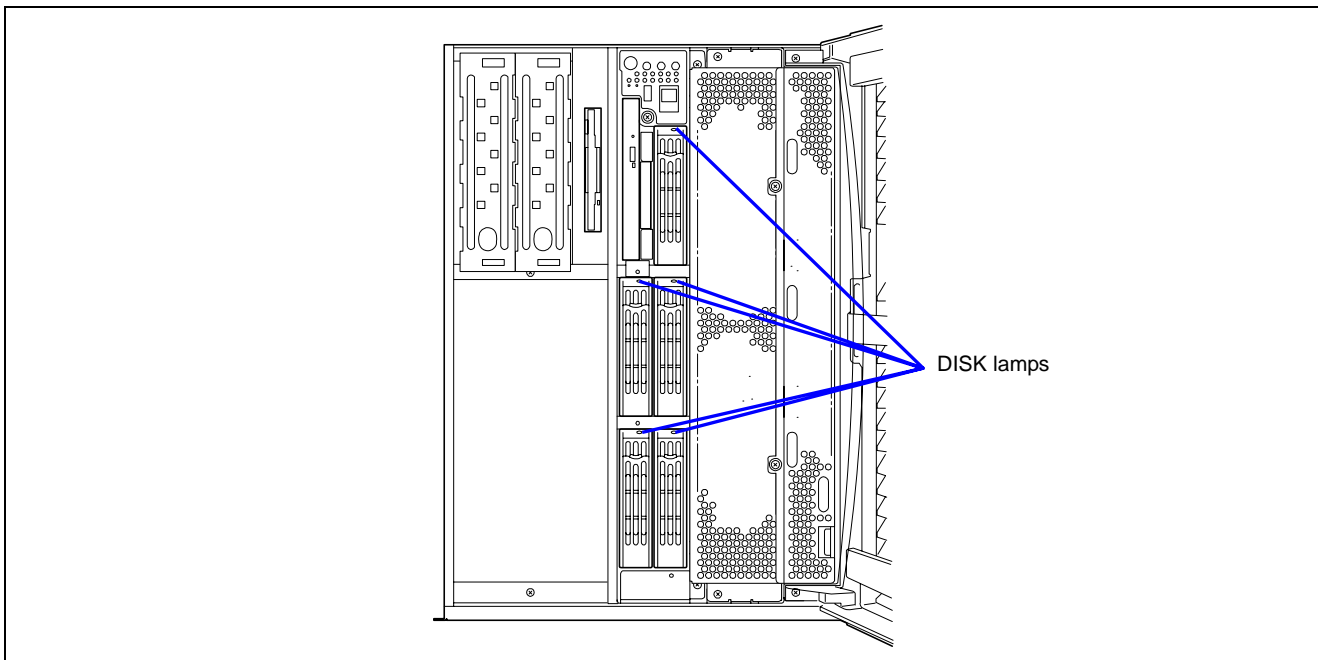

- Lit green

The hard disk is installed and powered on.

- Blinking green

Indicates that the hard disk is accessed.

- Lit amber

Indicates that the installed hard disk is defected in the disk array configuration.

NOTE: While hard disks are in the disk array configuration (RAID1/RAID5 or RAID0+1), a single failed hard disk does not affect the operation of the server. However, it is recommended to replace the failed hard disk and auto-rebuild (reconfigure) the hard disks as soon as possible. (You can hot-swap such a failed hard disk.)

- Alternate lighting green or amber

Indicates that the hard disk is being rebuilt (this status is not a failure). If the defected hard disk is replaced with a new one in the disk array configuration, the data is automatically rebuilt (auto rebuild function). During the rebuild operation, the lamp is lit green or amber alternatively.

The lamp goes off when the rebuild is terminated normally. The lamp goes on amber if the rebuild fails.

IMPORTANT: To abort rebuilding, power off the server. In such a case, restart the server, hot-swap the failed hard disk, and restart rebuilding. Observe the following notes to use the auto-rebuild feature.

- Do not power off the server. (If the server is powered off before rebuilding hard disks, the auto-rebuild feature will not start.)
 - When you removed a hard disk, wait at least 90 seconds before installing the hard disk back again.
 - Do not replace another hard disk while rebuilding is in progress.
-

LAN Connector Lamps

LAN1 and LAN2 connectors on the rear panel have two lamps as follows.

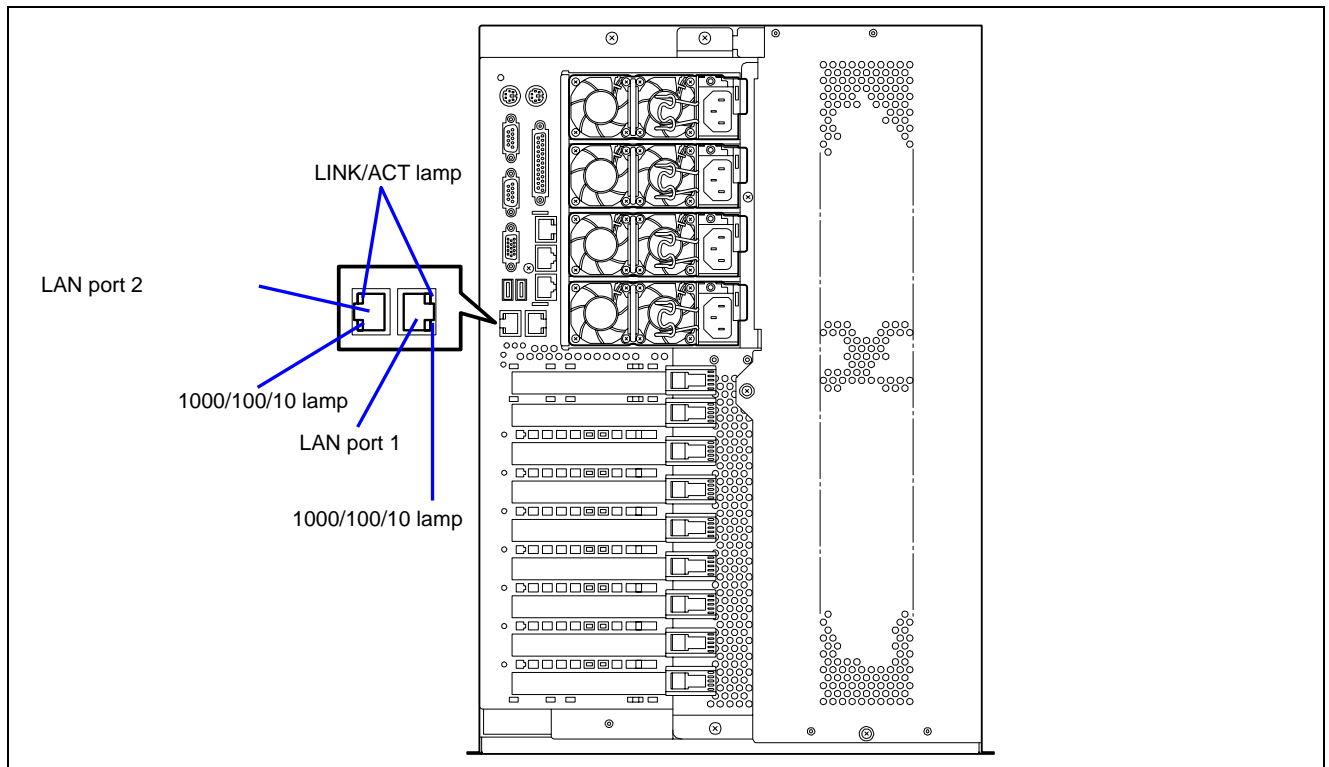

- LINK/ACT lamp

The link/ACT lamp indicates the state of each network port normally equipped with the server. If the power is supplied to the server and the hub and they are correctly connected with each other, the lamp is lit green (LINK state). If information is transmitted through a network port, the lamp blinks green (ACT state).

If the lamp is not lit in the LINK state, check the network cable and the cable connection. If the lamp is not lit still after the checking, the network (LAN) controller may be defected. Contact your service representative.

- 1000/100/10 lamps

The 1000/100/10 lamp indicates whether the LAN2 port normally equipped with the server is operated through the 1000BASE-T, 100BASE-TX or 10BASE-T network interface. If the lamp is lit amber, the network port is operated through 1000BASE-T. If the lamp is lit green, the network port is operated through 100BASE-TX. If the lamp is off, the network port is operated through 10BASE-T.

PCI Slot Lamps

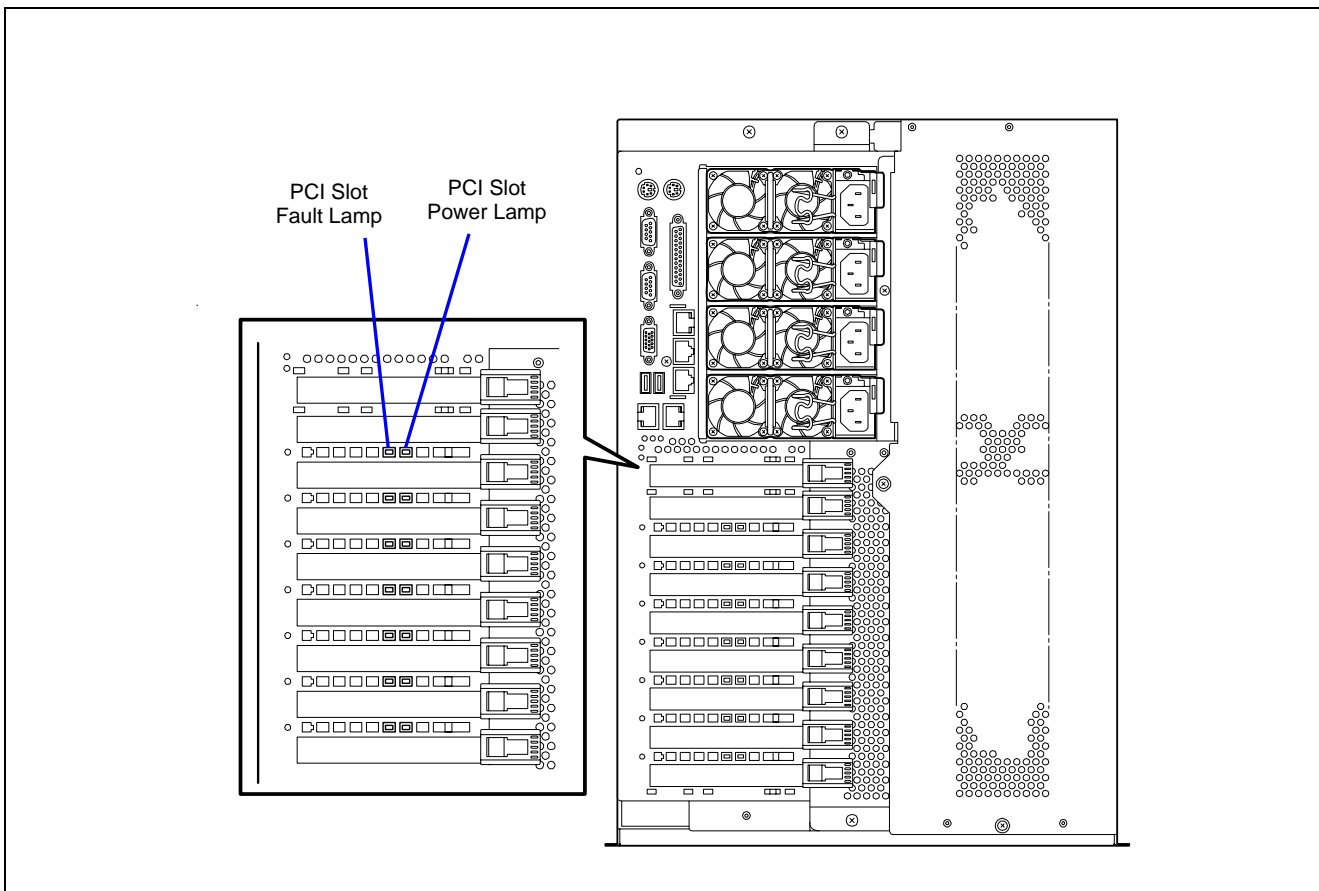

PCI Slot Power Lamp

The PCI slot power lamp lights in green when a PCI board is installed in the slot and powered up.

PCI Slot Fault Lamp

This lamp is available only when the operating system is Windows 2003/2000.

If the driver of a Hot Plug PCI board is stopped under Windows 2003/2000 and then the PCI board is logically disconnected from the system, PCI slot fault lamp blinks in amber.

If an error occurred on a PCI board or the slot where is installed the PCI board, this lamp lights in amber.

FAN Fault Lamps

FAN Fault lamp is adjacent to each fan module. These lamps are triangular in shape and point to their respective fans. When the cooling fan is working normally, the lamp does not light. When a fan is not working normally, the lamp lights in red. A cooling fan failure is also indicated by the status lamp located on the front panel. The failed fan may be hot-swapped.

IMPORTANT: Do not remove a fan that is normally operating. Ask your service representative for replacement of the cooling fan. If a cooling fan fails, do not continue to operate the system, but ask your service representative for replacement as soon as you can.

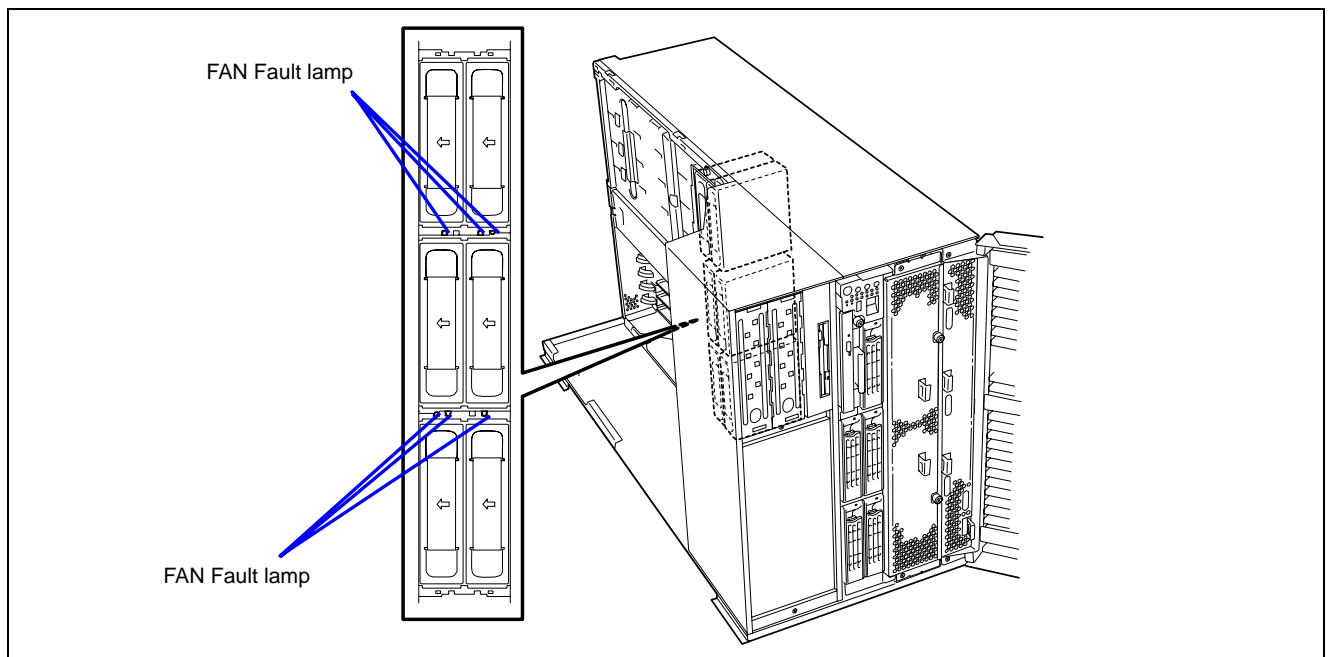

ERROR MESSAGES

If an error occurs in the server, an error message appears on the display unit connected to the server.

Error Messages after Power-on

Powering on the server automatically starts the self-diagnostic program, POST (Power On Self-Test). When the POST detects any error, it displays an error message and its measure on the display unit.

Follow the table below to troubleshoot such errors. However, even when there is no hardware failure, use of the keyboard or mouse at the following timing causes the POST to assume a keyboard controller error and stop processing.

- Immediately after the server is powered
- Immediately after the system is rebooted in response to a keyboard instruction (simultaneous key entry of **Ctrl + Alt + Delete**)
- Immediately after the system is rebooted in response to an operating system instruction
- During hardware initialization following restart of the POST

When the POST detects a hardware failure due to one of the above reason, restart the server once again. If the same error message reappears, you may assume there is no hardware error. To ensure normal operation of the server, however, make sure to follow the following restrictions.

- Do not make any keyboard entry or use the mouse before the memory count appears on the screen following the server power-on.
- Do not make any keyboard entry or use the mouse before the start-up message of the SCSI Configuration Utility appears on the screen following the server reboot.

IMPORTANT: Take a note on the on-screen message before contacting your service representative. The alarm indication would be a great help for maintenance.

POST Error Messages

When POST detects an error, it displays an error message on the display unit screen. The following table lists error messages, descriptions, and actions to take.

IMPORTANT: Take a note on the messages displayed before consulting with your service representative. Alarm messages are useful information for maintenance.

Error code	Error message	Recommended Action
0200	Failure Fixed Disk.	Contact your service representative.
0210	Stuck Key.	Disconnect the keyboard and connect it again.
0211	Keyboard error.	<ul style="list-style-type: none"> • Disconnect the keyboard and connect it again. • Restart the system. If the error cannot be corrected, contact your service representative.
0212	Keyboard Controller Failed.	
0213	Keyboard locked - Unlock key switch.	Release the lock of the key switch. If the error cannot be corrected in spite of the release of the lock, contact your service representative.
0220	Monitor type does not match CMOS - Run SETUP.	Start the SETUP. If the error cannot be corrected in spite of the start of SETUP, contact your service representative.
0230	System RAM Failed at offset.	Contact your service representative.
0231	Shadow RAM Failed at offset.	
0232	Extended RAM Failed at address line.	
0250	System battery is dead - Replace and run SETUP.	Contact your service representative to replace the battery. (After restarting the computer, start the SETUP to provide the setting again.)
0251	System CMOS checksum bad - Default configuration used.	The default values have just been set. Start the SETUP to provide the setting again. If the error cannot be corrected, contact your service representative.
0252	Password checksum bad - Passwords cleared.	The password has just been cleared. Start the SETUP to provide the setting again.
0260	System timer error.	Start the SETUP to set the date and time again. If the same error occurs successively in spite of the resetting, contact your service representative.
0270	Real time clock error.	
0271	Check date and time setting.	
0280	Previous boot incomplete – Default configuration used	Contact your service representative.
02B0	Diskette drive A error.	Start the SETUP to set the "Legacy Floppy A" and "Legacy Floppy B" in the Main menu again. If the same error occurs successively in spite of the resetting, contact your service representative.
02B1	Diskette drive B error.	
02B2	Incorrect Drive A type - run SETUP.	Start the SETUP to provide the setting again. If the error cannot be corrected, contact your service representative.
2B3	Incorrect Drive B type - run SETUP.	
02D0	System cache error - Cache disabled.	The cache cannot be used. Contact your service representative.
02D1	System Memory exceeds the CPU's caching limit.	Contact your service representative.
02F5	DMA Test Failed.	
02F6	Software NMI Failed.	
02F7	Fail-safe Timer NMI Failed.	
0500	Expansion ROM not initialized - PCI Slot 01	
0501	Expansion ROM not initialized - PCI Slot 02	
0502	Expansion ROM not initialized - PCI Slot 03	
0503	Expansion ROM not initialized - PCI Slot 04	
0504	Expansion ROM not initialized - PCI Slot 05	
0505	Expansion ROM not initialized - PCI Slot 06	
0506	Expansion ROM not initialized - PCI Slot 07	
0507	Expansion ROM not initialized - PCI Slot 08	
0508	Expansion ROM not initialized - PCI Slot 09	
0611	IDE configuration changed.	
0613	COM A configuration changed.	
0614	COM A config. error - device disabled.	

Error code	Error message	Recommended Action
0615	COM B configuration changed.	Contact your service representative.
0616	COM B config. error - device disabled.	
0617	Floppy configuration changed.	
0618	Floppy config. error - device disabled.	
0619	Parallel port configuration changed.	
061A	Parallel port config. error - device disabled.	
0B00	Rebooted during BIOS boot at Post Code.	
0B1B	PCI System Error on Bus/Device/Function.	
0B1C	PCI Parity Error on Bus/Device/Function.	
0B28	Unsupported Processor detected on Processor 1.	
0B29	Unsupported Processor detected on Processor 2.	
0B2A	Unsupported Processor detected on Processor 3.	
0B2B	Unsupported Processor detected on Processor 4.	
0B30	Fan 1 Alarm occurred.	A fan failure or fan clogging may occur. Contact your service representative to request the maintenance.
0B31	Fan 2 Alarm occurred.	
0B32	Fan 3 Alarm occurred.	
0B33	Fan 4 Alarm occurred.	
0B34	Fan 5 Alarm occurred.	
0B35	Fan 6 Alarm occurred.	
0B36	Fan 7 Alarm occurred.	
0B37	Fan 8 Alarm occurred.	
0B50	Processor #1 with error taken off line.	The processor is degraded. Contact your service representative.
0B51	Processor #2 with error taken offline.	
0B52	Processor #3 with error taken offline.	
0B53	Processor #4 with error taken offline.	
0B5F	Forced to use Processor with error	Because an error is detected in every processor, the system is forcibly started. Contact your service representative.
0B60	DIMM group #1 has been disabled	Contact your service representative.
0B61	DIMM group #2 has been disabled	
0B62	DIMM group #3 has been disabled	
0B63	DIMM group #4 has been disabled	
0B64	DIMM group #5 has been disabled	
0B65	DIMM group #6 has been disabled	
0B66	DIMM group #7 has been disabled	
0B67	DIMM group #8 has been disabled	
0B70	The error occurred during temperature sensor reading.	A fan failure or fan clogging may occur. Contact your service representative to request the maintenance.
0B71	System Temperature out of the range.	
0B74	The error occurred during voltage sensor reading.	
0B75	System voltage out of the range.	
0B78	The error occurred during fan sensor reading	Contact your service representative.
0B7C	The error occurred during redundant power module confirmation	
0B7D	The normal operation can't be guaranteed with use of only one PSU	Contact you service representative to replace the power supply unit.
		Contact you service representative to add an additional power supply unit or replace the existing power supply unit.

Error code	Error message	Recommended Action
0B80	BMC Memory Test Failed.	Turn off the power once and then on again to start the server. If the error cannot be corrected, contact your service representative.
0B81	BMC Firmware Code Area CRC check failed.	
0B82	BMC core hardware failure.	
0B83	BMC IBF or OBF check failed.	
0B8A	BMC SEL area full.	
0B8B	BMC progress check timeout.	
0B8C	BMC command access failed.	
0B8D	Could not redirect the console - BMC Busy -	
0B8E	Could not redirect the console - BMC Error -	
0B8F	Could not redirect the console - BMC Parameter Error -	
0B90	BMC Platform Information Area corrupted.	
0B91	BMC update firmware corrupted.	
0B92	Internal Use Area of BMC FRU corrupted.	All the commands and functions other than the FRU command and the EMP function can be used. This is not a fatal error. Turn off the power once and then on again to restart the server. If the error cannot be corrected, contact your service representative.
0B93	BMC SDR Repository empty.	Turn off the power once and then on again to restart the server. If the error cannot be corrected, contact your service representative.
0B94	IPMB signal lines do not respond.	All the functions other than the function of accessing to SMC through IPMB can be used. This is not a fatal error. Turn off the power once and then on again to restart the server. If the error cannot be corrected, contact your service representative.
0B95	BMC FRU device failure.	All the commands and functions other than the FRU command and the EMP function can be used. This is not a fatal error. Turn off the power once and then on again to restart the server. If the error cannot be corrected, contact your service representative.
0B96	BMC SDR Repository failure.	Turn off the power once and then on again to start the server. If the error cannot be corrected, contact your service representative.
0B97	BMC SEL device failure.	
0B98	BMC RAM test error.	
0B99	BMC Fatal hardware error.	
0B9A	BMC not responding.	
0B9B	Private I2C bus not responding.	
0B9C	BMC internal exception.	
0B9D	BMC A/D timeout error.	
0B9E	SDR repository corrupt.	
0B9F	SEL corrupt.	
0BB0	SMBIOS - SROM data read error.	Contact your service representative.
0BB1	SMBIOS - SROM data checksum bad.	Contact your service representative to replace the processor.
0BC0	POST detected startup failure of 1st Processor.	
0BC1	POST detected startup failure of 2nd Processor.	
0BC2	POST detected startup failure of 3rd Processor.	
0BC3	POST detected startup failure of 4th Processor.	

Error code	Error message	Recommended Action
8120	Unsupported DIMM detected in DIMM group #1.	Contact your service representative to replace the two DIMMs in the relevant group.
8121	Unsupported DIMM detected in DIMM group #2.	
8122	Unsupported DIMM detected in DIMM group #3.	
8123	Unsupported DIMM detected in DIMM group #4.	
8124	Unsupported DIMM detected in DIMM group #5.	
8125	Unsupported DIMM detected in DIMM group #6.	
8126	Unsupported DIMM detected in DIMM group #7.	
8127	Unsupported DIMM detected in DIMM group #8.	
8130	Mismatch DIMM Type detected in DIMM group #1.	See the labels put on the DIMMs to make sure that the DIMMs of the same type are installed in groups. If DIMMs of different types are installed in one or more groups, contact the service representative to replace DIMMs properly.
8131	Mismatch DIMM Type detected in DIMM group #2.	
8132	Mismatch DIMM Type detected in DIMM group #3.	
8133	Mismatch DIMM Type detected in DIMM group #4.	
8134	Mismatch DIMM Type detected in DIMM group #5.	
8135	Mismatch DIMM Type detected in DIMM group #6.	
8136	Mismatch DIMM Type detected in DIMM group #7.	
8137	Mismatch DIMM Type detected in DIMM group #8.	
8140	DIMM group #1 with error is enabled.	Contact your service representative to replace the two DIMMs in the relevant group.
8141	DIMM group #2 with error is enabled.	
8142	DIMM group #3 with error is enabled.	
8143	DIMM group #4 with error is enabled.	
8144	DIMM group #5 with error is enabled.	
8145	DIMM group #6 with error is enabled.	
8146	DIMM group #7 with error is enabled.	
8147	DIMM group #8 with error is enabled.	
8150	NVRAM Cleared By Jumper.	Turn off the power. Then recover the jumper setting to the original setting.
8151	Password Cleared By Jumper.	
8160	Mismatch Processor Speed detected on Processor 1.	Check the frequency of the processor. If it is unknown, contact your service representative.
8161	Mismatch Processor Speed detected on Processor 2.	
8162	Mismatch Processor Speed detected on Processor 3.	
8163	Mismatch Processor Speed detected on Processor 4.	
8170	Processor 1 not operating at intended frequency	

Error code	Error message	Recommended Action
8171	Processor 2 not operating at intended frequency	Check the frequency of the processor. If it is unknown, contact your service representative.
8172	Processor 3 not operating at intended frequency	
8173	Processor 4 not operating at intended frequency	
817F	All processors not operating at intended frequency	
8200	Online Spare Memory was not ready.	DIMM type mismatch is detected when the online spare memory feature is enabled. Contact your service representative.
8201	Mirroring Memory was not ready.	DIMM type mismatch is detected or unnecessary installation in group #2 is detected when the memory mirroring feature is enabled. Check the DIMM type or installation. If the error cannot be corrected, contact your service representative.
8202	Memory RAID was not ready.	Check if capacity, type, and installation status of all DIMMs are correct.
8300	Secondary BIOS is corrupted.	Contact your service representative.

The following figures show the location of specific components referenced in the POST error codes and messages table listed above.

NOTE: Failed processors or memory boards can be also identified with the BIOS SETUP utility.

■ Fans

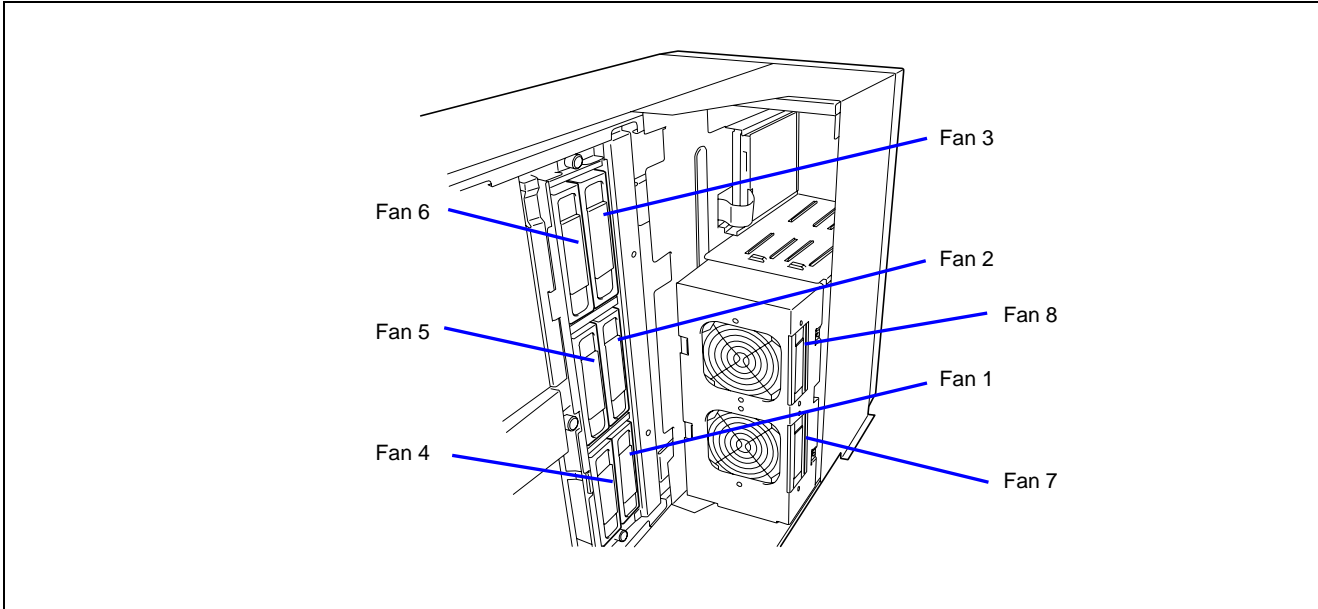

■ Processors

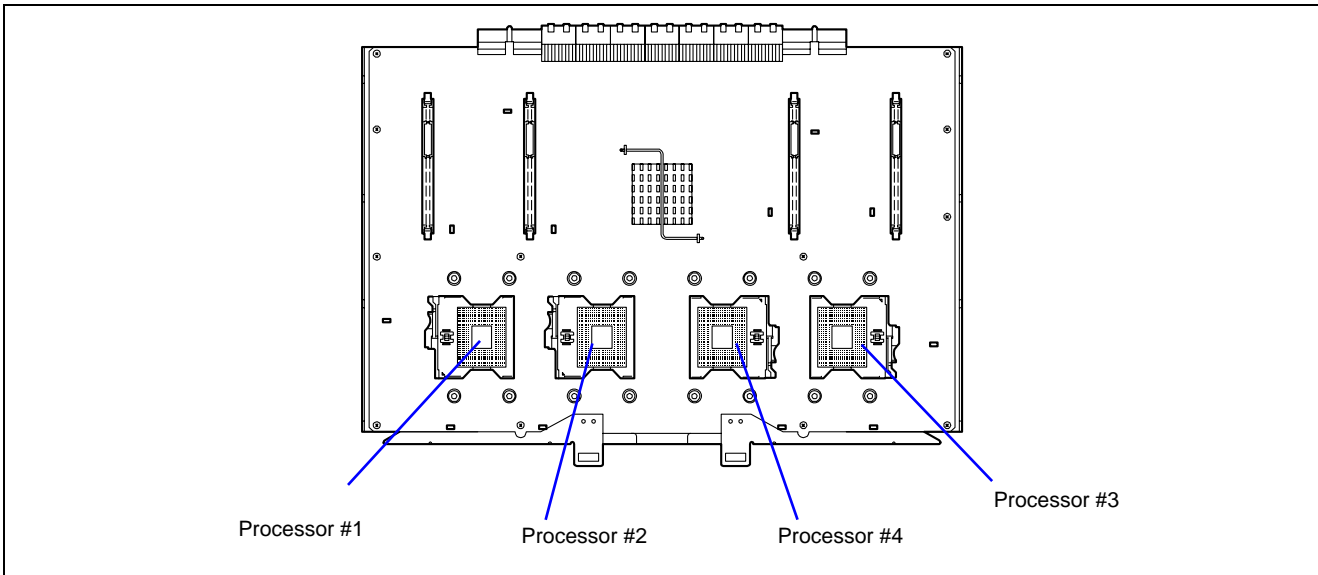

■ Memory board

The DIMM group consists of four DIMM boards.

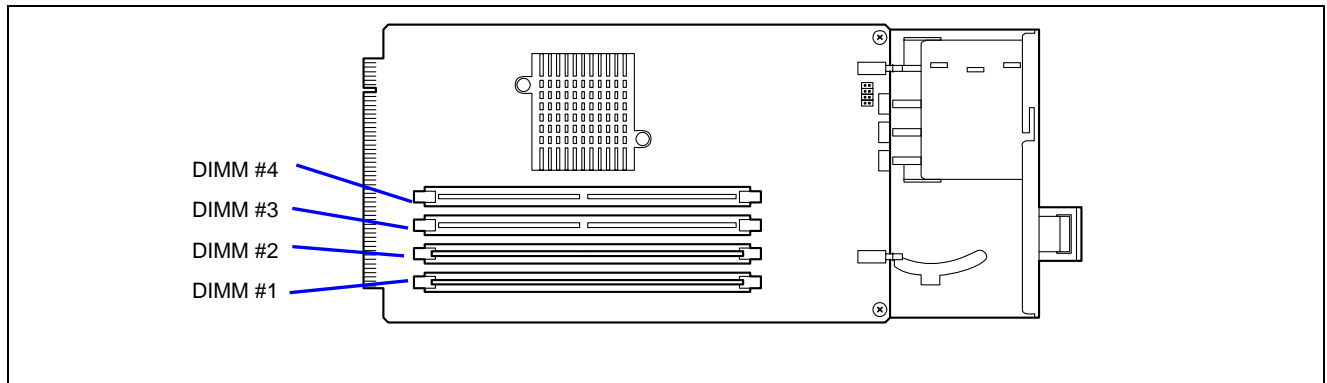

	Memory board slot #1		Memory board slot #2		Memory board slot #3		Memory board slot #4	
1	DIMM #1	DIMM Group #1	DIMM #1	DIMM Group #3	DIMM #1	DIMM Group #5	DIMM #1	DIMM Group #7
2	DIMM #2		DIMM #2		DIMM #2		DIMM #2	
3	DIMM #3	DIMM Group #2	DIMM #3	DIMM Group #4	DIMM #3	DIMM Group #6	DIMM #3	DIMM Group #8
4	DIMM #4		DIMM #4		DIMM #4		DIMM #4	

Beep Codes

If an error occurs during the POST, the server beeps, indicating the type of error.

Each number indicates the number of short beeps, and a hyphen indicates a pause. For example, the beep interval 1-3-1-3 indicates 1 beep, pause, 3 beeps, pause, 1 beeps, pause, and 3 beeps notifying that the keyboard controller error.

Beep code	Description	Recommended action
1-2	Video BIOS initialization error	If nothing is displayed, check if the connector of the display unit is properly connected. If the error persists, contact your service representative to replace the I/O board. If an expansion of Option ROM for additionally installed PCI board is not displayed, check if the PCI board is properly installed. If the error persists, contact your service representative to replace the I/O board or PCI board.
1-2	Option ROM initialization error	
1-3-1-3	Keyboard controller error	Disconnect the keyboard and connect it again. If the error persists, contact your service representative to replace the I/O board.
1-3-3-1	Memory is not detected. Or, DIMM type is incorrect.	Check if the DIMM and memory boards are properly connected. If the error persists, contact your service representative to replace DIMM or memory board.
1-3-4-1	DRAM Address error	
1-3-4-3	DRAM test Low Byte error	
1-4-1-1	DRAM test High Byte error	
1-5-1-1	Processor fails to start.	Check if the processor is properly installed. If the error persists, contact your service representative to replace processor or processor board.
1-5-2-2	No processor error	
1-5-2-3	Processors of various types and voltages coexist.	Check if the additionally installed processor is supported by the server. Check also the installation of processor. If the error persists, contact your service representative to replace the processor or processor board.
1-5-4-4	Power failure	Internal board may be faulty. Contact your service representative to identify the faulty board and replace it with new one.
2-2-3-1	Unexpected interrupt test error	Contact your service representative to replace the I/O board.

NOTE: Beep code 1-5-4-2 informs you that AC power supply is interrupted due to power failure or momentary voltage drop and the system is restarted. This is not an error.

Error Messages on Virtual LCD

The remote management feature of DianaScope and Web Server allows the managed server to display the virtual LCD (16 digits x 2 lines) and status lamps.

The virtual LCD displays the followings:

- POST progress
- Error occurred during operation or DC OFF (AC power is being on)

When POST detects an error, the POST error code is displayed on the virtual LCD upon completion of POST. See the table for POST error codes for details.

POST Progress

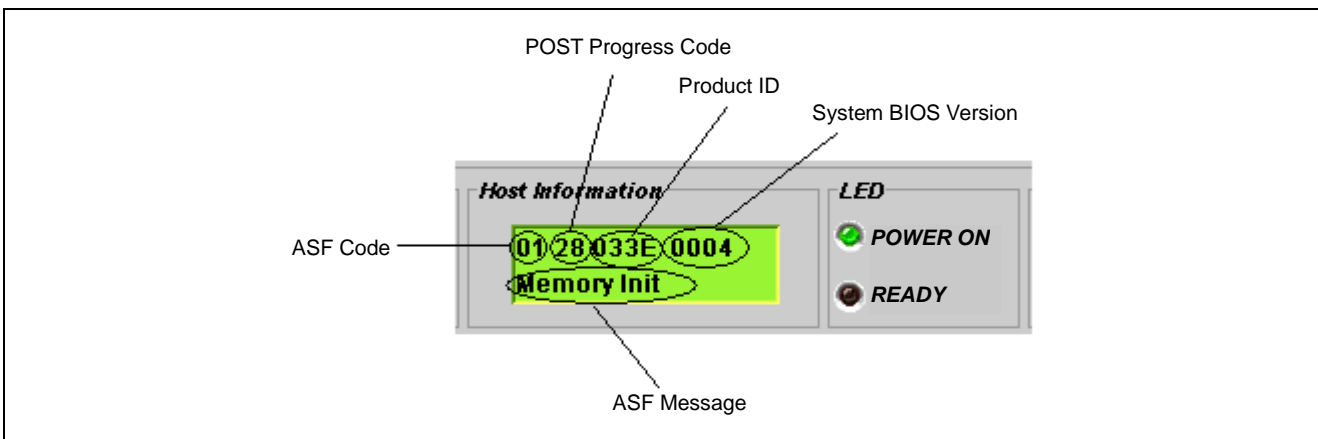

POST Error Code

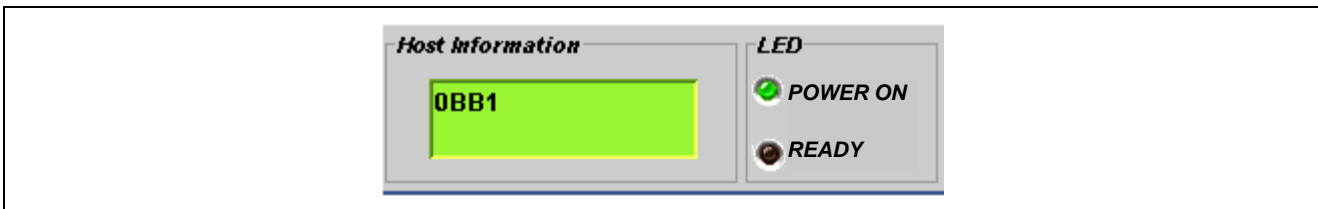

Other Messages

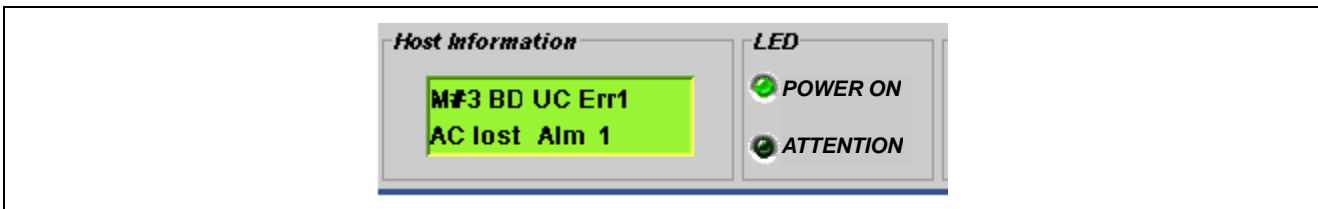

Messages displayed on upper line

On-screen message	Description	Action
Prepare To Boot	POST completes normally.	This is not an error.
CPU Reconfigured	POST completes with processor degraded.	Contact your service representative. Try the following steps to cancel the error. 1. Start BIOS SETUP. 2. Select [Main] - Processor Settings] - [Processor Retest] - [Yes]. 3. Select [Exit] - [Exit Saving Changes].
Mem Reconfigured	POST completes with memory degraded.	Contact your service representative. Try the following steps to cancel the error. 1. Start BIOS SETUP. 2. Select [Advanced] - [Memory Configuration] - [Memory Retest] - [Yes]. 3. Select [Exit] - [Exit Saving Changes].
M#1 D#1 C Err	A correctable error frequently occurs in DIMM #1 on memory board #1.	The system can continue operation. However, consult with your service representative.
M#1 D#2 C Err	A correctable error frequently occurs in DIMM #2 on memory board #1.	
M#1 D#3 C Err	A correctable error frequently occurs in DIMM #3 on memory board #1.	
M#1 D#4 C Err	A correctable error frequently occurs in DIMM #4 on memory board #1.	
M#2 D#1 C Err	A correctable error frequently occurs in DIMM #1 on memory board #2.	
M#2 D#2 C Err	A correctable error frequently occurs in DIMM #2 on memory board #2.	
M#2 D#3 C Err	A correctable error frequently occurs in DIMM #3 on memory board #2.	
M#2 D#4 C Err	A correctable error frequently occurs in DIMM #4 on memory board #2.	
On-screen message	Description	Action
M#3 D#1 C Err	A correctable error frequently occurs in DIMM #1 on memory board #3.	The system can continue operation. However, consult with your service representative.
M#3 D#2 C Err	A correctable error frequently occurs in DIMM #2 on memory board #3.	
M#3 D#3 C Err	A correctable error frequently occurs in DIMM #3 on memory board #3.	
M#3 D#4 C Err	A correctable error frequently occurs in DIMM #4 on memory board #3.	
M#4 D#1 C Err	A correctable error frequently occurs in DIMM #1 on memory board #4.	
M#4 D#2 C Err	A correctable error frequently occurs in DIMM #2 on memory board #4.	
M#4 D#3 C Err	A correctable error frequently occurs in DIMM #3 on memory board #4.	
M#4 D#4 C Err	A correctable error frequently occurs in DIMM #4 on memory board #4.	
M#1 D#1 UC Err	An uncorrectable error occurs in DIMM #1 or DIMM #2 on memory board #1.	The system can continue operation if the status lamp flashes green. However, consult with your service representative.
M#1 D#2 UC Err		
M#1 D#3 UC Err	An uncorrectable error occurs in DIMM #3 or DIMM #4 on memory board #1.	
M#1 D#4 UC Err		
M#2 D#1 UC Err	An uncorrectable error occurs in DIMM #1 or DIMM #2 on memory board #2.	
M#2 D#2 UC Err		
M#2 D#3 UC Err	An uncorrectable error occurs in DIMM #3 or DIMM #4 on memory board #2.	
M#3 D#4 UC Err		
M#3 D#1 UC Err	An uncorrectable error occurs in DIMM #1 or DIMM #2 on memory board #3.	
M#3 D#2 UC Err		

M#3 D#3 UC Err	An uncorrectable error occurs in DIMM #3 or DIMM #4 on memory board #3.	
M#3 D#4 UC Err		
M#4 D#1 UC Err	An uncorrectable error occurs in DIMM #1 or DIMM #2 on memory board #4.	
M#4 D#2 UC Err		
M#4 D#3 UC Err	An uncorrectable error occurs in DIMM #3 or DIMM #4 on memory board #4.	
M#4 D#4 UC Err		
M#1 BD C ErrX	A correctable error frequently occurs on memory board #1.	The system can continue operation. However, consult with your service representative.
M#2 BD C ErrX	A correctable error frequently occurs on memory board #2.	
M#3 BD C ErrX	A correctable error frequently occurs on memory board #3.	
M#4 BD C ErrX	A correctable error frequently occurs on memory board #4.	
M#1 BD UC ErrX	An uncorrectable error occurs on memory board #1.	The system can continue operation if the status lamp flashes green. However, consult with your service representative.
M#2 BD UC ErrX	An uncorrectable error occurs on memory board #2.	
M#3 BD UC ErrX	An uncorrectable error occurs on memory board #3.	
M#4 BD UC ErrX	An uncorrectable error occurs on memory board #4.	
PROC BD C ErrX	A correctable error frequently occurs on processor board.	The system can continue operation. However, consult with your service representative.
PROC BD UC ErrX	An uncorrectable error occurs on processor board.	The system can continue operation if the status lamp flashes green. However, consult with your service representative.
IO BD C ErrX	A correctable error frequently occurs on I/O board.	The system can continue operation. However, consult with your service representative.
IO BD UC Err1	An uncorrectable error occurs on I/O board.	Consult with your service representative.
PCI S#3 C Err	A correctable error frequently occurs on PCI board slot #3.	The system can continue operation. However, consult with your service representative.
PCI S#4 C Err	A correctable error frequently occurs on PCI board slot #4.	
PCI S#5 C Err	A correctable error frequently occurs on PCI board slot #5.	
PCI S#1 Err	A fatal error occurs on PCI board slot #1.	Consult with your service representative.
PCI S#2 Err	A fatal error occurs on PCI board slot #2.	
PCI S#3 Err	A fatal error occurs on PCI board slot #3.	
PCI S#4 Err	A fatal error occurs on PCI board slot #4.	
PCI S#5 Err	A fatal error occurs on PCI board slot #5.	
PCI S#6 Err	A fatal error occurs on PCI board slot #6.	
PCI S#7 Err	A fatal error occurs on PCI board slot #7.	
PCI S#8 Err	A fatal error occurs on PCI board slot #8.	
PCI S#9 Err	A fatal error occurs on PCI board slot #9.	

Messages displayed on lower line

On-screen message	Description	Action
Proc Missing	Processor is not found.	Contact your service representative.
240VA Power Down	POWERGOOD dropped during power-on.	
Power On Cnt Alm	POWERGOOD signal error occurred at power on/off.	
Proc1 VccpAlm XX	VCCP voltage alarm occurred on processor #1.	
Proc2 VccpAlm XX	VCCP voltage alarm occurred on processor #2.	
Proc3 VccpAlm XX	VCCP voltage alarm occurred on processor #3.	
Proc4 VccpAlm XX	VCCP voltage alarm occurred on processor #4.	
BB +3.3v Alm XX	+3.3V voltage alarm occurred on I/O board.	
BB +3.3vs Alm XX	+3.3Vs voltage alarm occurred on I/O board.	
BB +5.0v Alm XX	+5.0V voltage alarm occurred on I/O board.	
BB +5.0vs Alm XX	+5.0Vs voltage alarm occurred on I/O board.	
BB +12v Alm XX	+12V voltage alarm occurred on I/O board.	
BB -12v Alm XX	-12V voltage alarm occurred on I/O board.	
VBAT Alm XX	Voltage alarm in lithium battery occurred.	
BB +1.25v Alm XX	+1.25V voltage alarm occurred on I/O board.	
BB +1.5v Alm XX	+1.5V voltage alarm occurred on I/O board.	
BB +1.8v Alm XX	+1.8V voltage alarm occurred on I/O board.	
BB VTT Alm XX	+1.150V voltage alarm occurred on I/O board.	
VDD TNB Alm XX	+1.500V voltage alarm occurred on processor board.	
VCACHE1 Alm XX	VCACHE1 voltage alarm occurred on processor board.	
VCACHE2 Alm XX	VCACHE2 voltage alarm occurred on processor board.	
Proc 1 T-Trip	Thermal Trip occurred on processor #1.	
Proc 2 T-Trip	Thermal Trip occurred on processor #2.	
Proc 3 T-Trip	Thermal Trip occurred on processor #3.	
Proc 4 T-Trip	Thermal Trip occurred on processor #4.	
Processor 1 IERR	IERR occurred on processor #1.	
Processor 2 IERR	IERR occurred on processor #2.	
Processor 3 IERR	IERR occurred on processor #3.	
Processor 4 IERR	IERR occurred on processor #4.	
SB1 +3.3v Alm XX	+3.3V voltage alarm occurred on SCSI backplane 1.	
SB1 +5.0v Alm XX	+5.0V voltage alarm occurred on SCSI backplane 1.	
SB1 +12v Alm XX	+12V voltage alarm occurred on SCSI backplane 1.	

On-screen message	Description	Action
SB2 +3.3v Alm XX	+3.3V voltage alarm occurred on SCSI backplane 2.	Contact your service representative.
SB2 +5.0v Alm XX	+5.0V voltage alarm occurred on SCSI backplane 2.	
SB2 +12v Alm XX	+12V voltage alarm occurred on SCSI backplane 2.	
SCSI A-1 Alm XX	SCSI channel-A voltage error occurred.	
SCSI A-2 Alm XX	SCSI channel-A voltage error occurred.	
SCSI A-3 Alm XX	SCSI channel-A voltage error occurred.	
SCSI B-1 Alm XX	SCSI channel-B voltage error occurred.	
SCSI B-2 Alm XX	SCSI channel-B voltage error occurred.	
SCSI B-3 Alm XX	SCSI channel-B voltage error occurred.	
Proc1 TempAlm XX	Processor #1 thermal error occurred.	
Proc2 TempAlm XX	Processor #2 thermal error occurred.	
Proc3 TempAlm XX	Processor #3 thermal error occurred.	
Proc4 TempAlm XX	Processor #4 thermal error occurred.	
BB Temp Alm XX	I/O board thermal error occurred.	
FP Temp Alm XX	Front panel thermal error occurred.	
OS shutdown Alm	operating system shutdown alarm occurred.	
WDT timeout	Watchdog timer timeout error occurred.	
DUMP Request !	Dump switch is pressed.	
SMI timeout	SMI timeout occurred.	
AC lost Alm 1	AC lost occurred on power unit #1.	
AC lost Alm 2	AC lost occurred on power unit #2.	
AC lost Alm 3	AC lost occurred on power unit #3.	
AC lost Alm 4	AC lost occurred on power unit #4.	
Power Unit 1 Alm	Power unit #1 Failure occurred.	
Power Unit 2 Alm	Power unit #2 Failure occurred.	
Power Unit 3 Alm	Power unit #3 Failure occurred.	
Power Unit 4 Alm	Power unit #4 Failure occurred.	
Predictive Alm 1	Predictive Failure occurred on power unit #1.	
Predictive Alm 2	Predictive Failure occurred on power unit #2.	
Predictive Alm 3	Predictive Failure occurred on power unit #3.	
Predictive Alm 4	Predictive Failure occurred on power unit #4.	
CPU Fan Alarm	CPU FAN alarm occurred.	
PWR Fan Alarm	Power unit FAN alarm occurred.	
Sys Fan 1 Alarm	FAN#1 alarm occurred.	
Sys Fan 2 Alarm	FAN#2 alarm occurred.	
Sys Fan 3 Alarm	FAN#3 alarm occurred.	
Sys Fan 4 Alarm	FAN#4 alarm occurred.	
Sys Fan 5 Alarm	FAN#5 alarm occurred.	
Sys Fan 6 Alarm	FAN#6 alarm occurred.	

SOLVING PROBLEMS

When the server fails to operate as expected, see the following to find out your problem and follow the instruction given before asking for repair.

If the server still fails to operate successfully after solving your problem, take a note on the on-screen message and contact your service representative.

Problems with Server

No screen display appears with beep:

- Are DIMMs installed securely?
 - Check whether DIMMs are connected to the mating connectors firmly.
 - Check whether DIMMs of different specifications are installed in the specific group. See Chapter 9 for the DIMMs specifications.

Fail to power on the server:

- Is the server is properly supplied with power?
 - Check if the power cord is connected to a power outlet (or UPS) that meets the power specifications for the server.
 - Make sure to use the power cord provided with the server. Check the power cord for broken shield or bent plugs.
 - Make sure the power breaker for the connected power outlet is on.
 - If the power cord is plugged to a UPS, make sure the UPS is powered and it outputs power. See the manual that comes with the UPS for details.

Power supply to the server may be linked with the connected UPS using the BIOS setup utility of the server.

<Menu to check: [Server] - [AC-LINK]>
- Did you press the POWER switch?
 - Press the POWER switch on the front of the server to turn on the power (the POWER/SLEEP lamp lights).

Fail to power off the server / SLEEP switch is disabled:

- Is the POWER switch or SLEEP switch enabled?
 - Restart the server and start the BIOS setup utility.

<Menu to check: [Security] - [Power Switch Inhibit]>
- Is the server running in the Secure Mode?
 - The POWER switch and the SLEEP switch are disabled in the Secure Mode. (Forced shutdown is also not available.) To release the Secure Mode, enter the password specified with the BIOS setup utility.

POST fails to complete:

- Is the DIMM board installed?
 - At least four DIMM boards are required for operation.
- Is the memory size large?
 - The memory check may take a few seconds if the memory size is large. Wait for a while.
- Did you perform any keyboard or mouse operation immediately after you started the server?
 - If you perform any keyboard or mouse operation immediately after start-up, POST may accidentally detect a keyboard controller error and stop proceeding. In such a case, restart the server once again. Do not perform any keyboard or mouse operation until the BIOS start-up message appears when you restart the server.
- Does the server contains appropriate memory boards or PCI devices?
 - Operation of the server with unauthorized devices is not guaranteed.

Fail to access to internal or external devices (or such devices fail to operate):

- Are cables properly connected?
 - Make sure that the interface cables and power cord are properly connected. Also make sure that the cables are connected in the correct order.
- Is the power-on order correct?
 - When the server has any external devices connected, power on the external devices first, then the server.
- Did you install drivers for connected optional devices?
 - Some optional devices require specific device drivers. Refer to the manual that comes with the device to install its driver.
- Is BIOS configuration correct?
 - When the server has PCI devices connected, make sure to set the PCI device interrupt and others with the BIOS setup utility of the server. (Most PCI devices generally do not require any change to the configuration, but some boards do require specific settings. Refer to the manual that comes with the board for details to make correct settings.
<Menus to check: [Advanced] - [Advanced Chipset Control] - [PCI Device]>
 - Some devices connected to the serial or parallel port may require I/O port address or operation mode settings. Refer to the manual that comes with the board for details to make correct settings.
<Menu to check: [Advanced] - [Peripheral Configuration]>

USB device fail to operate:

- Did you connect the USB2.0 device to the USB connector on the front panel?
 - The USB connector on the front panel is dedicated to USB1.1. Use the USB connector on the rear panel to connect the USB2.0 device.

Management PC cannot detect the server:

- Is Java2 Runtime Environment, Standard Edition 1.4.2_04 or later used for management PC?
 - Download Java2 Runtime Environment, Standard Edition 1.4.2_04 or later from <http://java.sun.com/j2se/>.
- Are LAN or ICMB cable properly connected?
 - Make sure that the cable is properly connected to the management LAN port or ICMB port. If the cables are incorrectly connected, the sensor of the server will not be monitored. Also check if the cables are connected to LAN connector or serial port connector by mistake.
- Is the IP address unique in the network?
 - The IP address for management LAN port is factory-set to 192.168.1.1. If the same address exists in the same network, the server will not be detected correctly. Change the IP address appropriately.
- Is the server specified to be monitored by ESMPRO Agent?
 - Change setting of ESMPRO Agent.
 - Start ESMPRO Agent from Windows control panel, select [System] → [Express5800 Server] → [Monitor]. (The default is [Does not monitor].) Monitoring starts automatically. You do not need to restart the system, however, reconfiguring the tree may be needed if the server is not detected.
- Is any error message displayed?
 - See page 4-94 for details.

The server console is not displayed on remote KVM console:

- Is the resolution correctly set?
 - To display the server console on the remote KVM console, the resolution must be within 1024x768, and the refresh rate 75Hz. or less.
- Do you use the remote KVM console in text mode?
 - Under Linux, monitor, driver, and video memory settings may fail in graphical display such as X-Windows. We recommend using Linux in text mode.

Forgotten the login name/password to use the remote management feature through Web browser:

- If you have forgotten the login name or password, restore the factory default including password by changing the BMC configuration jumper switch.

IMPORTANT: Restoring the factory default clears BMC configuration that is used for DianaScope to connect with the server.

If you are using DianaScope, you need to save the configuration data into a floppy disk before clearing password.

BMC can be configured and saved with DianaScope Agent and the system management feature of EXPRESSBUILDER.

1. Power off the server and unplug the power cord.
2. Change the BMC configuration jumper switch setting as shown below. (See Chapter 4 for details.)

Factory-set jumper switch location Jumper switch location for clearing password

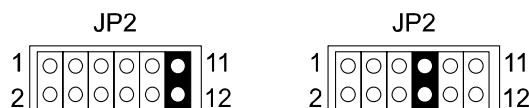

3. Connect the power cord.

4. Wait at least 30 seconds with the power being off, then unplug the power cord.
5. Restore the BMC configuration jumper switch setting and power on the server for reconfiguration.

The keyboard or mouse fails to operate:

- Is the cable properly connected?
 - Make sure that the cable is connected to the correct connector on the rear of the server.
 - The keyboard or mouse does not operate if it is connected when the server is powered (not applicable to USB devices). Power off the server first and connect it properly.
- Is BIOS configuration correct?
 - The keyboard and mouse may be disabled with the BIOS setup utility of the server. Check the settings with the BIOS setup utility.
<Menus to check: [Advanced] - [Peripheral Configuration] - [PS/2 Mouse], [Advanced] - [Numlock]>
- Are the server drivers installed?
 - Refer to the manual that comes with your operating system to check that the keyboard and mouse drivers are installed. (These drivers are installed along with the operating system.) Some operating systems allow you to change the keyboard and mouse settings. Refer to manual that comes with your operating system to check that the keyboard and mouse settings are correct.
- Is the server in the Secure Mode?
 - In the Secure Mode, the keyboard and mouse are disabled. To release the Secure Mode, enter the password specified with the BIOS setup utility.

Fail to access (read or write) to the floppy disk:

- Does the floppy disk drive contain a floppy disk?
 - Insert a floppy disk into the floppy disk drive until it clicks.
- Is the floppy disk write-protected?
 - Place the write-protect switch on the floppy disk to the "Write-enabled" position.
- Is the floppy disk formatted?
 - Use a formatted floppy disk or format the floppy disk in the floppy disk drive. Refer to the manual that comes with the operating system for formatting a floppy disk.
- Is BIOS configuration correct?
 - The floppy disk drive may be disabled with the BIOS setup utility of the server. Check the setting with the BIOS setup utility.
<Menus to check:
[Main] - [Legacy Floppy A]
[Security] - [Floppy Write Protect]>
- Is the server in the Secure Mode?
 - In the Secure Mode, write access to the floppy disk may be disabled. To release the Secure Mode, enter the password specified with the BIOS setup utility.

Fail to access to the CD-ROM:

- Is the CD-ROM properly set in the CD-ROM drive tray?
 - The tray is provided with a holder to secure the CD-ROM. Make sure that the CD-ROM is placed properly in the holder.
- Is the CD-ROM applicable to the server?
 - A CD-ROM for Macintosh is not available for use.

Fail to access to the CD-R disk:

- Is the mounting surface correct?
 - Take out the CD-R disk from the tray, and then set it again with its labelled surface upward.
- Is there any soil or crack on CD-R disk?
 - Make sure there is no soil due to fingerprint or others on the disk surface. Also make sure that there is no crack on the disk surface. Clean the disk surface if it is soiled.
If read-out still fails, set another disk of which data has been successfully read out to check if the drive can read the disk.
- Is the CD-R disk closed?
 - Close the session or set the disk in closed status, and try to read again.
- Are the CD-R disk and writing software appropriate to the disk drive?
 - The CD-ROM drive of the server may fail if the combination of disk drive, writing software, and CD-R is not correct.

Inserted the correct CD-ROM but the message like the following is displayed:

The CD-ROM is not inserted or the wrong CD-ROM is inserted.
Please insert the correct CD-ROM.
OK

- Is the data side of the CD-ROM dirty or scratched?
 - Take the CD-ROM out of the CD-ROM drive, confirm that it is not dirty or injured, reset and click [OK].

Fail to access the hard disk:

(Refer to the documentation supplied with the disk array controller.)

- Is the hard disk applicable to the server?
 - Operation of any device that is not authorized by us is not guaranteed.
- Is the hard disk properly installed?
 - Make sure to lock the hard disk with the lever on its handle. The hard disk is not connected to the internal connector when it is not completely installed (see Chapter 9).

Fail to access the (internal or external) SCSI devices:

- Is the SCSI device applicable to the server?
 - Operation of any SCSI device that is not authorized by us is not guaranteed.
- Is the cable connection changed?
 - The SCSI connector (B) on the I/O board in the machine can be used for either built-in file devices or external SCSI devices. The connection to external devices must be switched by modifying cable connection properly.
- Are SCSI devices properly configured?
 - When the server has external SCSI devices connected, device settings, including SCSI ID and terminator, are required. Refer to the manual that comes with the SCSI device for details.
- Are the SCSI controllers (including optional controllers) properly configured?
 - Use the BIOS setup utility for proper configuration of SCSI devices connected to the SCSI connector on the I/O board. When the server has an optional SCSI controller installed and SCSI devices connected to it, use the BIOS setup utility that comes with the optional SCSI controller for proper configuration. See the manual that comes with the optional SCSI controller for details.

Problems with Windows Server 2003 x64 Editions

There are some cases that an event log is registered as follows when you install Windows Server 2003 x64 Editions.

Source: DCOM

Category Error

Event ID 10016

Description: The application-specific permission settings do not grant Local Activation permission for the COM server application with CLSID {555F3418-D99E-4E51-800A-6E89CFD8B1D7} to the user {NT AUTHORITY\LOCAL SERVICE} SID {S-1-5-19}.

This security permission can be modified using the component Services administrative tool.

→ It is not a problem in operating the system.

Problems with Windows Server 2003 and Windows 2000

Cannot install the operating system correctly.

- Did you confirm the notes on installing the operating system?
→ See Chapter 6.

During Windows 2000 installation, the following warning is registered in the System Log of the Event Viewer:

Error detected on the device \Device\CdRom0 during the paging operation.
--

→ There is no problem on this issue.

Fail to start the operating system:

- Is a floppy disk in the floppy disk drive?
→ Take out the floppy disk and restart the server.
- Is the EXPRESSBUILDER CD-ROM in the CD-ROM drive?
→ Take out the EXPRESSBUILDER CD-ROM and restart the server.
- Is the operating system broken?
→ Use recovery process to recover the system.
(See "Recovery for Windows 2000" in this Chapter.)

The event log after every logon to Windows 2000 includes the following error log:

Description (D) The CPUs in this multiprocessor system are not all the same revision level. To use all processors the operating system restricts itself to the features of the least capable processor in the system. Should problems occur with this system, contact the CPU manufacture to see if this mix of processors is supported.

- Has the processor been expanded?
→ If different revisions (steppings) of the processors are installed in a multiprocessor system, Windows 2000 logs the above information every startup. If this message is logged, it is no problem for operation.

The operating system presents unstable operation:

- Did you update the system?
→ Installing a network drive after installation of the operating system may cause unstable operation. Use the EXPRESSBUILDER CD-ROM to update the system. (See Chapter 6.)

When any trouble occurred, the system does not run according to the specification of "Restart automatically":

→ When any trouble occurred on Windows 2000, the system may not restart automatically even if "Restart automatically" is specified. In such case, restart the system manually.

Cannot turn the power OFF at the blue screen:

- If you want to turn off the power at the blue screen, execute forced power off (forced shut down: continue to press POWER switch for 4 seconds). The power will not be turned off if you press the switch just one time.

The server is not found on the network:

- Is the LAN cable connected?
 - Make sure to connect the LAN cable to the network port on the rear of the server. Also make sure that the LAN cable to use conforms to the network interface standard.
- Is BIOS configuration correct?
 - The internal LAN controller may be disabled with the BIOS setup utility of the server. Check the setting with the BIOS setup utility.
 - <Menus to check:
 - [Advanced] - [PCI Configuration] - [Embedded NIC 1], [Embedded NIC 2]>
- Have the protocol and service already be configured?
 - Install the distinctive network driver for the server. Make sure that the protocol, such as TCP/IP, and services are properly specified.
- Is the transfer speed correct?
 - Open the network property dialog box in control panel to specify the "Link Speed & Duplex" value the same as the value specified for the HUB.

The processor name displayed in [General] tab of [System Property] is not in correct position.

- There is no problem for operation.

The system displays the message below and fails to log in.

- In Windows Server 2003, the following message will be displayed if you use the operating system without executing the license authentication. Select "Yes", and execute the procedure for license authentication.

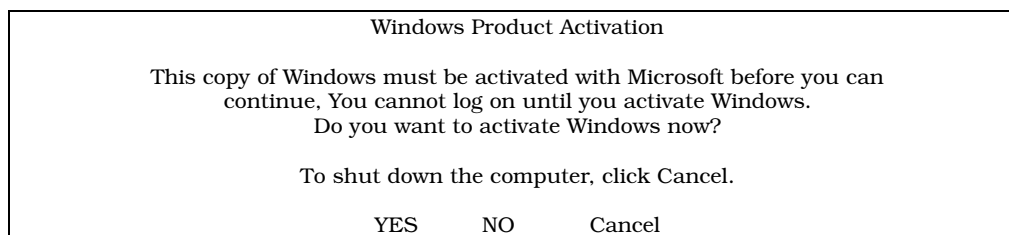
**Unable to update the system:**

- Are you trying to update the system without applying Service Pack or with Service Pack 1, 2, or 3?
 - Without applying Service Pack and applying Service Pack 1, 2, or 3 to this system are not supported. You have to apply Service Pack 4 to update the system. If you use Windows 2000 CD-ROM which includes Service Pack 4 to install Windows 2000 on your system, you do not have to apply Service Pack 4 again when you update the system.

About System Log when re-starting the system on Windows Server 2003

Type: Warning
Source: E100B
Event ID: 4
Description: Adapter Intel(R) PRO/100 Network Connection: Adapter Link Down

→ When re-starting the system without connecting the network cable, this log may be found in system event log.

But this has no effect on the behaviour of LAN driver.

Confirm that the system is connected with the LAN cable properly.

If 100Base LAN port is not used, disable 100Base LAN on device manager or disable it on BIOS configuration. Then, the log will not be registered.

Event logs in using SNMP Service in Windows Server 2003

Event Type: Warning
Event Source: EvntAgnt
Event Category: None
Event ID: 1015
Description: TraceLevel parameter not located in registry;
Default trace level used is 32.

Event Type: Warning
Event Source: EvntAgnt
Event Category: None
Event ID: 1003
Description: TraceFileName parameter not located in registry;
Default trace file used is .

→ The system will not be affected by these event logs. SNMP will not be affected either, so that you can ignore these logs.

A PCI board is not recognized.

- Is the PCI board installed correctly?
→ Confirm that the PCI board is installed in the slot correctly.
- Is the proper IRQ assigned for the board?
→ Assign the proper IRQ by referring to Chapter 4.
- Is "Disabled" specified in [Option ROM] for the slot to install SCSI card (excluding the array board used for operating system boot)?
→ Check the settings with the BIOS setup utility.
<Menus to check: [Advanced] - [PCI Configuration] - [PCI Slot n] (n: PCI slot number of installed board) - [Option ROM Scan]>
- Is "Disabled" specified in [Option ROM] for the slot for added network board which is not used for network boot?
→ Check the settings with the BIOS setup utility.
<Menus to check: [Advanced] - [PCI Configuration] - [PCI Slot n] (n: PCI slot number of installed board) - [Option ROM Scan]>

PCI hot-plug fails:

- Is BIOS configuration correct?
 - You must change the BIOS configuration to use the PCI hot-plug feature.
 - <Menus to check: [Advanced] - [PCI Configuration] - [Hot Plug PCI Control] - [Minimum/Middle/Maximum*]>
 - * Setting value depends on the board to be installed. See Chapter 4 for details.
 - <Menus to check: [Advanced] - [PCI Configuration] - [Hot Plug PCI Control] - [Empty Bus Default Speed] - [PCI Slots 5-6] or [PCI Slots 7-8] - Transfer speed of the board to be installed>

The driver of a PCI board cannot be stopped from the operating system when Hot Remove or Hot Replace is executed for the PCI board:

- Is another software application using the PCI board for which Hot Remove or Hot Replace is to be executed?
 - If another software application is using the PCI board for which Hot Remove or Hot Replace is to be executed, the driver of the PCI board cannot be stopped.
Terminate the software, then stop the driver of the PCI board. If executing Hot Replace, restart the software after having mounted a new PCI board.

Problems with EXPRESSBUILDER

When the server is not booted from the EXPRESSBUILDER CD-ROM, check the following:

- Did you insert the EXPRESSBUILDER CD-ROM during POST and restart the server?
 - If you do not insert the EXPRESSBUILDER CD-ROM during POST and restart the server, an error message will appear or the operating system will boot.
- Is BIOS configuration correct?
 - The boot device order may be specified with the BIOS setup utility of the server. Use the BIOS setup utility to change the boot device order to boot the system from the CD-ROM drive first.
 - <Menu to check: [Boot]>
- Is an error message appeared?
 - When an error occurs while EXPRESSBUILDER is in progress, one of the following messages appears.

After this message appears, check the error and take the appropriate corrective action according to the message listed in the table below.

Message	Cause and Remedy
This machine is not supported.	This EXPRESSBUILDER version is not designed for this server. Execute EXPRESSBUILDER on the compliant server.
NVRAM access error.	An access to the non-volatile memory (NVRAM) is not acceptable.
Hard disk access error.	The hard disk is not connected or it is failed. Check whether the hard disk is correctly connected.
The system-specific information does not exist on the I/O board. Please restore the backup data or write the data by using [System Information Management] of the Off-line Maintenance Utility. Only the authorized personnel are allowed to do this operation.	The system-specific information cannot be acquired in the I/O board exchange and so on.

Problems with Express Setup

Express Setup can not be used

- Express Setup does not support the installation of Microsoft Windows Server 2003 x64 Editions. If you want to perform re-setup, see Appendix D and perform "Manual Setup".

Following message appeared when you tried to install Express Setup to the hard disk that has smaller capacity than the specified partition size:

The specified partition size has exceeded the capacity of the hard disk.
 The setup created the partition at the maximum size that can be reserved on the hard disk.
 Setup will continue the process.
 OK

- It is not an abnormal condition. Press **Enter** to continue the installation.

The message can not be displayed correctly when copying the files from CD-ROM or checking CD-ROM:

- Press **R**. When any messages appear again even if you press **R**, restart the Express Setup from the beginning. In case the same result occurred after the restart of installation, contact your service representative and ask them to check the CD-ROM drive.

Express Setup terminated and asks to input setup information.

- There are some errors on the specified setup information. Follow the instruction to input the correct value. It is not necessary to cancel the installation. On Windows 2000, you might be asked to press Enter again after the last reboot of the setup.

[Complete] appears on the [Role of Computer] screen.

- If you click [Complete] here, the setup will select the default value of Express Setup for the later specification to continue the process.

<The Default Value for Windows 2000>

The specification of network protocol

Protocol : TCP/IP[DHCP Specified]
 Service : Select sharing Microsoft network files and printer.
 Client : Microsoft network client.
 Component : SNMP, IIS (Excluding Professional/Windows Server 2003)
 Application : ESMPRO Agent
 Power Console Plus (When disk array system)

[Complete] does not appear on [Role of Computer] screen.

- [Complete] does not appear if the setup information file that has already been created is loaded.
- [Complete] appears only when you first entered the [Role of Computer] screen. Once you go to the next screen from [Role of Computer], the [Complete] will not appear even if you enter [Back] to go back to the [Role of Computer] screen.

Select [Use Existing Array] at [New/Existing RAID Configuration], but the operating system is installed in the whole area of the disk.

- Is there any other partition than the partition to re-use (excluding maintenance area)? If no other partition than the one to re-use exist, the setup will reserve the whole area of the disk to install Windows 2000.

Specified to join the Domain, but the system is installed as Workgroup.

- When the setup fails to join the Domain during the installation, it will install the system as Workgroup. Open [System] in Control Panel to specify joining the Domain.

Specified large value as partition size, but when Windows 2000 is actually started, the system partition is created by 4095 MB.

- Is the [Partition Size] specified by the value larger than the real area? If you want to create one partition in all area of the hard disk (excluding the maintenance area) to install the operating system, specify [All Area].

Windows 2000 started with different display resolution from the specified value.

- If the specified display resolution can not be used, the system will use the nearest value or the default value of the driver.

Entered the incorrect Product ID/CD key.

- Even if you entered the incorrect Product ID/CD key, Express Setup will start. However, the setup will stop and asks you to re-enter the correct value. Also in this case, input request will occur when rebooting after GUI setup completed during Express Setup. If these 2 inputs are done correctly, there is no problem on Windows 2000 setup.

Unable to specify the details of network adapter.

- In Express Setup, you can not specify the details of Network adapter. Specify them from Control Panel after starting Windows 2000.

Windows 2000 is started with network adapter that has not been specified during Express Setup

- Windows 2000 will install the recognized network adapter specified as default value. If you want to modify the specification, it can be done from Control Panel after starting Windows 2000. Also, a network adapter that has been specified during Express Setup but is not connected will not be setup, though the protocol will only be installed.

Connected more than two network adapters and specified a different protocol for each adapter, but all the protocols are specified on either adapter.

- It's a design. Each adapter is specified so that all the installed protocols can be used. The values that cannot be specified during Express Setup will all be specified by default value.

When more than two network adapters are specified, the detailed specification of TCP/IP protocol are all set to use DHCP.

- When more than two network adapters are specified, the detailed specification of the protocol may all be set by default value. Re-specify the details from Control Panel.

Not more than two network adapters are connected, but the detailed specification of the protocol are all set by default. (e.g. Specified IP Address on TCP/IP, but DHCP is specified)

- Are you specifying more than two protocols?
In this case, the situation will be the same as connecting more than two Network adapter, so the detailed specification of the protocol are all set by default.
Re-specify the details from Control Panel after starting the operating system.

Changed the giga driver speed from 1000M bps to 100M bps. But the changed speed is not properly displayed in Network Details of ESMPRO data viewer (still 1000M bps is indicated):

→ It does not affect the operation of LAN driver.

Setup is interrupted at "Creating a working partition" process during the Express Setup.

- Did you connect the hard disk drive that operating system is not going to be installed on?
→ Disconnect the hard disk drive that operating system is not going to be installed on, and perform the Express Setup.

Error Message during Disk Array Configuration

Refer to the manual that comes with the disk array controller for any trouble occurred on disk array in this system.

The operating system cannot be installed:

- Is configuration of the disk array controller performed?
→ Perform configuration properly by using MegaRAID Configuration Utility.

The operating system cannot be started:

- Is the BIOS setting for the disk array controller changed?
→ Set it properly by using MegaRAID Configuration Utility.
- Does POST recognize the disk array controller?
→ Check that the disk array controller is connected correctly and then turn the power ON.
→ When the disk array is connected correctly but is not recognized, it may be faulty. Contact the maintenance service agent that you are contracted with or the dealer that you purchased this controller from.

Rebuilding cannot be performed:

- Is the capacity of the hard disk to be rebuilt insufficient?
→ Use a hard disk of the same capacity as the faulty one.
- Is the RAID configuration RAID0?
→ RAID0 does not have redundancy thus rebuilding cannot be performed. Replace the "DEAD" hard disk, create configuration information again, perform initialization and then restore using the backup data.

Auto-rebuild cannot be performed:

- Is the interval enough when hot swap are executed?
→ Take interval more than 90 seconds when hot swap are executed.
- Is the BIOS setting for the disk array controller correct?
→ Check the BIOS setting for disk array controller by using MegaRAID Configuration Utility. Select "Objects" → "Adapter" → "Auto Rebuild" from the TOP menu.

A hard disk goes into "FAIL" status:

- Contact the maintenance service agent that you are contracted with or the dealer that you purchased it from.

Problems with Master Control Menu

The master control menu fails to appear:

- Is your system Windows NT 4.0 or later, or Windows 95 or later?
→ The Master Control menu is supported by Windows NT 4.0 and Windows 95.
- Is **Shift** pressed?
→ Setting the CD-ROM with **Shift** pressed down cancels the Autorun feature.
- Is the system in the proper state?
→ The menu may not appear depending on the system registry setting or the timing to set the CD-ROM. In such a case, start the Explorer and run \MC\1ST.EXE in the CD-ROM.

Problems with Configuration Diskette Creator

<Common to Windows 2000>

The bit map of the Configuration Diskette Creator window is not displayed correctly during setting of setup information. (When the Trekking command is used)

- If the specified number of colours is fewer than 256 in the display setting, the bit map is not displayed correctly, but the setup information can be displayed correctly.

The Point to Point tunnelling protocol cannot be set.

- The protocol is not supported at present. After installation, set the protocol through Control Panel. In this case, rebooting is not necessary.

The details of a network adapter cannot be set.

- Configuration Diskette Creator is unable to set the details of network adapters. Start Windows 2000, and set the details through Control Panel.

COLLECTING EVENT LOG

This section describes how to collect the log of various events that occurred on the server.

IMPORTANT: If STOP error, system error, or stall occurred, follow the procedure below after restarting the system.

NOTE: Different revisions of processors may be mixed in the additional processor kit. When Windows 2000 is used, following message may be appeared in the System Log of the Event Viewer after extension of different revisions of two or more processors in the Express server. If this message is logged, it is no problem for operation.

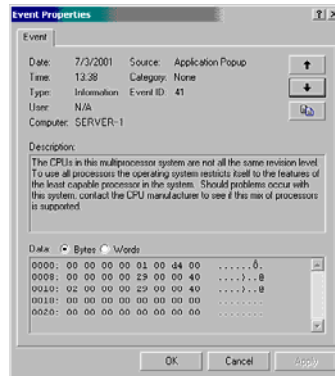

1. Click [Management Tool] → [Event Viewer] from the Control Panel.
2. Select the type of the log to collect.
On [Application Log], the events related to the running application are archived. On [Security Log], the events related to the security are archived. On [System Log], the events occurred at the item which configures Windows 2000 system are archived.
3. Click [Save as...] in the [Run] menu.
4. Type the file name of archived log in the [File Name] box.
5. Select the type of the log file you want to save in the [File Type] list box and click [OK].

For more information, refer to Windows 2000 Online Help.

COLLECT CONFIGURATION INFORMATION

This section describes how to collect the information on hardware configuration and inside specification.

In order to collect information, "Diagnostic Program" is used.

IMPORTANT: If STOP error, system error, or stall occurred, follow the procedure below after restarting the system.

1. Point to [Settings] in Start menu, and click [Control Panel].
The [Control Panel] dialog box appears.
2. Double-click [Management Tool], and double-click [Computer Management].
The [Computer Management] dialog box appears.
3. Click [System Tool] → [System Information].
4. Click [Save as System Information File] in the [Operation] menu.
5. Type the file name to save in the [File Name] box.
6. Click [Save].

COLLECTING DR. WATSON DIAGNOSTIC INFORMATION

Dr. Watson collects diagnostic information related to application errors. The location to save the information can be specified as you like. For more information, refer to Chapter 5.

MEMORY DUMP

If an error occurs, the dump file should be saved to acquire necessary information.

If you saved the dump to DAT, write down that it is saved as "NTBackup" or "ARCServe" on the label. You can specify the location to save the diagnostic information as you like. For more information, refer to "Specifying Memory Dump (Debug Information (refer to Chapter 5 for detail))".

IMPORTANT:

- Contact your service representative before dumping the memory. Dumping the memory while the server is in the successful operation may affect the system operation.
 - Restarting the system due to an error may display a message indicating insufficient virtual memory. Ignore this message and proceed. Restarting the system may result in dumping improper data.
-

Preparing for Memory Dumping

Memory dumping with the DUMP switch may disable the server to restart. In such a case, it is required to force the server to shut down. This forced shutdown, however, is not available if "Enable" is selected for "Power Switch Inhibit" on the Security menu of the BIOS setup utility, because this setting disables POWER switch operation.

Follow the procedure below to change the setting to enable the forced shutdown and restart of the server.

1. Power on the server and start the BIOS setup utility.
2. Select "Disable" for "Power Switch Inhibit" in the Security menu.
3. Save the configuration data and exit the SETUP.

Saving the Dump File

Press the DUMP switch to save the dump file when an error occurs. Insert a metal pin (a straightened large paper clip will make a substitute) into the switch hole to press the DUMP switch.

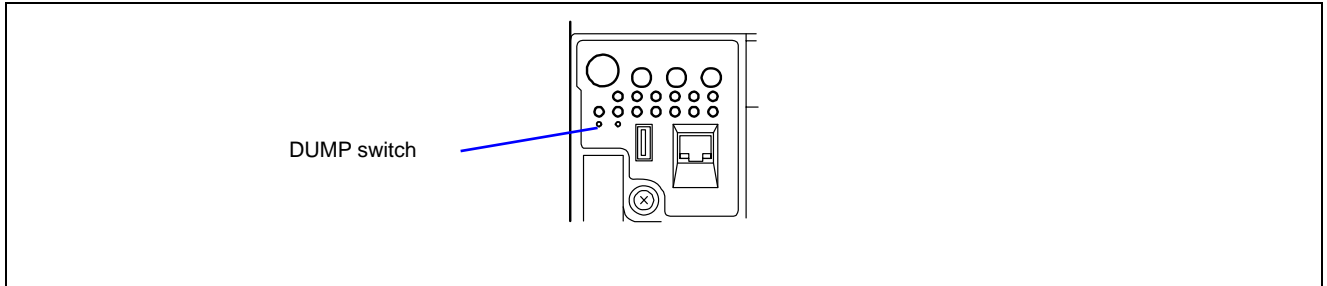

Pressing the DUMP switch saves the dump file in the specified directory. (Memory dumping may not be available when the processor stalls.)

IMPORTANT: Do not use a toothpick or plastic stick that is easy to break. Use a pin having the length of 1 inch (25 mm) or longer.

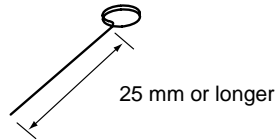

RECOVERY FOR Windows 2000 SYSTEM

If any file necessary for running the operating system is damaged, use the following procedures to recover the system.

IMPORTANT:

- After recovering the system, see "Updating the System" in Chapter 5 and be sure to update the system.
Also on Windows 2000, you need to update all the drivers after the system update. For more information, see "Installing and Setting Device Drivers" in Chapter 5.
 - If the hard disk can not be recognised, you can not recover the system.
-

Follow the procedure below and use the information in the disk, not system recovery disk, to recover the system.

1. Turn on the power of the system.
2. Insert Windows 2000 CD-ROM into the CD-ROM drive of your server.
3. Press the RESET switch or press **Ctrl, Alt, and Delete** to reboot the server. (You may also turn off and then on again to reboot the server.)
4. Press **F6** while the message "Setup is inspecting your computer's hardware configuration..." is displayed at the upper part of the screen.

NOTE: Nothing is changed on the screen when **F6** is pressed.

5. Press **S** when the following message appears:

Setup could not determine the type of one or more mass storage devices installed in your system, or you have chosen to manually specify an adapter.
Currently, Setup will load support for the following mass storage device(s).

Select [Other] and press **Enter**.

6. Insert Windows 2000 OEM-DISK for EXPRESSBUILDER into the floppy disk drive and press **Enter**.

Please insert the disk labeled
manufacturer-supplied hardware support disk
into Drive A:
* Press ENTER when ready.

Select the [LSI MEGARAID Products for Windows 2000] and press **Enter**.

7. Press **R** to select the recovery option.
8. If you are requested, press **R** to select system recovery procedure.
9. If you are requested, select either of the procedure below:

[Manual Recovery] (Press **M**)

Do not select this option unless you are a high-level user or a system administrator. If you use this option, you can recover the problems of system files, partition boot sector, and start-up environment.

[Quick Recovery] (Press **F**)

This option is very easy to use and the user does not need to do anything during the procedure. If you select this option, the system recovery disk program starts to recover the problems concerning system files, partition boot sector of system disk, and start-up environment (if multiple operating systems are installed on the system).

10. Follow the on-screen instructions, and then press **L** at the screen which request you to insert system recovery disk. The system will be restarted once.

NOTE: Start the procedure without system recovery disk.

11. Repeat steps 4 to 9.

The recovery procedure will be started.

During the recovery, the missing files and the damaged files are replaced either to the files in C:\I386 folder of hard disk or the files in systemroot\Repair of the system partition. These replaced files do not reflect the changes of the configuration after the setup at all.

12. Follow the instruction displayed on the screen.

If you take a note of any file name in which trouble is detected during the procedure, it is useful to diagnose how the system has been damaged.

13. Terminates the procedure if the recovery is successful.

You can verify that the replaced files are correctly copied to the hard disk if the computer is restarted normally.

OFF-LINE MAINTENANCE UTILITY

The Off-line Maintenance Utility is an operating system independent maintenance program. When you are unable to start the operating system dependent ESMPRO to troubleshoot a problem, the Off-line Maintenance Utility can be used.

IMPORTANT:

- The Off-line Maintenance Utility is intended for use by your service representative. The EXPRESSBUILDER CD-ROM and the Off-line Maintenance Utility Bootable floppy disk you have created contain a file that describes operation of the utility, but do not attempt to use the utility by yourself. Contact your service representative and follow instructions.
- Starting the Off-line Maintenance Utility disables any access from a client to the server.

Starting the Off-line Maintenance Utility

The Off-line Maintenance Utility may be started in the following ways.

- From the CD-ROM

Insert the EXPRESSBUILDER CD-ROM in the CD-ROM drive and reboot the system.

After the menu is displayed on the screen, select "Tools" - "Off-line Maintenance Utility".

The Off-line Maintenance Utility program starts from the CD-ROM.

- From the floppy disk

Insert the Off-line Maintenance Utility Bootable floppy disk in the floppy disk drive and reboot the system.

The Off-line Maintenance Utility program starts from the boot disk.

The Off-line Maintenance Utility Bootable floppy disk is created by selecting "Tools" - "Create Support FD" on the EXPRESSBUILDER.

- Manual start (by pressing **F4**)

When the Off-line Maintenance Utility is installed, press **F4** while the start-up screen of the server is on screen. The Off-line Maintenance Utility starts from the hard disk.

Features of Off-line Maintenance Utility

The Off-line Maintenance Utility provides the following features. (Available features vary depending on the way you started the Off-line Maintenance Utility.)

IMPORTANT: See the on-line help for details of the Off-line Maintenance Utility. For further information, ask your service representative.

- IPMI Information Viewer

Provides the functions to view the system event log (SEL), sensor data record (SDR), and field replaceable unit (FRU) and to make a backup copy of them.

Using this feature, you can find system errors and events to determine a maintenance part.

- BIOS Setup Viewer

Provides the functions to export the current configuration data defined with the Setup utility to a text file.

- System Information Viewer

Provides the functions to view information on the processor and the BIOS and export it to a text file.

- System Information Management

Provides the function to make a back-up copy of your data.

Without the backup data, the system-specific information and/or configuration may not be restored.

Only an authorised person is allowed to restore the backup data.

- Start of Utilities

With EXPRESSBUILDER, you can start the following utilities installed in the maintenance partition.

- System Management
- System Diagnostics
- Maintenance Partition Update

- Chassis Identify

This function can distinguish the machine with the lamp or buzzer of the machine.

This is convenient if you have to distinguish a machine among many machines on the rack.

RESETTING THE SERVER

- If the server halts before starting the operating system, press and hold **Ctrl** and **Alt** and press **Delete**. This restarts the server.
- Pressing the **RESET** switch on the front panel reboots the server.

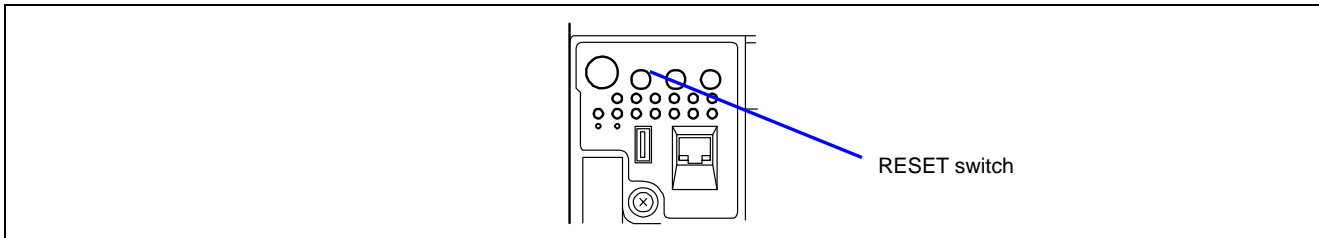

IMPORTANT: Resetting the server clears the DIMM memory and the data in process. To reset the server when it is not frozen, make sure that no processing is in progress.

FORCED SHUTDOWN

Use this function when an operating system command does not shut down the server, the **POWER** switch does not turn off the server, or resetting does not work.

Press and hold the **POWER** switch on the server for at least four seconds. The power is forcibly turned off. To turn on the power back again, wait approximately 10 seconds after turning off the power (forced shutdown).

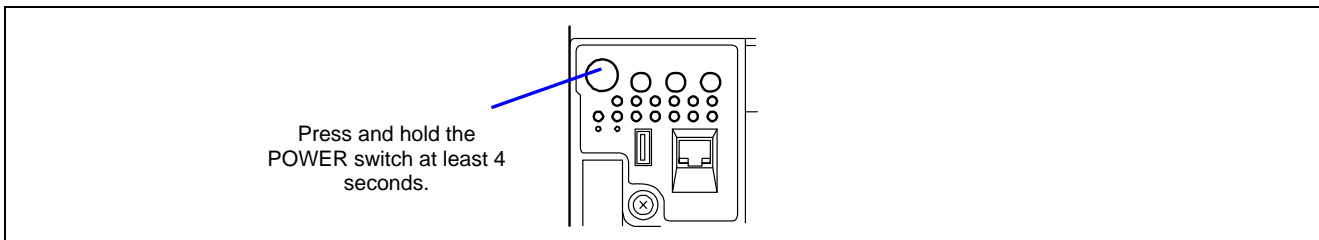

IMPORTANT: If the remote power-on function is used, cycle the power once to load the operating system, and turn off the power again in the normal way.

Chapter 9

Upgrading Your Server

This chapter describes internal optional devices available for the server, procedures for install or removing such optional devices, and notes on using them.

-
- **IMPORTANT:**
 - Optional devices described in this chapter may be installed or removed by any user. However, we do not assume any liability for damage to optional devices or the server or malfunctions of the server resulted from installation by the user. We recommend you ask your service representative for installing or removing any optional devices.
 - Make sure to use only optional devices and cables authorised by us. Repair of the server due to malfunctions, failures, or damage resulting from installing inappropriate devices or cables will be charged.
 - When you made any change to the hardware configuration, make sure to update the system (see Chapter 5 for details.).
-

SAFETY NOTES

Observe the following notes to install or remove optional devices safely and properly.

WARNING



Observe the following instructions to use the server safely. Failure to follow these instructions may result in death or serious personal injury. See pages 1-3 to 1-8 for details.

- Do not disassemble, repair, or alter the server.
- Do not look into the CD-ROM drive.
- Do not remove the lithium, Ni-CD, and/or NiMH battery.
- Disconnect the power plug before working with the server.

CAUTION



Observe the following instructions to use the server safely. Failure to follow these instructions may cause a fire, personal injury, or property damage. See pages 1-3 to 1-8 for details.

- Do not lift the server only by a single person.
- Make sure to complete board installation.
- Do not pinch your fingers with mechanical component.
- High temperature
- Put a connector cover on an unused connector.

ANTI-STATIC MEASURES

The server contains electronic components sensitive to static electricity. Avoid failures caused by static electricity when installing or removing any optional devices.

- Wear a wrist strap (an arm belt or anti-static glove).

Wear a wrist strap on your wrist. If no wrist strap is available, touch an unpainted metal part of the cabinet before touching a component to discharge static electricity from your body.

Touch a metal part regularly when working with components to discharge static electricity.

- Select a suitable work space.
 - Work with the server on an anti-static or concrete floor.
 - When you work with the server on a carpet where static electricity is likely to be generated, make sure take anti-static measures beforehand.
- Use a work table.

Place the server on an anti-static mat to work with it.
- Cloth
 - Do not wear a wool or synthetic cloth to work with the server.
 - Wear anti-static shoes to work with the server.
 - Take off any jewels (ring, bracelet, or wrist watch) before working with the server.
- Handling of components
 - Keep any component in an anti-static bag until you actually install it into the server.
 - Hold a component by its edge to avoid touching any terminals or components.
 - To store or carry any component, place it in an anti-static bag.

PREPARING FOR INSTALLATION AND REMOVAL

Follow the procedure below to prepare for installing or removing components.

1. Shut down the operating system.
2. Press the POWER switch to power off the server (the POWER/SLEEP lamp goes off).
3. Unplug the power cord from the AC inlet on the server
The AC Standby lamp on the front of the server goes off.
4. Remove all the cables connected to the server on the rear panel.
5. Make a clearance of 1m to 2m in the front and rear sides and left and right sides of the server.

NOTE: Make sure to disconnect the power cord from the outlet before installing or removing the option devices. If you remove the internal cable with the power cord being connected, the STATUS lamp will light in amber when the server is powered. Disconnect the power cord, connect it again, and then restart the server.

DEVICE INSTALLATION OR REMOVAL PROCEDURE

Install or remove a component from the server as follows.

3.5-inch Hard Disk Drive

The 3.5-inch device bay on the front of the server contains five slots in which hard disk drives can be installed. The device bay is not equipped with any hard disk drives (excluding when one or more built-in hard disk drives are ordered). Purchase additional hard disk drives if required.

IMPORTANT:

- Do not use any hard disk drives that are not authorised by us. Installing a third-party's hard disk drive may cause a failure of the server as well as the hard disk drive.
- The supported RAID level depends on the disk array controller to be used.
 - Onboard RAID:
RAID0, RAID1, and RAID5 (See "Disk Array Configuration" in this chapter.)
 - Optional disk array controller:
Refer to the manual that comes with the disk array controller. (If you purchased the board by BTO (built-to-order), the manual is provided with the server.)

All five slots may contain a hard disk drive approximately 25.4 mm (1 inch) high. The SCSI IDs ID0 through ID4 are always assigned to hard disk drives as shown below.

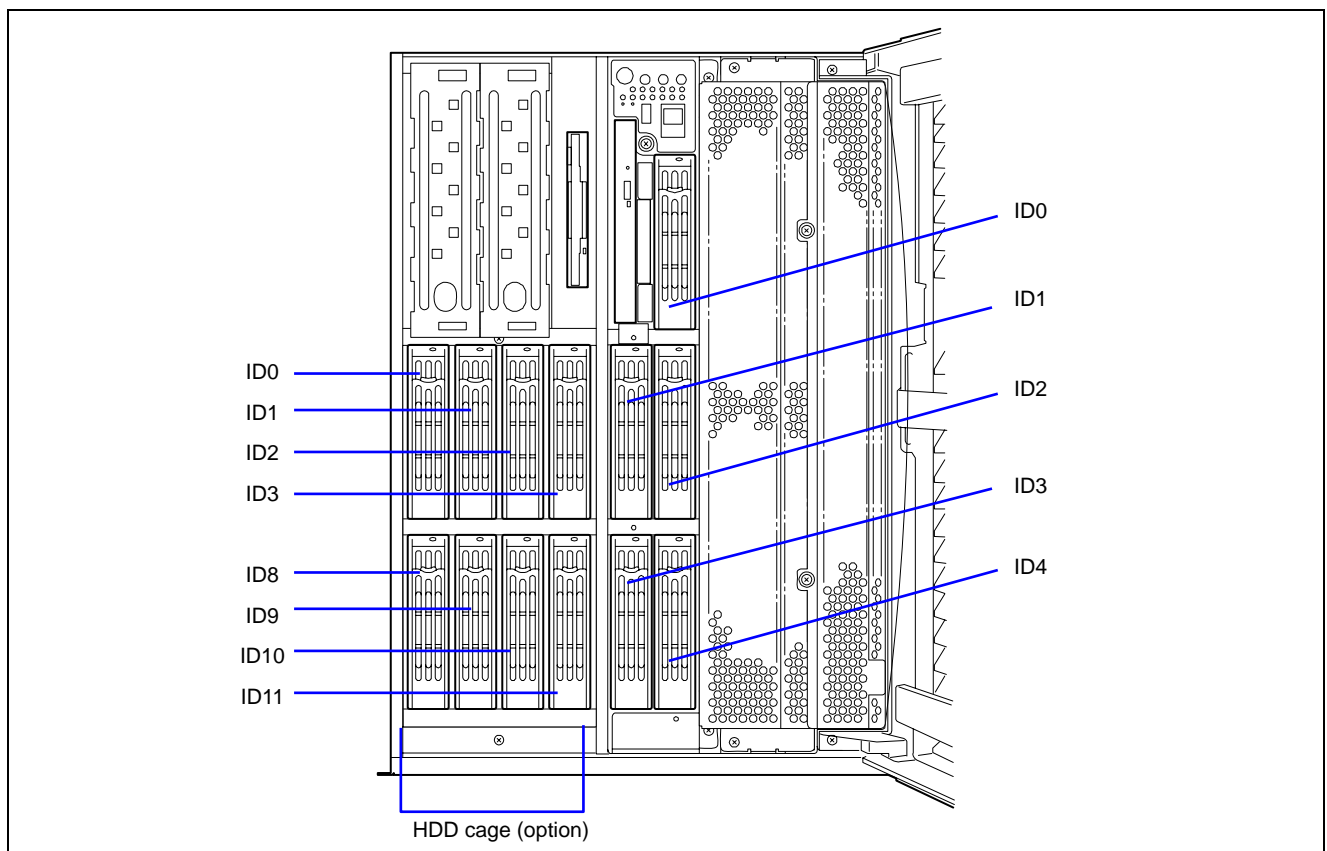

The 3.5-inch disk bay cable is connected between the SCSI (Ch-A) connector and the hard disk drives cage on the I/O board when the server is shipped.

To use the hard disk drives in a disk array configuration by using the on-board RAID controller, you do not need to

change cable connection. However, to use the hard disk drives in a disk array configuration using the optional RAID controller, you need to use a separately priced SCSI cable. Remove the cable that is connected between the SCSI Ch-A connector and the hard disk drives cage, and connect the separately priced SCSI cable to the connector between the hard disk drives cage and the disk array controller.

In the disk array configuration, use the same model of hard disk drives.

Installation

Install a hard disk drive as follows. This procedure applies to all the slots.

NOTE: In RAID1 or RAID5 configuration, the hard disk drive can be installed or removed while the server is being powered.

IMPORTANT: In a disk array configuration, use the same model of hard disk drives.

1. See the section "Preparing for Installation and Removal" described earlier to prepare (except for disk array configuration).
2. Unlock the front door with the security key, and open the front door.
3. Locate the slot in which you are going to install a hard disk drive.

The server has five slots. The SCSI IDs assigned to the slots are all determined (SCSI ID 0 to ID 4 from right to left).

4. Remove the empty drive carrier.

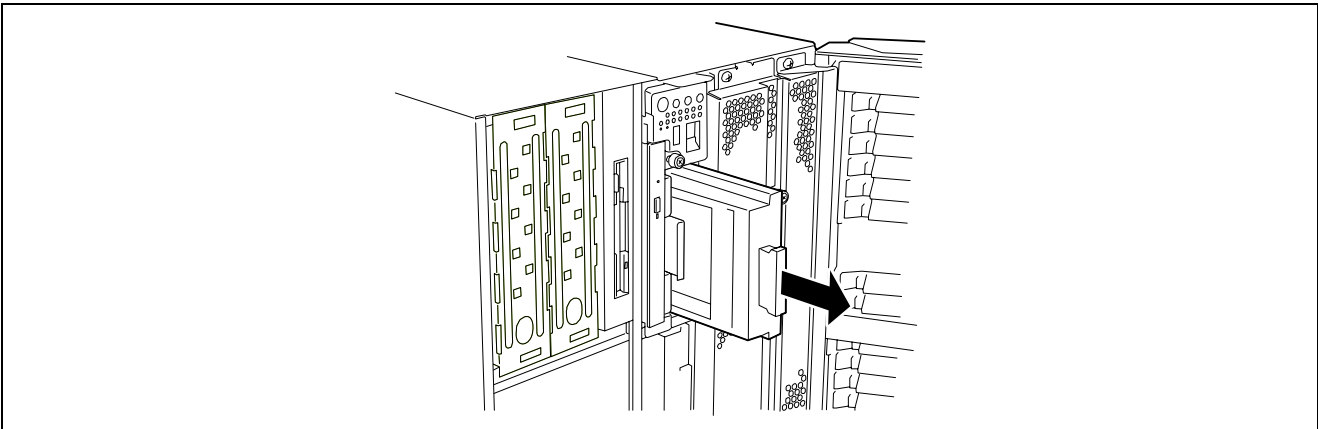

- Using the provided screws, secure the hard disk drive into the empty drive carrier.

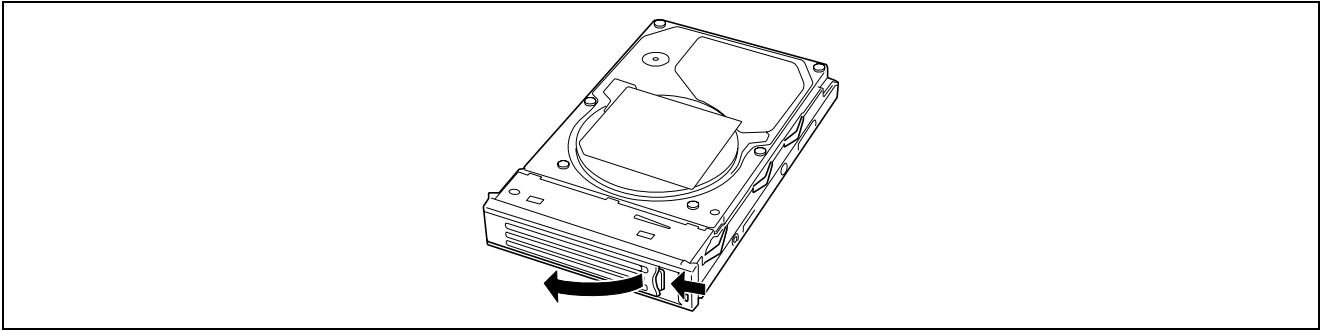

- Firmly hold the additional hard disk drive and handle, and insert it into the slot.

IMPORTANT:

- Push the hard disk drive until the handle hook hits the frame.
 - Carefully hold the hard disk drive with both hands.
-

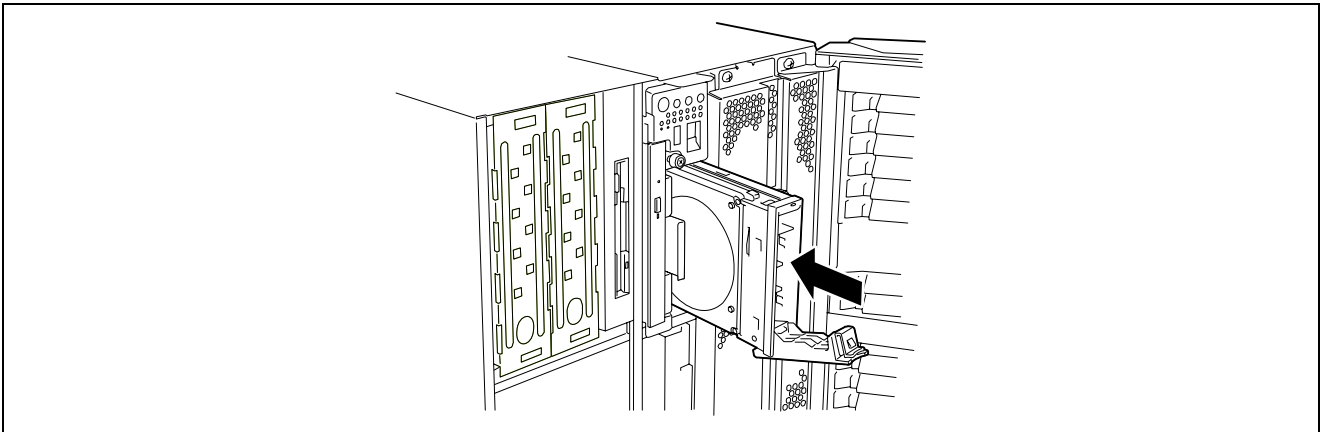

- Slowly close the handle.

The handle is locked when a "click" is heard.

NOTE: Make sure that the handle is hooked to the frame when having inserted the hard disk drive.

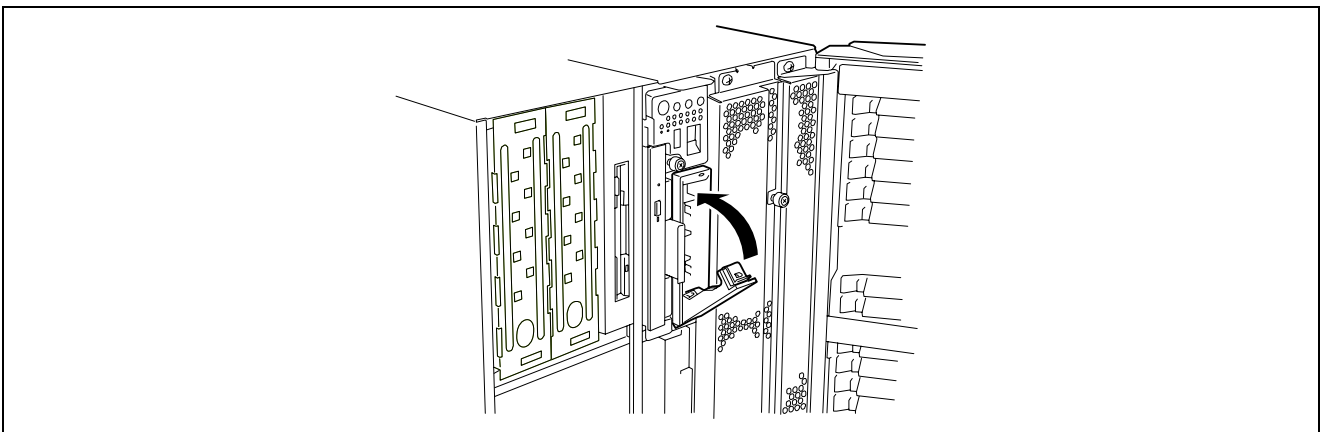

- Close the front door.

Removal

Remove a hard disk drive as follows. To use the server with the hard disk drive removed, insert an empty drive carrier into the empty slot.

1. Shutdown the system and press the POWER switch to turn off the power.
2. Unlock the hard disk drive.

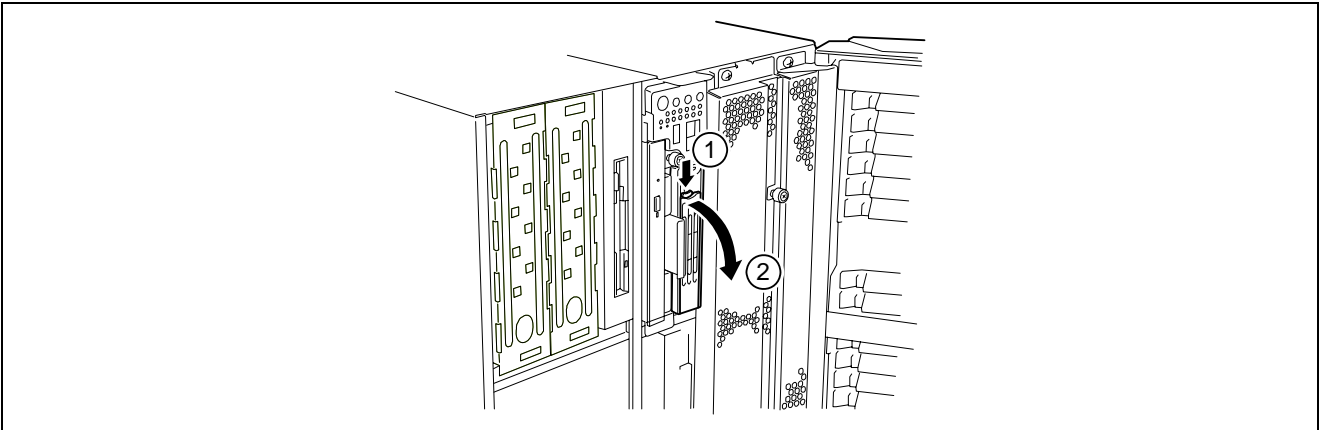

3. Firmly hold the hard disk drive and handle, then take them out.

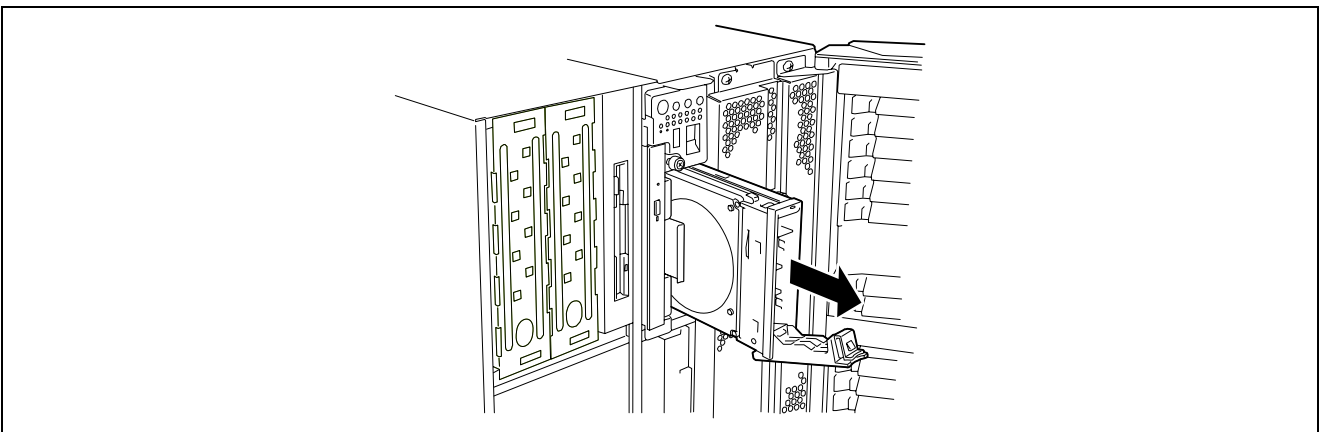

NOTE: If removing a failing hard disk drive, confirm the slot in which the DISK lamp of the hard disk drive is amber before starting the removal.

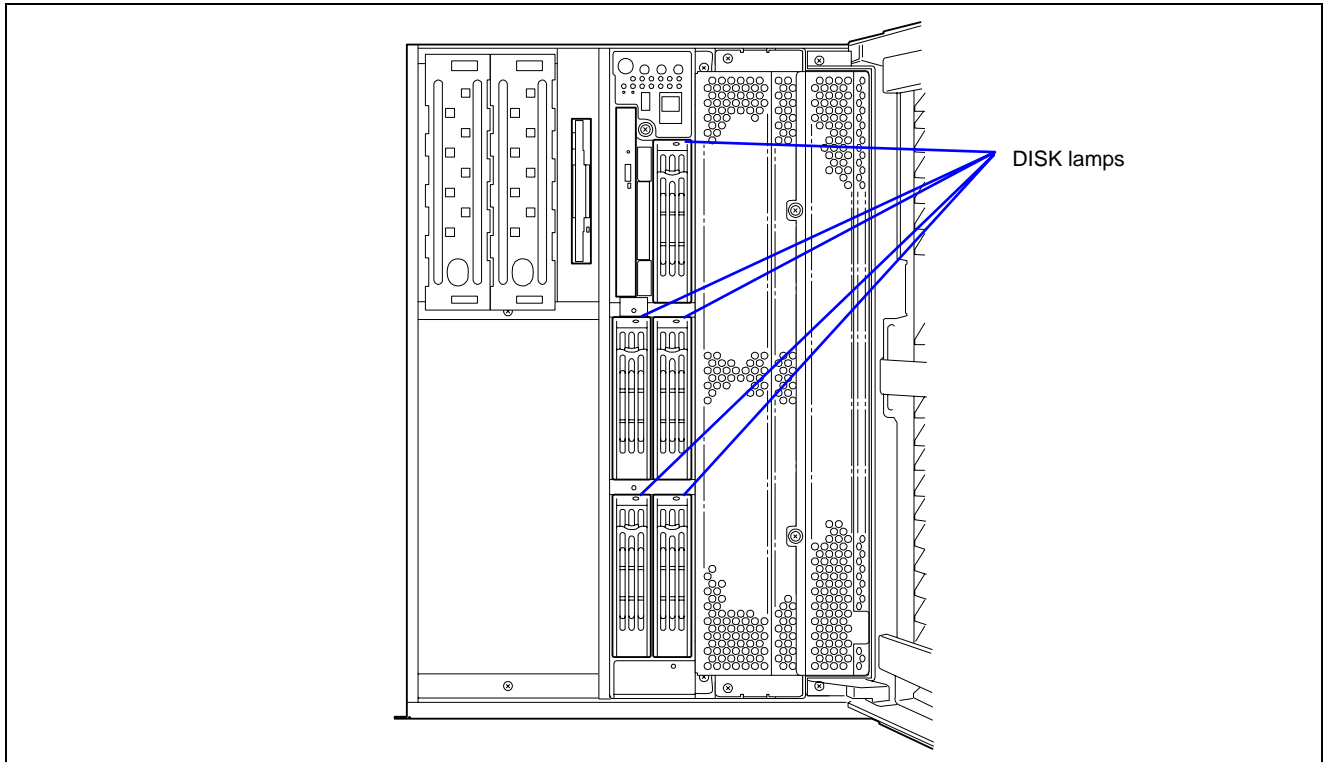

When the hard disk drives are in the disk array configuration, you can restore the state before an error using the auto-rebuild feature that stores the data in the old hard disk drive into a new one. The auto-rebuild feature may be enabled or disabled depending on the RAID level.

Auto-rebuild is automatically carried out when you hot-swap a failed hard disk drive with a new one (replace the disk while the server is powered). While auto-rebuild is in progress, the DISK lamp flashes green and amber alternatively to indicate it.

IMPORTANT: When auto-rebuild fails, the DISK lamp lights in amber. Remove and install the hard disk drive again to restart auto-rebuild. (If the disk array monitoring utility is installed, check the indication of the utility.)

Observe the following notes for auto-rebuild.

- Do not power off the server in the period between a hard disk drive error and completion of auto-rebuild.
- When you removed a hard disk drive, wait at least 90 seconds before installing the hard disk drive back again.
- Do not replace another hard disk drive while rebuilding is in progress. (The DISK lamp flashes green and amber alternatively while rebuilding the hard disk drive.)

Power Supply Unit

Even if one of three power supply units fails, the server can continue its operation without interruption when an additional power supply unit is installed (in the redundant configuration).

If the four power supply units are used, AC power can be divided into two lines with a pair of power supply units. With the AC power redundant configuration, the server can continue its operation without power interruption even if either of AC power line fails.

Installation

Install a power supply unit as follows:

1. See the section "Preparing for Installation and Removal" described earlier to prepare.
2. Remove the screw securing the blank cover.

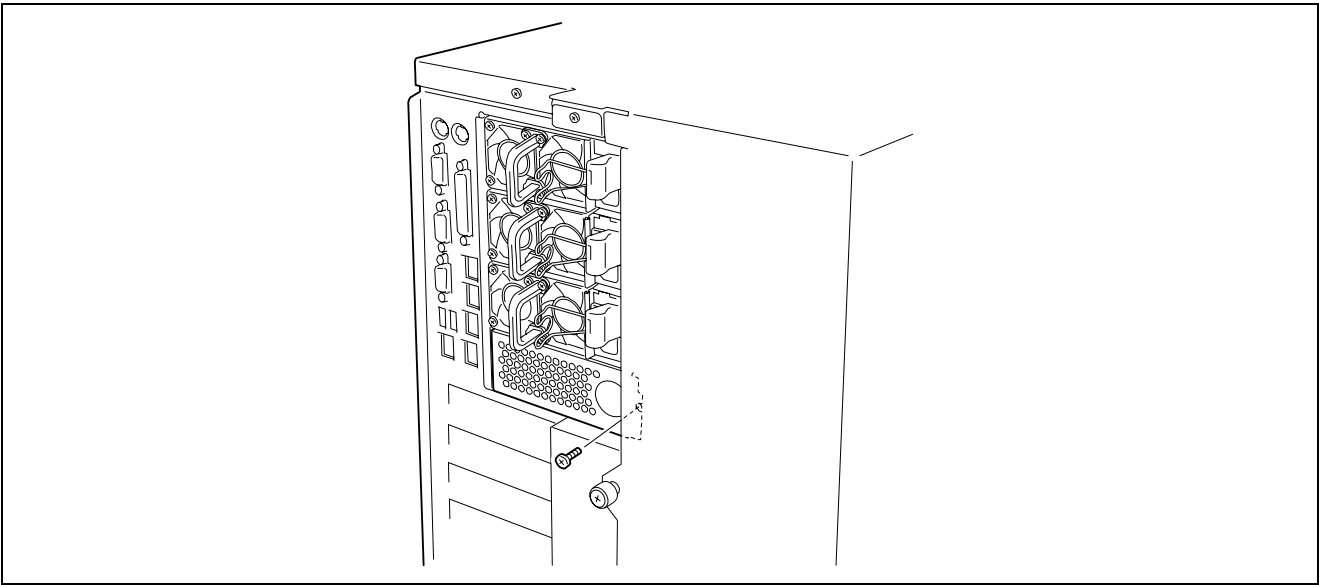

3. Remove the blank cover.

IMPORTANT: Keep the removed blank cover for future use.

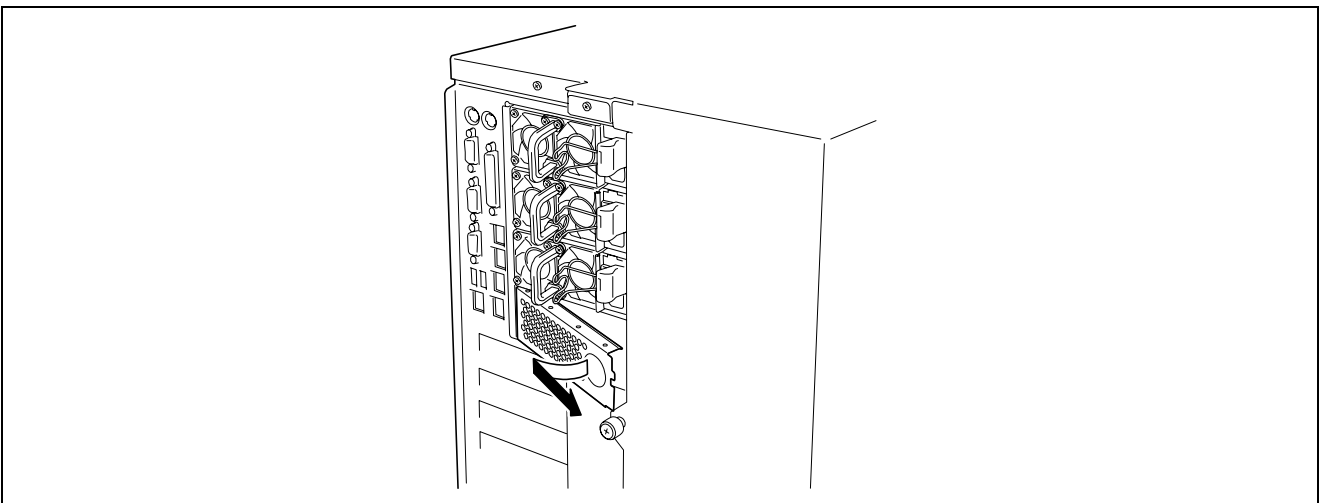

4. Insert the power supply unit into the slot.

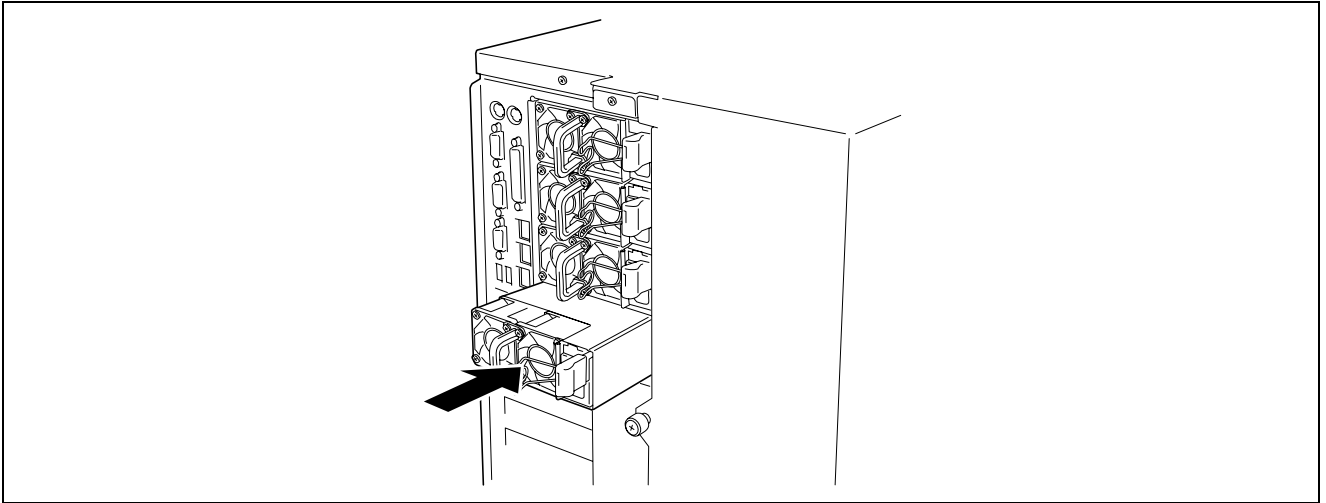

IMPORTANT: Be sure to push straight the power supply unit. To avoid damaging the power supply unit, do not tilt or twist the unit as you push it into the connector.

NOTE: Make sure that the power supply unit is pushed in to an end securely.

5. Connect two power cords to AC inlet.

Use the power cord provided with the power supply unit and the one provided with the optional unit.

IMPORTANT: A blank cover is attached to the slot for additional power supply unit. Keep the removed blank cover for future use.

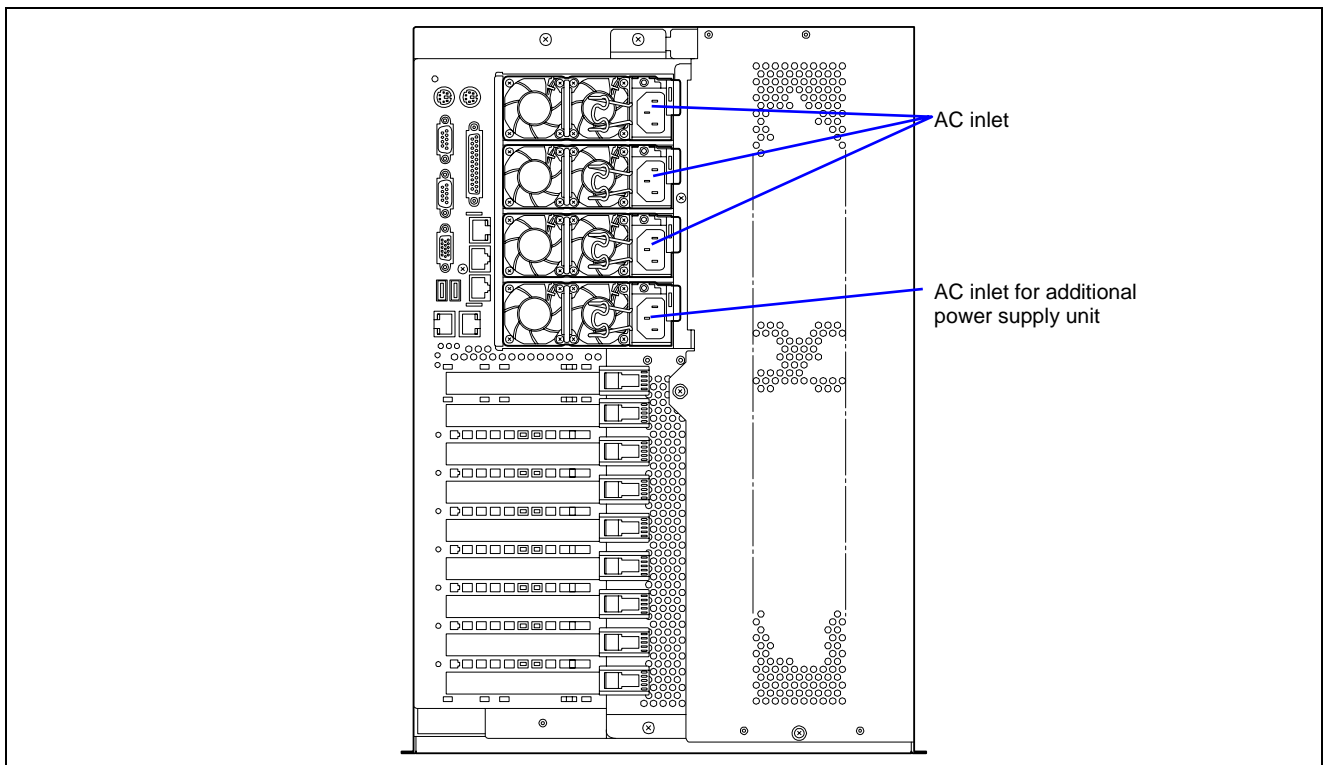

6. Power on the server.

The POWER lamp on the power supply units goes on.

7. Confirm, by the STATUS lamp or on the POST diagnostic screen, that there are no errors related to the power supply units.

See Chapter 8 for details on the error messages.

If the POWER lamps are off, reinstall the power supply units. If the POWER lamps are still off, contact your service representative.

Replacing a Failing Power Supply Unit

Replace only a failing power supply unit.

IMPORTANT: Do not remove a power supply unit operating normally.

NOTE: If two power supply units work normally while the server contains three or four power supply units in a redundant configuration, the failing power supply unit can be replaced with the system operating (power-on state). (Skip step 2.)

1. Check the POWER lamp on the power supply unit and determine which unit needs to be replaced.
The lamp of the failing power supply unit is off.
2. Shutdown the system, and turn off the server.
3. While pressing down on the locking tab, grasp the handle and carefully pull the power supply unit out of the power supply bay.

IMPORTANT: To avoid damaging the power supply unit and/or connector, do not tilt or twist the unit as you pull it from the power supply bay. Use even, steady force to remove the unit.

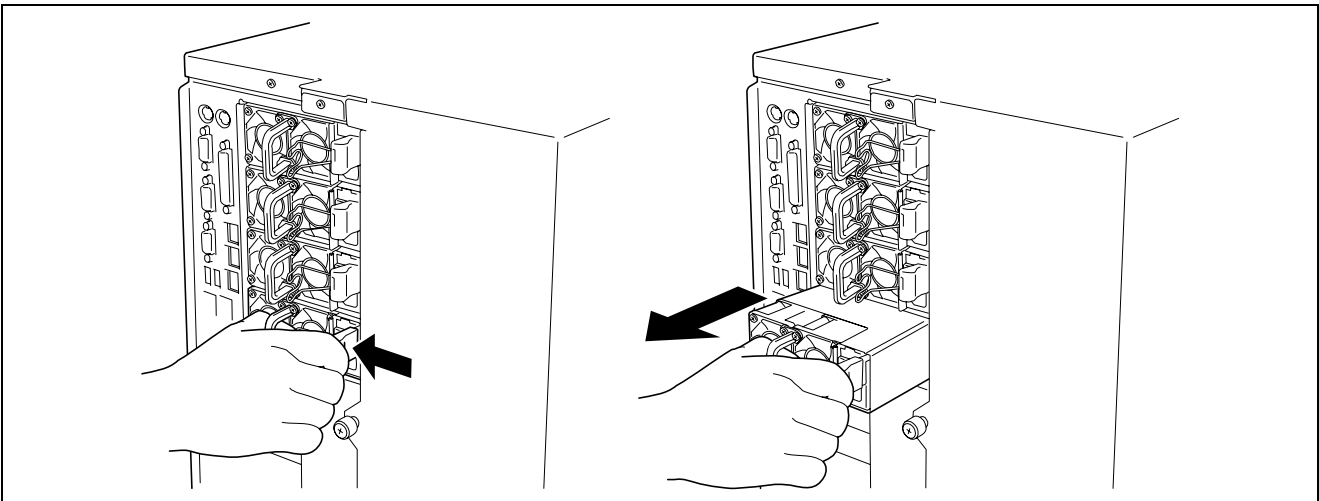

4. If you are not going to install a replacement power supply unit, you must install a blank cover you removed in step 2 of installation procedure to vacant slot.

IMPORTANT: To maintain the cooling effect in the server, install the blank cover in the vacant slot of the power supply bay.

5. Install the new power supply unit taking steps 3 to 6 of "Installation", and confirm that the power supply unit is installed normally.

NOTE: If one of the three or four power supply units of the server is replaced while the power is on, the POWER lamp of the new power supply unit goes on. (If it is replaced while the power is off, the lamp goes on after the power is turned on.)

5.25-inch Device

The server contains two slots in which SCSI backup devices such as magnetic tape drive can be installed.

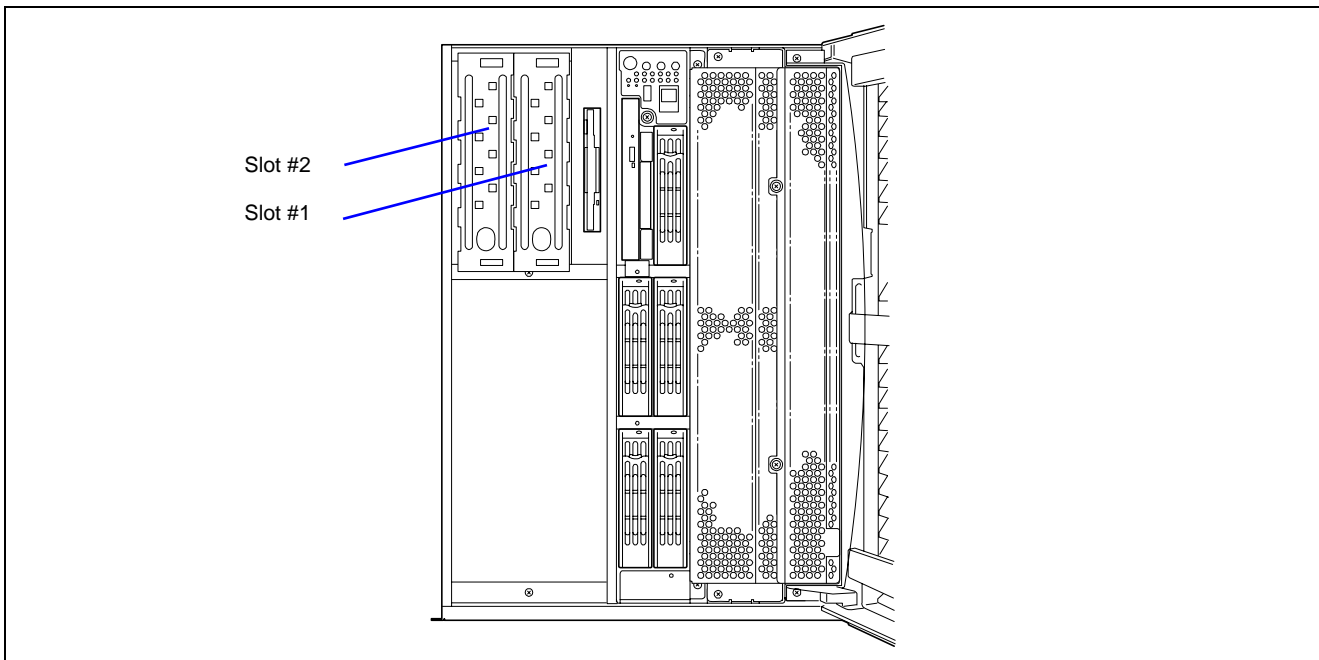

Available Devices

The 5.25-inch device slot can contain two single-height SCSI devices, or one full-height device.

- To connect the 5.25-inch device with the on-board SCSI controller, connect the SCSI cable mounted on the 5.25-inch device bay to "Ch-B" of SCSI connector on I/O board. In this case, assign the SCSI ID between 0 and 6 for the device to be installed. Set the terminator to "Disabled".
- If the "Ch-B" of SCSI connector on I/O board is connected to the additional HDD cage, connect the 5.25-inch device to the optional SCSI controller board.

Setting of SCSI ID

When connecting the 5.25-inch device with the SCSI connector (Ch-B) on I/O board, set the SCSI ID 0 through 6.

When connecting the 5.25-inch device with the optional SCSI controller, refer to the manual that comes with the SCSI controller.

- Setting of terminator
Set the terminator to "OFF".

Installation

Described below are installation procedures for both IDE device and SCSI device.

For SCSI device, procedures for connecting the device to SCSI connector "Ch-B" on I/O board are explained here. To connect it to the optional SCSI controller board, see "Cable Connection" described later.

1. See the section "Preparing for Installation and Removal" described earlier to prepare.
2. Open the front door.

3. Pull the dummy cover toward you gently and carefully.

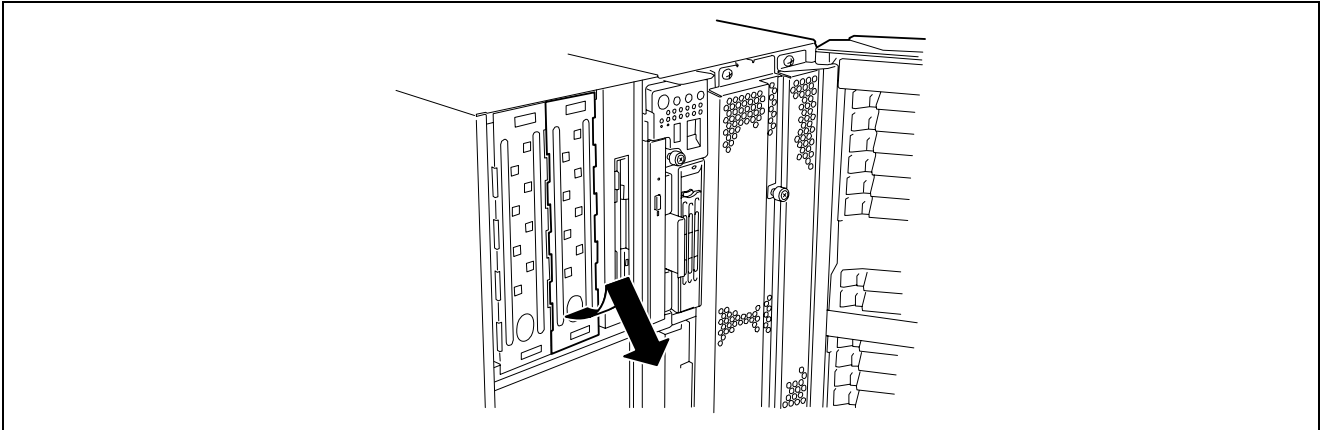

4. Pull the SCSI cable and power cable out of the 5.25-inch device bay.

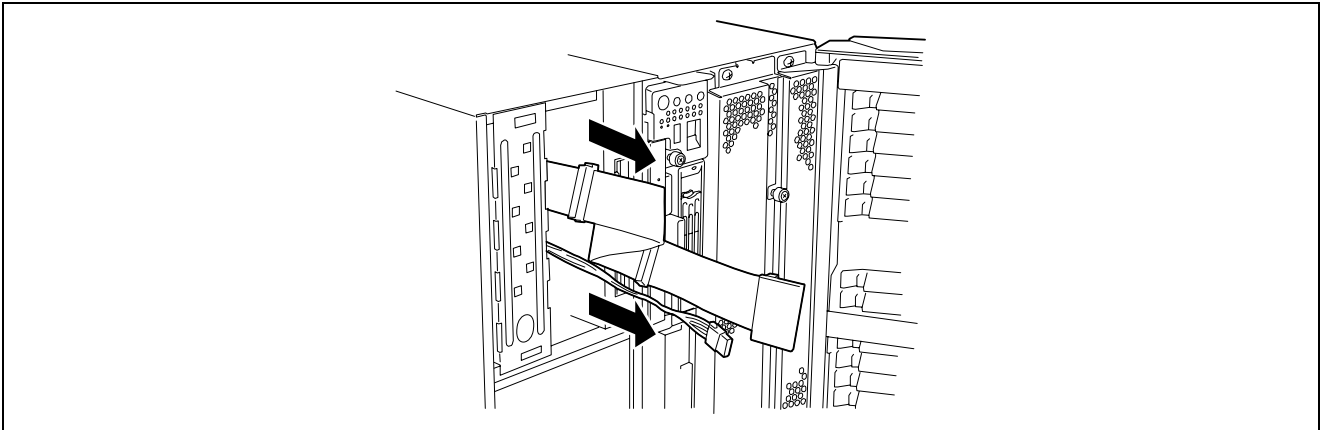

5. Install the two latching rails coming with the server to the device with the screw (PL-CPIMSx3x6x15BF) provided with the server.

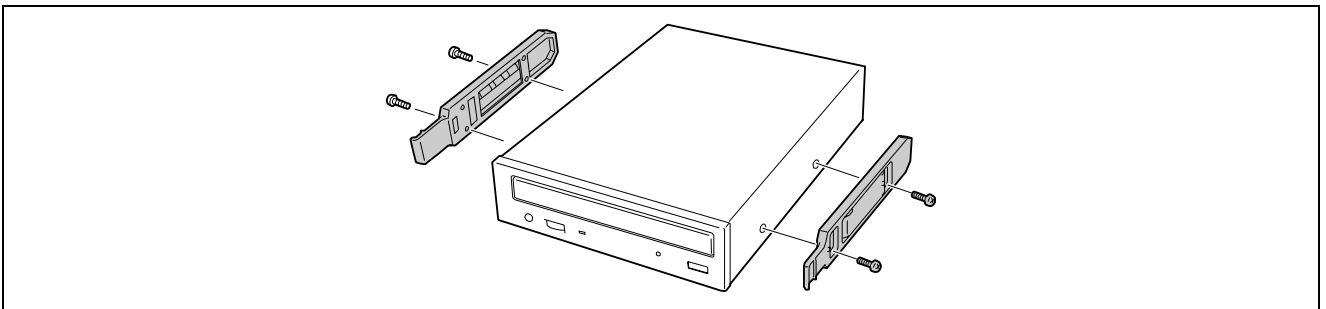

IMPORTANT: Always use the screws coming with the server. Do not use the screws coming with the 5.25-inch device. Using longer screws or those of different diameter may cause the device to be broken.

NOTE: Use the lower screw holes to secure the rail to the device.

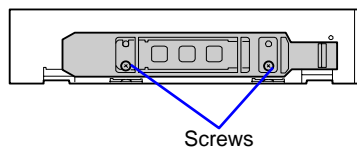

6. Connect the interface cable.

Connect the SCSI and power cables secured in the 5.25-inch device bay to the 5.25-inch device.

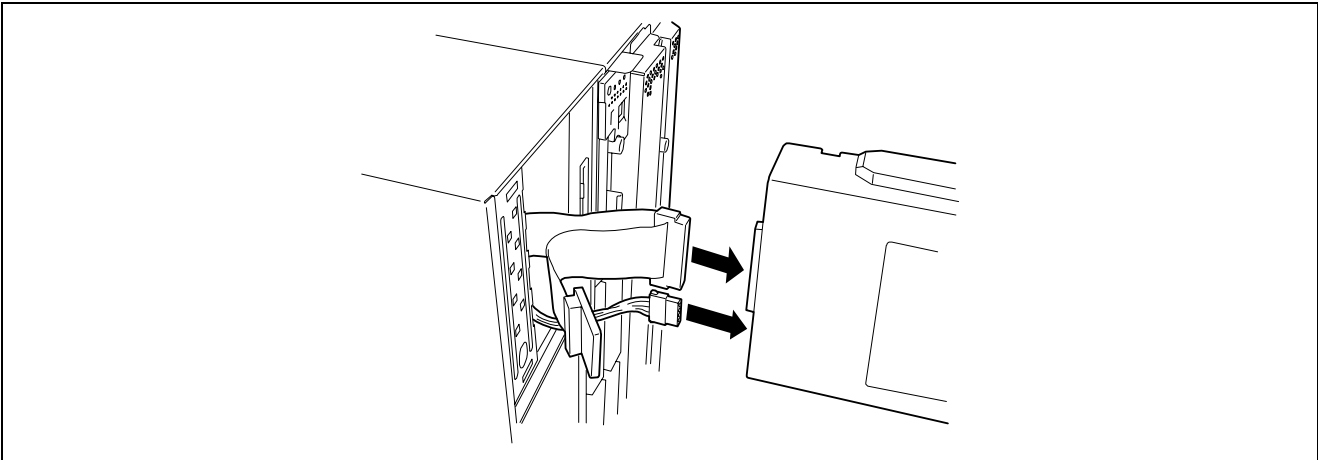

IMPORTANT: A connector cap is attached to the power cable. Keep the removed cap for future use.

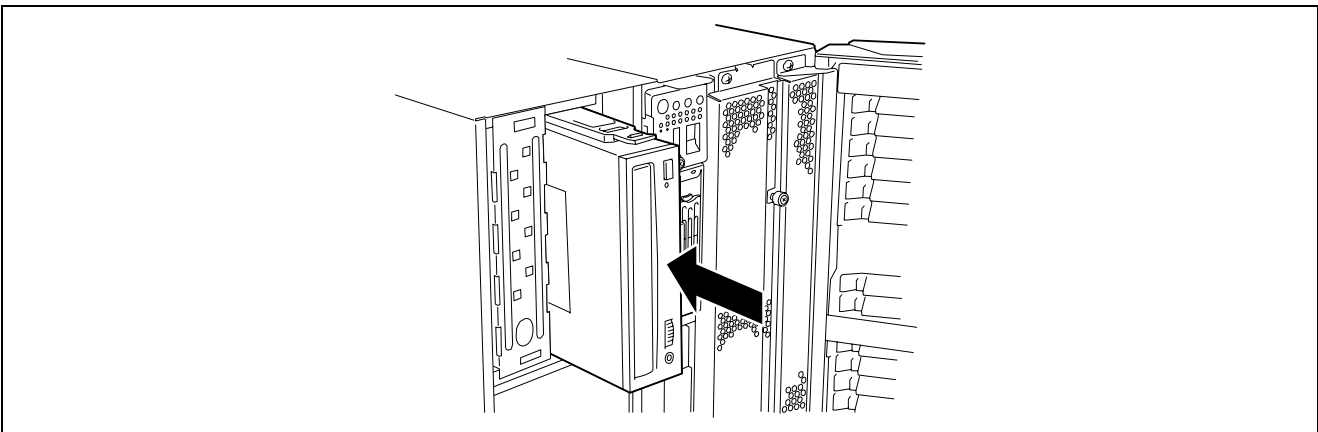
7. Push the 5.25-inch device to the device bay carefully until a click occurs to lock it.

IMPORTANT:

- If the SCSI connector "Ch-B" is connected to the additional HDD cage, install the optional SCSI controller board to connect with the 5.25-inch device.
 - Connector pin bending or incomplete connection may cause a malfunction to occur. Provide the connection securely watching the 5.25-inch device and cable connectors.
-

NOTE: Make sure that the cable is not caught.

8. Close the front door.**9.** Provide the setup for the SCSI controller.

If the 5.25-inch device is connected to optional SCSI controller board, refer to the manual that comes with the SCSI controller board for setup.

Removal

Remove the 5.25-inch device in the reverse procedure of the installation.

Rear Access Cover

To install or remove a PCI board, or to change cable connections of internal SCSI cable, you will need to remove the rear access cover.

⚠ CAUTION



Observe the following instructions to use the server safely. Failure to follow these instructions may result in death or serious personal injury. See pages 1-3 to 1-8 for details.

Be sure to power off the server before removing the rear access cover.

Removal

1. See the section "Preparing for Installation and Removal" described earlier to prepare.
2. Loosen the captive screws located on the rear of the cover.
3. Slide the rear access cover toward the rear of the chassis.
4. Lift the cover up and off of the chassis.

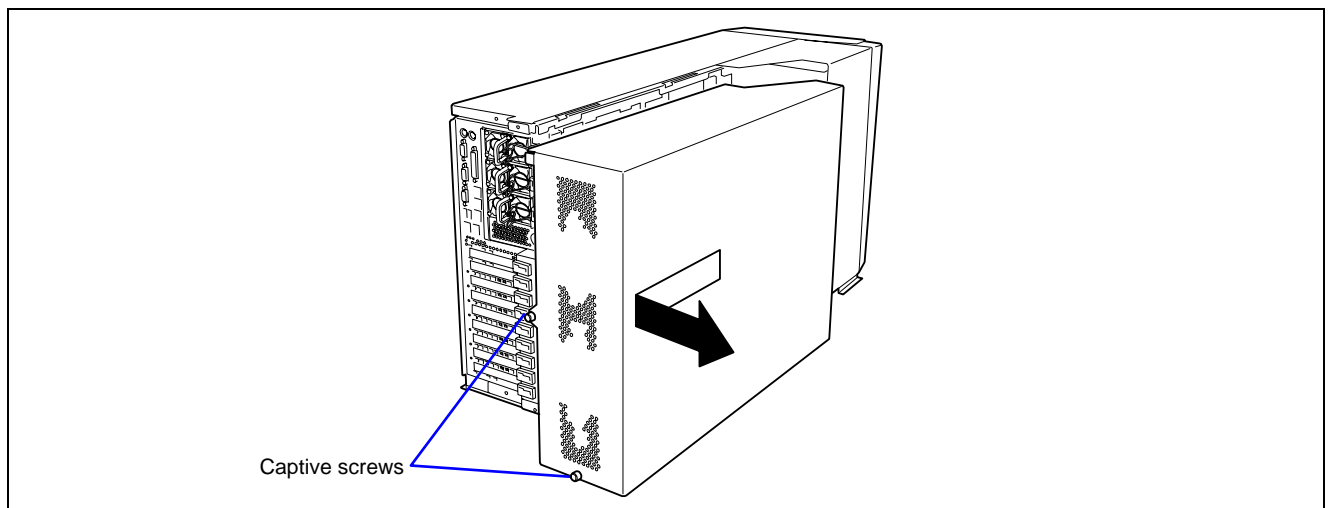

Installation

IMPORTANT: Before installing the rear access cover, check that you have not left tools or loose parts inside the system.

1. Position the cover on the chassis so that the cover tabs align with the chassis slots.
2. While lightly pressing down on the cover, slide it toward the front of the chassis.
3. Attach the cover to the chassis with the captive screws located on the rear of the cover.

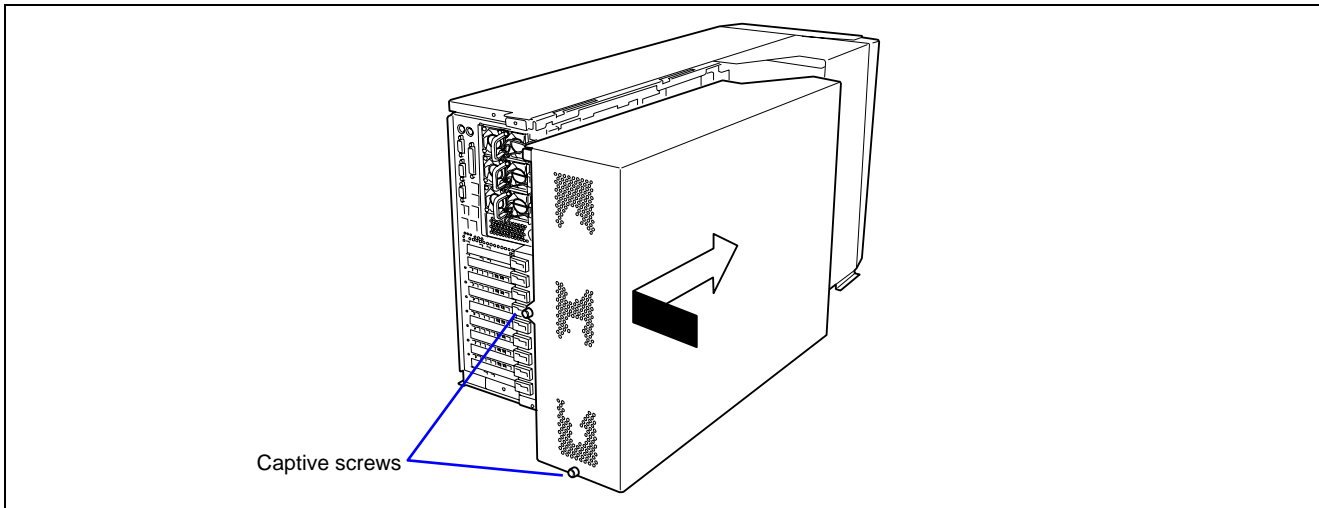

PCI Access Cover

To install or remove a non-hot-swap PCI board, remove the PCI access cover inside the server. You do not need to remove the PCI access cover when you work with hot-swap PCI slot.

Removal

1. See the section "Preparing for Installation and Removal" described earlier to prepare.
2. Remove the rear access cover.
3. Loosen the screw securing the PCI access cover.
4. Hold the end of the cover (the end where the screw is loosened), and take out the cover slowly and gently.

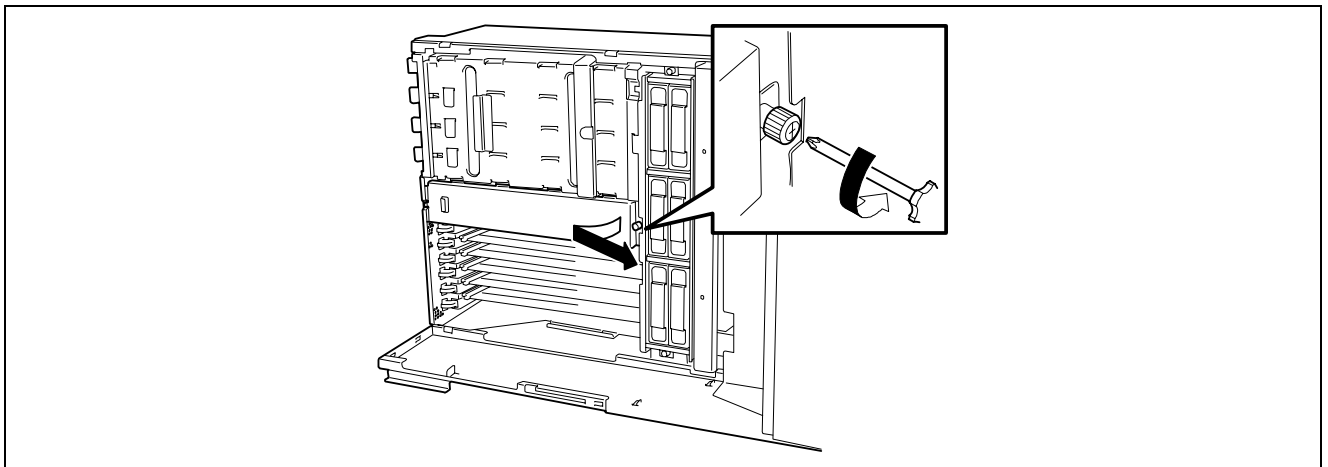

Installation

Take the following steps to install the PCI access cover.

1. Orient the PCI access cover with the screw toward the front of the server.
2. Insert the tab on the rear side of the PCI access cover into the chassis slot.
3. Slowly and gently put the cover on the chassis, and secure it with a screw.

PCI Board

The server contains six slots for PCI board, and three slots for PCI-Express board.

Some PCI boards support the hot-plug function by which they may be installed or removed with the power of the server being on. Your server supports the hot-plug function if the Windows Server 2003 or Windows 2000 is used as operating system. The PCI boards supporting the hot-plug function only include the N8104-86 100BASE-TX Adapter, N8104-111 100BASE-TX Adapter and the N8103-103 1000BASE-T Adapter.

IMPORTANT: The PCI board is extremely sensitive to static electricity. Make sure to touch the metal frame of the server to discharge static electricity from your body before handling the PCI board. Do not touch the PCI board terminals or on-board parts by a bare hand or place the PCI board directly on the desk. For static notes, see the section "Anti-static Measures".

NOTES:

- The tab on the PCI board slot indicates hot-plug or non-hot-plug by its colour. Hot-plug slots have a green tab (PCI slot #5 through #8), and non-hot-plug slots have a blue tab (PCI slot #1 through #4).
 - The PCI-Express boards are x1, x4, x8, and x16. The server can contain x1, x4, and x8 PCI-Express board.
-

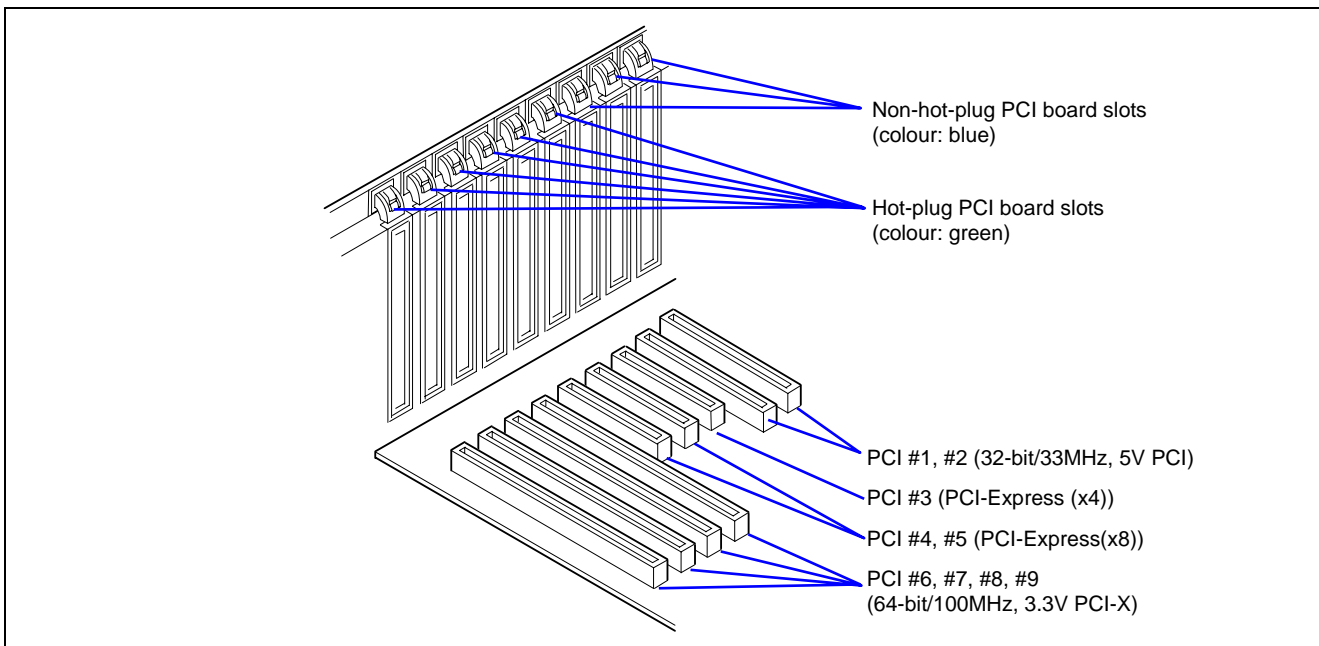

There are three types of PCI boards: 5V PCI boards, 3.3V PCI boards, and universal PCI boards.

A 5V PCI board must be installed in the 5V PCI slot, and a 3.3V PCI board must be installed in the 3.3V PCI slot. A universal PCI board can be installed in any PCI slot.

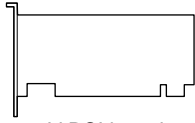

5V PCI board

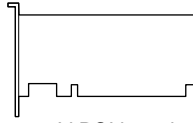

3.3V PCI board

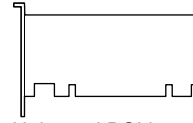

Universal PCI board

The PCI-Express boards are x1, x4, x8, and x16. The server can contain x1, x4, and x8 PCI-Express boards.

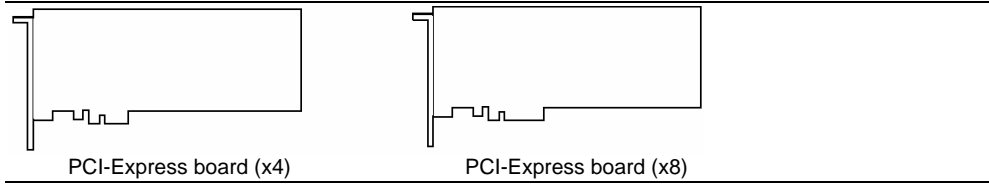

PCI-Express board (x4)

PCI-Express board (x8)

RAID Controller Considerations

Note the following on the configuration of a disk array by using the on-board or optional disk array controller.

- To change the disk array configuration or the RAID, the hard disk drives must be initialised. If important data is saved in the hard disk drives used to constitute a disk array, first back up the data in other hard disk drives before installing boards and configuring the disk array.
- At least two hard disk drives are required to configure a disk array.
- Hard disk drives used in the disk array configuration should have the same disk revolution rate and capacity in packs.
- See the table on next page for the slot in which an optional board can be installed.
- Up to four disk array controller boards can be installed in the server.
- Several RAID (Redundant Arrays of Inexpensive [Independent] Disks) levels can be set for the disk array configuration in the server. See "Disk Array Configuration" described later for available RAIDs, data transfer rate, and array configuration.

For an optional disk array controller, refer to the documentation coming with the disk array controller for details.

- The available capacity of the hard disk drives in the disk array configuration is lower than the total capacity of the hard disk drives configuring the disk array while the disk reliability is improved (for RAID 1, 5, 10, or 50).
- Set "Option ROM Scan," a parameter of the slot in which a hard disk is installed, to "Enabled" in "PCI Configuration" in the Advanced menu of the BIOS SETUP utility. For other slots, set the parameter to "Disabled". ("Enabled" is factory-set.) If two or more disk array controllers are installed, set only the slot containing the board to boot-up to "Enabled". Do not set "Option ROM Scan" for embedded SCSI to "Disabled".
- Replacement of I/O board or optional disk array controller board

Back up the disk array configuration information in the disk array controller board to a floppy disk and restore it to the replaced disk array controller board. Use the configuration utility for backup and restoration. See "Disk Array Configuration" described later or refer to the manual that comes with the disk array controller for details. If a disk array controller is replaced, create the configuration information newly by using the proper utility.

When more than one disk array controller board are installed in the server, install the disk array controller board to which the system disk is connected in the PCI slot having the highest boot priority.

Boot priority: PCI#3 → PCI#4 → PCI#5 → PCI#8 → PCI#9 → PCI#6 → PCI#7 → PCI#1 → PCI#2

For example, if four disk array controller boards are installed in PCI slots #6 to #9, the system disk should be connected to the board installed in PCI slot #8.

- The maximum total capacity of the hard disk drives that are configured as a logical drive or a pack is 2 TB (terabyte).
- The maximum logical disk capacity for installing Microsoft Windows 2000 operating system or Linux operating system is 1 TB.

List of Optional Devices and their Available Slots

Product Name	Description	PCI		PCI Express			PCI-X				
		#1	#2	#3	#4	#5	#6	#7	#8	#9	
		Bus A		Bus B	Bus C	Bus D	Bus E		Bus F		
		32-bit/33MHz		x4	x8		64-bit/100MHz				
		Slot size		Full-height							
		PCI board type		5V			x8 socket		3.3V		
Available board size		Long/short									
Hot-plug		Non-hot-plug			Hot-plug						
Initio 101	SCSI controller (32bit/33MHz PCI) *5	√	√	-	-	-	√	√	√	√	
Adaptec 29320	SCSI controller (64bit/133MHz PCI-X) *5	√	√	-	-	-	√	√	√	√	
SCSI U160 PCI-ATX-64b	SCSI controller (64bit/133MHz PCI-X) *5	√	√	-	-	-	√	√	√	√	
SecuRAID 321	Disk array controller (64bit/66MHz PCI) *4	-	-	-	-	-	√	√	√	√	
Emulex LP1050	Fibre Channel controller (2Gbps/Optical) (64bit/133MHz PCI-X) *4	-	-	-	-	-	√	√	√	√	
64B PCI-X PRO 1000MT DUAL	1000BASE-T Adapter (2ch)(64bit/133MHz PCI-X) *1	-	-	-	-	-	√	√	√	√	
INTEL PRO/1000 TX 64-BIT PCI	1000BASE-T Adapter (64bit/133MHz PCI-X) *1	-	-	-	-	-	√	√	√	√	
INTEL PRO/1000 F 64-BIT PCI	1000BASE-SX Adapter (64bit/133MHz PCI-X) *1	-	-	-	-	-	√	√	√	√	

√: Can be installed. -: Cannot be installed.

- *1 Only one card can be installed per a PCI-X bus.
- *2 Up to two cards can be installed.
- *3 Up to three cards can be installed.
- *4 Up to four cards can be installed.
- *5 Up to six cards can be installed.

NOTE: The system BIOS initialises the PCI slots in the order shown below. The order may be changed according to the types and number of PCI cards.

PCI#3→PCI#4→PCI#5→PCI#8→PCI#9→PCI#6→PCI#7→PCI#1→PCI#2

Onboard LAN Controller Considerations

It is possible to configure the Teaming function of AFT (Adapter Fault Tolerance)/ALB (Adaptive Load Balancing) in a standard network controller (on board LAN controller).

But it is also impossible to configure the Teaming function of the same AFT/ALB on a standard network controller and an optional LAN board.

Restriction on Teaming among Onboard LANs

When teaming is configured among onboard LANs, the following system event log appears when Windows starts. You can ignore this message and continue operation.

source: iANSMiniport

event IDs: 11/13/16/22

Non-hot-plug PCI Boards

This section describes the procedure for installing or removing a non-hot-plug PCI board.

Installation

Install a board in a PCI board slot as follows.

IMPORTANT:

- PCI board slots #6 to #9 can accept 3.3V and universal PCI boards.
 - PCI board slots #1 and #2 can accept 5V and universal PCI boards.
-

NOTES:

- Before installing the PCI board, make sure that the terminal section of the board mates with the connector of the PCI board slot.
 - Insulators are installed between the PCI board slots. They are for protecting the PCI board already been installed. Take care not to remove or damage the insulator when installing or removing a PCI board. If the insulator is taken off, reinstall the insulator in place.
-

1. See the section "Preparing for Installation and Removal" described earlier to prepare.

IMPORTANT: To avoid damage to the system and devices, always turn off the system before installing a non-hot swap board.

2. Remove the rear access cover.
3. Locate the slot to install a board.
4. Press the retention tab at the tip of the additional slot cover to unlock and open the tab.

IMPORTANT: Do not open the retention tab to 90 degrees or more. Doing so could damage the tab.

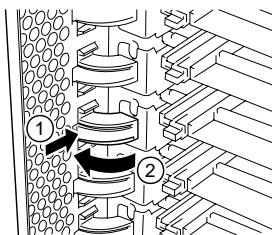

5. Remove the blank plate.

IMPORTANT: Keep the blank plate being removed for future use.

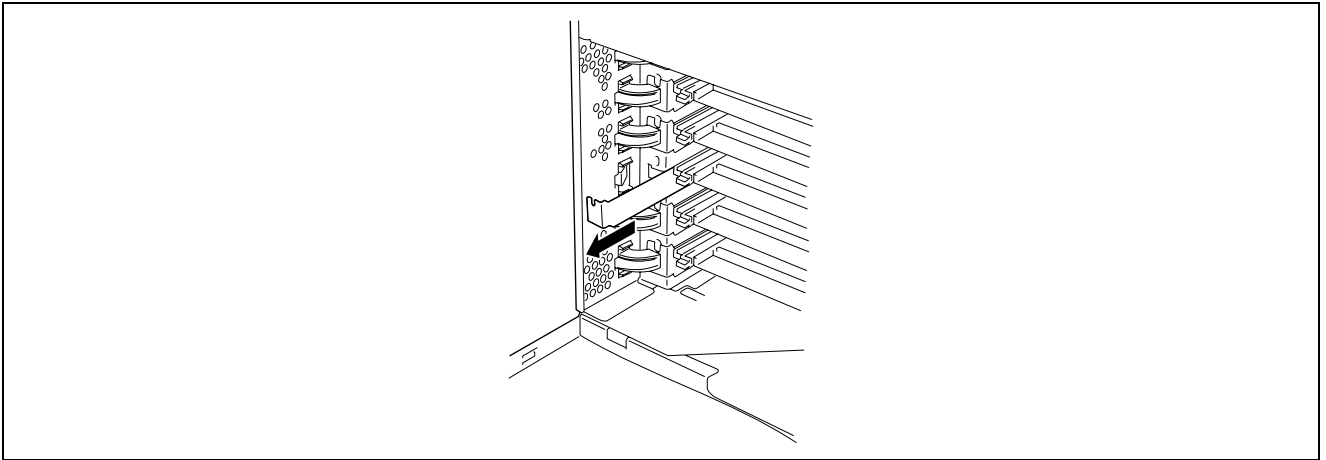

6. Align the board with the grooves of the guide rail, and insert the board slowly and gently.

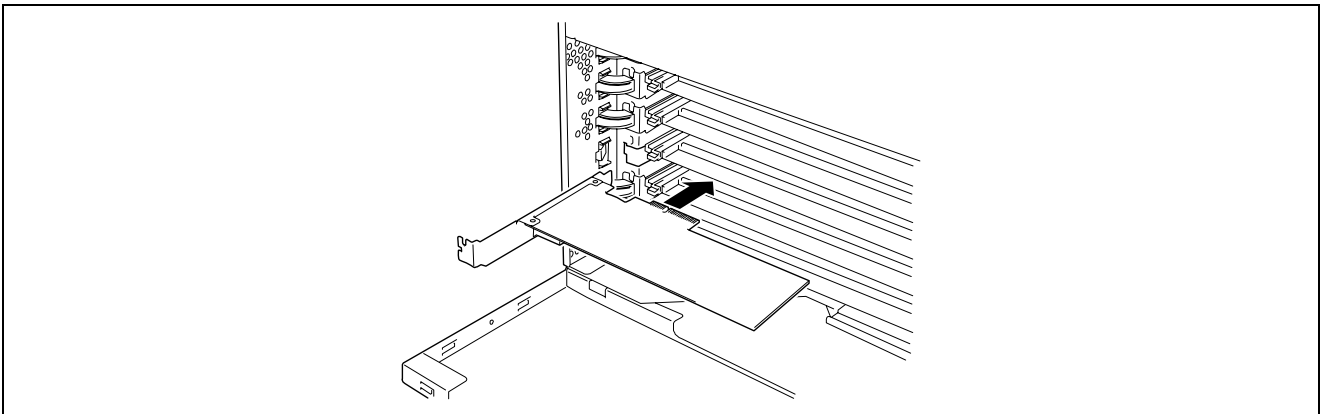

7. Carefully push the board until it engages and fully seats in the slot connector.

IMPORTANT: If the board cannot be installed easily, remove the board once and then reinstall it. Excess force added to the board may cause the board to be broken.

NOTES:

- After installed a long board, secure it with the lock on the upper part of the guide rail.

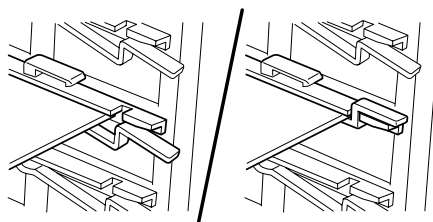

- Insulators are installed between the PCI board slots. They are for protecting the PCI board already installed. Take care not to remove or damage the insulator when installing or removing a PCI board. If the insulator is taken off, reinstall the insulator in place.
-

8. Slowly close the tab to secure the PCI board.

NOTE: Make sure that the tab is firmly locked. If the tab is unlocked, the PCI board and/or I/O board may be damaged due to unstable PCI board.

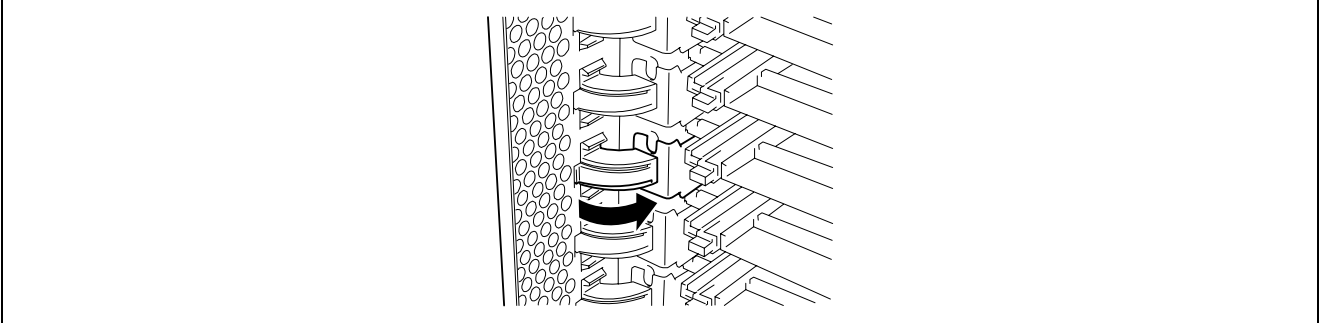

9. Reinstall the removed components.
10. Turn on the power of the server. Then make sure that any error message does not appear in POST. If an error message appears, write down the message and review the error message list in Chapter 8.
11. Start the BIOS Setup Utility to set the "Reset Configuration Data" in the "Advanced" menu to "Yes." This is required to update the hardware configuration information. See Chapter 4 for details.

Removal

Remove the board in the reverse procedure of the installation.

Hot-plug PCI Board

On the PCI board slots #5 through #9, you can replace or add a hot-plug PCI board while the server is operating.

Only N8104-86 100BASE-TX Adapter, N8104-111 100BASE-TX Adapter and N8104-103 1000BASE-T Adapter support the Hot-plug PCI function.

The PCI hot-plug function includes the following functions:

- **Hot Add**
Use Hot Add to install a Hot Plug PCI board while the server is operating.
- **Hot Remove**
Use Hot Remove to remove a Hot Plug PCI board while the server is operating.
- **Hot Replace**
Use Hot Replace to replace a Hot Plug PCI board while the server is operating.

IMPORTANT:

- Before removing a PCI board, be sure to stop the driver of the slot (containing the PCI board) from the operating system (Windows Server 2003/Windows 2000). Failure to do so may cause the system to fail.
 - For Windows Server 2003/Windows 2000 server, do not use a function in inactive state after executing the PCI Hot-plug function. The system fails to return to the original state when a function in inactive state is restarted.
Use the BIOS Setup utility to set the following before executing the PCI Hot Plug function:
Select [Advanced] → [PCI Configuration] → [Hot-plug PCI Control] → [Reserving memory space for PHP] → Select memory space for installed board*¹.
 - *1 The memory capacity appears to be less than the actually installed memory capacity.
 - To execute the PCI Hot-plug function, be sure to log in the system as Administrator.
 - The board available for the hot add varies depending on the clock rate previously set by PCI slots #6 and #7 or #8 and #9. If a PCI board operating at a different clock rate is subject to the hot addition, the PCI slot fault lamp goes on and the hot plug cannot be performed correctly. However, restarting the system allows BIOS to ignore the setting value and automatically operate the system with the optimum setting.
-

Requirements for Hot Add

- **No boards installed in the same bus**
Verify the available slot according to "List of Optional Devices and their Available Slots", and then hot-add the PCI card.
- **PCI boards installed on the same bus**
Provide Hot Add for PCI boards operating at the same clock.

Status Lamps

Two LEDs on the back panel indicate the status of the hot-plug PCI add-in boards. You can check the indication by lamps on the I/O board.

- **PCI slot Power lamp (green)**

Lights when power is supplied normally to the PCI board installed.

- **PCI slot Fault lamp (amber)**

Lights when an error occurs on PCI board or the slot containing the PCI board.

Flashes when the driver is stopped from Windows Server 2003/Windows 2000 for Hot Remove or Hot Replace.

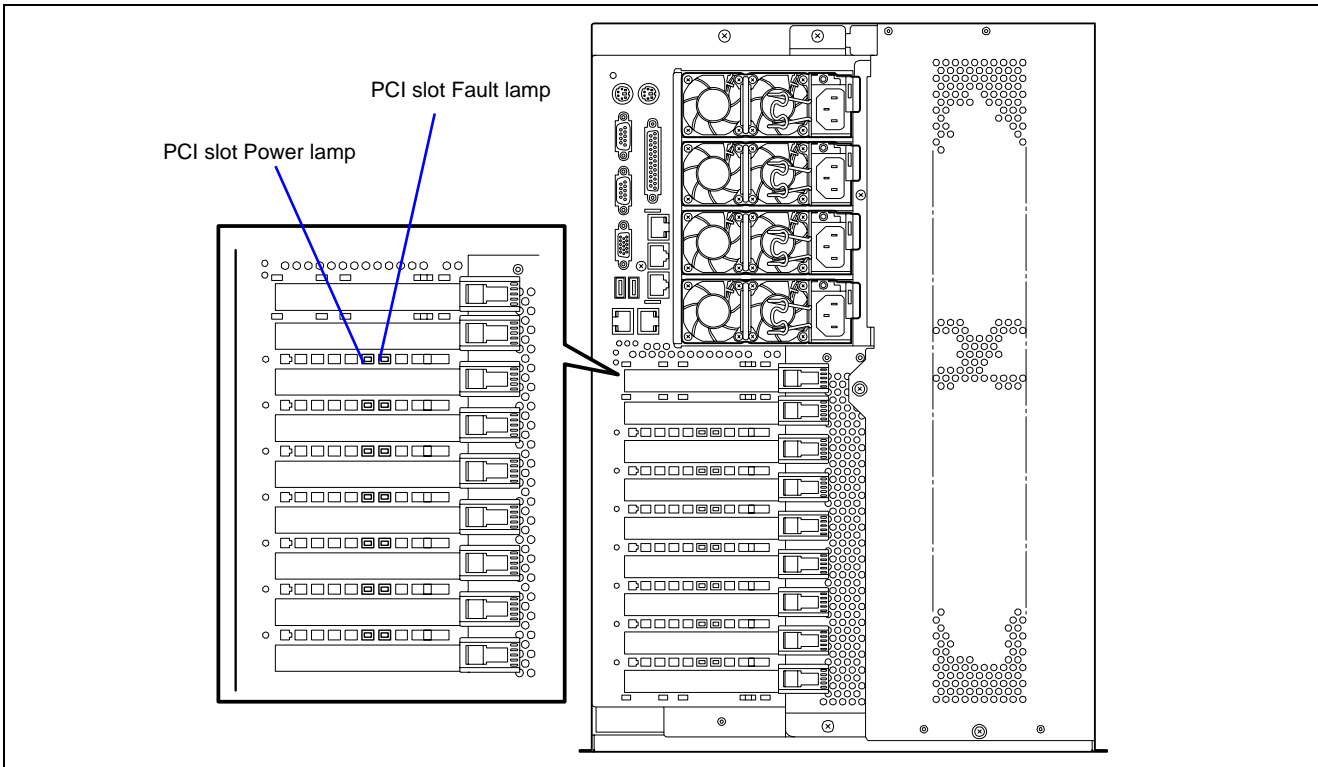

Hot Add

Take the following procedure to execute Hot Add:

1. Remove the rear access cover from the server with the power being on.
2. Locate the slot in which you are going to install an additional board.

NOTE: Confirm that the PCI Slot Power lamp of the slot in which you are going to install the PCI board is off.

3. Push the tab at the tip of the additional slot cover of the slot in which you are going to install the PCI board to unlock the tab. Open the tab.

IMPORTANT: Do not open the retention tab to 90 degrees or more. Doing so could damage the tab.

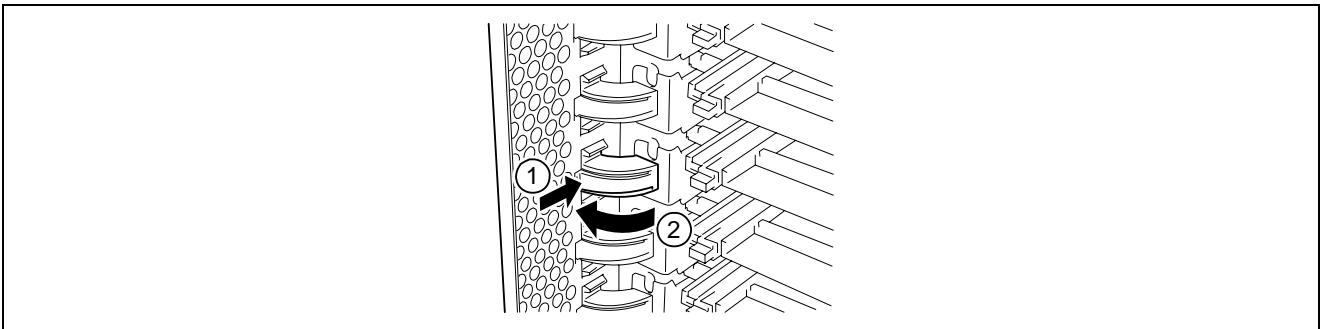

4. Remove the slot cover.

IMPORTANT: Keep the removed slot cover for future use.

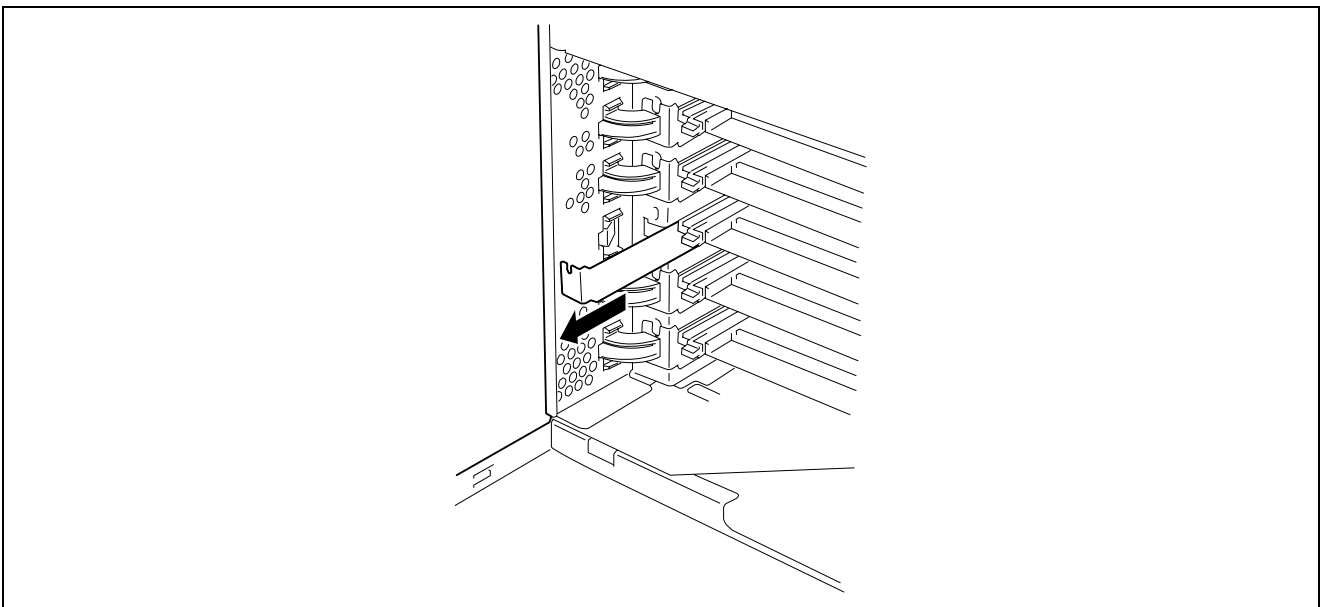

5. Push the PCI board slowly and carefully into the slot.

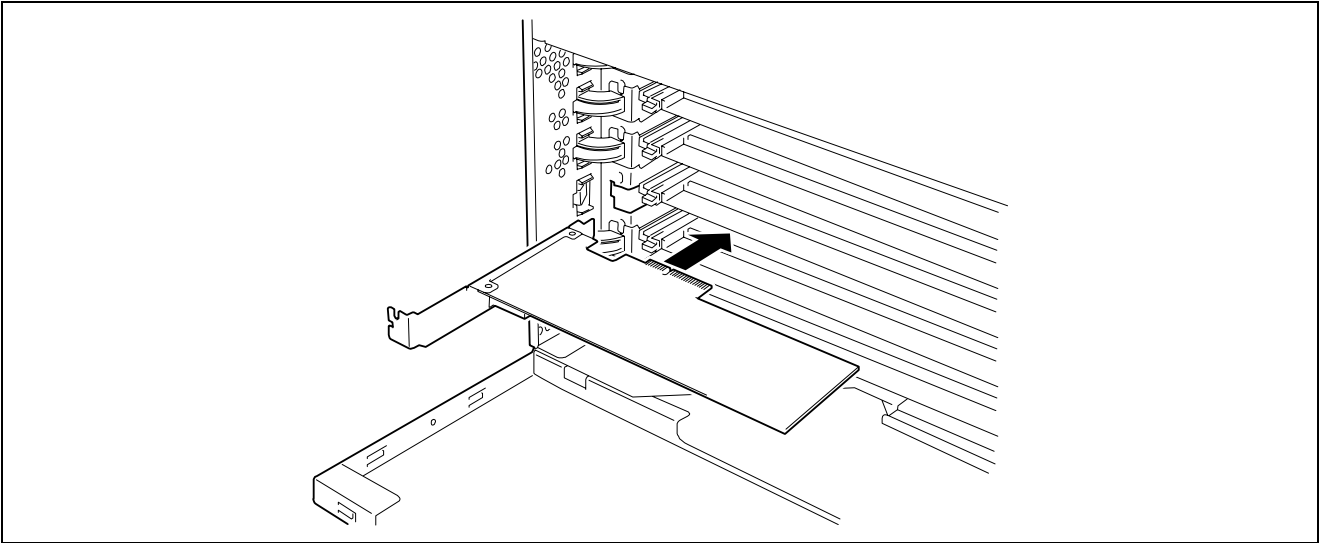

6. Push the PCI board until the connection part of the board is firmly connected into the slot.

IMPORTANT: If failing to install the PCI board correctly, reinstall it. Be careful not to apply excess force to the PCI board when handling it. Applying excess force may cause damage to the PCI board.

NOTES:

- After installed a long board, secure it with the lock on the upper part of the guide rail.

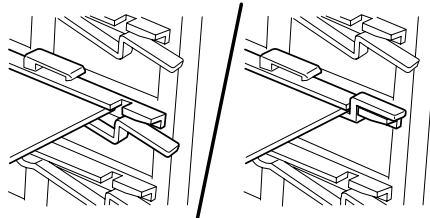

- Insulators are installed between the PCI board slots. They are for protecting the PCI boards already installed. Take care not to remove or damage the insulator when installing or removing the PCI board. If the insulator is taken off, reinstall the insulator in place.
-

7. Connect the cables to the PCI board while firmly holding the PCI board with your hand.
8. Slowly close the tab to secure the PCI board.
9. Press the PCI Hot Plug switch. The PCI Slot Power lamp flashes once and then, goes on.

NOTES:

- If the server runs on Windows Server 2003 or Windows 2000, the operating system automatically recognises the additionally installed PCI board and installs the driver.
 - If an error occurred in the installed board or slot, the PCI Slot Fault lamp goes on (amber).
-

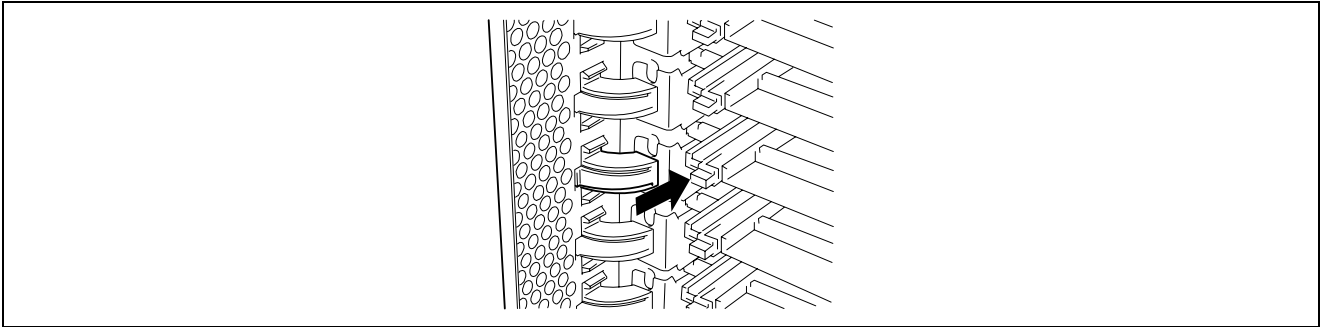

10. Reinstall the rear access cover.
11. Check if the additionally installed PCI board is recognised and working properly as follows:
 - (1) Select [Control Panel], [Administrative Tools], [Computer Management], and [Device Manager] in the order to start the Device Manager.
 - (2) Move the cursor to the added board.

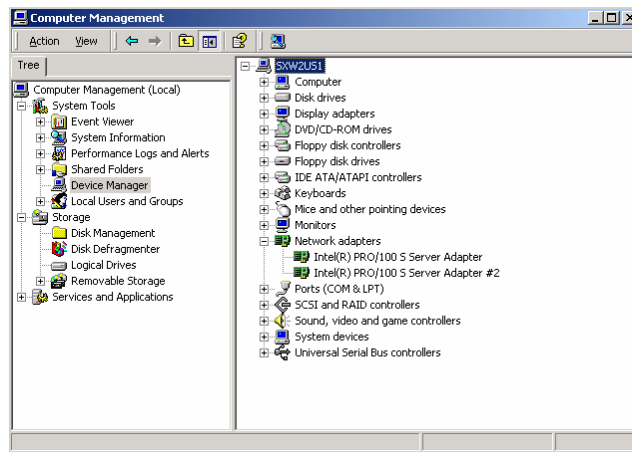

- (3) Click the [General] tab to display the property to confirm that the device is working properly.

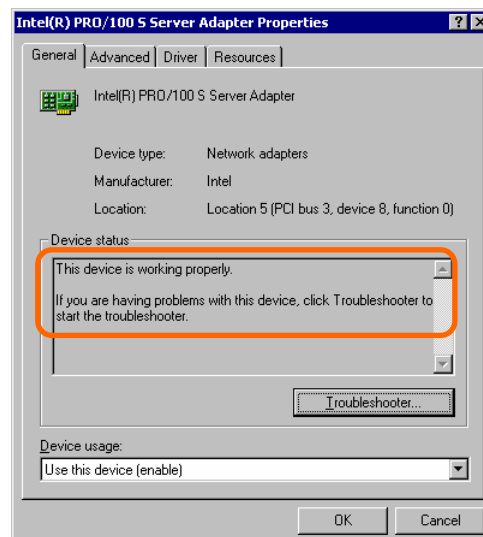

* The message in the "property" depends on the location of the PCI board slot.

Hot Remove

Use the following procedure to execute Hot Remove:

1. Stop the device driver used by the Hot-plug PCI board you want to remove as follows:

IMPORTANT: Before removing a PCI board, be sure to stop the driver of the slot (containing the PCI board) from the operating system. Failure to do so may cause the system to fail.

To stop the device driver from the operating system window:

- (1) Open [Add/Remove Hardware] in [Control Panel].
The [Add/Remove Hardware Wizard] starts.
- (2) Click [Next].



- (3) Select [Uninstall/Unplug a device] for hardware task, then click [Next].

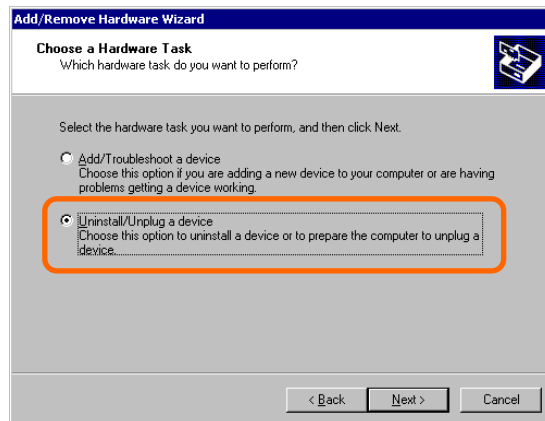

- (4) Select [Unplug/Eject a device] for removal task, then click [Next].

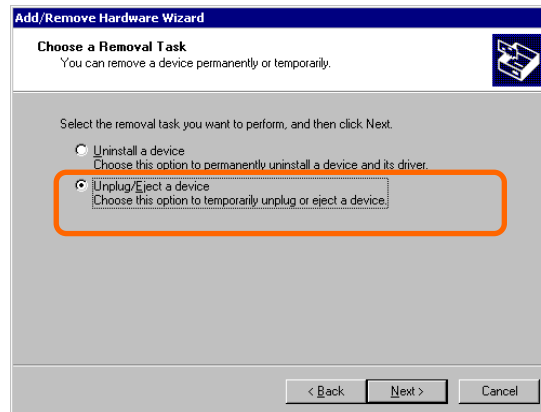

- (5) Select the target device, then click [Next].

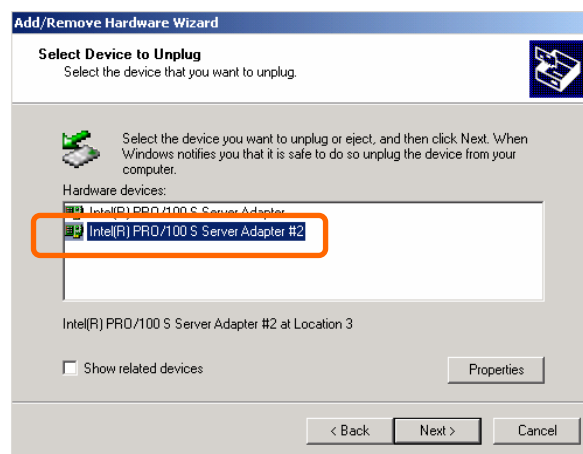

- (6) Confirm that the driver is used by the device you want to remove, then click [Next]. The [Add/Remove Hardware Wizard] closes.

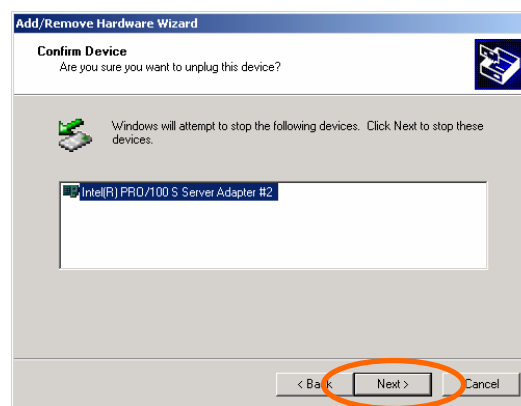

- (7) Click [Finish].

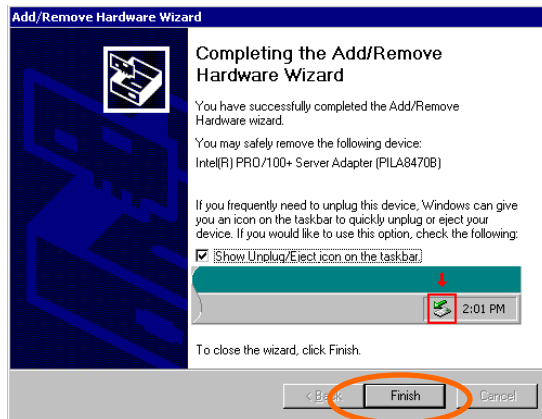

- (9) Remove the rear access cover and locate the slot from which the board has to be removed.

NOTE: Confirm that the PCI Slot Power lamp of the target PCI slot is off.

To stop the device driver using the PCI hot-plug switch:

- (1) Remove the rear access cover and confirm the slot to remove the PCI board.
- (2) Press the PCI hot-plug switch on the slot from which the PCI board is to be removed.

NOTE: Confirm that the PCI Slot Power lamp of the target PCI slot is off.

2. Disconnect all the cables from the PCI board.
3. Push the tab to unlock it, slowly open the tab, then remove the PCI board.

IMPORTANT: Do not open the retention tab to 90 degrees or more. Doing so could damage the tab.

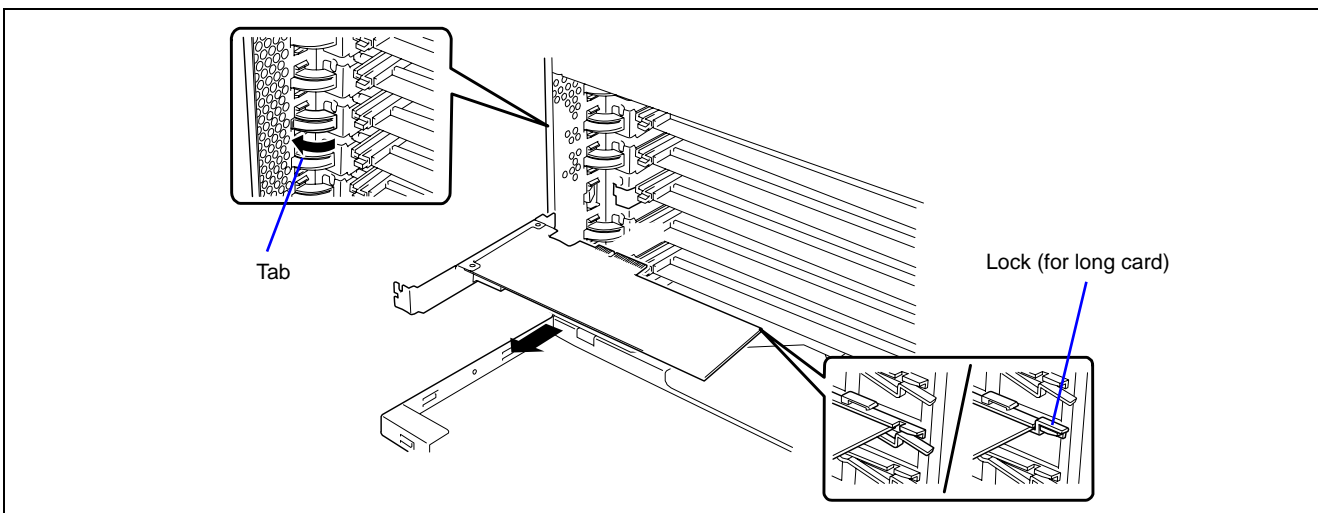

4. Install a slot cover on the slot from which you removed the PCI board, then slowly close the tab.

IMPORTANT: To maintain the dust-proofing and electromagnetic radiation characteristics and cooling performance of the server, be sure to install the blank plate on the slot from which you removed the PCI board.

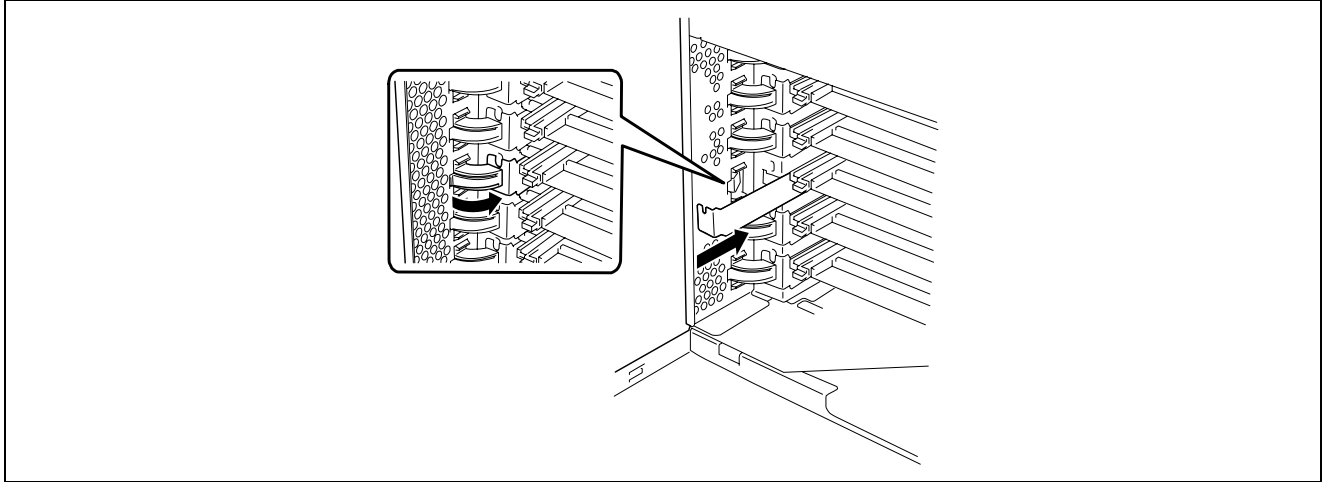

5. Reinstall the rear access cover.

Hot Replace

Use the following procedure to execute a Hot Replace:

1. Stop the device driver used by the Hot Plug PCI board you want to replace as follows:

IMPORTANT: Before removing a PCI board, be sure to stop the driver of the slot (containing the PCI board) from the operating system. Failure to do so may cause the system to fail.

To stop the device driver from the operating system window:

- (1) Open [Add/Remove Hardware] in [Control Panel].
The [Add/Remove Hardware Wizard] starts.
- (2) Click [Next].



- (3) Select [Uninstall/Unplug a device] for hardware task, then click [Next].

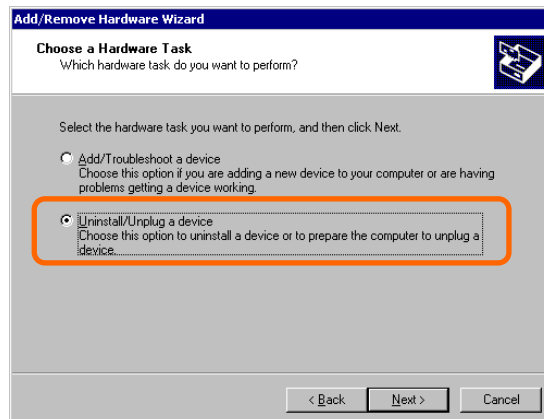

- (4) Select [Unplug/Eject a device] for removal task, then click [Next].

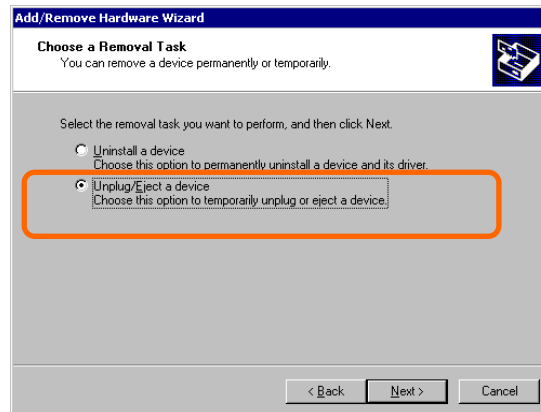

- (5) Select the target device, then click [Next].

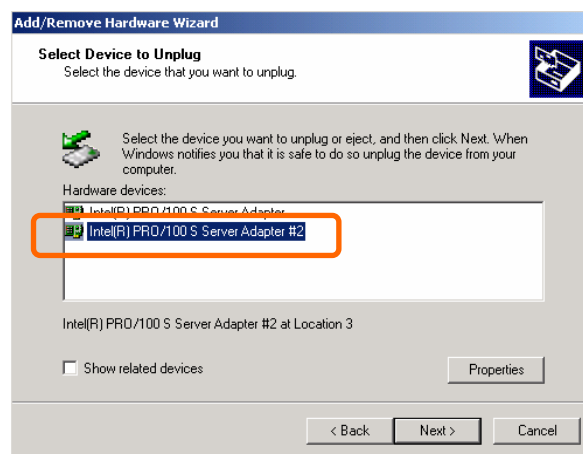

- (6) Confirm that the driver is used by the device you want to remove, then click [Next]. The [Add/Remove Hardware Wizard] terminates.

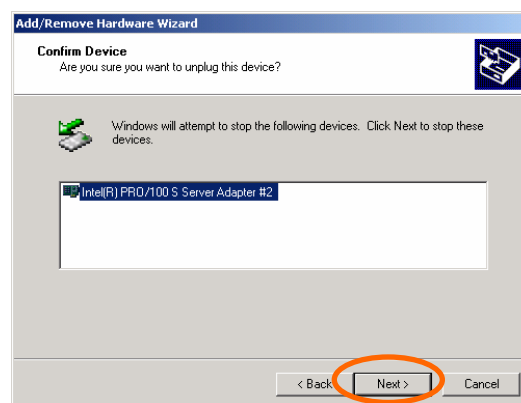

- (7) Click [Finish].

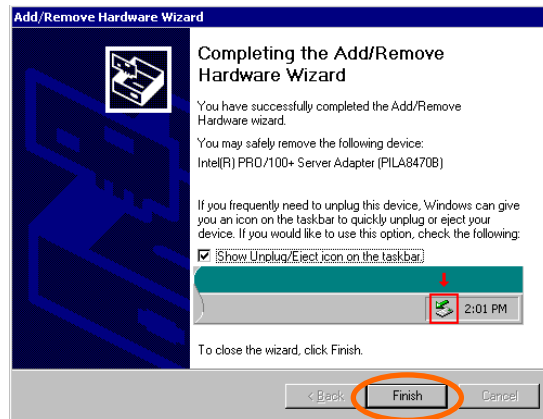

- (8) Remove the rear access cover and locate the board to be removed.

NOTE: Confirm that the PCI Slot Power lamp of the target PCI slot is off.

2. Disconnect all the cables from the PCI board.
3. Push the tab to unlock it, slowly open the tab, then remove the PCI board.

IMPORTANT: Do not open the retention tab to 90 degrees or more. Doing so could damage the tab.

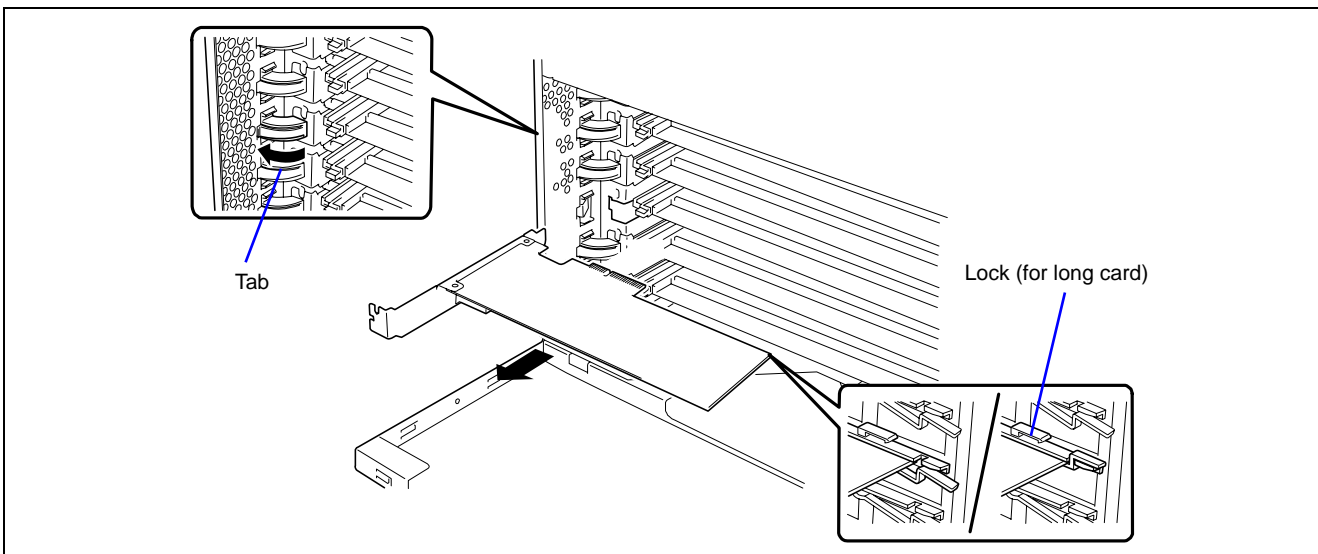

4. Slowly insert the PCI board into the server.

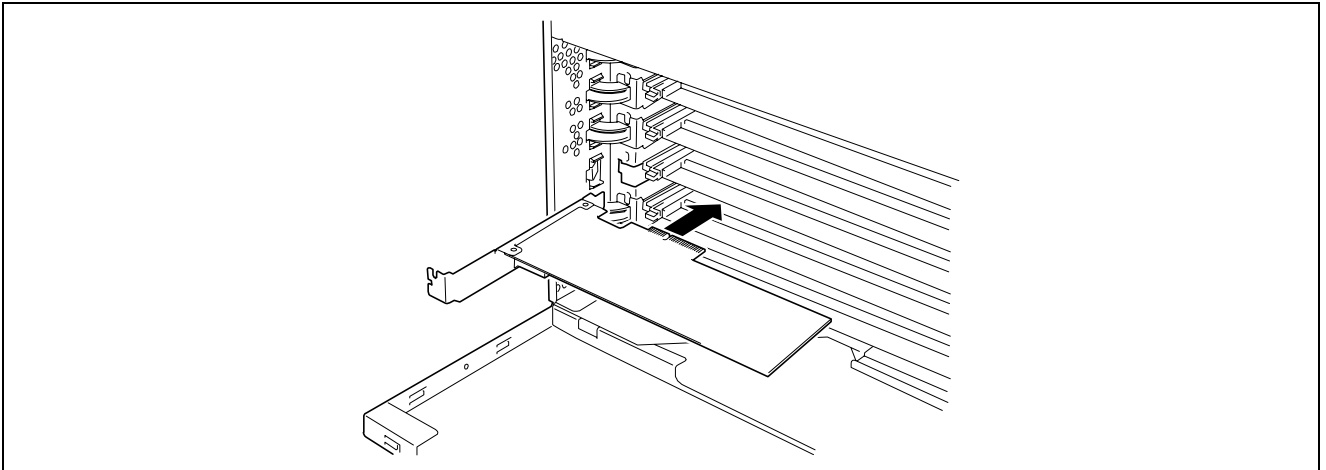

5. Push the PCI board until the connection part of the board is firmly connected into the slot.

IMPORTANT: If failing to install the PCI board correctly, reinstall it. Be careful not to apply excess force to the PCI board when handling it. Applying excess force may cause damage to the PCI board.

NOTES:

- After installed a long board, secure it with the lock on the upper part of the guide rail.

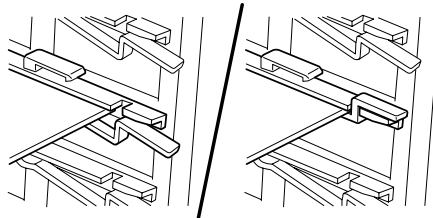

- Insulators are installed between the PCI board slots. They are for protecting the PCI boards already installed. Take care not to remove or damage the insulator when installing or removing the PCI board. If the insulator is taken off, reinstall the insulator in place.
-

6. Connect the cables to the PCI board while firmly holding the PCI board with your hand.
7. Slowly close the tab to secure the PCI board.
8. Press the PCI hot plug switch.

The PCI Slot Power lamp flashes once, and then goes on.

NOTES:

- If the server runs on Windows Server 2003 or Windows 2000, the operating system automatically recognises the installed PCI board and installs the driver.
 - If an error occurred in the installed board or slot, the PCI Slot Fault lamp goes on (amber).
-

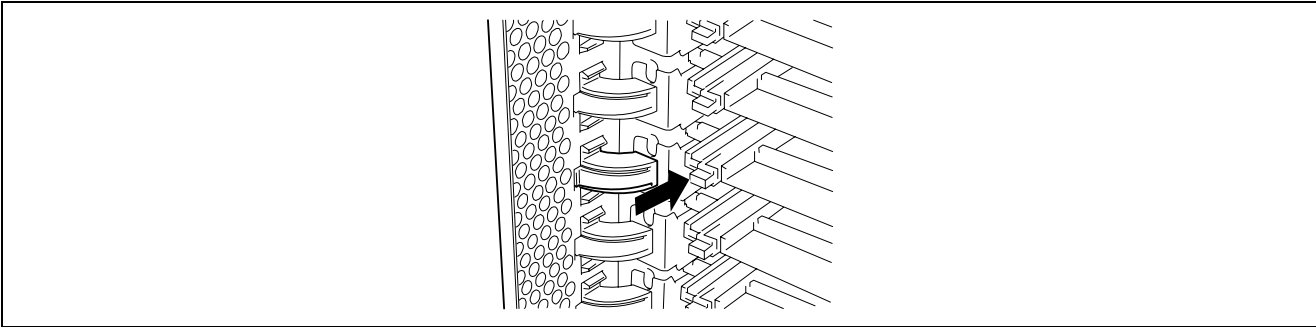

- 9. Reinstall the PCI slot cover.
- 10. Check if the installed PCI board is recognised and working properly as follows:
 - (1) Select [Control Panel], [Administrative Tools], [Computer Management], and [Device Manager] in the order to start the Device Manager.
 - (2) Move the cursor to the added board.

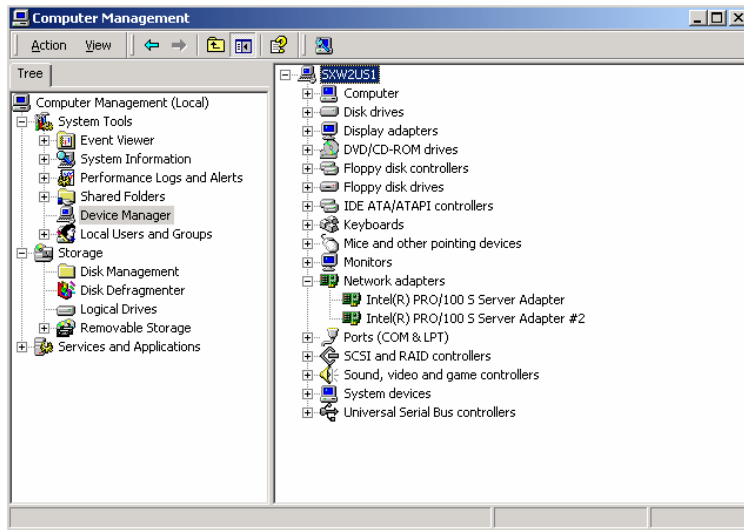

- (3) Display the [General] dialog in the property to confirm that the device is working properly.

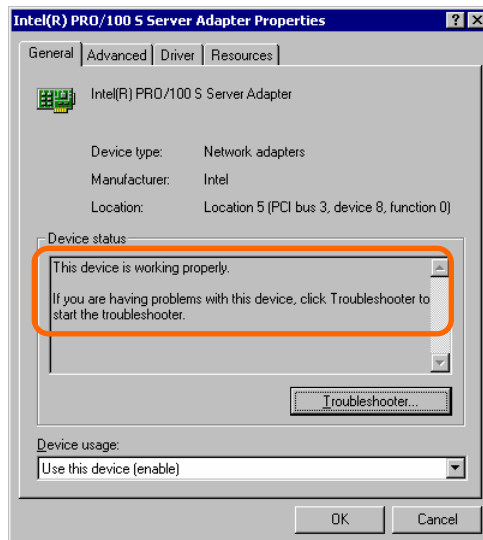

* The message in the "property" depends on the location of the PCI board slot.

- Notes when removing the PCI slot insulators

Be careful that the insulator does not make contact with the capacitor of the PCI-Express slot.

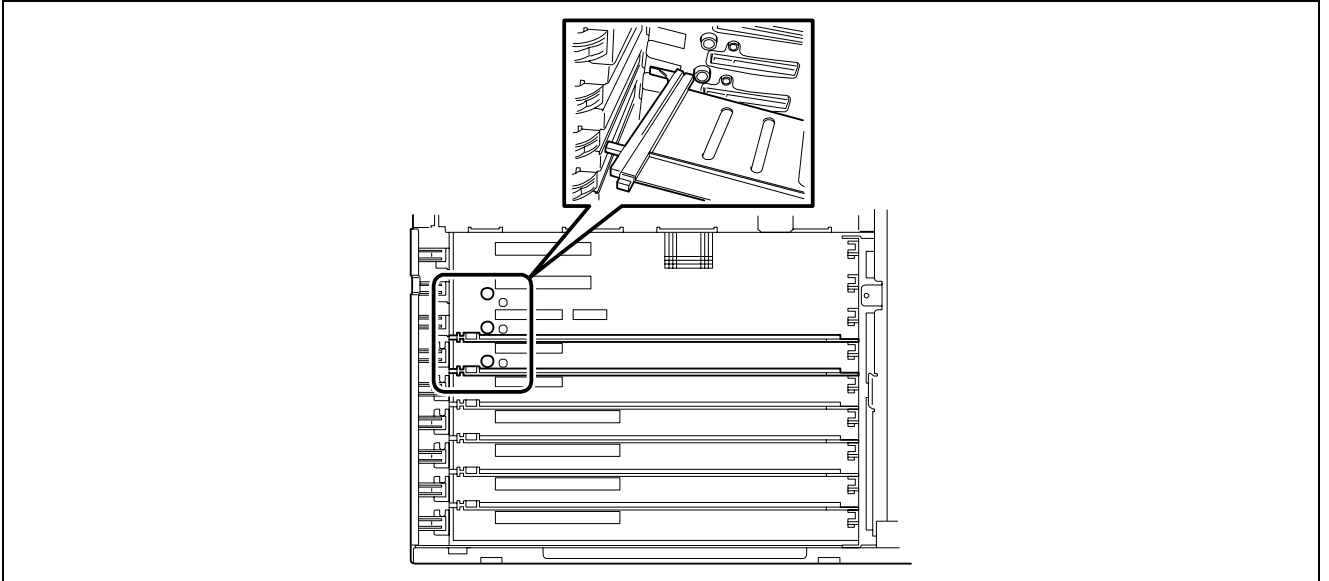

Memory Board

To install or remove a DIMM, remove the memory board first.

One memory board is factory-installed in the server. Up to four memory boards (32 GB maximum) can be installed in the server.

The failing DIMM or memory board can be hot-swapped (replacement with power-on state) in the memory RAID configuration. For hot-swap memory board, see "Memory Hot-Plug Feature 1 (Hot Replace)" and "Memory Hot-Plug Feature 2 (Hot Add)" described later in this chapter.

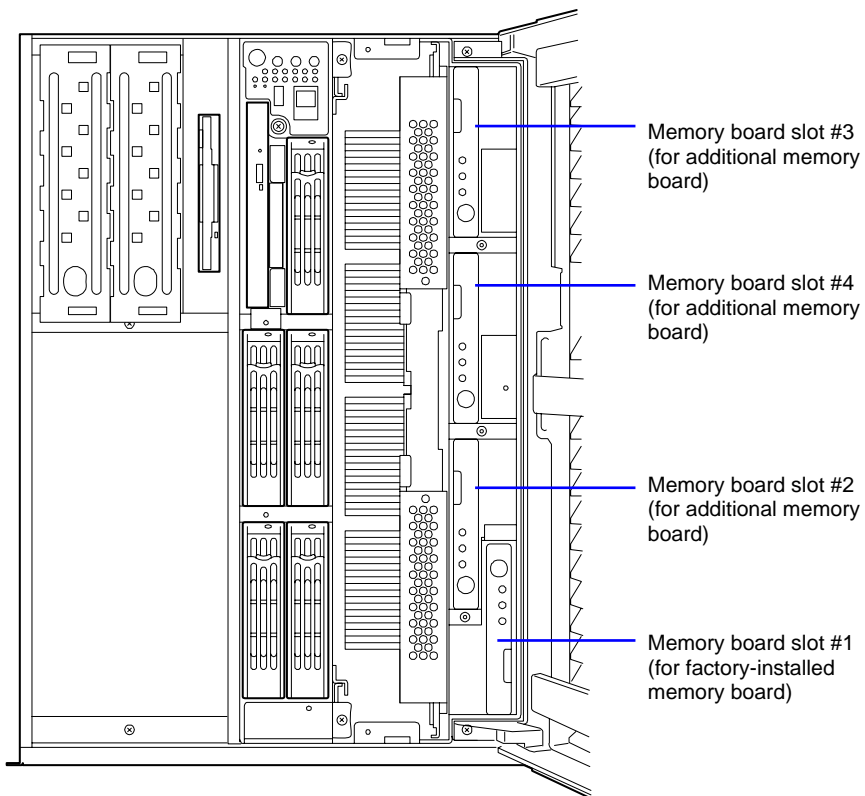

Memory board installation order: #2 → #3 → #4

Removal

Remove the memory board as follows:

IMPORTANT:

- The memory board is extremely sensitive to static electricity. Make sure to touch the metal frame of the server to discharge static electricity from your body before handling the memory board. Do not touch the memory board terminals or on-board parts by a bare hand or place the memory board directly on the desk. For static notes, see the section "Anti-static Measures" described earlier.
 - The memory board becomes very hot while being powered. When removing the board, turn off the power and wait for several minutes before pulling it out.
-

1. See the section "Preparing for Installation and Removal" described earlier to prepare.
2. Unlock the front door with the security key, and open the front door.
3. Remove the two screws, and remove the memory slot cover from the front of the server.

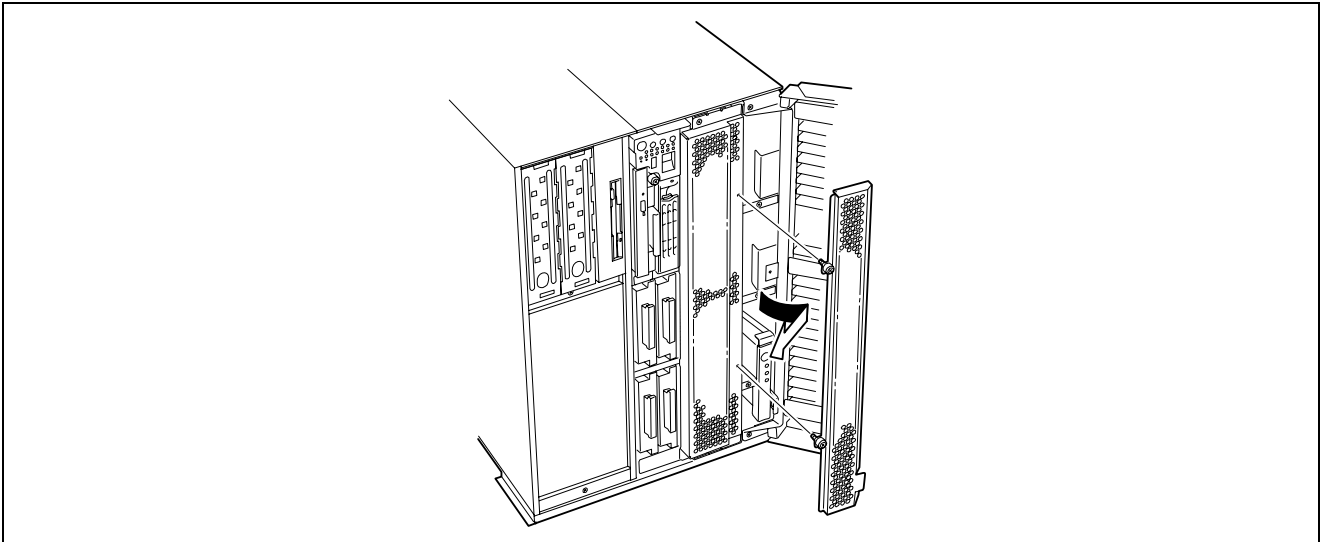

4. Unlock the memory board to open the ejector.

The memory board becomes very hot while being powered. When removing the board, turn off the power and wait for several minutes before pulling it out.

Note that the hot-plug memory board is off-powered when it is unlocked (the LED goes off). Wait several minutes in this state.

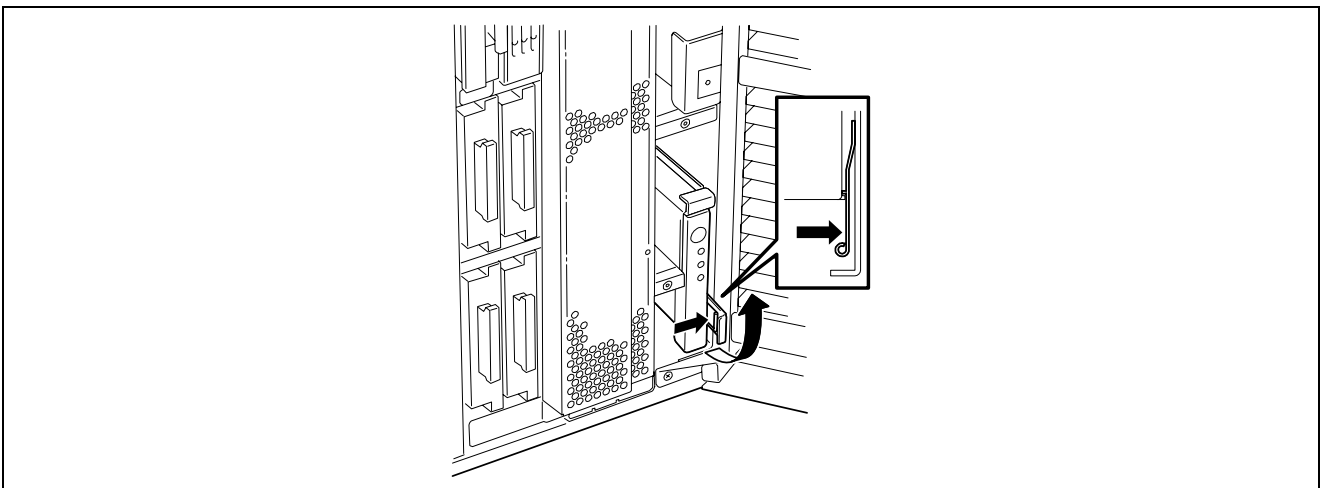

5. Hold the ejector and pull the memory board out from the server.

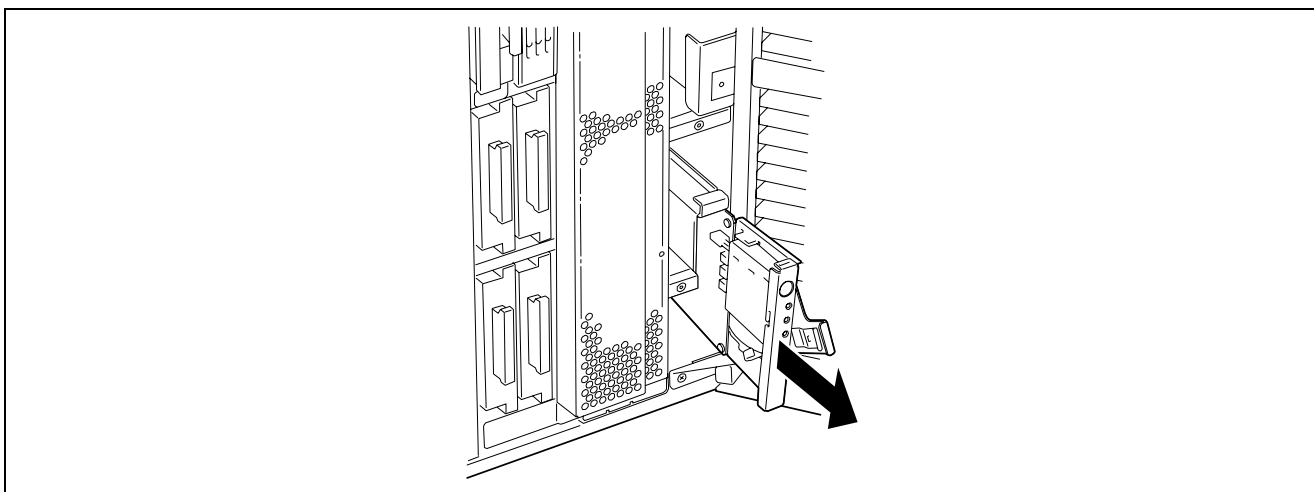

6. Put the memory board on a dry, clean, and static-free place.

Installation

Install the memory board in reverse order of the removal steps.

DIMM

Install an additional DIMM (Dual Inline Memory Module) in a DIMM socket on the memory board in the server. DIMMs are installed on the sockets in the ascending order of DIMM socket numbers in the unit of two modules.

NOTE: Up to 8 GB of memory (2 GB DIMM × 4) can be installed.

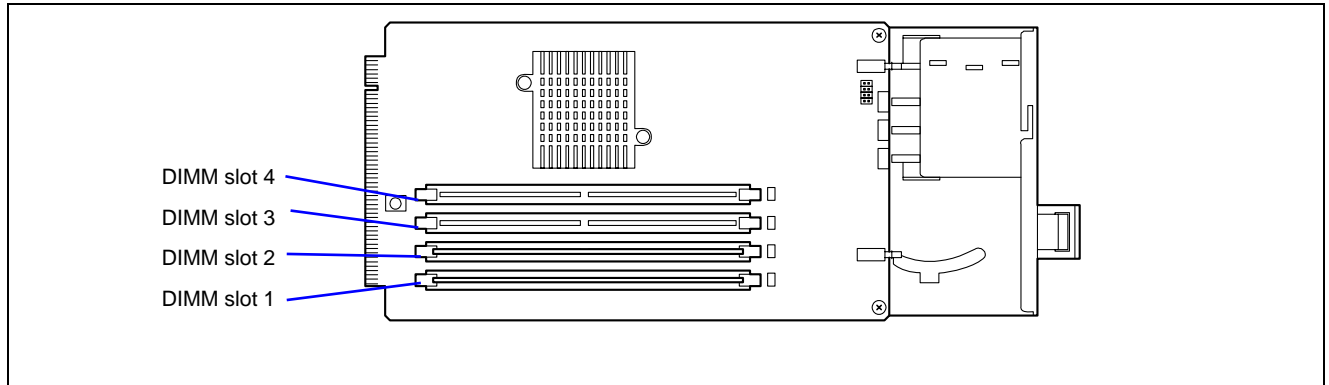

* DIMM specification is shown on the label attached to the DIMM as follows:

Example: Frequency of 400 MHz, buffered, capacity of 1GB, row address of 14 bits, column address of 11 bits, and single rank

2-400 / B / 1024 / R14 C11 S

Frequency Buffered / Registered Capacity Row address Column address Single rank

IMPORTANT: The last digit character indicates the symbol representing either of single rank (S) or dual rank (D).

If DIMMs of single rank and dual rank are installed on the same memory board, be sure to install the DIMM of dual rank in DIMM Group #1 (DIMM slots 1 and 2). Otherwise, the system will fail to start.

5. Fully open the levers at both ends of the socket (1) and remove the socket cover.

IMPORTANT:

- To avoid damaging the lever, do not apply an excess force to the lever.
 - Keep the removed blank cover for future use.
-

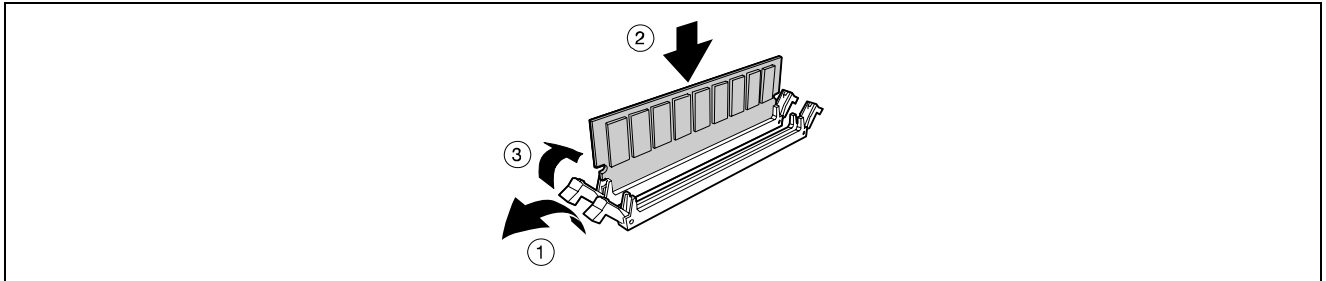

6. Push the DIMM straight into the socket (2).

NOTE: Make sure of the orientation of DIMM. The terminal side of the DIMM has a cut-out to prevent incorrect insertion.

The levers automatically close when the DIMM is inserted into the socket (3).

IMPORTANT: Always install the DIMMs in pair. Two DIMMs must be of the same specification. DIMM specification is shown on the label attached to the DIMM as follows:

Example: Frequency of 400 MHz, buffered, capacity of 1GB, row address of 14 bits, column address of 11 bits, and single rank

2-400	/	B	/	1024	/	R14		C11		S
Frequency		Buffered / Registered		Capacity		Row address		Column address		Single rank

7. Install the memory board back into the chassis slot.
8. Install the memory slot cover.
9. Power on the server and verify that POST displays no error messages.
If POST displays an error message, take a note on the message and see the POST error messages listed in Chapter 8.
10. Start the SETUP and select [Advanced] → [Memory Configuration] to verify that the installed DIMM shows the status "Normal". (See Chapter 4 for details.)
11. Select "Yes" for [Reset Configuration Data] on the [Advanced] menu.
This setting is required to change the hardware configuration data. See Chapter 4 for details.
12. If Windows Server 2003 or Windows 2000 is in use, set the paging file size to the recommended value (total memory size * 1.5) or a greater value. See Chapter 5 for details.

Removal

Remove a DIMM as follows:

IMPORTANT: The DIMM is extremely sensitive to static electricity. Make sure to touch the metal frame of the server to discharge static electricity from your body before handling the DIMM. Do not touch the DIMM terminals or on-board parts by a bare hand or place the DIMM directly on the desk. For static notes, see the section "Anti-static Measures" described earlier.

NOTE: To remove the failed DIMM, check the error message appearing in POST or ESM PRO to identify the DIMM socket (group) in which the failed DIMM is installed.

1. See the section "Preparing for Installation and Removal" described earlier to prepare.
2. Unlock the front door with the security key, and open the front door.
3. Remove the memory slot cover, and then remove the memory board on which the DIMMs to be removed are installed.

NOTE: The error lamp corresponding to the failing DIMM goes on.

4. Open the levers at both sides of the socket from which you remove the DIMM.(1).
The DIMM is unlocked and ready for removal.(2)

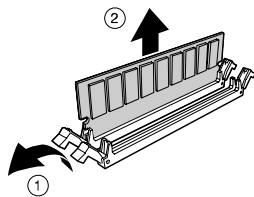

5. Install the memory board.
6. Install the memory slot cover.
7. Power on the server and verify that POST displays no error messages.
If POST displays an error message, take a note on the message and see the POST error messages listed in Chapter 8.
8. Start the SETUP and select [Advanced] → [Memory Configuration] → [Memory Retest] → [Enabled] to clear the error information of the removed DIMM. Then, select [Server] → [Clear FRU LED] → [Yes] to turn off the LED indicating DIMM error. (See Chapter 4 for details.)
9. Select "Yes" for [Reset Configuration Data] on the Advanced menu.

This setting is required to change the hardware configuration data. See Chapter 4 for details.

Memory Mirroring / Memory RAID Feature

Memory Mirroring Feature

The memory mirroring feature places a memory board as spare memory in standby state. If the current memory board encounters an uncorrectable error, the memory mirroring feature switches to the standby memory board. When this feature is used, the current memory board and the standby memory board should be combined. Available combinations are:

- Mirroring with memory boards 1 and 2
- Mirroring with a pair of memory boards 1 and 2 and a pair of memory boards 3 and 4

To enable the memory mirroring feature, the combined memory boards must have DIMMs of same capacities.

The table below shows combinations of memory boards installed.

	Memory board 1	Memory board 2	Memory board 3	Memory board 4
A	2GB (1GB*2)	2GB (1GB*2)	2GB (1GB*2)	2GB (1GB*2)
B	8GB (2GB*4)	8GB (2GB*4)	8GB (2GB*4)	8GB (2GB*4)
C	4GB (1GB*4)	4GB (1GB*4)	–	–

Memory RAID Feature

If one of the four memory boards encounters an uncorrectable error, the memory RAID feature switches to the other memory board to continue operation. To use this feature, four memory boards must be installed. Each memory board must have DIMMs of same capacities.

The table below shows combinations of memory boards installed.

	Memory board 1	Memory board 2	Memory board 3	Memory board 4
A	2GB (1GB*2)	2GB (1GB*2)	2GB (1GB*2)	2GB (1GB*2)
B	8GB (2GB*4)	8GB (2GB*4)	8GB (2GB*4)	8GB (2GB*4)
C	4GB (1GB*4)	4GB (1GB*4)	4GB (1GB*4)	4GB (1GB*4)

Setting BIOS

Start SETUP and select [Advanced] → [Memory Configuration] → [Memory RAS Feature] and set as follows:

- To enable the memory mirroring feature: Select [Mirror].
- To enable the memory RAID feature: Select [RAID].

Others

- Memory capacity displayed on the operating system = total capacity of physically installed memory – capacity for standby memory
Memory mirroring feature: 1/2 of actually installed memory capacity
Memory RAID feature: 3/4 of actually installed memory capacity
- Enabling the memory mirroring or memory RAID feature does not influence the operations of applications.
- Each feature is automatically disabled when an error message is displayed:

The following indicates that the memory mirroring /memory RAID feature has worked:

- a) The Redundancy lamp on the front panel of the server lights green.
- b) The failing DIMM group is degraded when the server restarts.
- c) If ESMPRO Agent has been installed, the following log is registered as a system log of Event Viewer:
Source name: ESMCommonService
Event ID: 2313
Explanation: Part of the DIMM was isolated due to a memory error.
Memory number: XX
Date/time: XX
- d) If report setting is made through ESMPRO Agent, Manager reporting and ALIVE reporting is performed.
The report contents are as follows:
Explanation: Part of the DIMM was isolated due to a memory error.
Memory number: XX
Date/time: XX

Memory Hot-Plug Feature 1 (Hot Replace)

In the memory redundant configuration such as memory mirroring and memory RAID configuration, the memory board can be removed while the operating system is running.

1. See the section "Preparing for Installation and Removal" described earlier to prepare.
2. Unlock the front door with the security key, and open the front door.
3. Remove the two screws and then remove the memory slot cover.

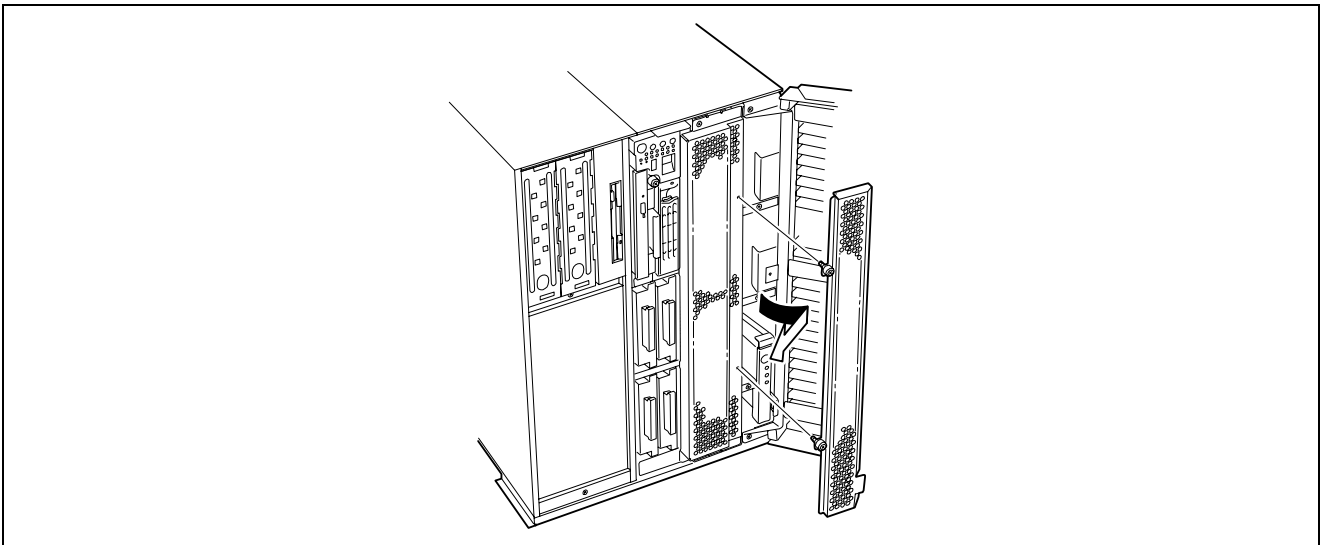

4. Press the Attention switch corresponding to the memory board to be removed.
The memory board power lamp and the memory board redundancy lamp for that board go off.

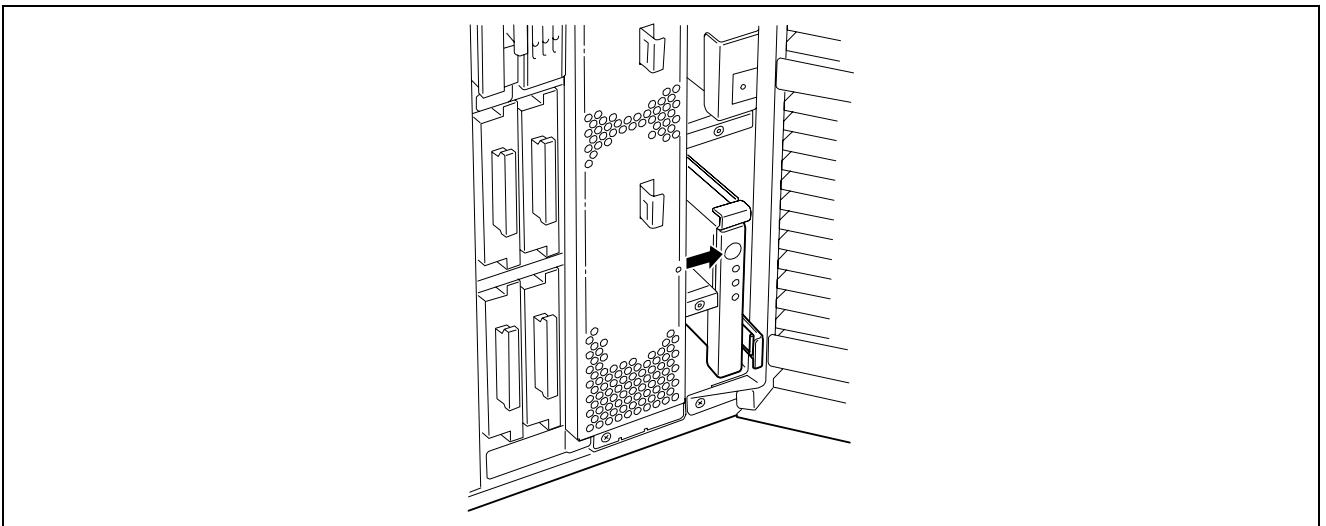

5. Make sure that the memory board power lamp goes off, then remove the memory board.

IMPORTANT: The memory board becomes very hot while being powered. When removing the board, turn off the power and wait for several minutes before pulling it out.

Note that the hot-plug memory board is off-powered when it is unlocked (the LED goes off). Wait several minutes in this state.

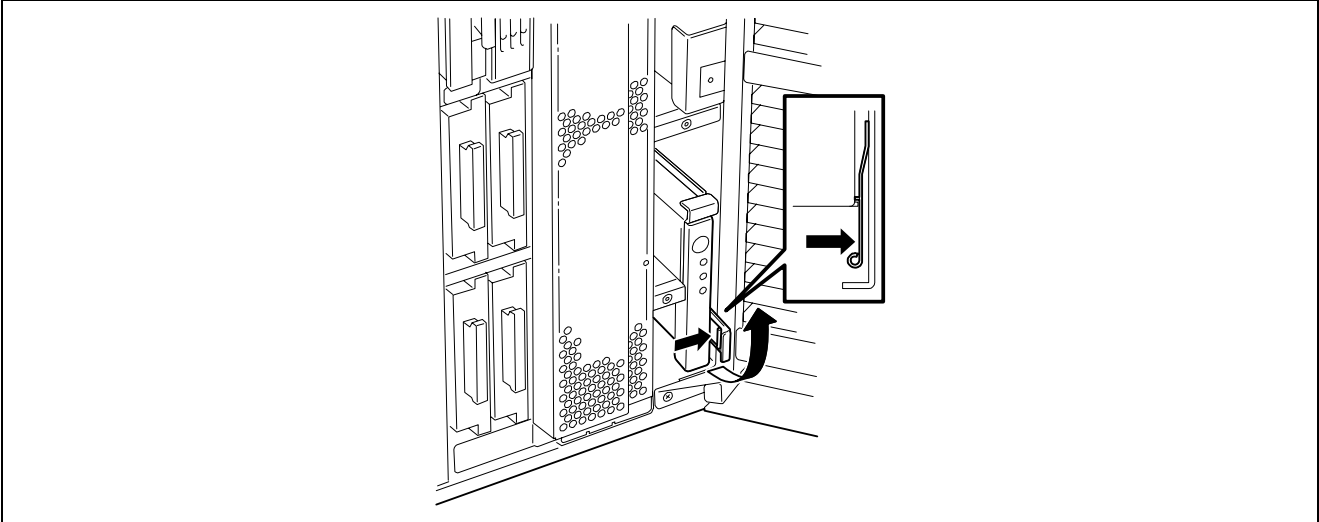

6. Hold the ejector and pull the memory board out from the server.

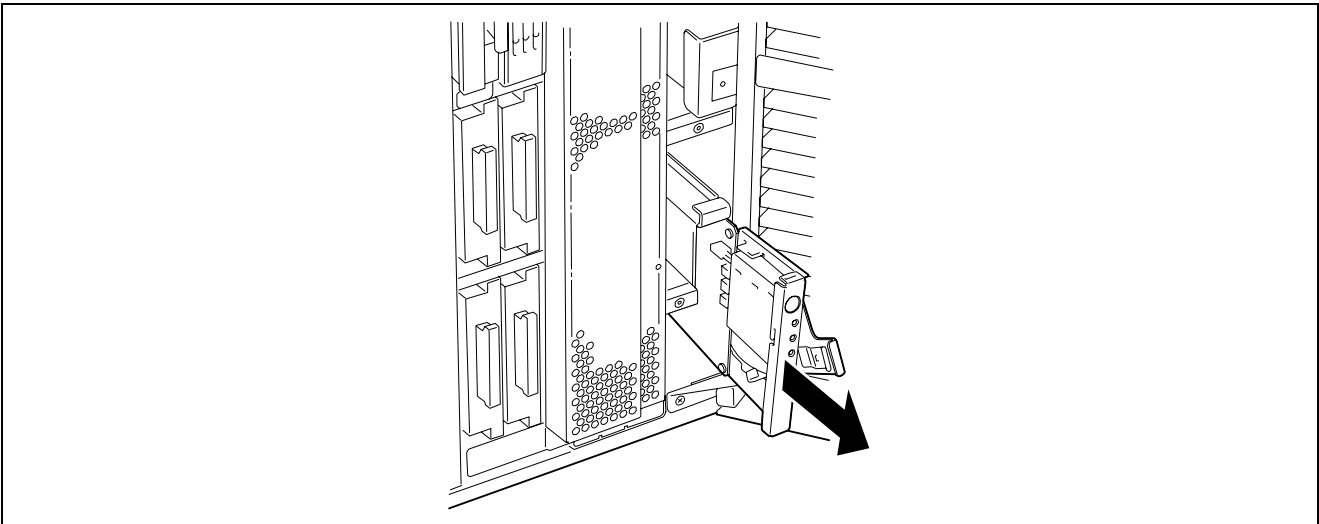

7. To set back the memory boards in redundant configuration, install the memory boards in reverse order of removal procedure. Then, press the Attention switch on the memory board. The memory board Power lamp starts flashing, and after a while, it goes on. The Memory Board Redundancy lamp goes on.

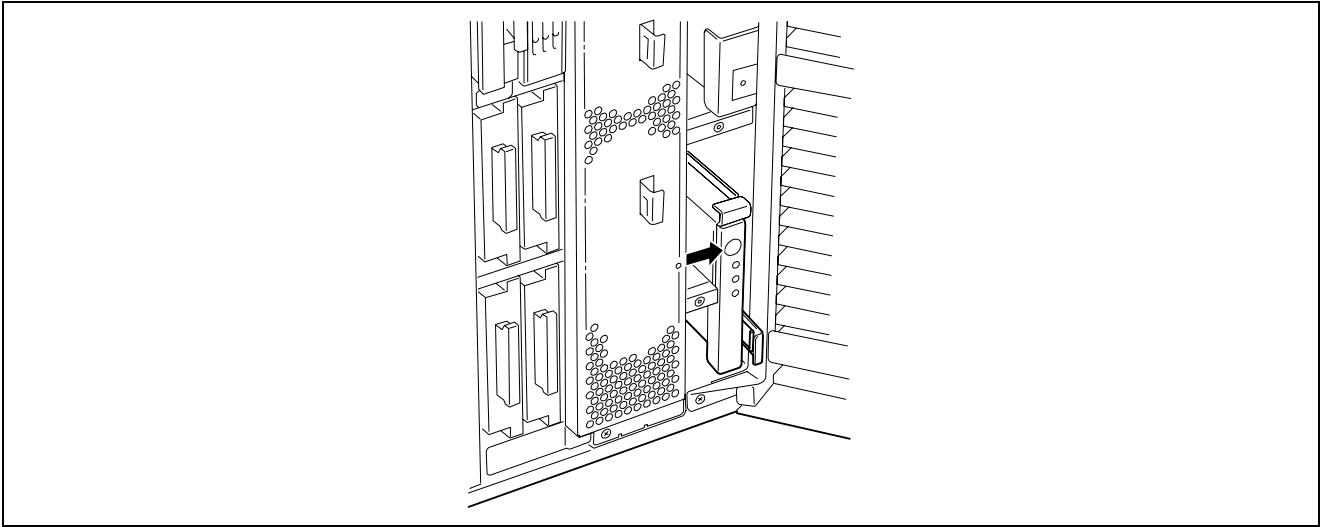

This completes Hot Replace of memory board.

Memory Hot-Plug Feature 2 (Hot Add)

In Windows Server 2003 Enterprise Edition, you can use the Hot-Add memory feature. The Hot Add feature allows you to add a physical memory without shutting down the system.

To use the Hot-Add memory feature, set the BIOS as follows:

Setting BIOS

Start SETUP and select [Advanced] → [Memory Configuration] → [Memory RAS Feature] in order and set as follows:

- To enable the Hot-Add memory feature in normal mode: Select [Normal].
- To enable the Hot-Add memory feature in mirroring mode: Select [Mirror].

NOTE: Before selecting [Mirror], the mirroring configuration must have been set for memory boards 1 and 2. In this case, the memory hot plug is used for memory boards 3 and 4. (Memory boards 3 and 4 must also be in mirroring configuration.)

In addition, be sure to specify [Advanced] → [Memory Configuration] → [Hot-add Memory Support] to "Enabled".

- Hot-Add memory feature in normal mode

When the operating system starts with memory board 1 (factory-installed), installing memory boards on which DIMMs are installed to memory board slots 2, 3, and 4 can increase the physical memory capacity. See Memory Hot-Plug Feature 1 for memory board installing procedure.

For example, if you insert a memory board into memory board slot 2 and press the Attention switch of that slot, the memory board Power lamp starts flashing and initialisation of memory is started.

When the memory board Power lamp stops flashing and goes on, the operating system is notified that the memory has been added.

The notification is processed on the operating system. After a while, you can view the added physical memory in performance monitor of task manager. Memory boards can be added to slots 3 and 4 in a similar procedure.

- Hot-Add memory feature in mirroring mode

Add the memory boards 3 and 4 while the memory boards 1 and 2 are configured to use the mirroring feature. In this case, memory boards 3 and 4 must be configured to use the mirroring feature. See Memory Hot-Plug Feature 1 for memory board installing procedure.

the only difference with normal mode is that the memory board is added to slot 3, and there is no change in system status. Adding a memory board to memory board slot 4 can make the memory mirroring configuration. And it is notified to the operating system. After a while, you can view the added physical memory in performance monitor of task manager.

You can confirm that a half of installed physical memory capacity is added. In memory mirroring configuration, the memory board additionally installed by using the Hot-Add memory feature can be hot-replaceable.

- Indication on ESMPRO Data Viewer after Hot-Add Memory

If you add a memory board dynamically by using Hot-Add feature, the added memory size will not be indicated on Data Viewer of ESMPRO Manager unless the system is rebooted.

Processor Board

To install or remove a processor, remove the processor board.

Removal

Remove the processor board as follows:

IMPORTANT: The processor board is extremely sensitive to static electricity. Make sure to touch the metal frame of the server to discharge static electricity from your body before handling the processor board. Do not touch the processor board terminals or on-board parts by a bare hand or place the processor board directly on the desk. For static notes, see the section "Anti-static Measures" described earlier.

1. See the section "Preparing for Installation and Removal" described earlier to prepare.
2. Unlock the front door with the security key, and open the front door.
3. Remove the memory board cover.
4. Remove the two screws and then remove the processor board cover.

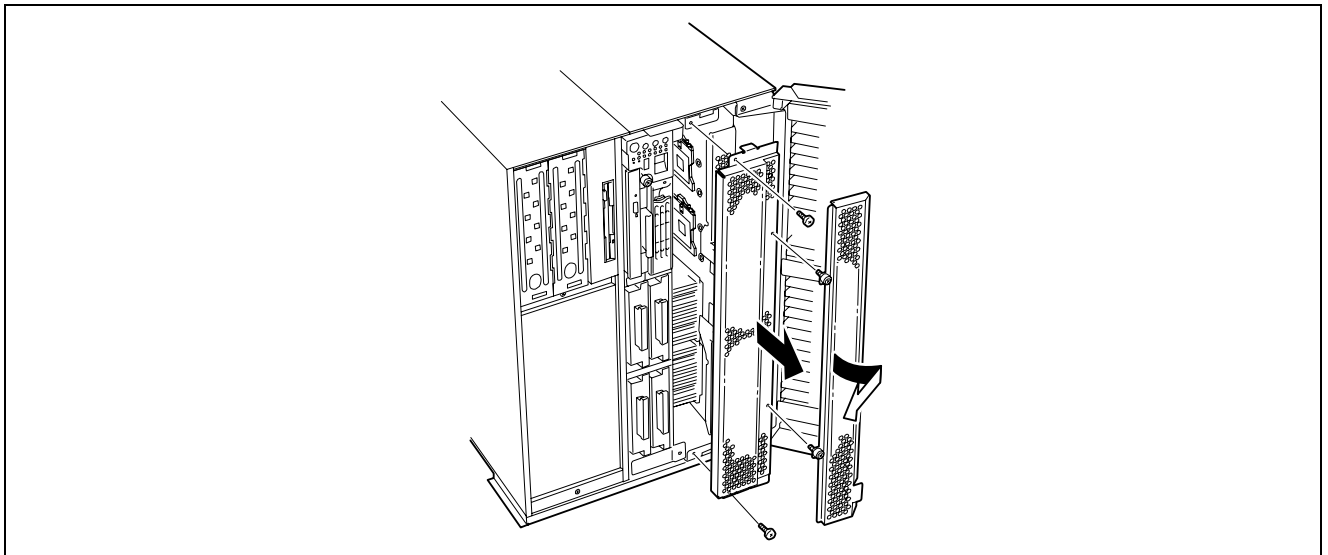

5. Remove the two screws securing the ejectors.

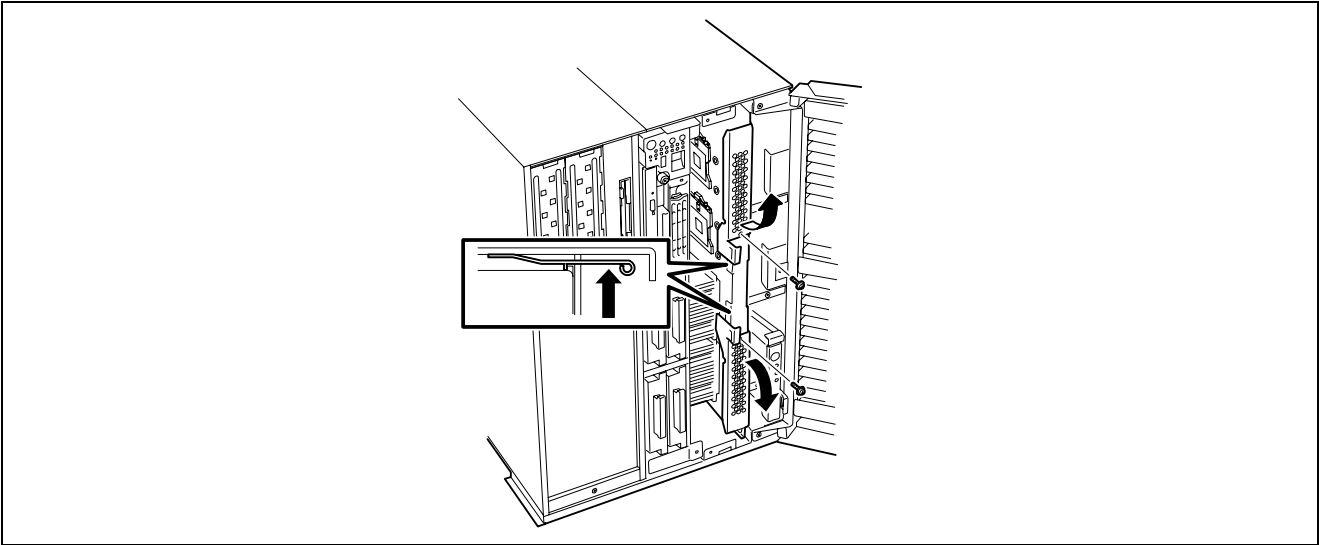

6. Unlock the processor board and open the ejectors.

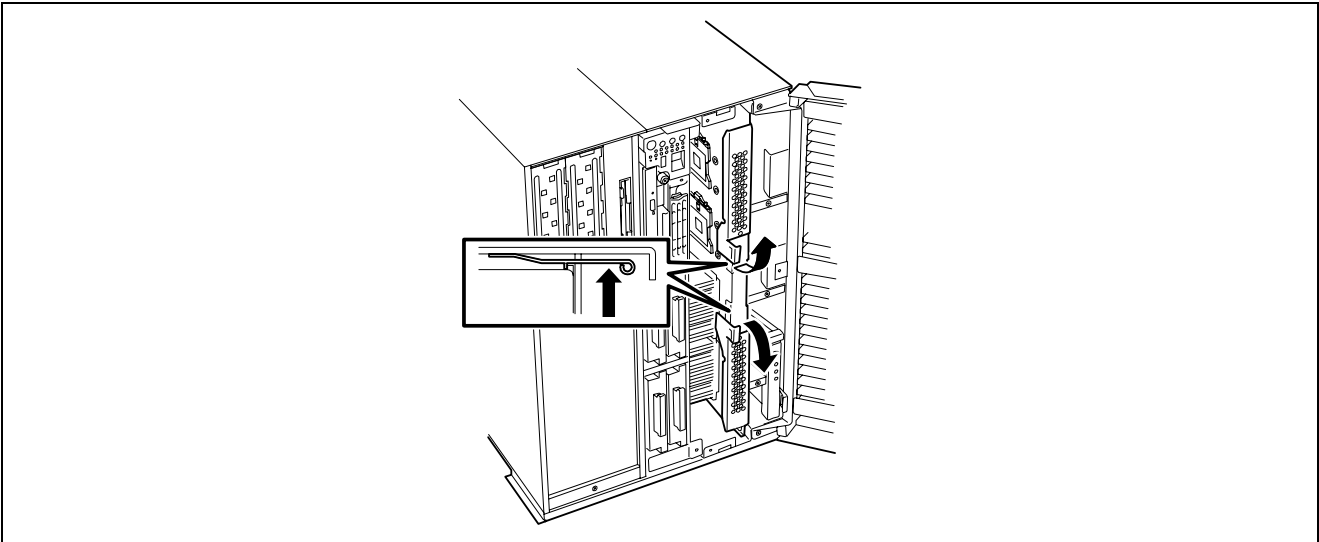

7. Firmly hold the processor board and pull it out from the chassis.

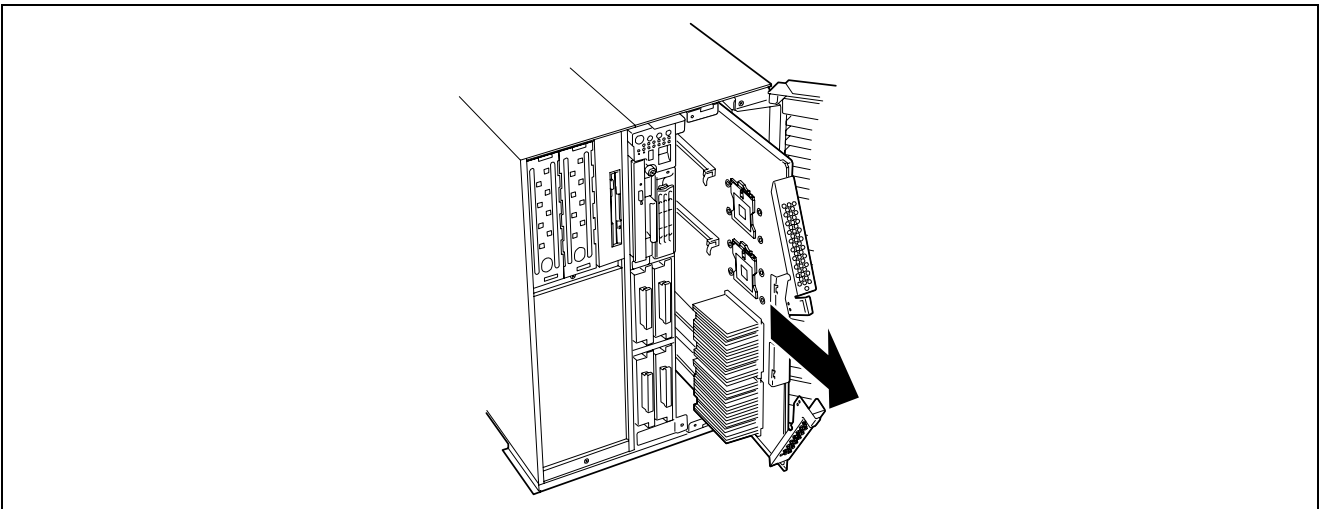

NOTE: Notes when removing the processor board

The processor board is very heavy (max. 7 kg). Pay attention not to drop it.

8. Put the processor board on a dry, clean, and static-free place.

Installation

Install the processor board in reverse order of the removal steps.

Processor

The processor board is equipped with sockets to install four 64-bit Intel® Xeon™ processors MP and corresponding VRMs. (One processor and one VRM are factory-installed.)

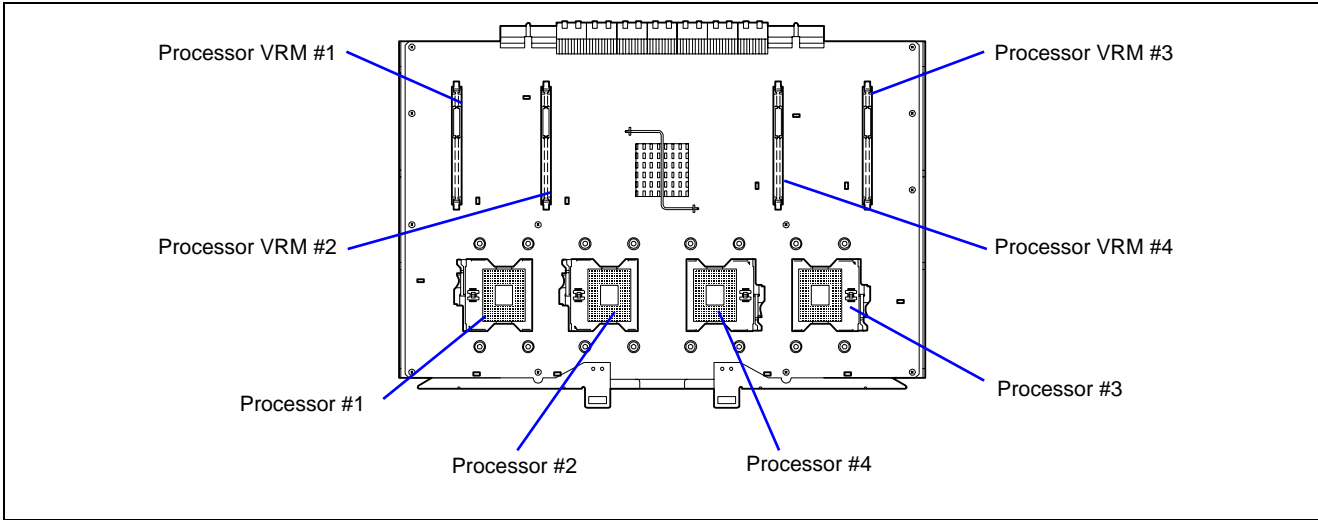

NOTE: If different revisions of processors are installed in a multiprocessor system, Windows 2000 logs the following information every start-up. If this message is logged, it is no problem for operation.

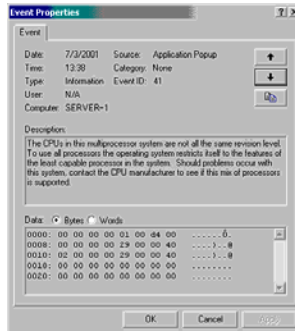

Installation

Install a processor as follows:

IMPORTANT:

- The processor is extremely sensitive to static electricity. Make sure to touch the metal frame of the server to discharge static electricity from your body before handling the processor. Do not touch the processor pins by a bare hand or place the processor directly on the desk. For static notes, see the section "Anti-static Measures" described earlier.
 - When using the server in the single processor configuration, processor must be installed on Processor #1 socket.
 - Install the processor in the ascending order of the processor number (see figure above).
 - To maintain the cooling effect in the server, install a dummy cover to the empty slot.
-

1. See the section "Preparing for Installation and Removal" described earlier to prepare.
2. Unlock the front door with the security key, and open the front door.
3. Remove the memory slot cover.
4. Remove the processor slot cover.
5. Remove the processor board.
6. Locate the processor socket in which you are going to install the processor, remove four screws, then remove the dummy cover from the socket.

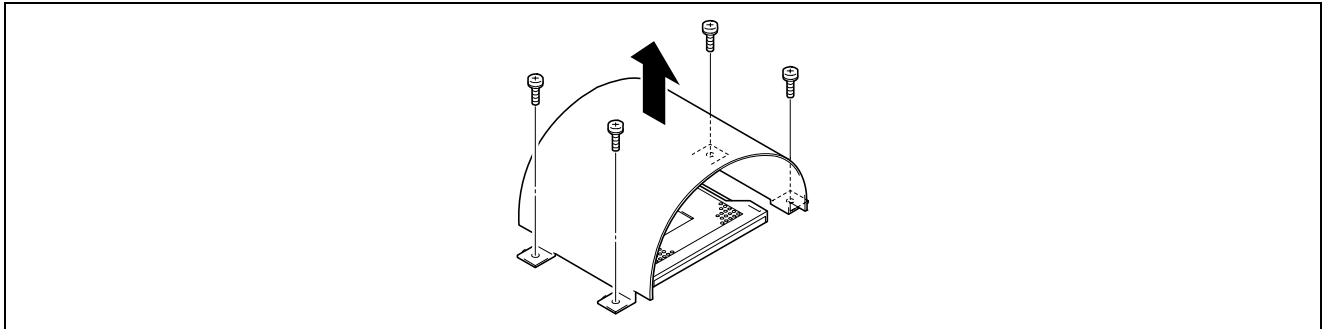

7. Remove the protective cover from the socket surface.
8. Raise the locking lever on the socket.

IMPORTANT: Open the lever until it stops. It can be opened to approximately 120 degrees.

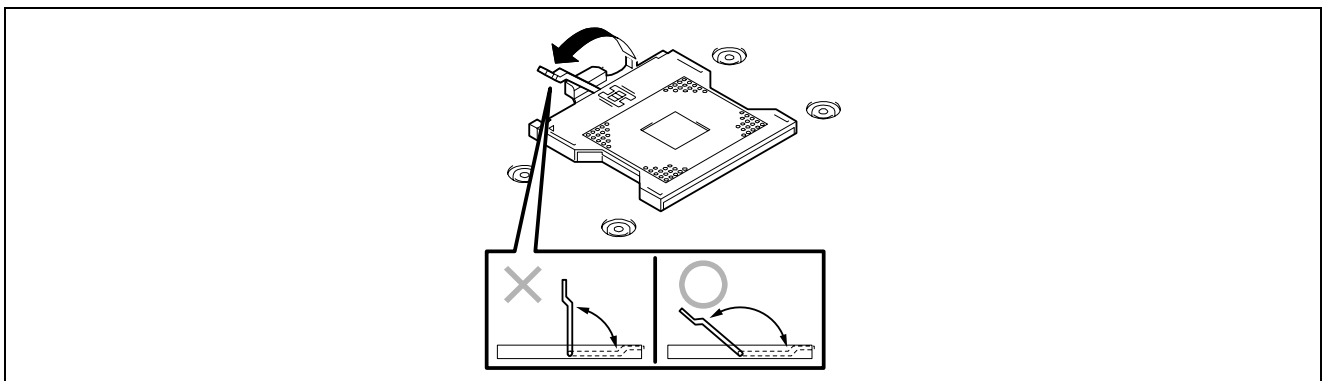

- Put the processor on the socket slowly and gently.

NOTE: Make sure of the orientation of the processor. Pin layouts on two corners among four differ from others to prevent an incorrect insertion. Confirm the pin mark and pin layout on the socket, and insert the processor correctly.

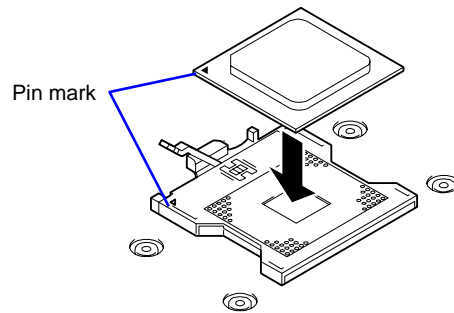

- Push the processor lightly to the socket, and push down the lever to secure the processor.

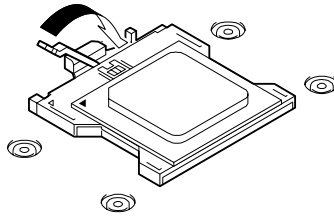

- Remove the cooling sheet from the bottom of the heat sink, and put the heat sink on processor.

NOTE: You do not need to care of the direction of heat sink.

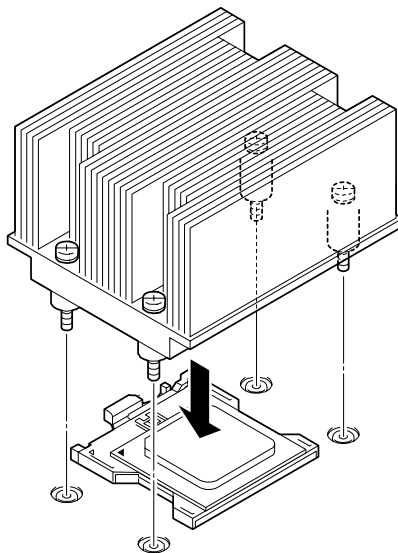

12. Tighten the four screws to secure the heat sink.

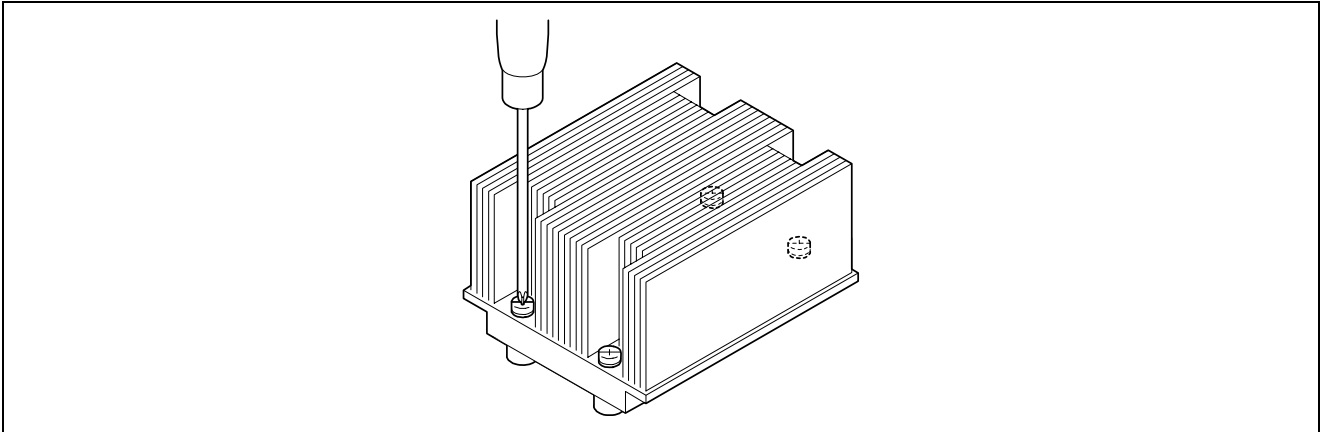

13. Make sure that the heat sink is level.

IMPORTANT: If the heat sink is not level, remove it, and check if the processor is positioned correctly.

14. Fully open the levers on both sides of the VRM socket.

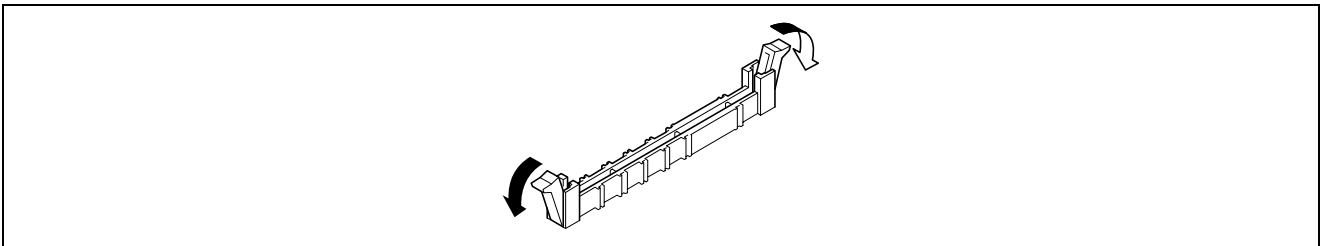

15. Push the VRM straight into the socket.

When the VRM is inserted into the socket, the lever automatically closes. Push the lever toward inside to securely close the lever.

NOTE: Make sure of the orientation of the VRM. The terminal side of VRM has a cut-out to prevent the incorrect insertion.

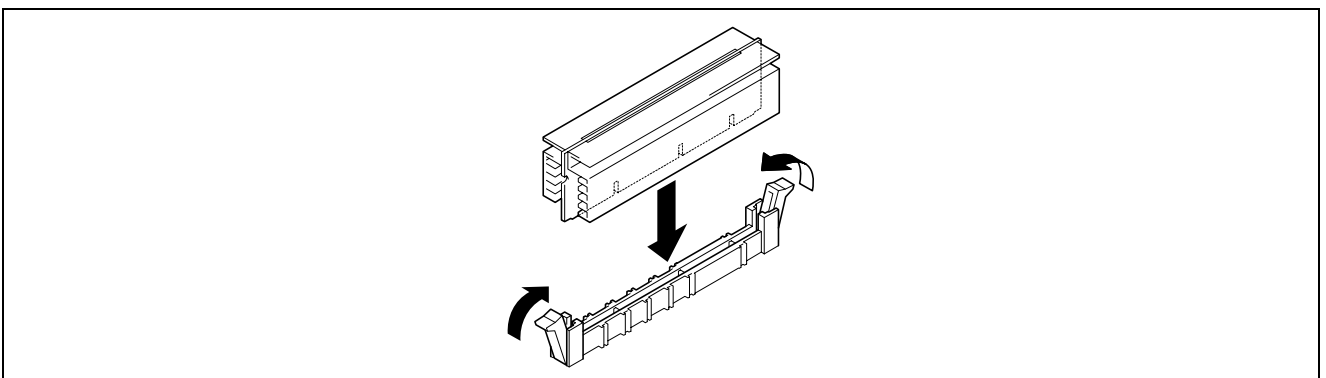

16. Install the components you removed previously.

17. Start SETUP and select "Yes" for [Reset Configuration Data] on the Advanced menu.
This setting is required to change the hardware configuration data. See Chapter 4 for details.
18. To add one or more processors to the server in 1-processor configuration to operate the server with more than one processor, do the procedure below:
For Windows Server 2003 or Windows 2000, change the driver of [Computer] in the device manager to [ACPI multi-processor PC] and then update the system (see Chapter 5).

Removal

To remove the processor, prepare the removal referring to steps 1 to 5 of the installation procedure and do the reverse procedure of steps 8 to 12.

IMPORTANT:

- Do not remove any processor unless it is failed.
 - To maintain the cooling effect in the server, a dummy cover is installed in the empty slot. Be sure to install a dummy cover on the slot where the processor is not installed.
 - After the operation, heat may make the cool seat at the bottom of the heat sink adhere to the processor. To remove the heat sink from the processor, first turn the heat sink to the left and right lightly to make sure that the heat sink can be set apart from the processor. Removing the heat sink with it adhering to the processor may cause the processor and/or socket to be damaged.
-

Do as follows if a processor is removed (or replaced):

1. Start SETUP, select menus "Main" – "Processor Settings" – "Processor Retest" in order to clear the error information on the removed processor (see Chapter 4).
When a processor is replaced, select menus "Main" – "Processor Settings" to confirm that the ID and L2 and L3 Cache of the additional processor are defined correctly (see Chapter 4).
2. Select "Yes" for [Reset Configuration Data] on the Advanced menu.
This is required to update the hardware configuration information. See Chapter 4 for details.

Appendix A

Specifications

Item		Express5800/140He		
Model type at shipment		Diskless		
Processor	Type	64-bit Intel® Xeon™ Processor MP		
	Clock/2nd cache	3.16 GHz/1 MB	3.66 GHz/1 MB	3.33 GHz/8 MB (on specific configurations only)
	Number of processors	1		
	Maximum	4		
Chipset		Intel TwinCastle + ICH5 + Dobson + PXH		
Memory	Standard	2 GB (1 GB×2)		
	Maximum	32 GB (The standard DIMMs must be replaced.)		
	Expansion unit	2 DIMMs		
	Expansion times	Maximum 8 times (2 times per each memory board)		
	Memory module	DDR2 400 SDRAM DIMM (Registered)		
	Error check	ECC		
	Memory mirroring feature Online sparing memory feature Memory Hot-add/Hot-replace feature Memory RAID feature	Supported		
Graphics (VRAM)		ATI® Radeon® 7000M (VRAM 16MB)		
Auxiliary input device	Floppy disk (standard)	–		
	Hard disk (standard)	–		
	Hard disk (maximum)	1500 GB (300 GB × 5) + 2400 GB (300 GB × 8, Additional HDD cage is required)		
	CD-ROM (standard)	ATAPI Interface × 1 (Load on tray type, x24 speed)		
5.25-inch device bay		2 slots (Full height x1)		
3.5-inch disk bay		Up to 13 slots (Hot-swappable, Additional HDD cage is required)		
Additional slot	PCI-X 100MHz (64-bit)	4 slots (Hot-swappable)		
	PCI 33MHz (32-bit)	2 slots		
	PCI EXPRESS(x8)	2 slots (Hot-swappable)		
	PCI EXPRESS(x4)	1 slot		
LAN interface		1000BASE-T/100BASE-TX/10BASE-T (2 port)		
LAN interface (A-RMC)		100BASE-TX/10BASE-T (1 port, dedicated for server management)		

Item		Express5800/140He
External interface	Keyboard	MINI DIN 6-pin connector (1 port)
	Mouse	MINI DIN 6-pin connector (1 port)
	USB	4-pin (3 ports; front: 1 (USB1.1), rear: 2 (USB2.0))
	Serial	D-sub 9-pin (2 ports, rear), RJ-45 (1 port, front (exclusively used with either port on the rear panel))
	Parallel	D-sub 25-pin (1 port)
	Network	RJ-45 (2 ports and 1 management port)
	Display	MINI D-sub 15-pin (1 port)
	SCSI	–
Cabinet design		Middle-Tower
External dimensions		310 (width) × 456 (height) × 805 (depth) mm
Weight		75 kg (Max.)
Power supply		100 to 127 Vac ±10%, 200 to 240 Vac ±10%, 50/60 Hz ±1Hz
Power consumption		1800 VA
Environmental requirements	Temperature	10 to 35°C
	Humidity	20 to 80% RH (no condensation)
Others		NEC EXPRESSBUILDER supported, NEC ESMPRO provided in the standard configuration

Appendix B

Other Precautions

Transfer Rate of the On-board LAN Controller

The LAN controller on the IO board has two ports. Each port supports 10Base-T, 100Base-TX, and 1000Base-T networks and is capable of full or half duplex.

The controller can automatically detect and switch for network speed and transfer mode connected to the HUB. However, for proper network operation, specify the "Link Speed & Duplex" value the same as the value specified for the HUB.

Server Management Software

The NEC EXPRESSBUILDER CD-ROM that comes with the server contains the NEC ESMPRO utility.

We recommend that you should install NEC ESMPRO for effective use of the reliability enhancement features of the server.

Floppy Disk

The following describes use of the floppy disk.

Floppy disk type

The server uses 3.5-inch floppy disks. You can use the following two types of 3.5-inch floppy disks:

- 2HD floppy disk (double-sided high-density track type)
Stores data of 1.44 MB.
- 2DD floppy disk (double-sided double-density track type)
Stores data of 720 KB.

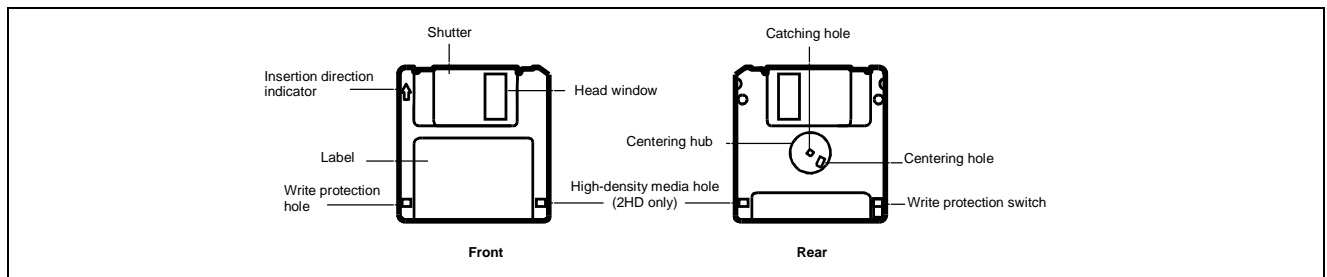

Notes on use

The floppy disk is an important data storage media with delicate structure and requires care. Keep the following notes in mind to use it:

- Insert the floppy disk into the floppy disk drive gently as far as it goes.
- Attach the label to the correct position.
- Do not write anything directly onto the disk surface with a pencil or ball-point pen.
- Do not open the shutter.
- Do not use the floppy disk in a dusty place.
- Do not place anything on the floppy disk.
- Do not leave the floppy disk in a high-temperature place (e.g., place exposed to direct sunlight or close to a heater).
- Do not leave the floppy disk with foods and drinks, or in a place exposed to cigarette smoke.
- Do not leave the floppy disk near any form of liquid or a chemical or in a place where a chemical may be accidentally sprayed over them.
- Do not place any magnetic objects (e.g., magnet) near the floppy disk.
- Do not clip the floppy disk or drop it.
- Keep the floppy disk in a floppy disk case that protects it from magnetism and dust.
- Write-protection

A floppy disk has a write-protect switch that prevents the stored data from accidental erasure.

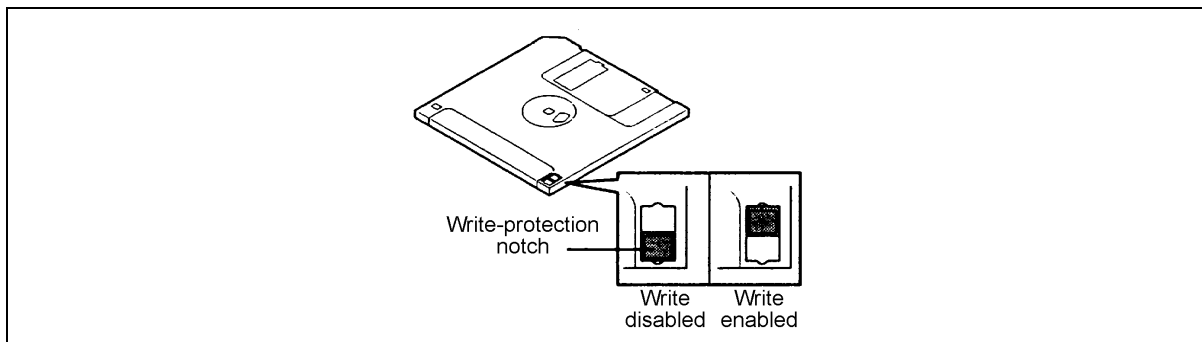

You can read data from a write-protected floppy disk, but you cannot save data into the floppy disk or format it. We recommend that you should write-protect any floppy disk containing valuable data unless you are about to save data.

To write-protect a 3.5-inch floppy disk, use the write-protect switch provided on its back.

■ Disk format

To write data into a floppy disk, the floppy disk must be "formatted." "Formatting" is to initialise the floppy disk and make it available for the system environment (operating system).

IMPORTANT:

- Formatting a used floppy disk clears all the data contained in it, if any.
 - Formatting a floppy disk from the DOS command line is not available with the server.
Use a formatted floppy disk to work with it on the DOS command line.
-

The format method depends on your operating system. Refer to the manual that comes with your operating system for details.

- Data backup

"Data backup" is to copy data stored in a media into another media (e.g., floppy disk, digital audio tape, or magnet-optical disk).

IMPORTANT: Make sure to make a back-up copy of every floppy disk, if provided.

The floppy disk is a very delicate storage media. Dust or thermal changes, as well as operator's misconduct or sever failures, may cause loss of data. To avoid loss of data, we recommend that you should make a back-up copy of your valuable data on a regular basis.

CD-ROM

Keep the following notes in mind to use the CD-ROM for the server:

- Press the centre of the storage case to remove the CD-ROM from the case.
- Do not drop the CD-ROM.
- Do not place anything on the CD-ROM or bend the CD-ROM.
- Do not attach any label onto the CD-ROM.
- Do not touch the signal side (nothing is printed on this side) with your hand.
- Place the CD-ROM with its printed side upward and gently put it on the tray.
- Do not scratch the CD-ROM or write anything directly on it with a pencil or ball-point pen.
- Do not leave the CD-ROM with foods and drinks, or in a place exposed to cigarette smoke.
- Do not leave the CD-ROM in a high-temperature place (e.g., place exposed to direct sunlight or close to a heater).
- When dust or fingerprints are attached on the CD-ROM, wipe the CD-ROM from its centre to edge with a dry soft cloth slowly and gently.
- Use CD cleaner to clean the CD-ROM. Do not use record spray/cleaner, benzene, or thinner.
- Keep the CD-ROM in a CD-ROM case when not in use.

Tape Media

The following describes data handling with the DAT, DLT, or AIT optionally available for the server.

- Saving your valuable data

When you save your valuable data or programs into the cartridge tape, you should save them into two cartridge tapes to make the primary and secondary tapes.

This enables you to restore your data from one tape when the other makes a read error, as well as to protect your valuable data and programs from loss.

- Three-generation data management

We recommend that you should employ three-generation data management for data storage.

Three-generation data management uses three cartridge tapes: A, B, and C. You save data to tape A on the first day, tape B on the second day, tape C on the third day, tape A on the fourth day, and so on. That is, you save data into cartridge tapes cyclically from tape A through C.

This enables you, for example, to use tape B to restore the data when tape C makes a read error. Also when both tapes B and C make a read error, you can restore your valuable data by using the data stored in tape A.

Keyboard

The keyboard is a device to instruct your computer by entering alphanumeric characters or symbols.

IMPORTANT:

- Do not pour any liquid such as water or put anything into the keyboard. Doing so may cause a failure of the keyboard.
- The keyboard provided with the server is designed for adjustment of an angle. Adjust the keyboard angle at which the keyboard is easy to operate. The adjustment assists in reducing strain on your shoulders, arms, and fingers.

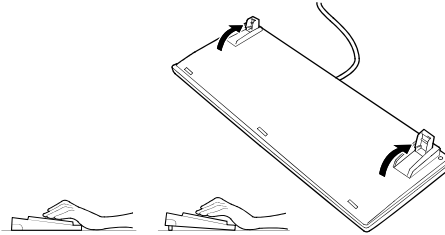

NOTE: The keyboard functions depend on the software. Refer to the manual that comes with the software for details.

Mouse

Like the keyboard, the mouse is a device to instruct your computer. Many operating systems and application software require the mouse for operation.

NOTE:

- Functions assigned to the mouse buttons vary depending on the software. For details, refer to the manual provided with the software.
- Use the mouse on a clean desk. Using the mouse on a dusty or dirty desk disturbs smooth movement or normal operation of the mouse. When your mouse movement seems dull, clean your mouse. (See Chapter 7.)

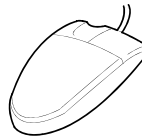

Mouse operation includes "Click," "Double-click," and "Drag."

- Click: Press the button only once and release it.
Double-click: Press the button twice consecutively and release it.
Drag: Press and hold the button and move the mouse.

Operation of the server involves combinations of these mouse operations and data entries with the keyboard.

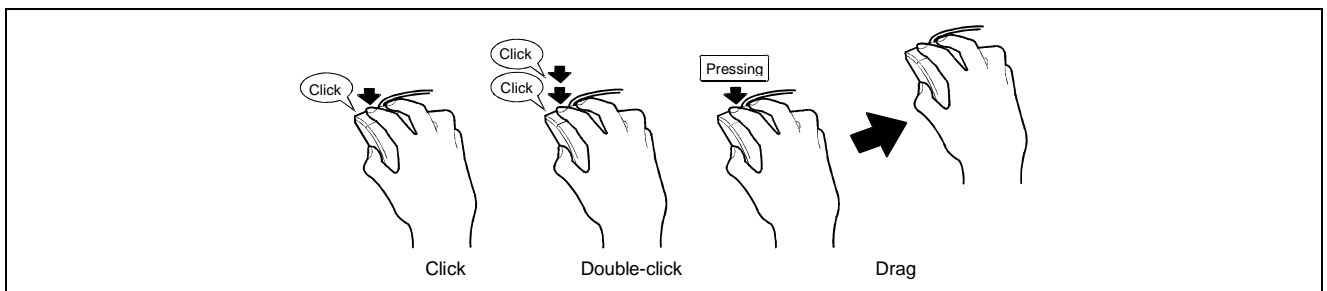

This page is intentionally left blank

Appendix C

IRQ and I/O Port Address

The factory-set interrupt requests and I/O port addresses are listed below. Find an appropriate one to install an optional device.

Interrupt Request

The factory-set IRQs are assigned as follows:

IRQ	Peripheral Device (Controller)	IRQ	Peripheral Device (Controller)
0	System timer	8	Real-time clock
1	Keyboard	9	PCI/SCI
2	Cascaded connection	10	PCI
3	COM B serial port (PCI)	11	BMCIRQ/PCI
4	COM A serial port (PCI)	12	Mouse
5	PCI/LPT2 parallel port	13	Numeric processor
6	Floppy disk	14	Primary IDE (CD-ROM drive)
7	LPT1 parallel port	15	PCI

PIRQ and PCI Device

The factory-set PCI device interrupts are assigned as follows. You can change these interrupts by using the BIOS SETUP, however, use the factory-set interrupts as they are. See Chapter 4 for details.

	PIRQ1	PIRQ2	PIRQ3	PIRQ4	PIRQ5	PIRQ8
USB#1	√					
USB#2				√		
USB20						√
IDE (native mode)			√			
SMBus		√				
VGA					INTA	
RAID			INTA			
LAN			INTA	INTB		
PCISlot#1 (PCI)	INTB		INTA			INTC INTD
PCISlot#2 (PCI)		INTA		INTB		INTC INTD
PCI Slot#3(PCI-EXPRESS)	INTA	INTB	INTC	INTD		
PCI Slot#4 (PCI-EXPRESS)	INTA	INTB	INTC	INTD		
PCI Slot#5 (PCI-EXPRESS)	INTA	INTB	INTC	INTD		
PCI Slot#6 (PCI-X)	INTB INTD		INTA INTC			
PCI Slot#7 (PCI-X)		INTB INTD		INTA INTC		
PCI Slot#8 (PCI-X)	INTA INTC		INTB INTD			
PCI Slot#9 (PCI-X)		INTA INTC		INTB INTD		

I/O Port Address

The factory-set I/O port addresses for the server are assigned as follows:

Addresses	Description	Chip
00-08h	DMA Control Registers	ICH5
09-0Eh	RESERVED	ICH5
0Fh	DMA Control Register	ICH5
10-18h	DMA Control Register	ICH5
19-1Eh	RESERVED	ICH5
1Fh	DMA Control Register	ICH5
20-21h	Master 8259 Programming Interface	ICH5
24-25h	Master 8259 Programming Interface	ICH5
28-29h	Master 8259 Programming Interface	ICH5
2C-2Dh	Master 8259 Programming Interface	ICH5
2E-2Fh	Configuration Registers	PC87417
30-31h	Master 8259 Programming Interface	ICH5
34-35h	Master 8259 Programming Interface	ICH5
38-39h	Master 8259 Programming Interface	ICH5
3C-3Dh	Master 8259 Programming Interface	ICH5
40-42h	8254 Programming Interface	ICH5
43h	RESERVED	ICH5
4E-4Fh	Configuration Registers	PC87417
50-52h	8254 Programming Interface	ICH5
53h	RESERVED	ICH5
60h	Keyboard/Mouse	PC87417
61h	NMI Status Register	ICH5
62h		PC87417
63h	NMI Status Register	ICH5
64h	Keyboard/Mouse	PC87417
65h	NMI Status Register	ICH5
66h		PC87417
67h	NMI Status Register	ICH5
70h	RESERVED	ICH5
71h	RTC (data)	ICH5
72h	RTC (data)	ICH5
73h	RTC (data)	ICH5
74h	RTC (data)	ICH5
75h	RTC (data)	ICH5
76h	RTC (data)	ICH5
77h	RTC (data)	ICH5
80-91h	16-bit DMA Control Registers	ICH5
92h	Port 92 Register	ICH5
93-9Fh	DMA Control Register	ICH5
A0-A1h	Slave 8259 Programming Interface	ICH5
A4-A5h	Slave 8259 Programming Interface	ICH5
A8-A9h	Slave 8259 Programming Interface	ICH5
AC-ADh	Slave 8259 Programming Interface	ICH5
B0-B1h	Slave 8259 Programming Interface	ICH5
B2-B3h	Power Management	ICH5
B4-B5h	Slave 8259 Programming Interface	ICH5
B8-B9h	Slave 8259 Programming Interface	ICH5
BC-BDh	Slave 8259 Programming Interface	ICH5
C0-D1h	DMA Controller Page Registers	ICH5
C2-DDh	RESERVED	ICH5
DE-DFh	DMA Controller Page Registers	ICH5
F0h	Reset IRQ13	ICH5
102h	VGA	Radeon7000M
170h-177h	Secondary IDE Command Block Registers	ICH5

Addresses	Description	Chip
1F0h-1F7h	Primary IDE Command Block Registers	ICH5
278-27Fh	(Parallel Port 3)	PC87417
2F8-2FFh	Serial port 2	PC87417
376h	Secondary IDE Control Block Registers	ICH5
370-377h	(Floppy disk 2), IDE 2	PC87417
378-37Fh	(Parallel Port 2)	PC87417
3B0-3BBh	VGA	Radeon7000M
3BC-3BEh	Parallel port 1	PC87417
3C0-3CFh	VGA	Radeon7000M
3D4-3D5h	VGA	Radeon7000M
3F6h	Primary IDE Control Block registers	ICH5
3F0-3F7h	Floppy disk 1,IDE 1	PC87417
3F8-3FFh	Serial port 1	PC87417
40Bh	DMA1 Extended Write Mode Register	ICH5
4D0h	Master 8259 ELCR Programming	ICH5
4D1h	Slave 8259 ELCR Programming	ICH5
CF9h	Turbo and Reset Control	TwinCastle

*1 Hexadecimal notation

*2 The I/O port address of a PCI device is set according to its type and number.

Appendix D

Installing Windows Server™ 2003 x64 Editions

This section describes the procedures for installing Windows Server 2003 x64 Edition without using Express Setup tool.

BEFORE INSTALLING Windows Server 2003 X64 EDITIONS

Please read carefully the following information BEFORE beginning your Windows Server 2003 x64 Edition Installation.

Optional Boards Supported by NEC EXPRESSBUILDER

NEC EXPRESSBUILDER CD-ROM attached to your system supports the following optional boards:

NOTE: If you want to install other boards by using a driver floppy disk ("OEM-FD for Mass storage device") than the ones listed below, see "Exceptional setup" and "Installing Optional Mass Storage Driver" of "Configuration Diskette Creator" in Chapter 6.

- Supporting installation of the operating system in NEC EXPRESSBUILDER
 - On Board RAID (Controller on the I/O board)
 - SecuRAID321 Disk Array Controller (SCSI 2ch)
- Other optional boards
 - Adaptec 29320 SCSI Controller
 - SCSI U160 PCI-ATX-64b 1 Disk Controller

Updating System

If you modified the Windows system, execute "Update Express5800 system" in Master Control Menu.

Re-installing to the Hard Disk Which Has Been Upgraded to Dynamic Disk

If you want to leave the existing partition when installing the system on the hard disk upgraded to Dynamic Disk, note the following issue:

- Do not select the partition where the operating system had been installed as the partition to install the operating system newly.
- Select "Use the current File System" for the format of the operating system partition.

MO Device

If you specify the file system as NTFS with MO Device connected during the installation, the file system will not be converted normally. Disconnect MO Device and restart the installation from the beginning.

Media such as DAT

During the operating system installation, do not attach unnecessary media for operating system installation to the system, such as DAT.

Partition Size

The size for the partition that the system is to be installed can be calculated from the following formula.

Size necessary to install the system + Paging File Size + Dump File Size + Application Size
Size necessary to install the system = 4100 MB
Paging File Size (Recommended) = Mounted Memory Size \times 1.5
Dump file Size = Mounted Memory Size + 1 MB
Application Size = Required Size

IMPORTANT:

- The above-mentioned paging file size is recommended for collecting debug information (memory dump). The paging file with initial size large enough to store the dump file in the boot drive is required.
Correct debug information might not be able to be collected due to virtual memory shortage when the paging file is insufficient, so set the paging file size large enough for the entire system.
 - The dump file size for the system with more than 2 GB memory mounted is '2048 MB + 1 MB'.
 - If you install any application program, add necessary space to the partition to install these programs.
-

For example, if the mounted memory size is 512 MB, the partition size will be calculated by the above formula as follows:

$$4100 \text{ MB} + (512 \text{ MB} * 1.5) + (512 \text{ MB} + 1 \text{ MB}) + \text{Application Size} \\ = 5381 \text{ MB} + \text{Application Size}$$

Dividing into the partition of the recommended size into multiple disks as written below will solve problem that it cannot be reserved in one disk.

1. Set the "Size required for installation + Paging file size".
2. See Chapter 5 and set that debugging information (equivalent to the dump file size) is to be written to a separate disk.

(If the disk does not have enough free space to enable the file size to be written, then after installing the system using the "Size required for installation + Paging file size," install an additional new disk.)

INSTALLING Windows Server™ 2003 X64 EDITIONS

Preparations for Installation

- NEC EXPRESSBUILDER CD-ROM
- Microsoft® Windows Server™ 2003 Standard x64 Edition (CD-ROM)
- User's Guide
- Getting Started
- Windows Server 2003 x64 Edition OEM-DISK for NEC EXPRESSBUILDER

Creating "Windows Server 2003 x64 Edition OEM-DISK for NEC EXPRESSBUILDER"

Before installing, create Windows Server 2003 x64 Edition OEM-DISK for NEC EXPRESSBUILDER.

NOTE: If you have already "Windows Server 2003 x64 Edition OEM-DISK for NEC EXPRESSBUILDER" for Express5800 Server which you are going to install Windows Server 2003 x64 Edition, you do not need to create it again.

You can create Windows Server 2003 x64 Edition OEM-DISK for NEC EXPRESSBUILDER with the following two procedures:

- Create from the menu which appears when running Express5800 Server with NEC EXPRESSBUILDER.

If you have only Express5800 Server to create Windows Server 2003 x64 Edition OEM-DISK for NEC EXPRESSBUILDER, use this procedure.

If Windows Server 2003 or Windows NT 4.0 can be operated on Express5800 Server, you can use the other procedure described later.

Follow the steps below:

1. Prepare one 3.5-inch floppy disk.
2. Turn on your Express5800 Server.
3. Insert the NEC EXPRESSBUILDER CD-ROM into the CD-ROM drive of the server.
4. Press the RESET switch or press **Ctrl, Alt** and **Delete** to reboot the server. (You may also turn off and then on again to reboot the server.)

The system will boot from the CD-ROM and NEC EXPRESSBUILDER starts.

5. Select [Create Support Disk] from [Tools].
6. Select [Windows Server 2003 x64 Edition OEM-DISK for NEC EXPRESSBUILDER] from [Create Support Disk] menu.
7. Insert a floppy disk into the floppy disk drive according to the on-screen instruction.

Windows Server 2003 x64 Edition OEM-DISK for NEC EXPRESSBUILDER will be created.

Write-protect and attach a label, then keep it in a safe place.

- Create from [Master Control Menu]

[Master Control Menu] runs on the following operating systems.

- Windows Server™ 2003 x64 Editions
- Windows Server™ 2003
- Windows® XP x64 Edition
- Windows® XP

- Windows® 2000
- Windows® Me/98/95
- Windows NT® 4.0

You can create Windows Server 2003 x64 Edition OEM-DISK for NEC EXPRESSBUILDER from [Master Control Menu], if you have a computer on which one of the above operating systems operates.

Follow the steps below:

1. Prepare one 3.5-inch floppy disk.
2. Run Windows Me/98/95, or Windows 2000, Windows Server 2003, Windows NT 4.0, Windows XP.
3. Insert the NEC EXPRESSBUILDER CD-ROM into the CD-ROM drive of the server.
[Master Control Menu] will appear.
4. Click [Setup] with left mouse button and click [Make OEM-DISK] and then [for Windows Server 2003 x64].

NOTE: You can do the same operation with the menu displayed by a Right-click.

5. Insert the floppy disk into the floppy disk drive according to the message.
Windows Server 2003 x64 Edition OEM-DISK for NEC EXPRESSBUILDER will be created.
Write-protect and attach a label, then keep it in a safe place.

Windows Server™ 2003 x64 Editions Clean Installation

This section explains how to perform a clean installation of Windows Server™ 2003 x64 Editions.

1. Turn on the system power.
2. Insert the Windows Server 2003 x64 Edition CD-ROM into the CD-ROM drive.
3. Press **Ctrl + Alt + Delete** to reset the system.

After a bootable operating system has been installed on the hard disk, press **Enter** while the message "Press any key to boot from CD..." is displayed at the top of the screen.

If no bootable operating system exists on the hard disk, this step is unnecessary.

The Windows Server 2003 x64 Editions setup screen will appear.

If the screen is not displayed, **Enter** was not pressed properly.

Begin after turning on the system power again.

4. Press **F6** in a few seconds when the window is in either of the following states.
 - "Setup is inspecting your computer's hardware configuration ..." is displayed.
 - A screen with a solid blue background is displayed.

IMPORTANT: There is no visible indication on screen when **F6** has been pressed.

5. When the following message is displayed, press **S**.

Setup could not determine the type of one or more mass storage devices installed in your system, or you have chosen to manually specify an adapter. Currently, Setup will load support for the following mass storage device(s).

The following message is displayed.

Please insert the disk labeled
manufacturer-supplied hardware support disk
into Drive A:
*Press ENTER when ready.

6. Insert the Windows Server 2003 x64 Edition OEM-DISK for NEC EXPRESSBUILDER into the floppy disk drive, and press **Enter**.
A list of mass storage devices is displayed.
7. Select the proper SCSI Adapter and press **Enter**.
 - MegaRAID PCI Express(TM) ROMB (When on-board RAID is installed.)
 - MegaRAID SCSI 320-2 RAID Controller Driver (When N8103-81F board is installed.)

Continue performing tasks according to the subsequent messages that appear.

For details, refer to "Getting Started".

After installation is completed, be sure to execute the tasks described in "Driver Installation and Advanced Settings" and "Updating the System" of this manual.

Procedure for License Authentication

Product Key used in the procedure for license authentication should be matched with the COA label in which the product key contained in Windows Server 2003 is written.

NOTES:

- Execute the activation within 30 days. System may be locked after 30 days is passed.
 - COA label may be attached to your server.
-

Updating the System

To ensure normal system operation you should update your system using the following procedures.

1. Logon to the system using the administrator account or another account which is a member of the Administrators group.
2. Insert the NEC EXPRESSBUILDER CD-ROM into the CD-ROM drive.
Master Control Menu is automatically displayed on the screen.
3. Click [Setup] with left mouse button and click [Update Express5800 system] section.
4. Continue your work for system update as the following message.
5. Click [Restart Computer] to restart the system.
6. Remove the NEC EXPRESSBUILDER CD-ROM from the CD-ROM drive immediately after clicking on [Restart Computer]

IMPORTANT: If you change the configuration of the system (by adding or removing hardware or Operating system software components) or repair the system, you must run the system update again.

DRIVER INSTALLATION AND ADVANCED SETTINGS

This section describes how to install and setup various standard drivers mounted on the device.

For information on installing and setting up a driver that is not described in this section, please refer to the document attached to the driver.

PROSet

PROSet is a utility that confirms the function of network contained in network driver.

Utilizing PROSet enables the following items:

- Confirm detailed information of the adapter.
- Diagnose loop back test, packet transmission test and so on.
- Setup of teaming.

Configuring several network adapters as one team provides the server a tolerant environment on any trouble and enhances throughput between the switches.

PROSet is necessary to use these features.

Follow the procedure below to install PROSet:

1. Insert the NEC EXPRESSBUILDER CD-ROM into the CD-ROM drive.
2. The [Windows Explorer] dialog starts.
 - * Procedure with the standard start menu
Click Start and click [Windows Explorer].
 - * Procedure with the classic start menu
Click Start, point to [Programs], [Accessories] and click [Windows Explorer].
3. Run "DXSETUP.EXE" in the following directory:
CD-ROM DriveLetter:\WINNT\W2K3AMD\NS1\PROSET\WS03_32E
The [Intel(R) PROSet - Install Shield Wizard] dialog starts.
4. Click [Next].
5. Choose "I accept the terms in the license agreement" and click [Next].
6. Click [Install].
7. When [Install Shield Wizard Completed] window is displayed, click [Finish].
8. Restart the system.

Network Driver

Specifying the details of network driver.

One standard network driver that is mounted will be installed automatically, but the link speed and Duplex mode need to be specified manually.

[When PROSet is not installed]

1. The [Local Area Connection Properties] dialog box appears.
 - * Procedure with the standard start menu
 1. Click Start, [Control Panel], [Network Connections], and click [Local Area Connection].
 - * Procedure with the classic start menu
 1. Click Start, [Settings] and click [Network Connections].

The [Network Connections] dialog box appears.
 2. Right-click [Local Area Connection] and click [Properties] from drop down menu.
2. Click [Configure].

The property dialog box for network adapter is displayed.
3. Click [Advanced] and specify [Link Speed & Duplex] value the same as the value specified for the HUB.
4. Click [OK] on the property dialog box for network adapter.

[When PROSet is installed]

1. Open the [Device Manager]
2. Double-click [(Network Adapter Name)] in the list.
3. Click [Link] and specify [Link Speed & Duplex Settings] value the same as the value specified for the HUB.
4. Click [OK].

Also, add or delete any protocols and services if necessary.

You can operate the process on the property dialog box for local area network which can be appeared from [Network and Dial-up Connection].

NOTE: We recommend you to add [Network Monitor] at [Adding Services]. [Network Monitor] can monitor the frame (or the packet) that the computer installing [Network Monitor] sends or receives. This tool is valuable when analyzing network trouble. For information on how to install the tool, see the "Setting for Solving Problems" described later in this chapter.

Optional Network Board Driver

If you want to use optional Network Board (INTEL PRO/1000 F 64-BIT PCI / INTEL PRO/1000 TX 64-BIT PCI / 11B PCI-X PRO/1000 MT DUAL), the network driver will be installed automatically. Therefore, the driver attached to the Network board should not be used.

Re-install the Network Driver

The network driver will be installed automatically.

Graphics Accelerator Driver

The standard graphics accelerator driver installed by "Update Express5800 system" is automatically installed.

The following is the procedure when it is necessary to install it manually.

If you want to use an optional Graphics Accelerator Driver board, follow the document attached to the board to install the driver.

1. Insert the NEC EXPRESSBUILDER CD-ROM into the CD-ROM drive.
2. Click Start, point to [Programs], [Accessories] and click [Windows Explorer].
3. Run "Setup.exe" in the following directory.
<CD-ROM Drive Letter>:\WINNT\W2K3AMD\VIDEO\setup.exe.
4. Follow the message to continue the installation.
If the dialog message "Digital Signature could not be found." appears, select [Yes] to continue.
5. Remove the NEC EXPRESSBUILDER CD-ROM from the CD-ROM drive, follow the on-screen instructions and restart the system.

Installing SCSI Controller Driver (Adaptec 29320 / SCSI U160 PCI-ATX-64b)

The SCSI controller driver will be installed automatically.

Installing Disk Array Controller Driver (SecuRAID 321)

To additionally install the SecuRAID 321 in a system containing Windows Server 2003, connect the controller and install the driver as follows:

1. When the [Found New Hardware Wizard] dialog box is displayed, click [Next].
2. When the [Install Hardware Device Drivers] dialog box is displayed, select [Search for a suitable driver for my device (Recommended)], and click [Next].
3. When the [Locate Driver Files] dialog box is displayed, select [Floppy disk drives], insert "Windows Server 2003 x64 Edition OEM-DISK for EXPRESSBUILDER" into the floppy disk drive, and click [Next].
4. When the [Driver Files Search Results] dialog box is displayed, click [Next].
5. Copying of the driver is completed, and the [Completion of the new hardware detection wizard] dialog box is displayed. Click [Complete].

SETTING FOR COLLECTING MEMORY DUMP (DEBUG INFORMATION)

Set for collecting memory dump using the procedure described in Chapter 5.

(This page is intentionally left blank.)

Appendix E

Installing Windows Server™ 2003

This section describes the procedures for installing Windows Server™ 2003 without using Express Setup tool.

BEFORE INSTALLING Windows Server™ 2003

Please read carefully the following information BEFORE commencing your Windows Server™ 2003 Installation.

Optional Boards Supported by NEC EXPRESSBUILDER

NEC EXPRESSBUILDER CD-ROM attached to your system supports the following optional boards:

NOTE: If you want to install other boards by using a driver floppy disk ("OEM-FD for Mass storage device") than the ones listed below, see "Exceptional setup" and "Installing Optional Mass Storage Driver" of "Configuration Diskette Creator" in Chapter 6.

- Supporting installation of the operating system in NEC EXPRESSBUILDER
 - On Board RAID (Controller on the I/O board)
 - SecuRAID 321 Disk Array Controller (SCSI 2ch)
- Other optional boards
 - Initio 101 SCSI Controller
 - Adaptec 29320 SCSI Controller
 - SCSI U160 PCI-ATX-64b Disk Controller

Updating System

If you modified the Windows system, execute "Update Express5800 system" in Master Control Menu.

Re-installing to the Hard Disk Which Has Been Upgraded to Dynamic Disk

If you want to leave the existing partition when installing the system on the hard disk upgraded to Dynamic Disk, note the following issue:

- Do not select the partition where the operating system had been installed as the partition to install the operating system newly.
- Select "Use the current File System" for the format of operating system partition.

MO Device

If you specify the file system as NTFS with MO Device connected during the installation, the file system will not be converted normally. Disconnect MO Device and restart the installation from the beginning.

Media such as DAT

During the operating system installation, do not attach unnecessary media for operating system installation to the system, such as DAT.

Partition Size

The size for the partition that the system is to be installed can be calculated from the following formula.

Size necessary to install the system + Paging File Size + Dump File Size + Application Size
 Size necessary to install the system = 2900 MB
 Paging File Size (Recommended) = Mounted Memory Size * 1.5
 Dump File Size = Mounted Memory Size + 12 MB
 Application Size = Required Size

IMPORTANT:

- The above-mentioned paging file size is recommended for collecting debug information (memory dump). The paging file with initial size large enough to store the dump file in the boot drive is required.
 Correct debug information might not be able to be collected due to virtual memory shortage when the paging file is insufficient, so set the paging file size large enough for the entire system.
 - The maximum paging file size which can be set on one partition is 4095 MB. If the above paging file size exceeds 4095 MB, specify 4095 MB for the paging file size.
 - The maximum dump file size for the system with more than 2 GB memory mounted is '2048 MB + 12 MB'.
 - If you install any application program, add necessary space to the partition to install these programs.
-

For example, if the mounted memory size is 512 MB, the partition size will be calculated by the above formula as follows:

$$2900 \text{ MB} + (512 \text{ MB} * 1.5) + (512 \text{ MB} + 12 \text{ MB}) + \text{Application Size} = 4192 \text{ MB} + \text{Application Size}$$

Dividing into the partition of the recommended size into multiple disks as written below will solve problem that it cannot be reserved in one disk.

1. Set the "Size required for installation + Paging file size".
2. See Chapter 5 and set that debugging information (equivalent to the dump file size) is to be written to a separate disk.

(If the disk does not have enough free space to enable the file size to be written, then after installing the system using the "Size required for installation + Paging file size," install an additional new disk.)

INSTALLING Windows Server 2003

Preparations for Installation

- NEC EXPRESSBUILDER CD-ROM
- Microsoft® Windows Server™ 2003 Standard Edition (CD-ROM) or Microsoft® Windows Server™ 2003 Enterprise Edition (CD-ROM)
- User's Guide
- Getting Started
- Windows Server 2003 OEM-DISK for NEC EXPRESSBUILDER

Creating "Windows Server 2003 OEM-DISK for NEC EXPRESSBUILDER"

Before installing, create Windows Server 2003 OEM-DISK for NEC EXPRESSBUILDER.

NOTE: If you have already "Windows Server 2003 OEM-DISK for NEC EXPRESSBUILDER" for Express5800 Server which you are going to install Windows Server 2003, you do not need to create it again.

You can create Windows Server 2003 OEM-DISK for NEC EXPRESSBUILDER with the following two procedures:

- Create from the menu which appears when running Express5800 Server with NEC EXPRESSBUILDER.

If you have only Express5800 Server to create Windows Server 2003 OEM-DISK for NEC EXPRESSBUILDER, use this procedure.

If Windows Server 2003 or Windows NT 4.0 can be operated on Express5800 Server, you can use the other procedure described later.

Follow the steps below:

1. Prepare one 3.5-inch floppy disk.
2. Turn on your Express5800 Server.
3. Insert the NEC EXPRESSBUILDER CD-ROM into the CD-ROM drive of the server.
4. Press the RESET switch or press **Ctrl, Alt** and **Delete** to reboot the server. (You may also turn off and then on again to reboot the server.)

The system will boot from the CD-ROM and NEC EXPRESSBUILDER starts.

5. Select [Create Support Disk] from [Tools].
6. Select [Windows Server 2003 OEM-DISK for NEC EXPRESSBUILDER] from [Create Support Disk] menu.
7. Insert a floppy disk into the floppy disk drive according to the on-screen instruction.

Windows Server 2003 OEM-DISK for NEC EXPRESSBUILDER will be created.

Write-protect and attach a label, then keep it in a safe place.

- Create from [Master Control Menu]

[Master Control Menu] runs on the following operating systems.

- Windows Server™ 2003 x64 Editions
- Windows Server™ 2003
- Windows® XP x64 Edition
- Windows® XP
- Windows® 2000

- Windows® Me/98/95
- Windows NT® 4.0

You can create Windows Server 2003 OEM-DISK for NEC EXPRESSBUILDER from [Master Control Menu], if you have a computer on which one of the above operating systems operates.

Follow the steps below:

1. Prepare one 3.5-inch floppy disk.
2. Run Windows Me/98/95, or Windows 2000, Windows Server 2003, Windows NT 4.0, Windows XP.
3. Insert the NEC EXPRESSBUILDER CD-ROM into the CD-ROM drive of the server.
[Master Control Menu] will appear.
4. Click on [Setup] with left mouse button and click [Make OEM-DISK] and then [for Windows Server 2003].

NOTE: You can do the same operation with the menu displayed by a right-click.

5. Insert the floppy disk into the floppy disk drive according to the message.
Windows Server 2003 OEM-DISK for NEC EXPRESSBUILDER will be created.
Write-protect and attach a label, then keep it in a safe place.

Windows Server 2003 Clean Installation

This section explains how to perform a clean installation of Windows Server 2003.

1. Turn on the system power.
2. Insert the Windows Server™ 2003 CD-ROM into the CD-ROM drive.
3. Press **Ctrl + Alt + Delete** to reset the system.

After a bootable operating system has been installed on the hard disk, press **Enter** while the message "Press any key to boot from CD..." is displayed at the top of the screen.

If no bootable operating system exists on the hard disk, this step is unnecessary.

The Windows Server 2003 setup screen will be displayed.

If the screen is not displayed, **Enter** was not pressed properly.

Restart after turning on the system power again.

4. Press **F6** in a few seconds when the window is in either of the following states.
 - "Setup is inspecting your computer's hardware configuration ..." is displayed.
 - A screen with a solid blue background is displayed.

IMPORTANT: There is no visible indication on screen when **F6** has been pressed.

5. When the following message is displayed, press **S**.

Setup could not determine the type of one or more mass storage devices installed in your system, or you have chosen to manually specify an adapter. Currently, Setup will load support for the following mass storage device(s).

The following message is displayed.

Please insert the disk labeled
manufacturer-supplied hardware support disk
into Drive A:
*Press ENTER when ready.

6. Insert the Windows Server 2003 OEM-DISK for NEC EXPRESSBUILDER into the floppy disk drive, and press **Enter**.

A list of mass storage devices is displayed.

Select the [LSI MEGARAID Products for Windows 2003 (x86)] and press **Enter**.

Continue performing tasks according to the subsequent messages that are displayed.

For details, refer to "Getting Started".

After installation is completed, be sure to execute the tasks described in "Driver Installation and Advanced Settings" and "Updating the System" of this manual.

Procedure for License Authentication

Product Key used in the procedure for license authentication should be matched with the COA label in which the product key contained in Windows Server 2003 is written.

NOTES:

- Execute the activation within 30 days. System may be locked after 30 days is passed.
- COA label may be attached to your server.

Updating the System

To ensure normal system operation you should update your system using the following procedures.

1. Logon to the system using the administrator account or another account which is a member of the Administrators group.
2. Insert the NEC EXPRESSBUILDER CD-ROM into the CD-ROM drive.
Master Control Menu is automatically displayed on the screen.
3. Click [Setup] with left mouse button and click [Update Express5800 system] section.
4. Continue your work for system update as the following message.
5. Click [Restart Computer] to restart the system.
6. Remove the NEC EXPRESSBUILDER CD-ROM from the CD-ROM drive immediately after clicking [Restart Computer]

IMPORTANT: If you change the configuration of the system (by adding or removing hardware or Operating system software components) or repair the system, you must run the system update again.

Upgrade Installation

NOTE: If you are using the Adaptec 29160, please carry out after removing it.

1. Procedures below upgrade the installed Windows 2000 to Windows Server 2003.
2. Power on the system and start Windows 2000.
3. Log on as an administrator.
4. Insert the Windows Server™ 2003 CD-ROM into the CD-ROM drive.

Then, [Select an operation] dialog will be displayed.

NOTE: If the [Select an operation] dialog box is not displayed, start \SETUP.EXE from CD-ROM drive.

5. Select [Install Windows Server 2003].
Then, a dialog box asks to select upgrade or clear installation.
6. Select "Upgrade (recommended)" and click Next.
Follow the messages and continue. The system will automatically restart after copying the files.

NOTE: You can leave the Windows Server 2003 CD-ROM in the CD-ROM drive.

7. If a disk array controller is attached to the device, press **F6** while a message, "Setup is inspecting your computer's hardware configuration...", is on the screen.

IMPORTANT: There is no visible indication on screen when **F6** has been pressed.

8. When the following message is displayed, press **S**.

Setup could not determine the type of one or more mass storage devices installed in your system, or you have chosen to manually specify an adapter. Currently, Setup will load support for the following mass storage device(s).

The following message is displayed.

Please insert the disk labeled
manufacturer-supplied hardware support disk
into Drive A:
*Press ENTER when ready.

9. Insert the Windows Server 2003 OEM-DISK for NEC EXPRESSBUILDER into the floppy disk drive, and press **Enter**.
A list of mass storage devices is displayed.
Select the [LSI MEGARAID Products for Windows 2003 (x86)] and press **Enter**.
10. Update the system.

11. Install the driver and make detailed settings.

- If PROSet is already installed, uninstall PROSet before upgrading.

If the teaming function is enabled, disable this function before uninstalling PROSet.

- During upgrade installation, [Disk Insert] dialog box may be displayed.

If it is displayed, insert the Windows Server 2003 OEM-DISK for NEC EXPRESSBUILDER into the floppy disk drive, and click [OK].

[Files Needed] dialog box may be displayed.

Enter "a:\" into "Copy files from:" and then click [OK].

DRIVER INSTALLATION AND ADVANCED SETTINGS

This section describes how to install and setup various standard drivers mounted on the device.

For information on installing and setting up a driver that is not described in this section, please refer to the document attached to the driver.

PROSet

PROSet is a utility that confirms the function of network contained in network driver.

Utilizing PROSet enables the following items:

- Confirm detailed information of the adapter.
- Diagnose loop back test, packet transmission test and so on.
- Setup of teaming.

Configuring several network adapters as one team provides the server a tolerant environment on any trouble and enhance throughput between the switches.

PROSet is necessary to use these features.

Follow the procedure below to install PROSet.

1. Insert the NEC EXPRESSBUILDER CD-ROM into the CD-ROM drive.
2. The [Windows Explorer] dialog starts.
 - * Procedure with the standard start menu
Click Start and click [Windows Explorer].
 - * Procedure with the classic start menu
Click Start, point to [Programs], [Accessories] and click [Windows Explorer].
3. Run "PROSET.EXE" in the following directory:
<CD-ROM DriveLetter>:\WINNT\DOTNET\BC5\PROSET\WS03XP32
The [Intel(R) PROSet - InstallShield Wizard] dialog starts.
4. Click [Next].
5. Choose "I accept the terms in the license agreement" and click [Next].
6. Choose "Typical" and click [Next].
7. Click [Install].
8. When [InstallShield Wizard Completed] window is displayed, click [Finish].
9. Restart the system.

Network Driver

Specifying the details of network driver.

Two standard network drivers that are mounted will be installed automatically, but the link speed and Duplex mode need to be specified manually.

[When PROSet is not installed]

1. The [Local Area Connection Properties] dialog box is displayed.
 - * Procedure with the standard start menu
 1. Click Start, Click [Control Panel], Click [Network Connections], and Click [Local Area Connection].
 - * Procedure with the classic start menu
 1. Click Start, [Settings] and click [Network Connections].

The [Network Connections] dialog box is displayed.
 2. Right-click [Local Area Connection] and click [Properties] from drop down menu.
2. Click [Configure].

The property dialog box for network adapter is displayed.
3. Click [Advanced] and specify [Link Speed & Duplex] value the same as the value specified for the HUB.
4. Click [OK] on the property dialog box for network adapter.

[When PROSet is installed]

1. The [Intel PROSet] dialog box appears.
 - * Procedure with the standard start menu

Click Start, point to [Control Panel] and click [Intel PROSet].
 - * Procedure with the classic start menu
 1. Click Start, point to [Settings] and click [Control Panel].
 2. Double-click [Intel(R) PROSet] on the [Control Panel] window.
2. Click [(Network Adapter Name)] in the list.
3. Click [Speed] and specify [Link Speed & Duplex Settings] value the same as the value specified for the HUB.
4. Click [Apply] and click [OK].

Specify the other network driver the same as above.

Also, add or delete any protocols and services if necessary.

You can operate the process on the property dialog box for local area network which can be displayed from [Network and Dial-up Connection].

NOTE: We recommend you add "Network Monitor" at "Adding Services".

"Network Monitor" can monitor frames (or packets) sent or received by a computer on which "Network Monitor" is installed. This is an effective tool for analyzing network faults.

For information about the installation procedure, see Chapter 6.

Re-install the Network Driver

The network driver will be installed automatically.

Installing SCSI Controller Driver (Initio 101 / Adaptec 29320)

If you use SCSI controller driver (Initio 101 / Adaptec 29320), install it according to the following procedure:

1. Start [Device Manager] from [Start] menu → [Control Panel] → [Administrative Tools] → [Computer Management].
2. Double-click the SCSI Controller driver that Device Manager lists as unknown device.
3. Click [Update Driver].
4. When the "Update Device Driver Wizard" is displayed, select "Install from a list or specific location [Advanced]" and click [Next].
5. Select "Don't search. I will choose the driver to install" and click [Next].
6. Click [Have Disk..].
7. Insert "Windows Server 2003 OEM-DISK for NEC EXPRESSBUILDER" into the floppy disk drive, enter "a:\" into "copy manufacturer's file from:" and click [OK].
8. Specify the following driver and click [Next].
 - [INITIO INI-A10XU2W PCI SCSI Controller] (When Initio 101 board is installed.)
 - [Adaptec SCSI Card 29320ALP - Ultra320 SCSI] (When Adaptec 29320 board is installed.)

The installation of the driver is completed.

Restart the system according to the message displayed on the screen.

Installing SCSI Controller Driver (SCSI U160 PCI-ATX-64b)

If you use SCSI controller driver (SCSI U160 PCI-ATX-64b), update your system with NEC EXPRESSBUILDER CD-ROM attached to your system.

The SCSI controller driver will be installed automatically.

Installing Disk Array Controller Driver (SecuRAID 321)

To additionally install the SecuRAID 321 in a system containing Windows Server 2003, connect the controller and install the driver as follows:

1. When the [Found New Hardware Wizard] dialog box is displayed, click [Next].
2. When the [Install Hardware Device Drivers] dialog box is displayed, select [Search for a suitable driver for my device (Recommended)], and click [Next].
3. When the [Locate Driver Files] dialog box is displayed, select [Floppy disk drives], insert "Windows Server 2003 OEM-DISK for NEC EXPRESSBUILDER" into the floppy disk drive, and click [Next].
4. When the [Driver Files Search Results] dialog box is displayed, click [Next].
5. Copying of the driver is completed, and the [Completion of the new hardware detection wizard] dialog box below is displayed. Click [Complete].

SETTING FOR COLLECTING MEMORY DUMP (DEBUG INFORMATION)

Set for collecting memory dump using the procedure described in Chapter 5.

This page is left intentionally blank

Appendix F

Product Configuration Record Table

Use this table for information about setup and system environment change.

Hardware

Main Unit						
	Model name		Serial No.		Date Installed	
Processor						
#1	Clock		Serial No.		Date Installed	
#2	Clock		Serial No.		Date Installed	
#3	Clock		Serial No.		Date Installed	
#4	Clock		Serial No.		Date Installed	
Memory						
Group #1	Size		Serial No.		Date Installed	
Group #2	Size		Serial No.		Date Installed	
Group #3	Size		Serial No.		Date Installed	
Group #4	Size		Serial No.		Date Installed	
Group #5	Size		Serial No.		Date Installed	
Group #6	Size		Serial No.		Date Installed	
Group #7	Size		Serial No.		Date Installed	
Group #8	Size		Serial No.		Date Installed	
Monitor						
	Type		Model name		Serial No.	
					Date Installed	
Hard Disk Drive (Standard)						
ID0	Type			Serial No.		
	Capacity			Date Installed		
	Type number					
ID1	Type			Serial No.		
	Capacity			Date Installed		
	Type number					
ID2	Type			Serial No.		
	Capacity			Date Installed		
	Type number					
ID3	Type			Serial No.		
	Capacity			Date Installed		
	Type number					
ID4	Type			Serial No.		
	Capacity			Date Installed		
	Type number					

Hard Disk Drive (Option)						
ID0	Type			Serial No.		
	Capacity			Date Installed		
	Type number					
ID1	Type			Serial No.		
	Capacity			Date Installed		
	Type number					
ID2	Type			Serial No.		
	Capacity			Date Installed		
	Type number					
ID3	Type			Serial No.		
	Capacity			Date Installed		
	Type number					
ID8	Type			Serial No.		
	Capacity			Date Installed		
	Type number					
ID9	Type			Serial No.		
	Capacity			Date Installed		
	Type number					
ID10	Type			Serial No.		
	Capacity			Date Installed		
	Type number					
ID11	Type			Serial No.		
	Capacity			Date Installed		
	Type number					
Backup Device						
Slot 1	Size		Capacity		Serial No.	
	Model name		Type number		Date Installed	
Slot 2	Size		Capacity		Serial No.	
	Model name		Type number		Date Installed	
PCI Slot #1						
	Model name				Serial No.	
					Date Installed	
PCI Slot #2						
	Model name				Serial No.	
					Date Installed	
PCI Slot #3						
	Model name				Serial No.	
					Date Installed	
PCI Slot #4						
	Model name				Serial No.	
					Date Installed	
PCI Slot #5						
	Model name				Serial No.	
					Date Installed	
PCI Slot #6						
	Model name				Serial No.	
					Date Installed	

PCI Slot #7						
	Model name				Serial No.	
					Date Installed	
PCI Slot #8						
	Model name				Serial No.	
					Date Installed	
PCI Slot #9						
	Model name				Serial No.	
					Date Installed	
Printer						
	Model name				Serial No.	
	Manufacturer				Date Installed	
Additional Cabinet for Disk						
	Model name				Serial No.	
					Date Installed	
External Peripheral Device 1						
	Model name				Serial No.	
	Manufacturer				Date Installed	
External Peripheral Device 2						
	Model name				Serial No.	
	Manufacturer				Date Installed	
Display						
	Model name				Serial No.	
	Manufacturer				Date Installed	
Keyboard						
	Model name				Serial No.	
	Manufacturer				Date Installed	
Mouse						
	Model name				Serial No.	
	Manufacturer				Date Installed	

Software

Firmware version	
Operating System Application of RUR media	<input type="checkbox"/> Apply Name: Version: Name: Version:
File system	<input type="checkbox"/> FAT <input type="checkbox"/> HPFS <input type="checkbox"/> NTFS <input type="checkbox"/> Others ()
Bundled software installed	
Licensed software installed	
Application running when a failure occurred	

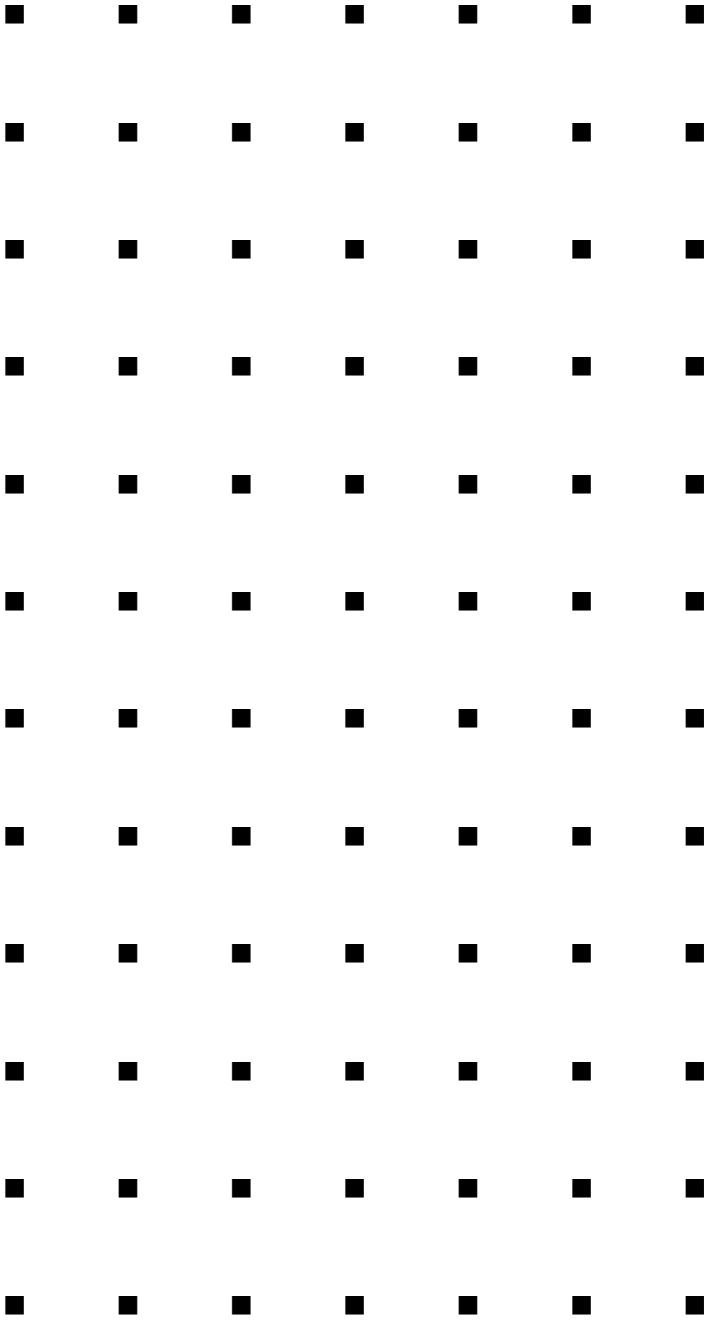

Free Manuals Download Website

<http://myh66.com>

<http://usermanuals.us>

<http://www.somanuals.com>

<http://www.4manuals.cc>

<http://www.manual-lib.com>

<http://www.404manual.com>

<http://www.luxmanual.com>

<http://aubethermostatmanual.com>

Golf course search by state

<http://golfingnear.com>

Email search by domain

<http://emailbydomain.com>

Auto manuals search

<http://auto.somanuals.com>

TV manuals search

<http://tv.somanuals.com>