

Warranty

Multiplex Technology, Inc. warrants this products to be free from defects in materials and workmanship for a period of one year from the date of purchase or MTI will repair, or at its option, replace the defective product. To obtain warranty service, call MTI for a return material authorization (RMA) number and return the product prepaid

Attention: Customer Service. Please put the RMA number on the outside of the carton.

Any implied warranty arising from the sale of the product including implied warranties of merchantability and fitness for purpose are limited to the warranty stated above. MTI shall not be responsible for losses or damages or expenses, whether direct, consequential or incidental arising from the use of or the inability to use this product. Some states do not allow limitations on how long the implied warranty lasts or the exclusion or limitation or incidental or consequential damages, so the above limitations and exclusions may not apply to you. This warranty gives you specific legal rights, and you may have other rights which may vary from state to state.

Channel Plus®

PERFORMANCE MULTI-ROOM VIDEO

Multi-room Video Distribution System Installation Manual

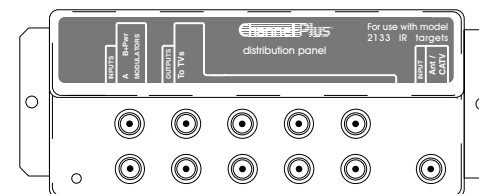
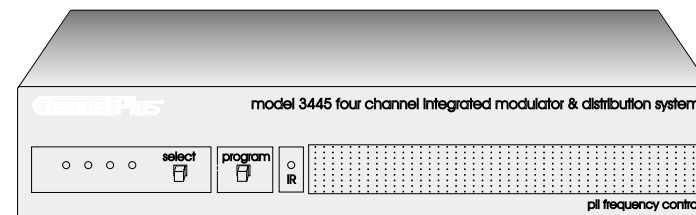

Models 3425/3445

This device complies with the FCC's Part 15 Rules for TV interface devices. Any change or modification to this device without the permission of Multiplex Technology, Inc. may void the user's authority to operate this equipment.

 multiplex®
technology, inc. 

This ChannelPlus 3400 Series video distribution system contains digitally-tuned video modulators that convert any baseband video and audio signal to a user-selected UHF, or Ultraband CATV channel. An internal quartz crystal reference oscillator and PLL circuitry ensure drift-free performance. The user selects the output frequency (channel) using the "select" button to choose which modulator and the "program" button to enter the number of the desired channel. Any TV connected to the output via coax can receive the signals, when the TV is tuned to the proper channel.

Models available:

3425 2 channel system
3445 4 channel system

Controls and Connections - Model 3445 shown

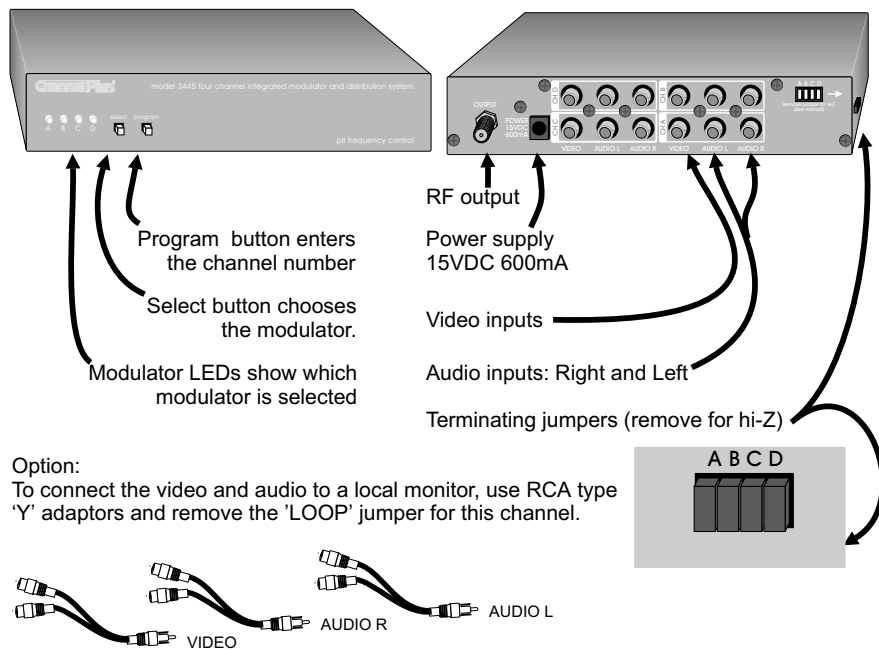

Model 3245/3445 - RF section

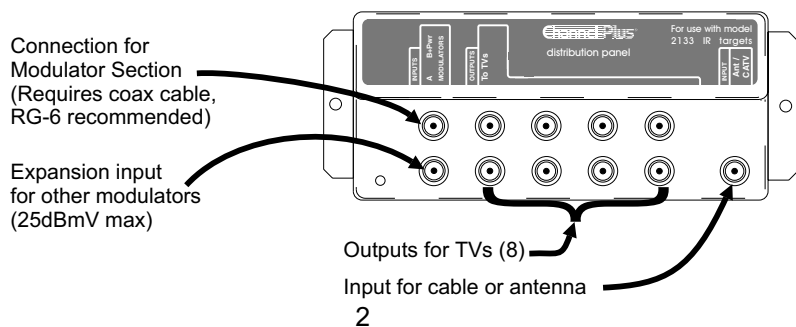

Changing modulation standards

Cable HRC and IRC considerations

Most cable services use IRC frequency assignments. This is the default for the ChannelPlus 3400 series' modulators. However, if the cable service uses HRC or the TV appears to search for the "house channels," the modulator can be reprogrammed to use HRC assignments by entering the number "98". Set to IRC by entering a "99". Both of these settings are only used for setting HRC/IRC. **Note:** This setting can be entered on any modulator channel, A, B, C, or D, and affects all channel assignments for that unit. Cable channels must either be all IRC or all HRC.

Common questions

Can an amplifier be used on an output to drive signals over longer cable paths? ... No. The IR remote control feature will be defeated if an external amplifier is used.

Can a splitter be used on one or more outputs in order to add more TVs? ... No. The model 3425/3445 Multi-room Video Distribution System is a pre-engineered system providing optimum signal levels to each TV for clear, crisp picture quality. Each time a splitter is added, there is lowering of signal level called insertion loss. Insertion losses upset system performance. Additionally, the IR remote control feature will be defeated.

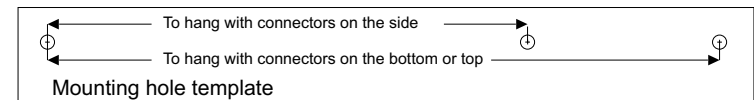

Specifications: typical @ 25°C ± 5°C

3400 Series

Inputs	video	1 Vp-p @ 75Ω	
	audio	1 Vrms @ 47KΩ	
Video performance	differential gain	4%	
	differential phase	<4°	
	signal/noise	55 dB	
RF output	standard	UHF	CATV
	channel ranges	14-64	65-125 (excluding 95-99)
	output level	+15 dBmV (75dBμV)	
	IM distortion	-60 dBC	
	alternate channel	-45dBC @ 12MHz	
	Gain CATV/Ant to output	0 dB	
Power supply (UL listed)	model number	350-079	
	output current	600mA	
	output voltage	15 VDC	
	input power	105-125 VAC	
	power consumption	<9 watts	
Physical	modulator section	1.5x7.9x5.5" (3.8x20.0x14.1cm)	
		2 lbs 10 oz (1.19kg)	
	RF section	0.9x6.3x2.5" (2.4x16x6.4cm)	
		1 lbs 2 oz (0.5kg)	

Things to watch for:

No picture ... Verify that the video source is on and is producing a video signal. Check that the TV and the modulator are tuned to the same channel. For example, if the modulator is broadcasting on UHF channel 16, make sure the TV is on UHF 16 rather than CATV 16. UHF 16 and CATV 16 are at different frequencies.

Weak ChannelPlus UHF channel ... If the TV has a separate UHF input, be sure that it is connected.

LEDs blink ... You need to have one unused channel space between channels. The display will blink if you have made an 'illegal' choice. See the section on programming.

Herringbone interference on ChannelPlus channel (diagonal lines) ... You may have chosen a channel number that is not completely vacant. Distant UHF stations may be un-watchable, but will cause interference if you try to create a new channel at the same frequency. Also, cable companies often have extra signals where there should be none. Try moving the ChannelPlus channel to another number. You may have to add a low pass filter to remove cable company noise. If a filter does not work, try adding a DC-block to remove common mode interference.

Herringbone interference on many channels, including ChannelPlus channels (disappears when you remove the CATV/Ant feed) ... The RF amplifier can be overloaded by abnormally strong signals. Often, you can cure the problem with a simple attenuator. Use a variable attenuator and try to find a signal level where the interference just disappears. Sometimes, the problem is one station that is far stronger than the rest. In this case attenuating all of the signals with a simple attenuator will cause the desired stations to be weak (snowy). In this case you must reduce the strength of only the offending station. A common FM trap will help if the problem is a nearby FM tower. If the problem is a nearby TV station, often the station management can provide suitable filters.

Audio volume is low ... The left and right audio inputs are combined for monaural. For proper audio level, both right and left inputs must be used. If you have a mono source, connect it to both right and left inputs using an RCA 'Y' connector.

No color on ChannelPlus channels ... You may have chosen the incorrect cable standard. Not all televisions can accommodate the 1.25MHz frequency difference between the H and I cable standards. See the section on programming.

Infrared Remote Control Problems ... Use the red **IR DATA** light on the side of the modulator section as a trouble shooting aid. This light will blink as remote control signals are relayed.

If the light is on constantly, one or more IR targets is receiving electrical or optical noise. At the modulator section unit, begin to disconnect the outputs to the TVs until the **IR DATA** light goes off. This will tell you which IR target is the source of the noise.

Next cover the front of the offending IR target. If the **IR DATA** light turns off, the IR target is 'seeing' a source of IR noise, such as a solid state fluorescent lamp. If the light does not go out, the problem may be radiated electrical noise from the TV. Reposition this IR target. If repositioning the IR target does not help, the TV may be conducting noise from its input. Place a DC block between the IR target and the TV.

If the **IR DATA** light seems to indicate proper operation, but the component is not being controlled, the IR emitter may be mis-located. Be sure the emitters are in front of the IR sensor.

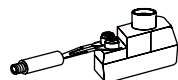

Simple DC-block for RF

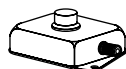

Inexpensive 0-20dB attenuator

Sample System Diagram

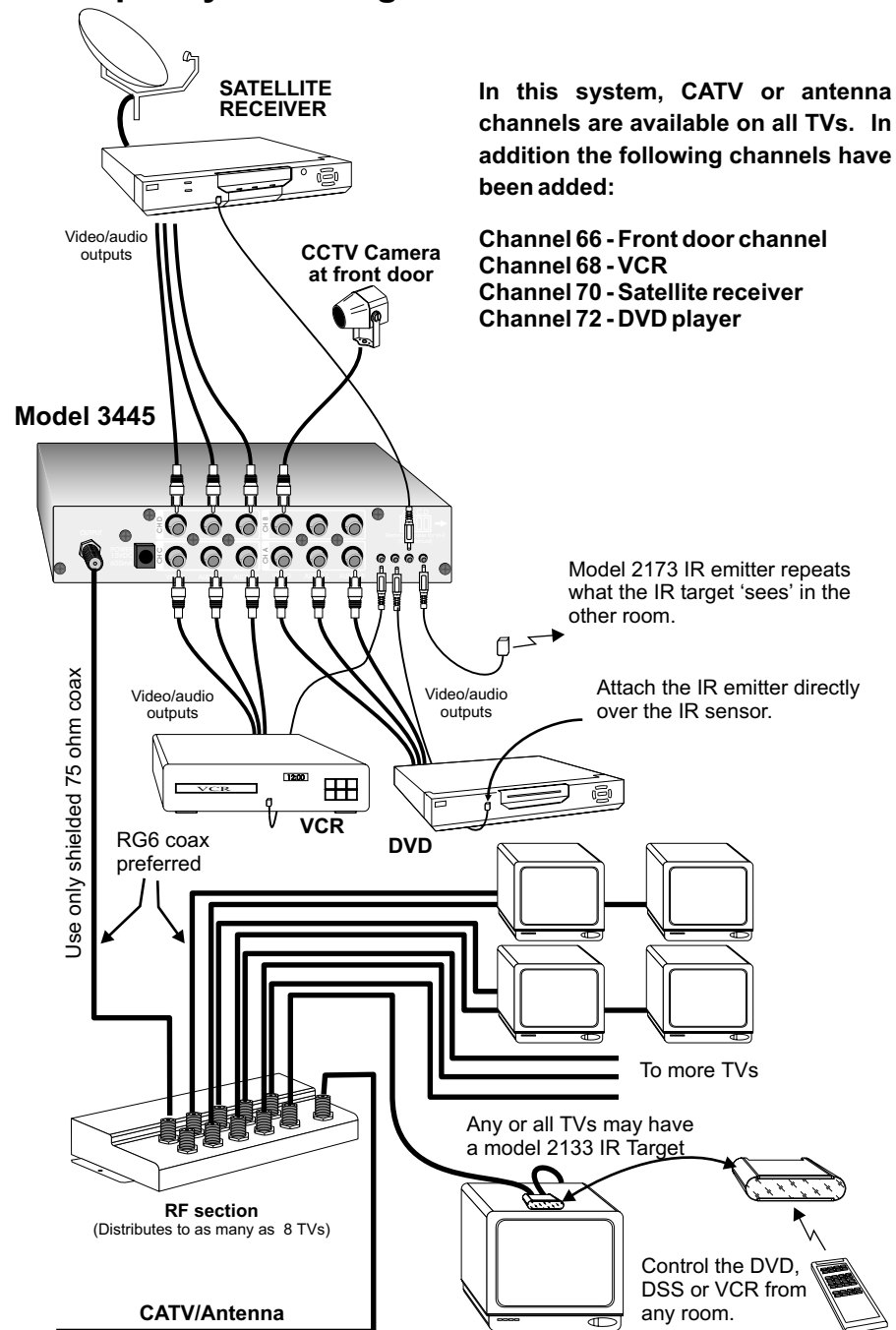

In this system, CATV or antenna channels are available on all TVs. In addition the following channels have been added:

- Channel 66 - Front door channel**
- Channel 68 - VCR**
- Channel 70 - Satellite receiver**
- Channel 72 - DVD player**

Programming Examples:

To program modulator **B** to channel **67**

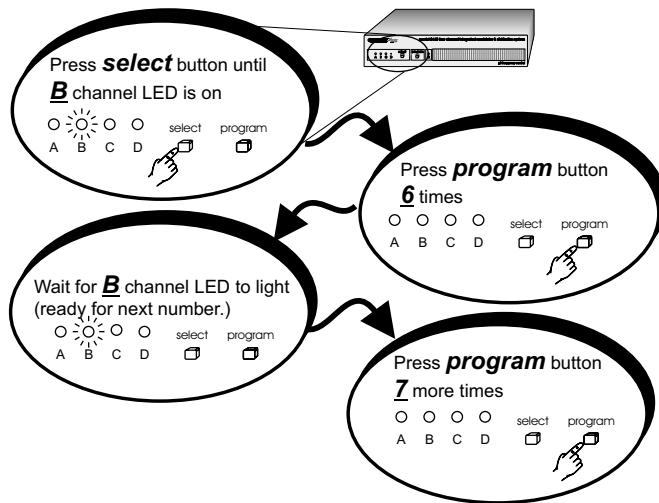

To program modulator **C** to channel **120**

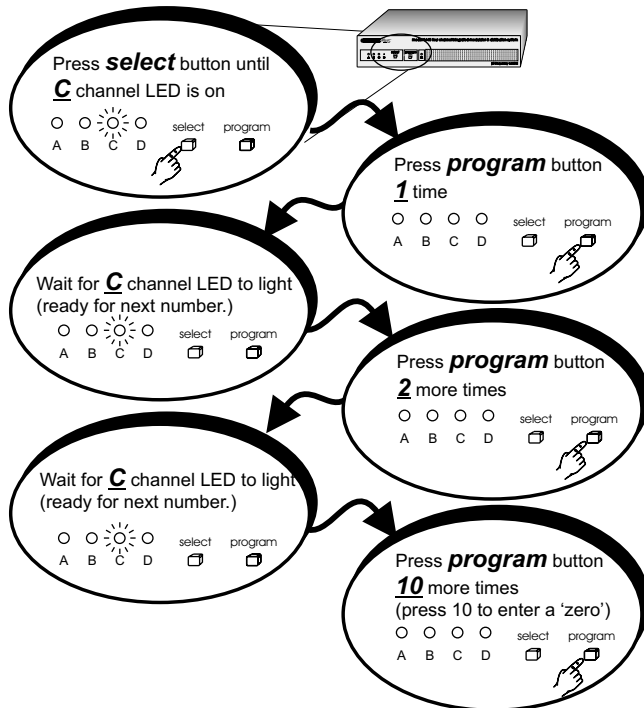

Valid Channels: 14-64: UHF channels
65-125: CATV channels
95-99: not valid

Channel Spacing: Skip at least one number between channels.
Channels 14 and 16: OK.
Channels 14 and 15: Illegal.

Error indication: If an error has occurred or an incorrect channel is entered, the LED will flash quickly for a second and return to the previous settings.

If two adjacent channels are selected, the unit will accept the entry but will blink the LEDs of channels that are too close. If this happens, re-program one of the channels to move it away from the other.

Channel number readback: A readback mode will display the current channel assignments.

To readback modulator **C** channel assignment (example: C has been programmed to channel **108**)

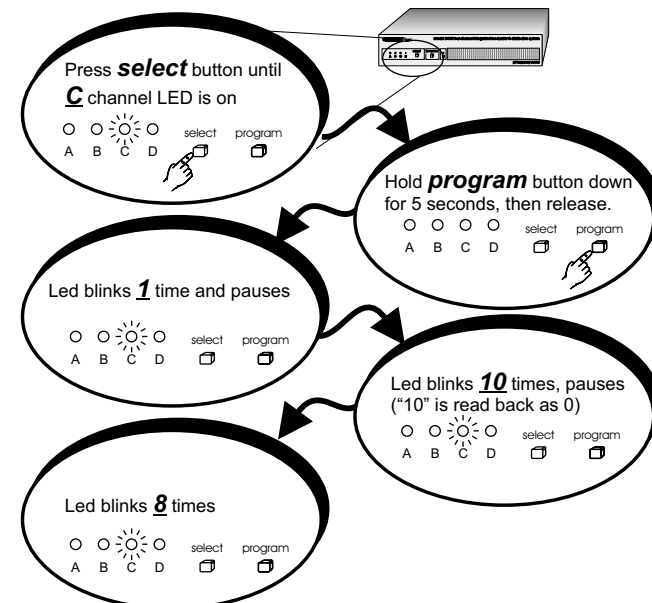

Free Manuals Download Website

<http://myh66.com>

<http://usermanuals.us>

<http://www.somanuals.com>

<http://www.4manuals.cc>

<http://www.manual-lib.com>

<http://www.404manual.com>

<http://www.luxmanual.com>

<http://aubethermostatmanual.com>

Golf course search by state

<http://golfingnear.com>

Email search by domain

<http://emailbydomain.com>

Auto manuals search

<http://auto.somanuals.com>

TV manuals search

<http://tv.somanuals.com>