

## FOREWORD

This section must be read before any connection is made to the mains supply.

### WARNINGS

- Do not expose the equipment to rain or moisture.
- Do not remove the cover from the equipment.
- Do not push anything inside the equipment through the ventilation holes.

### COPYRIGHT

Recording and playback of any material may require consent. For further information refer to the following:

- Copyright Act 1956
- Dramatic and Musical Performers Act 1958
- Performers Protection Acts 1963 and 1972
- any subsequent statutory enactments and orders

## INTRODUCTION

Please read these operating instructions carefully. We recommend that you read the entire user guide before you connect or operate the unit.

After you have reviewed the contents this manual, we suggest that you make all system connections before you attempt to operate the unit.

## PRECAUTIONS

The following precautions should be considered when operating the equipment.

When setting the equipment ensure that :

- air is allowed to circulate freely around the equipment
- the equipment is on a vibration free surface
- the equipment will not be exposed to interference from an external source
- the equipment will not be exposed to excessive heat, cold, moisture or dust
- the equipment will not be exposed to direct sunlight
- the equipment will not be exposed to electrostatic discharges
- In addition, never place heavy objects on the equipment.
- If a foreign body or water does enter the equipment, contact your nearest dealer or service center.

---

---

## Features

---

---

- MPEG I Layer 2 compression technology for recording and playback of mono MPEG audio.
- Recording and playback to and from approved PCMCIA PC Cards (ATA flash or hard disk card).
- MS-DOS compatible file system.
  - MPEG Files in .wav, .mpg, and .bwf.
  - PCM files in broadcast .wav and .bwf.
- A wide variety of input and output jacks.
  - Microphone input jacks (XLR and 1/4").
  - Line level RCA input and output jacks.
  - Digital coaxial output jack (SPDIF, 48kHz).
  - Telephone jack (input/output).
- Three recording modes; LP, MP, and SP.
- Bit rate is assigned to each mode by presetting.
- Three record level options: manual, manual with limiter, and automatic level control (ALC).
- Skip playback and repeat playback using a built-in EDL (Edit Decision List).
- In pre-recording mode, 2 seconds recording prior to the recording start is done.  
Unexpected chance of starting recording is not missed.
- 3-way power supply:
  - 8 Alkaline AA (R6) batteries
  - AC adaptor (supplied)
  - Rechargeable Ni-Cad pack (optional)
- ANC (Ambient Noise Control) switch for eliminating unwanted background noise.
- Built in clock automatically imprints each file with the date and time of creation.
- Built-in mono condenser microphone.
- Built-in speaker.
- Backlit LCD display.
- Remote jack for external start/stop control.

---

---

## How to Use this Manual

---

---

This manual is divided into the 6 sections described below. To find out how to use a specific control, refer to the "Index of Parts, Controls, and Display" on page xxx.

### SETTING UP

This section provides information you need to prepare to use the unit to begin with.

### GENERAL FUNCTION

This section provides information about functions and operations which are common between recording and playback.

### RECORDING

This section provides information about how to select various recording sources, how the selected source is manipulated, and how each of recording behavior works. These are useful to make the best use of variety of recording function which the unit provides according to your recording purpose.

### PLAYBACK and EDITING

This section provides information about playback and editing. There are various ways to access where you like to listen. There are various ways of repeat playback. You can put mark where you like to access. Further, you can program the playback to skip or repeat based on the marks you put.

### PRESETTING

This section provides information about presetting of various parameters. Thus, you can tailor the units to match best to your style of using the unit.

### ADDITIONAL INFORMATION

This section includes detailed information about error handling, PC card recording system, trouble shooting, the specifications, and the "Index of Parts, Controls, and Display", which allows you look up operations of specific controls.

---

---

## Contents

---

---

### SETTING UP

Batteries and AC Adapter .....	xx
Power On/Off .....	xx
Setting the Date and Time .....	xx
Understanding PC Card .....	xx
Connecting Microphones .....	xx
Connecting Analog Components .....	xx
Other Connections .....	xx

### GENERAL FUNCTION

Charging Battery .....	xx
Low Battery Warning and Auto Power Off .....	xx
Data Display .....	xx
Key Lock .....	xx

### RECORDING

Selection and Manipulation of Input Source .....	xx
Recording Behavior Settings .....	xx
Operation .....	xx

### PLAYBACK and EDITING

Basic Operation .....	xx
Repeat Play .....	xx
Marking and EDL Playback .....	xx
Track Handling .....	xx

### PRESETTING

Presetting Parameters .....	xx
-----------------------------	----

### ADDITIONAL INFORMATION

Error Handling .....	xx
Requirement for Card .....	xx
File Structure .....	xx
System Limitations .....	xx
Troubleshooting .....	xx
Specifications .....	xx
Index of Parts, Controls, and Display .....	xx

## Batteries and AC Adaptor

### Alkaline Batteries

The PMD680 uses 8 standard AA-type alkaline batteries. Load as shown in the following illustration.

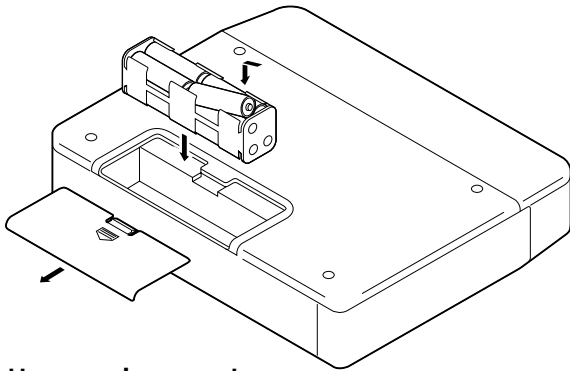

### Battery replacement

When the battery alert indicator (⚡) appears in the display, replace all batteries with new ones. Once this indicator appears there are approximately XXX hours of battery life remaining.

Fresh alkaline batteries can provide up to XXX hours of continuous recording or playback.

### Notes

- When recording, to avoid problems caused by loss of battery power it is recommended to always use new alkaline batteries.
- Use only AA batteries for replacement.
- Be sure to insert the batteries with correct polarity (as illustrated on the battery compartment).
- Remove the batteries if the unit will not be used for an extended period of time.
- Battery life may vary depending on the conditions under which the unit is operated (environmental temperature, humidity, speaker usage, etc.).
- If batteries leak, dispose them immediately. Avoid touching the leaking material or letting it come into contact with clothing, etc. Clean the battery compartment thoroughly before installing new batteries.

### AC adaptor

When recording for extended periods, or using this unit in a studio environment we recommend using the AC adaptor.

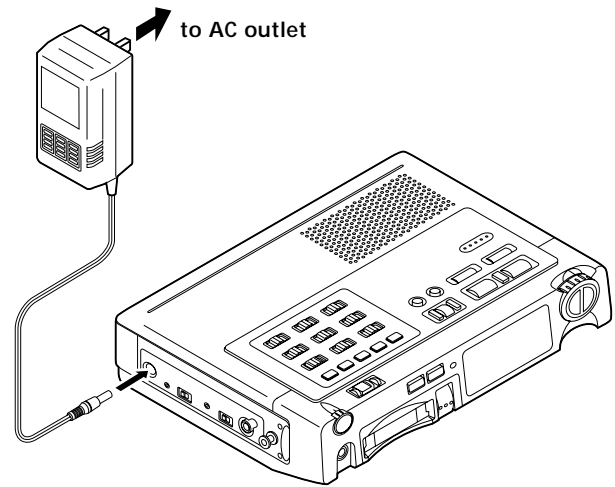

### Notes

- It is recommended to always use a Marantz AC adaptor (DA740PMDU).

### Ni-Cad Rechargeable Battery (optional)

The PMD680 can use an optional Ni-Cad rechargeable battery. Be sure batteries are fully charged before use. These batteries have a longer operating life than standard alkaline batteries, reducing the number of battery changes required under heavy usage (see below). Refer to the following illustrations to load the battery.

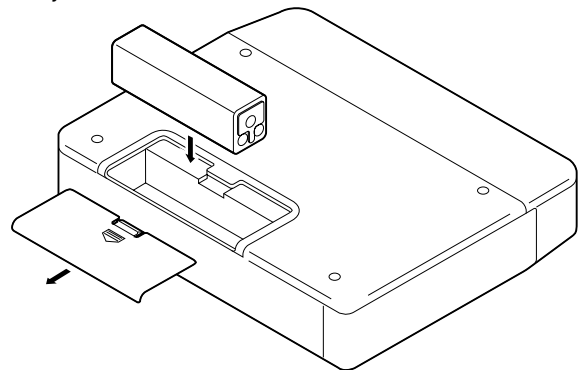

### Battery replacement

When the battery alert indicator (⚡) appears in the display, charge the battery or replace the rechargeable battery with a fully charged one. Once this indicator appears there are approximately (???) hours of battery life remaining.

Fully charged Ni-Cad batteries can provide up to 3 hours of continuous recording or playback.

### Charging time

Approximately 3 hours.

### Notes

- When recording, to avoid problems caused by loss of battery power it is recommend to always use fully charged batteries.
- Battery life may vary depending on the conditions under which the unit is operated (environmental temperature, humidity, speaker usage, etc.).
- It is recommended to only use the Marantz AC adaptor (DA740PMDU) for charging the rechargeable battery.

## Power On/Off

### Power on

Sliding the power switch rightward makes power on and off in turn.

When power is applied from the battery or the AC adapter, sliding the power switch make the unit enter standby status.

Sliding the power switch rightward in standby status, the main power is put on and the unit detects existence of the card in the card slot.

If the card in the slot is formatted complying with the units specification, the display blinks showing TOC (Tabel Of Contents) creating message, then enters stop status.

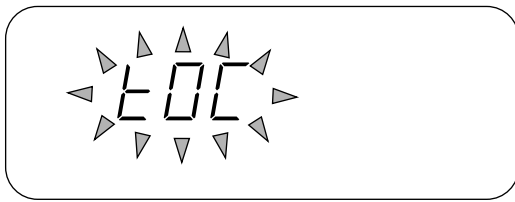

□About the display in stop status, please refer to the chapter of "Data Display" on page xxx.

If the card is not formatted complying with the unit specification, the display shows unformat message.



If the card does not exist in the card slot, the display shows no card message.

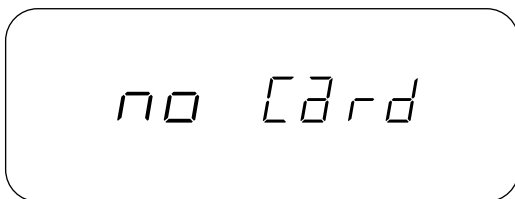

### Power Off

Sliding the power switch rightward while main power is on, the main power is put off after necessary process for shutdown, and the unit enters standby status.

While recording or rec-pause, the main power is not put off even if the power switch is operated.

## Setting the Date and Time

Before operating your PMD680, perform the following operations to set the current date and time.

The current date and time are recorded automatically at the beginning of each recording.

- 1 With the power off, slide POWER to the right while holding down DISPLAY (TIME/DATE). The unit turns on and enters the date/time setup mode.
- 2 Press ◀◀/|◀◀ or ▶▶/|▶▶ to set the year, then press PLAY/PAUSE (▶/||) to enter.
- 3 Press ◀◀/|◀◀ or ▶▶/|▶▶ to set the month, then press PLAY/PAUSE (▶/||) to enter.
- 4 Press ◀◀/|◀◀ or ▶▶/|▶▶ to set the day, then press PLAY/PAUSE (▶/||) to enter.
- 5 Press ◀◀/|◀◀ or ▶▶/|▶▶ to set the hour, then press PLAY/PAUSE (▶/||) to enter.
- 6 Press ◀◀/|◀◀ or ▶▶/|▶▶ to set the minute, then press PLAY/PAUSE (▶/||) to enter.
- 7 The seconds start counting from 00 and the unit automatically returns to its normal operation mode (stop status) immediately after you press DISPLAY (TIME/DATE) key. Pressing PLAY/PAUSE (▶/||) instead of DISPLAY (TIME/DATE) key, the minute setting is entered and the menu returns to year setting menu (step 2).
- 8 Pressing STOP (■) before setting minute cancels all the date/time setting.

## Understanding PC Cards

The model PMD680 records directly to Flash or Hard Disk-type PC cards. One of the many advantages is that it allows you to transfer audio data to a computer immediately after recording.

### Recommended media

SanDisk® PC Card

SanDisk® Compact Flash (with PC card adapter)

SanDisk and Compact Flash are trademarks of SanDisk.

### Inserting the card

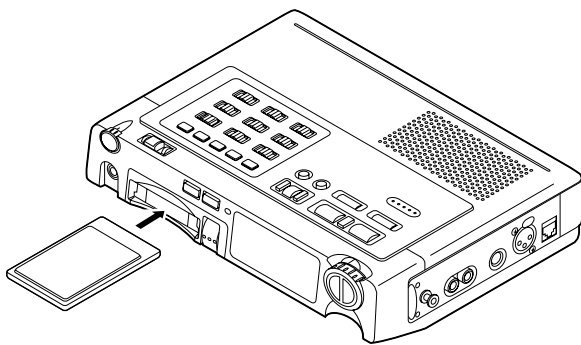

### Notes

- Make sure the card is inserted with the correct side facing up.

### Ejecting the card

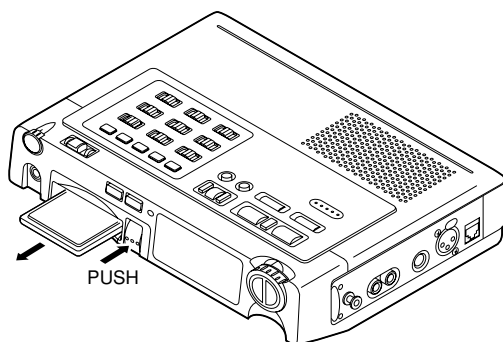

### Note

The EJECT button is mechanical and ejects the PC card regardless of the unit's power or operating status. Do not press EJECT while recording (when the REC indicator is lit). This may result in the loss of all data on the PC card.

### Formatting the PC card

Before using a PC Card for the first time, perform the following operations to format the PC card so that it can be used to record audio. This operation completely erases any information stored on the card. Be sure to backup any important information before formatting.

### Note

You can also use this operation to completely erase a previously used PC card containing audio data you no longer need.

### Operation

- 1 Start operation in standby mode.
- 2 Insert card you want to format.
- 3 Slide the POWER to the right while holding down ERASE (FORMAT).
- 4 The format message is displayed.
- 5 After formatting the card and generate the EDL file, "done" message is displayed for 3 seconds.
- 6 The unit enters the stop status.

Display while formatting



Display when the formatting was done (for 3 seconds)



### Notes

- Even the PC card was formatted by MSDOS PC, formatting by the unit is necessary to format it in the unit's format. After this formatting, the PC card is still readable by PC as MSDOS file. After using the card many times, it is recommended to do this formatting operation to streamline the fragmentation.
- Do not eject the PC card or turn this unit's power off while formatting is in progress.

## Connecting Microphones

Connect the microphones as shown below.

With the PMD680, you can connect a microphone (for mono recording) to either the MIC 1 (XLR) jack or the MIC 2 (1/4" phone) jack.

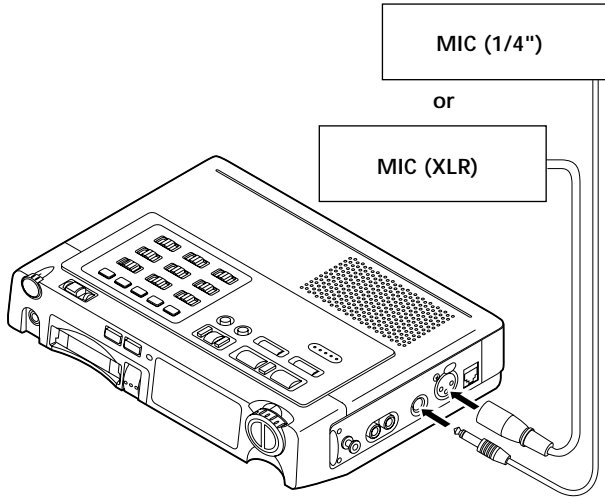

### Notes

- Take care to not connect or disconnect microphones while recording. This may result in unwanted sounds in the recording.

## Connecting Analog Components

The following illustrations show you how to connect analog audio components for recording or playback.

### To record from analog audio components

Connect the source component's analog line output jacks to this unit's LINE IN (RCA) jack.

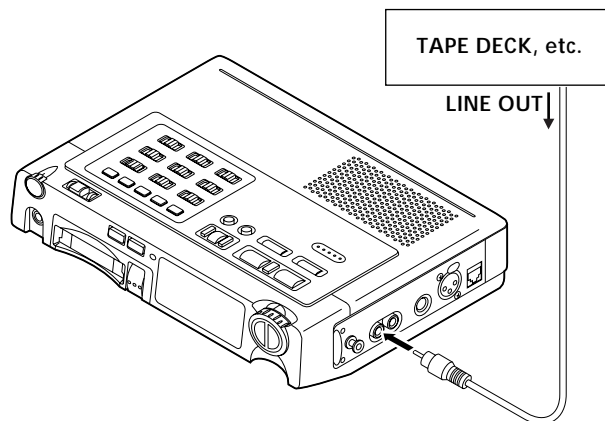

### Notes

- To connect a stereo source to the mono PMD680 LINE IN, a Y-adaptor cable can be used.

### To output analog audio signals to another audio component

Connect the source component's analog line input jacks to this unit's LINE OUT (RCA) jack.

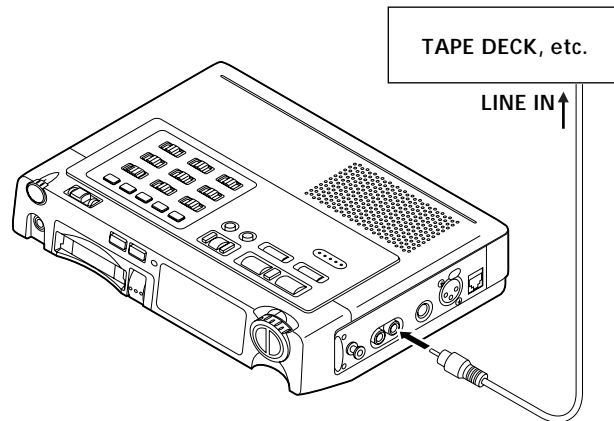

### Notes

- To connect the mono PMD680 LINE OUT to a stereo input, a Y-adaptor cable can be used.

### To record from or output through a telephone wire

Connect the phone line to the TELEPHONE IN/OUT jack.

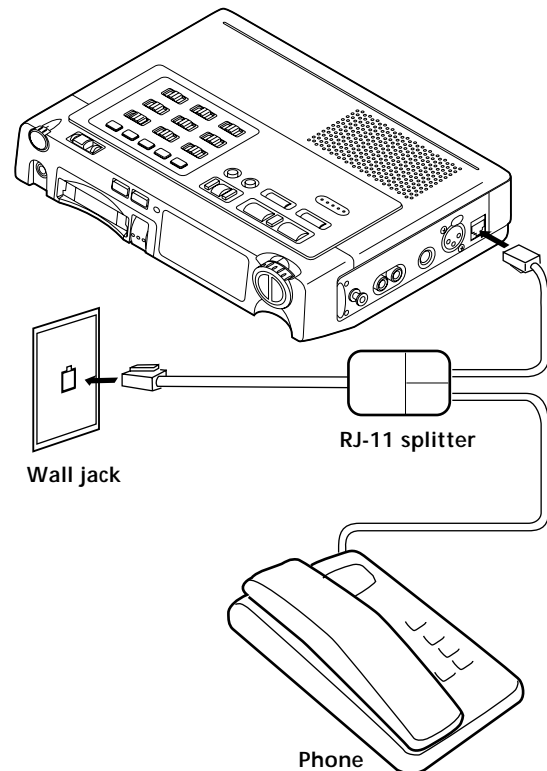

### Notes

- Do not start recording until the telephone connects with the dialed telephone number.
- Please be advised that connecting the PMD680 to a telephone line is illegal in some countries.

## Connecting Digital Components

The following illustrations show you how to connect digital audio components for recording.

### To output digital audio signals to another audio component

Connect the source component's digital input jacks to this unit's DIGITAL OUT (coaxial) jack, and set the DIGITAL OUT switch ON.

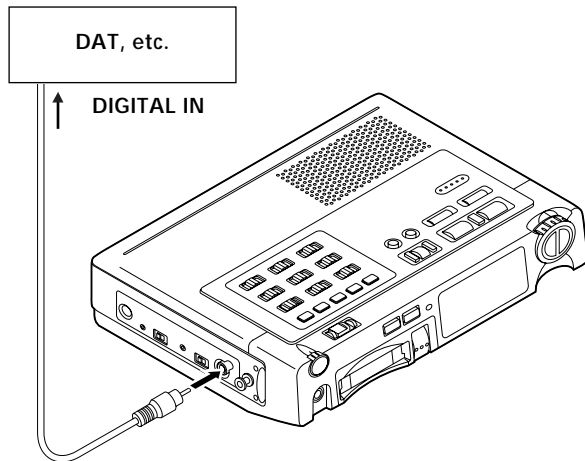

#### Notes

When digital output is not used, turn the DIGITAL OUT switch OFF.

## Other Connections

### Remote control

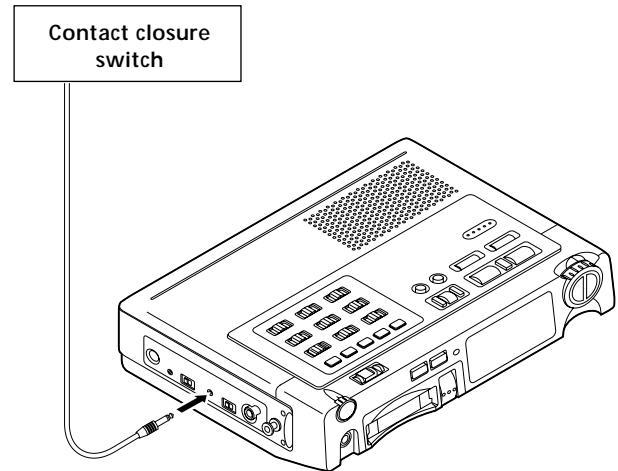

#### Available Functions

The remote Pauses or Un-Pauses the unit when Play status.

#### Notes

- The unit must first be put in Play status manually before the remote connector will work.

### Headphones

Connect headphones to the PHONES output to monitor the sound during recording and playback.

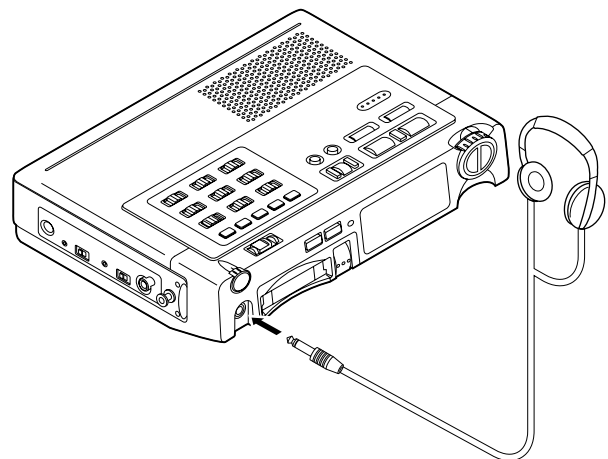

Use the HP / SPK VOLUME knob to control the volume of the headphones. The sound from the internal speaker is muted automatically when headphones are connected.

## Charging Battery

Charging Battery is done while,

- power is supplied from AC adaptor.
- Ni-Cad battery is loaded.
- presetting of battery is Ni-Cad battery (refer to page xxx, PRESETTING).
- CHARGE slide switch setting is ON

While charging, charge LED blinks. After charge is completed, charge LED becomes stably on.

### Note

- Charge does not happen and charge LED turns off while power is on. Charge occurs only in standby (power off) status.

## Low Battery Warning and Auto Power Off

When the remaining battery energy is anticipated to last in about xxx minutes, battery warning indicator turns on in the display (1st warning).



After that, when the remaining battery energy is anticipated to last soon, battery warning indicator in the display and REC LED start to blink, and beep sound turns on and off in 1 second interval (2nd warning).

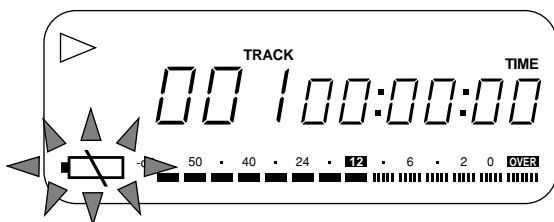

After 2nd warning, when the battery voltage goes down lower than operating voltage, the unit enters auto power off process. If the unit is working (playback, recording, editing), necessary shut down process (file update and closing) takes place. Then the power is turned off and the unit enters standby status.

## Data Display

### Changing Display Information

Pressing DISPLAY (TIME/DATE) key changes the display information as follows.

### During stop mode

① Total Track No

Total Track Time

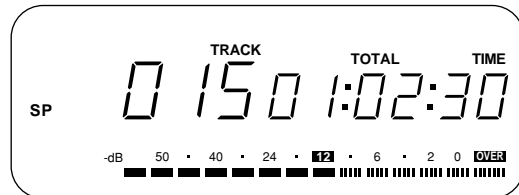

② Total Track No

Remain Time

(time available for recording at the selected bit rate)



③ Current Time

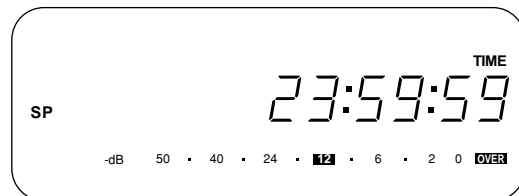

④ Current Date

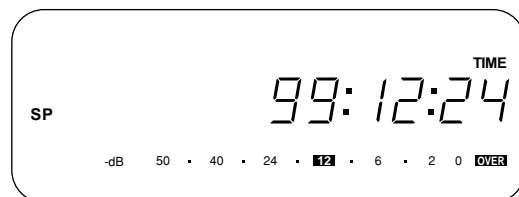



## During playback

- ① Current Track No      Time elapsed on current playing track

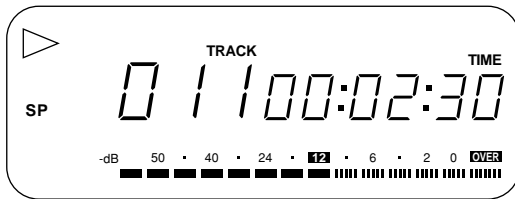

- ② Current Track No      Remain time of current playing track

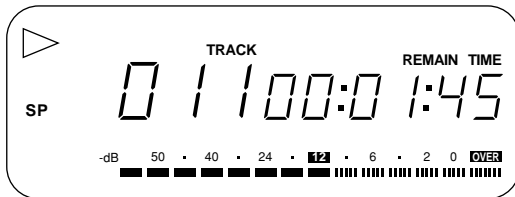

- ③ Current Track No      Accumulated time elapsed (Total time of exiting tracks previous to the current track + time elapsed on current playing track)

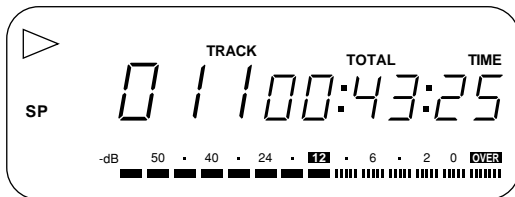

- ④ Current Track No      Total playback remain time (Total time of exiting tracks after the current track + Remain time of current playing track)

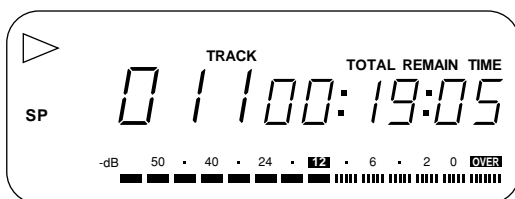

- ⑤ Recorded Bit Rate      Time when the current track recording was started

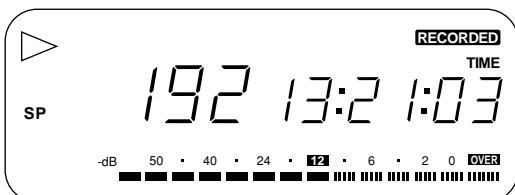

- ⑥ Recorded Bit Rate      Date when the current track recording was started

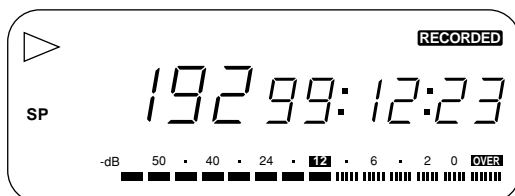

## During Recording

- ① Current Track No      Recording elapsed time on current track

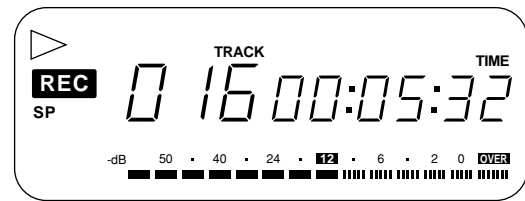

- ② Current Track No      Remain recording time (Time available for recording)

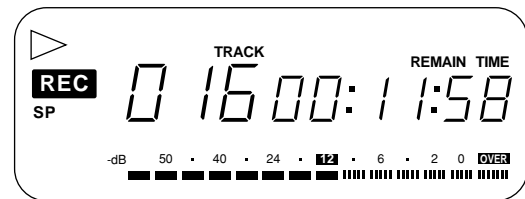

- ③ Current Track No      Accumulated recording time elapsed (Total time of exiting tracks previous to the current track + recording time elapsed on the current track)

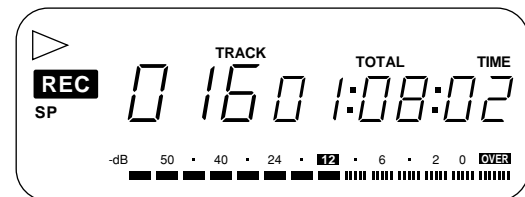

### To Illuminate the Display Panel

- Pressing LIGHT key for less than 1 second, the back light of the display panel turns on for 3 seconds and turns off.
- Pressing the LIGHT key for 1 second or more, the back light turns on and keeps on. Pressing the LIGHT key again, the back light turns off.

## Keylock

To avoid accident by unintentionally hitting the key, keylock function is provided.

While the KEYLOCK slide switch is set to LOCK position, any other key operation is neglected except that;

LIGHT key while power on status.

POWER key while power off (standby) status.

If you operate the other keys, "Hold" message is displayed for 1 second.

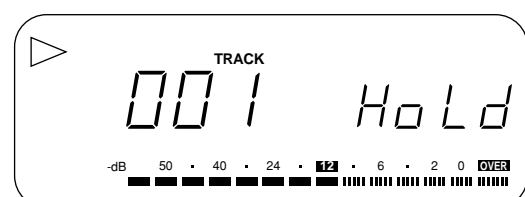

### Note

Keylock effects on PRE REC (slide switch), REC MODE (slide switch), and all push buttons except LIGHT key. Keylock does not effect on other slide switches.

## Selection and Manipulation of Input Source

### Input Source Selection

Input source is selected from external XLR microphone connector input, 1/4" microphone connector input, internal microphone input, line input, and telephone input.

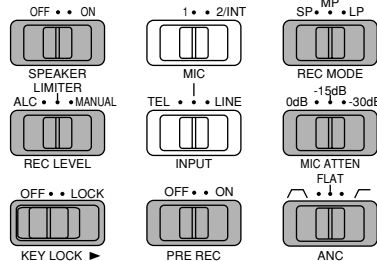

INPUT LEVEL switch selects from telephone input, microphone input, and line input. Only when INPUT LEVEL switch is at the MIC INPUT position, MIC INPUT switch becomes effective. XLR microphone connector input is assigned to "1" position of MIC INPUT switch. 1/4" microphone connector input and internal microphone input are assigned to "2 / INT MIC" position of MIC INPUT switch.

If a microphone plug is inserted into the 1/4" microphone connector, the input from the 1/4" microphone connector becomes effective. If a microphone plug is not inserted into the 1/4" microphone connector, the input from the internal microphone becomes effective.

#### Effective microphone input

MIC INPUT switch position	1	2 / INT MIC
1/4" connector		
Inserted	XLR microphone connector input	1/4" microphone connector input
Not inserted		Internal Microphone Input

### MIC ATTENUATION

MIC ATTENUATION is effective only for the signal from external microphone inputs, i.e. XLR microphone connector input and 1/4" microphone connector input. MIC ATTENUATION is NOT effective for the signal from internal microphone inputs and line input.

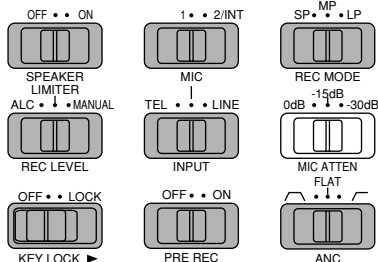

0dB (no attenuation), -15dB attenuation, and -30dB attenuation of the microphone input is selected by MIC ATTENUATION switch. Mic attenuation is used to normalize the difference in sensitivity of the external microphones and realize the best S/N ratio in recording.

### Ambient Noise Control

ANC (Ambient Noise Control) is effective for all microphone input and telephone input, but is not effective for line input.

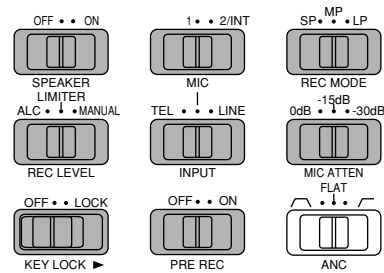

This function filters out unwanted frequencies for recording.

- Band-pass (  $\wedge$  ) : Cuts low frequency (150Hz and lower) and high frequency (3KHz and higher)
- Flat : No filtering
- Low-cut (  $\neg$  ) : Cuts low frequency (150Hz and lower)

### REC LEVEL

For all inputs (external microphone, internal microphone, line), three ways of level control are selected by REC LEVEL switch

- ALC (Automatic Level Control): Automated recording level adjustment based on the level of the input signal (REC LEVEL knob does not effect the recording). Time constant is long to prevent sudden fluctuations in the recording level.
- LIMITER: Although the recording level must be adjusted by REC LEVEL knob, signals over 0VU trigger an automatic reduction of the recording level. Time constant is short to provide quick restoration of the manually set recording level. When limiter works (at signals over 0VU), REC LED also dimms as a noticeable warning. (Refer to Recording Indication on page xx)
- MANUAL: Recording level must be adjusted manually using the REC LEVEL knob.

#### Effective Manipulation for Inputs

Input	Manipulation	MIC ATTENUATION	ANC (Ambient Noise Control)	REC LEVEL (ALC, LIMITER, MANUAL)
Telephone Input		Not effective	Not effective	Effective
MIC	XLR microphone connector input	Effective	Effective	Effective
	1/4" microphone connector input	Effective	Effective	Effective
	Internal microphone Input	Not effective	Effective	Effective
Line Input		Not effective	Not effective	Effective

### Recording Level Adjustment

For the input on which REC LEVEL is effective (refer to the above table), recording level should be adjusted using LEVEL KNOB. Watching the audio level meter and monitoring the input sound, use the REC LEVEL knob to adjust the audio level meter so that the 0dB indicator just barely flicker at the highest peak of the input sound level. The OVER indicator should not light (this would result in clipping).

# Recording Behavior Setting

## REC MODE

Three recording modes are selectable

- LP (Long Play mode): Long playback/recording time, Low sound quality. (Icon LP is showed on the display during recording status and rec-pause status.)
- MP (Medium Play Mode): Medium playback recording time, Medium sound quality. (Icon LP and SP turn off on the display during recording status and rec-pause status.)
- SP (Short Play mode) Short playback/recording time, High sound quality. (Icon SP is showed on the display during recording status and rec-pause status.)

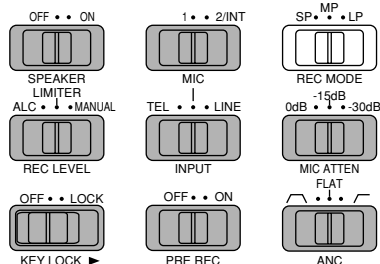

The bit rate is assigned to each recording mode by preset operation (Refer to the chapter of Presetting Parameters on page xx).

## PRE REC

While PRE REC switch is on, pre-recording function becomes active. While REC PAUSE status, 2 seconds sound data is recorded in a buffer memory in the unit in first-in-first-out manner.

So, 2 seconds of recording is added prior to the recording made after the recording operation is started. This function saves from missing the unexpected recording chance which occurs suddenly.

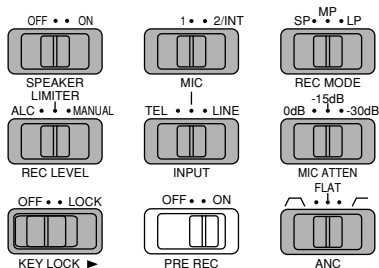

### Note

- If REC PAUSE status was less than 2 seconds, the sound during REC PAUSE is pre-recorded.
- When pre-recording is started, recording elapsed time shown in the display starts counting up. If the pre-recording status exceeds 2 seconds, the recording elapsed time in the display keeps blinking showing 2 seconds.
- When recording is started, pre-recorded time (2 seconds in maximum) is added to the time after recording is started, and so displayed.
- If STOP is pressed while REC PAUSE status, pre-recorded data is lost and the unit enters STOP status.

## SILENT SKIP

After detecting continuous certain length of silence, the unit enters rec-pause status and stays in that status as long as silence continues. When sound input is detected, the unit resumes recording. This function saves the card memory by skipping the silent part.

Silent skip mode is set and reset in toggle manner by pushing the SILENT SKIP button. While silent skip mode is set, the icon S.SKIP turns on in the display.



The level and the length of sound to enter the rec-pause status are preset by preset operation (refer to Presetting Parameters on page xx). The factory setting (default) value is three seconds, -40 dB.

The sound level to resume recording is always -24dB. SILENT SKIP always works with pre-recording function (PRE-REC) regardless of PRE-REC switch setting, to prevent dropping of recorded sound when the recording is resumed.

### Note

Silent skip works while recording status. So, once you have to start recording.

In rec-pause status made manually (by pressing REC/MARK button once in stop status, or by pressing PLAY/PAUSE button while recording), the recording does not start even if the sound is detected.

## AUTO MARK

A mark is put automatically every time rec-pause status changes to REC status.



AUTO MARK mode is set and reset in toggle manner by pushing the AUTO MARK button. While AUTO MARK mode is set, the icon A. MARK turns on in the display.

While silent skip (S.SKIP) mode is set, the unit automatically put a mark when the recording is resumed at the sound detected after the silence.

For mark, refer to "Marking and EDL Playback" on page xxx.

### Note

- AUTO MARK mode can be set/reset whether in recording status or in rec-pause status.
- Maximum quantity of mark in a card is 255. If the quantity of the mark is already 255, the unit does not enter the AUTO MARK mode even pushing the AUTO MARK button.
- When the the unit enters rec-pause status with the 255 marks, AUTO MARK mode is reset and shows mark full message "FULL -P 255" in 3 seconds, staying in recording standby (rec-pause) status. Recording function other than AUTO MARK works normally.

## Recording Operation

### Basic Procedure

- Pressing REC/MARK key in stop status, the unit enters rec-pause status.
- Pressing REC/MARK key in rec-pause status, the unit enters recording status.
- Pressing PLAY/PAUSE key in recording status, the unit enters rec-pause status.
- Pressing REC/MARK key in recording status, the unit put mark at that point (regarding mark, refer to Marking and EDL playback on page xx).
- Pressing STOP key in recording status or in rec-pause status, the unit enters stop status.

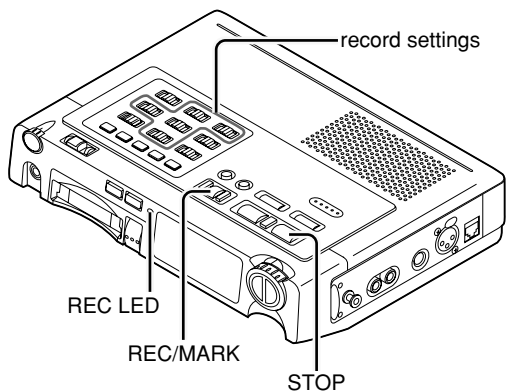

### Sound Level Monitoring

In rec-pause status and in recording status, the input sound becomes audible (through the internal speaker or head phone) and sound level is displayed at the level meter.

### Recording Indication

During rec-pause status, REC indicator on the display and REC LED on the front panel blink.

During recording status, REC indicator on the display and REC LED on the front panel turn on.

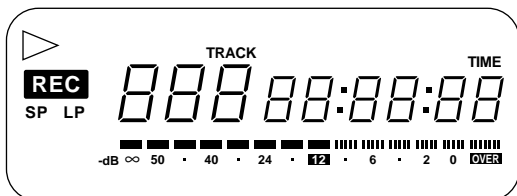

REC LED dimms when the limiter works.  
(Refer to REC LEVEL on page xx)

### Track Number of New Recording

Track number of new recording is next number to that of the last track. If number of the last track is N, the track number of new recording is N+1.

### Card full

When card becomes full while recording, the recording is stopped, the card full message "FUL Card" is displayed for 3 seconds.

This message is also displayed when attempt to start recording was made (REC/MARK button was pressed) after card full. Then the unit stops.

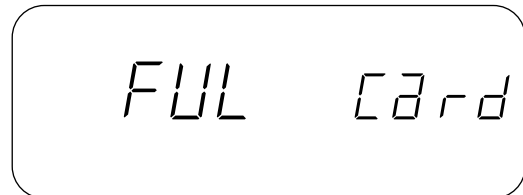

### Track Full

The maximum track number in a card is 255 tracks. When attempt to start recording was made (REC/MARK button was pressed) while 255 tracks exits already in a card, track full message "FUL 255" is displayed.



### Caution

Changing REC MODE switch during recording or rec-pause is not effective. The change is effective only in stop status and the REC MODE is applied to the next track recording.

The minimum length of one track is 0.5 second. A track less than 0.5 second is not generated (If you start recording and stop it after less 0.5 second, a track would not be made).

## Basic Operation

Playback can be monitored through the internal speaker or a pair of headphones. Use the HP/SPK VOLUME knob to adjust the level of the internal speaker or headphones.

The audio signal is also output from the LINE OUT jack, DIGITAL OUT jack, and TELEPHONE IN/OUT jack. The level of the signals output from these jacks is not effected by the position of the HP/SPK VOLUME knob.

## Preparation

### SPEAKER MODE / SPEAKER

To listen to the playback via the internal speaker, set the SPEAKER switch to ON. To mute output from the internal speaker (when using an external monitor system, etc.) set SPEAKER to OFF.

#### Note

When headphones are connected no sound comes from the internal speaker, regardless of the setting of the SPEAKER switch.

## Operation

### To start playback

Press PLAY/PAUSE (▶/⏸) during stop mode.

### To pause during playback

Press PLAY/PAUSE (▶/⏸).

The playback is paused at the location when PLAY/PAUSE is pressed.

### To switch the information shown in the display

Press TIME (refer to Data Display on page XX).

## Stop

To stop playback, press STOP (■).

If mark was edited during the playback, EDL file is updated. During EDL update, display shows "TOC" blinking (about EDL, refer to Marking and EDL Playback on page xx).

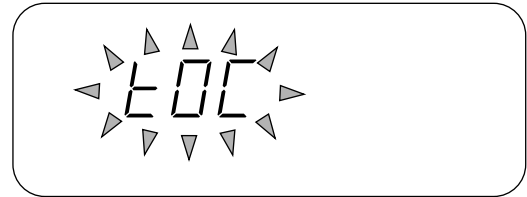

When STOP key is pressed, playback location returns to the beginning of the first track.

## Audible Seek

This section explains about higher speed (x4) audible access.

(refer to Summary of Accessing Behavior on page xxx for the details)

### Seek <sup>+</sup>

Seek <sup>+</sup> is 4 times fast audible forward access.

Press and hold ►►/►► during playback.

The unit playbacks forward at four times as high speed as normal playback speed.

Holding the ►►/►► pressed.

The unit keeps going the Seek <sup>+</sup>. Then releasing the ►►/►►, the unit resumes playback at the normal speed. Playback time counter is displayed according to the Seek <sup>+</sup> motion.

### Note

While keeping on Seek <sup>+</sup>, the unit works as follows according to repeat play mode (refer to Repeat Play on page xxx):

- If single track repeat mode is not set, Seek <sup>+</sup> goes through the tracks until the end of the last track. Then;
  - If entire track repeat mode is not set, the unit stays at the end of the last track without sound.
  - If entire track repeat mode is set, the unit skips to the top of the first track and continues Seek <sup>+</sup>. (When entire track repeat mode is on, whole tracks are assumed to be continuous in a circle manner in Seek <sup>+</sup>, that is, next track to the last track is assumed as the first track.)
- If single track repeat mode is set, Seek <sup>+</sup> works within the current track only.
  - When the unit reached the end of the track, the unit skips to the top of the current track and continues Seek <sup>+</sup>.

### Seek <sup>-</sup>

Seek <sup>-</sup> is 4 times fast audible backward access.

Press and hold ◀◀/◀◀ during playback.

The unit playbacks backward at four times as high speed as normal playback speed.

Holding the ◀◀/◀◀ pressed, the unit keeps going the Seek <sup>-</sup>. Then releasing the ◀◀/◀◀, the unit resumes playback at the normal speed. Playback time counter is displayed according to the Seek <sup>-</sup> motion.

### Note

While keeping on Seek <sup>-</sup>, the unit works as follows according to repeat play mode (refer to Repeat Play on page xxx):

- If single track repeat mode is not set, Seek <sup>-</sup> goes through the tracks until the top of the first track. Then stays there without sound until the ◀◀/◀◀ is released. After releasing ◀◀/◀◀, the unit resumes playback from there at the normal speed.
- If single track repeat mode is set, Seek <sup>-</sup> works within the current track only.
  - When the unit reached top of the current track, the unit stays there without sound until ◀◀/◀◀ is released. After releasing ◀◀/◀◀, the unit resumes playback from there at the normal speed.

## Un-audible Fast Access

This section explains about 30-250 times fast un-audible access.

(refer to Summary of Accessing Behavior on page xxx for the details)

### FF (Fast Forward)

FF is 30-250 times fast un-audible forward access.

Press and hold ►►/►► during pause status.

The unit runs forward without sound at thirty times as fast as normal playback speed.

After keeping ►►/►► pressed for 2 seconds, the FF speed shifts up to 250 times as fast as normal playback speed.

Keeping ►►/►► pressed, the unit keeps FF.

Playback time counter is incremented and displayed according to the FF motion.

Releasing ►►/►►, the unit pauses at the location shown by the time counter.

### Note

While keeping on FF, the unit works as follows according to repeat play mode (refer to Repeat Play on page xxx):

- If single track repeat mode is not set, FF goes through the tracks until the end of the last track. Then;
  - If entire track repeat mode is not set, the unit pauses at the end of the last track.
  - If entire track repeat mode is set, the unit skips to the top of the first track and continues FF. (When entire track repeat mode is on, whole tracks are assumed to be continuous in a circle manner in FF as well as in Seek<sup>+</sup>. That is, next track to the last track is assumed as the first track.)
- If single track repeat mode is set, FF works within the current track only.
  - When the unit reached the end of the track, the unit skips to the top of the current track and continues FF.

## RWD (ReWind)

RWD is 30 times fast un-audible backward access.

Press and hold ◀◀/◀◀ during pause status.

The unit playbacks backward at thirty times as high speed as normal playback speed.

After keeping ◀◀/◀◀ pressed for 2 seconds, the RWD speed shifts up to 250 times as fast as normal playback speed.

Keeping ◀◀/◀◀ pressed, the unit keeps RWD.

Playback time counter is decreased and displayed according to the RWD motion.

Releasing ◀◀/◀◀, the unit pauses at the location shown by the time counter.

### Note

While keeping on RWD, the unit works as follows in relation with repeat play mode (refer to Repeat Play on page xxx):

- If single track repeat mode is not set, RWD goes through the tracks until the top of the first track, and pauses there.
- If single track repeat mode is set, RWD works within the current track only.
  - When the unit reached top of the current track, the unit pauses there.

## Track Jump

This section explains about track jump, which enables to access to the top of the destination track.

(refer to Summary of Accessing Behavior on page xxx for the details)

### Next Track Jump

- Tap (press and release in an instant) ►►/►► during playback.  
The playback location jumps to the top of the next track and the unit starts playback. The incremented track number is displayed.
- Tap ►►/►► during pause.  
The playback location jumps to the top of the next track and the unit pauses there. The incremented track number and pause icon (►■) are displayed.

#### Note

If next track jump occurred in the last track, the playback location jumps to the top of the 1st track.

### Previous Track Jump

- Tap ◀◀/◀◀ during playback.
  - If elapsed time from the top of the track is 1 second or less, playback location jumps to the top of the previous track and the unit starts playback from there. The decreased track number is displayed.
  - If elapsed time from the top of the track is more than 1 second, playback location jumps to the top of the current track and the unit starts playback from there.
- Tap ◀◀/◀◀ during pause.
  - If elapsed time from the top of the track is 1 second or less, playback location jumps to the top of the previous track and the unit pauses there. The decreased track number and pause icon (■) are displayed.
  - If elapsed time from the top of the track is more than 1 second, playback location jumps to the top of the current track and the unit pauses there. The decreased track number and pause icon (►■) are displayed.

#### Note

Previous track jump occurred before 1 second track time of the 1st track results in track jump to the top of last track.

## Track Count Up/Down

Starting from stop status, track count up/down enables quick track select.

(refer to Summary of Accessing Behavior on page xxx for the details)

### Track Count Up

- Tap ►►/►► during stop.  
The playback location jumps to the top of the next track and stays there.  
The incremented track number is displayed. Pause icon (►■) is not displayed.
- Press and hold ►►/►► during stop.  
The track number counts up quickly (4 track/sec). After keeping ►►/►► pressed for 2 seconds, count up speed doubles (8 track/sec). Releasing ►►/►►, playback location stays at the top of the track which track number is shown in the display.  
The increased track number is displayed.

### Track Count Down

- Tap ◀◀/◀◀ during stop.  
The playback location jumps to the top of the previous track and stays there. The decreased track number is displayed.
- Press and hold ◀◀/◀◀ during stop.  
The track number counts down quickly (4 track/sec). After keeping ◀◀/◀◀ pressed for 2 seconds, count down speed doubles (8 track/sec). Releasing ◀◀/◀◀, playback location stays at the top of the track which track number is shown in the display.  
The decreased track number is displayed.

#### Note

In track count up/down, it is assumed that the first track and the last track is next track each other. Thus, track count up occurred at the last track causes jump to the first track. Similarly, track count down occurred at the first track causes jump to the last track (regardless of repeat mode setting).

## Repeat Play

You can have the unit repeatedly play a single track or the full card.  
Or, you can specify repeat points anywhere in the tracks (refer to page xxx, EDL play)

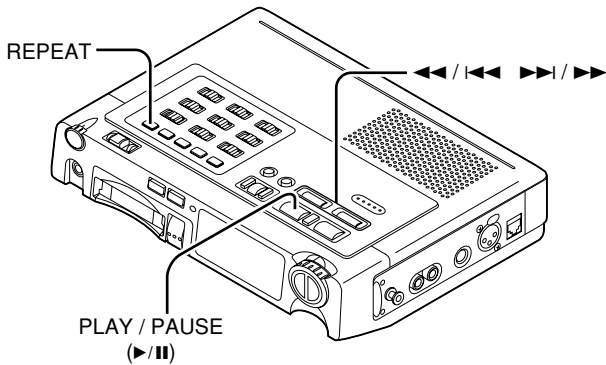

### Repeating a Track

- 1 Use ◀◀/|◀◀ or ▶▶/|▶▶ to select the track you want to repeat.
- 2 Press PLAY/PAUSE (▶/||) to start playback.
- 3 Tap REPEAT repeatedly until "REPEAT 1" appears in the display.

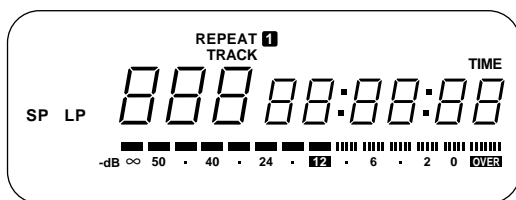

#### To cancel

Press REPEAT repeatedly until "REPEAT" and "REPEAT 1" disappear from the display.

### Repeating the Entire card

Press REPEAT repeatedly until "REPEAT" appears in the display.

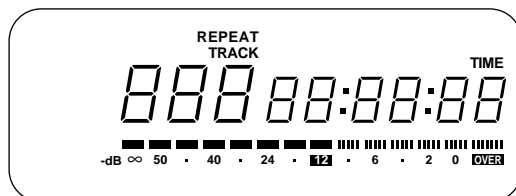

#### To cancel

Press REPEAT repeatedly until "REPEAT" and "REPEAT 1" disappears from the display.



## Summary of Accessing Behavior

Key Operation		Status when key is hit	Action during holding the key pressed	Action after the key is released	Behavior in Repeat Mode		
					Repeat Mode On		Repeat mode Off
					Entire Card Repeat	Single Track Repeat	
▶▶/▶▶	Tap	<b>Play</b>	–	<b>Next Track Jump</b> Playback from the top of the next track	The next track to the last track is the 1 <sup>st</sup> track*		
		<b>Pause</b>	–	<b>Next Track Jump</b> Pause at the top of the next track			
		<b>Stop</b>	–	<b>Next Track Jump</b> Stop at the top of the next track			
	Press and Hold	<b>Play</b>	<b>Seek +</b> x4 audible	Playback from the location where the key is released	End of the last track continues to the top of the 1 <sup>st</sup> track	End of the current track continues to the top of the current track	At the end of the last track, the unit enters stop status.
		<b>Pause</b>	<b>FF</b> x30 - x250 un-audible	Pause at the location where the key is released			
		<b>Stop</b>	<b>Track Count Up</b> Quick Track Count Up	Stop at the top of the track indicated by the track counter	The next track to the last track is the 1 <sup>st</sup> track*		
◀◀/◀◀	Tap	<b>Play</b> at track time ≤ 1 sec	–	<b>Previous Track Jump</b> Playback from the top of the previous track	Previous track to the 1 <sup>st</sup> track* is the last track		
		<b>Play</b> at track time > 1 sec	–	<b>Previous Track Jump</b> Playback from the top of the current track			
		<b>Pause</b> at track time ≤ 1 sec	–	<b>Previous Track Jump</b> Pause at the top of the previous track	Previous track to the 1 <sup>st</sup> track* is the last track		
		<b>Pause</b> at track time > 1 sec		<b>Previous Track Jump</b> Pause at the top of the current track			
		<b>Stop</b>	–	<b>Previous Track Jump</b> Stop at the top of the previous track	The previous track to the 1 <sup>st</sup> track is the last track*		
Press and Hold	<b>Play</b>	<b>Seek -</b> x4 audible	Playback from the location where the key is released. When the top of the 1 <sup>st</sup> track is reached, pause there while key is held pressed, and resume playback after releasing the key.	When the top of the current track is reached, pause there while key is held pressed, and resume playback after releasing the key.	When the top of the 1 <sup>st</sup> track is reached, pause there while key is held pressed, and resume playback after releasing the key.		
	<b>Pause</b>	<b>RWD</b> x30 - x250 un-audible	Pause at the location where the key is released	When the top of the 1 <sup>st</sup> track is reached, pause there.	When the top of the current track is reached, pause there.	When the top of the 1 <sup>st</sup> track is reached, pause there.	
	<b>Stop</b>	<b>Track Count Down</b> Quick Track Count Down	Stop at the top of the track indicated by the track counter	The previous track to the 1 <sup>st</sup> track is the last track*			

\* The track number of the 1<sup>st</sup> track is not always track number 1. For example, if the 1<sup>st</sup> track is deleted, the 1<sup>st</sup> track may be track number 2. After renumbering operation, the first track will be track number 1.

## Marking and EDL Playback

### Marking Operation

Pushing REC/MARK key during playback, playback pause, and recording, a mark is placed at the location where REC/MARK key is pressed.

Putting mark helps access to the marked location, and further, in EDL Playback mode, the marks can be used to specify the skip start point, skip destination, and repeat points.

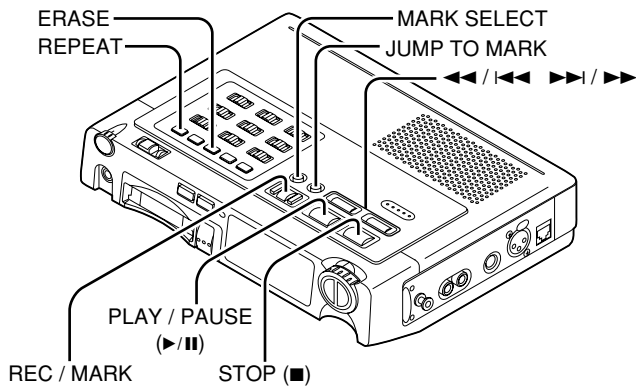

Every time a mark is placed, the total quantity of mark is displayed for one second instead of track number (**TRACK** icon turns off). Then, the display resumes track number display (**TRACK** icon turns on).

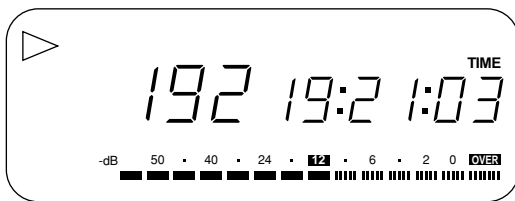

When a mark is placed, the total quantity of mark is displayed (total quantity of mark = 192)

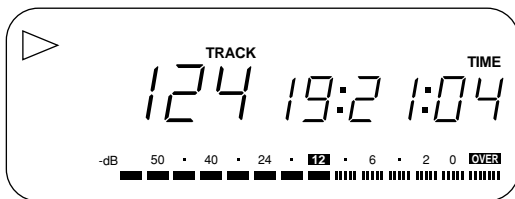

After one second, the display resumes track number display (track number = 124)

#### Note

- The marked location data is stored in the EDL file in the card.
- The updated marked location data is written in the EDL file when the units enters STOP status.
- The mark placed by pressing REC/MARK key is not yet assigned attributes (Skip, -a,-b) for EDL Playback.
- The maximum number of mark placed in a card is 255. Attempt to place a mark while already 255 marks were placed, mark full message, "FUL -p 255", is displayed for 3 seconds. The mark is not put any more.

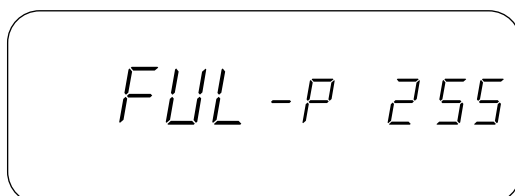

### AUTO MARK

AUTO MARK mode automatically places a mark when recording starts from rec-pause status.

In silent skip recording mode as well, a mark is placed every time when recording is resumed detecting sound from the rec-pause status made by silence.

The total quantity of mark is displayed for one second instead of track number (**TRACK** icon turns off). After one second, the display resumes track number display (**TRACK** icon turns on).

Pressing AUTO MARK key turns on and off AUTO MARK mode. When auto marking mode is on, "A.MARK" icon is displayed.

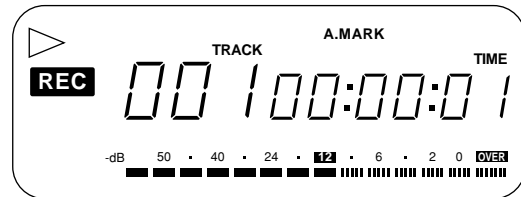

For operation to set Auto Mark mode, refer to "Recording Behavior Setting" on page xxx.

#### Note

Since the maximum number of marks in a card is 255, when rec-pause occurs after 255 marks were placed by auto marking, auto marking mode is automatically removed. "A.MARK" icon turns off, and mark full message "FUL -p 255" is displayed for 3 seconds. Silent skip works after this as well, but a mark would not be put anymore.

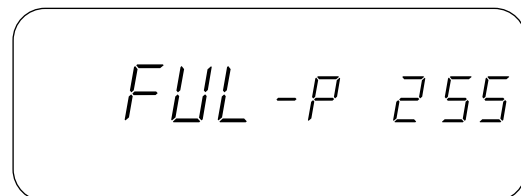

Displayed for 3 seconds

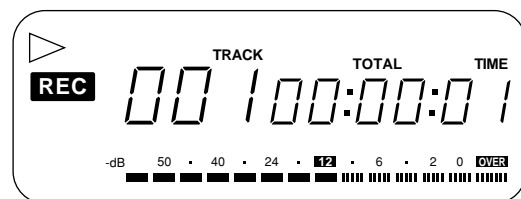

A.MARK indicator turned off.

## Access to the Mark

### Forward Mark Access

In stop status, pressing ►►/►► key while pressing JUMP TO MARK key makes the location jump to the nearest next mark and the unit pauses there. Then, every time pressing ►►/►► key while pressing JUMP TO MARK key, location jumps to next mark point and pauses there. Pressing PLAY/PAUSE while pausing, the unit starts playback from there. Forward mark access from the last mark in a card result in access to the first mark in the card. After track count up/down (see page xxx), the forward mark access makes jump to the mark next to the top of the selected track.

### Backward Mark Access

In stop status, pressing ◀◀/◀◀ key while pressing JUMP TO MARK key makes the location jump to the nearest previous mark and the unit pauses there. Then, every time pressing ◀◀/◀◀ key while pressing JUMP TO MARK key, location jumps to previous mark and pauses there. Pressing PLAY/PAUSE while pausing, the unit starts playback from there. Backward mark access from the first mark in a card results in access to the last mark in the card. After track count up/down (see page xxx), the backward mark access makes jump to top of the selected track.

### Display at Mark Access

When the mark is accessed by forward mark access or backward mark access, the mark number accessed (sequential number) is displayed for one second instead of track (TRACK icon turns off). Then, the display shows track number accessed (TRACK icon turns on).

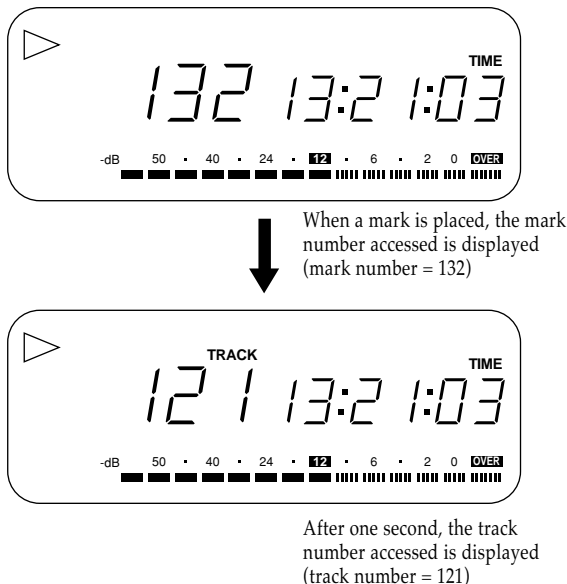

## Editing Mark

### Mark Definition and EDL Playback

The mark is used not only for easy accessing as described above, but also for EDL playback (program playback). Giving definition to certain marks, these mark points becomes skip or repeat point in EDL playback.

### Defining Mark

While pausing at the mark point after mark access (Jump To Mark) operation, press MARK SELECT key. Every time MARK SELECT key is pressed, the display shows definition cyclically.

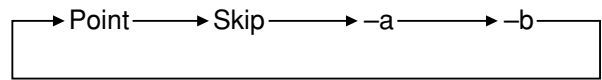

Showing one of above definitions you want on the display, press PLAY/PAUSE key. Then the mark is so defined.

### Display while mark definition

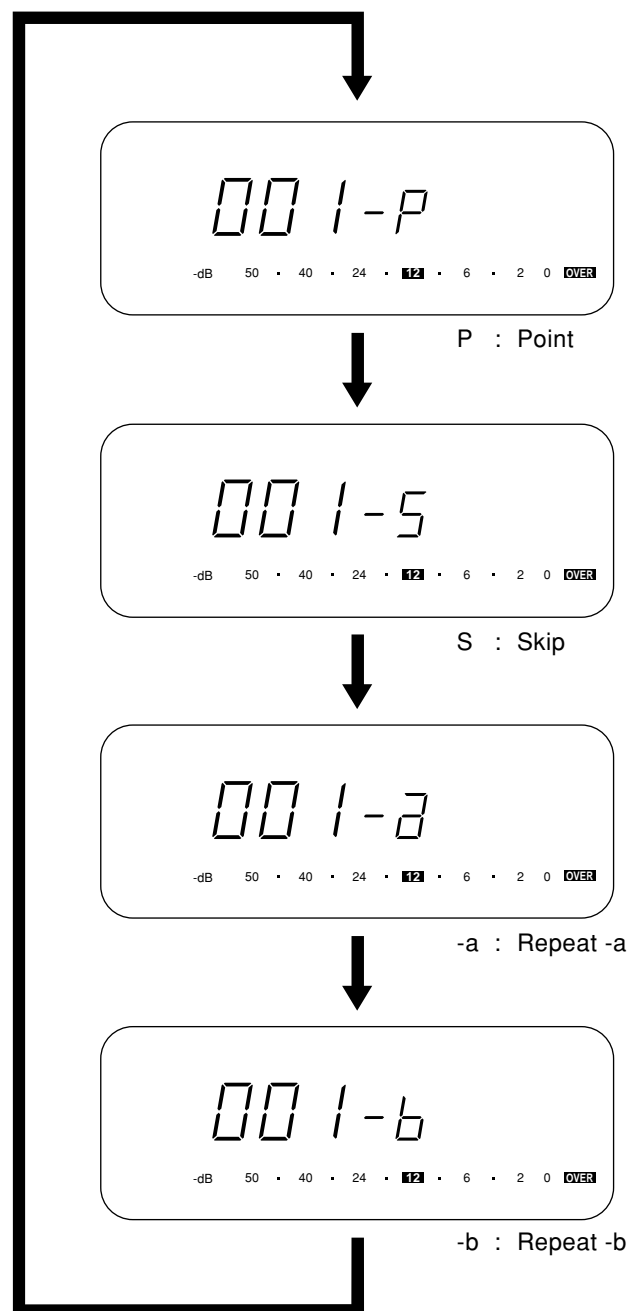

Track number displayed is where the mark to be defined exists.

## Meaning of Mark Definition

Mark put by REC/MARK key or AUTO MARK mode is defined as Point (default definition). Then you can change definition by above operation according to the sequence control purpose such as skip play or repeat play using defined mark.

The meaning of definition to the mark is as follows.

- Point (default); Mark without any sequence control definition. This is only useful for JUMP TO MARK access. In this case, mark is used like a bookmark in the recorded contents.
- Skip ; Sequence control "Skip".
- -a ; Sequence control "Repeat -a".
- -b ; Sequence control "Repeat -b".

### Note

- Skip definition is effective only in EDL playback.
- Repeat -a, -b definitions are only effective in EDL Repeat playback mode.
- Mark defined as Repeat -a exits only one in a card. Mark defined as Repeat -b exits only one in a card as well. To define Repeat -a or Repeat -b, the mark defined last is effective, and former mark with Repeat definition changed to mark with Point definition.
- If Repeat -a is newly defined to a mark, the former mark with Repeat -a definition is change to a mark with Point definition (Mark with Repeat -b definition stay unchanged).
- Similarly, if Repeat -b is newly defined to a mark, the former mark with Repeat -b definition is change to a mark with Point definition (Mark with Repeat -a definition stay unchanged).

## EDL Playback

To start EDL playback, press PLAY/PAUSE key while pressing JUMP TO MARK key. EDL playback always starts from the top of the first track (track with the least track number in the card). In EDL play, when the mark with Skip definition is hit during EDL playback, jump to next mark. If next mark is also defined as Skip, then skip to next mark, until mark with definition other than Skip.

Skip can occur beyond the track, as well as within the track.

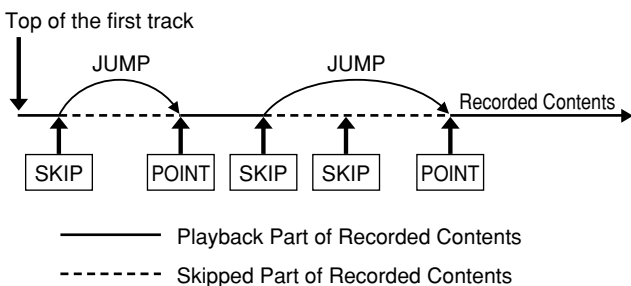

### Note

If skip destination is not found (there is no POINT after the last SKIP) the EDL Playback stops at the last SKIP mark (the end of the track is assumed as the SKIP destination).

## Display during EDL playback

During EDL playback, the play icon (▶) blinks.

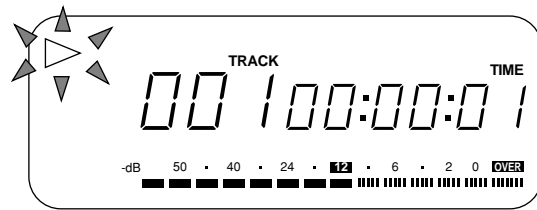

## EDL Repeat Playback

Pressing REPEAT key while EDL playback, EDL playback starts. The unit plays back between the marks defined as Repeat -a and Repeat -b. The "REPEAT" icon turns on. Pressing REPEAT key again, the unit exits from EDL repeat, and resumes EDL playback without REPEAT. The "REPEAT" icon turns off.



## Display during EDL Repeat playback

During EDL Repeat playback, the play icon (▶) blinks. "REPEAT" icon turns on.

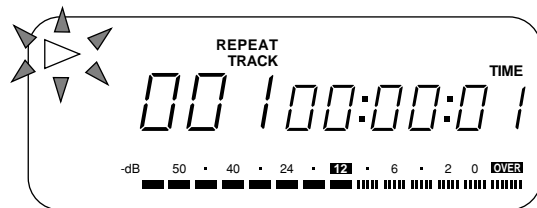

### Note

Skip definition to the mark is effective during EDL Repeat playback. Playback with skip is repeated between the marks with Repeat -a and Repeat -b definition.

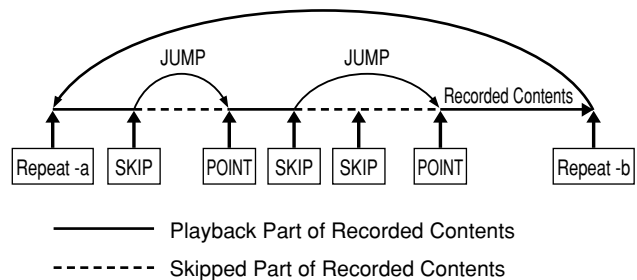

## Playback Control in EDL playback and in EDL Repeat playback

### Pause

Pause is effective in EDL playback and EDL Repeat. Pressing PLAY/PAUSE key during EDL playback or EDL Repeat playback, the unit pauses. Pressing it again resumes EDL Playback or EDL Repeat playback.

### Display during pause while EDL Playback

Pause (▶||) icon blinks.

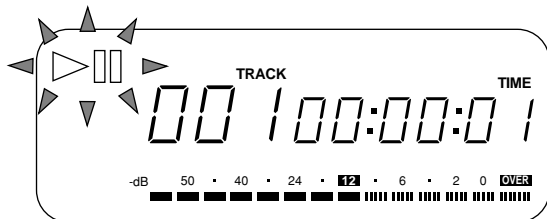

### STOP

Pressing STOP key, the unit stops and exits from EDL playback or EDL Repeat playback.

### Note

During EDL Playback and EDL Repeat playback, Seek+, Seek-, FF, and RWD operations are not effective. Operations attempting to do those operations are ignored.

### Deleting Mark

Select at the mark you like to delete using ▶|/▶▶ key while pressing JUMP TO MARK key, and press ERASE key. The definition of the mark and "Erase" message blinks. Pressing ERASE key again, the unit deletes the mark and enters pause status. Instead, pressing STOP key, the unit cancels to delete the mark.



### Display at mark erase operation

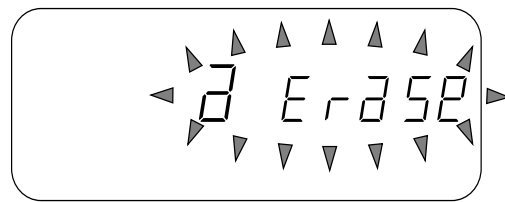

Blinking

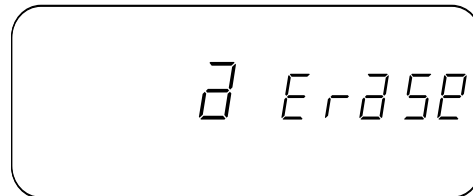

Executing

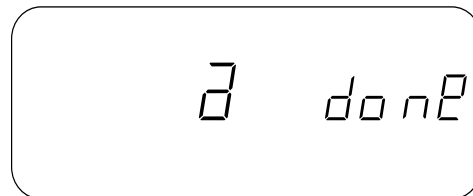

Completed  
(Displayed for 3 seconds)

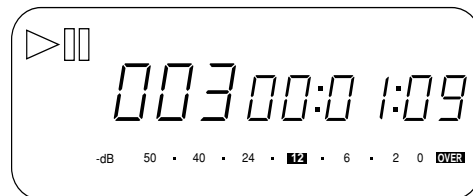

Enter Pause status

# PLAYBACK and EDITING

## Initialization of EDL

Initialization of EDL deletes all marks put in a card. Press ERASE key while pressing JUMP TO MARK key in STOP status while pressing JUMP TO MARK key. "Edl Erase" message blinks. Pressing ERASE key again, initialization is executed. Instead, pressing STOP key cancels initialization and resumes stop status.



## Display at initialization of EDL

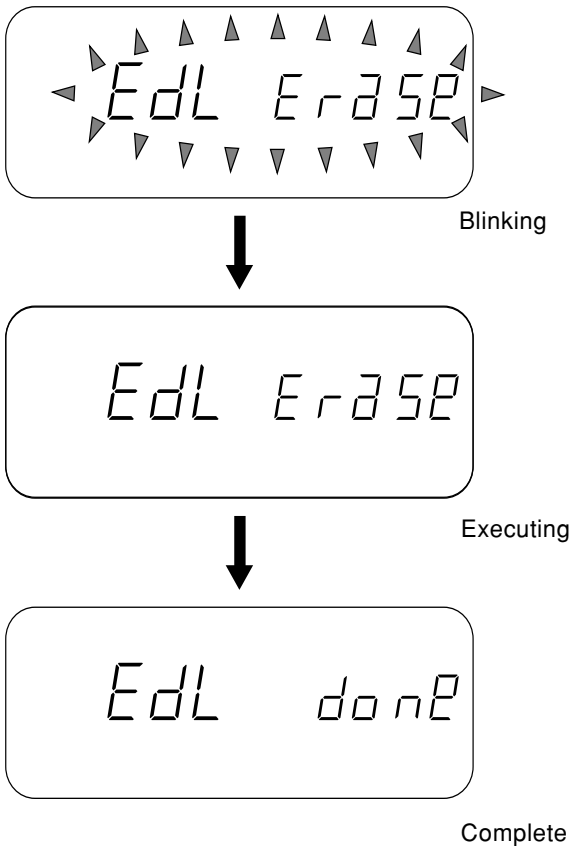

## Displaying Total Number of Marks Placed

Pressing REC/MARK key while pressing JUMP TO MARK key in stop status. The total number of marks is displayed for 3 seconds, then the unit resumes stop status.

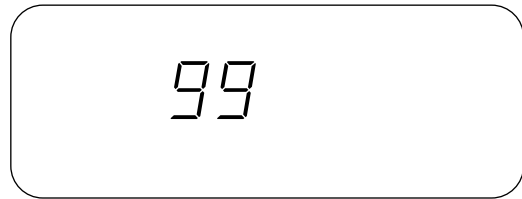

## Mark Inconsistency

When definition to the marks is inconsistent, the unit displays follows.

- One of marks defined as Repeat -a or Repeat -b is not found in EDL Repeat playback.

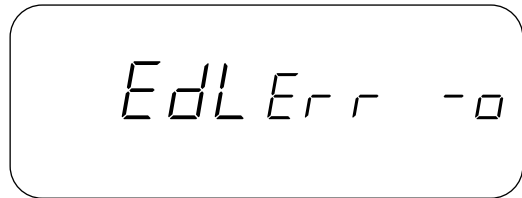

- EDL is initialized when EDL playback or EDL Repeat playback operation is attempted.

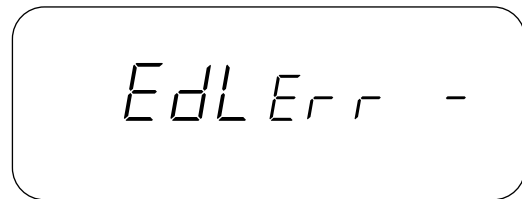

Pressing STOP key, the unit exits from above status, and the unit enters stop atatus.

## Track Handling

### Track Erase

To erase a track you want to erase;

- From stop status, select the track you want to erase and press ERASE key.
- The track number selected is shown, and erase message blinks for confirmation.
- Pressing ERASE key again, the track selected is erased, and completion message is displayed for 3 seconds. Then resumes stop status.
- Instead, pressing STOP key cancels to erase the track and resumes stop status.



### Display at Track Erase Operation EMBED

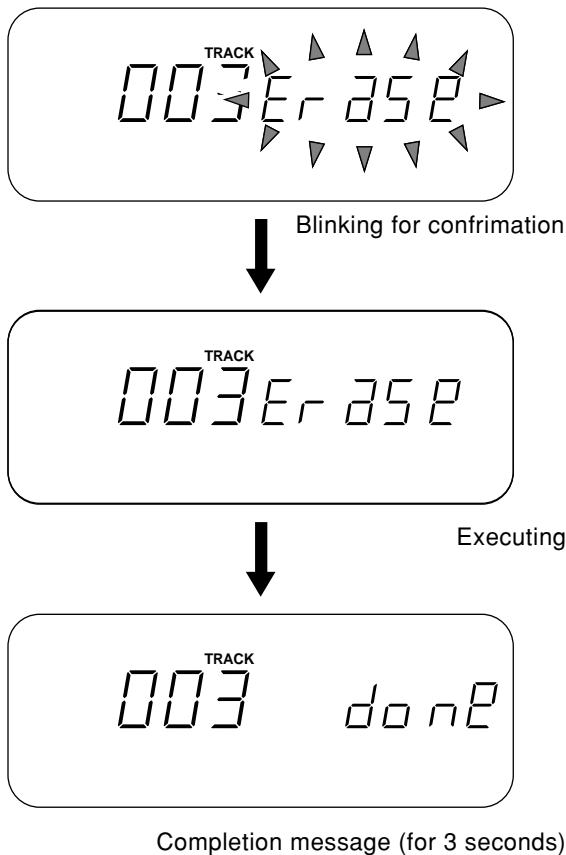

#### Note

After a track is erased, the number of the following tracks after the erased track are not automatically renumbered. The number of erased track becomes absent. The track number of the newly recording is always next to the last track number (the largest track number +1). The absent track number is not re-used for new recording (except that the deleted track was the last track). To renumber the track numbers of tracks after the absent number, track renumber operation is needed.

### Renumbering Track Number

To renumber the track numbers of tracks after the absent number caused by track erase;

From stop status, press RENUMBER key. Renumber message blinks for confirmation. Pressing RENUMBER key again, renumbering is executed. Completion message is displayed for 3 seconds, and units resumes stop status.

Instead, pressing STOP key, renumbering is cancelled, and units resumes stop status. □□□□□



### Display at renumbering operation

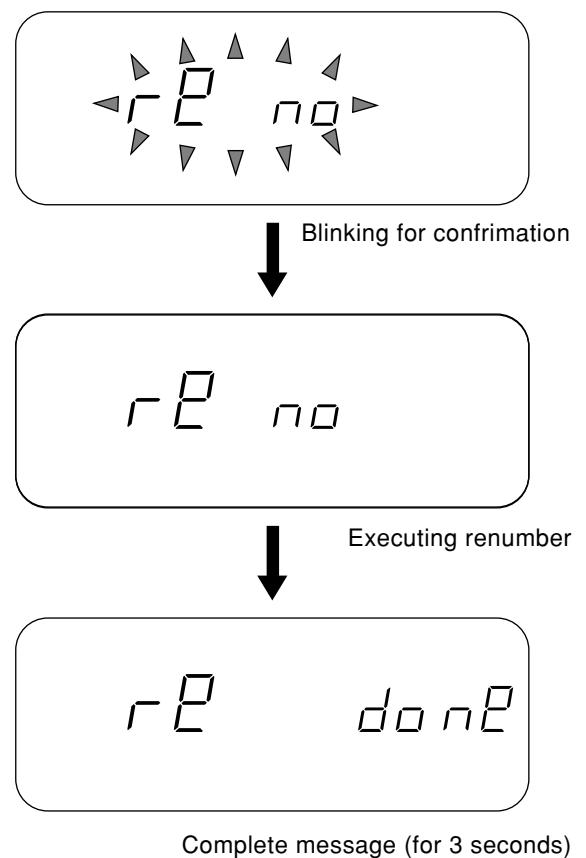

## Presetting Parameters

Presetting parameters, the unit can be tuned to be most suitable for each user.

### Pre-settable Parameters

- Bit rate (MPEG or PCM) assigned to each of SP/LP/MP mode.
- Threshold sound level to detect silence in silent skip mode.
- Threshold time to detect silence in silent skip mode.
- Battery Type
- File format of recorded track.
- ID1 (6 digits)
- ID2 (6 digits)
- ID3 (6 digits)

Parameter	Selectable Setting for the Parameter	Default Setting
Bit rate of SP	768, 192, 128, 96 kbps	192 kbps
Bit rate of MP	192, 128, 96, 48 kbps	96 kbps
Bit rate of LP	128, 96, 48, 32 kbps	64 kbps
Sound level for silent skip	-50dB to -30dB, 1dB step	-40 dB
Silent time for silent skip	1 to 5 second, 1 second step	3 seconds
Battery type	Alkaline, Ni-Cad.	Alkaline
File format	WAVE, LPEG2, BWF	WAVE
ID1,2,3	000000 to 999999	000000

#### Note

ID1-3 is used to record ID numbers in the user blocks in BWF header.

For example, ID1 for ID of the broadcasting station, ID2 for the department code, ID3 for the budge number of the reporter. ID1, ID2, and ID3 are recorded in the "Broadcast Audio Extension" chunk of BWF as follows.

- ID1: Description (the first 6 characters in 256 columns)
- ID2: Originator (the first 6 characters in 32 columns)
- ID3: Originator Reference (the first 6 characters in 32 columns)

## Preset Operation

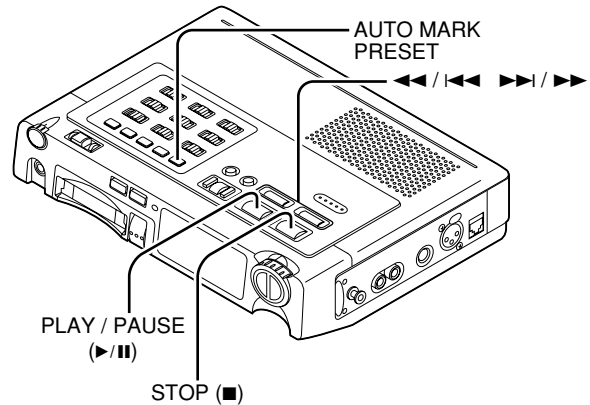

- From standby (power off) status, turn power on while pressing MARK SELECT key. The unit enters preset mode.
  - Using ◀◀/|◀◀ key or ▶▶/|▶▶ key, select which parameter to be set
  - Parameter menu is displayed blinking cyclically as follows;
    - Bit rate for SP → Bit rate for MP → Bit rate for LP →
    - Sound level for silent skip → Silent time for silent skip
    - Battery type → File format → ID1 ID2 ID3
1. While blinking, press PLAY/PAUSE key. Then the blinking parameter is selected as a parameter to be changed, and blinking of parameter stops to be stable on. Instead, settings for the parameter start to blink.
  2. Using ◀◀/|◀◀ key or ▶▶/|▶▶ key, display the selectable settings.
  3. Press PLAY/PAUSE key, displayed setting is assigned to the parameter .
  4. After setting the value for the parameter, you can again select the parameter to be set using ◀◀/|◀◀ key or ▶▶/|▶▶ key. The parameter menu blinks. (Return to item 1).
  5. Pressing MARK/SELECT key, updated parameters are registered and become effective. The unit enters stop status.
  6. Instead, pressing STOP key, update is not done. The preset values stay as it they were before entering preset menu. The unit enters stop status.

### Nesting of Parameter Presetting Menu

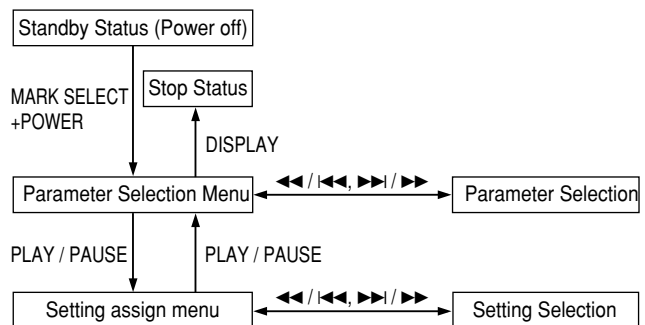



Example of Presetting Operation

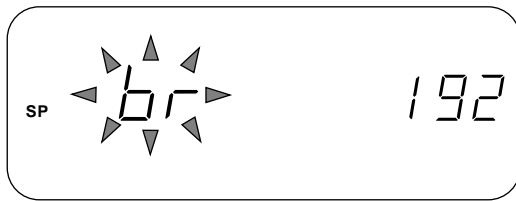

Parameter: Bit rate for SP mode, showing default setting.

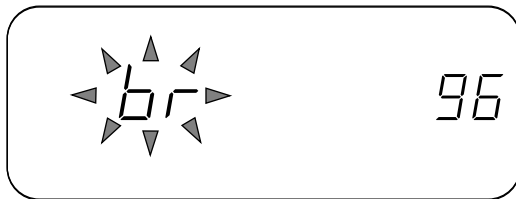

Parameter: Bit rate for MP mode, showing default setting.

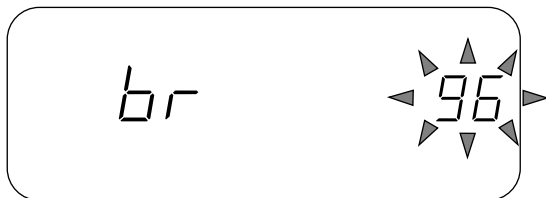

Selected parameter is bit rate of MP

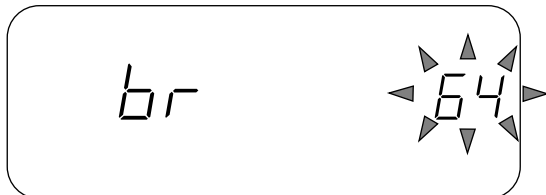
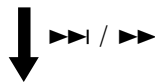

Display the selectable setting

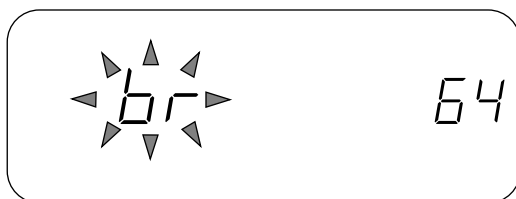

Setting was selected (48kbps for bitrate of MP)

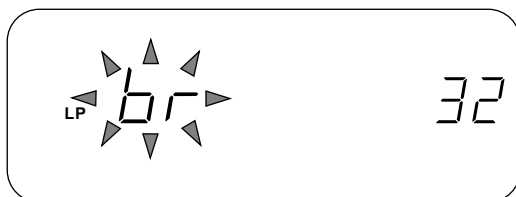
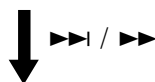

Parameter: Bit rate for LP mode.

# PRESETTING

## Battery Type Presetting

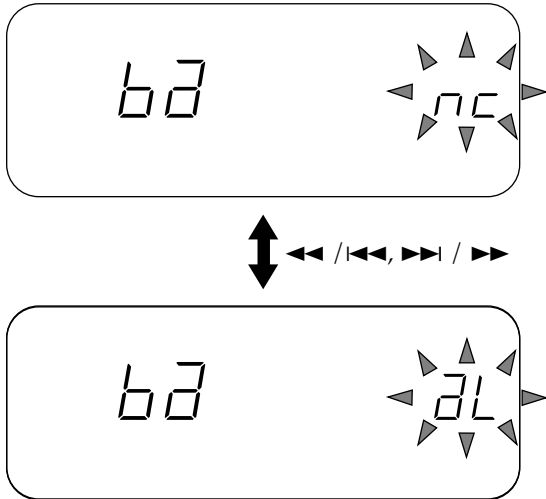

ba:battery, nl:NiCad, al:alkaline

## ID Number Presetting

ID number is applied to the Broadcast Extension Chunk of BWF.

ID1: Description  
ID2: Originator  
ID3: Originator Reference

### ID number setting operation

- In the ID1 parameter setting menu, left most digits blinks. Pressing ►►/►► key increments the digit (0 to 9) one by one, and pressing ◀◀/◀◀ key decrements the digit (0 to 9) one by one.
- Pressing PLAY/PAUSE, the digit is set and the next digit (right to the former digit) starts to blink. Set the value (0 to 9) of this digit using ►►/►► key or ◀◀/◀◀ key.
- Thus, all nine digits were set, menu move to ID1 parameter setting, then, ID3 parameter setting.

## File Format Presetting

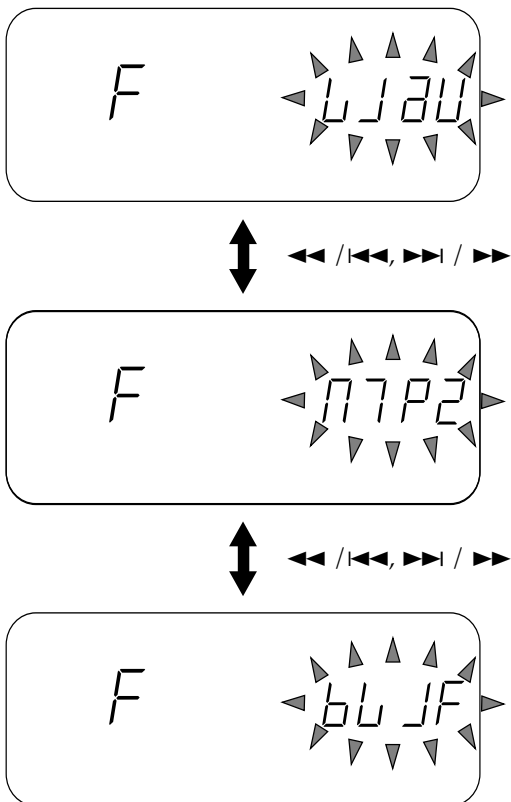

F:file, wav:wave, mp2:mpeg2

Display at Parameter Selection Menu

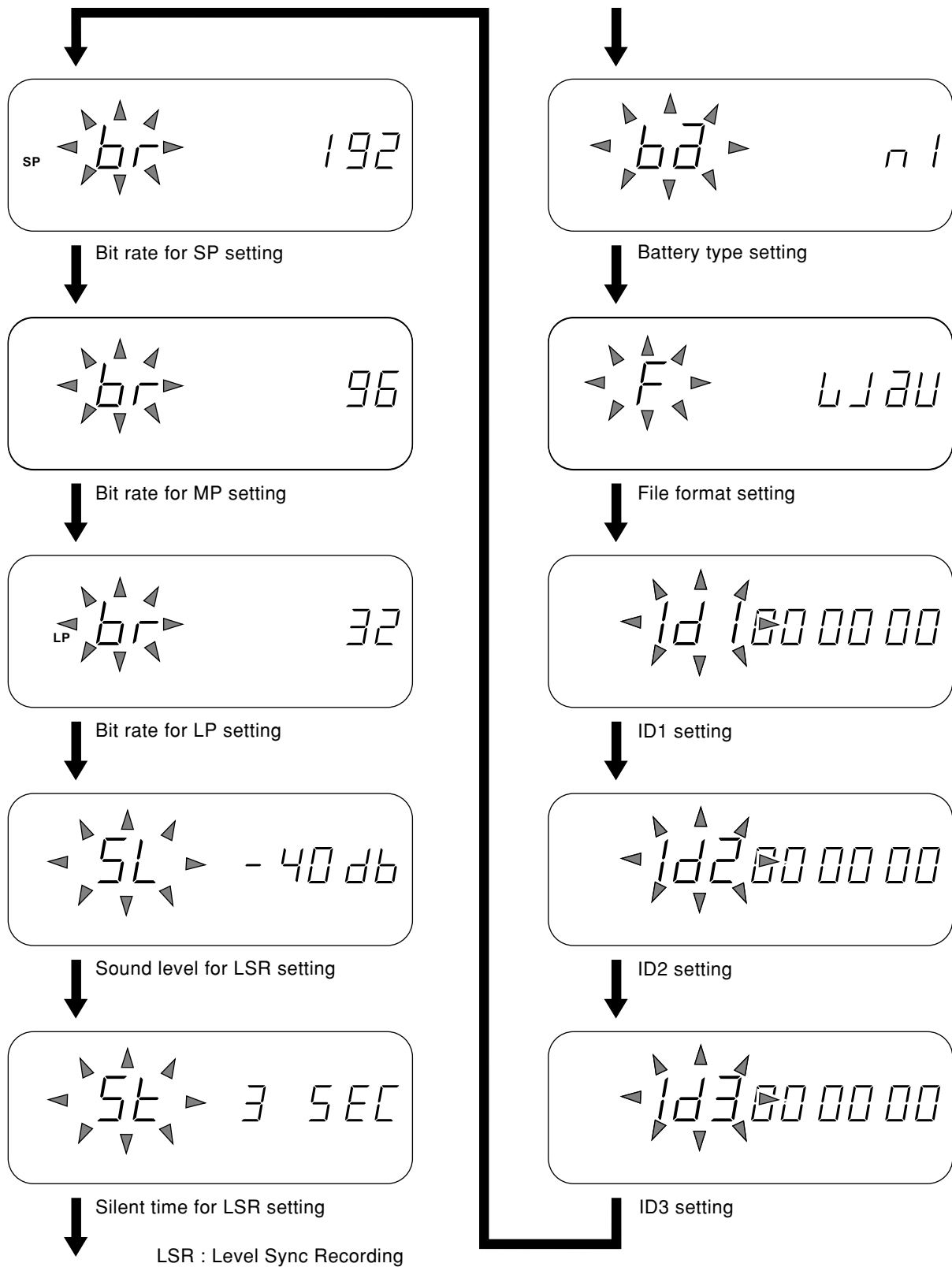

## Error Handling

□ File check and recovery is done at abnormal ending.

### Error Detection

Error is detected in the following case occurs during playback, recording, or editing;

- the card is ejected.
- the power is put off.

When the card is ejected, unit enters error status, and error message is displayed.

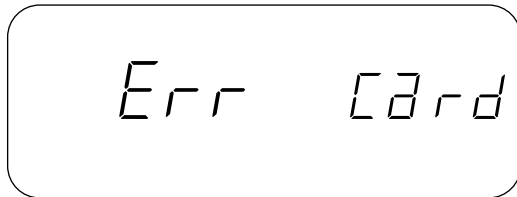

The unit exit from error status by turning the power off (abnormal ending).

Then, turning on the power again, the unit executes error recovery. Following message is displayed during the recovery.

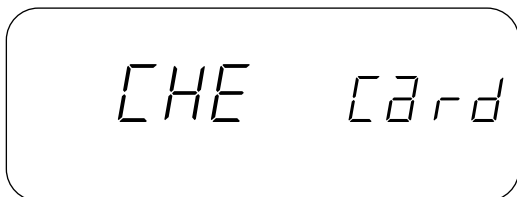

(CHEcking Card)

If recovery was done successfully, following message is displayed.

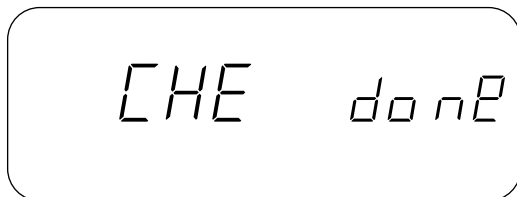

(CHEck done)

If recovery fails, recovery unable message is displayed.

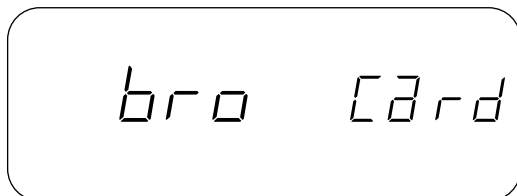

(broken Card)

## Capacity of Card and Recording Time

The maximum capacity supported by the unit is up to 640 MB

Recording time varies according to recording bitrate and capacity of the card.

Approximate recording time/per 100MB is as follows.

### Approximate Recording Time / 100MB

Bit Rate (kbps)	Total Recording Time
32	6 hr 15 min
64	3 hr 00 min
96	2 hr 00 min
128	1 hr 30 min
192	1 hr 00 min
768 (PCM)	15 min

## File Management

### File Format

File format is MS DOS compatible. Still it is required that the card is once formatted in the units.

### File Structure

File structure and naming of the recorded tracks is shown below.

directory	file
\ MZ000001	\ MZ000001.xxx
MZ000002	\ MZ000002.xxx
MZ000003	\ MZ000003.xxx
MZ000nnn	\ MZ000nnn.xxx
nnn:	track number
xxx:	BWF (BWF format was selected at the recording the trac)
	WAV (WAVE format was selected at the recording the trac)
	MP2 (MP2 format was selected at the recording the trac)

### Note

If the files in a card recorded by the unit are deleted or modified by a PC or a system other than the unit, the unit does not work correctly with the card.

---

---

## Troubleshooting

---

---

If your unit fails to operate normally, check the symptoms and solutions described below which you can take to correct the problem. If it cannot be corrected, or the symptom is not listed, contact your authorized MARANTZ dealer or service center for help.

**The unit does not respond to operations.**

- Make sure that you have installed fresh batteries, or that the AC power adaptor is connected correctly.
- Make sure the PC card is fully inserted.
- Turn power OFF, then ON.

**The unit does not work normally.**

- Check all settings.

**Playback is not possible.**

- Check to make sure the PMD680 acknowledges track information on the PC card.

**Recording is not possible.**

- 255 tracks are the maximum number of recorded tracks. Check to make sure that the PMD680 acknowledges the PC card.

**Excessive noise.**

- Check all connected cables for proper connection.

**To clean the cabinet**

Use a soft cloth slightly moistened with mild detergent solution.

**Care of PC cards**

- Please refer to the documentation included with your PC card for proper care.

---

---

**SPECIFICATIONS**

---

---

**Digital audio system****System**

MPEG/Linear PCM Audio

**Usable Media**

PCMCIA ATA flash memory cards

PCMCIA ATA hard disk cards

**Recording and reading method**

MPEG1 Layer II compression &amp; 16 bit linear

**Recording Bit rate**

LP (Long Play mode)

32 Kbps

MP (Medium Play mode)

64 Kbps

SP (Standard Play mode)

96 Kbps

**Record/playback time**

LP (Long Play mode)

14.4MB/hour

MP (Medium Play mode)

28.8MB/hour

SP (Standard Play mode)

43.2MB/hour

PCM (Pulse Code Modulation)

345.6MB/hour

**Sampling frequency**

48 kHz

**Number of channels**

1 (mono)

**Frequency Response**22,000 Hz  $\pm$ 0.5 dB (at digital)**Signal-to-Noise Ratio**

More than 70 dB during playback

**Wow and Flutter**

Below measurable limit

**Inputs****MIC IN 1**

Type: XLR (unbalanced)

Input impedance: 9 k-ohms

Standard input level: -70 dBu

**MIC IN 2**

Type: phone jack

Input impedance: 9 k-ohms

Standard input level: -70 dBu

**LINE IN**

Type: RCA pin jack

Input impedance: 47 k-ohms

Standard input level: -26 dBu

**TELEPHONE IN/OUT**

Type: telephone jack

Input impedance: ?? ohms

Standard input level: ?? Vp-p

Standard output level: ?? Vp-p

**Outputs****LINE OUT**

Type: RCA pin jack

Standard output level: -1.5 dBu

**DIGITAL OUT**

Type: coaxial pin jack

Output impedance: 75 ohms

Standard output level: 0.5 Vp-p

Sampling frequency: 48 kHz

**GENERAL****Speaker output power**

300 mW (at 10% distortion)

**Phones output power**

10 mW (at 8 ohms loaded)

**Power Supplies (via optional AC Adaptor)**

120 V, 60 Hz / 230 V, 50 Hz

**Power Consumption (when using optional AC Adaptor)**

?? W

**Dimensions (W x H x D)**

264 x 52 x 185 mm

**Weight**

?? kg (? lbs. ?? oz.)

**Accessories**

AC adaptor: 1

Battery holder: 1

Carrying Strap: 1

Owner's Manual: 1

Specifications subject to change without notice.

# Index of Parts, Controls, and Display

See the pages in parenthesis for details regarding operation.

## Top Panel

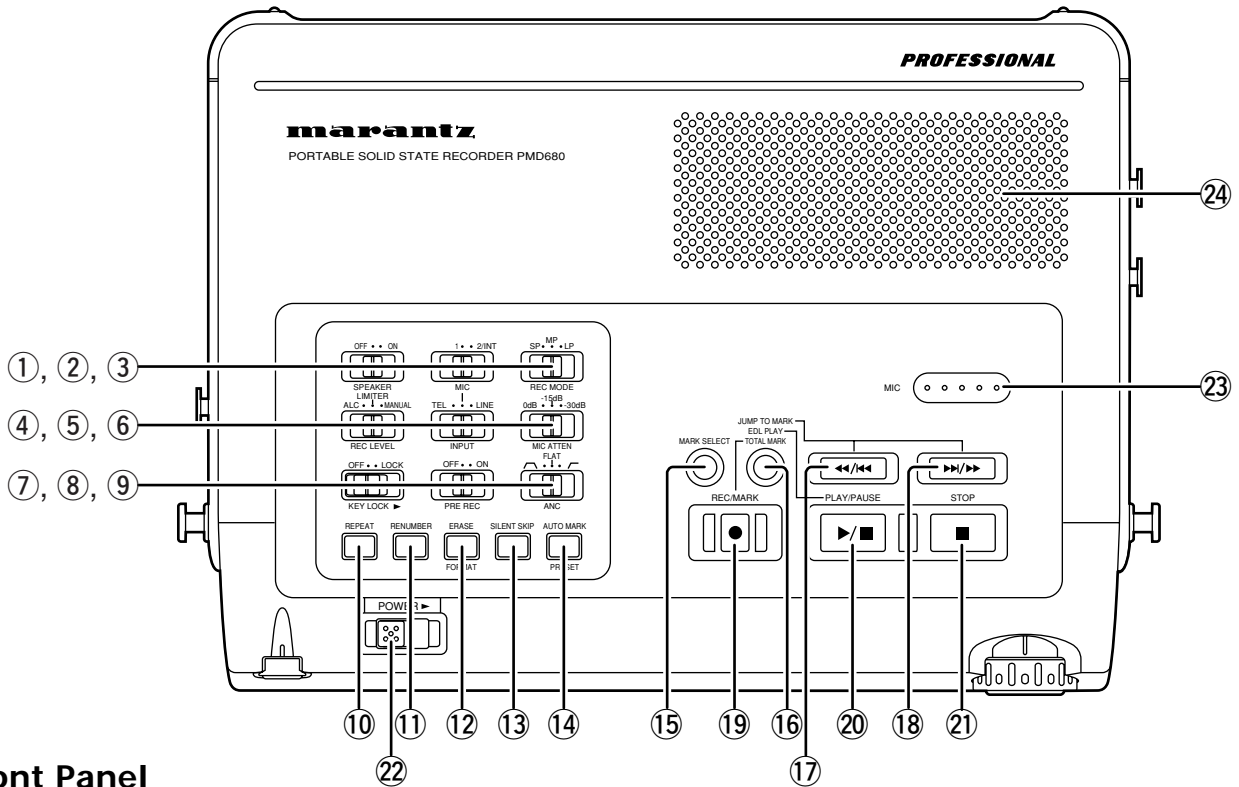

## Front Panel

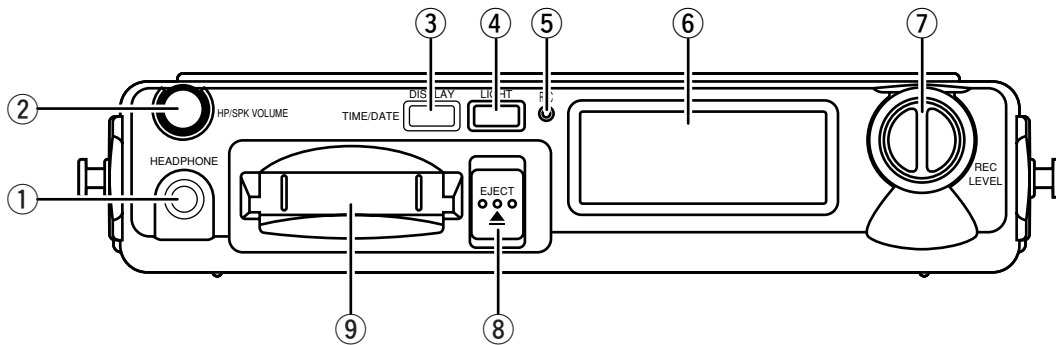

### Top Pannel

- ① SPEAKER switch (page xxx)
- ② MIC switch (page xxx)
- ③ REC MODE switch (page xxx)
- ④ REC LEVEL switch (page xxx)
- ⑤ INPUT switch (page xxx)
- ⑥ MIC ATTENUATION switch (page xxx)
- ⑦ KEY LOCK switch (page xxx)
- ⑧ PRE REC switch (page xxx)
- ⑨ Ambient Noise Control switch (page xxx)
- ⑩ REPEAT key (page xxx)
- ⑪ RENUMBER key (page xxx)
- ⑫ ERASE, FORMAT key (page xxx)
- ⑬ SILENT SKIP key (page xxx)
- ⑭ AUTO MARK, PRESET key (page xxx)
- ⑮ MARK SELECT key (page xxx)
- ⑯ JUMP TO MARK, EDL PLAY, TOTAL MARK key (page xxx)
- ⑰ ◀◀ / |◀◀ key (page xxx)
- ⑱ ▶▶ / ▶▶ key (page xxx)
- ⑲ REC/MARK key (page xxx)
- ⑳ START/PAUSE key (page xxx)
- ㉑ STOP key (page xxx)
- ㉒ POWER key (page xxx)
- ㉓ ECM microphone (page xxx)
- ㉔ SPEAKER (page xxx)

### Front Pannel

- ① HEADPHONE jack (page xxx)
- ② HP/SPK VOLUME knob (page xxx)
- ③ DISPLAY, TIME/DATE key (page xxx)
- ④ LIGHT key (page xxx)
- ⑤ REC LED (page xxx)
- ⑥ Display (page xxx)
- ⑦ REC LEVEL knob (page xxx)
- ⑧ EJECT button (page xxx)
- ⑨ PC card slot (page xxx)



## Left Panel

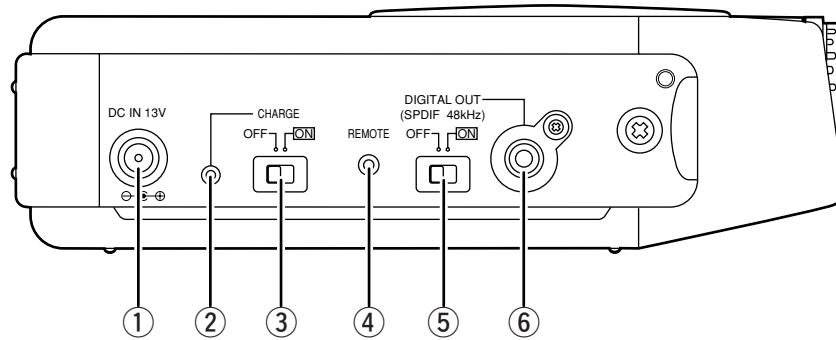

- ① DC IN 13V (page xxx)
- ② Charge LED (page xxx)
- ③ Charge switch (page xxx)
- ④ REMOTE IN jack (page xxx)
- ⑤ DIGITAL OUT switch (page xxx)
- ⑥ DIGITAL OUT jack (page xxx)

## Right Panel

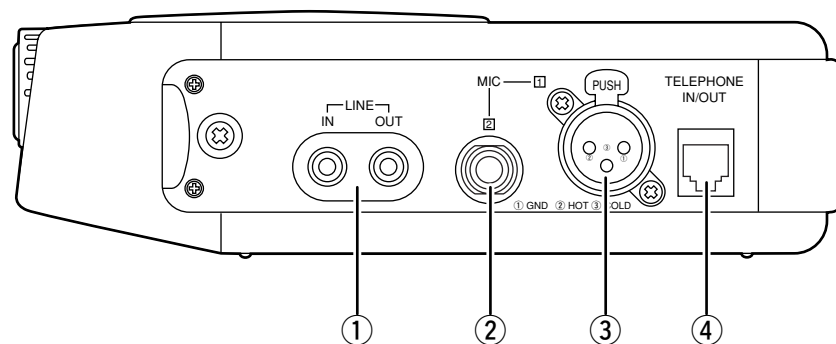

- ① LINE IN/OUT jacks (xx)
- ② MIC 2 IN jack (xx)
- ③ MIC 1 IN jack (xx)
- ④ TELEPHONE IN/OUT jack (xx)

# ADDITIONAL INFORMATION

## Display

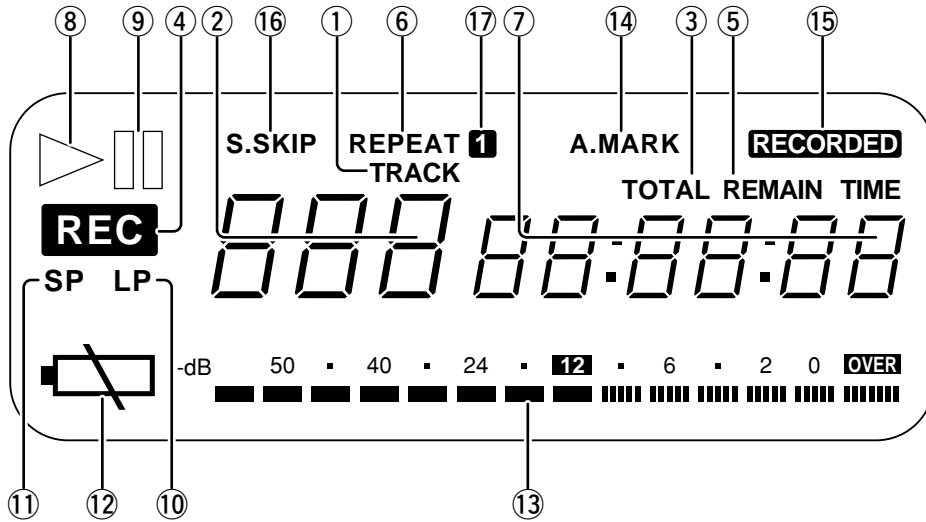

No	Item	Type	Explanation
①	TRACK		Turns on while track number is displayed
②	Track Number	7 Seg x 3 digits	001~255 error message, mode message
③	TOTAL		Turns on while Total Time is displayed
④	<b>REC</b>		Blinks while REC Pause, Steadily on while Recording
⑤	REMAIN		Turns on while Remain Time is displayed
⑥	REPEAT		Turns on while repeat playback and EDL repeat playback
⑦	Time	7Seg x 6 digits	Displays time, displays error message
⑧	PLAY		Blinks while Play Pause and REC Pause, Steadily on while Play and Recording
⑨	PAUSE		Turns on while Play Pause and REC Pause
⑩	LP		Turns on while Long Play mode recording
⑪	SP		Turns on while Short Play mode recording
⑫	Battery Indicator		Turns on when Battery is half consumed, blinks when battery is near end.
⑬	Level Meter	14dots	0dB=2V output
⑭	A.MARK		Turns on while Auto Mark recording mode
⑮	<b>RECORDED</b>		Tunes on while recorded time or date is displayed
⑯	S.SKIP		Turns on while Silent Skip mode recording
⑰	<b>Z</b>		Turns on while single track repeat playback

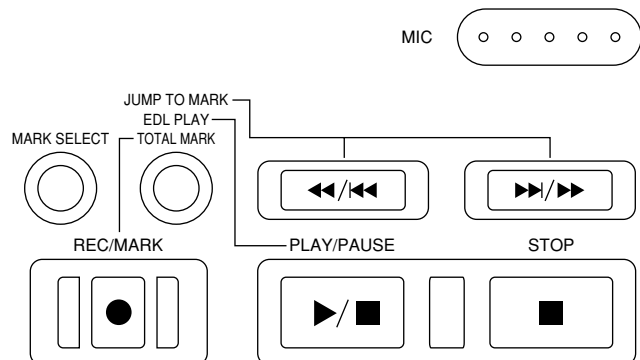
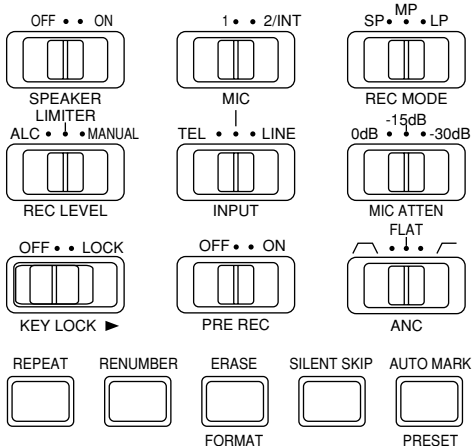

## Free Manuals Download Website

<http://myh66.com>

<http://usermanuals.us>

<http://www.somanuals.com>

<http://www.4manuals.cc>

<http://www.manual-lib.com>

<http://www.404manual.com>

<http://www.luxmanual.com>

<http://aubethermostatmanual.com>

Golf course search by state

<http://golfingnear.com>

Email search by domain

<http://emailbydomain.com>

Auto manuals search

<http://auto.somanuals.com>

TV manuals search

<http://tv.somanuals.com>