

marantz®

Model VP8600 User Guide

DLP™ Projector





 The lightning flash with arrowhead symbol within an equilateral triangle is intended to alert the user to the presence of uninsulated "dangerous voltage" within the product's enclosure that may be of sufficient magnitude to constitute a risk of electric shock to persons.

 The exclamation point within an equilateral triangle is intended to alert the user to the presence of important operating and maintenance (servicing) instructions in the literature accompanying the product.

WARNING

**TO REDUCE THE RISK OF FIRE OR ELECTRIC SHOCK,
DO NOT EXPOSE THIS PRODUCT TO RAIN OR MOISTURE.**

**CAUTION: TO PREVENT ELECTRIC SHOCK, MATCH WIDE BLADE OF
PLUG TO WIDE SLOT, FULLY INSERT.**

**ATTENTION: POUR ÉVITER LES CHOC ÉLECTRIQUES, INTRODUIRE
LA LAME LA PLUS LARGE DE LA FICHE DANS LA BORNE
CORRESPONDANTE DE LA PRISE ET POUSSER JUSQU'AU FOND.**

NOTE:

This equipment has been tested and found to comply with the limits for a Class B digital device, pursuant to Part 15 of the FCC Rules. These limits are designed to provide reasonable protection against harmful interference in a residential installation. This equipment generates, uses and can radiate radio frequency energy and, if not installed and used in accordance with the instructions, may cause harmful interference to radio communications. However, there is no guarantee that interference will not occur in a particular installation. If this equipment does cause harmful interference to radio or television reception, which can be determined by tuning the equipment off and on, the user is encouraged to try to correct the interference by one or more of the following measures:

- Reorient or relocate the receiving antenna.
- Increase the separation between the equipment and receiver.

- Connect the equipment into an outlet on a circuit different from that to which the receiver is connected.

- Consult the dealer or an experienced radio/TV technician for help.

NOTE:

Changes or modifications not expressly approved by the party responsible for compliance could void the user's authority to operate the equipment.

IMPORTANT SAFETY INSTRUCTIONS

READ BEFORE OPERATING EQUIPMENT

This product was designed and manufactured to meet strict quality and safety standards. There are, however, some installation and operation precautions which you should be particularly aware of.

1. Read these instructions.
2. Keep these instructions.
3. Heed all warnings.
4. Follow all instructions.
5. Do not use this apparatus near water.
6. Clean only with dry cloth.
7. Do not block any ventilation openings. Install in accordance with the manufacture's instructions.
8. Do not install near any heat sources such as radiators, heat registers, stoves, or other apparatus (including amplifiers) that produce heat.
9. Do not defeat the safety purpose of the polarized or grounding-type plug. A polarized plug has two blades with one wider than the other. A grounding type plug has two blades and a third grounding prong. The wide blade or the third prong are provided for your safety. If the provided plug does not fit into your outlet, consult an electrician for replacement of the obsolete outlet.
10. Protect the power cord from being walked on or pinched particularly at plugs, convenience receptacles, and the point where they exit from the apparatus.
11. Only use attachments/accessories specified by the manufacturer.
12. Use only with the cart, stand, tripod, bracket, or table specified by the manufacturer, or sold with the apparatus. When a cart is used, use caution when moving the cart/apparatus combination to avoid injury from tip-over.



13. Unplug this apparatus during lightning storms or when unused for long periods of time.
14. Refer all servicing to qualified service personnel. Servicing is required when the apparatus has been damaged in any way, such as power-supply cord or plug is damaged, liquid has been spilled or objects have fallen into the apparatus, the apparatus has been exposed to rain or moisture, does not operate normally, or has been dropped.
15. Remove the lens cap when using this apparatus.

Additional Safety Information!

- This product should not be placed in a built-in installation such as a bookcase or rack unless proper ventilation is provided or the manufacturer's instructions have been adhered to.
- To prevent fire or shock hazard, do not place objects filled with liquids, such as vases, on the apparatus.
- When the switch is in the OFF position, the apparatus isn't completely switched-off from the MAINS.

This Class B digital apparatus complies with Canadian ICES-003.

Cet appareil numérique de la Classe B est conforme à la norme NMB-003 du Canada.

ENGLISH

FOREWORD

This section must be read carefully before any connection is made to the mains supply.

WARRANTY

For warranty information, contact your local Marantz distributor.

RETAIN YOUR PURCHASE RECEIPT

Your purchase receipt is your permanent record of a valuable purchase. It should be kept in a safe place to be referred to as necessary for insurance purposes or when corresponding with Marantz.

IMPORTANT

When seeking warranty service, it is the responsibility of the consumer to establish proof and date of purchase. Your purchase receipt or invoice is adequate for such proof.

FOR U.K. ONLY

This undertaking is in addition to a consumer's statutory rights and does not affect those rights in any way.

EQUIPMENT MAINS WORKING SETTING

Your Marantz product has been prepared to comply with the household power and safety requirements that exist in your area.

COPYRIGHT

Recording and playback of some material may require permission. For further information refer to the following:

- Copyright Act 1956
- Dramatic and Musical Performers Act 1958
- Performers Protection Acts 1963 and 1972
- Any subsequent statutory enactments and orders

WARNINGS

- Do not expose the equipment to rain or moisture.
- Do not remove the cover from the equipment.
- Do not insert anything into the equipment through the ventilation holes.
- Do not handle the mains lead with wet hands.
- Do not cover the ventilation with any items such as tablecloths, newspapers, curtains, etc.
- No naked flame sources, such as lighted candles, should be placed on the equipment.
- When disposing of used batteries, please comply with governmental regulations or environmental public instruction's rules that apply in your country or area.
- Do not place anything about 1 meter above the top panel.
- Make a space of about 0.2 meter around the unit.
- When the projector is mounted on the ceiling, the Ceiling Mount Kit approved by MARANTZ must be used for installation.
- Do not look into the lens when the projector is turned on. It could damage your eyesight.
- Unplug the projector from the wall outlet if it is not to be used for a few days.
- When the switch is in the OFF position, the apparatus is NOT disconnected from the AC supply mains.
- The socket-outlet shall be installed near the equipment and shall be easily accessible.
- No objects filled with liquids, such as vases, shall be placed on the apparatus.

CAUTION

- The chance of the lamp breaking is high after extended use. It is recommended to replace the lamp when near the end of its designed life. Do not use a lamp beyond the maximum lighting time.
- When replacing lamp, call for Marantz authorized dealer. Do not replace the lamp yourself. It is extremely dangerous to replace the lamp.
- If the lamp breaks, leave the area immediately and stay away for at least 30 minutes, and ventilate the room so as not to inhale the mercury vapor.
- If you inhale the mercury vapor, see a physician immediately and follow his instructions.

FRANÇAIS

AVANT-PROPOS

Prière de lire ce chapitre avant de brancher l'appareil sur le secteur.

GARANTIE

Pour des informations sur la garantie, contacter le distributeur local Marantz.

CONSERVER L'ATTESTATION D'ACHAT

L'attestation d'achat est la preuve permanente d'un achat de valeur. La conserver en lieu sûr pour s'y reporter aux fins d'obtention d'une couverture d'assurance ou dans le cadre de correspondances avec Marantz.

IMPORTANT

Pour l'obtention d'un service couvert par la garantie, il incombe au client d'établir la preuve de l'achat et d'en corroborer la date. Le reçu ou la facture constituent des preuves suffisantes.

REGLAGE DE L'ALIMENTATION

SECTEUR DE L'APPAREIL

Cet appareil Marantz a été conçu pour respecter les exigences de votre région en matière d'alimentation secteur et de sécurité.

DRUITS D'AUTEUR

L'enregistrement et la lecture de certaines informations sonores nécessitent une autorisation.

Pour de plus amples renseignements, consultez:

- La loi de 1956 sur les Copyright
- Loi concernant les Acteurs et Musiciens 1958
- Lois de Protection des Artistes 1963 et 1972
- Les décrets et règlements ultérieurs qui s'y rapportent

AVERTISSEMENTS

- Ne pas exposer l'appareil à la pluie ni à l'humidité.
- Ne pas essayer de retirer le boîtier de l'appareil.
- Ne rien insérer dans l'appareil par les orifices de ventilation.
- Ne pas manipuler le cordon d'alimentation avec les mains mouillées.
- Ne pas recouvrir les ouïes de ventilation avec un objet quelconque comme une nappe, un journal, un rideau, etc.
- Ne placer aucune source de flamme nue, comme une bougie allumée, sur l'appareil.
- Pour mettre au rebut les piles usées, respecter les lois gouvernementales ou les règlements officiels concernant l'environnement qui s'appliquent à votre pays ou région.
- Ne placer aucun objet à moins d'un mètre environ du panneau supérieur.
- Veiller à ce qu'aucun objet ne soit à moins de 0,2 mètre des côtés de l'appareil.
- Pour monter le projecteur au plafond, vous devez utiliser un kit de montage au plafond approuvé par MARANTZ pour l'installation.
- Ne regardez pas dans l'objectif quand le projecteur est allumé. Cela pourrait endommager votre vue.
- Débranchez le projecteur de la prise murale s'il ne doit pas être utilisé pendant plusieurs jours.
- Quand l'interrupteur d'alimentation est sur la position OFF, l'appareil N'EST PAS déconnecté de l'alimentation secteur.
- La prise secteur doit être située près de l'appareil et accessible facilement.
- Aucun objet rempli de liquide, un vase par exemple, ne doit être placé sur l'appareil.

ATTENTION

- Le risque que la lampe se casse est élevé après une utilisation prolongée. Il est recommandé de remplacer la lampe lorsqu'elle approche de sa durée de service spécifiée. N'utilisez pas une lampe au-delà du temps d'éclairage maximum.
- Pour faire remplacer la lampe, contacter un revendeur Marantz agréé. Ne pas remplacer la lampe soi-même. Il est extrêmement dangereux de remplacer la lampe.
- Si la lampe se casse, sortez immédiatement de la zone pendant au moins 30 minutes, et aérez la pièce afin de ne pas inhaler la vapeur de mercure.
- Si vous inhalez de la vapeur de mercure, consultez immédiatement un médecin et suivez ses instructions.

PROLOGO

Antes de conectar el equipo a la corriente, debe leer este capítulo.

GARANTIA

Para obtener información acerca de la garantía póngase en contacto con su distribuidor Marantz.

GUARDE SU RECIBO DE COMPRA

Su recibo de compra es su prueba permanente de haber adquirido un aparato de valor. Este recibo deberá guardarlo en un lugar seguro y utilizarlo como referencia cuando tenga que hacer uso del seguro o se ponga en contacto con Marantz.

IMPORTANTE

Cuando solicite el servicio otorgado por la garantía el usuario tiene la responsabilidad de demostrar cuando efectuó la compra. En este caso, su recibo de compra será la prueba apropiada.

SELECCION DEL VOLTAJE DE

ALIMENTACION

Este producto Marantz se ha preparado para estar conforme con los requisitos de alimentación eléctrica doméstica y de seguridad que hay en su zona.

COPYRIGHT

La grabación y reproducción de determinado material puede necesitar permiso. Para más información consulte lo siguiente:

- Acta sobre copyright de 1958
- Acta de la Sociedad General de Autores de 1958
- Acta de Protección de la Propiedad Intelectual de Autores de 1963 y 1972
- Cualquier acta, estatuto y órdenes subsiguientes

ADVERTENCIAS

- No exponga el equipo a la lluvia ni a la humedad.
- No extraiga la tapa del equipo.
- No introduzca nada en el interior del equipo a través de los orificios de ventilación.
- No maneje el cable de alimentación con las manos mojadas.
- No cubra la ventilación con objetos como manteles, periódicos, cortinas, etc.
- No deben colocarse sobre el equipo elementos con fuego, por ejemplo velas encendidas.
- Cuando se eliminen baterías usadas, deben cumplirse las reglamentaciones oficiales o las normas de protección medioambiental aplicables en su país o en su zona.
- No ponga nada a menos de 1 metro por encima del panel superior.
- Deje un espacio de unos 0,2 metro alrededor de la unidad.
- Cuando el proyector se monte en el techo deberá utilizarse para la instalación el juego de montaje en el techo aprobado por MARANTZ.
- No mira al objetivo cuando el proyector esté encendido. Podría lesionarse la vista.
- Desenchufe el proyector de la toma de corriente si no lo va a utilizar durante unos pocos días.
- Cuando el interruptor esté en la posición OFF, el aparato NO estará desconectado de la fuente de alimentación de CA.
- La toma de corriente deberá estar instalada cerca del equipo y deberá poderse acceder a ella fácilmente.
- No se deben colocar sobre el aparato recipientes que contengan líquidos, como por ejemplo jarrones.

PRECAUCIÓN

- La probabilidad de que la lámpara se rompa es alta después de un uso prolongado. Se recomienda recambiar la lámpara cerca de la fecha de expiración de su vida útil prevista. No utilice una lámpara más tiempo del máximo de iluminación previsto.
- Para reemplazar la lámpara, solicite la ayuda de un distribuidor Marantz autorizado. No sustituya la lámpara sin la ayuda de un técnico especializado. La sustitución de la lámpara es una operación extremadamente peligrosa.
- Si la lámpara se rompe, abandone la zona inmediatamente y permanezca alejado durante al menos 30 minutos, ventilando la habitación con objeto de no inhalar el vapor de mercurio.
- Si inhala vapor de mercurio, consulte inmediatamente a su médico y siga sus instrucciones.

TABLE OF CONTENTS

ACCESSORIES	2	OPERATIONS	16
PROJECTOR LAYOUT AND FUNCTIONAL OVERVIEW	3	On-Screen Display Menu Controls	16
Front and Top View.....	3	Menu Structure	17
Rear and Terminals View.....	4	Picture Adjust Menu (PC/HD)	18
Remote Controller	5	Picture Adjust Menu (Video)	18
Remote Controller Operational Range.....	6	Display Menu (PC/HD and Video)	19
Preparing the Remote Controller	6	Fine Menu (PC/HD)	19
CONNECTION	7	Config. Menu (PC/HD and Video).....	20
Connection with AC Power Supply	7	PIP Configuration Menu	20
Connection with Video Equipments	7	Information Menu	20
Connection with a HD-Video, DVD Player, Satellite, Cable Tuner or PC	8	MAINTENANCE.....	21
Advanced Connection	9	Lamp Life and Replace Lamp	21
INITIAL SETTING	10	Replacement Parts	21
Turning on the Power.....	10	Cleaning the Projector	21
Adjust the Zoom, Focus and Keystone	10	TROUBLESHOOTING.....	22
Adjusting the Image	11	Common problems and solutions	22
The Screen Images in a 16:9 screen	12	Tips for Troubleshooting	22
To Turn off the Power	13	LED Error Messages.....	22
The Screen Images in a 4:3 screen	13	Image Problems	22
INSTALLATION	14	Lamp Problems.....	23
Screen Size and Projection Distance (inch) VP8600.....	14	Remote Control Problems.....	23
Screen Size and Projection Distance (mm) VP8600	14	Having the Projector Serviced	23
Lens shift position	15	SPECIFICATIONS	24
		DIMENSIONS	25
		GLOSSARY	25

ACCESSORIES

- LENS CAP

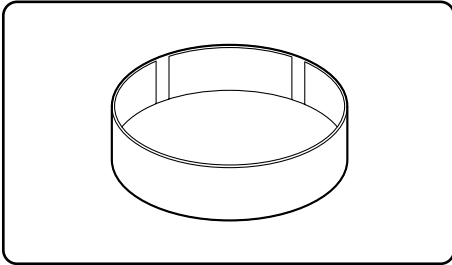

- MAINS CORD

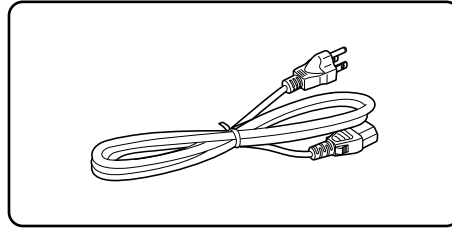

- REMOTE CONTROL

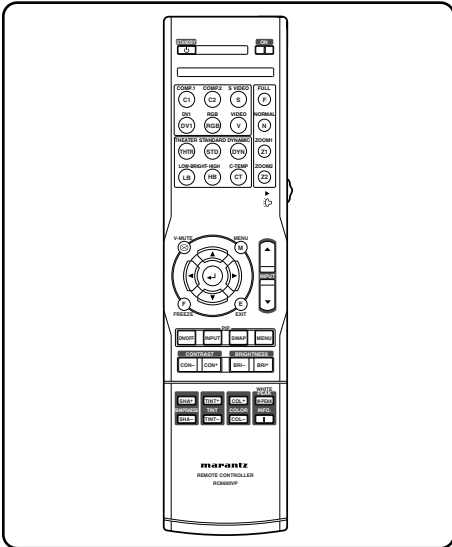

- HDMI-DVI CONNECTOR

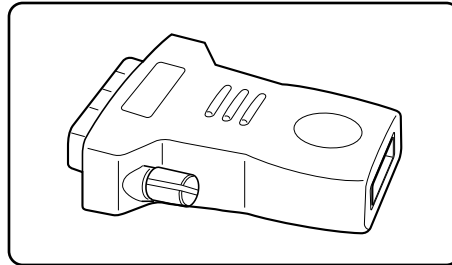

- USERS GUIDE

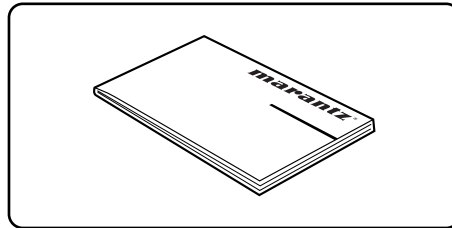

- AAA BATTERIES

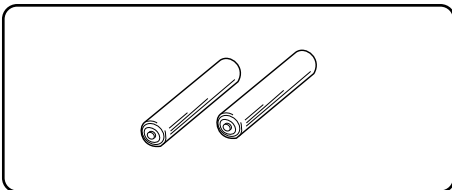

- WARRANTY CARD (USA, CANADA)

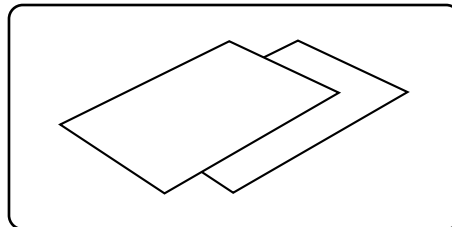

PROJECTOR LAYOUT AND FUNCTIONAL OVERVIEW

Front and Top View

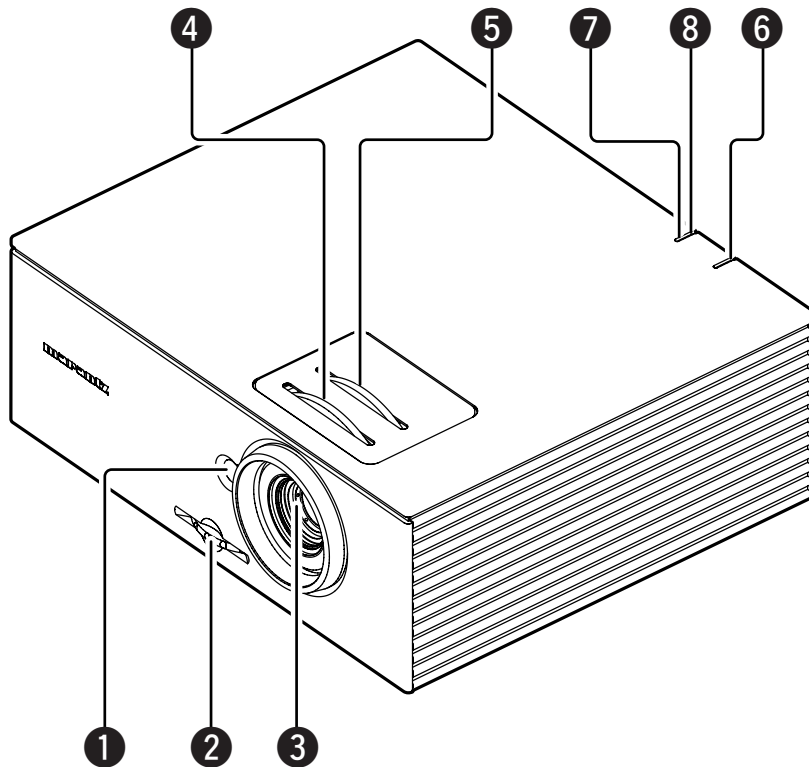

❶ IR receiver

Front receiver for IR signal from remote control.

❷ Vertical lens shift

Adjusts the vertical position of the lens.

❸ Lens

Remove cover before operation.

❹ Focus ring (➡ P.10)

Sharpens the projected image.

❺ Zoom ring (➡ P.10)

Enlarges the projected image.

❻ IR LED

Flashes green when signal from remote control is received.

❼ Lamp LED (Red)

Lighting

Lamp ready.

Blinking which is fast

Lamp not ready—do not press the power button.

❽ Power LED (Blue)

Lighting

Unit is powered on and working correctly.

Blinking which is slow

Unit is powered off.

Blinking which is fast

Operational error code. (➡ P.22)

Important:

Grill openings on the projector allow for good air circulation, which keeps the projector lamp cool. Do not obstruct any of the grill openings.

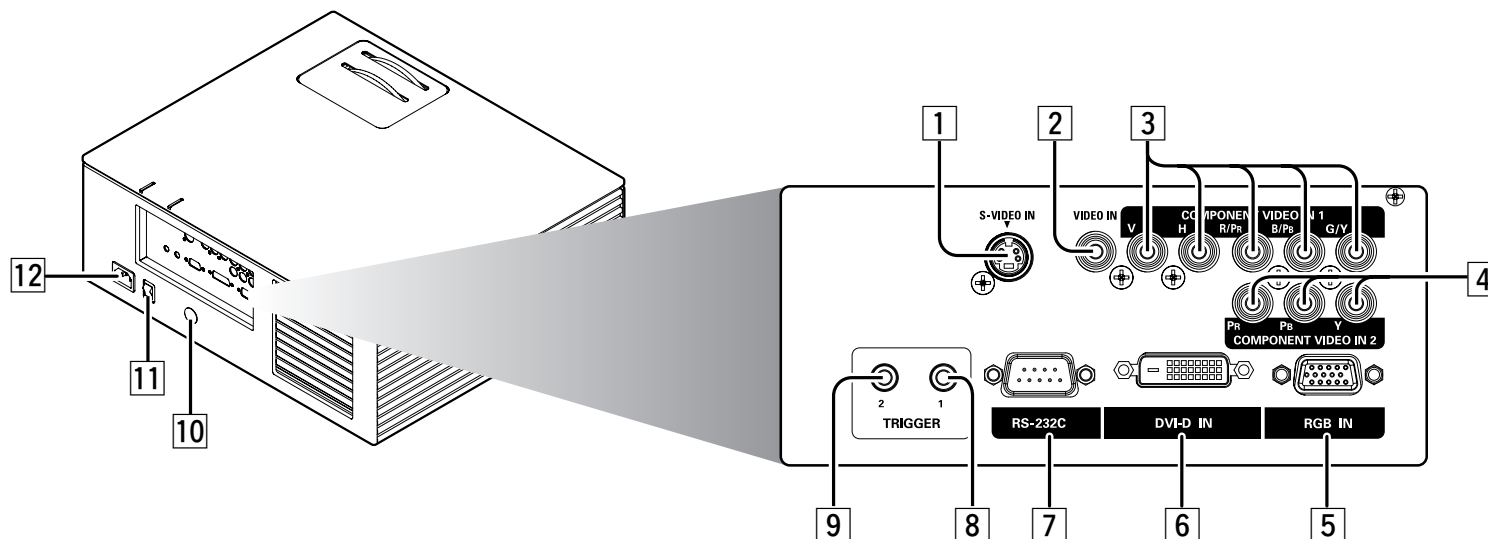

1 S-VIDEO IN

Connect an S-video enabled device.

2 VIDEO IN

Connect a composite video enabled device.

3 COMPONENT VIDEO IN 1

Connect a component video enabled device.

4 COMPONENT VIDEO IN 2

Connect a component video enabled device.

5 RGB IN

Connect to a computer.

6 DVI-D IN

Connect a DVI (digital) cable from a computer or video source.

7 RS-232C

This is a service port for firmware upgrades.

8 TRIGGER 1

Connect to the screen.
When the unit is turned on, 12V is output. When the unit is turned off, no voltage is output. This allows such as a powered up/down screen, whenever the projector is turned on or off.

Note:

To connect with external devices, use an ordinal 3.5mm mini-plug (mono) cable.

9 TRIGGER 2

Connect to the screen to control screen aspect ratio with powered up/down dual aspect ratio screen. If Normal (4:3) aspect ratio is selected by projector, 12V is output.

Notes:

- Do not use TRIGGER 1 and TRIGGER 2, as the power source.
- To connect with external devices, use an ordinal 3.5mm mini-plug (mono) cable.

10 IR receiver

Rear receiver for IR signal from remote control.

11 Main power switch

Turns the main power to the unit on or off.

12 AC IN socket

Connect to an electrical outlet.

Note:

- If your video equipment has both S-video and RCA jacks (composite video) connect to the S-video connector. S-video provides a better quality signal.

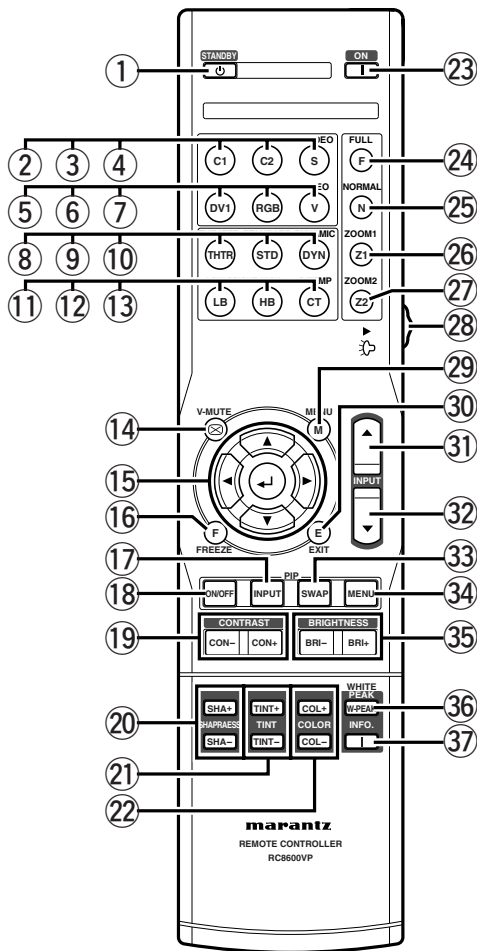

① STANDBY button

Turns the projector off.

② COMP.1 button

Select the devices connected to the COMPONENT VIDEO IN 1 jack as the input source.

③ COMP.2 button

Select the devices connected to the COMPONENT VIDEO IN 2 jack as the input source.

④ S-VIDEO button

Select the S-VIDEO IN signal.

⑤ DVI button

Select the DVI-D IN signal.

⑥ RGB button

Select the RGB IN signal.

⑦ VIDEO button

Select the VIDEO IN signal.

⑧ THEATER button

Select the THEATER (THTR) picture mode.

⑨ STANDARD button

Select the STANDARD (STD) picture mode.

⑩ DYNAMIC button

Select the DYNAMIC (DYN) picture mode.

⑪ LOW BRIGHT button

Select the LOW BRIGHT (LB) picture mode.

⑫ HIGH BRIGHT button

Select the High Bright (HB) picture mode.

⑬ C-TEMP button

Changes color temperature setting.

⑭ V-MUTE button

Makes the screen blank.

⑮ ▲/▼/◀/▶/↔ button

UP (▲) button

Navigates and changes settings in the OSD.

DOWN (▼) button

Navigates and changes settings in the OSD.

LEFT (◀) button

Navigates and changes settings in the OSD.

RIGHT (▶) button

Navigates and changes settings in the OSD.

ENTER (↔) button

Changes settings in the OSD.

⑯ FREEZE button

Freeze/unfreezes the on-screen picture.

⑰ PIP-INPUT button

Changes the PIP source.

⑱ PIP-ON/OFF button

Enables/disables PIP (picture-in-picture).

⑲ CONTRAST+ button, CONTRAST- button

Increases/decreases the contrast of the projected image.

⑳ SHARPNESS+ button, SHARPNESS- button

Increases/decreases the sharpness of the projected image.

㉑ TINT+ button, TINT- button

Increases/decreases the tint of the projected image.

㉒ COLOR+ button, COLOR- button

Increases/decreases the color (saturation) of the projected image.

㉓ ON button

Turns the projector on.

㉔ FULL button

Select FULL (16:9) mode from four aspect ratio modes.

㉕ NORMAL button

Select NORMAL (4:3) mode from four aspect ratio modes.

㉖ ZOOM1 button

Select ZOOM1 (1.88:1) mode from four aspect ratio modes.

㉗ ZOOM2 button

Select ZOOM2 (2.35:1) mode from four aspect ratio modes.

㉘ LIGHT button

Switches on the remote control backlight.

㉙ MENU button

Opens the On-Screen Display (OSD).

㉚ EXIT button

Exits the OSD, or returns to previous menu.

㉛ INPUT UP button

Changes the input signals. COMP.1 → COMP.2 → S-VIDEO → VIDEO → RGB → DVI

㉜ INPUT DOWN button

Changes the input signals. DVI → RGB → VIDEO → S-VIDEO → COMP.2 → COMP.1

㉝ PIP-SWAP button

Swap the window sources in PIP mode.

㉞ PIP-MENU button

Open/close the PIP setting menu.

㉟ BRIGHTNESS+ button, BRIGHTNESS- button

Increases/decreases the brightness of the projected image.

㊱ W-PEAK button

Enables/disables the white peak enhancement.

㊲ INFO. button

Open/close the Information.

Remote Controller Operational Range

The remote control uses infrared transmission to control the projector. It is not necessary to point the remote directly at the projector. Provided you are not holding the remote perpendicular to the sides of the projector, the remote will function well within a radius of about 5 meters and 30 degrees above or below the projector level. If the projector does not respond to the remote control, try bouncing the IR signal off the screen or move a little closer to the projector.

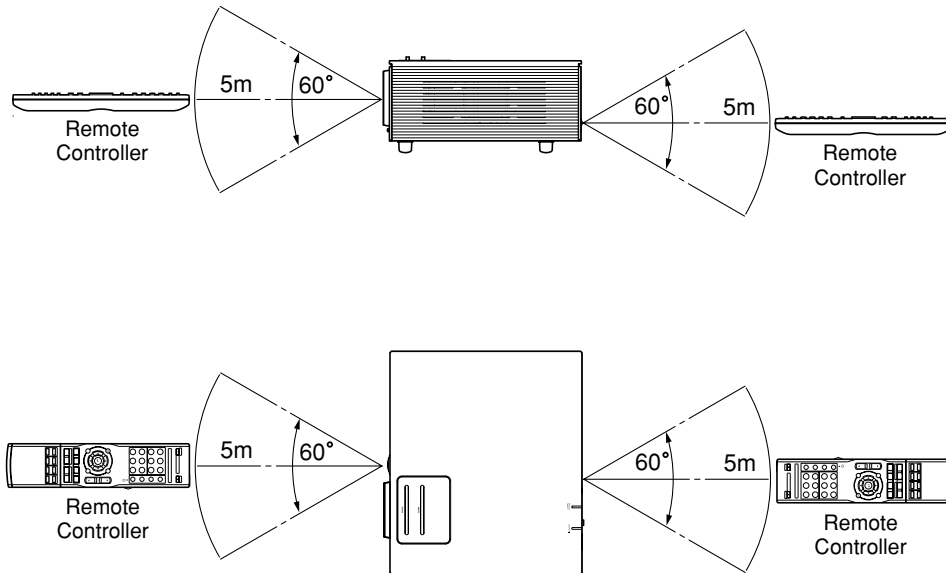

Preparing the Remote Controller

1. Remove the battery compartment cover by pushing down on the latch in the direction of the arrow.

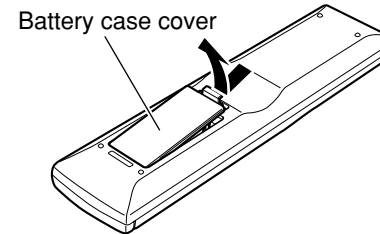

2. Insert the supplied batteries taking note of the polarity (+/-) as shown here.

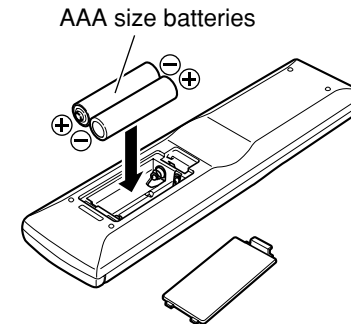

3. Replace the cover at the bottom first, then push the cover until it "clicks" closed.

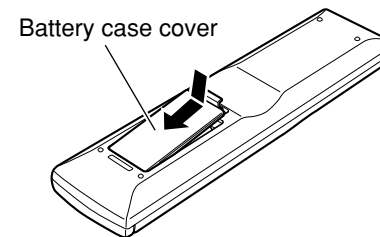

Notes :

- Do not mix alkaline and manganese batteries.
- Do not mix old and new batteries.

CAUTIONS ON BATTERIES

- Use "AAA" type batteries in this remote control unit.
- If the remote control unit does not operate from close to the main unit, replace the batteries with new ones, even if less than a year has passed.
- The included battery is only for verifying operation. Replace it with a new battery as soon as possible.
- When inserting the batteries, be careful to do so in the proper direction, following the + and - marks in the remote control unit's battery case cover.
- To prevent damage or battery fluid leakage:
 - Do not use a new battery with an old one.
 - Do not use two different types of batteries.
 - Do not short-circuit, disassemble, heat or dispose of batteries in flames.
- Remove the batteries when not planning to use the remote control unit for a long period of time.
- If the batteries should leak, carefully wipe off the fluid from the inside of the battery case cover, then insert new batteries.
- When disposing of used batteries, please comply with governmental regulations or environmental public instruction's rules that apply in your country or area.

CONNECTION

❖ When making connections be sure to:

- Turn off all equipment before making any connections.
- Use the proper cables for each connection.
- Securely insert the plug into the port to connect cables. Loose cables can lead to trouble and damage.

❖ When pulling out a cable:

- Be sure to grab the plug, not the cable itself.

Connection with AC Power Supply

Connect the supplied AC power cord into the AC IN socket of the projector.

Note:

Make sure the AC power cord is firmly connected into the AC IN socket.

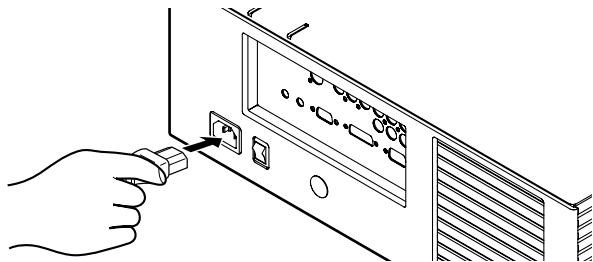

Connection with Video Equipments

You can connect this projector to a VCR, DVD player and other video equipment.

❖ Connecting a video source using S-VIDEO IN and VIDEO IN terminals.

1. Connect one of the S-video cable to the S-VIDEO IN terminal, or one end of the video cable to the VIDEO IN terminal on the projector.
2. Connect the other end of the S-video cable or the video cable to the S-video output terminal or video output terminal of the video source.

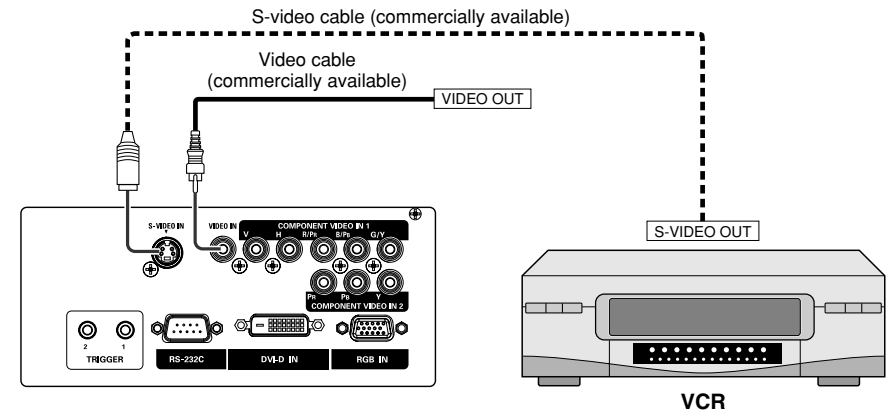

❖ Connecting a DVD player to the COMPONENT VIDEO IN 1 or 2 terminal (Devices can be connected to both terminals at the same time.)

1. Connect the individual terminals of the component video cable into the COMPONENT VIDEO IN 1 or 2 terminal of the projector.
2. Connect the other end of the cable to the corresponding terminals on a DVD player.

COMPONENT 1: YPbPr

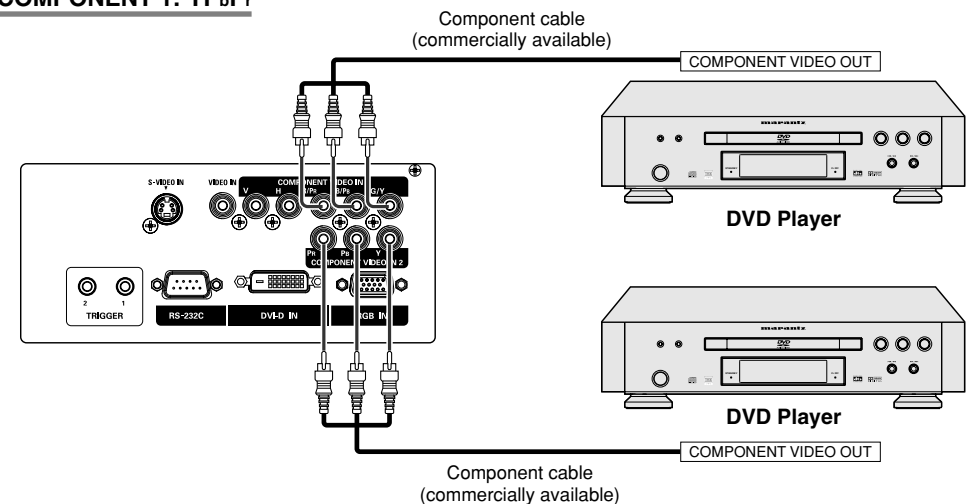

COMPONENT 1: SCART

When connecting the COMPONENT 1 terminal to the SCART (RGB) out terminal, set COMPONENT 1 settings to [SCART]. (P.19)

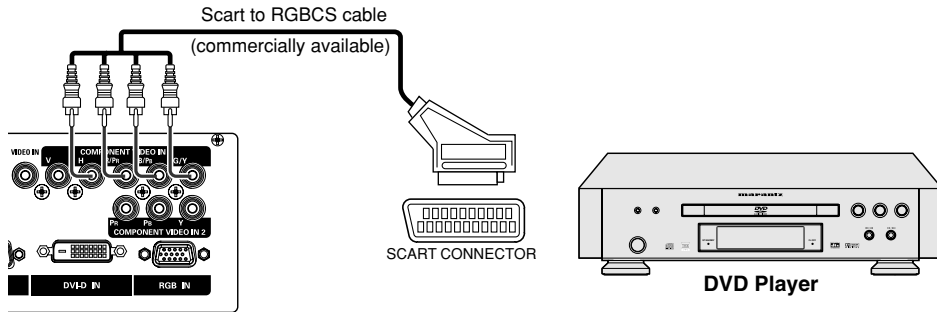

COMPONENT 1: RGB

When connecting the COMPONENT 1 terminal to the RGB HV out terminal, set COMPONENT 1 settings to [RGB]. (P.19)

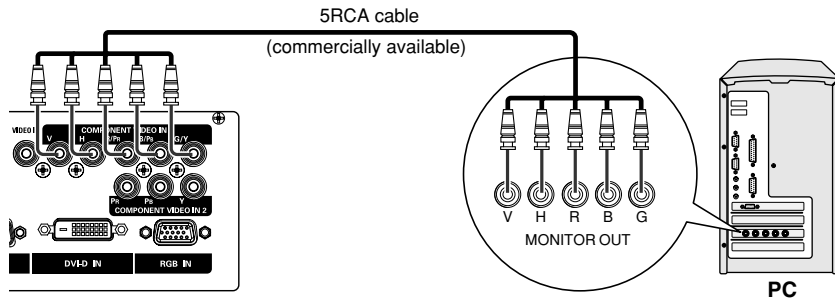

Connection with a HD-Video, DVD Player, Satellite, Cable Tuner or PC

You can connect this projector to HD-Video /PC using RGB IN port, or DVD Player/Satellite /Cable Tuner /PC using DVI-D in port.

1. Connect one end of the RGB cable to the RGB IN port, or one end of the DVI-D cable to the DVI-D IN port on the projector.
2. Connect the other end to the corresponding port on a HD-Video, Satellite, Cable Tuner or personal computer.

Note : When projecting a video image from a device connected to the DVI-D terminal, follow the procedure below.

1. Turn on power of this unit.
2. Set the input video source to DVI-D input.
3. Turn on power of the device connected to the DVI-D terminal of the unit (i.e. DVD player).

If the procedure above is not followed, projected image may corrupt. For the details of the DVI-D terminal on the device connected with the unit, see the instruction manual of the device.

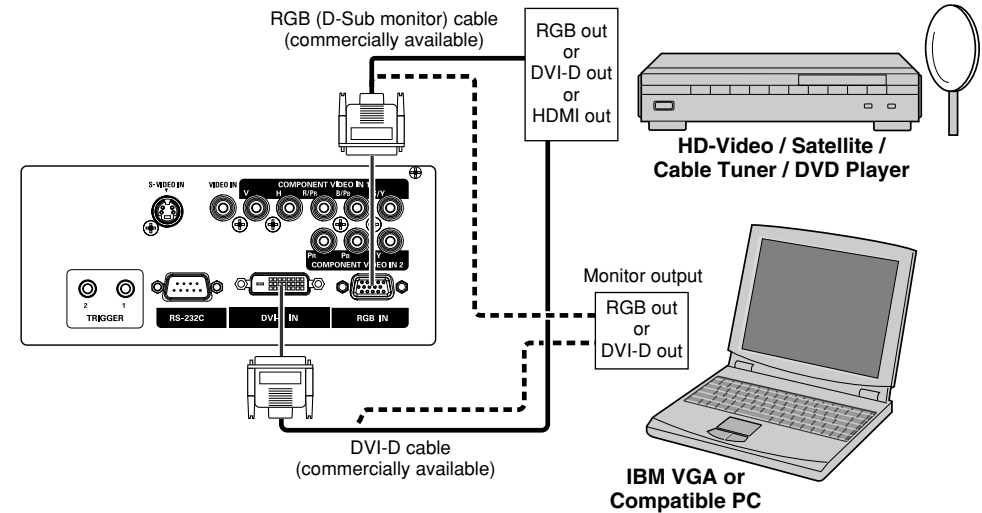

Advanced Connection

You can control total home theater system using PC.
For installing below system, consult with Marantz authorized dealer.

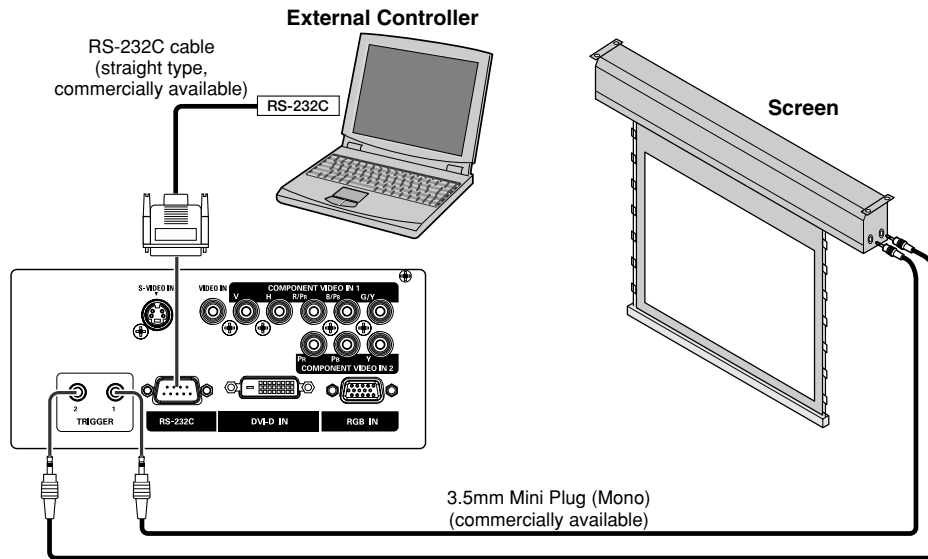

INITIAL SETTING

Turning on the Power

1. Connect the mains cord to the projector. Connect the other end to a wall outlet. Turn on the main power switch. The Power LED blinks (blue) slowly.

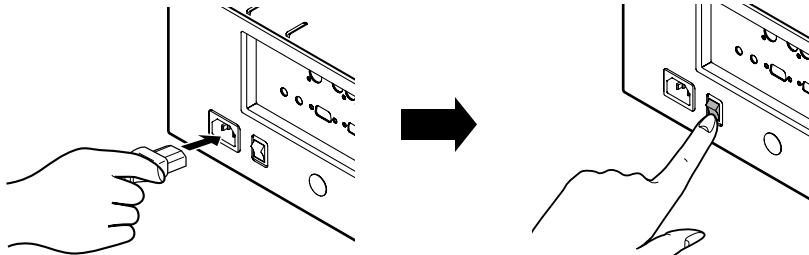

2. Remove the lens cover.
3. Turn on the connected devices.
4. Press the **ON** button on the remote controller to turn on the projector. The Power LED lights blue and the projector splash screen displays.

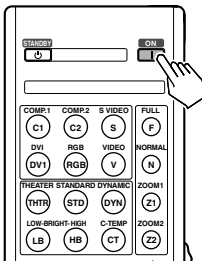

5. Press the **INPUT ▲** or **INPUT ▼** key to select the input signal source.

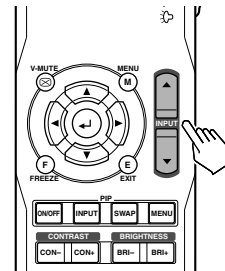

Adjust the Zoom, Focus and Keystone

1. Use the **ZOOM** ring (on the projector) to resize the projected image and screen size.
2. Use the **FOCUS** ring (on the projector) to sharpen the projected image.

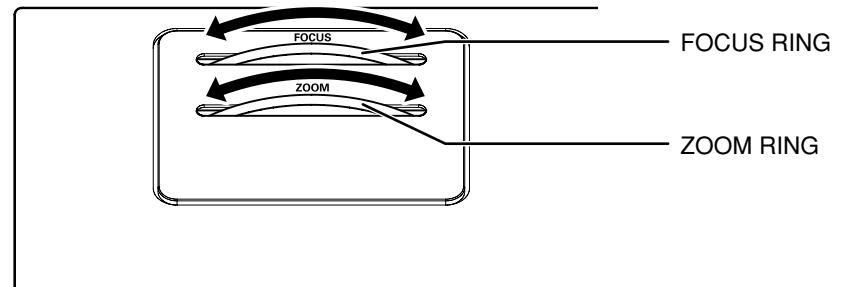

3. Press **MENU** on the remote control to open the OSD.
4. Press **▲▼** to select **Config.** and then press **ENTER**.
5. Press **◀▶** to adjust the horizontal keystone and then press **ENTER**.
6. Press **◀▶** to adjust the vertical keystone and then press **ENTER**.
7. Press the **EXIT** button twice to close the OSD.

Picture	H Keystone	<input type="text" value="20"/>	20
Adjust	V Keystone	<input type="text" value="20"/>	20
Display	Menu Position	1 2 3 4 5 6 7 8 9	
	Menu Timer	Continue	10s 20s
Fine	Language	English	
	Installation	R+Ceiling	
Menu	Auto Input Detection	Enable	Disable
	Auto Power Off	Enable	Disable
Config.	Reset	←	

Exit: EXIT Select: ▲▼ ◀▶ Enter: ↵

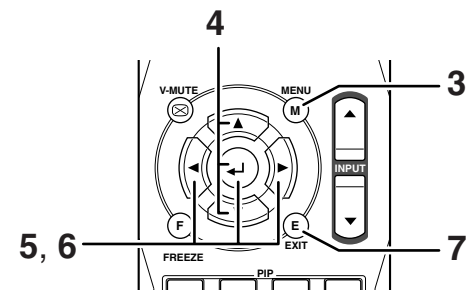

Adjusting the Image

There are hot keys on the remote control that let you adjust contrast, sharpness, tint, color, brightness. When you press one of these hot keys, a slide bar is overlaid on the source image. Use the +/- button to adjust the value. Press the **EXIT** button to close an image slide bar, or press an image hot key to automatically close the current slide bar and open the next.

❖ Contrast Control

Use the contrast control to adjust the contrast between light and dark areas of the projected image.

1. Press the **CON+ / CON-** button.
The contrast slide bar appears.
2. Press the **CON+ / CON-** button to increase/decrease the contrast.
3. Press the **EXIT** button to close the contrast slide bar.

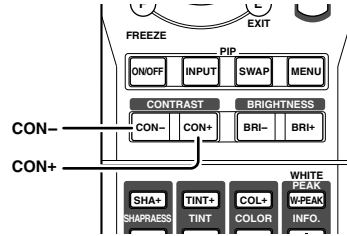

❖ Sharpness Control

Use the sharpness control to adjust the image sharpness. The sharpness control is not available in PC mode.

1. Press the **SHA+ / SHA-** button.
The sharpness slide bar appears.
2. Press the **SHA+ / SHA-** button to increase/decrease the sharpness.
3. Press the **EXIT** button to close the sharpness slide bar.

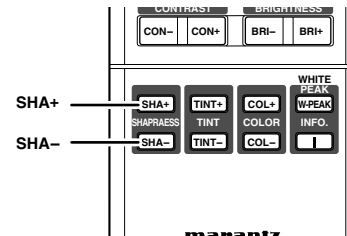

❖ Tint Control

Use the tint control to adjust color hue to obtain true color reproduction. The tint control is not available in PC mode.

1. Press the **TINT+ / TINT-** button.
The tint slide bar appears.
2. Press the **TINT+ / TINT-** button to increase/decrease the tint.
3. Press the **EXIT** button to close the tint slide bar.

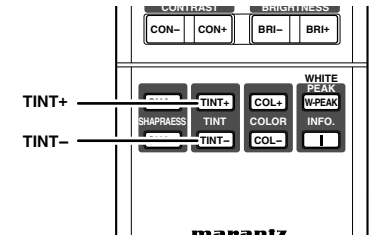

❖ Color Control

Use the color control to adjust the color saturation level. The color control is not available in PC mode.

1. Press the **COL+ / COL-** button.
The color slide bar appears.
2. Press the **COL+ / COL-** button to increase/decrease the color.
3. Press the **EXIT** button to close the color slide bar.

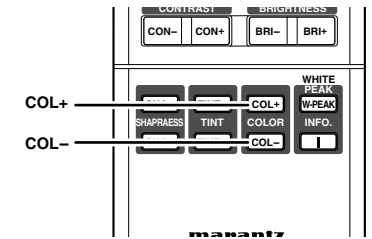

❖ Brightness Control

Use the brightness control to adjust the overall light output.

1. Press the **BRI+ / BRI-** button.
The brightness slide bar appears.
2. Press the **BRI+ / BRI-** button to increase/decrease the brightness.
3. Press the **EXIT** button to close the brightness slide bar.

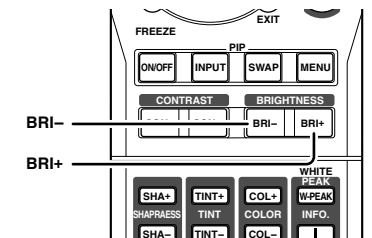

❖ Color Temperature Control

Select the color temperature according to the source. The calibrated **Color temp. 1/Color temp. 2/Color temp. 3/Color temp. 4** setting provides optimum color tracking. The **Color temp. 4** setting provides maximum projector light output.

Everytime the button is pressed, the selection rotates in order of **Color temp. 1 → Color temp. 2 → Color temp. 3 → Color temp. 4**

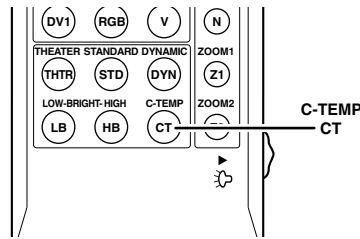

❖ Aspect Control

Use the aspect control to adjust the aspect ratio of the projected image.

An aspect ratio can be directly selected by pressing one of the **FULL**, **NORMAL**, **ZOOM1** and **ZOOM2** buttons on the remote control, or it can be selected from the menu (P.19)

The following settings are supported:

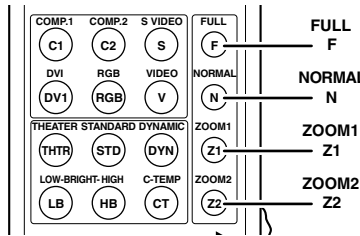

ASPECT RATIO	DESCRIPTION
FULL (16:9)	Wide screen TV format (anamorphic format)
NORMAL (4:3)	Standard TV format
ZOOM1 (1.88:1)	Flat movie format
ZOOM2 (2.35:1)	Panavision or Cinemascope format

The Screen Images in a 16:9 screen

- Press the **NORMAL** button on the remote controller for the 4:3 aspect ratio video source.
- Press the **FULL** button on the remote controller for 16:9 aspect ratio video source, such as 1080i, 1035i, and 720p video systems.
- Press the **FULL**, **ZOOM 1** or **ZOOM 2** button on the remote controller for the squeezed video source.

❖ Original Source Image

16 : 9 video source

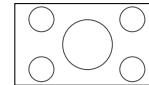

4 : 3 video source

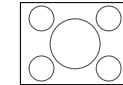

❖ Full mode

The 16:9 squeezed image is displayed with the correct aspect.

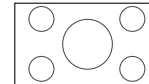

The 4:3 image is enlarged horizontally.

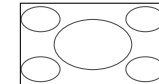

❖ Normal mode

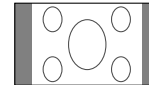

The picture in normal ratio 4:3 is displayed.

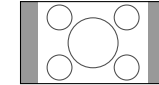

❖ Zoom 1 mode

The 16:9 image is squeezed vertically into 1.88:1 aspect ratio.

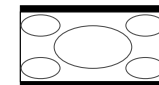
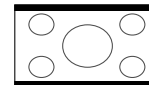

❖ Zoom 2 mode

The 16:9 image is squeezed vertically into 2.35:1 aspect ratio.

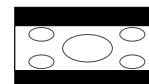

The Screen Images in a 4:3 screen

- Press the **NORMAL** button on the remote controller for the 4:3 aspect ratio video source.
- Press the **FULL** button on the remote controller for 16:9 aspect ratio video source, such as 1080i, 1035i, and 720p video systems.
- Press the **FULL**, **ZOOM 1** or **ZOOM 2** button on the remote controller for the squeezed video source.

❖ Original Source Image

16 : 9 video source

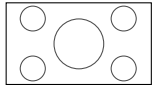

4 : 3 video source

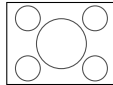

❖ Full mode

The 16:9 squeezed image is displayed with the correct aspect.

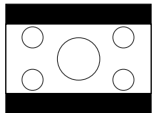

The 4:3 image is enlarged horizontally.

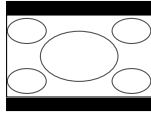

❖ Normal mode

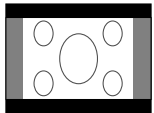

The picture in normal ratio 4:3 is displayed.

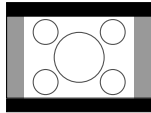

❖ Zoom 1 mode

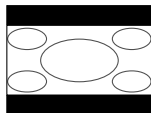
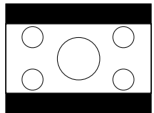

❖ Zoom 2 mode

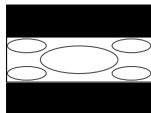
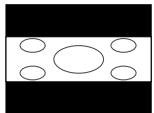

To Turn off the Power

1. Press the **STANDBY** button on the remote controller.
The projector turns off.
2. The fan continues running for about 1 minute to internally cool the projector. In the meantime, the Power LED on the projector flashes a blue color and buttons on the remote control are irresponsive to touch. Once the fan stops, the Power LED blinks (blue) slowly to indicate the projector is on standby.
3. Turn off the main power switch.

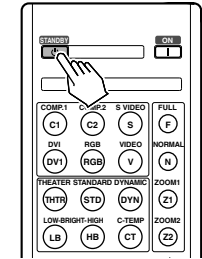
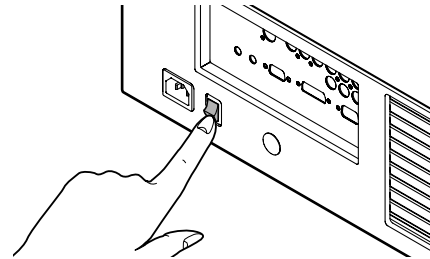

Notes :

- Do not pull out the AC power cord until the projector turns in standby mode.
- Do not pull out the power cord suddenly in the state of "POWER ON." It can cause a breakdown.
- When a error message blinks, turn off the main power switch after checking that the fan has stopped.
- The projector will not be turned on if the **ON** button on the remote controller is pressed immediately after turning off. Press the **ON** button on the remote controller after the projector turns into standby mode.

INSTALLATION

Screen Size and Projection Distance (inch) VP8600

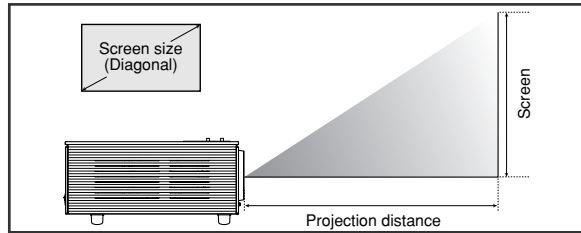

❖ 16 : 9 Screen

In case of displaying the 16:9 picture on the whole of the 16:9 screen.

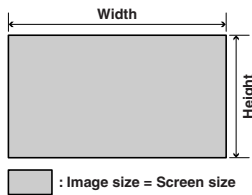

16:9 Screen Size (1.77:1 Aspect Ratio)			Projection Distance	
Diagonal	Width	Height	Minimum	Maximum
inch	inch	inch	inch	inch
60	52.29	29.41	94.13	125.50
70	61.01	34.32	109.82	146.42
72	62.75	35.30	112.95	150.60
80	69.72	39.22	125.50	167.34
82	71.47	40.20	128.64	171.52
84	73.21	41.18	131.78	175.71
90	78.44	44.12	141.19	188.26
92	80.18	45.10	144.33	192.44
100	87.16	49.02	156.88	209.17
106	92.38	51.97	166.29	221.72
110	95.87	53.93	172.57	230.09
120	104.59	58.83	188.26	251.01
123	107.20	60.30	192.96	257.28
133	115.92	65.20	208.65	278.20
135	117.66	66.18	211.79	282.38
150	130.73	73.54	235.32	313.76
170	148.16	83.34	266.70	355.59
200	174.31	98.05	313.76	418.35
250	217.89	122.56	392.20	522.93
300	261.47	147.07	470.64	627.52

❖ 4 : 3 Screen

In case of displaying the 16:9 picture on the whole of the 4:3 screen.

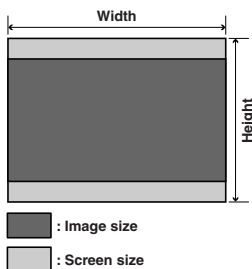

4:3 Screen Size (1.33:1 Aspect Ratio)			Projection Distance	
Diagonal	Width	Height	Minimum	Maximum
inch	inch	inch	inch	inch
60	48.00	36.00	86.40	115.20
70	56.00	42.00	100.80	134.40
72	57.60	43.20	103.68	138.24
80	64.00	48.00	115.20	153.60
82	65.60	49.20	118.08	157.44
84	67.20	50.40	120.96	161.28
90	72.00	54.00	129.60	172.80
92	73.60	55.20	132.48	176.64
100	80.00	60.00	144.00	192.00
106	84.80	63.60	152.64	203.52
110	88.00	66.00	158.40	211.20
120	96.00	72.00	172.80	230.40
123	98.40	73.80	177.12	236.16
133	106.40	79.80	191.52	255.36
135	108.00	81.00	194.40	259.20
150	120.00	90.00	216.00	288.00
170	136.00	102.00	244.80	326.40
200	160.00	120.00	288.00	384.00
250	200.00	150.00	360.00	480.00
300	240.00	180.00	432.00	576.00

Screen Size and Projection Distance (mm) VP8600

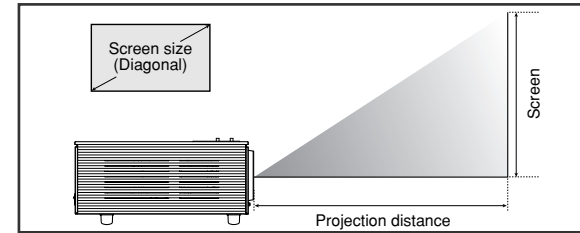

❖ 16 : 9 Screen

In case of displaying the 16:9 picture on the whole of the 16:9 screen.

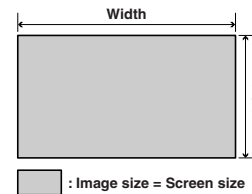

16:9 Screen Size (1.77:1 Aspect Ratio)			Projection Distance	
Diagonal	Width	Height	Minimum	Maximum
inch	mm	mm	mm	mm
60	1328	747	2391	3188
70	1550	872	2789	3719
72	1594	897	2869	3825
80	1771	996	3188	4250
82	1815	1021	3267	4357
84	1860	1046	3347	4463
90	1992	1121	3586	4782
92	2037	1146	3666	4888
100	2214	1245	3985	5313
106	2347	1320	4224	5632
110	2435	1370	4383	5844
120	2656	1494	4782	6376
123	2723	1532	4901	6535
133	2944	1656	5300	7066
135	2989	1681	5379	7173
150	3321	1868	5977	7969
170	3763	2117	6774	9032
200	4427	2490	7969	10626
250	5534	3113	9962	13282
300	6641	3736	11954	15939

❖ 4 : 3 Screen

In case of displaying the 16:9 picture on the whole of the 4:3 screen.

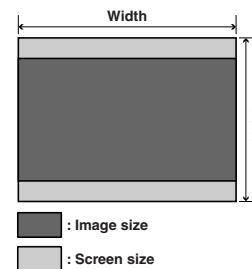

4:3 Screen Size (1.33:1 Aspect Ratio)			Projection Distance	
Diagonal	Width	Height	Minimum	Maximum
inch	mm	mm	mm	mm
60	1219	914	2195	2926
70	1422	1067	2560	3414
72	1463	1097	2633	3511
80	1626	1219	2926	3901
82	1666	1250	2999	3999
84	1707	1280	3072	4097
90	1829	1372	3292	4389
92	1869	1402	3365	4487
100	2032	1524	3658	4877
106	2154	1615	3877	5169
110	2235	1676	4023	5364
120	2438	1829	4389	5852
123	2499	1875	4499	5998
133	2703	2027	4865	6486
135	2743	2057	4938	6584
150	3048	2286	5486	7315
170	3454	2591	6218	8291
200	4064	3048	7315	9754
250	5080	3810	9144	12192
300	6096	4572	10973	14630

Lens shift position

❖ Standard condition (From +50% to +120%)

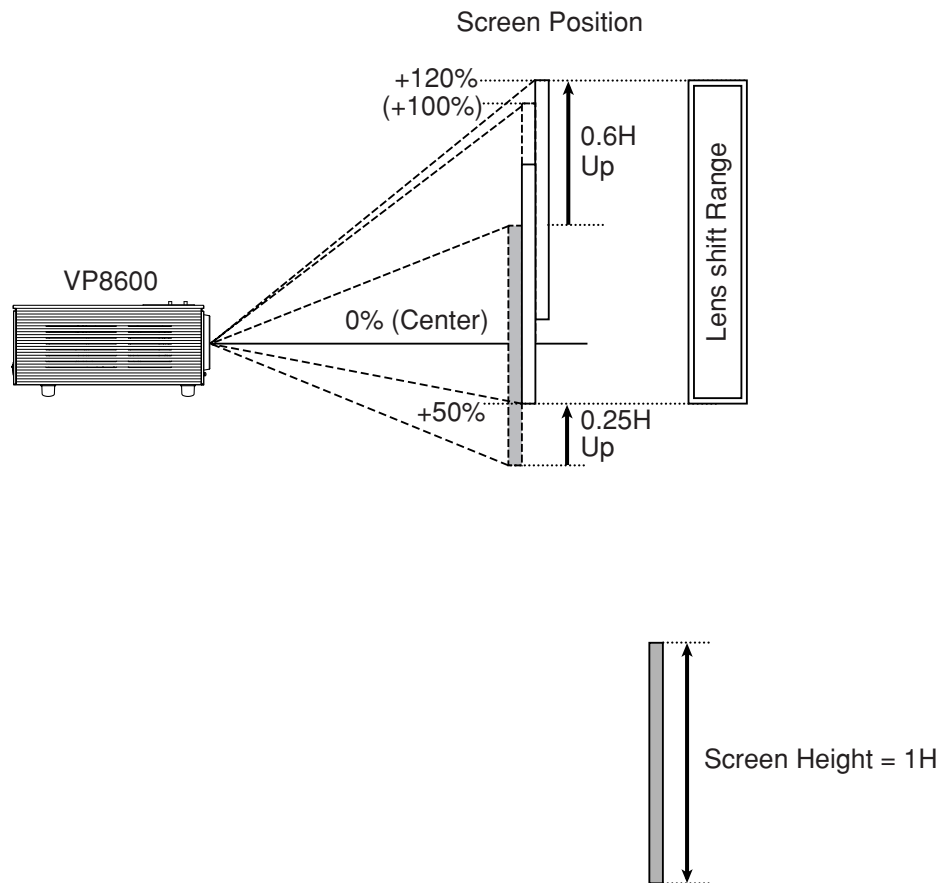

OPERATIONS

On-Screen Display Menu Controls

The projector has an On-Screen Display (OSD) that lets you make picture adjustment and change various settings.

❖ Navigating the OSD

Press **MENU** to open the OSD, and then use the arrow buttons (up/down ▲▼, left/right ◀▶) to navigate and make changes. Press **ENTER** to enter menus and confirm settings. Press the **EXIT** button to exit menus. Press **MENU** to close the OSD.

The example below demonstrates how to change the **Brightness** setting in the **Picture Adjust** menu, and then navigate to the **Horizontal Size** setting in the **Display** menu.

1. Press **MENU**. The **Picture Adjust** menu (or last open menu) appears.
2. Press **ENTER** to select **Brightness**.
3. Press ◀▶ to adjust the brightness.
4. Press **EXIT** to leave the **Picture Adjust** menu.



5. Press ▲▼ until **Display** is highlighted and press **ENTER**. The **Display** menu opens; the **Horizontal Size** setting is selected.
6. Press ◀▶ to adjust the horizontal setting.
7. Press **MENU** to close the OSD.

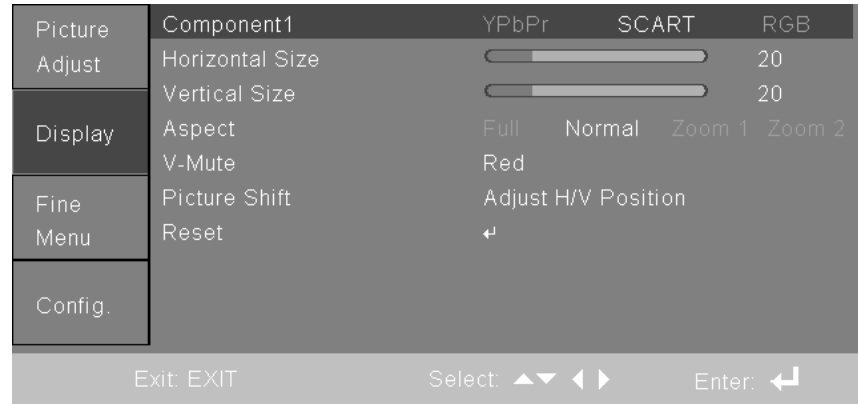
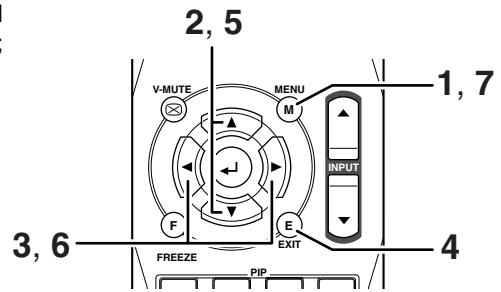

❖ Setting the OSD Language

You may want to reference the OSD on your projector while reading this section. Set the OSD language to your preference before continuing. (Available languages are English, Francais, Italiano, Deutsch, and Español. The default language is English.)

1. Press **MENU**. The **Picture Adjust** menu (or the last open menu) appears.
2. Press ▲▼ until **Config.** is highlighted and then press **ENTER**.

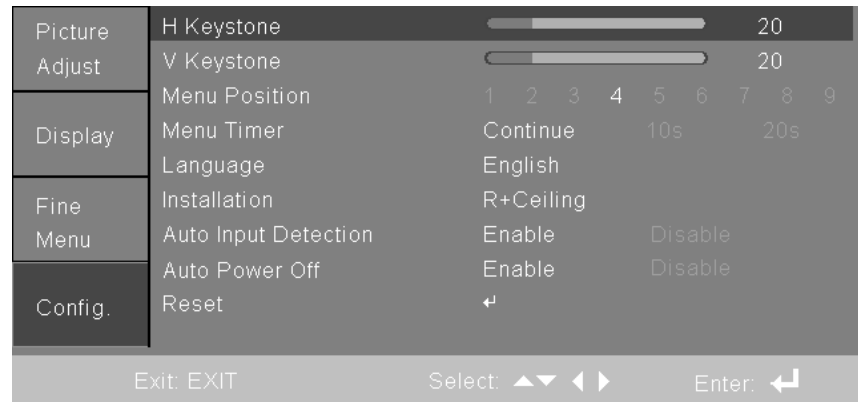

3. Press ▲▼ until **Language** is highlighted.
4. Press ◀▶ to select the language you want.
5. Press **ENTER** to confirm.

Menu Structure

Main Menu

Picture Adjust

P.18

Item	Value
Brightness	-63 ↔ 64
Contrast	-63 ↔ 64
Color	-63 ↔ 64
Tint	-63 ↔ 64
Sharpness*1	0 ↔ 12
Gamma	LB / THTR / STD / DYN / HB
Color Temp.	1 / 2 / 3 / 4
W-PEAK	ON / OFF
Readjust*2	
Reset	

Display

P.19

Component 1	YPbPr / SCART / RGB
Horizontal Size	-128 ↔ 127
Vertical Size	-128 ↔ 127
Aspect	Full / Normal / Zoom1 / Zoom2
V-Mute	<ul style="list-style-type: none"> Red Green Blue Black White
Picture Shift	
Reset	

*1 0↔4 for PC/HD

*2 PC/HD only

Main Menu

Fine menu

P.19

R.Gain	-128 ↔ 127
B.Gain	-128 ↔ 127
R.Bias	-128 ↔ 127
B.Bias	-128 ↔ 127
Reset	

Config.

P.20

H Keystone	-36 ↔ 36
V Keystone	-36 ↔ 36
Menu Position	1 / 2 / 3 / 4 / 5 / 6 / 7 / 8 / 9
Menu Timer	Continue / 10s / 20s
Language	<ul style="list-style-type: none"> English Français Italiano Deutsch Español
Installation	<ul style="list-style-type: none"> Front F+Ceiling Rear R+Ceiling
Auto Input Detection	Enable / Disable
Auto Power Off	Enable / Disable
Reset	

Picture Adjust Menu (PC/HD)

Press **MENU** to open the OSD. If necessary, press **▲▼** to move to the **Picture Adjust** menu and press **ENTER**. Press **▲▼** to move up and down in the **Picture Adjust** menu. Press **◀▶** to adjust values and press **ENTER** to confirm the setting.

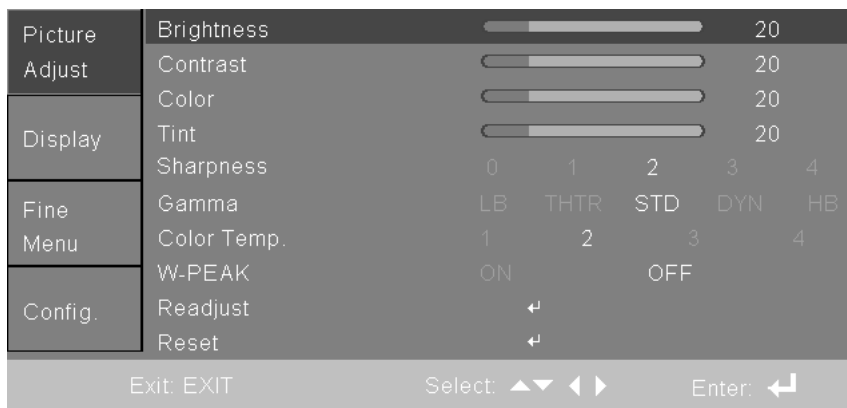

ITEM	DESCRIPTION	DEFAULT
Brightness	Press ◀▶ to adjust the brightness. (Range: -63 to 64)	*1
Contrast	Press ◀▶ to adjust the contrast. (Range: -63 to 64)	*1
Color	Press ◀▶ to adjust the color. (Range: -63 to 64)	*1
Tint	Press ◀▶ to adjust the color. (Range: -63 to 64)	*1
Sharpness	Press ◀▶ to adjust the sharpness. (Range: 0 to 4)	2
Gamma	Press ◀▶ to adjust the gamma correction of the display. (Range: LB; THTR; STD; DYN; HB)	STD
Color Temp.	Press ◀▶ to adjust the color temperature. (Range: 1 Warm; 2 Normal; 3 Cool; 4 White)	*1
W-PEAK	Press ◀▶ to select the white peak enhancement ON or OFF.	OFF
Readjust	Press ENTER to auto adjust the image for the current source.	—
Reset	Resets all items in the Picture Adjust menu to the default values.	—

*1 The default value depends on input signal.

Picture Adjust Menu (Video)

Press **MENU** to open the OSD. If necessary, press **▲▼** to move to the **Picture Adjust** menu and press **ENTER**. Press **▲▼** to move up and down in the **Picture Adjust** menu. Press **◀▶** to adjust values and press **ENTER** to confirm the setting.

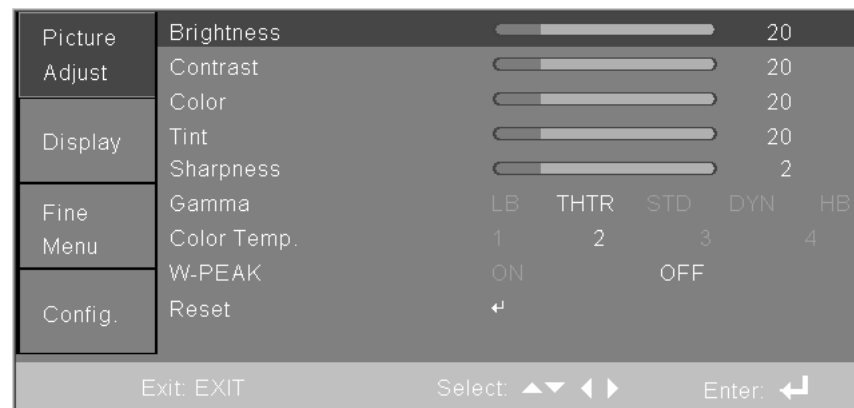

ITEM	DESCRIPTION	DEFAULT
Brightness	Press ◀▶ to adjust the brightness. (Range: -63 to 64)	*1
Contrast	Press ◀▶ to adjust the contrast. (Range: -63 to 64)	*1
Color	Press ◀▶ to adjust the color. (Range: -63 to 64)	*1
Tint	Press ◀▶ to adjust the video tint/hue. (Range: -63 to 64)	*1
Sharpness	Press ◀▶ to adjust the sharpness. (Range: 0 to 12)	6
Gamma	Press ◀▶ to adjust the gamma correction of the display. (Range: LB; THTR; STD; DYN; HB)	STD
Color Temp.	Press ◀▶ to adjust the color temperature. (Range: 1 Warm; 2 Normal; 3 Cool; 4 White)	*1
W-PEAK	Press ◀▶ to select the white peak enhancement ON or OFF	OFF
Reset	Resets all items in the Picture Adjust menu to the default values.	—

*1 The default value depends on input signal.

Display Menu (PC/HD and Video)

Press **MENU** to open the OSD menu. Press **▲▼** to move to the **Display** menu and press **ENTER**. Press **▲▼** to move up and down in the **Display** menu. Press **◀▶** to adjust values and press **ENTER** to confirm the setting.

Picture	Component1	YPbPr	SCART	RGB
Adjust	Horizontal Size			20
	Vertical Size			20
Display	Aspect	Full	Normal	Zoom 1 Zoom 2
	V-Mute	Red		
Fine Menu	Picture Shift	Adjust H/V Position		
	Reset	←		
Config.				

Exit: EXIT Select: ▲▼ ◀▶ Enter: ↵

ITEM	DESCRIPTION	DEFAULT
Component 1	Press ◀▶ to change the source for component 1. Range: (P.7, 8) 1. YP _b P _r – YP _b P _r – sync on green 2. SCART 3. RGB – RGBHV (5-cable)	YP _b P _r
Horizontal size	Press ◀▶ to adjust the screen size horizontally. (Range: –128 to 127)	0
Vertical size	Press ◀▶ to adjust the screen size vertically. (Range: –128 to 127)	0
Aspect	Press ◀▶ to adjust the video aspect ratio. (Range: Full (16:9) – Normal (4:3) – Zoom 1 (1.88:1) – Zoom2 (2.35:1))	Full
V-Mute	Press ◀▶ to select a background color for blank screen (Range: Red – Green – Blue – Black – White)	Black
Picture Shift	Select this item and press ENTER . Then use the arrow buttons to shift the onscreen image.	—
Reset	Resets all items in the Display menu to the default values.	—

Fine Menu (PC/HD)

Press **MENU** to open the OSD menu. Press **▲▼** to move to the **Fine** menu and press **ENTER**. Press **▲▼** to move up and down in the **Fine** menu. Press **◀▶** to adjust values and press **ENTER** to confirm the setting.

Picture	R.Gain		20
Adjust	B.Gain		20
	R.Bias		20
Display	B.Bias		20
	Reset	←	
Fine Menu			
Config.			

Exit: EXIT Select: ▲▼ ◀▶ Enter: ↵

ITEM	DESCRIPTION	DEFAULT
R.Gain	Press ◀▶ to adjust the white color temperature on red. (Range: –128 to 127)	0
B.Gain	Press ◀▶ to adjust the white color temperature on blue. (Range: –128 to 127)	0
R.Bias	Press ◀▶ to adjust the black color temperature on red. (Range: –128 to 127)	0
B.Bias	Press ◀▶ to adjust the black color temperature on blue. (Range: –128 to 127)	0
Reset	Resets all items in the Fine menu to the default values.	—

Config. Menu (PC/HD and Video)

Press **MENU** to open the OSD menu. Press **▲▼** to move to the **Config.** menu and press **ENTER**. Press **▲▼** to move up and down in the **Config.** menu. Press **◀▶** to adjust values and press **ENTER** to confirm the setting.

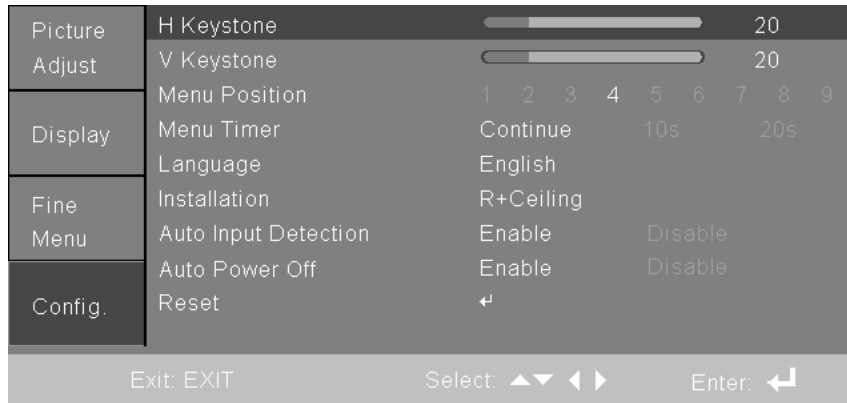

ITEM	DESCRIPTION	DEFAULT	
H Keystone	Press ◀▶ to adjust the horizontal keystone. (Range: -36 to 36)	0	
V Keystone	Press ◀▶ to adjust the vertical keystone. (Range: -36 to 36)	0	
Menu Position	Press ◀▶ to select the menu screen position. (Range: 1 (upper left) — 9 (bottom right))	4	
Menu Timer	Press ◀▶ to select how long the menu is displayed. (Range: Continue (OSD appears until manually closed) — 10 Sec. — 20 Sec.)	Continue	
Language	Press ◀▶ to change the language. (Range: English; Français; Italiano; Deutsch; Español)	English	
Installation	Press ◀▶ to choose from four projection methods:	Front	
	Front		Desktop mount, front of screen
	F+Ceiling		Ceiling mount, front of screen
	Rear		Desktop mount, rear of screen
	R+Ceiling	Ceiling mount, rear of screen	
Auto Input Detection	Press ◀▶ to enable/disable Auto Input Detection. Note: When this setting is disabled, you need to select the source manually.	Disable	
Auto Power Off	When the Auto Power off is set to Enable , power to the projector automatically shuts off if no signals are received and no operations are performed for about 10 consecutive minutes.	Disable	
Reset	Resets all items in the config. menu to the default values.	—	

PIP Configuration Menu

Press **P-MENU** in PIP mode to open **PIP Configuration** menu. Press **▲▼** to move up and down in the **PIP Configuration** menu.

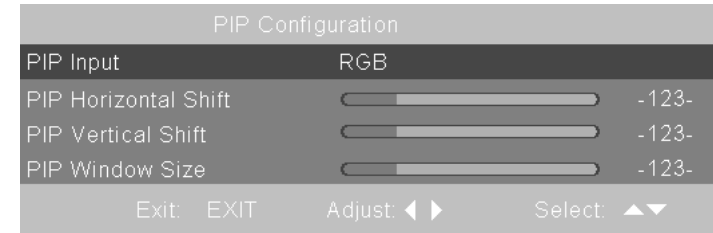

ITEM	DESCRIPTION	DEFAULT
PIP input	Press ◀▶ to select the PIP input.	*1
PIP Horizontal Shift	Press ◀▶ to adjust the horizontal position of the PIP window. (Range:-128 to 127)	-128
PIP Vertical Shift	Press ◀▶ to adjust the vertical position of the PIP window. (Range:-128 to 127)	-128
PIP Window Size	Press ◀▶ to adjust the size of the PIP window. (Range:-128 to 127)	*1

*1 The default value depends on input signal.

Information:

PIP operations may not function depending on the combination of input signals. See the table below for details.

O: support X: Not support

PIP Source	Main Input Source								
	COMP.1	COMP.2	S-VIDEO	VIDEO	RGB	DVI	Yp/P.	SCART	RGB
COMP.1	X	X	X	X	O	O	X	X	X
SCART	X	X	X	X	O	O	X	X	X
RGB	X	X	X	X	O	O	X	X	X
COMP.2	X	X	X	X	O	O	X	X	X
S-VIDEO	X	X	X	X	O	O	X	X	X
VIDEO	X	X	X	X	O	O	X	X	X
RGB	O	O	O	O	X	X	O	O	X
DVI	O	O	O	O	X	X	O	O	X

Information Menu

Press **Info.** to open **Information** menu. The **Information** menu items are displayed only.

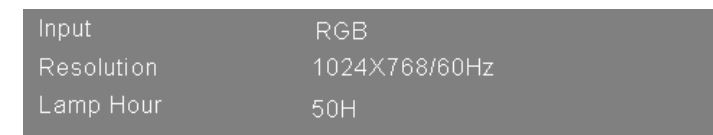

ITEM	DESCRIPTION	DEFAULT
Input	Displays the select input source.	These items are display only.
Resolution	Displays the resolution and H/V in PC mode. Displays the color standard of the connected video device.	
Lamp Hour	Number of hours lamp has been in use.	

MAINTENANCE

Lamp Life and Replace Lamp

❖ Lamp Hour

Display the lamp life by pressing the **INFO.** button on the remote controller.

Input	RGB
Resolution	1024X768/60Hz
Lamp Hour	50H

Notes:

- The maximum life limit of the lamp is 4,000 hours. Although we care very much about quality, the lamp can rarely breaks down if running time exceeds 3,000 hours. Therefore we recommend to replace the lamp if Lamp Hour gets over 3,000 hours. The lamp needs to be replaced with-in the maximum life limit.
- This product is checked under strict quality control when it is shipped out form factory. “Lamp Hour” in the menu includes the time for this check. So “Lamp Hour” may not be 0 hours when it is used first time.

- When the lamp hour exceeds 3900 hours and the unit is still on, the Warning is displayed on the screen automatically.

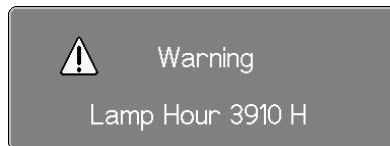

To clear the warning, press the **EXIT** button.

When this warning is displayed, contact your nearest Marantz authorized dealer or Service center for a replacement.

Do not replace the lamp yourself.

Replacement Parts

When replacement parts are required, be sure to inform a Marantz authorized service center. Use only replacement parts specified by Marantz. Unauthorized substitutions may result in fire, electric shock, or other hazards. And, the warranty may not be guaranteed.

Cleaning the Projector

Cleaning the projector to remove dust and grime will help ensure trouble-free operation.

Warning:

1. Be sure to turn off and unplug the projector at least an hour before cleaning. Failure to do so could result in a severe burn.
2. Use only a dampened cloth when cleaning. Do not allow water to enter the ventilation openings on the projector.
3. If a little water gets into the projector interior while cleaning, leave unplugged in a well-ventilated room for several hours before using.
4. If a lot of water gets into the projector interior when cleaning, have the projector serviced.

❖ Cleaning the Lens

You can purchase optic lens cleaner from most camera stores. Refer to the following to clean the projector lens.

1. Apply a little optic lens cleaner to a clean soft cloth. (Do not apply the cleaner directly to the lens.)
2. Lightly wipe the lens in a circular motion.

Caution:

1. Do not use abrasive cleaners or solvents.
2. To prevent discoloration or fading, avoid getting cleaner on the projector case.

❖ Cleaning the Case

Refer to the following to clean the projector case.

1. Wipe off dust with a clean dampened cloth.
2. Moisten the cloth with warm water and mild detergent (such as used to wash dishes), and wipe the case.
3. Rinse all detergent from the cloth and wipe the projector again.

Caution:

To prevent discoloration or fading of the case, do not use abrasive alcohol-based cleaners.

TROUBLESHOOTING

Common problems and solutions

These guidelines provide tips to deal with problems you may encounter while using the projector. If the problem remains unsolved, contact your dealer for assistance.

Often after time spent troubleshooting, the problem is traced to something as simple as a loose con-nection. Check the following before proceeding to the problem-specific solutions.

- Use some other electrical device to confirm that the electrical outlet is working.
- Ensure the projector is turned on.
- Ensure all connections are securely attached.
- Ensure the attached device is turned on.
- Ensure a connected PC is not in suspend mode.
- Ensure a connected notebook computer is configured for an external display. (This is usually done by pressing an Fn-key combination on the notebook.)

Tips for Troubleshooting

In each problem-specific section, try the steps in the order suggested. This may help you to solve the problem more quickly.

Try to pin point the problem and thus avoid replacing non-defective parts.

For example, if you replace batteries and the problem remains, put the original batteries back and go to the next step.

Keep a record of the steps you take when troubleshooting: The information may be useful when call-ing for technical support or for passing on to service personnel.

LED Error Messages

Number of times LED flashes		Condition	DEFAULT
Power (blue)	Lamp (red)		
3	1	System overheating 1	Allow the projector to cool.
3	3	System overheating 1	
5	1	Lamp error 1	Call the service center.
5	2	Lamp error 2	
5	3	Lamp error 3	
6	1	Fan error 1	Have the projector serviced. (See "Having the Projector Serviced on page 23.")
6	2	Fan error 2	
6	3	Fan error 3	
6	4	Fan error 4	
6	5	Fan error 5	
6	6	Fan error 6	
8	-	DMD error	

Image Problems

❖ Problem: No image appears on the screen

1. Verify the settings on your video source.
2. Turn off all equipment and power up again in the correct order.

❖ Problem: The image is blurred

1. Adjust the **Focus** on the projector.
2. Ensure the projector-to-screen distance is within the 10-meter (33-feet) specified range.
3. Check that the projector lens is clean.

❖ Problem: The image is wider at the top or bottom (trapezoid effect)

1. Position the projector so it is as perpendicular to the screen as possible.
2. Use the Keystone settings in the OSD to correct the problem.

❖ Problem: The image is reversed or upside down

1. Check the **Installation** setting on the **Config.** menu of the OSD.

❖ Problem: The image is flat with no contrast

1. Adjust the **Contrast** setting on the **Picture Adjust** menu of the OSD.

❖ Problem: The color of the projected image does not match the source image.

1. Adjust the Color Temp. and Gamma settings on the **Picture Adjust** menu of the OSD.

Lamp Problems

❖ Problem: There is no light from the projector

1. Check that the power cable is securely connected.
2. Ensure the power source is good by testing with another electrical device.
3. Restart the projector in the correct order and check that the Power LED is blue.
4. Have the lamp module replaced.

❖ Problem: The lamp goes off

1. Power surges can cause the lamp to turn off. Press the power button to turn off the projector. When the Lamp Ready LED is on, press the power button.
2. Have the lamp module replaced.

Remote Control Problems

❖ Problem: The projector does not respond to the remote control

1. Direct the remote control towards remote sensor on the projector.
2. Ensure the path between remote and sensor is not obstructed.
3. Turn off any fluorescent lights in the room.
4. Check the battery polarity.
5. Replace the batteries.
6. Turn off other Infrared-enabled devices in the vicinity.
7. Have the remote control serviced.

Having the Projector Serviced

If you are unable to solve the problem, you should have the projector serviced. Pack the projector in the original carton. Include a description of the problem and a checklist of the steps you took when trying to fix the problem. The information may be useful to the service personnel. Return the projector to the place you purchased it.

SPECIFICATIONS

❖ Optical characteristics

Panel	0.8 inch 16:9 1280 x 720 pixels Digital Micromirror Device
Lamp	200W AC
Lens	f: 32.5 to 44.0mm F: F2.5
Projection size	60 to 300 inches

❖ Input/Output

VIDEO IN	RCA x 1 NTSC-3.58/PAL-4.43/SECAM Composite video 1.0Vp-p/ 75 Ohm
S-VIDEO IN	S-Connector x 1 NTSC-3.58/PAL-4.43/SECAM S-Video
COMPONENT IN	3RCA x 1 (Y, P _B , P _R) 5RCA x 1 (G/Y, B/P _B , R/P _R , H, V)
RGB/HD IN	D-sub M 15 pin x 1 Analog RGB
HDMI IN	DVI-D x 1
AC IN	3 Prong Grounding Type
TRIG.1 OUT, TRIG.2 OUT	Mini Jack x 2 Output: DC12V or 0V
RS-232C	RS-232C receptacle plug x 1

❖ General

Power requirement	AC 100-240V, 47–63 Hz
Power consumption	255 W
Standby consumption	1.3 W at 100 V AC 1.6 W at 240 V AC
Safety	UL60950 CAN/CSA-C22-2 NO-60950
EMC	FCC Part-15 Class-B EN55022 Class-B
Dimensions	17.13(W) x 14.76 (D) x 7.06 (H) inch 435(W) x 375(D) x 179.4(H) mm
Net weight	14.1 kg
Operating Temperature	10 to 35 °C
Operating humidity	30 to 85%
Storage Temperature	– 20 to 60 °C
Storage humidity	30 to 85%

❖ Accessories

- Lens cap x 1
- Remote controller x 1
- Batteries x 2
- Mains code x 1
- HDMI-DVI Connector
- User Guide
- Warranty Card
(1 copy each for USA, CANADA)

Specifications may be subjected to change without any prior notice.

❖ Timing chart

Format	Resolution	V (Hz)	H (KHz)	Comp.1/2	CVBS/S-Video	RGB	DVI
NTSC 3.58	720×487	59.94 / 60	15.75		●		
NTSC 4.43	720×487	59.94 / 60	15.75		●		
PAL-B/G	720×576	50	15.625		●		
PAL M	720×487	59.94 / 60	15.75		●		
PAL N	720×576	50	15.625		●		
PAL 60	720×487	59.94 / 60	15.75		●		
SECAM	720×576	50	15.625		●		
480/60i (NTSC)	720×487	59.94 / 60	15.75	●		●	●
480/60p	720×483	59.94 / 60	31.5	●		●	●
576/50i (PAL)	720×576	50	15.625	●		●	●
576/50p	720×576	50	31.25	●		●	●
720/50p	1280×720	50	37.5	●		●	●
720/60p	1280×720	59.94 / 60	45	●		●	●
1035/60i	1920×1035	59.94 / 60	33.75	●		●	●
1080/50i	1920×1080	50	28.125	●		●	●
1080/60i	1920×1080	59.94 / 60	33.75	●		●	●
640×480@60Hz	640×480	60	31.469			●	●
640×480@72Hz	640×480	72	37.861			●	●
640×480@75Hz	640×480	75	37.5			●	●
640×480@85Hz	640×480	85	43.269			●	●
800×600@56Hz	800×600	56	35.156			●	●
800×600@60Hz	800×600	60	37.879			●	●
800×600@72Hz	800×600	72	48.077			●	●
800×600@75Hz	800×600	75	46.875			●	●
800×600@85Hz	800×600	85	53.673			●	●
1024×768@60Hz	1024×768	60	48.363			●	●
1024×768@70Hz	1024×768	70	56.476			●	●
1024×768@75Hz	1024×768	75	60.023			●	●
1024×768@85Hz	1024×768	85	68.678			●	●
1280×1024@60Hz	1280×1024	60	63.981			●	●

DIMENSIONS

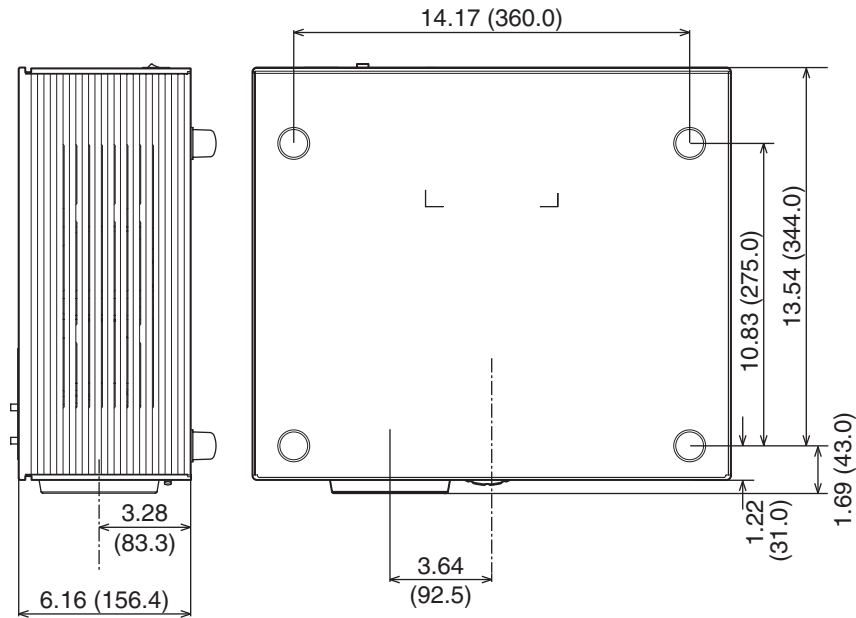
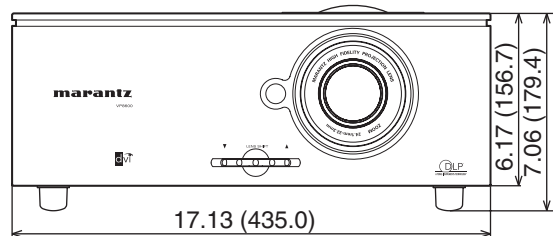
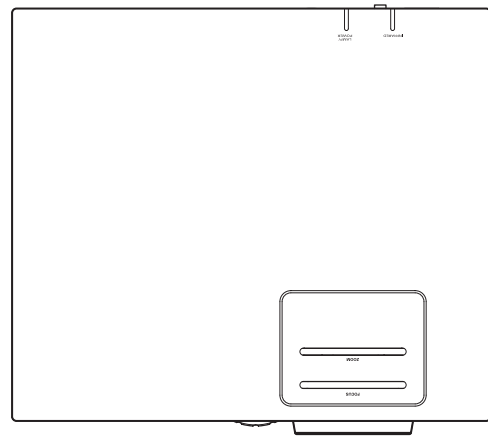
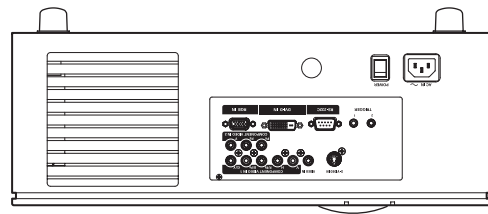

Unit : inch (mm)

GLOSSARY

Aspect ratio

Width and height ratio of an image. The normal aspect ratio of a computer and video image is 4 : 3. There are also wide images with an aspect ratio of 16 : 9, 1.88 : 1 and 2.35 : 1.

Color Temperature

White color hue.
 Low color temperature implies a warmer (more yellow/red) light.
 High color temperature implies a colder (more blue) light.

Keystone

Distortion of the image caused by projection to a wrong vertical/horizontal angle.

www.marantz.com

You can find your nearest authorized distributor or dealer on our website.

U.S.A. Marantz America, Inc. 1100 Maplewood Drive, Itasca, IL 60143, U.S.A.

EUROPE Marantz Europe B.V. P.O. Box 8744, 5605 LS Eindhoven, The Netherlands

marantz[®] is a registered trademark.



Free Manuals Download Website

<http://myh66.com>

<http://usermanuals.us>

<http://www.somanuals.com>

<http://www.4manuals.cc>

<http://www.manual-lib.com>

<http://www.404manual.com>

<http://www.luxmanual.com>

<http://aubethermostatmanual.com>

Golf course search by state

<http://golfingnear.com>

Email search by domain

<http://emailbydomain.com>

Auto manuals search

<http://auto.somanuals.com>

TV manuals search

<http://tv.somanuals.com>