

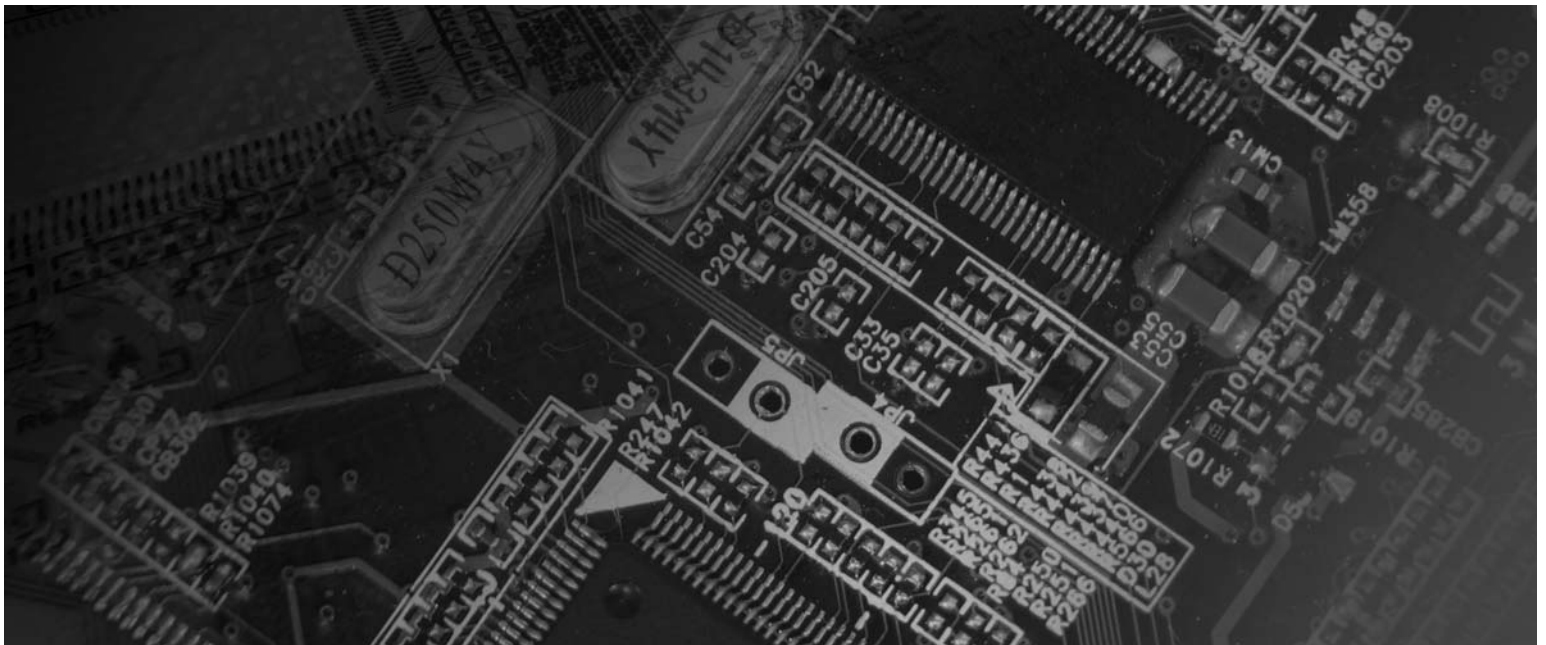

Secure Managed Client - Storage Array User Guide



Machine Type 8332



Secure Managed Client - Storage Array User Guide

Note

Before using this information and the product it supports, be sure to read the *Safety and Warranty Guide* that came with this product.

First Edition (October 2008)

© Copyright Lenovo 2005, 2008. All rights reserved.

LENOVO products, data, computer software, and services have been developed exclusively at private expense and are sold to governmental entities as commercial items as defined by 48 C.F.R. 2.101 with limited and restricted rights to use, reproduction and disclosure.

LIMITED AND RESTRICTED RIGHTS NOTICE: If products, data, computer software, or services are delivered pursuant a General Services Administration "GSA" contract, use, reproduction, or disclosure is subject to restrictions set forth in Contract No. GS-35F-05925.

Contents

Introduction	v
Product contents, order options, and accessories	v
Chapter 1. Important safety information	1
Chapter 2. Features	3
Enclosure subsystem	4
Enclosure chassis	5
Server board subdivision	6
Server board I/O panel	6
Front operator's panel	7
Rear panel	8
Power supply unit	8
Power supply output connectors	9
Cooling fans	9
Drive carrier module	10
Drive status indicator	11
Anti-tamper locks	11
Chapter 3. Getting Started	13
Planning your installation	13
Drive bay numbering convention	13
Enclosure installation prerequisites	14
Preparation of site and host server	14
Unpacking the enclosure system	14
Planning and configuring your installation	15
Rack installation prerequisites	15
Installing the enclosure in a rack	16
Rail kit assembly	16
Enclosure installation	16
Power cord connection	17
Grounding checks	17
Chapter 4. Operation	19
Power on	19
Power supply unit LED	19
Front operator's panel LEDs and switches	20
Starting the drives	21
Disk drive LEDs	21
Engaging the drive module anti-tamper locks	21
BIOS settings	22
Turning off	22
Chapter 5. Troubleshooting and problem solving	23
Initial start-up problems	23
Faulty cords	23
Alarm sounds and power up	23
Computer doesn't recognize the subsystem	23
LEDs	23
Power supply units	23
Front operator's panel	24
Cooling fan LEDs	25
Drive carrier module LEDs	25
Rear panel LED	25
Server board LEDs	25
Audible alarms	26
Alarm interpretation	26
Troubleshooting	28
System faults	28
Power supply unit faults	28
Cooling fan faults	29
Thermal cooling	29
Drive carrier module faults	30
Dealing with hardware faults	30
Continuous operation during replacement	31
Chapter 6. Notices	33
Trademarks	34

Introduction

The Secure Managed Client (SMC) - Storage Array is a 2U (rack space) disk drive enclosure, currently housing 12 low-profile 2.54-cm (1-inch) high, 1.5/3.0 Gb/s, 8.89-cm (3.5-inch) form factor SATA disk drives. Each individual disk drive is field replaceable.

This guide is written for system technicians who are responsible for setting up, installing, and troubleshooting this storage system. This document provides a brief overview of the features of this product, a list of accessories or other components you may need, instructions on setting up the system, and troubleshooting information.

Product contents, order options, and accessories

The SMC - Storage Array ships with the following items:

- *Secure Managed Client (SMC) - Storage Array Setup Poster*, in the product box
- AC power cord(s) (North America only)
- 50 Phillips head screws
- Resource CD
- Rail kit
- T10 TORX screwdriver
- 12 hard drive labels

For information about which accessories and third-party hardware have been tested and can be used with your storage system, and for ordering information for Lenovo products, visit <http://www.lenovo.com>.

Chapter 1. Important safety information

CAUTION:

Before using this manual, it is important that you read and understand all the related safety information for this product. Refer to the *Safety and Warranty Guide* that you received with this product for the latest safety information. Reading and understanding this safety information reduces the risk of personal injury and or damage to your product.

Chapter 2. Features

Figure 1 shows a front view of the Secure Managed Client (SMC) - Storage Array while Figure 2 shows a rear view with the lid removed, showing those areas accessible to service personnel only.

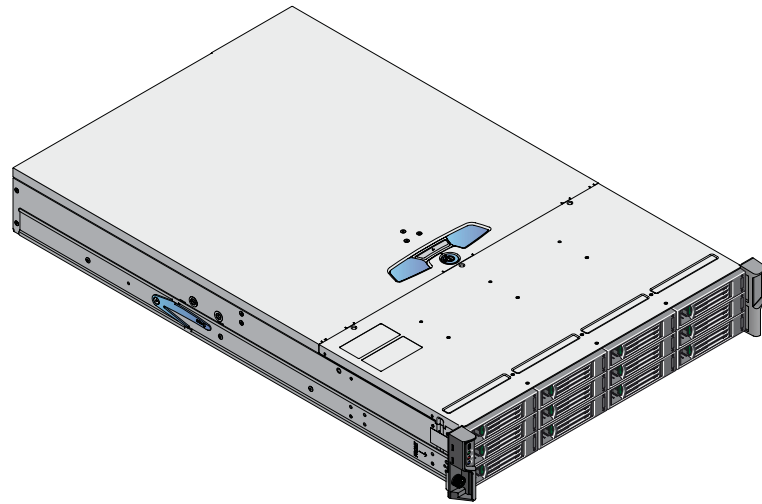

Figure 1. SMC - Storage Array front view

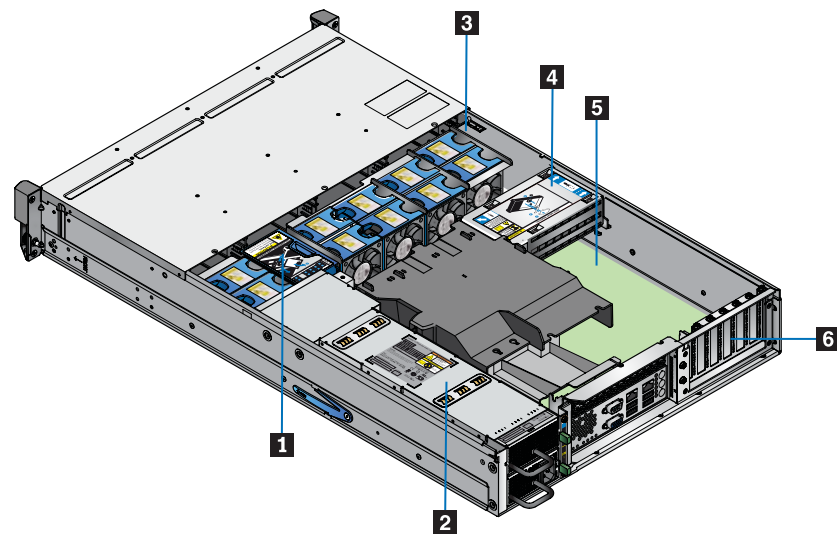

Figure 2. SMC - Storage Array rear view, showing service areas

- 1** SAS expander card
- 2** Power supply unit
- 3** Cooling fans (10)
- 4** Boot drive
- 5** Server board
- 6** PCI slots

Enclosure subsystem

The SMC - Storage Array design concept is based on an enclosure subsystem together with a set of plug-in modules and (as supplied) consists of:

- An enclosure chassis with:
 - A backplane PCB
 - An enclosure management PCB
 - A SAS expander PCB, to branch from 4 to 12 SAS ports, supporting SATA tunnelling protocol
 - A front operator's panel
 - An integral rear panel, incorporating an enclosure ID LED
 - A power supply mounting cage containing one 850-W plug-in power supply unit (PSU)

Note: A blanking plate must be installed over the empty upper bay.

- A server subsystem comprising:
 - An Intel Server Board S5000PSL with integral I/O panel
 - An Intel RAID Controller SRCSATAWB
 - A boot drive module
- A cooling module containing 10 high-speed, single-rotor axial fans, which are individually pluggable
- 12 SATA hard drives

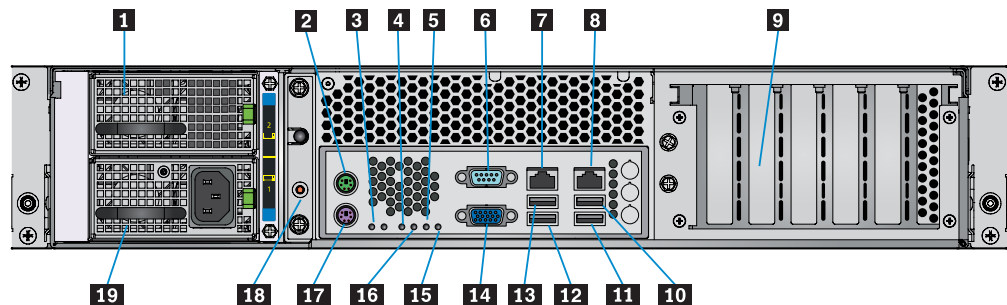

Figure 3. Enclosure subsystem rear view

- | | |
|-------------------------------------|-------------------------------|
| 1 Empty power supply bay | 11 USB port 1 |
| 2 PS2 mouse port | 12 USB port 3 |
| 3 System status LED | 13 USB port 2 |
| 4 MSB (POST LED) | 14 Video port |
| 5 Bit 1 (POST LED) | 15 LSB (POST LED) |
| 6 Serial port | 16 Bit 2 (POST LED) |
| 7 NIC port 1 (1 Gb) | 17 PS2 keyboard |
| 8 NIC port 2 (1 Gb) | 18 ID LED |
| 9 2 dual-port Ethernet cards | 19 Power supply unit 1 |
| 10 USB port 0 | |

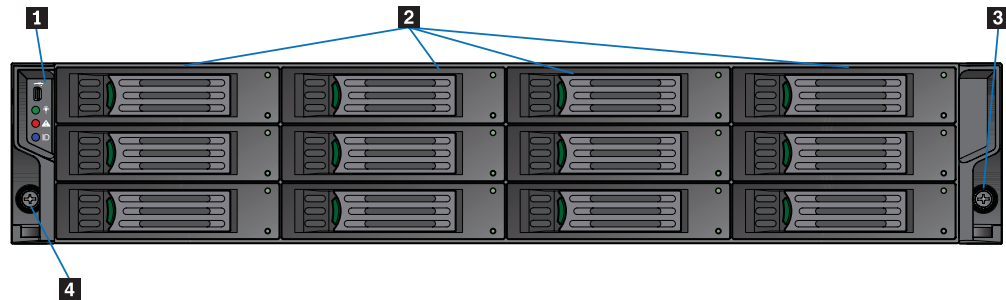

Figure 4. Enclosure subsystem front view

- 1** Front panel
- 2** Drive bays
- 3** Rack retaining screw
- 4** Rack retaining screw

Enclosure chassis

The chassis is installed with 48.26-cm (19-inch) rack-mounting features, which enable it to be installed to standard 48.26-cm (19-inch) racks. One chassis occupies two units of rack space (3.5 inches or 8.89 cm high).

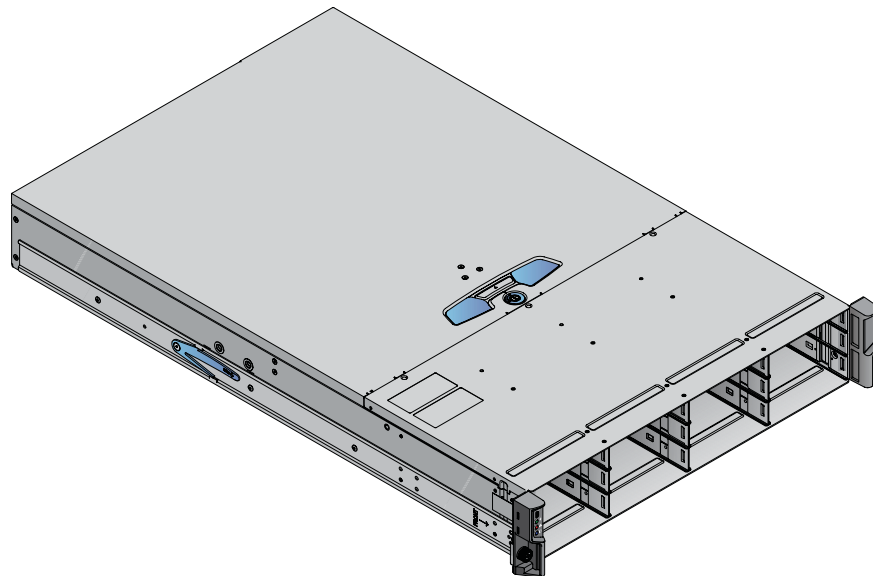

Figure 5. Enclosure chassis

The backplane PCB provides 12 direct dock SAS/SATA connectors to the drives and acts as the connectivity hub of the enclosure, connecting to the enclosure management PCB.

The ten cooling fans are connected to the system by the enclosure management PCB.

There are 12 drive bays at the front of the enclosure. Each drive bay accommodates a plug-in drive carrier module that can house one low-profile 2.54-cm (1-inch) high

8.89-cm (3.5-inch) form factor drive. In addition, two 6.35-cm (2.5-inch) boot drives can be installed in the boot drive module.

Note: A bay is defined as the space required to house a single 2.54-cm (1.0-inch) high 8.89-cm (3.5-inch) disk drive in its carrier module (limitation of 1 TB size).

At the rear, the chassis assembly accommodates one PSU and a server board subsystem.

A top cover on the enclosure provides access to the cooling fans and the server board subsystem.

Note: The enclosure cover should only be removed by qualified service personnel as it provides access to a service area. Upon replacement, the cover **MUST** be secured by tightening the lock mechanism to the locked position with a screwdriver.

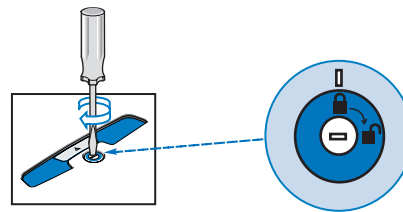

Figure 6. Locking the enclosure cover

Server board subdivision

The server board subdivision consists of:

- An Intel Server Board S5000PSL
- Slots for up to six low-profile 1.905-cm (3/4-inch) PCI cards, installed in a vertical orientation. The following PCBs are installed as standard configuration:
 - An Intel RAID Controller SRCSATAWB, in the left-hand slot (when viewed from the rear)
- A boot drive module, which contains two 6.35-cm (2.5-inch) SATA boot drives

Server board I/O panel

The server board I/O panel consists of various connectors and LEDs.

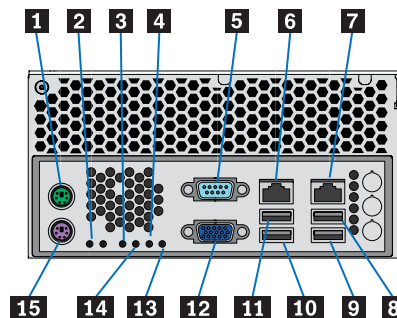

Figure 7. Server board I/O panel connectors

- | | |
|----------------------------|---------------------------|
| 1 PS2 mouse port | 9 Bit 2 (POST LED) |
| 2 System status LED | 10 LSB (POST LED) |
| 3 MSB (POST LED) | 11 Video port |
| 4 Bit 1 (POST LED) | 12 USB port 2 |
| 5 Serial port | 13 USB port 3 |
| 6 NIC port 1 (1 Gb) | 14 USB port 1 |
| 7 NIC port 2 (1 Gb) | 15 USB port 0 |
| 8 PS2 keyboard | |

Connectors

The following connectors are located on the server board I/O panel:

- PS2 mouse port
- PS2 keyboard port
- Serial port
- Video port
- Two RJ-45 ports - NICs 1 and 2 (1Gb each)
- Four USB ports: 0, 1, 2, and 3

Server board LEDs

Status LEDs: Diagnostic LEDs are located on the server board I/O panel to assist in identifying failed and failing components. See “Server board LEDs” on page 25 for a summary of status LED states.

NIC LEDs: The NIC LEDs at the right and left of each NIC port provide information on NIC status. See “I/O panel NIC LEDs” on page 25 for a summary of NIC LED states.

Front operator's panel

A front operator's panel, consisting of a USB port, three LEDs and three push-button switches, are located on the front of the enclosure.

Note: The front operator's panel is an integral part of the enclosure assembly and is not field replaceable.

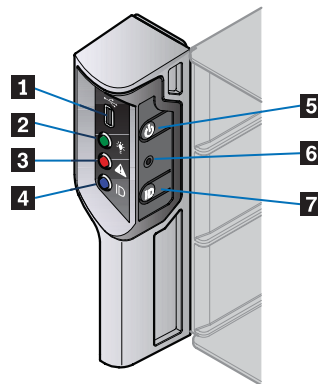

Figure 8. Front operator's panel components

- | | |
|-------------------------|---------------------------|
| 1 USB port | 5 Power active LED |
| 2 Unit fault LED | 6 ID LED |

3 On/off switch

7 Reset button (recessed)

4 ID LED activation switch

Table 1. Functions of front operator's panel LEDs and switches

LED	Push-button switch	USB Port
Power Active (Green)	Power On/Off	Intended for service use only.
Unit Fault (Amber)	Reset Button	Intended for service use only.
Enclosure ID (Blue)	Enclosure ID LED Activation	Intended for service use only.

For a full description of LED and switch functions, see “Front operator's panel LEDs and switches” on page 20.

Rear panel

A rear panel, consisting of a blue enclosure ID LED (see Figure 2 on page 3), is located on the rear of the enclosure.

Note: The rear panel is an integral part of the enclosure assembly and is not field replaceable.

Table 2. Rear Panel ID LED Status

Enclosure ID LED	Blue (when activated)	Activated by push button on the Front Operator's Panel, or by system software. Used to identify a server from among several servers.
------------------	-----------------------	---

Power supply unit

AC-DC power is provided by a power supply with specific load capability, mechanical packaging, and output connectors to suit this product.

A power supply mounting cage is installed in the rear of the enclosure as part of the subsystem core product. The cage houses one individually hot pluggable 850-W AC power supply unit (PSU) with its own IEC inlet connector and failure indicator.

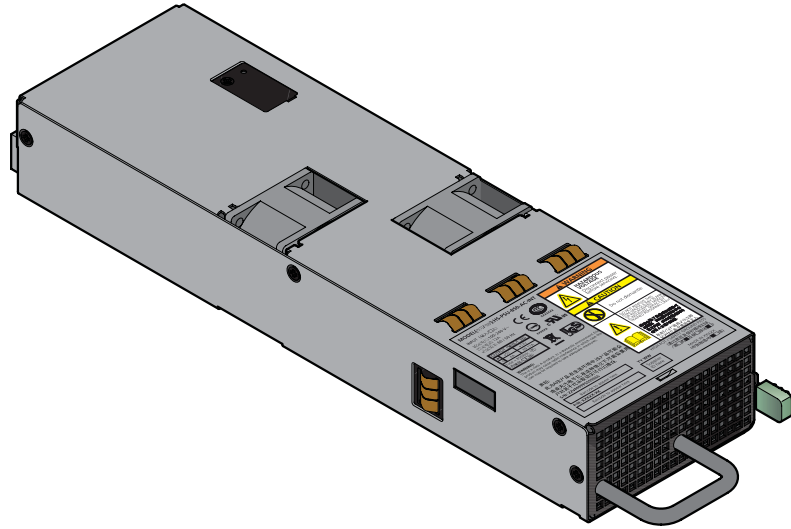

Figure 9. Power supply unit

Power supply unit voltage operating ranges are nominally 100V - 240V AC, selected automatically.

The PSU has an audible alarm to indicate a fault state and a bi-color (green/red) LED to indicate PSU status.

Power supply output connectors

The power supply output connectors provide the following outputs:

- P1 server board main power connector (1 x 24 pin)
- P2 processor power connector (8 pin)
- P3 12-V power connector
- P4 peripheral power connector (2 x 4 pin)
- P5 PSU1 connector (5 pin)

Cooling fans

Ten high-speed single-rotor axial fans are housed in a cooling cage, located centrally within the enclosure, between the drive bays and the server board, as shown in Figure 2 on page 3. This ensures maximum airflow through the PSU and minimizes noise.

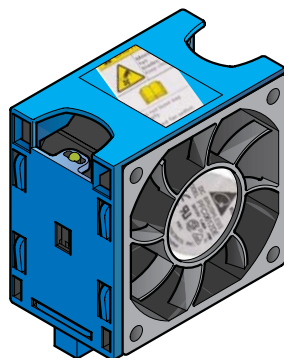

Figure 10. Cooling fan

Airflow is front to rear with cooling air being drawn across the drives, through the fans and pressurizing the rear of the enclosure. The pressurized rear allows the PSU to draw the air that it requires; perforations at the rear of the chassis allow cooling air to flow over the processor heatsinks, server board and PCI cards.

The cooling system must be operated with low-pressure rear exhaust installation (back pressure created by rack doors and obstacles not to exceed 5 pascals [0.5mm Water gauge]).

The cooling system provides sufficient capacity to ensure that drive maximum temperatures have not exceeded at 35°C (95°F) with one failing fan at sea level.

The cooling cage contains ten individual high-speed single-rotor axial fans, individually connected to and interfacing with the enclosure management PCB. This interface provides power and speed control to the fans and returns speed output from each fan to the management system.

Drive carrier module

The drive carrier module consists of a hard disk mounted in a drive carrier. Each drive bay can house a single low-profile 2.54-cm (1.0-inch) high, 8.89-cm (3.5-inch) form factor SATA disk drive in its drive carrier. The drive carrier has mounting locations for SATA drives.

Each disk drive is enclosed in a sheet steel carrier which provides excellent thermal conduction, radio frequency and electro-magnetic induction protection, as well as affords the drive with maximum physical protection.

The front cap of the drive carrier supports an ergonomic handle, which provides the following functions:

- Camming of drive carrier into and out of drive bays.
- Positive "spring loading" of the drive/backpane connector.

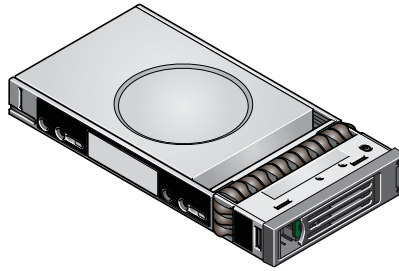

Figure 11. Driver carrier module

Drive status indicator

Disk drive status, under ESI processor control, is monitored by two LEDs (a green LED and an amber LED) mounted on the front cap of each drive carrier module. See "Disk drive LEDs" on page 21 for a description of LED states.

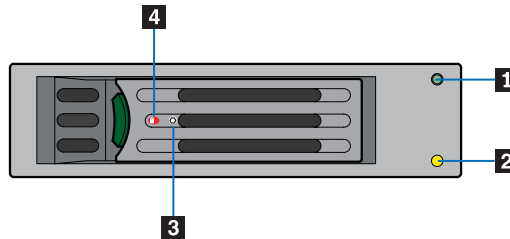

Figure 12. Drive status LEDs and components

- 1 Green LED
- 2 Amber LED
- 3 Torque screw
- 4 Drive lock indicator opening

Anti-tamper locks

Anti-tamper locks are installed in each drive carrier handle and are accessed with a TORX screwdriver through the small cutout in the latch section of the handle. When activated, the locks disable the normal "pinch" latch action of the drive carrier handle. A drive is locked when the red lock symbol appears in the indicator opening.

Chapter 3. Getting Started

In this chapter, you are shown how to plan and install your Secure Managed Client (SMC) - Storage Array into an industry standard 48.26-cm (19-inch) rack cabinet.

CAUTION:

When connecting the SMC - Storage Array, use only the power cords supplied or power cords that match the specification quoted in the *Safety and Warranty Guide*.

Planning your installation

Before installing the SMC - Storage Array, familiarize yourself with the configuration requirements listed in the following table.

CAUTION:

Installation procedures should be performed by trained personnel only.

Table 3. Configuration requirements

Module	Location
Drive bays	All drive bays must be installed with either a drive carrier module or a dummy drive carrier module. No bays should be left empty. A minimum of 1 drive must be installed.
Power supply	One PSU can be installed. A blanking plate must be installed to cover the empty (top) slot.
Cooling fans	Ten fans, housed in a cooling cage, are located centrally within the enclosure between the drive bays and the server board.
PCI cards	Up to six PCI cards can be installed in a vertical orientation. Currently, only the two outer card slots are used in the standard configuration, installed with an Intel® RAID Controller SRCSAS144E and an Intel® Intelligent AXXRIBBU1 Battery Backup Unit. When not in use, the four empty PCI slots must be installed with blanking plates.

Drive bay numbering convention

The drive bay numbering convention is as follows.

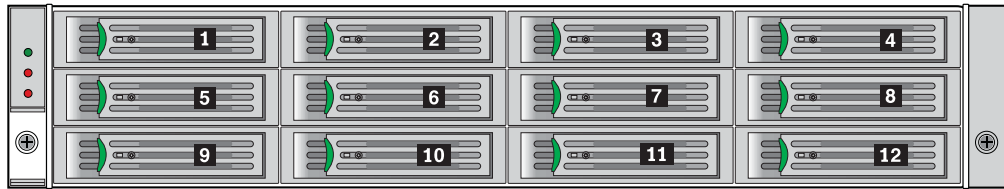
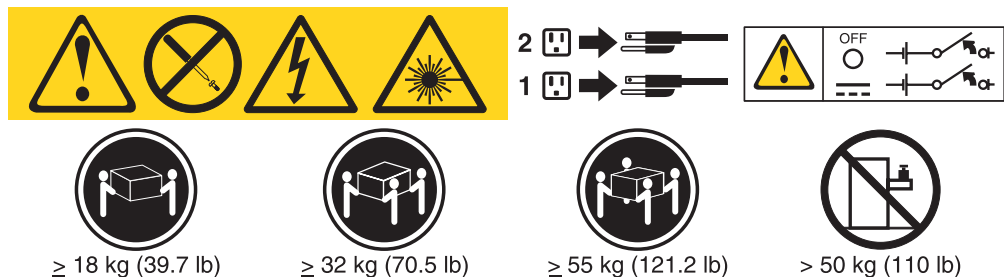

Figure 13. Drive bay numbering

The SMC - Storage Array subsystem is housed in a 4 x 3 enclosure (four drive bays wide by three bays high). The top bays are numbered 1 to 4 from left to right, as viewed from the front. Drive carrier module locations are identified from a matrix of the top and side numbers.

Enclosure installation prerequisites

The SMC - Storage Array is delivered fully populated with 12 drive carrier modules pre-installed.



Notes:

1. The SMC - Storage Array with all its component parts installed is too heavy for a single person to easily install into a rack cabinet.
2. Ensure that you have fitted and checked a suitable anti-static wrist or ankle strap and observe all conventional ESD precautions when handling modules and components. Avoid contact with backplane, server board and PCI card components and module connectors, or other parts. See the *Safety and Warranty Guide* for additional information on static electricity prevention.

Preparation of site and host server

Before beginning, make sure that the site where you intend to set up and use your SMC - Storage Array has standard AC power available from an independent source or a rack power distribution unit with a universal power supply (UPS).

Unpacking the enclosure system

The package contents and unpacking procedure are outlined in the following figure.

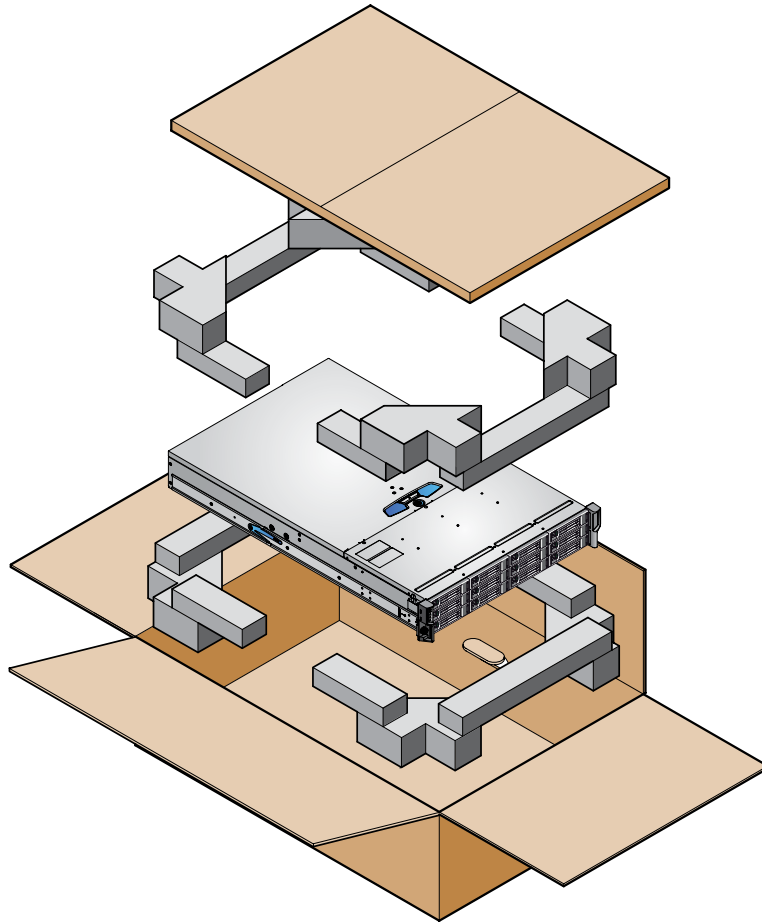

Figure 14. Unpacking the SMC - Storage Array

Planning and configuring your installation

Refer to “Planning your installation” on page 13 for information on overall system configuration requirements.

Refer to the *Secure Managed Client (SMC) - Storage Array Setup Poster* that shipped with your system for instructions on installing the processors, drives, and memory.

Rack installation prerequisites

The SMC - Storage Array is designed for installation into an industry standard 48.26-cm (19-inch) cabinet capable of holding the unit.

- Minimum depth: 70.76 cm (27.83 inches) from rack posts to maximum extremity of enclosure (excludes rear cabling).
- Weight: up to 30 kg (66.20 lb), dependent upon configuration, per enclosure.
- A minimum gap of 2.54-cm (1-inch) clearance is required between the rack cover and front of drawer. A 5.08 cm (2-inch) rear clearance between rear of drawer and rear of rack is recommended to maintain correct airflow around the enclosure.
- The rack should present a maximum back pressure of 0.5 mm (5 pascals) water gauge.

CAUTION:

Operation of the enclosure system with any modules missing will disrupt the airflow and the drives will not receive sufficient cooling. It is essential that all openings are filled before operating the unit.

Installing the enclosure in a rack

A set of rack-mounting rails is provided with the system for installing the SMC - Storage Array in a 48.26-cm (19-inch) rack cabinet. These rails have been designed and tested to handle the maximum weight of the enclosure and to ensure that multiple enclosures may be installed without loss of space within the rack. Use of other mounting hardware may cause some loss of rack space.

Contact your supplier to ensure suitable mount rails are available for the rack you are using.

Rail kit assembly

Refer to the *Rail Kit Installation Guide* for instructions on assembling the rail kit.

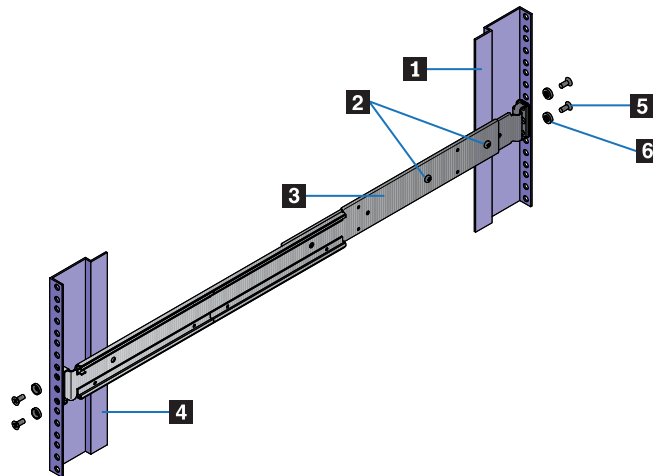

Figure 15. Rack mount rail kit

- 1** Rear rack post
- 2** Clamping screws
- 3** Rack bracket ASM
- 4** Front rack post
- 5** Slide screw (4)
- 6** Slide washer (4)

Enclosure installation

To install the enclosure, do the following:

1. Check for damage.
2. Lift enclosure and align with front rails.
3. Carefully insert enclosure slides into rack rails and push fully home.
4. Tighten rear screws.
5. Withdraw enclosure until it reaches hard stops (approximately 400 mm).
6. Tighten front screws.

- Return enclosure to fully home position and attach to rack using captive fasteners on front flanges.

Note: Rack rails have features to restrict complete enclosure withdrawal while still allowing access to the cooling fans. If it becomes necessary to completely remove the system, pull the enclosure out until it stops then rotate the latches, shown in Figure 15 (right hand up, left hand down), to completely remove the enclosure from the rack.

Power cord connection

CAUTION:

The power connection must always be disconnected prior to removal of a PSU from the enclosure.

To connect the power cord, do the following:

- Observe all safety and ESD precautions listed in the *Safety and Warranty Guide*.
- Attach a power cord for the installed PSU. The Power On LED (see **1** in Figure 16) for the PSU will blink green when AC main power is present. The Power On LED will illuminate a constant green when power to the PSU is turned on.

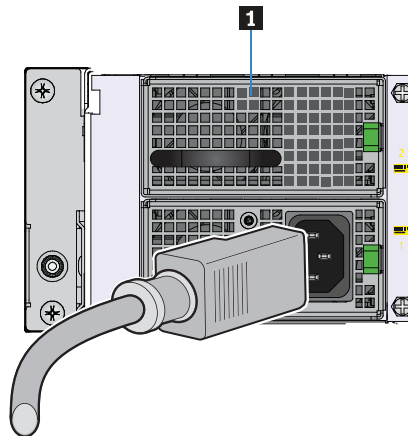

Figure 16. Connecting power cords

Grounding checks

The SMC - Storage Array must only be connected to a power source that has a safety electrical earth connection.

CAUTION:

If more than one enclosure is installed in a rack, the earth connection to the rack is even more important, because the rack will have a high “earth leakage current” (“touch current”).

Before powering on, the earth connection to the rack must be checked by an electrical engineer who is qualified in local and National electrical standards.

Chapter 4. Operation

Before powering on the Secure Managed Client (SMC) - Storage Array ensure that all modules are firmly seated in their correct bays.

Power on

Apply AC main power to power on the enclosure.

The power active LED on the front operator's panel will light up green once power is activated. The disk drive motors will also start running.

CAUTION:

Do not operate the SMC - Storage Array until the ambient temperature is within the specified operating range. If the drives have been recently installed, ensure they have had time to acclimate before operating them.

Notes:

1. If main power is lost for any reason, upon restoration of power, the enclosure will re-start automatically.
2. See "Front operator's panel LEDs and switches" on page 20 for details on Front Operator's Panel LEDs and related fault conditions.

Power supply unit LED

The PSU has a bi-color red/green LED.

- When the PSU is connected to a main supply, the LED will flash green.
- When the PSU is switched on, the LED will illuminate a constant green.
- If a fault occurs, the LED will illuminate a constant red.
- If an over-current, under-voltage or over-voltage protection condition occurs, the LED will flash red.

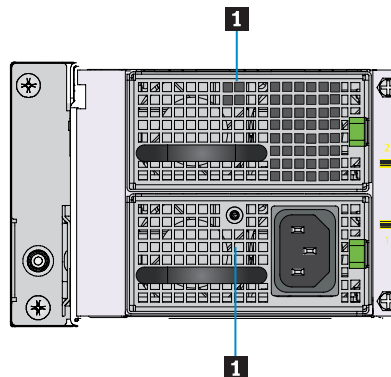

Figure 17. Power supply unit LEDs

1 POST LED

Front operator's panel LEDs and switches

The front operator's panel LED fault and status conditions are defined in Table 4. Functions of the push-button switches are defined in Table 5.

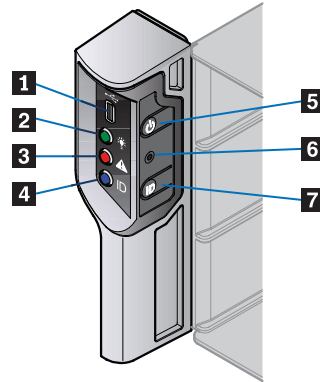

Figure 18. Front operator's panel components

- 1** USB port
- 2** Power active LED
- 3** Unit fault LED
- 4** ID LED
- 5** On/off switch
- 6** Reset button (recessed)
- 7** ID LED activation switch

Table 4. Front operator's panel LED states

LED	Status
Power active	Constant green: good or positive indication
Unit fault	Constant amber: fault present
Enclosure ID	<i>Blue: only when activated</i>

Table 5. Front operator's panel switch functions

Push-button switch	Definition
On/Off	Function of this button is dependent on the enclosure status. <i>Enclosure connected to power source but not operating.</i> Press button to activate and commence boot process. <i>Enclosure operating:</i> Depress button for <4 seconds to turn off the enclosure.
System reset	Resets the enclosure hardware and firmware. This button is recessed and is activated with a ball-point pen or similar implement.
Enclosure ID	Each press of this button causes the state of the blue ID LED on the Front Operator's Panel and rear panel to change.

Starting the drives

Unless otherwise selected during installation, all drives in the enclosure should automatically start their motors during power on. If this does not occur then one of the following conditions may exist:

- There may be a power problem (an alarm and power fault indication would normally be present).
- The drive motors will spin up in a delayed sequence.

Disk drive LEDs

Each drive carrier module has two LEDs, an upper (green) LED and a lower (amber) LED.

- During normal operation, the green LED will be on and will flicker to indicate drive activity. It will also be on when no drive is present. It is off when the drive is not spun up.
- During normal operation, the amber LED will be:
 - Off if no drive is present
 - Off as the drive operates
 - On if a drive fault exists

Engaging the drive module anti-tamper locks

An anti-tamper lock is installed in each drive carrier handle and can be accessed through the small cutout in the latch section of the handle with a TORX screwdriver. A lock symbol displays in the small opening beside the torque screw when the drive is locked.

Activating an anti-tamper lock

To activate an anti-tamper lock, do the following:

1. Carefully insert the TORX screwdriver provided into the cutout in the handle (see **1** in Figure 19).
2. Rotate the screwdriver in a clockwise direction until the lock symbol is visible in the opening beside the key (see **2** in Figure 19).

Note: Do not turn the lock more than half a turn; otherwise, the drive carrier may be damaged.

3. Remove the screwdriver.

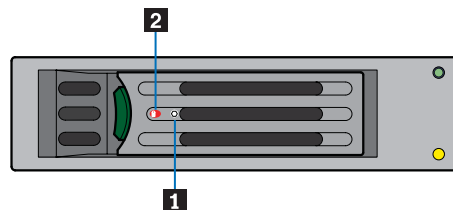

Figure 19. Activating an anti-tamper lock

Note: A drive carrier cannot be installed if its anti-tamper lock is activated outside the enclosure.

Deactivating an anti-tamper lock

To deactivate an anti-tamper lock, do the following:

1. Carefully insert the TORX screwdriver provided into the cutout in the handle (see **1** in Figure 20).
2. Rotate the screwdriver in an anti-clockwise direction until the lock symbol is no longer visible in the opening beside the key (see **2** in Figure 20).

Note: Do not turn the lock more than half a turn; otherwise, the drive carrier may be damaged.

3. Remove the screwdriver.

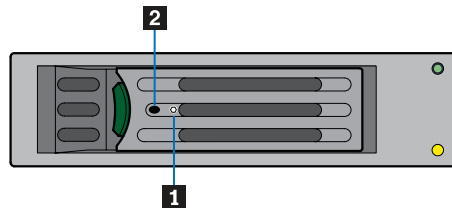

Figure 20. Deactivating an anti-tamper lock

BIOS settings

To install the AMI StorTrends iTX software, verify the following BIOS settings:

1. Disable the Onboard SATA Controller option to install onto the boot drive. This option is present in the ATA Controller Configuration settings under the **Advanced** tab.
2. Enable the LSI MPT SAS Controller option, which is present in the Mass Storage Controller Configuration settings under the **Advanced** tab.
3. If you add DIMMS to increase system memory, the default BIOS option limits the memory visible to the operating system to 2.50GB. To make more memory visible to the operating system, modify the Memory Mapped I/O Start Address option, which is present in the PCI Configuration settings under the **Advanced** tab.
4. To boot from the network using PXE boot, enable the option Onboard NIC ROM option, which is also present in the PCI Configuration settings. The device boot order registers this change after you save the changes and reboot.
5. To boot from the boot drive attached to the LSI MPT SAS controller, change the hard disk order under the **Boot Options** tab. Set ID01 LUN0 as the first disk, followed by the PCI RAID adapter. If you need to enable the network boot, select IBA GE as the first boot device.
6. To boot from the boot drive attached to the LSI MPT SAS controller, set ID01 LUN0 as the second boot option under the **Boot Options** tab.

Note: The drives need to be connected to the blue SATA slots on the server board for installation.

Turning off

To turn off the enclosure, either:

- Turn off the PSU installed in the enclosure by pressing the power push-button on the front operator's panel for approximately three seconds,

OR

- Remove AC main at the power source

Chapter 5. Troubleshooting and problem solving

The Secure Managed Client (SMC) - Storage Array includes an enclosure services processor and associated monitoring and control logic to enable it to diagnose problems within the enclosure's power, cooling and drive systems.

The sensors for power and cooling conditions are housed within the PSUs and cooling fans. There is independent monitoring for each unit.

Initial start-up problems

The following problems may occur on initial start up:

Faulty cords

First check that you have wired up the subsystem correctly. Call your supplier for replacement if:

- Cords are missing or damaged.
- Plugs are incorrect.
- Cords are too short.

Alarm sounds and power up

See "Audible alarms" on page 26 for details.

Computer doesn't recognize the subsystem

1. Check that the interface cables from the SMC - Storage Array to the host computer are installed correctly.
2. Check that the LEDs on all installed drive carrier modules are illuminated (amber).

Note: Drive LEDs will not be lit during drive spin up.

3. Check that drive carrier modules have been correctly installed.

LEDs

A green LED is always used for good or positive indication. A flashing green/amber LED is used for non-critical conditions. With the exception of the drive carrier module LED, which is lit amber under Normal conditions (see "Drive carrier module faults" on page 30), a continuous red or amber LED indicates the presence of a critical fault within the module.

Power supply units

The power supply unit provides a single external bi-color LED to indicate the status of the power supply. When AC is applied to the PSU and standby voltages are available, the LED will blink green. The LED will be solid on green to indicate that all power outputs are available. The LED will be on solid amber to indicate that the power supply has failed (shut down due to over current, shut down due to over temperature, or a predictive failure).

Table 6. Power supply unit LED states

Condition	LED state
No AC power to all PSUs	Off
Power supply direct current (DC) outputs ON and OK	Green
No AC power to this PSU only	Amber
AC present / only standby outputs	Blink Green
Power supply failure (includes over voltage, over temperature)	Amber
Voltage regulator module (VRM) failure (cage related)	Blink green
240VA limit (cage related)	Blink green
Current limit	Amber

Front operator's panel

The front operator's panel displays the aggregated status of all the modules. Front operator's panel LED states are defined in Table 4 on page 20.

Note: The front operator's panel is supplied as an integral part of the enclosure core product and is not user replaceable.

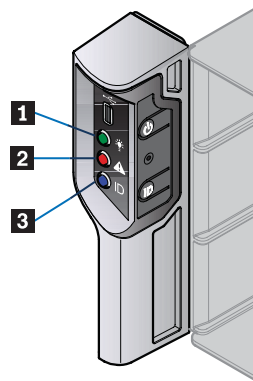

Figure 21. Front operator's panel LEDs

- 1** Power active LED
- 2** Unit fault LED
- 3** Enclosure ID LED

Table 7. Ops panel LED states

LEDs	Normal Operation	Fault condition
Power active	Constant green: good or positive indication	
Unit fault	Off	Constant amber: fault present
Enclosure ID	Blue: <i>only when activated</i>	Blue: <i>only when activated</i>

Cooling fan LEDs

An amber LED incorporated in each cooling fan monitors its status. Constant On indicates a fault condition. .

Drive carrier module LEDs

Disk drive status is monitored by a green LED and an amber LED mounted on the front of each drive carrier module. The conditions for each LED are defined in "Drive carrier module faults" on page 30.

Rear panel LED

Table 8. Rear panel status LED

Enclosure ID LED	Blue (when activated)	Activated by push button on the front operator's panel, or by system software. Used to identify a server from among several servers.
------------------	-----------------------	--

Server board LEDs

Server board LEDs consist of I/O panel status LEDs and I/O panel NIC LEDs.

I/O panel status LEDs

The server board I/O panel contains a number of diagnostic LEDs, whose functions are summarized in the following table. Refer to your server board documentation for full details of each LED state.

Table 9. Server board status LEDs

LED	Color	Function
System status LED	<ul style="list-style-type: none">• Green• Off• Alternating green/amber• Amber• Green blink• Amber blink	<ul style="list-style-type: none">• System OK• AC power off• System not ready• Critical fault• System degraded• Non-fatal alarm, system likely to fail
4 x power-on self test (POST) LEDs	<p>Off</p> <p>*Amber</p>	<p>System running normally</p> <p>The POST LEDs toggle between red, green, amber, and Off at boot up.</p> <p>*(Lit amber only if a failure occurs)</p>

I/O panel NIC LEDs

The Network Interface Controller (NIC) LED states are summarized in the following table. Refer to your server board documentation for full details of each state.

Table 10. NIC LEDs

LED	LED state	Description
Left	Off	No network connection is in place
	Solid green	Active network connection is in place
	Blinking green	Transmit / receive activity is occurring
Right	Off	10 Mbps connection (if left LED is on or blinking)
	Solid green	100 Mbps connection
	Solid amber	1000 Mbps connection

Audible alarms

The PSUs incorporate audible alarms, which indicate when a fault state is present. A Voltage Out Of Range condition will activate the audible alarm.

The audible alarm can be muted by pressing the Enclosure ID button on the front operator's panel.

Alarm interpretation

The following table summarizes the various interpretations when combining LED states and audible alarms. Use this table to help understand a pattern of lights and beeps. Each light/beep is taken in turn and shows linked items, so some of the data is duplicated in several places to make ease of search better.

Note: There will be no beep if the enclosure is muted.

Table 11. Light and buzzer interpretations

LED/buzzer	State	Related	Meaning	Action
Front operator's panel fault light	Off	-	No warnings or worse	None - all OK
	Slow blink (0.5 seconds on, 3.5 seconds off)	Slow beep (half second beep every 8 seconds). No fan/drive lights lit constant. No beep if muted.	Warning state - usually approaching temperature threshold.	Check ambient temperature and increase if too cold or decrease if too hot. If this does not work, check for fan failure that has a broken light, too.
		Slow beep. Fan light constant. No beep if muted.	Fan broken or out of tolerance.	Replace lit fan.
		Slow beep. Fan light constant. No beep if muted.	Drive fault	Replace drive

Table 11. Light and buzzer interpretations (continued)

LED/buzzer	State	Related	Meaning	Action
	Fast blink (alternating every half second)	Faster beep (1.5 seconds beep, 0.5 seconds silence). No fan light constant. No beep if muted.	Critical state - usually temperature near edge of operating range	Check ambient temperature and increase if too cold or decrease if too hot immediately. If this does not work, check for a fan failure that also has a broken light.
		Faster beep, more than one fan light on or a single PSU fan light on. No beep if muted.	Fans broken or out of tolerance.	Replace fans immediately.
	Constant on	Constant - no fan lights lit constant	Failure state - temperature in range where damage could occur	Check ambient temperature and increase if too cold or decrease if too hot immediately. If this does not work check for fan failure that has a broken light, too.
		Constant - multiple fan lights lit constant	Fans broken or out of tolerance	Replace fans immediately. Decrease ambient temperature
Fan light	Constant on	Varying levels of beep and chassis fault light setting. No beep if muted.	Fan broken or out of tolerance.	Replace fans immediately.
Drive light (amber)	Constant on	Varying levels of beep and chassis fault - usually slow beep and slow flash. No beep if muted.	Drive faulty	Replace drive
Front operator's panel ID LED	Flashing		Ops panel ident on	
Buzzer	Off	Front operator's panel fault LED off	No issues	
	Off	Front operator's panel fault LED flashing or constant	Muted	See Table 4 on page 20 for interpretation of lights and remedy.
	Intermittent short beep (0.5 second beep every 32 seconds)	Various front operator's panel fault light flash states	Fault has occurred and system is muted but in remind mode	Check fault status using ops panel fault LED settings and remedy.
	Slow beep (half second beep every 8 seconds)	Front operator's panel fault LED slow blink (0.5 seconds on, 3.5 seconds off)	Warning mode	See Table 4 on page 20.

Table 11. Light and buzzer interpretations (continued)

LED/buzzer	State	Related	Meaning	Action
	Faster beep (1.5 seconds beep, 0.5 second silence)	Front operator's panel fault LED fast blink (alternating every half second)	Critical mode	See Table 13.
	Constant beep	Front operator's panel fault LED constant on	Failure mode	See Table 4 on page 20.

Troubleshooting

The following sections describe common problems, with possible solutions, which can occur with your Secure Managed Client (SMC) - Storage Array.

For details on how to remove and replace a module see the *Hardware Installation and Replacement Guide*.

System faults

Table 12. System faults

Symptom	Cause	Action
1. Audible alarm sounds	1. Internal fault detected (failure of an internal communications path)	1. Check for other amber LED indications of the power supply units. If there is a PSU error present there may be a communication problem with that PSU. Remove and then re-install the PSU. If the problem persists then change the PSU.

Power supply unit faults

Table 13. Power supply unit faults

Symptom	Cause	Action
1. Front operator's panel unit fault LED amber 2. Audible alarm sounding	1. Any power fault 2. A thermal condition which could cause PSU overheating	1. Check that the AC main connection to PSU is live 2. Disconnect the PSU from main power and remove the PSU from the power supply cage. Re-install. If problem persists, replace PSU. 3. Reduce the ambient temperature

Cooling fan faults

Table 14. Cooling fan faults

Symptom	Cause	Action
<ol style="list-style-type: none"> 1. Front panel fault LED amber 2. Audible alarm sounding 3. Fan LED is illuminated 	<ol style="list-style-type: none"> 1. Any power fault 2. A fan failure 	<ol style="list-style-type: none"> 1. Check to ensure DC power to cooling fans is correct and that the LED is not illuminated 2. Disconnect the PSU from main power and remove the faulty fan from the system. Re-install. If problem persists, replace PSU. 3. Reduce the ambient temperature

Thermal cooling

The Secure Managed Client (SMC) - Storage Array uses extensive thermal monitoring to ensure component temperatures are kept low and acoustic noise is minimized. Airflow is from front to rear of the enclosure.

Table 15. Thermal cooling

Symptom	Cause	Action
<p>If the ambient air is cool (below 25°C or 77°F) and the fans are observed to increase in speed then some restriction on airflow may be causing an additional internal temperature rise.</p> <p>Note: This is not a fault condition.</p>	<p>The first stage in the thermal control process is for the fans to automatically increase in speed when a thermal threshold is reached. This may be caused by higher ambient temperatures in the local environment and may be perfectly normal.</p> <p>Note: This threshold changes according to the number of drives and power supplies installed.</p>	<ol style="list-style-type: none"> 1. Check the installation for any airflow restrictions at either the front or rear of the enclosure. A minimum gap of 2.5 cm (1 inch) at the front and 5 cm (2 inches) at the rear is recommended. 2. Check for restrictions due to dust build up; clean as appropriate. 3. Check for excessive re-circulation of heated air from rear to front. Use in a fully enclosed rack installation is not recommended. 4. Check that all blank modules are in place. 5. Reduce the ambient temperature.

Table 15. Thermal cooling (continued)

Symptom	Cause	Action
<ol style="list-style-type: none"> 1. Front operator's panel unit fault LED amber. 2. An amber LED is lit on one or more PSUs. 	<p>If the internal temperature measured in the airflow through the enclosure exceeds a pre-set threshold, a thermal alarm sound.</p>	<ol style="list-style-type: none"> 1. Check to ensure that local ambient environment temperature is below the upper 35°C (95°F) specification. 2. Check the installation for any airflow restrictions at either the front or rear of the enclosure. A minimum gap of 2.5 cm (1 inch) at the front and 5 cm (2 inches) mm at the rear is recommended. 3. Check for restrictions due to dust build up; clean as appropriate. 4. Check for excessive re-circulation of heated air from rear to front. Use in a fully enclosed rack installation is not recommended. 5. If possible, turn off the enclosure and investigate the problem before continuing.

Drive carrier module faults

Each Drive Carrier module has two LEDs: an upper (green) LED and a lower (amber) LED.

- Under normal operation, the green LED is on and will flicker as the drive operates
- Under normal operation, the amber LED will be:
 - Off if there is no drive present
 - Off as the drive operates
 - On if a drive fault is present

Dealing with hardware faults

Ensure that you have obtained a replacement module of the same type before removing any faulty module.

- If the subsystem is powered up and you remove any module, replace it immediately. If the subsystem is used with modules or module blanks missing for more than a few minutes, the enclosure can overheat, causing power failure and data loss. Such use will invalidate the warranty.
- Replace a faulty drive with a drive of the same type and equal or greater capacity.
- Refer to your vendor-supplied documentation when using storage software for handling drive-related hardware faults.
- All drive bays must be installed with a drive carrier module in order to maintain a balanced airflow.
- All the supplied plug-in power supply units, electronics modules and blank modules must be in place for the air to flow correctly around the cabinet

CAUTION:

Observe all conventional ESD precautions when handling modules and components. Avoid contact with backplane components and module connectors, etc.

Note: The top cover of the enclosure covers a service area which should be accessed only by qualified service personnel. When the cover is replaced it must be secured by turning the lock mechanism to the locked position.

Continuous operation during replacement

Depending on how the enclosure system is set up, if a disk unit fails, it can normally be replaced without interrupting the use of the system.

Chapter 6. Notices

Lenovo may not offer the products, services, or features discussed in this document in all countries. Consult your local Lenovo representative for information on the products and services currently available in your area. Any reference to an Lenovo product, program, or service is not intended to state or imply that only that Lenovo product, program, or service may be used. Any functionally equivalent product, program, or service that does not infringe any Lenovo intellectual property right may be used instead. However, it is the user's responsibility to evaluate and verify the operation of any other product, program, or service.

Lenovo may have patents or pending patent applications covering subject matter described in this document. The furnishing of this document does not give you any license to these patents. You can send license inquiries, in writing, to:

*Lenovo (United States), Inc
1009 Think Place
Building One
Morrisville, NC 27560
USA
Attention: Lenovo Director of Licensing*

LENOVO GROUP LTD. PROVIDES THIS PUBLICATION "AS IS" WITHOUT WARRANTY OF ANY KIND, EITHER EXPRESS OR IMPLIED, INCLUDING, BUT NOT LIMITED TO, THE IMPLIED WARRANTIES OF NON-INFRINGEMENT, MERCHANTABILITY OR FITNESS FOR A PARTICULAR PURPOSE. Some jurisdictions do not allow disclaimer of express or implied warranties in certain transactions, therefore, this statement may not apply to you.

This information could include technical inaccuracies or typographical errors. Changes are periodically made to the information herein; these changes will be incorporated in new editions of the publication. Lenovo may make improvements and/or changes in the product(s) and/or the program(s) described in this publication at any time without notice.

The products described in this document are not intended for use in implantation or other life support applications where malfunction may result in injury or death to persons. The information contained in this document does not affect or change Lenovo product specifications or warranties. Nothing in this document shall operate as an express or implied license or indemnity under the intellectual property rights of Lenovo or third parties. All information contained in this document was obtained in specific environments and is presented as an illustration. The result obtained in other operating environments may vary.

Lenovo may use or distribute any of the information you supply in any way it believes appropriate without incurring any obligation to you.

Any references in this publication to non-Lenovo Web sites are provided for convenience only and do not in any manner serve as an endorsement of those Web sites. The materials at those Web sites are not part of the materials for this Lenovo product, and use of those Web sites is at your own risk.

Any performance data contained herein was determined in a controlled environment. Therefore, the result in other operating environments may vary significantly. Some measurements may have been made on development-level systems and there is no guarantee that these measurements will be the same on generally available systems. Furthermore, some measurements may have been estimated through extrapolation. Actual results may vary. Users of this document should verify the applicable data for their specific environment.

Trademarks

The following terms are trademarks of Lenovo in the United States, other countries, or both:

Lenovo
the Lenovo logo

Microsoft, Windows, Windows Vista, and Active Directory are trademarks or registered trademarks of Microsoft Corporation in the United States, other countries, or both.

Other company, product, or service names may be trademarks or service marks of others.

lenovo®

Part Number: 45K1342

Printed in USA

(1P) P/N: 45K1342



Free Manuals Download Website

<http://myh66.com>

<http://usermanuals.us>

<http://www.somanuals.com>

<http://www.4manuals.cc>

<http://www.manual-lib.com>

<http://www.404manual.com>

<http://www.luxmanual.com>

<http://aubethermostatmanual.com>

Golf course search by state

<http://golfingnear.com>

Email search by domain

<http://emailbydomain.com>

Auto manuals search

<http://auto.somanuals.com>

TV manuals search

<http://tv.somanuals.com>