

LANTRONIX®



EDS-MD™ User Guide

- ◆ EDS-MD4
- ◆ EDS-MD8
- ◆ EDS-MD16

Part Number 900-591
Revision D November 2011

Copyright & Trademark

© 2011 Lantronix. All rights reserved. No part of the contents of this book may be transmitted or reproduced in any form or by any means without the written permission of Lantronix. Printed in the United States of America.

Ethernet is a trademark of XEROX Corporation. Windows is a trademark of Microsoft Corporation. Linux is a registered trademark of Linus Torvalds.

Warranty

For details on the Lantronix warranty replacement policy, please go to our web site at www.lantronix.com/support/warranty.

Contacts

Lantronix Corporate Headquarters

167 Technology Drive
Irvine, CA 92618, USA

Phone: 949-453-3990
Fax: 949-450-7249

Technical Support

Online: www.lantronix.com/support

Sales Offices

For a current list of our domestic and international sales offices, go to the Lantronix web site at www.lantronix.com/about/contact.

Disclaimer

The information in this guide may change without notice. The manufacturer assumes no responsibility for any errors that may appear in this guide.

Revision History

Date	Rev.	Comments
September 2011	A	Initial Document for firmware release 7.2.0.0.
October 2011	B	Updated power cord part number information.
November 2011	C	Updated ethernet port information and cover product image.
November 2011	D	Added Suppliers Declaration of Conformity document.

Table of Contents

Copyright & Trademark	2
Warranty	2
Contacts	2
Disclaimer	2
Revision History	2
List of Figures	12
List of Tables	13
1: Using This Guide	15
Purpose and Audience	15
Summary of Chapters	15
Safety Information	16
Cover	16
Power Plug	16
Input Supply	16
Grounding	16
Fuses	16
Battery	17
Wall Mounting	17
Port Connections	17
Equipment Classifications	18
Environmental Conditions for Transportation and Storage	18
Cleaning Instructions	18
Electromagnetic Interference	18
Additional Documentation	19
2: Introduction	20
Key Features	20
Applications	20
Protocol Support	20
Troubleshooting Capabilities	21
Configuration Methods	21
Addresses and Port Numbers	21
Hardware Address	21
IP Address	21
Port Numbers	22
Product Information Label	22

3: Installation of EDS-MD4/8/16 Device Servers	23
Package Contents _____	23
User-Supplied Items _____	23
Identifying Hardware Components _____	23
Serial Ports _____	24
Ethernet Port _____	24
LEDs _____	24
Reset to Default Button _____	25
To restore factory default settings: _____	25
Technical Specification _____	26
Installing the EDS-MD _____	27
Finding a Suitable Location _____	27
Connect the EDS-MD to one or more serial devices _____	27
4: Using DeviceInstaller	28
Accessing EDS-MD Using DeviceInstaller _____	28
Device Detail Summary _____	28
5: Configuration Using Web Manager	30
Accessing Web Manager _____	30
Device Status Page _____	31
Web Manager Page Components _____	32
Navigating the Web Manager _____	33
6: Line and Tunnel Settings	35
RS232/RS485 _____	35
Line Settings _____	35
To Configure Line Settings _____	36
Using Web Manager _____	36
Using the CLI _____	36
Using XML _____	36
To View Line Statistics _____	36
Using Web Manager _____	36
Using the CLI _____	37
Using XML _____	37
Tunnel Settings _____	37
Serial Settings _____	37
To Configure Tunnel Serial Settings _____	37
Using Web Manager _____	37
Using the CLI _____	38
Using XML _____	38
Packing Mode _____	38

To Configure Tunnel Packing Mode Settings	38
Using Web Manager	38
Using the CLI	39
Using XML	39
Accept Mode	39
To Configure Tunnel Accept Mode Settings	40
Using Web Manager	40
Using the CLI	40
Using XML	40
Connect Mode	41
To Configure Tunnel Connect Mode Settings	42
Using Web Manager	42
Using the CLI	42
Using XML	42
Disconnect Mode	42
To Configure Tunnel Disconnect Mode Settings	43
Using Web Manager	43
Using the CLI	43
Using XML	43
Modem Emulation	43
To Configure Tunnel Modem Emulation Settings	44
Using Web Manager	44
Using the CLI	44
Using XML	44
Statistics	44
To View Tunnel Statistics	44
Using Web Manager	44
Using the CLI	45
Using XML	45

7: Network Settings **46**

Network Interface Settings	46
To Configure Network Interface Settings	47
Using Web Manager	47
Using the CLI	47
Using XML	47
To View Network Interface Status	47
Using Web Manager	47
Network Link Settings	48
To Configure Network Link Settings	48
Using Web Manager	48
Using the CLI	48
Using XML	48

8: Terminal and Host Settings 49

Terminal Settings	49
To Configure the Terminal Network Connection	50
Using Web Manager	50
Using the CLI	50
Using XML	50
To Configure the Terminal Line Connection	50
Using Web Manager	50
Using the CLI	50
Using XML	50
Host Configuration	50
To Configure Host Settings	51
Using Web Manager	51
Using the CLI	51
Using XML	51

9: Services Settings 52

DNS Settings	52
To View or Configure DNS Settings:	52
Using Web Manager	52
Using the CLI	52
Using XML	52
FTP Settings	53
To Configure FTP Settings	53
Using Web Manager	53
Using the CLI	53
Using XML	53
Syslog Settings	53
To View or Configure Syslog Settings:	54
Using Web Manager	54
Using the CLI	54
Using XML	54
HTTP Settings	54
To Configure HTTP Settings	55
Using Web Manager	55
Using the CLI	55
Using XML	55
To Configure HTTP Authentication	56
Using Web Manager	56
Using the CLI	56
Using XML	56
RSS Settings	56

To Configure RSS Settings	56
Using Web Manager	56
Using the CLI	57
Using XML	57
Real Time Clock (RTC) Settings	57
To Configure RTC Settings	57
Using Web Manager	57
Using the CLI	57
Using XML	57

10: Security Settings **58**

SSH Settings	58
SSH Server Host Keys	58
SSH Client Known Hosts	59
SSH Server Authorized Users	59
SSH Client Users	60
To Configure SSH Settings	61
Using Web Manager	61
Using the CLI	61
Using XML	61
SSL Settings	61
Certificate and Key Generation	62
To Create a New Credential	62
Using Web Manager	62
Using the CLI	62
Using XML	63
Certificate Upload Settings	63
To Configure an Existing SSL Credential	63
Using Web Manager	63
Using the CLI	63
Using XML	63
Trusted Authorities	64
To Upload an Authority Certificate	64
Using Web Manager	64
Using the CLI	64
Using XML	64

11: Maintenance and Diagnostics Settings **65**

Filesystem Settings	65
File Display	65
To Display Files	65
Using Web Manager	65
Using the CLI	65

Using XML	65
File Modification	66
File Transfer	66
To Transfer or Modify Filesystem Files	67
Using Web Manager	67
Using the CLI	67
Using XML	67
IP Network Stack Settings	67
To Configure IP Network Stack Settings	67
Using Web Manager	67
Using the CLI	67
Using XML	67
To Configure ICMP Network Stack Settings	68
Using Web Manager	68
Using the CLI	68
Using XML	68
To Configure ARP Network Stack Settings	68
Using Web Manager	68
Using the CLI	68
Using XML	68
To Configure SMTP Network Stack Settings	69
Using Web Manager	69
Using the CLI	69
Using XML	69
Query Port	69
To Configure Query Port Settings	69
Using Web Manager	69
Using the CLI	69
Using XML	70
Diagnostics	70
Hardware	70
To View Hardware Information	70
Using Web Manager	70
Using the CLI	70
Using XML	70
IP Sockets	70
To View the List of IP Sockets	70
Using Web Manager	70
Using the CLI	70
Using XML	70
Ping	70
To Ping a Remote Host	71
Using Web Manager	71

Using the CLI _____	71
Using XML _____	71
Traceroute _____	71
To Perform a Traceroute _____	71
Using Web Manager _____	71
Using the CLI _____	71
Using XML _____	71
Log _____	72
To Configure the Diagnostic Log Output _____	72
Using Web Manager _____	72
Using the CLI _____	72
Using XML _____	72
Memory _____	72
To View Memory Usage _____	72
Using Web Manager _____	72
Using the CLI _____	72
Using XML _____	72
Processes _____	73
To View Process Information _____	73
Using Web Manager _____	73
Using the CLI _____	73
Using XML _____	73
Threads _____	73
To View Thread Information _____	73
Using Web Manager _____	73
Using the CLI _____	73
Using XML _____	73
System Settings _____	74
To Reboot or Restore Factory Defaults _____	74
Using Web Manager _____	74
Using the CLI _____	74
Using XML _____	74

12: Advanced Settings 75

Email Settings _____	75
To View, Configure and Send Email _____	75
Using Web Manager _____	75
Using the CLI _____	76
Using XML _____	76
Command Line Interface Settings _____	76
Basic CLI Settings _____	76
To View and Configure Basic CLI Settings _____	76
Using Web Manager _____	76

Using the CLI	76
Using XML	76
Telnet Settings	77
To Configure Telnet Settings	77
Using Web Manager	77
Using the CLI	77
Using XML	77
SSH Settings	77
To Configure SSH Settings	78
Using Web Manager	78
Using the CLI	78
Using XML	78
XML Settings	78
XML: Export Configuration	78
To Export Configuration in XML Format	79
Using Web Manager	79
Using the CLI	79
Using XML	79
XML: Export Status	79
To Export in XML Format	79
Using Web Manager	79
Using the CLI	79
Using XML	80
XML: Import Configuration	80
Import Configuration from External File	80
Import Configuration from the Filesystem	80
To Import Configuration in XML Format	80
Using Web Manager	80
Using the CLI	80
Using XML	80

13: Updating Firmware **81**

Obtaining Firmware	81
Loading New Firmware	81

14: VIP Settings **82**

Virtual IP (VIP) Configuration	82
To Configure VIP Settings	82
Using Web Manager	82
Using the CLI	82
Using XML	82
Virtual IP (VIP) Status	82
To View VIP Status	82

Using Web Manager	82
Using the CLI	82
Using XML	83
Virtual IP (VIP) Counters	83
To View VIP Counters	83
Using Web Manager	83
Using the CLI	83
Using XML	83
15: Branding the EDS-MD4/8/16	84
Web Manager Customization	84
Short and Long Name Customization	85
To Customize Short or Long Names	85
Using Web Manager	85
Using the CLI	85
Using XML	85
Appendix A: Technical Support	86
Appendix B: Binary to Hexadecimal Conversions	87
Converting Binary to Hexadecimal	87
Conversion Table	87
Scientific Calculator	87
Appendix C: Compliance	89
Appendix D: Lantronix Cables, Adapters and Serial Port Pinouts	93
Cables and Adapters	93
Adapters and Serial Port Pinouts	94

List of Figures

Figure 2-1 EDS-MD Product Label _____	22
Figure 3-1 Front View of the EDS-MD16 _____	24
Figure 3-2 Back View of the EDS-MD4, EDS-MD8 and EDS-MD16 _____	24
Figure 5-1 Components of the Web Manager Page _____	32
Figure 17-2 Windows Scientific Calculator _____	88
Figure 17-3 Hexadecimal Values in the Scientific Calculator _____	88
Figure 18-4 Suppliers Declaration of Conformity _____	91
Figure 19-2 RJ45 Receptacle to DB25M DTE Adapter (PN 200.2066A) _____	94
Figure 19-3 RJ45 Receptacle to DB25M DCE Adapter (PN 200.2073) _____	94
Figure 19-4 RJ45 Receptacle to DB25F DTE Adapter (PN 200.2067A) _____	95
Figure 19-5 RJ45 Receptacle to DB25F DCE Adapter (PN 200.2074) _____	95
Figure 19-6 RJ45 Receptacle to DB9M DTE Adapter (PN 200.2069A) _____	96
Figure 19-7 RJ45 Receptacle to DB9M DCE Adapter (PN 200.2071) _____	96
Figure 19-8 RJ45 Receptacle to DB9F DTE Adapter (PN 200.2070A) _____	97
Figure 19-9 RJ45 Receptacle to DB9F DCE Adapter (PN 200.2072) _____	97
Figure 19-10 RJ45 to RJ45 Adapter (ADP010104-01) _____	98

List of Tables

Table 3-3 System LEDs on the Top of EDS-MD	24
Table 3-4 Serial Indicator LEDs on the Top of EDS-MD	25
Table 3-5 RJ45 LEDs on the Back Panel (Ethernet Indicators).	25
Table 6-1 Line Configuration Settings	35
Table 6-2 Line Command Mode Settings	36
Table 6-3 Tunnel Serial Settings	37
Table 6-4 Tunnel Packing Mode Settings	38
Table 6-5 Tunnel Accept Mode Settings	39
Table 6-6 Tunnel Connect Mode Settings	41
Table 6-7 Tunnel Disconnect Mode Settings	42
Table 6-8 Tunnel Modem Emulation Settings	43
Table 7-1 Network Interface Settings	46
Table 7-2 Network 1 (eth0) Link Settings	48
Table 8-1 Terminal on Network and Line Settings	49
Table 8-2 Host Configuration	50
Table 9-1 DNS Settings	52
Table 9-2 FTP Settings	53
Table 9-3 Syslog Settings	53
Table 9-4 HTTP Settings	54
Table 9-5 HTTP Authentication Settings	55
Table 9-6 RSS Settings	56
Table 9-7 RTC Settings	57
Table 10-1 SSH Server Host Keys	58
Table 10-2 SSH Client Known Hosts	59
Table 10-3 SSH Server Authorized Users	60
Table 10-4 SSH Client Users	60
Table 10-5 Certificate and Key Generation Settings	62
Table 10-6 Upload Certificate Settings	63
Table 10-7 Trusted Authority Settings	64
Table 11-1 File Display Settings	65
Table 11-2 File Modification Settings	66
Table 11-3 File Transfer Settings	66
Table 11-4 IP Network Stack Settings	67
Table 11-5 ICMP Network Stack Settings	68
Table 11-6 ARP Network Stack Settings	68
Table 11-7 SMTP Network Stack Settings	69

Table 11-8 Query Port Settings	69
Table 11-9 Ping Settings	71
Table 11-10 Traceroute Settings	71
Table 11-11 Log Settings	72
Table 11-12 System Settings	74
Table 12-1 Email Configuration	75
Table 12-2 CLI Configuration Settings	76
Table 12-3 Telnet Settings	77
Table 12-4 SSH Settings	77
Table 12-5 XML Exporting Configuration	78
Table 12-6 Exporting Status	79
Table 12-7 Import Configuration from Filesystem Settings	80
Table 14-1 VIP Configuration	82
Table 14-2 VIP Counters	83
Table 15-1 Short and Long Name Settings	85
Table 17-1 Binary to Hexadecimal Conversion	87
Table 18-1 Applicable Medical Standards	89
Table 18-2 Applicable ITE Standards	89
Table 18-3 Regulatory Compliance	90
Table 19-1 Lantronix Cables and Adapters	93

1: Using This Guide

Purpose and Audience

This guide provides the information needed to configure, use, and update the EDS-MD4, EDS-MD8 and EDS-MD16. It is intended for system integrators who are installing this product into their designs.

Note: EDS-MD device servers (which include models EDS-MD4, EDS-MD8 and EDSMD16) are commonly referred to as either EDS-MD4/8/16 or as EDS-MD when mentioned within a description equally applicable to any of the three models.

Summary of Chapters

The remaining chapters in this guide include:

Chapter	Description
2: Introduction	Main features of the product and the protocols it supports. Includes technical specifications.
3: Installation of EDS-MD4/8/16 Device Servers	Instructions for installing the EDS-MD.
4: Using DeviceInstaller	Instructions for viewing the current configuration using DeviceInstaller.
5: Configuration Using Web Manager	Instructions for accessing Web Manager and using it to configure settings for the device.
7: Network Settings	Instructions for configuring network settings.
6: Line and Tunnel Settings	Instructions for configuring line and tunnel settings.
8: Terminal and Host Settings	Instructions for configuring terminal and host settings.
9: Services Settings	Instructions for configuring DNS, FTP, HTTP and Syslog settings.
10: Security Settings	Instructions for configuring SSL security settings.
11: Maintenance and Diagnostics Settings	Instructions to maintain the EDS-MD, view statistics, files, and diagnose problems.
12: Advanced Settings	Instructions for configuring email, CLI and XML settings.
13: Updating Firmware	Instructions for obtaining the latest firmware and updating the EDS-MD.
14: VIP Settings	Information about Virtual IP (VIP) features available on the device and instructions on configuring settings.
15: Branding the EDS-MD4/8/16	Instructions on how to brand your device.
Appendix A: Technical Support	Instructions for contacting Lantronix Technical Support.
Appendix B: Binary to Hexadecimal Conversions	Instructions for converting binary values to hexadecimals.
Appendix C: Compliance	Lantronix compliance information.
Appendix D: Lantronix Cables, Adapters and Serial Port Pinouts	Information about the device driver for windows host.

Safety Information

This section describes the safety precautions that should be followed when installing and operating the EDS-MD.

Warning: *This equipment is not suitable for use in the presence of a flammable anaesthetic mixture including air, oxygen or nitrous oxide.*

Cover



Warning: *Do not remove the cover of the EDS-MD. There are no user-serviceable parts inside. Opening or removing the cover may expose you to dangerous voltage that could cause fire or electric shock. Do not operate the EDS-MD if the housing is broken.*

Note: *Refer all servicing to Lantronix.*

Power Plug

- ◆ When disconnecting the power cable from the socket, pull on the plug, not the cord.
- ◆ Always connect the power cord to a properly wired and grounded power source. Do not use adapter plugs or remove the grounding prong from the cord.
- ◆ Only use a power cord with a voltage and current rating greater than the voltage and current rating marked on the unit.

Note: *Unit is shipped with a power cord for medical application.*

- ◆ Install the unit near an AC outlet that is easily accessible.
- ◆ Always connect any equipment used with the product to properly wired and grounded power sources.
- ◆ To help protect the product from sudden, transient increases and decreases in electrical power, use a surge suppressor, line conditioner, or uninterruptible power supply (UPS).
- ◆ Do not connect or disconnect this product during an electrical storm.

Input Supply

- ◆ Check nameplate ratings to assure there is no overloading of supply circuits that could affect over current protection and supply wiring.

Grounding

- ◆ Maintain reliable grounding of this product.
- ◆ Pay particular attention to supply connections when connecting to power strips, rather than directly to the branch circuit.

Fuses

There are fuses on the internal power supply serviceable only by Lantronix.

Battery

A Lithium battery cell inside the unit maintains the unit's date and time when the device is powered off. **Do not attempt to replace it.** The battery is serviceable only by Lantronix.

Caution: *DANGER OF EXPLOSION IF BATTERY IS INCORRECTLY REPLACED. REPLACE ONLY WITH THE SAME OR EQUIVALENT TYPE RECOMMENDED BY THE MANUFACTURER. DISPOSE OF USED BATTERIES ACCORDING TO THE MANUFACTURER'S INSTRUCTIONS.*

Attention: *IL Y A DANGER D'EXPLOSION S'IL Y A REMPLACEMENT INCORRECT DE LA BATTERIE, REMPLACER UNIQUEMENT AVEC UNE BATTERIE DU MÊME TYPE OU D'UN TYPE ÉQUIVALENT RECOMMANDÉ PAR LE CONSTRUCTEUR. METTRE AU REBUT LES BATTERIES USAGÉES CONFORMÉMENT AUX INSTRUCTIONS DU FABRICANT.*

Wall Mounting

If wall-mounted units are installed, the following items must be considered:

- ◆ Do not install the unit in such a way that a hazardous stability condition results because of uneven loading. A drop or fall could cause injury.
- ◆ Make sure to install the EDS-MD in an environment with an ambient temperature less than the maximum operating temperature of the EDS-MD. Therefore, consideration should be given to installing the equipment in an environment compatible with the maximum ambient temperature (T_{ma}) specified by the manufacturer.
- ◆ Install the equipment on a wall in such a way that the amount of airflow required for safe operation of the equipment is not compromised.
- ◆ Maintain reliable earthing of wall-mounted equipment. Give particular attention to supply connections other than direct connections to the branch circuit (e.g. use of power strips) because of the effect that overloading of the circuits might have on overcurrent protection and supply wiring. Appropriate consideration of equipment nameplate ratings should be used when addressing this concern.
- ◆ Before operating the EDS-MD, make sure the EDS-MD mounting is secured.

Port Connections

- ◆ Only connect the network port to an Ethernet network that supports 10 Base-T/100 Base-TX/1000 Base-T.
- ◆ Only connect device ports to equipment with serial ports that support EIA-232 (formerly RS-232C).
- ◆ Unless specified otherwise, only connect USB ports to USB thumb drives.

Warning: *To avoid overloading and overheating, do not use a USB port as a charger port or a power port for other devices such as a cellular phone, PDA device, disk drive, etc.*

Equipment Classifications

- ◆ Classification according to the type of protection against electric shock: Class I Equipment
- ◆ Classification according to the degree of protection against electric shock: No Applied Parts
- ◆ Classification according to the degree of protection against ingress of water: IP20
- ◆ Classification according to the mode of operation: Continuous Operation

Environmental Conditions for Transportation and Storage

- ◆ An ambient temperature range of -30°C to +80°C
- ◆ A relative humidity range of 0% to 95%, noncondensing
- ◆ An atmospheric pressure range of 50 kPa to 106 kPa

Cleaning Instructions

1. Disconnect all cables and unplug ac power from the device.
2. Prepare a disinfectant solution using 1 part bleach mixed with 9 parts water.
3. Lightly moisten a tissue with the mild detergent and wipe down only the outside of the device.
4. Allow the device to air-dry or wipe dry with a clean dry tissue before use.

Caution: *To avoid electric shock and for the device to work properly, do not allow cleaning solution get inside the device, specifically the interface port connectors or the ac inlet. Do not immerse the device in any liquid.*

Electromagnetic Interference

This equipment has been tested and found to comply with the EMC limits for the Medical Device Directive 93/42/EEC (EN 55022 Class A and EN 60601-1-2). These limits are designed to provide reasonable protection against harmful interference in a typical medical installation. The equipment generates, uses and can radiate radio frequency energy and, if not installed and used in accordance with these instructions, may cause harmful interference to other devices in the vicinity. However, there is no guarantee that interference will not occur in a particular installation. If this equipment does cause harmful interference with other devices, which can be determined by turning the equipment off and on, the user is encouraged to try to correct the interference by one or more of the following measures:

- ◆ Reorient or relocate the receiving device
- ◆ Increase the separation between the equipment
- ◆ Connect the equipment into an outlet on a circuit different from that to which the other device(s) is connected
- ◆ Consult the manufacturer or field service technician for help

Additional Documentation

Visit the Lantronix Web site at www.lantronix.com/support/documentation for the latest documentation and the following additional documentation.

Document	Description
EDS-MD Command Reference	Instructions for accessing Command Mode (the command line interface) using a Telnet connection, SSH connection or through the serial port. Detailed information about the commands. Also provides details for XML configuration and status.
EDS-MD Quick Start Guide	Instructions for getting the EDS-MD up and running.
DeviceInstaller Online Help	Instructions for using the Lantronix Windows-based utility to locate the EDS-MD and to view its current settings.
Com Port Redirector Quick Start and Online Help	Instructions for using the Lantronix Windows-based utility to create virtual com ports.
Secure Com Port Redirector User Guide	Instructions for using the Lantronix Windows-based utility to create secure virtual com ports.

2: Introduction

The EDS-MD4, EDS-MD8 and EDS-MD16 Ethernet Device Servers are complete network-enabling solutions. This device server allows system integrators and administrators to go to market quickly and easily with Ethernet networking and web server capabilities. EDS-MD models are available in 4, 8 and 16 port configurations.

Key Features

- ◆ **Power Supply:** Direct plug-in to wall ac with universal 100-240 VAC input
- ◆ **Controller:** 32-bit ARM11 microprocessor running at 600 megahertz (Mhz)
- ◆ **Memory:** 64 megabit Flash, 2 gigabit DDR2 DRAM, and a 4 gigabyte SDHC card (internal only-not user replaceable).
- ◆ **Ethernet:** Gigabit Ethernet support (10/100/1000Base-T) speed auto-sensing, automatic MDI/MDIX (straight and cross-over cables are OK to use)
- ◆ **Serial Ports:** 4 to 16 ports depending on model (EDS-MD4, EDS-MD8 or EDS-MD16), electrically isolated from one another and other circuits. Hardware/Software handshaking capability. Custom/standard baud rates up to 921600 bits per second (bps).
- ◆ **USB ports:** 2 ports of fixed full-speed 2.0 USB Host, electrically isolated from one another and other circuits, capable of providing 0.5A each.
- ◆ **Temperature Range:** 0°C to +55°C.

Applications

The EDS-MD4/8/16 device server connects serial devices such as those listed below to Ethernet networks using the IP protocol family.

- ◆ Patient Monitoring Devices
- ◆ Glucose Analyzers
- ◆ Infusion Pumps

Protocol Support

The EDS-MD4/8/16 device server contains a full-featured IP stack. Supported protocols include:

- ◆ ARP, UDP, TCP, ICMP, DHCP, Auto IP, Telnet, SMTP, DNS, FTP, TFTP, and Syslog for network communications and management.
- ◆ TCP, UDP and tunneling to the serial port.
- ◆ TFTP for uploading/downloading files.
- ◆ FTP, SFTP, HTTPS and HTTP for firmware upgrades and uploading/downloading files.

Troubleshooting Capabilities

The EDS-MD4/8/16 offers a comprehensive diagnostic toolset that lets you troubleshoot problems quickly and easily. Available from the CLI or Web Manager, the diagnostic tools let you:

- ◆ View memory and IP socket information.
- ◆ Perform ping and traceroute operations.
- ◆ Conduct forward or reverse DNS lookup operations.
- ◆ View all processes currently running on the EDS-MD, including CPU utilization.
- ◆ View system log messages.

Configuration Methods

After installation, the EDS-MD4/8/16 requires configuration. For the unit to operate correctly on a network, it must have a unique IP address on the network. There are four basic methods for logging into the EDS-MD4/8/16 and assigning IP addresses and other configurable settings:

Web Manager: View and configure all settings easily through a web browser using the Lantronix Web Manager. (See [“Configuration Using Web Manager” on page 30.](#))

DeviceInstaller: Configure the IP address and related settings and view current settings on the EDS-MD4, EDS-MD8 and EDS-MD16 using a Graphical User Interface (GUI) on a PC attached to a network. (See [“Using DeviceInstaller” on page 28.](#))

Command Mode: There are two methods for accessing Command Mode (CLI): making a Telnet or SSH connection, or connecting a terminal (or a PC running a terminal emulation program) to the unit’s serial port. (See the *EDS-MD4 Command Reference Guide* for instructions and available commands.)

XML: The EDS-MD4/8/16 supports XML-based configuration and setup records that make device configuration transparent to users and administrators. XML is easily editable with a standard text or XML editor. (See the *EDS-MD Command Reference Guide* for instructions and commands.)

Addresses and Port Numbers

Hardware Address

The hardware address is also referred to as the Ethernet address, physical address, or MAC address. Sample hardware address:

- ◆ 00-20-4A-14-01-18
- ◆ 00:20:4A:14:01:18

IP Address

Every device connected to an IP network must have a unique IP address. This address references the specific unit.

Port Numbers

Every TCP connection and every UDP datagram is defined by a destination and source IP address, and a destination and source port number. For example, a Telnet server commonly uses TCP port number 23.

The following is a list of the default server port numbers running on the EDS-MD4/8/16:

- ◆ TCP Port 22: SSH Server (Command Mode configuration)
- ◆ TCP Port 23: Telnet Server (Command Mode configuration)
- ◆ TCP Port 80: HTTP (Web Manager configuration)
- ◆ TCP Port 21: FTP
- ◆ UDP Port 30718: LDP (Lantronix Discovery Protocol) port
- ◆ TCP/UDP Port 10001: Tunnel 1

Note: Additional TCP/UDP ports and tunnels will be available, depending on the product type. The default numbering of each additional TCP/UDP port and corresponding tunnel will increase sequentially (i.e., TCP/UDP Port 1000X: Tunnel X).

Product Information Label

The product information label on the unit contains the following information about the specific unit:

- ◆ Bar code
- ◆ Product Revision
- ◆ Part Number
- ◆ Serial Number (MAC Address)
- ◆ Manufacturing Date Code

Note: The hardware address on the label is also the product serial number. The hardware address on the label is the address for the Ethernet (eth0) interface.

Figure 2-1 EDS-MD Product Label



3: Installation of EDS-MD4/8/16 Device Servers

This chapter describes how to install the EDS-MD4, EDS-MD8 and EDS-MD16 device servers.

Package Contents

Your EDS-MD4/8/16 package includes the following items:

- ◆ One EDS-MD device server (an EDS-MD4, EDS-MD8 or EDS-MD16)
- ◆ One RJ45 CAT 5E cable (part number 500-207-R) for network connection
- ◆ One RJ45 cable loopback adapter (part number 500-153)
- ◆ One power cord
- ◆ EDS-MD Quick Start Guide

User-Supplied Items

To complete your EDS-MD installation, you need the following items:

- ◆ RS-232 serial devices that require network connectivity. Each EDS-MD4/8/16 serial port supports a directly connected RS-232 serial device.
- ◆ A serial cable for each serial device to be connected to the EDS-MD4/8/16. All devices attached to the device ports support the RS-232C (EIA-232) standard. Category 5 cabling with RJ45 connections is used for the device port connections.

Note: To connect an EDS-MD4/8/16 serial port to a DTE device, you need a DTE cable, such as the one supplied in your EDS-MD package, or an RJ45 patch cable and DTE adapter. To connect the EDS-MD4/8/16 serial port to a DCE device, you need a DCE (modem) cable, or an RJ45 patch cable and DCE adapter. For a list of the Lantronix cables and adapters you can use with the EDS-MD, see the [Appendix D: Lantronix Cables, Adapters and Serial Port Pinouts](#) (on page 93).

- ◆ An available connection to your Ethernet network and an Ethernet cable.
- ◆ A working, properly grounded power outlet.

Identifying Hardware Components

[Figure 3-1](#) shows the front of the EDS-MD16. [Figure 3-2](#) shows the back of the EDS-MD4, EDS-MD8 or EDS-MD16.

Figure 3-1 Front View of the EDS-MD16



Note: EDS-MD4 has 4 RJ45 Serial Ports and EDS-MD8 has 8 RJ45 Serial Ports.

Figure 3-2 Back View of the EDS-MD4, EDS-MD8 and EDS-MD16

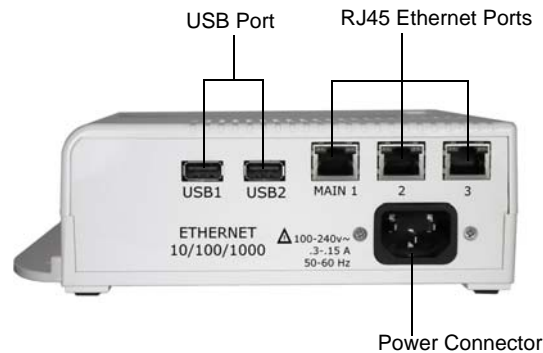

Note: Ethernet ports 2 and 3 will become operational with a future firmware update.

Serial Ports

In the front of the device, the EDS-MD4 has 4 serial ports, the EDS-MD8 has 8 serial ports, and the EDS-MD16 has 16 serial ports. All are configured as DTE and support up to 921600 baud.

Ethernet Port

The back panel of the EDS-MD4/8/16 provides a network interface via the “Main 1” RJ45 port. This port can connect to an Ethernet network at 10/100/1000Base-T. The Speed LED on the back of the EDS-MD shows the connection of the attached Ethernet network. The EDS-MD4/8/16 can be configured to operate at a fixed Ethernet speed and duplex mode (half- or full-duplex). Otherwise by default, the EDS-MD auto-negotiates the connection to the Ethernet network.

LEDs

Light-emitting diodes (LEDs) on the EDS-MD show status information.

- ◆ Each serial port has a corresponding status LED.
- ◆ The Ethernet port LEDs indicate Speed, Activity, Power, and Status.

The tables below describe the LEDs on the EDS-MD4, EDS-MD8 or EDS-MD16.

Table 3-3 System LEDs on the Top of EDS-MD

LED	Description
Steady Green	Unit operational.
Off	Unit powered down or not operational.

Table 3-4 Serial Indicator LEDs on the Top of EDS-MD

LED	Description
Green	Indicates there is a tunnel connection to or from the EDS-MD.
Red	Not supported.
Off	There is no tunnel connection on the serial line.

Note: Number of Serial LEDs correspond with the EDS-MD model number. For instance, EDS-MD4 has 4 LEDs, EDS-MD8 has 8 LEDs, and EDS-MD16 has 16 LEDs.

Table 3-5 RJ45 LEDs on the Back Panel (Ethernet Indicators).

LED	Description
Left LED Green	Connected at 1000 Mbps.
Left LED Amber	Connected at 100 Mbps.
Left LED Off	Connected at 10 Mbps or no link.
Right LED Green (Solid)	Full duplex with no activity
Right LED Green (Blinking)	Full duplex with activity
Right LED Amber (Solid)	Half duplex with no activity.
Right LED Amber (Blinking)	Half duplex with activity.
Right LED Off	No connection.

Reset to Default Button

The EDS-MD can be restored to factory defaults which includes clearing all networking settings. The IP address, gateway and netmask are set to all zeros. The reset-to-default button is located on the side of the housing, accessible with a paper clip or other similar object, through a pin hole.

To restore factory default settings:

1. Power cycle the unit.
2. *During the bootup*, hold down the reset-to-default button for a minimum of 25 seconds.
3. Release the button. The firmware restores factory default settings to the configuration.

Technical Specification

Category	Description
NETWORK INTERFACE	
Ethernet Ports	3 RJ45 10Base-T/100Base-TX/1000Base-T Ethernet ports Auto sensing Automatic MDI/MDI-X crossover Full duplex IEEE 802.3x flow control Half-duplex back pressure flow control
Left LED Indicator	See Table 3-5 .
Right LED Indicator	See Table 3-5 .
Isolation from internal circuit	1.5 KVAC
Isolation from adjacent port	1.5 KVAC
USB INTERFACE	
USB Ports	2 of USB-A Host, USB 2.0, Full Speed only
Output Capability	0.5 A
Isolation from internal circuit	1.5 KVAC
Isolation from adjacent port	1.5 KVAC
SERIAL INTERFACE	
Serial Ports	Options of 4-port, 8-port, 16-port RS232 Serial Ports DTE via RJ45 connectors
Baud rate	Selectable from 300 bps to 921600 bps
Serial Line Formats	Characters: 7 or 8 data bits Stop bits: 1 or 2 Parity: odd, even, none
Modem Control	DTR/DSR
Flow Control	Hardware: CTS/RTS Software: XON/XOFF
Serial LED Indicators	See Table 3-4 .
Protection from ESD	15kV (human body model)
Isolation from internal circuit	1.5 KVAC
Isolation from adjacent port	1.5 KVAC
Reset-to-Default-Parameters Switch	Side panel pin-hole recessed push button switch
POWER RATING	
Power Input AC Connector	IEC60320 C14 receptacle with no power switch
Power Usage	100-240 VAC, 50/60 HZ, 0.4M

Category (continued)	Description
PHYSICALS	
Dimensions	L x W x H = 8.25 x 7.5 x 2.4 in. (21 x 19 x 6 cm)
Weight	16-port = 2.0 lbs (0.9 Kg) 8-port = 1.8 lbs (0.82 Kg) 4-port = 1.75 lbs (0.8 Kg)
Environmental	Temperature Operating 0° to 55°C (32° to 131°F) Temperature for Transportation and Storage -30° to 80°C Humidity 0% to 95% non-condensing Atmospheric Pressure 50 kPa to 105 kPa
Humidity Operating	20% to 90% relative humidity, non-condensing

Installing the EDS-MD

Finding a Suitable Location

- ◆ You can install the EDS-MD4, EDS-MD8 or EDS-MD16 either on a shelf, on a desktop or mounted on the wall.
- ◆ If using AC power, do not use outlets controlled by a wall switch.

Connect the EDS-MD to one or more serial devices

All EDS-MD serial ports support RS-232 devices.

1. Power off the serial devices.
2. Attach a CAT 5 serial cable between the EDS-MD and your serial device. See [Appendix D: Lantronix Cables, Adapters and Serial Port Pinouts \(on page 93\)](#), for a list of cables and adapters you can use.
3. Connect an Ethernet cable between the EDS-MD Ethernet port and your Ethernet network.
4. Insert the power cord into the back of the EDS-MD. Plug the other end into an AC wall outlet.
5. Power up the serial devices.

4: Using DeviceInstaller

This chapter covers the steps for locating a EDS-MD4/8/16 unit and viewing its properties and device details. DeviceInstaller is a free utility program provided by Lantronix that discovers, configures, upgrades and manages Lantronix Device Servers.

Notes:

- ◆ For instructions on using DeviceInstaller to configure the IP address and related settings or for more advanced features, see the DeviceInstaller Online Help.
- ◆ Auto IP generates a random IP address in the range of 169.254.0.1 to 169.254.255.254, with a netmask of 255.255.0.0, if no BOOTP or DHCP server is found. These addresses are not routable.

Accessing EDS-MD Using DeviceInstaller

Note: Make note of the MAC address. It is needed to locate the EDS-MD4/8/16 using DeviceInstaller.

To use the DeviceInstaller utility, first install the latest version from the downloads page on the Lantronix web site www.lantronix.com/downloads.

1. Run the executable to start the installation process and respond to the installation wizard prompts. (If prompted to select an installation type, select **Typical**.)
2. Click **Start -> All Programs -> Lantronix -> DeviceInstaller -> DeviceInstaller**.
3. When DeviceInstaller starts, it will perform a network device search. To perform another search, click **Search**.
4. Expand the EDS-MD4, EDS-MD8 or EDS-MD16 folder by clicking the + symbol next to the folder icon. The list of available Lantronix EDS-MD4/8/16 devices appears.
5. Select the EDS-MD4/8/16 unit by expanding its entry and clicking on its IP address to view its configuration.
6. On the right page, click the **Device Details** tab. The current EDS-MD4/8/16 configuration appears. This is only a subset of the full configuration; the full configuration may be accessed via Web Manager, CLI or XML.

Device Detail Summary

Note: The settings are Display Only in this table unless otherwise noted

Current Settings	Description
Name	Name identifying the EDS-MD.
DHCP Device Name	The name associated with the EDS-MD module's current IP address, if the IP address was obtained dynamically.

Current Settings (continued)	Description
Group	Configurable field. Enter a group to categorize the EDS-MD. Double-click the field, type in the value, and press Enter to complete. This group name is local to this PC and is not visible on other PCs or laptops using DeviceInstaller.
Comments	Configurable field. Enter comments for the EDS-MD. Double-click the field, type in the value, and press Enter to complete. This description or comment is local to this PC and is not visible on other PCs or laptops using DeviceInstaller.
Device Family	Shows the EDS device family type as "EDS".
Type	Shows the device type as "EDS-MD".
ID	Shows the EDS-MD ID embedded within the unit.
Hardware Address	Shows the EDS-MD hardware (MAC) address.
Firmware Version	Shows the firmware currently installed on the EDS-MD.
Extended Firmware Version	Provides additional information on the firmware version.
Online Status	Shows the EDS-MD status as Online, Offline, Unreachable (the EDS-MD is on a different subnet), or Busy (the EDS-MD is currently performing a task).
IP Address	Shows the EDS-MD current IP address. To change the IP address, click the Assign IP button on the DeviceInstaller menu bar.
IP Address was Obtained	<p>Appears "Dynamically" if the EDS-MD automatically received an IP address (e.g., from DHCP). Appears "Statically" if the IP address was configured manually.</p> <p>If the IP address was assigned dynamically, the following fields appear:</p> <ul style="list-style-type: none"> ◆ Obtain via DHCP with values of True or False. ◆ Obtain via BOOTP with values of True or False.
Subnet Mask	Shows the subnet mask specifying the network segment on which the EDS-MD resides.
Gateway	Shows the IP address of the router of this network. There is no default.
Number of Ports	Shows the number of serial ports on this EDS-MD.
Supports Configurable Pins	Shows False, indicating configurable pins are not available on the EDS-MD.
Supports Email Triggers	Shows True, indicating email triggers are available on the EDS-MD.
Telnet Enabled	Indicates whether Telnet is enabled on this EDS-MD.
Telnet Port	Shows the EDS-MD port for Telnet sessions.
Web Enabled	Indicates whether Web Manager access is enabled on this EDS-MD.
Web Port	Shows the EDS-MD port for Web Manager configuration (if Web Enabled field is True).
Firmware Upgradable	Shows True, indicating the EDS-MD firmware is upgradable as newer versions become available.

5: Configuration Using Web Manager

This chapter describes how to configure the EDS-MD4, EDS-MD8 and EDS-MD16 using Web Manager, the Lantronix browser-based configuration tool. The unit's configuration is stored in nonvolatile memory and is retained without power. All changes take effect immediately, unless otherwise noted. It contains the following sections:

- ◆ [Accessing Web Manager](#)
- ◆ [Web Manager Page Components](#)
- ◆ [Navigating the Web Manager](#)

Accessing Web Manager

Note: You can also access the Web Manager by selecting the Web Configuration tab on the DeviceInstaller window.

To access Web Manager, perform the following steps:

1. Open a standard web browser. Lantronix supports the latest version of Internet Explorer, Mozilla Suite, Mozilla Firefox, Safari, Chrome or Opera.
2. Enter the IP address of the EDS-MD4/8/16 in the address bar. The IP address may have been assigned manually using DeviceInstaller (see the *EDS-MD Quick Start Guide*) or automatically by DHCP.
3. Enter your username and password. The factory-default username is "admin" and the password is "PASS." The Device Status web page displays configuration, network settings, line settings, tunneling settings, and product information.

Note: The Logout button is available on any web page. Logging out of the web page would force re-authentication to take place the next time the web page is accessed.

Device Status Page

The Device Status page is the first page that appears after you log into the Web Manager. It also appears when you click **Status** in the Main Menu.

EDS-MD
LANTRONIX

- Status ⌂
- CLI
- Diagnostics
- DNS
- Email
- Filesystem
- FTP
- Host
- HTTP
- Line
- Network
- Protocol Stack
- Query Port
- RSS
- SSH
- SSL
- Syslog
- System
- Terminal
- Tunnel
- VIP
- XML

Device Status

[\[Logout\]](#)

Product Information		
Product Type:	Lantronix EDSMD	
Firmware Version:	7.2.0.0R24	
Build Date:	Aug 22 07:59:25 PDT 2011	
Serial Number:		
Uptime:	1 days 07:29:17	
Current Date/Time:	Wed Apr 1 09:30:39 UTC 1970	
Temperature:	Board Temperature = 41.192C CPU Temperature = 64.128C	
Permanent Config:	Saved	
Network Settings		
Interface:	eth0	
Link:	Auto 10/100 Mbps Auto Half/Full (100 Mbps Half)	
MAC Address:	00:20:4a:9d:01:96	
Hostname:	edsmd	
IP Address:	172.19.205.88	
Default Gateway:	172.19.0.1	
Domain:	<None>	
Primary DNS:	<None>	
Secondary DNS:	<None>	
MTU:	1500	
VIP Conduit:	Disabled	
Line Settings		
Line 1:	RS232, 9600, None, 8, 1, None	
Line 2:	RS232, 9600, None, 8, 1, None	
Line 3:	RS232, 9600, None, 8, 1, None	
Line 4:	RS232, 9600, None, 8, 1, None	
Line 5:	RS232, 9600, None, 8, 1, None	
Line 6:	RS232, 9600, None, 8, 1, None	
Line 7:	RS232, 9600, None, 8, 1, None	
Line 8:	RS232, 9600, None, 8, 1, None [CLI]	
Tunneling	Connect Mode	Accept Mode
Tunnel 1:	Disabled	Waiting
Tunnel 2:	Disabled	Waiting
Tunnel 3:	Disabled	Waiting
Tunnel 4:	Disabled	Active
Tunnel 5:	Disabled	Active
Tunnel 6:	Disabled	Waiting
Tunnel 7:	Disabled	Waiting
Tunnel 8:	Disabled	Waiting

Copyright © Lantronix, Inc. 2007-2011. All rights reserved.

Web Manager Page Components

The layout of a typical Web Manager page is below.

Figure 5-1 Components of the Web Manager Page

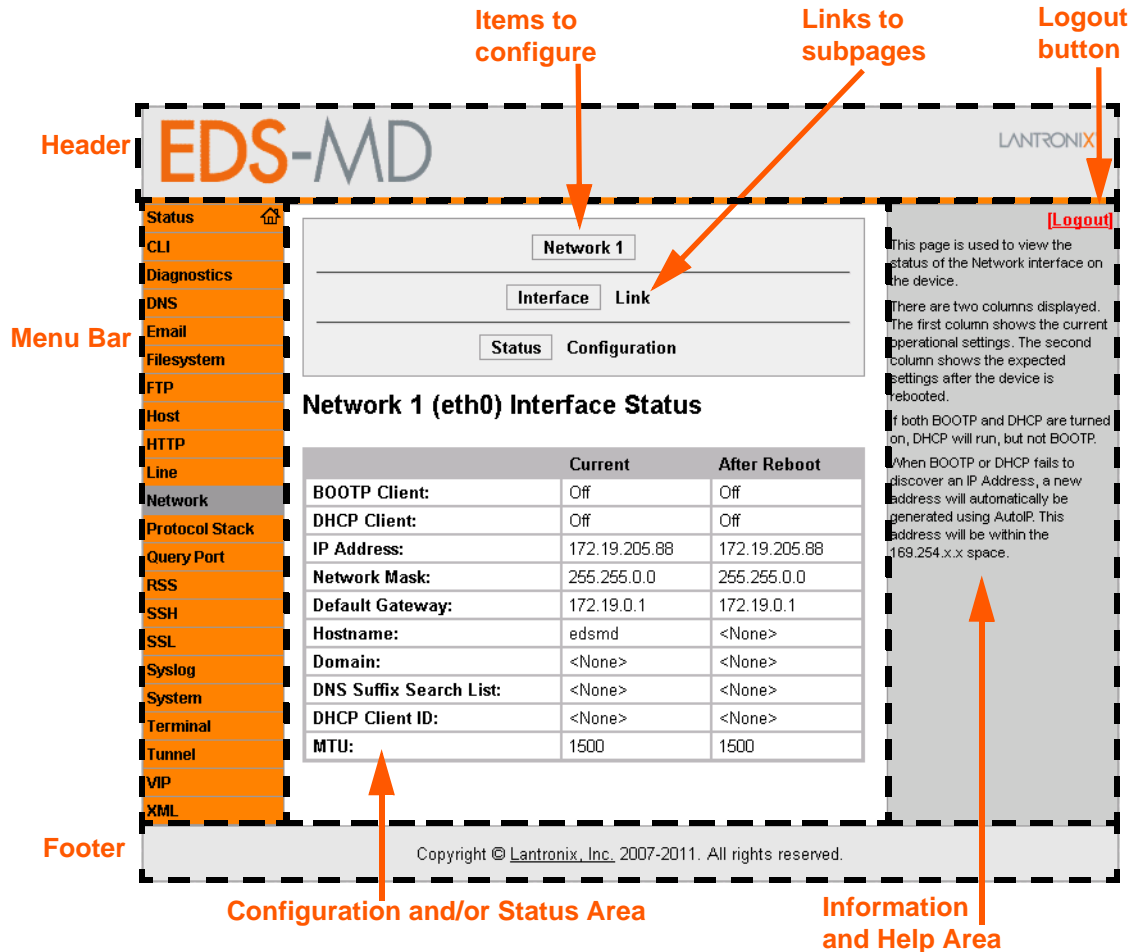

The menu bar always appears at the left side of the page, regardless of the page shown. The menu bar lists the names of the pages available in the Web Manager. To bring up a page, click it in the menu bar.

The main area of the page has these additional sections:

- ◆ At the very top, many pages, such as the one in the example above, enable you to link to sub pages. On some pages, you must also select the item you are configuring, such as a line or a tunnel.
- ◆ In the middle of many pages, you can select or enter new configuration settings. Some pages show status or statistics in this area rather than allow you to enter settings.
- ◆ At the bottom of most pages, the current configuration is displayed. In some cases, you can reset or clear a setting.

- ◆ The information or help area shows information or instructions associated with the page.
- ◆ A **Logout** link is available at the upper right corner of every web page. In Chrome or Safari, it is necessary to close out of the browser to completely logout. If necessary, reopen the browser to log back in.
- ◆ The footer appears at the very bottom of the page. It contains copyright information and a link to the Lantronix home page.

Navigating the Web Manager

The Web Manager provides an intuitive point-and-click interface. A menu bar on the left side of each page provides links you can click to navigate from one page to another. Some pages are read-only, while others let you change configuration settings.

Note: *There may be times when you must reboot the EDS-MD4/8/16 for the new configuration settings to take effect. The chapters that follow indicate when a change requires a reboot. Anytime you reboot the unit, this operation will take some time to complete. Please wait a minimum of 5 seconds after rebooting the unit before attempting to make any subsequent connections.*

Web Manager Page	Description	See Page
Status	Shows product information and network, line, and tunneling settings.	31
CLI	Shows Command Line Interface (CLI) statistics and lets you change the current CLI configuration settings.	76
Diagnostics	Lets you perform various diagnostic procedures.	70
DNS	Shows the current configuration of the DNS subsystem and the DNS cache.	52
Email	Shows email statistics and lets you clear the email log, configure email settings, and send an email.	75
Filesystem	Shows file system statistics and lets you browse the file system to view a file, create a file or directory, upload files using HTTP, copy a file, move a file, or perform TFTP actions.	65
FTP	Shows statistics and lets you change the current configuration for the File Transfer Protocol (FTP) server.	53
Host	Lets you view and change settings for a host on the network.	50
HTTP	Shows HyperText Transfer Protocol (HTTP) statistics and lets you change the current configuration and authentication settings.	54
Line	Shows statistics and lets you change the current configuration and Command mode settings of a serial line.	35
Network	Shows status and lets you configure the network interface.	46
Protocol Stack	Lets you perform lower level network stack-specific activities.	67
Query Port	Lets you change configuration settings for the query port.	69
RSS	Lets you change current Really Simple Syndication (RSS) settings.	56
SSH	Lets you change the configuration settings for SSH server host keys, SSH server authorized users, SSH client known hosts, and SSH client users.	58
SSL	Lets you upload an existing certificate or create a new self-signed certificate.	61

Web Manager Page (continued)	Description	See Page
Syslog	Lets you specify the severity of events to log and the server and ports to which the syslog should be sent.	53
System	Lets you reboot device, restore factory defaults, upload new firmware, and change the device long and short names.	74
Terminal	Lets you change current settings for a terminal.	49
Tunnel	Lets you change the current configuration settings for a tunnel.	37
VIP	Lets you configure Virtual IP addresses to be used in Tunnel Accept Mode and Tunnel Connect Mode.	91
XML	Lets you export XML configuration and status records, and import XML configuration records.	78

6: Line and Tunnel Settings

The EDS-MD4, EDS-MD8 and EDS-MD16 contains four, eight or sixteen Lines, depending on the specific model. All lines use standard RS232 serial ports.

RS232/RS485

All lines can be configured to operate in the following modes:

- ◆ RS232
- ◆ All serial settings such as Baud Rate, Parity, Data Bits, etc, apply to these Lines.

Line Settings

The Line Settings allow configuration of the serial Lines (ports).

Some settings may be specific to only certain Lines. Such settings are noted below.

Table 6-1 Line Configuration Settings

Line Settings	Description
Name	Enter a name or short description for the line, if desired. By default, there is no name specified. A name that contains white space must be quoted.
State	Select to Enable or Disable the operational state of the Line. The default is Enable .
Protocol	Set the operational protocol for the Line. The default is Tunnel . Choices are: <ul style="list-style-type: none">◆ None◆ Tunnel = Serial-Network tunneling protocol.
Baud Rate	Set the Baud Rate (speed) of the Line. The default is 9600 . Any set speed between 300 and 921600 may be selected: 300, 600, 1200, 2400, 4800, 9600, 19200, 38400, 57600, 115200, 230400, 460800, 921600. When selecting a Custom baud rate, you may manually enter any value between 300 and 5000000. <i>Note: Custom baud rates are not supported when a line is configured for Command Mode.</i>
Parity	Set the Parity of the Line. The default is None .
Data Bits	Set the number of data bits for the Line. The default is 8 .
Stop Bits	Set the number of stop bits for the Line. The default is 1 .
Flow Control	Set the flow control for the Line. The default is None .
Xon Char	Set Xon Char to be used when Flow Control is set to Software. Prefix decimal with \ or prefix hexadecimal with 0x or prefix a single control character <control>.
Xoff Char	Set Xoff Char to be used when Flow Control is set to Software. Prefix decimal with \ or prefix hexadecimal with 0x or prefix a single control character <control>.
Gap Timer	Set the Gap Timer delay to Set the number of milliseconds to pass from the last character received before the driver forwards the received serial bytes. By default, the delay is four character periods at the current baud rate (minimum 1 msec).
Threshold	Set the number of threshold bytes which need to be received in order for the driver to forward received characters.

Table 6-2 Line Command Mode Settings

Line Command Mode Settings	Description
Mode	Set the Command Mode state of the Line. When in Command Mode, a CLI session operates exclusively on the Line. Choices are: <ul style="list-style-type: none"> ◆ Always ◆ User Serial String ◆ Disabled <p><i>Note: In order to enable Command Mode on the Line, Tunneling on the Line must be Disabled (both Connect and Accept modes). Also, custom baud rates are not supported in Command Mode.</i></p>
Wait Time	Enter the amount of time to wait during boot time for the Serial String. This timer starts right after the Signon Message has been set on the Serial Line and applies only if mode is "Use Serial String".
Serial String	Enter the Text or Binary string of bytes that must be read on the Serial Line during boot time in order to enable Command Mode. It may contain a time element to specify a required delay in milliseconds x, formed as {x}. Applies only if mode is "User Serial String". It may contain a binary character(s) of the form [x]. For example, use decimal [12] or hex [0xc].
Echo Serial String	Select Enable or Disable for Echo Serial String. Applies only if mode is "User Serial String". Select enable to echo received characters backed out on the line while looking for the serial string.
Signon Message	Enter the string of bytes to be sent to the Serial Line during boot time. It may contain a binary character(s) of the form [x]. For example, use decimal [12] or hex [0xc].

To Configure Line Settings

Note: The following section describes the steps to view and configure Line 1 settings; these steps apply to other line instances of the device.

Using Web Manager

- ◆ To configure a specific line, click **Line** in the menu and select **Line 1 -> Configuration** (Table 6-1).
- ◆ To configure a specific line in Command Mode, click **Line** in the menu and select **Line 1 -> Command Mode** (Table 6-2).

Using the CLI

- ◆ To enter Line 1 command level: `enable -> line 1`

Using XML

- ◆ Include in your file: `<configgroup name="line" instance="1">`
- ◆ Include in your file: `<configgroup name="serial command mode" instance="1">`

To View Line Statistics

Using Web Manager

- ◆ To view statistics for a specific line, click **Line** in the menu and select **Line 1 -> Statistics**.

Using the CLI

- ◆ To view Line statistics: `enable -> line 1, show statistics`

Using XML

- ◆ Include in your file: `<statusgroup name="line" instance="1">`

Tunnel Settings

Tunneling allows serial devices to communicate over a network, without “being aware” of the devices which establish the network connection between them. Tunneling parameters are configured using the Tunnel menu and submenus. The Tunnel settings allow you to configure how the Serial-Network tunneling operates. Tunneling is available on all serial Lines. The connections on one serial Line are separate from those on another serial port.

Note: The following section describes the steps to view and configure Tunnel 1 settings; these steps apply to other tunnel instances of the device.

Serial Settings

These serial settings for the tunnel apply to the Serial Line interface. The Line Settings and Protocol are displayed for informational purposes and must be configured from the Line settings.

Table 6-3 Tunnel Serial Settings

Tunnel Serial Settings	Description
Line Settings	Line Settings information here is display only. Go to the section, To Configure Line Settings to modify these settings.
Protocol	Protocol information here is display only. Go to the section, To Configure Line Settings to modify these settings.
DTR	Select the conditions in which the Data Terminal Ready (DTR) control signal on the Serial Line are asserted. Choices are: <ul style="list-style-type: none"> ◆ Unasserted ◆ TruPort = the DTR is asserted whenever either a connect or an accept mode tunnel connection is active with the Telnet Protocol RFC2217 saying that the remote DSR is asserted. ◆ Asserted while connected = the DTR is asserted whenever either a connect or an accept mode tunnel connection is active. ◆ Continuously asserted

To Configure Tunnel Serial Settings

Using Web Manager

- ◆ To configure the Serial Settings for a specific tunnel, click **Tunnel** in the menu and select **Tunnel 1 -> Serial Settings**.

Using the CLI

- ◆ To enter Tunnel 1 command level: `enable -> tunnel 1 -> serial`

Using XML

- ◆ Include in your file: `<configgroup name="tunnel serial" instance="1">`

Packing Mode

With Packing, data from the serial Line is not sent over the network immediately. Instead, data is queued and sent in segments, when either the timeout or byte threshold is reached. Packing applies to both Accept and Connect Modes.

Table 6-4 Tunnel Packing Mode Settings

Tunnel Packing Mode Settings	Description
Mode	Configure the Tunnel Packing Mode. Choices are: <ul style="list-style-type: none"> ◆ Disable = Data not packed. ◆ Timeout = data sent after timeout occurs. ◆ Send Character = data sent when the Send Character is read on the Serial Line.
Threshold	Set the threshold (byte count). If the received serial data reaches this threshold, then the data will be sent on the network. Valid range is 100 to 1450 bytes. Default is 512.
Timeout	Set the timeout value, in milliseconds, after the first character is received on the serial Line, before data is sent on the network. Valid range is 1 to 30000 milliseconds. Default is 1000.
Send Character	Enter Control Characters in any of the following forms: <ul style="list-style-type: none"> ◆ <control>J ◆ 0xA (hexadecimal) ◆ \10 (decimal) If used, the Send Character is a single printable character or a control character that, when read on the Serial Line, forces the queued data to be sent on the network immediately.
Trailing Character	Enter Control Characters in any of the following forms: <ul style="list-style-type: none"> ◆ <control>J ◆ 0xA (hexadecimal) ◆ \10 (decimal). If used, the Trailing Character is a single printable character or a control character that is injected into the outgoing data stream right after the Send Character. Disable the Trailing Character by blanking the field (setting it to <None>).

To Configure Tunnel Packing Mode Settings

Using Web Manager

- ◆ To configure the Packing Mode for a specific tunnel, click **Tunnel** in the menu and select **Tunnel 1 -> Packing Mode**.

Using the CLI

- ◆ To enter the Tunnel 1 Packing command level: `enable -> tunnel 1 -> packing`

Using XML

- ◆ Include in your file: `<configgroup name="tunnel packing" instance="1">`

Accept Mode

In Accept Mode, the EDS-MD4/8/16 listens (waits) for incoming connections from the network. A remote node on the network initiates the connection.

The configurable local port is the port the remote device connects to for this connection. There is no remote port or address. Supported serial lines and associated local port numbers progress sequentially in matching value. For instance, the default local port is 10001 for serial line 1 and the default local port for serial line 2 is 10002, and so on for the number of serial lines supported.

Serial data can still be received while waiting for a network connection, keeping in mind serial data buffer limitations.

Table 6-5 Tunnel Accept Mode Settings

Tunnel Accept Mode Settings	Description
Mode	Set the method used to start a tunnel in Accept mode. Choices are: <ul style="list-style-type: none"> ◆ Disable = do not accept an incoming connection. ◆ Always = accept an incoming connection. (<i>default</i>) ◆ Any Character = start waiting for an incoming connection when any character is read on the serial line. ◆ Start Character = start waiting for an incoming connection when the start character for the selected tunnel is read on the serial line. ◆ Modem Control Asserted = start waiting for an incoming connection as long as the Modem Control pin (DSR) is asserted on the serial line until a connection is made. ◆ Modem Emulation = start waiting for an incoming connection when triggered by modem emulation AT commands. Connect mode must also be set to Modem Emulation.
Local Port	Set the port number for use as the network local port. The default local port number for each supported serial line number progresses sequentially in equal value so that Tunnel X : 1000X. For example: <ul style="list-style-type: none"> ◆ Tunnel 1 : 10001 ◆ Tunnel 2 : 10002
Protocol	Select the protocol type for use with Accept Mode: <ul style="list-style-type: none"> ◆ SSH ◆ SSL ◆ TCP (default protocol) ◆ TCP AES ◆ Telnet
TCP Keep Alive	Enter the time, in milliseconds, the EDS-MD waits during a silent connection before checking if the currently connected network device is still on the network. If the unit then gets no response after 1 attempt, it drops the connection. Enter 0 to disable.

Tunnel Accept Mode Settings (continued)	Description
Flush Serial	Set whether the serial Line data buffer is flushed upon a new network connection. Choices are: <ul style="list-style-type: none"> ◆ Enabled = serial data buffer is flushed on network connection ◆ Disabled = serial data buffer is not flushed on network connection (<i>default</i>)
Block Serial	Set whether Block Serial is enabled for debugging purposes. Choices are: <ul style="list-style-type: none"> ◆ Enabled = if Enabled, incoming characters from the Serial Line will not be forwarded to the network. Instead, they will be buffered and will eventually flow off the Serial Line if hardware or software flow control is configured. ◆ Disabled = this is the default setting; incoming characters from the Serial Line are sent on into the network. Any buffered characters are sent first.
Block Network	Set whether Block Network is enabled for debugging purposes. Choices are: <ul style="list-style-type: none"> ◆ Enabled = if Enabled, incoming characters from the network will not be forwarded to the Serial Line. Instead, they will be buffered and will eventually flow off the network side. ◆ Disabled = this is the default setting; incoming characters from the network are sent on into the Serial Line. Any buffered characters are sent first.
Password	Enter a password. This password can be up to 31 characters in length and must contain only alphanumeric characters and punctuation. When set, clients must send the correct password string to the unit within 30 seconds from opening network connection in order to enable data transmission. The password sent to the unit must be terminated with one of the following: <ul style="list-style-type: none"> ◆ 0A (Line Feed) ◆ 00 (Null) ◆ 0D 0A (Carriage Return/Line Feed) ◆ 0D 00 (Carriage Return/Null) If, Prompt for Password is set to Enabled, the user will be prompted for the password upon connection.
Email on Connect	Select an email profile number to which an email notification will be sent upon the establishment of an accept mode tunnel.
Email on Disconnect	Select an email profile number to which an email notification will be sent upon the disconnection of an accept mode tunnel.

To Configure Tunnel Accept Mode Settings

Using Web Manager

- ◆ To configure the Accept Mode for a specific tunnel, click **Tunnel** in the menu and select **Tunnel 1 -> Accept Mode**.

Using the CLI

- ◆ To enter Tunnel 1 Accept Mode command level: `enable -> tunnel 1 -> accept`

Using XML

- ◆ Include in your file: `<configgroup name="tunnel accept" instance="1">`

Connect Mode

In Connect Mode, the EDS-MD4/8/16 continues to attempt an outgoing connection on the network, until established. If the connection attempt fails or the connection drops, then it retries after a timeout. The remote node on the network must listen for the Connect Mode's connection.

For Connect Mode to function, it must be enabled, have a remote station (node) configured, and a remote port configured (TCP or UDP). When established, Connect Mode is always on. Enter the remote station as an IP address or DNS name. The EDS-MD4/8/16 will not make a connection unless it can resolve the address.

For Connect Mode using UDP, the EDS-MD4/8/16 accepts packets from any device on the network. It will send packets to the last device that sent it packets.

Note: *The Port in Connect Mode is not the same port configured in Accept Mode.*

The TCP keepalive time is the time in which probes are periodically sent to the other end of the connection. This ensures the other side is still connected.

Table 6-6 Tunnel Connect Mode Settings

Tunnel Connect Mode Settings	Description
Mode	Set the method to be used to attempt a connection to a remote host or device. Choices are: <ul style="list-style-type: none"> ◆ Disable = an outgoing connection is never attempted. (<i>default</i>) ◆ Always = a connection is attempted until one is made. If the connection gets disconnected, the EDS-MD retries until it makes a connection. ◆ Any Character = a connection is attempted when any character is read on the serial line. ◆ Start Character = a connection is attempted when the start character for the selected tunnel is read on the serial line. ◆ Modem Control Asserted = a connection is attempted as long as the Modem Control pin (DSR) is asserted, until a connection is made. ◆ Modem Emulation = a connection is attempted when triggered by modem emulation AT commands.
Local Port	Enter an alternative Local Port. The Local Port is set to <Random> by default but can be overridden. Blank the field to restore the default.
Host 1	Click on the displayed information to expand it for editing. If <None> is displayed, clicking it will allow you to configure a new host. At least one Host is required to enable Connect Mode as this information is necessary to connect to that host.
Reconnect Timer	Set the value of the reconnect timeout (in milliseconds) for outgoing connections established by the device. Valid range is 1 to 65535 milliseconds. Default is 15000.
Flush Serial Data	Set whether the serial Line data buffer is flushed upon a new network connection. Choices are: <ul style="list-style-type: none"> ◆ Enabled = serial data buffer is flushed on network connection ◆ Disabled = serial data buffer is not flushed on network connection (<i>default</i>)

Tunnel Connect Mode Settings (continued)	Description
Block Serial	Set whether Block Serial is enabled for debugging purposes. Choices are: <ul style="list-style-type: none"> ◆ Enabled = If Enabled, incoming characters from the Serial Line will not be forwarded to the network. Instead, they will be buffered and will eventually flow off the Serial Line if hardware or software flow control is configured. ◆ Disabled = this is the default setting; incoming characters from the Serial Line are sent on into the network. Any buffered characters are sent first.
Block Network	Set whether Block Network is enabled for debugging purposes. Choices are: <ul style="list-style-type: none"> ◆ Enabled = If Enabled, incoming characters from the network will not be forwarded to the Serial Line. Instead, they will be buffered and will eventually flow off the network side. ◆ Disabled = this is the default setting; incoming characters from the network are sent on into the Serial Line. Any buffered characters are sent first.
Email on Connect	Select an email profile number to which an email notification will be sent upon the establishment of an accept mode tunnel.
Email on Disconnect	Select an email profile number to which an email notification will be sent upon the disconnection of an accept mode tunnel.

To Configure Tunnel Connect Mode Settings

Using Web Manager

- ◆ To configure the Connect Mode for a specific tunnel, click **Tunnel** in the menu and select **Tunnel 1 -> Connect Mode**.

Using the CLI

- ◆ To enter the Tunnel 1 Connect Mode command level: `enable -> tunnel 1 -> connect`

Using XML

- ◆ Include in your file: `<configgroup name="tunnel connect" instance="1">`

Disconnect Mode

Specifies the optional conditions for disconnecting any Accept Mode or Connect Mode connection that may be established. If any of these conditions are selected but do not occur and the network disconnects to the device, a Connect Mode connection will attempt to reconnect. However, if none of these conditions are selected, a closure from the network is taken as a disconnect.

Table 6-7 Tunnel Disconnect Mode Settings

Tunnel Disconnect Mode Settings	Description
Stop Character	Enter the Stop Character which when received on the Serial Line, disconnects the tunnel. The Stop Character may be designated as a single printable character or as a control character. Control characters may be input in any of the following forms: <code><control>J</code> or <code>0xA(hexadecimal)</code> or <code>\10 (decimal)</code> . Disable the Stop Character by blanking the field to set it to <code><None></code> .

Tunnel Disconnect Mode Settings	Description
Modem Control	Set whether Modem Control enables disconnect when the Modem Control pin is not asserted on the Serial Line. Choices are: <ul style="list-style-type: none"> ◆ Enabled ◆ Disabled (default)
Timeout	Enter the number of milliseconds a tunnel may be idle before disconnection. The value of zero disables the idle timeout.
Flush Serial Data	Set whether to flush the Serial Line when the Tunnel is disconnected. Choices are: <ul style="list-style-type: none"> ◆ Enabled ◆ Disabled (default)

To Configure Tunnel Disconnect Mode Settings

Using Web Manager

- ◆ To configure the Disconnect Mode for a specific tunnel, click **Tunnel** in the menu and select **Tunnel 1 -> Disconnect Mode**.

Using the CLI

- ◆ To enter the Tunnel 1 Disconnect command level: `enable -> tunnel 1 -> disconnect`

Using XML

- ◆ Include in your file: `<configgroup name="tunnel disconnect" instance="1">`

Modem Emulation

Some older equipment is designed to attach to a serial port and dial into a network with a modem. This equipment uses AT commands to control the connection. For compatibility with these older devices on modern networks, our product mimics the behavior of the modem.

Table 6-8 Tunnel Modem Emulation Settings

Tunnel Modem Emulation Settings	Description
Echo Pluses	Set whether the pluses will be echoed back during a "pause +++ pause" escape sequence on the Serial Line. Choices are: <ul style="list-style-type: none"> ◆ Enabled ◆ Disabled (default)
Echo Commands	Set whether characters read on the Serial Line will be echoed, while the Line is in Modem Command Mode. Choices are: <ul style="list-style-type: none"> ◆ Enabled ◆ Disabled (default)
Verbose Response	Set whether Modem Response Codes are sent out on the Serial Line. Choices are: <ul style="list-style-type: none"> ◆ Enabled ◆ Disabled (default)

Tunnel Modem Emulation Settings	Description
Response Type	Select a representation for the Modem Response Codes sent out on the Serial Line. Choices are: <ul style="list-style-type: none"> ◆ Text (ATV1) (default) ◆ Numeric (ATV0)
Error Unknown Commands	Set whether the Error Unknown Commands is enabled (ATU0) and ERROR is returned on the Serial Line for unrecognized AT commands. Otherwise (ATU1) OK is returned for unrecognized AT commands. Choices are: <ul style="list-style-type: none"> ◆ Enabled ◆ Disabled (default)
Incoming Connection	Set how and if requests are answered after an incoming RING (ATS0=2). Choices are: <ul style="list-style-type: none"> ◆ Disabled (default) ◆ Automatic ◆ Manual
Connect String	Enter the customized Connect String sent to the Serial Line with the Connect Modem Response Code.
Display Remote IP	Set whether the Display Remote IP is enabled so that the incoming RING sent on the Serial Line is followed by the IP address of the caller. Choices are: <ul style="list-style-type: none"> ◆ Enabled ◆ Disabled (default)

To Configure Tunnel Modem Emulation Settings

Using Web Manager

- ◆ To configure the Modem Emulation for a specific tunnel, click **Tunnel** in the menu and select **Tunnel 1 -> Modem Emulation**.

Using the CLI

- ◆ To enter the Tunnel 1 Modem command level: `enable -> tunnel 1 -> modem`

Using XML

- ◆ Include in your file: `<configgroup name="tunnel modem" instance="1">`

Statistics

Tunnel statistics contains data counters, error counters, connection time and connection information. Statistics are available at each individual connection and aggregated across all connections.

To View Tunnel Statistics

Using Web Manager

- ◆ To view statistics for a specific tunnel, click **Tunnel** in the menu and select the **Tunnel 1 -> Statistics**.

Using the CLI

- ◆ To view Tunnel 1 statistics: enable -> tunnel 1, show statistics

Using XML

- ◆ Include in your file: `<statusgroup name="tunnel" instance="1">`

7: Network Settings

The Network Settings show the status of the Ethernet interface/link and let you configure the settings on the device. Interface settings are related to the configuration of the IP and related protocols. Link settings are related to the physical link connection, which carries the IP traffic.

The EDS-MD4, EDS-MD8 and EDS-MD16 contains one network interface. The Ethernet interface is also called interface 1 or eth0.

Notes:

- ◆ Some settings require a reboot to take effect. These settings are noted below.
- ◆ Wait a minimum of 5 seconds after rebooting the unit before attempting to make any subsequent connections.
- ◆ The blue text in the XML command strings of this chapter are to be replaced with a user-specified name.

Network Interface Settings

Table 7-1 shows the network interface settings that can be configured.

Table 7-1 Network Interface Settings

Network Interface Settings	Description
BOOTP Client	Select to turn On or Off . At boot up, after the physical link is up, the EDS-MD will attempt to obtain IP settings from a BOOTP server. <i>Note:</i> Overrides the configured IP address/mask, gateway, hostname, and domain. When DHCP is Enabled , the system automatically uses DHCP, regardless of whether BOOTP is Enabled . Changing this value requires you to reboot the device.
DHCP Client	Select to turn On or Off . At boot up, after the physical link is up, the EDS-MD will attempt to obtain IP settings from a DHCP server and will periodically renew these settings with the server. <i>Note:</i> Overrides BOOTP, the configured IP address/mask, gateway, hostname, and domain. Changing this value requires you to reboot the device. <i>Note:</i> Within WebManager, click Renew to renew the DHCP lease.
IP Address	Enter the static IP address to use for the interface. You may enter it alone or in CIDR format. <i>Note:</i> This setting will be used if Static IP is active (both DHCP and BOOTP are Disabled). Changing this value requires you to reboot the device. When DHCP or BOOTP is enabled, the EDS-MD tries to obtain an IP address from a DHCP or BOOTP server. If it cannot, the EDS-MD generates and uses an Auto IP address in the range of 169.254.xxx.xxx, with a network mask of 255.255.0.0.
Default Gateway	Enter the IP address of the router for this network. <i>Note:</i> This setting will be used if Static IP is active (both DHCP and BOOTP are Disabled).

Network Interface Settings (continued)	Description
Hostname	Enter the hostname for the interface. It must begin with a letter or number, continue with a sequence of letters, numbers, or hyphens, and end with a letter or number. <i>Note:</i> This setting will take effect immediately, but will not register the hostname with a DNS server until the next reboot.
Domain	Enter the domain name suffix for the interface. <i>Note:</i> This setting will be used when either Static IP or Auto IP is active, or if DHCP/BOOTP is active and no Domain Suffix was acquired from the server.
DHCP Client ID	Enter the ID if the DHCP server requires a DHCP Client ID option. The DHCP server's lease table shows IP addresses and MAC addresses for devices. The lease table shows the Client ID, in hexadecimal notation, instead of the EDS-MD MAC address.
Primary DNS	Enter the IP address of the primary Domain Name Server. <i>Note:</i> This setting will be used when either Static IP or Auto IP is active, or if DHCP/BOOTP is active and no DNS server was acquired from the server.
Secondary DNS	Enter the IP address of the secondary Domain Name Server. <i>Note:</i> This setting will be used when either Static IP or Auto IP is active, or if DHCP/BOOTP is active and no DNS server was acquired from the server.
MTU	When DHCP is enabled, the MTU size is (usually) provided with the IP address. When not provided by the DHCP server, or using a static configuration, this value is used. The MTU size can be from 576 to 1500 bytes, the default being 1500 bytes.

To Configure Network Interface Settings

Using Web Manager

- ◆ To modify Ethernet (eth0) settings, click **Network** on the menu and select **Network 1 -> Interface -> Configuration**.

Using the CLI

- ◆ To enter the eth0 command level: `enable -> config -> if 1`

Using XML

- ◆ Include in your file: `<configgroup name="interface" instance="eth0">`

To View Network Interface Status

Using Web Manager

In Network Interface Status, you can view both the current operational settings as well as the settings that would take affect upon a device reboot.

- ◆ To view Ethernet (eth0) Status, click **Network** on the menu and select **Network 1 -> Interface -> Status**.

Network Link Settings

Physical link parameters can be configured for an Ethernet (eth0) Network Interface (see [Table 7-2](#)).

Table 7-2 Network 1 (eth0) Link Settings

Network 1 Ethernet (eth0) Link Settings	Description
Speed	Select the Ethernet link speed. (Default is Auto) <ul style="list-style-type: none"> ◆ Auto = Auto-negotiation of Link Speed ◆ 10 = Force 10 Mbps ◆ 100 = Force 100 Mbps
Duplex	Select the Ethernet link duplex mode. (Default is Auto) <ul style="list-style-type: none"> ◆ Auto = Auto-negotiation of Link Duplex ◆ Half = Force Half Duplex ◆ Full = Force Full Duplex

Notes:

- ◆ When speed is **Auto**, duplex must be **Auto** or **Half**.
- ◆ When speed is not **Auto**, duplex must be **Half** or **Full**.
- ◆ Fixed speed **Full** duplex will produce errors connected to **Auto**, due to duplex mismatch.

To Configure Network Link Settings

Using Web Manager

- ◆ To modify Ethernet (eth0) Link information, click **Network** on the menu and select **Network 1 -> Link**.

Using the CLI

- ◆ To enter the eth0 Link command level: `enable -> config -> if 1 -> link`

Using XML

- ◆ Include in your file: `<configgroup name="ethernet" instance="eth0">`

8: Terminal and Host Settings

Predefined connections are available via telnet, ssh, or a serial port. A user can choose one of the presented options and the device automatically makes the predefined connection.

Either the Telnet, SSH, or serial port connection can present the CLI or the Login Connect Menu. By default, the CLI is presented when the device is accessed. When configured to present the Login Connect Menu, the hosts configured via the Host selections, and named serial lines are presented.

Terminal Settings

You can configure whether each serial line or the telnet/SSH server presents a CLI or a Login Connect menu when a connection is made.

Table 8-1 Terminal on Network and Line Settings

Terminal on Network and Line Settings	Description
Terminal Type	Enter text to describe the type of terminal. The text will be sent to a host via IAC. <i>Note:</i> IAC means, "interpret as command." It is a way to send commands over the network such as send break or start echoing .
Login Connect Menu	Select the interface to display when the user logs in. Choices are: ◆ Enabled = shows the Login Connect Menu. ◆ Disabled = shows the CLI (default)
Exit Connect Menu	Select whether to display a choice for the user to exit the Login Connect Menu and reach the CLI. Choices are: ◆ Enabled = a choice allows the user to exit to the CLI. ◆ Disabled = there is no exit to the CLI (default)
Send Break	Enter a Send Break control character, e.g., <control> Y, or blank to disable. When the Send Break control character is received from the network on its way to the serial line, it is not sent to the line; instead, the line output is forced to be inactive (the break condition). <i>Note:</i> This configuration option is only available for Line Terminals.
Break Duration	Enter how long the break should last in milliseconds, up to 10000. Default is 500. <i>Note:</i> This configuration option is only available for Line Terminals.
Echo	Select whether to enable echo: ◆ Enabled ◆ Disabled <i>Note:</i> Applies only to Connect Mode Telnet connections, not to Accept Mode. Only disable Echo if your terminal echoes, in which case you will see double of each character typed. Default is enabled.

To Configure the Terminal Network Connection

Using Web Manager

- ◆ To configure the Terminal on Network, click **Terminal** on the menu and select **Network -> Configuration**.

Using the CLI

- ◆ To enter the Terminal Network command level: `enable -> config -> terminal network`

Using XML

- ◆ Include in your file: `<configgroup name="terminal" instance="network">`

To Configure the Terminal Line Connection

Note: The following section describes the steps to view and configure Terminal 1 settings; these steps apply to other terminal instances of the device.

Using Web Manager

- ◆ To configure a particular Terminal Line, click **Terminal** on the menu and select **Line 1 -> Configuration**.

Using the CLI

- ◆ To enter the Terminal Line command level: `enable -> config -> terminal 1`

Using XML

- ◆ Include in your file: `<configgroup name="terminal" instance="1">`

Host Configuration

Table 8-2 Host Configuration

Host Settings	Description
Name	Enter a name for the host. This name appears on the Login Connect Menu. To leave a host out of the menu, leave this field blank.
Protocol	Select the protocol to use to connect to the host. Choices are: <ul style="list-style-type: none"> ◆ Telnet ◆ SSH <p>Note: SSH keys must be loaded or created in SSH for the SSH protocol to work.</p>

Host Settings (continued)	Description
SSH Username	Enter a username to select a pre-configured Username/Password/Key (configured on the SSH: Client Users), or leave it blank to be prompted for a username and password at connect time. <i>Note: This field appears if you selected SSH as the protocol.</i>
Remote Address	Enter an IP address for the host to which the device will connect.
Remote Port	Enter the port on the host to which the device will connect.

To Configure Host Settings

Note: The following section describes the steps to view and configure Host 1 settings; these steps apply to other host instances of the device.

Using Web Manager

- ◆ To configure a particular Host, click **Host** on the menu and select **Host 1 -> Configuration**.

Using the CLI

- ◆ To enter the Host command level: `enable -> config -> host 1`

Using XML

- ◆ Include in your file: `<configgroup name="host" instance="1">`

9: Services Settings

DNS Settings

This section describes the active run-time settings for the domain name system (DNS) protocol. The primary and secondary DNS addresses come from the active interface. The static addresses from the Network Interface configuration settings may be overridden by DHCP.

Note: The blue text in the XML command strings of this chapter are to be replaced with a user-specified name.

Table 9-1 DNS Settings

Setting / Field	Description
Lookup	Perform one of the following: <ul style="list-style-type: none">◆ Enter an IP address, and perform a reverse Lookup to locate the hostname for that IP address◆ Enter a hostname, and perform a forward Lookup to locate the corresponding IP address

To View or Configure DNS Settings:

Using Web Manager

- ◆ To view DNS current status, click **DNS** in the menu.
- ◆ To lookup DNS name or IP address, click **DNS** in the menu to access the **Lookup** field.

Note: To configure DNS for cases where it is not supplied by a protocol, click **Network** in the menu and select **Interface -> Configuration**.

Using the CLI

- ◆ To enter the DNS command level: `enable -> dns`

Using XML

- ◆ Include in your file: `<configgroup name="interface" instance="eth0">`

FTP Settings

The FTP protocol can be used to upload and download user files, and upgrade the EDS-MD4/8/16 firmware. A configurable option is provided to enable or disable access via this protocol.

Table 9-2 FTP Settings

FTP Settings	Description
State	Select to enable or disable the FTP server: <ul style="list-style-type: none"> ◆ Enabled (default) ◆ Disabled

To Configure FTP Settings

Using Web Manager

- ◆ To configure FTP, click **FTP** in the menu.

Using the CLI

- ◆ To enter the FTP command level: `enable -> config -> ftp`

Using XML

- ◆ Include in your file: `<configgroup name="ftp server">`

Syslog Settings

The Syslog information shows the current configuration and statistics of the syslog. Here you can configure the syslog host and the severity of the events to log.

Note: *The system log is always saved to local storage, but it is not retained through reboots unless diagnostics logging to the filesystem is enabled. Saving the system log to a server that supports remote logging services (see RFC 3164) allows the administrator to save the complete system log history. The default port is 514.*

Table 9-3 Syslog Settings

Syslog Settings	Description
State	Select to enable or disable the syslog: <ul style="list-style-type: none"> ◆ Enabled ◆ Disabled (default)
Host	Enter the IP address of the remote server to which system logs are sent for storage.
Remote Port	Enter the number of the port on the remote server that supports logging services. The default is 514.

Syslog Settings (continued)	Description
Severity Log Level	Specify the minimum level of system message the EDS-MD should log. This setting applies to all syslog facilities. The drop-down list in the Web Manager is in descending order of severity (e.g., Emergency is more severe than Alert.)

To View or Configure Syslog Settings:

Using Web Manager

- ◆ To configure the Syslog, click **Syslog** in the menu.

Using the CLI

- ◆ To enter the Syslog command level: `enable -> config -> syslog`

Using XML

- ◆ Include in your file: `<configgroup name="syslog">`

HTTP Settings

Hypertext Transfer Protocol (HTTP) is the transport protocol for communicating hypertext documents on the Internet. HTTP defines how messages are formatted and transmitted. It also defines the actions web servers and browsers should take in response to different commands. HTTP Authentication enables the requirement of usernames and passwords for access to the device.

Table 9-4 HTTP Settings

HTTP Settings	Description
State	Select to enable or disable the HTTP server: <ul style="list-style-type: none"> ◆ Enabled (default) ◆ Disabled
Port	Enter the port for the HTTP server to use. The default is 80 .
Secure Port	Enter the port for the HTTPS server to use. The default is 443 . The HTTP server only listens on the HTTPS Port when an SSL certificate is configured.
Secure Protocols	Select to enable or disable the following protocols: <ul style="list-style-type: none"> ◆ SSL3 = Secure Sockets Layer version 3 ◆ TLS1.0 = Transport Layer Security version 1.0. TLS 1.0 is the successor of SSL3 as defined by the IETF. ◆ TLS1.1 = Transport Layer Security version 1.1 <p>The protocols are enabled by default.</p> <p>Note: A server certificate and associated private key need to be installed in the SSL configuration section to use HTTPS.</p>
Secure Credentials	Specify the name of the set of RSA and/or DSA certificates and keys to be used for the secure connection.

HTTP Settings (continued)	Description
Max Timeout	Enter the maximum time for the HTTP server to wait when receiving a request. This prevents Denial-of-Service (DoS) attacks. The default is 10 seconds.
Max Bytes	Enter the maximum number of bytes the HTTP server accepts when receiving a request. The default is 40 KB (this prevents DoS attacks).
Logging State	Select to enable or disable HTTP server logging: <ul style="list-style-type: none"> ◆ Enabled (default) ◆ Disabled
Max Log Entries	Set the maximum number of HTTP server log entries. Only the last Max Log Entries are cached and viewable.
Log Format	Set the log format string for the HTTP server. Follow these Log Format rules: <ul style="list-style-type: none"> ◆ %a - remote IP address (could be a proxy) ◆ %b - bytes sent excluding headers ◆ %B - bytes sent excluding headers (0 = '-') ◆ %h - remote host (same as '%a') ◆ %{h}i - header contents from request (h = header string) ◆ %m - request method ◆ %p - ephemeral local port value used for request ◆ %q - query string (prepend with '?' or empty '-') ◆ %t - timestamp HH:MM:SS (same as Apache '%(%H:%M:%S)t' or '%(%T)t') ◆ %u - remote user (could be bogus for 401 status) ◆ %U - URL path info ◆ %r - first line of request (same as '%m %U%q <version>') ◆ %s - return status
Authentication Timeout	The timeout period applies if the selected authentication type is either Digest or SSL/Digest . After this period of inactivity, the client must authenticate again.

To Configure HTTP Settings

Using Web Manager

- ◆ To configure HTTP settings, click **HTTP** in the menu and select **Configuration**.
- ◆ To view HTTP statistics, click **HTTP** in the menu and select **Statistics**.

Using the CLI

- ◆ To enter the HTTP command level: `enable -> config -> http`

Using XML

- ◆ Include in your file: `<configgroup name="http server">`

Table 9-5 HTTP Authentication Settings

HTTP Authentication Settings	Description
URI	Enter the Uniform Resource Identifier (URI). <i>Note:</i> The URI must begin with '/' to refer to the filesystem.

HTTP Authentication Settings	Description
Auth Type	<p>Select the authentication type:</p> <ul style="list-style-type: none"> ◆ None = no authentication is necessary. ◆ Basic = encodes passwords using Base64. ◆ Digest = encodes passwords using MD5. ◆ SSL = can only be accessed over SSL (no password is required). ◆ SSL/Basic = is accessible only over SSL and encodes passwords using Base64. ◆ SSL/Digest = is accessible only over SSL and encodes passwords using MD5. <p><i>Note: When changing the parameters of Digest or SSL Digest authentication, it is often best to close and reopen the browser to ensure it does not attempt to use cached authentication information.</i></p>

To Configure HTTP Authentication

Using Web Manager

- ◆ To configure HTTP Authentication, click **HTTP** in the menu and select **Authentication**.

Using the CLI

- ◆ To enter the HTTP command level: `enable -> config -> http`

Using XML

- ◆ Include in your file: `<configgroup name="http authentication uri" instance="uri name" >`

RSS Settings

Really Simple Syndication (RSS) (sometimes referred to as Rich Site Summary) is a method of feeding online content to Web users. Instead of actively searching for configuration changes, RSS feeds permit viewing only relevant and new information regarding changes made to the via an RSS publisher. The RSS feeds may also be stored to the file system `cfg_log.txt` file.

Table 9-6 RSS Settings

RSS Settings	Description
RSS Feed	Select On or Off for RSS feeds to an RSS publisher. The default setting is off.
Persistent	Select On or Off for RSS feed to be written to a file (<code>cfg_log.txt</code>) and to be available across reboots. The default setting is off.
Max Entries	Set the maximum number of log entries. Only the last Max Entries are cached and viewable.

To Configure RSS Settings

Using Web Manager

- ◆ To configure RSS, click **RSS** in the menu.

Using the CLI

- ◆ To enter the RSS command level: `enable -> config -> rss`

Using XML

- ◆ Include in your file: `<configgroup name="rss">`

Real Time Clock (RTC) Settings

The current date and time displayed on the EDS-MD can be modified.

Table 9-7 RTC Settings

RTC Settings	Description
Time Zone	Select the time zone corresponding to the location of the EDS-MD.
Date	Select the year, month and day corresponding to the current date at the location of the EDS-MD
Time (24 hour)	Select the hour, minutes and seconds corresponding to the current time at the location of the EDS-MD.

To Configure RTC Settings

Using Web Manager

- ◆ To configure RTC, click **RTC** in the menu.

Using the CLI

- ◆ To enter the RTC command level: `enable -> config -> rtc`

Using XML

- ◆ Include in your file: `<configgroup name="clock">`

10: Security Settings

The EDS-MD4, EDS-MD8 and EDS-MD16 device supports Secure Shell (SSH) and Secure Sockets Layer (SSL). SSH is a network protocol for securely accessing a remote device. SSH provides a secure, encrypted communication channel between two hosts over a network. It provides authentication and message integrity services.

Secure Sockets Layer (SSL) is a protocol that manages data transmission security over the Internet. It uses digital certificates for authentication and cryptography against eavesdropping and tampering. It provides encryption and message integrity services. SSL is widely used for secure communication to a web server. SSL uses certificates and private keys.

Note: The device supports SSLv3 and its successors, TLS1.0 and TLS1.1. An incoming SSLv2 connection attempt is answered with an SSLv3 response. If the initiator also supports SSLv3, SSLv3 handles the rest of the connection.

SSH Settings

SSH is a network protocol for securely accessing a remote device over an encrypted channel. This protocol manages the security of internet data transmission between two hosts over a network by providing encryption, authentication, and message integrity services.

Two instances require configuration: when the EDS-MD is the SSH server and when it is an SSH client. The SSH server is used by the CLI (Command Mode) and for tunneling in Accept Mode. The SSH client is for tunneling in Connect Mode.

To configure the EDS-MD as an SSH server, there are two requirements:

- ◆ **Defined Host Keys:** both private and public keys are required. These keys are used for the Diffie-Hellman key exchange (used for the underlying encryption protocol).
- ◆ **Defined Users:** these users are permitted to connect to the EDS-MD SSH server.

SSH Server Host Keys

The SSH Server Host Keys are used by all applications that play the role of an SSH Server. Specifically Tunneling in Accept Mode. These keys can be created elsewhere and uploaded to the device or automatically generated on the device.

If uploading existing keys, take care to ensure the Private Key will not be compromised in transit. This implies the data is uploaded over some kind of secure private network.

Note: Some SSH Clients require RSA Host Keys to be at least 1024 bits in size.

Table 10-1 SSH Server Host Keys

RSS Settings	Description
Private Key	Enter the path and name of the existing private key you want to upload. . In WebManager, you can also Browse to the private key to be uploaded. Be sure the private key will not be compromised in transit. This implies the data is uploaded over some kind of secure private network.

RSS Settings (continued)	Description
Public Key	Enter the path and name of the existing public key you want to upload. In WebManager, you can also Browse to the public key to be uploaded.
Key Type	Select a key type to use for the new key: <ul style="list-style-type: none"> ◆ RSA ◆ DSA
Bit Size	Select a bit length for the new key: <ul style="list-style-type: none"> ◆ 512 ◆ 768 ◆ 1024

Note: SSH Keys from other programs may be converted to the required EDS-MD format. Use Open SSH to perform the conversion.

SSH Client Known Hosts

The SSH Client Known Hosts are used by all applications that play the role of an SSH Client. Specifically Tunneling in Connect Mode. Configuring these public keys are optional but if they exist another layer of security is offered which helps prevent Man-in-the-Middle (MITM) attacks.

Table 10-2 SSH Client Known Hosts

RSS Settings	Description
Server	Specify either a DNS Hostname or IP Address when adding public host keys for a Server. This Server name should match the name used as the Remote Address in Connect Mode Tunneling.
Public RSA Key	Enter the path and name of the existing public RSA key you want to use with this user. In WebManager, you can also Browse to the public RSA key to be uploaded. If authentication is successful with the key, no password is required.
Public DSA Key	Enter the path and name of the existing public DSA key you want to use with this user. In WebManager, you can also Browse to the public DSA key to be uploaded. If authentication is successful with the key, no password is required.

Note: These settings are not required for communication. They protect against Man-In-The-Middle (MITM) attacks.

SSH Server Authorized Users

The SSH Server Authorized Users are used by all applications that play the role of an SSH Server and specifically Tunneling in Accept Mode. Every user account must have a Password.

The user's Public Keys are optional and only necessary if public key authentication is wanted. Using public key authentication will allow a connection to be made without the password being asked at that time.

Note: When uploading the security keys, ensure the keys are not compromised in transit.

Table 10-3 SSH Server Authorized Users

RSS Settings	Description
Username	Enter a new username or edit an existing one.
Password	Enter a new password or edit an existing one.
Public RSA Key	Enter the path and name of the existing public RSA key you want to use with this user. In WebManager, you can also Browse to the public RSA key to be uploaded. If authentication is successful with the key, no password is required.
Public DSA Key	Enter the path and name of the existing public DSA key you want to use with this user. In WebManager, you can also Browse to the public DSA key to be uploaded. If authentication is successful with the key, no password is required.

SSH Client Users

The SSH Client Users are used by all applications that play the role of an SSH Client. Specifically Tunneling in Connect Mode. To configure the EDS-MD as an SSH client, an SSH client user must be both configured and also exist on the remote SSH server.

At the very least, a Password or Key Pair must be configured for a user. The keys for public key authentication can be created elsewhere and uploaded to the device or automatically generated on the device.

If uploading existing Keys, take care to ensure the Private Key will not be compromised in transit. This implies the data is uploaded over some kind of secure private network.

The default Remote Command is '<Default login shell>' which tells the SSH Server to execute a remote shell upon connection. This can be changed to anything the SSH Server on the remote host can execute.

Note: *If you are providing a key by uploading a file, make sure that the key is not password protected.*

Table 10-4 SSH Client Users

RSS Settings	Description
Username	Enter the name that the device uses to connect to an SSH server.
Password	Enter the password associated with the username.
Remote Command	Enter the command that can be executed remotely. Default is shell, which tells the SSH server to execute a remote shell upon connection. This command can be changed to anything the remote host can perform.
Private Key	Enter the path and name of the existing private key you want to upload. . In WebManager, you can also Browse to the private key to be uploaded. Be sure the private key will not be compromised in transit. This implies the data is uploaded over some kind of secure private network.
Public Key	Enter the path and name of the existing public key you want to upload. In WebManager, you can also Browse to the public key to be uploaded.
Key Type	Select a bit length for the key: <ul style="list-style-type: none"> ◆ RSA ◆ DSA

RSS Settings (continued)	Description
Bit Size	<p>Select the bit length of the new key:</p> <ul style="list-style-type: none"> ◆ 512 ◆ 768 ◆ 1024 <p>Using a larger Bit Size takes more time to generate the key. Approximate times are:</p> <ul style="list-style-type: none"> ◆ 1 second for a 512 bit RSA key ◆ 1 second for a 768 bit RSA key ◆ 1 second for a 1024 bit RSA key ◆ 2 seconds for a 512 bit DSA key ◆ 2 seconds for a 768 bit DSA key ◆ 20 seconds for a 1024 bit DSA key <p>Note: Some SSH clients require RSA host keys to be at least 1024 bits long. This device generates keys up to 2048 bits long.</p>

To Configure SSH Settings

Using Web Manager

- ◆ To configure SSH, click SSH in the menu.

Using the CLI

- ◆ To enter the SSH command level: `enable -> ssh`

Using XML

- ◆ Include in your file: `<configitem name="ssh username">`

SSL Settings

Secure Sockets Layer (SSL) is a protocol for managing the security of data transmission over the Internet. It provides encryption, authentication, and message integrity services. SSL is widely used for secure communication to a web server.

Certificate/Private key combinations can be obtained from an external Certificate Authority (CA) and uploaded into the unit. Self-signed certificates with associated private key can be generated by the device server itself.

Note: The blue text in the XML command strings of this chapter are to be replaced with a user-specified name.

Certificate and Key Generation

The EDS-MD4, EDS-MD8 and EDS-MD16 can generate self signed certificates and their corresponding keys. This can be done for both the rsa and dsa certificate formats. Certificates can be identified on the EDS-MD4/8/16 by a name provided at generation time.

Table 10-5 Certificate and Key Generation Settings

Certificate Generation Settings	Description
Country (2 Letter Code)	Enter the 2-letter country code to be assigned to the new self-signed certificate. Examples: US for United States and CA for Canada
State/Province	Enter the state or province to be assigned to the new self-signed certificate.
Locality (City)	Enter the city or locality to be assigned to the new self-signed certificate.
Organization	Enter the organization to be associated with the new self-signed certificate.
Organization Unit	Enter the organizational unit to be associated with the new self-signed certificate.
Common Name	Enter the common name to be associated with the new self signed certificate. Note that this is a required field.
Expires	Enter the expiration date, in mm/dd/yyyy format, for the new self-signed certificate. Example: An expiration date of May 9, 2012 is entered as 05/09/2012.
Key length	Select the bit size of the new self-signed certificate. Choices are: <ul style="list-style-type: none"> ◆ 512 bits ◆ 768 bits ◆ 1024 bits ◆ 2048 bits <p>The larger the bit size, the longer it takes to generate the key.</p>
Type	Select the type of key: <ul style="list-style-type: none"> ◆ RSA = Public-Key Cryptography algorithm based on large prime numbers, invented by Rivest Shamir and Adleman. Used for encryption and signing. ◆ DSA = Digital Signature Algorithm also based on large prime numbers, but can only be used for signing. Developed by the US government to avoid the patents on RSA.

To Create a New Credential

Using Web Manager

- ◆ To create a new credential, click **SSL** in the menu and select **Credentials**.

Using the CLI

- ◆ To enter the SSL command level: `enable -> ssl`
- ◆ To enter the Credentials command level: `enable -> ssl -> credentials`

Using XML

- ◆ Not applicable.

Certificate Upload Settings

SSL certificates identify the EDS-MD4/8/16 to peers. Certificate and key pairs can be uploaded to the EDS-MD4/8/16 through either the CLI or XML import mechanisms. Certificates can be identified on the EDS-MD4/8/16 by a name provided at upload time.

Table 10-6 Upload Certificate Settings

Upload Certificate Settings	Description
New Certificate	<p>SSL certificate to be uploaded. RSA or DSA certificates are allowed.</p> <p>The format of the certificate must be PEM. It must start with "-----BEGIN CERTIFICATE-----" and end with "-----END CERTIFICATE-----". Some Certificate Authorities add comments before and/or after these lines. Those need to be deleted before upload.</p>
New Private Key	<p>The key needs to belong to the certificate entered above.</p> <p>The format of the file must be PEM. It must start with "-----BEGIN RSA PRIVATE KEY-----" and end with "-----END RSA PRIVATE KEY-----". Read DSA instead of RSA in case of a DSA key. Some Certificate Authorities add comments before and/or after these lines. Those need to be deleted before upload.</p>

To Configure an Existing SSL Credential

Using Web Manager

- ◆ To configure an existing SSL Credential, click **SSL** in the menu and select **Credentials**.

Using the CLI

- ◆ To enter the SSL command level: `enable -> ssl`
- ◆ To enter the Credential command level: `enable -> ssl -> credentials`

Using XML

- ◆ Include in your file:

```
<configgroup name="ssl">
and <configitem name="credentials" instance="name">
and <value name="RSA certificate"/> or <value name="DSA certificate"/>
```

Trusted Authorities

One or more authority certificates are needed to verify a peer's identity. These certificates do not require a private key.

Table 10-7 Trusted Authority Settings

Trusted Authorities Settings	Description
Authority	SSL authority certificate. RSA or DSA certificates are allowed. The format of the authority certificate can be PEM or PKCS7. PEM files must start with "-----BEGIN CERTIFICATE-----" and end with "-----END CERTIFICATE-----". Some Certificate Authorities add comments before and/or after these lines. Those need to be deleted before upload.

To Upload an Authority Certificate

Using Web Manager

- ◆ To upload an Authority Certificate, click **SSL** in the menu and select **Trusted Authorities**.

Using the CLI

- ◆ To enter the SSL command level: `enable -> ssl`
- ◆ To enter the Trusted Authorities command level: `enable -> ssl -> trusted authorities`

Using XML

- ◆ Include in your file:

```
<configgroup name="ssl">
and <configitem name="trusted authority" instance="1">
and <configitem name="intermediate authority" instance="1">
```

11: Maintenance and Diagnostics Settings

Filesystem Settings

Use the file system to list, view, add, remove, and transfer files. The EDS-MD4/8/16 uses an EXT3 flash file system to store files. This is a journalled file system, which means that changes to the file system are recorded before the actual changes themselves are made. In the event of power loss, the use of journaling can usually recover from changes that had been started but not completed.

Some file systems may contain a 'lost+found' directory. In the event of power loss in the midst of file system I/O, file data that cannot be fully recovered will be placed in this directory. It is recommended to always restart the system from the Web Manager application or the CLI.

Note: *It is recommended to always use the Web Manager application or the CLI to shutdown/restart the system.*

File Display

It is possible to view the list of existing files, and to view their contents in the ASCII or hexadecimal formats.

Table 11-1 File Display Settings

File Display Commands	Description
ls	Displays a list of files on the EDS-MD, and their respective sizes.
cat	Displays the specified file in ASCII format.
dump	Displays the specified file in a combination of hexadecimal and ASCII formats.
pwd	Print working directory.
cd	Change directories.
show tree	Display file/directory tree.

To Display Files

Using Web Manager

- ◆ To view existing files and file contents, click **Filesystem** in the menu and select **Browse**.

Using the CLI

- ◆ To enter the Filesystem command level: `enable -> filesystem`

Using XML

- ◆ Not applicable.

File Modification

The EDS-MD4/8/16 allows for the creation and removal of files on its filesystem.

Table 11-2 File Modification Settings

File Modification Commands	Description
rm	Removes the specified file from the file system.
touch	Creates the specified file as an empty file.
cp	Creates a copy of a file.
mkdir	Creates a directory on the file system.
rmdir	Removes a directory from the file system.
format	Format the file system and remove all data.

File Transfer

Files can be transferred to and from the EDS-MD4/8/16 via the TFTP protocol. This can be useful for saving and restoring XML configuration files. Files can also be uploaded via HTTP.

Table 11-3 File Transfer Settings

File Transfer Settings	Description
Create	Browse to location of the file to be created.
Upload File	Browse to location of the file to be uploaded.
Copy File	Enter the source and destination for file to be copied.
Move	Enter the source and destination for file to be moved.
Action	Select the action that is to be performed via TFTP: Get = a “get” command will be executed to store a file locally. Put = a “put” command will be executed to send a file to a remote location.
Local File	Enter the name of the local file on which the specified “get” or “put” action is to be performed.
Remote File	Enter the name of the file at the remote location that is to be stored locally (“get”) or externally (“put”).
Host	Enter the IP address or name of the host involved in this operation.
Port	Enter the number of the port involved in TFTP operations.

To Transfer or Modify Filesystem Files

Using Web Manager

- ◆ To create a new file or directory, upload an existing file, copy or move a file, click **Filesystem** in the menu and select **Browse**.

Using the CLI

- ◆ To enter the Filesystem command level: `enable -> filesystem`

Using XML

- ◆ Not applicable.

IP Network Stack Settings

There are various low level network stack specific items that are available for configuration. This includes settings related to IP, ICMP, ARP and SMTP, which are described in the sections below.

Table 11-4 IP Network Stack Settings

Protocol Stack IP Settings	Description
IP Time to Live	This value typically fills the Time To Live in the IP header. SNMP refers to this value as "ipDefaultTTL". Enter the number of hops to be transmitted before the packet is discarded.
Multicast Time to Live	This value fills the Time To Live in any multicast IP header. Normally this value will be one so the packet will be blocked at the first router. It is the number of hops allowed before a Multicast packet is discarded. Enter the value to be greater than one to intentionally propagate multicast packets to additional routers.

To Configure IP Network Stack Settings

Using Web Manager

- ◆ To configure IP protocol settings, click **Protocol Stack** in the menu and select **IP**.

Using the CLI

- ◆ To enter the command level: `enable -> config -> ip`

Using XML

- ◆ Include in your file: `<configgroup name="ip" >`

Table 11-5 ICMP Network Stack Settings

Protocol Stack ICMP Settings	Description
State	The State selection is used to turn on/off processing of ICMP messages. This includes both incoming and outgoing messages. Choose Enabled or Disabled .

To Configure ICMP Network Stack Settings

Using Web Manager

- ◆ To configure ICMP protocol settings, click **Protocol Stack** in the menu and select **ICMP**.

Using the CLI

- ◆ To enter the command level: enable -> config -> icmp

Using XML

- ◆ Include in your file: <configgroup name="icmp">

Table 11-6 ARP Network Stack Settings

Protocol Stack ARP Settings	Description
IP Address	Enter the IP address to add to the ARP cache.
MAC Address	Enter the MAC address to add to the ARP cache.

To Configure ARP Network Stack Settings

Using Web Manager

- ◆ To configure ARP protocol settings, click **Protocol Stack** in the menu and select **ARP**.

Using the CLI

- ◆ To enter the command level: enable -> config -> arp

Using XML

- ◆ Include in your file: <configgroup name="arp">

Table 11-7 SMTP Network Stack Settings

Protocol Stack SMTP Settings	Description
Relay Address	Address of all outbound email messages through a mail server. Can contain either a hostname or an IP address.
Relay Port	Port utilized for the delivery of outbound email messages.

To Configure SMTP Network Stack Settings

Using Web Manager

- ◆ To configure SMTP protocol settings, click **Protocol Stack** in the menu and select **SMTP**.

Using the CLI

- ◆ To enter the command level: `enable -> config -> smtp`

Using XML

- ◆ Include in your file: `<configgroup name="smtp" >`

Query Port

The query port (UDP port 0x77FE) is used for the automatic discovery of the device by the DeviceInstaller utility. Only 0x77FE discover messages from DeviceInstaller are supported. For more information on DeviceInstaller, see [Chapter 4: Using DeviceInstaller on page 28](#).

Table 11-8 Query Port Settings

Query Port Settings	Description
Query Port Server	Enables or disables listening and responding to query port messages. Select On or Off.

To Configure Query Port Settings

Using Web Manager

- ◆ To view Query Port settings or to switch the Query Port Server on or off, click **Query Port** in the menu.

Using the CLI

- ◆ To enter the Query Port command level: `enable -> config -> query port`

Using XML

- ◆ Include in your file:

```
<configgroup name="query port">
```

and

```
<configitem name="state">
```

Diagnostics

The EDS-MD4/8/16 has several tools for diagnostics and statistics. Various options allow for the configuration or viewing of IP socket information, ping, traceroute, memory, and processes.

Hardware

To View Hardware Information

Using Web Manager

- ◆ To view hardware information, click **Diagnostics** in the menu and select **Hardware**.

Using the CLI

- ◆ To enter the command level: `enable -> device, show hardware information`

Using XML

- ◆ Include in your file: `<statusgroup name="hardware">`

IP Sockets

You can view the list of listening and connected IP sockets.

To View the List of IP Sockets

Using Web Manager

- ◆ To view IP Sockets, click **Diagnostics** in the menu and select **IP Sockets**.

Using the CLI

- ◆ To enter the command level: `enable, show ip sockets`

Using XML

- ◆ Include in your file: `<statusgroup name="ip sockets">`

Ping

The ping command can be used to test connectivity to a remote host.

Table 11-9 Ping Settings

Diagnostics: Ping Settings	Description
Host	Enter the IP address or host name for the EDS-MD to ping.
Count	Enter the number of ping packets EDS-MD should attempt to send to the Host . The default is 5 .
Timeout	Enter the time, in seconds, for the EDS-MD to wait for a response from the host before timing out. The default is 5 seconds.

To Ping a Remote Host

Using Web Manager

- ◆ To ping a Remote Host, click **Diagnostics** in the menu and select **Ping**.

Using the CLI

- ◆ To enter the command level: `enable`

Using XML

- ◆ Not applicable.

Traceroute

Here you can trace a packet from the EDS-MD4/8/16 to an Internet host, showing how many hops the packet requires to reach the host and how long each hop takes. If you visit a web site whose pages appear slowly, you can use traceroute to determine where the longest delays are occurring.

Table 11-10 Traceroute Settings

Diagnostics: Traceroute Settings	Description
Host	Enter the IP address or DNS hostname. This address is used to show the path between it and the EDS-MD when issuing the traceroute command.

To Perform a Traceroute

Using Web Manager

- ◆ To perform a Traceroute, click **Diagnostics** in the menu and select **Traceroute**.

Using the CLI

- ◆ To enter the command level: `enable`

Using XML

- ◆ Not applicable.

Log

Table 11-11 Log Settings

Diagnostics: Log	Description
Output	Select a diagnostic log output type: <ul style="list-style-type: none"> ◆ Disable - Turn off the loggin feature. ◆ Filesystem - Directs logging to /log.txt. ◆ Line (1, 2, 3 and 4) - Directs logging to the selected serial line.
Max Length	Set the maximum length of the log.txt file. <i>Note: This setting becomes available when Filesystem is selected.</i>

To Configure the Diagnostic Log Output

Using Web Manager

- ◆ To configure the Diagnostic Log output, click **Diagnostics** in the menu and select **Log**.

Using the CLI

- ◆ To enter the command level: enable -> config -> diagnostics -> log

Using XML

- ◆ Include in your file:

```
<configgroup name="diagnostics">
and
<configitem name="log">
```

Memory

The memory information shows the total, used, and available memory (in kilobytes).

To View Memory Usage

Using Web Manager

- ◆ To view memory information, click **Diagnostics** in the menu and select **Memory**.

Using the CLI

- ◆ To enter the command level: enable -> device, show memory

Using XML

- ◆ Include in your file: <statusgroup name="memory" >

Processes

The EDS-MD4/8/16 Processes information shows all the processes currently running on the system. It shows the Process ID (PID), Parent Process ID (PPID), user, CPU percentage, percentage of total CPU cycles, and process command line information.

To View Process Information

Using Web Manager

- ◆ To view process information, click **Diagnostics** in the menu and select **Processes**.

Using the CLI

- ◆ To enter the command level: `enable, show processes`

Using XML

- ◆ Include in your file: `<statusgroup name="processes" >`

Threads

The EDS-MD4/8/16 Threads information shows details of threads in the ltrx_evo task which can be useful for technical experts in debugging.

To View Thread Information

Using Web Manager

- ◆ To view thread information, click **Diagnostics** in the menu and select **Threads**.

Using the CLI

- ◆ To enter the command level: `enable -> device, show task state`

Using XML

- ◆ Not available

System Settings

The EDS-MD4/8/16 System settings allow for rebooting the device, restoring factory defaults, uploading new firmware and updating a system's short and long name.

Note: Anytime you reboot the unit, this operation will take some time to complete. Please wait a minimum of 5 seconds after rebooting the unit before attempting to make any subsequent connections.

Table 11-12 System Settings

System Settings	Description
Reboot Device	Reboots the device.
Restore Factory Defaults	Restores the device to the original factory settings. All configuration will be lost. The EDS-MD automatically reboots upon setting back to the defaults.
Upload New Firmware	FTP to the EDS-MD. Write the new firmware file to firmware.rom on the EDS-MD. The device automatically reboots upon the installation of new firmware. See the section, FTP Settings on page 53 .
Short Name	Enter a short name for the system name. A maximum of 32 characters are allowed.
Long Name	Enter a long name for the system name. A maximum of 64 characters are allowed.

To Reboot or Restore Factory Defaults

Using Web Manager

- ◆ To access the area with options to reboot, restore to factory defaults, upload new firmware, update the system name (long or short names) or to view the current configuration, click **System** in the menu.

Using the CLI

- ◆ To enter the command level: `enable`

Using XML

- ◆ Include in your file: `<configgroup name="xml import control">`

12: Advanced Settings

Email Settings

View and configure email alerts relating to events occurring within the system.

Table 12-1 Email Configuration

Email – Configuration Settings	Description
To	Enter the email address to which the email alerts will be sent. Multiple addresses are separated by semicolon (;). Required field if an email is to be sent.
CC	Enter the email address to which the email alerts will be copied. Multiple addresses are separated by semicolon (;).
From	Enter the email address to list in the From field of the email alert. Required field if an email is to be sent.
Reply-To	Enter the email address to list in the Reply-To field of the email alert.
Subject	Enter the subject for the email alert.
Message File	Enter the path of the file to send with the email alert. This file appears within the message body of the email.
Overriding Domain	Enter the domain name to override the current domain name in EHLO (Extended Hello).
Server Port	Enter the SMTP server port number. The default is port 25 .
Local Port	Enter the local port to use for email alerts. The default is a random port number.
Priority	Select the priority level for the email alert: <ul style="list-style-type: none">◆ Urgent◆ High◆ Normal◆ Low◆ Very Low

To View, Configure and Send Email

Note: The following section describes the steps to view and configure Email 1 settings; these steps apply to other emails available for the device.

Using Web Manager

- ◆ To view Email statistics, click **Email** in the menu and select **Email 1 -> Statistics**.
- ◆ To configure basic Email settings, click **Email** in the menu and select **Email 1 -> Configuration**.
- ◆ To send an email, click **Email** in the menu and select **Email 1 -> Send Email**.

Using the CLI

- ◆ To enter Email command level: `enable -> email 1`

Using XML

- ◆ Include in your file: `<configgroup name="email" instance="1">`

Command Line Interface Settings

The Command Line Interface settings allow you to control how users connect to and interact with the EDS-MD4/8/16's command line. It is possible to configure access via the Telnet and SSH protocols, in addition to general CLI options.

Basic CLI Settings

The basic CLI settings control general CLI access and usability options.

Table 12-2 CLI Configuration Settings

Command Line Interface Configuration Settings	Description
Login Password	Enter the password for logins by the admin account. The default password is "PASS".
Enable Level Password	Enter the password for access to the Command Mode Enable level. There is no password by default.
Quit Connect Line	Set the string used to terminate a connect line session and resume the CLI. Type <control> before any key to be pressed while holding down the Ctrl key, for example, <control>L.
Inactivity Timeout	Set a time period in which the CLI session should disconnect if no data is received. Enter 0 to disable. Blank the display field to restore the default.
Line Authentication	Enable or Disable authentication for CLI access on the serial lines.

To View and Configure Basic CLI Settings

Using Web Manager

- ◆ To view CLI statistics, click **CLI** in the menu and select **Statistics**.
- ◆ To configure basic CLI settings, click **CLI** in the menu and select **Configuration**.

Using the CLI

- ◆ To enter CLI command level: `enable -> config -> cli`

Using XML

- ◆ Include in your file: `<configgroup name="cli">`

Telnet Settings

The telnet settings control CLI access to the EDS-MD4/8/16 over the Telnet protocol.

Table 12-3 Telnet Settings

Telnet Settings	Description
Telnet State	Enable or Disable CLI access via telnet
Telnet Port	Enter an alternative Telnet Port to override the default used by the CLI server. Blank the field to restore the default.
Telnet Max Sessions	Specify the maximum number of concurrent Telnet sessions that will be allowed.
Telnet Authentication	Enable or Disable authentication for telnet logins.

To Configure Telnet Settings

Using Web Manager

- ◆ To configure Telnet settings, click **CLI** in the menu and select **Configuration**.

Using the CLI

- ◆ To enter the Telnet command level: `enable -> config -> cli -> telnet`

Using XML

- ◆ Include in your file:

```
<configgroup name="telnet">
and
<configitem name="state">
and
<configitem name="authentication">
```

SSH Settings

The SSH settings control CLI access to the EDS-MD4/8/16 over the SSH protocol.

Table 12-4 SSH Settings

SSH Settings	Description
SSH State	Select to Enable or Disable CLI access via telnet.
SSH Port	Specify the SSH Port and override the default, as needed. Blank the field to restore the default.
SSH Max Sessions	Specify the maximum number of concurrent SSH sessions that will be allowed.

To Configure SSH Settings

Using Web Manager

- ◆ To configure SSH settings, click **CLI** in the menu and select **Configuration**.

Using the CLI

- ◆ To enter the SSH command level: `enable -> config -> cli -> ssh`

Using XML

- ◆ Include in your file:

```
<configgroup name="ssh">
and
<configitem name="state">
```

XML Settings

The EDS-MD4/8/16 allows for the configuration of units using an XML configuration record (XCR). Export a current configuration for use on other EDS-MD4/8/16 or import a saved configuration file.

XML: Export Configuration

You can export the current system configuration in XML format. The generated XML file can be imported later to restore a configuration. It can also be modified and imported to update the configuration on this EDS-MD4/8/16 unit or another. The XML data can be dumped to the screen or exported to a file on the file system.

By default, all groups are exported. You may also select a subset of groups to export.

Table 12-5 XML Exporting Configuration

XML Export Configuration Settings	Description
Export to browser	Select this option to export the XCR data in the selected fields to the browser. Use the "xcr dump" command to export the data to the browser.
Export to local file	Select this option to export the XCR data to a file on the device. If you select this option, enter a file name for the XML configuration record. Use the "xcr export" command to export the data to a local file.
Export secrets	Select to export secret password and key information. Use only with a secure link, and save only in secure locations. Note: Only use with extreme caution.
Comments	Select this option to include descriptive comments in the XML.
Lines to Export	Select instances to be exported in the line, serial, tunnel and terminal groups.

XML Export Configuration Settings (continued)	Description
Groups to Export	Check the configuration groups that are to be exported to the XML configuration record. The group list should be comma delimited and encased in double quotes. The list of available groups can be viewed with the “xcr list” command.

To Export Configuration in XML Format

Using Web Manager

- ◆ To export configuration format, click **XML** in the menu and select **Export Configuration**.

Using the CLI

- ◆ To enter the XML command level: `enable -> xml`

Using XML

- ◆ Not applicable.

XML: Export Status

You can export the current status in XML format. By default, all groups are exported. You may also select a subset of groups to export.

Table 12-6 Exporting Status

XML Export Status Settings	Description
Export to browser	Select this option to export the XCR data in the selected fields to the browser. Use the “xcr dump” command to export the data to the browser.
Export to local file	Select this option to export the XCR data to a file on the device. If you select this option, enter a file name for the XML configuration record. Use the “xcr export” command to export the data to a local file.
Lines to Export	Select instances to be exported in the line, serial, tunnel and terminal groups.
Groups to Export	Check the configuration groups that are to be exported to the XML configuration record. The group list should be comma delimited and encased in double quotes. The list of available groups can be viewed with the “xcr list” command.

To Export in XML Format

Using Web Manager

- ◆ To export configuration format, click **XML** in the menu and select **Export Status**.

Using the CLI

- ◆ To enter the XML command level: `enable -> xml`

Using XML

- ◆ Not applicable.

XML: Import Configuration

Here you can import a system configuration from an XML file.

The XML data can be imported from a file on the file system or pasted into a CLI session. The groups to import can be specified at the command line, the default is all groups.

Import Configuration from External File

This import option requires entering the path and file name of the external XCR file you want to import.

Import Configuration from the Filesystem

This import option picks up settings from a file and your import selections of groups, lines, and instances. The list of files can be viewed from the filesystem level of the CLI.

Table 12-7 Import Configuration from Filesystem Settings

Import Configuration from Filesystem Settings	Description
Filename	Enter the name of the file on the EDS-MD (local to its filesystem) that contains XCR data.
Lines to Import	Select filter instances to be imported in the line, serial, tunnel and terminal groups. This affects both Whole Groups to Import and Text List selections.
Whole Groups to Import	Select the configuration groups to import from the XML configuration record. This option imports all instances of each selected group.
Text List	Enter the string to import specific instances of a group. The textual format of this string is: <g>:<i>;<g>:<i>;... Each group name <g> is followed by a colon and the instance value <i> and each <g>:<i> value is separated by a semi-colon. If a group has no instance then only the group name <g> should be specified.

To Import Configuration in XML Format

Using Web Manager

- ◆ To import configuration, click **XML** in the menu and select **Import Configuration**.

Using the CLI

- ◆ To enter the XML command level: `enable -> xml`

Using XML

- ◆ Not applicable.

13: Updating Firmware

Obtaining Firmware

Obtain the most up-to-date firmware and release notes for the unit from the Lantronix Web site (www.lantronix.com/support/downloads/) or by using anonymous FTP (<ftp://ftp.lantronix.com/>).

Loading New Firmware

Firmware may be updated by sending the file to the EDS-MD4/8/16 over an FTP connection. The destination file name on the EDS-MD4, EDS-MD8 or EDS-MD16 must be "firmware.rom". The device will reboot upon successful completion of the firmware upgrade.

Example FTP session:

```
$ ftp 192.168.10.127
Connected to 192.168.10.127.
220 (vsFTPD 2.0.7)
Name (192.168.10.127:user): admin
331 Please specify the password.
Password:
230 Login successful.
Remote system type is UNIX.
Using binary mode to transfer files.
ftp> put edsmd_7_2_0_0R8.rom firmware.rom
200 PORT command successful. Consider using PASV.
150 Ok to send data.
226 File receive OK.
9308164 bytes sent in 3.05 seconds (3047859 bytes/s)
ftp> quit
221 Goodbye.
```

14: VIP Settings

Virtual IP (VIP) Configuration

Configuring Connect Mode tunnels to use VIP is a simple matter of configuring a tunnel as is normally done, but also enabling VIP in the Tunnel Host settings, and using a VIP Name for the address.

VIP Accept Mode tunnels do not require special configuration. If VIP access is enabled (in VIP configuration), then VIP Accept Mode requests from a ManageLinx device will be accepted.

Table 14-1 VIP Configuration

VIP Settings	Description
State	Select Enabled or Disabled to determine whether to allow Virtual IP addresses to be used in Tunnel Connect Mode and to accept incoming Virtual IP connection requests to any local listening port.

To Configure VIP Settings

Using Web Manager

- ◆ To configure VIP settings, click **VIP** on the menu and select **Configuration**.

Using the CLI

- ◆ To enter the VIP command level: `enable -> config -> vip`

Using XML

- ◆ Include in your file: `<configgroup name="vip">`

Virtual IP (VIP) Status

The VIP Status shows the current state of the conduit. When configured correctly, a conduit with the AccessMyDevice Gateway will be maintained at all times.

To View VIP Status

Using Web Manager

- ◆ Click **VIP** on the menu and select **Status**.

Using the CLI

- ◆ To enter the VIP command level: `enable -> config -> vip, show status`

Using XML

- ◆ Include in your file: `<statusgroup name="vip">`

Virtual IP (VIP) Counters**Table 14-2 VIP Counters**

VIP Counters	Description
Data Bytes	Total bytes in the TCP packets (not the UDP packets)
UDP Packet Queue	The number of packets queued for transmission.
UDP Packets	The number of packets transmitted. <i>Note: UDP counts are packet based, and do not record the number of data bytes.</i>

To View VIP Counters**Using Web Manager**

- ◆ Click **VIP** on the menu and select **Counters**.

Using the CLI

- ◆ To enter the VIP command level: `enable -> config -> vip, show counters`

Using XML

- ◆ Include in your file: `<statusgroup name="vip">`

15: Branding the EDS-MD4/8/16

This chapter describes how to brand your EDS-MD4, EDS-MD8 or EDS-MD16 by using Web Manager and Command Line Interface (CLI). It contains the following sections on customization:

- ◆ [Web Manager Customization](#)
- ◆ [Short and Long Name Customization](#)

Web Manager Customization

Customize the Web Manager's appearance by modifying `index.html`, `style.css`, and the product logo. The style (fonts, colors, and spacing) of the Web Manager is controlled with `style.css`. The text and graphics are controlled with `index.html`. The product logo is the image in top-left corner of the page and defaults to a product name image.

Note: *The recommended dimensions of the new graphic are 300px width and 50px height.*

The Web Manager files are hidden and are incorporated directly into the firmware image but may be overridden by placing the appropriate file in the appropriate directory on the EDS-MD4, EDS-MD8 or EDS-MD16 file system.

Web Manager files can be retrieved and overridden with the following procedure:

1. FTP to the EDS-MD4/8/16 device.
2. Make a directory (`mkdir`) and name it `http/config`.
3. Change to the directory (`cd`) that you created in step 2 (`http/config`).
4. Save the contents of `index.html` and `style.css` by using a web browser and navigating to `http://<EDS-MD>/config/index.html` and `http://<EDS-MD>/config/style.css`.
5. Modify the file as required or create a new one with the same name.
6. To customize the product logo, save the image of your choice as `logo.gif`.
7. Put the file(s) by using `put <filename>`.
8. Type `quit`. The overriding files appear in the file system's `http/config` directory.
9. Restart any open browser to view the changes.
10. If you wish to go back to the default files in the firmware image, simply delete the overriding files from the file system.

Short and Long Name Customization

You can customize the short and long names in your EDS-MD4/8/16. The names display in the CLI show command and in the System web page in the Current Configuration table. The short name is used for the show command. Both names display in the CLI Product Type field.

Table 15-1 Short and Long Name Settings

Name Settings	Description
Short Name	Enter a short name for the system name. A maximum of 32 characters are allowed.
Long Name	Enter a long name for the system name. A maximum of 64 characters are allowed.

To Customize Short or Long Names

Using Web Manager

- ◆ To access the area with options to customize the short name and the long name of the product, or to view the current configuration, click **System** in the menu.

Using the CLI

- ◆ To enter the command level: enable

Using XML

- ◆ Include in your file:

```
<configitem name="short name">
and
<configitem name="long name">
```

Appendix A: Technical Support

If you are unable to resolve an issue using the information in this documentation, please contact Technical Support:

Technical Support US

Check our online knowledge base or send a question to Technical Support at <http://www.lantronix.com/support>.

Technical Support Europe, Middle East, Africa

Phone: +33 13 930 4172

Email: eu_techsupp@lantronix.com or eu_support@lantronix.com

Firmware downloads, FAQs, and the most up-to-date documentation are available at <http://www.lantronix.com/support>

When you report a problem, please provide the following information:

- ◆ Your name, and your company name, address, and phone number
- ◆ Lantronix model number
- ◆ Lantronix serial number/MAC address
- ◆ Firmware version (on the first screen shown when you Telnet to the device and type show)
- ◆ Description of the problem
- ◆ Status of the unit when the problem occurred (please try to include information on user and network activity at the time of the problem)
- ◆ Additionally, it may be useful to export and submit the exported XML Configuration file.

Appendix B: Binary to Hexadecimal Conversions

Many of the unit's configuration procedures require you to assemble a series of options (represented as bits) into a complete command (represented as a byte).

The resulting binary value must be converted to a hexadecimal representation.

Use this chapter to learn to convert binary values to hexadecimal or to look up hexadecimal values in the tables of configuration options. The tables include:

- ◆ Command Mode (serial string sign-on message)
- ◆ AES Keys

Converting Binary to Hexadecimal

Following are two simple ways to convert binary numbers to hexadecimal notation.

Conversion Table

Hexadecimal digits have values ranging from 0 to F, which are represented as 0-9, A (for 10), B (for 11), etc. To convert a binary value (for example, 0100 1100) to a hexadecimal representation, treat the upper and lower four bits separately to produce a two-digit hexadecimal number (in this case, 4C). Use the following table to convert values from binary to hexadecimal.

Scientific Calculator

Another simple way to convert binary to hexadecimal is to use a scientific calculator, such as the one available on the Windows operating systems. For example:

1. On the Windows Start menu, click **Programs -> Accessories -> Calculator**.
2. On the View menu, select **Scientific**. The scientific calculator appears.
3. Click **Bin** (Binary), and type the number you want to convert.

Table 17-1 Binary to Hexadecimal Conversion

Decimal	Binary	Hex
0	0000	0
1	0001	1
2	0010	2
3	0011	3
4	0100	4
5	0101	5
6	0110	6
7	0111	7
8	1000	8
9	1001	9
10	1010	A
11	1011	B
12	1100	C
13	1101	D
14	1110	E
15	1111	F

Figure 17-2 Windows Scientific Calculator

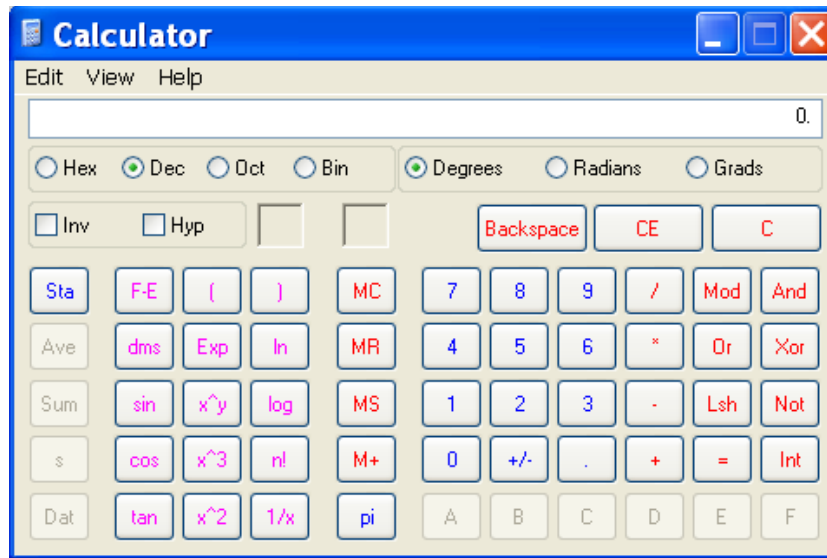

4. Click Hex. The hexadecimal value appears.

Figure 17-3 Hexadecimal Values in the Scientific Calculator

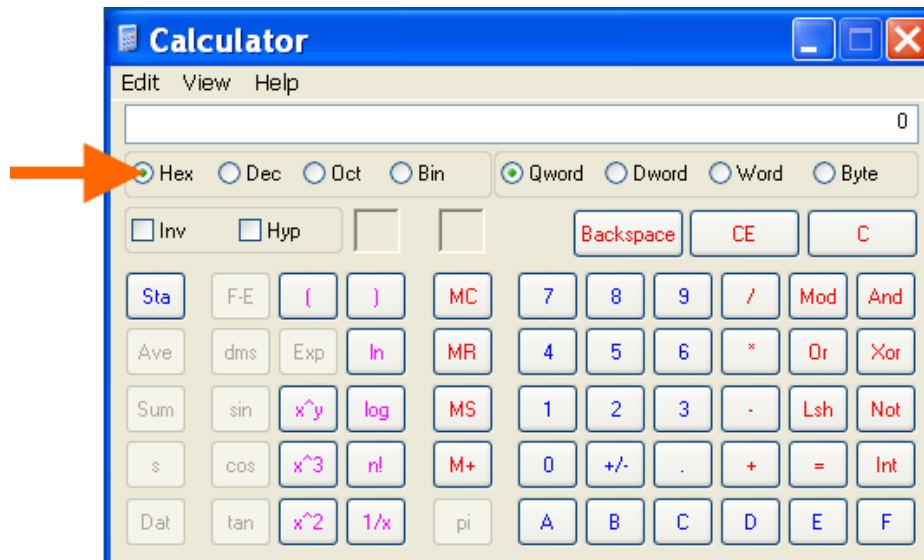

Appendix C: Compliance

(According to ISO/IEC Guide 22 and EN 45014)

Manufacturer's Name & Address:

Lantronix
167 Technology Drive, Irvine, CA 92618 USA

Product Name Model:

EDS-MD4, EDS-MD8 and EDS-MD16 Port Device Servers
Conform to the following standards or other normative documents:

Table 18-1 Applicable Medical Standards

Emissions	Immunity
EN 60601-1-2: 2007	EN 60601-1-2: 2007
CISPR 11:2003+A1:2004+A2:2006	EN 61000-4-2: 2009
EN 61000-3-2: 2006 + A1: 2009 + A2: 2009	EN 61000-4-3: 2006 + A1: 2008
EN 61000-3-3: 2008	EN 61000-4-4: 2004 + A1: 2010
	EN 61000-4-5: 2006
	EN 61000-4-6: 2009
	EN 61000-4-8: 1994 + A1: 2001
	EN 61000-4-11: 2004

Table 18-2 Applicable ITE Standards

Emissions	Immunity
FCC Part 15 Subpart B	EN 55024: 1998 +A1: 2001 +A2: 2003
Industry Canada ICES-003 Issue 4 February 2004	EN 61000-4-2: 2009
CISPR 22: 2005 + A1: 2005 + A2: 2006 Information Technology Equipment	EN 61000-4-3: 2006 + A1: 2008
VCCI V-3/2010.04	EN 61000-4-4: 2004 + A1: 2010
AS/NZS CISPR 22: 2009	EN 61000-4-5: 2006
EN 55022: 2006 + A1:2007	EN 61000-4-6: 2009
EN 61000-3-2: 2006 + A1: 2009 + A2: 2009	EN 61000-4-8: 1994 + A1: 2001
EN 61000-3-3: 2008	EN 61000-4-11: 2004

Note: In the event of an ESD surge to the unit, a full power cycle may need on the unit for it to regain its full functionality.

Table 18-3 Regulatory Compliance

Standard	Description
United States: UL 60950-1: 2nd edition	Standard for Safety for Information Technology Equipment – Safety – Part 1: General Requirements
United States: UL 60601-1: 1st edition	Standard for Safety for Medical Electrical Equipment, Part 1: General Requirements for Safety
Canada: CAN/CSA-C22.2 No. 60950-1-07 2nd edition	Standard for Safety for Information Technology Equipment – Safety – Part 1: General Requirements
Canada: CAN/CSA C22.2 No. 601.1: 1990	Medical Electrical Equipment, Part 1: General Requirements for Safety
International: IEC 60601-1: 1998 (2nd edition)	Standard for Safety for Medical Electrical Equipment, Part 1: General Requirements for Safety
International: IEC with Japan Deviations JIS T 0601-1:1999	Medical Electrical Equipment -- Part 1: General Requirements for Safety
International: Japan VCCI V-3/2008.04	VCCI Japan
International: Australia AS/NZS CISPR 22: 2006	C-Tick Australia/New Zealand

Manufacturer's Contact:

Lantronix
 167 Technology Drive, Irvine, CA 92618 USA
 Tel: 949-453-3990
 Fax: 949-450-7249

Figure 18-4 Suppliers Declaration of Conformity



SUPPLIERS DECLARATION OF CONFORMITY

We, Lantronix, hereby declare that the product listed below, to which this Declaration of Conformity relates, is in conformity with the Standards and other Normative Documents listed below:

Type of Product: Multi-port Ethernet Device Server,
 Product number: EDS-MD
 Rated: 100-240 Vac, 50/60 Hz, 0.4A
 Intended use: Commercial installations, indoor use
 Standards

- Safety:** Low Voltage Directive (2006/95/EC),
- EN 60601-1: 1990 + am1 and am2
 - UL 60950-1, 2nd Edition, 2007-10-31
 - UL 60601-1 (1st edition)
 - CSA C22.2 No. 60950-1-07, 2nd Edition, 2006-07
 - CAN/CSA C22.2 601.1-M90
 - CAN/CSA C22.2 601.1S1-94
 - CAN/CSA C22.2 601.1B-98

EMC: EMC Directive 2004/108/EC

<u>Emissions</u>	<u>Immunity</u>
FEDERAL COMMUNICATIONS COMMISSION PART 15 SUBPART B CLASS A	EN 60601-1-2: 2007
INDUSTRY CANADA, ICES-003 Issue 4 February 2004 CLASS A	EN 55024: 1998 +A1: 2001 +A2: 2003
CISPR 22: 2005 +A1: 2005 + A2: 2006 Information Technology Equipment	EN 61000-4-2: 2009
VCCI V-3/2010.04 CLASS A	EN 61000-4-3: 2006 + A1: 2008
AS/NZS CISPR 22: 2009 CLASS A	EN 61000-4-4: 2004 + A1: 2010
EN55022: 2006 +A1: 2007 Class A	EN 61000-4-5: 2006
EN61000-3-2: 2006 + A1: 2009 + A2: 2009 Class A	EN 61000-4-6: 2009
EN61000-3-3: 2008	EN 61000-4-8: 1994 + A1: 2001
EN 60601-1-2: 2007	EN 61000-4-11: 2004
CISPR 11:2003+A1:2004+A2:2006	

"Lantronix, 167 Technology Drive, Irvine, CA 92618, USA declares that the equipment specified above conforms to the referenced EU Directives and Harmonized Standards."

Signature: Daryl R. Miller Date: 11-11-2011

Name: Daryl R. Miller Title: VP of Engineering

RoHS Notice

All Lantronix products in the following families are China RoHS-compliant and free of the following hazardous substances and elements:

- Lead (Pb)
 - Cadmium (Cd)
- Mercury (Hg)
 - Hexavalent Chromium (Cr (VI))
- Polybrominated biphenyls (PBB)
 - Polybrominated diphenyl ethers (PBDE)

Product Family Name	Toxic or hazardous Substances and Elements					
	Lead (Pb)	Mercury (Hg)	Cadmium (Cd)	Hexavalent Chromium (Cr (VI))	Polybrominated biphenyls (PBB)	Polybrominated diphenyl ethers (PBDE)
UDS1100 and 2100	0	0	0	0	0	0
EDS	0	0	0	0	0	0
MSS100	0	0	0	0	0	0
IntelliBox	0	0	0	0	0	0
XPress DR & XPress-DR+	0	0	0	0	0	0
SecureBox 1101 & 2101	0	0	0	0	0	0
WiBox	0	0	0	0	0	0
UBox	0	0	0	0	0	0
MatchPort	0	0	0	0	0	0
SLC	0	0	0	0	0	0
XPort	0	0	0	0	0	0
WiPort	0	0	0	0	0	0
SLB	0	0	0	0	0	0
SLP	0	0	0	0	0	0
SCS	0	0	0	0	0	0
SLS	0	0	0	0	0	0
DSC	0	0	0	0	0	0
PremierWave	0	0	0	0	0	0
Micro125	0	0	0	0	0	0

O: toxic or hazardous substance contained in all of the homogeneous materials for this part is below the limit requirement in SJ/T11363-2006.

X: toxic or hazardous substance contained in at least one of the homogeneous materials used for this part is above the limit requirement in SJ/T11363-2006.

Appendix D: Lantronix Cables, Adapters and Serial Port Pinouts

Lantronix cables and adapters for use with EDS-MD4, EDS-MD8 and EDS-MD16 are listed here according to part number and application.

Cables and Adapters

Table 19-1 Lantronix Cables and Adapters

Lantronix P/N	Description	Applications
500-153	RJ45-to DB9F	Connects the RJ45 RS232 serial ports of EDS-MD to a DB9M DTE interface of a PC or serial device to check that serial ports in the EDS-MD are functioning properly.
200.2066A	Adapter RJ45-to-DB25M	Allows a standard straight-pinned CAT5 cable to connect the EDS-MD RJ45 serial ports to the DB25F DTE interface of a serial device.
200.2067A	Adapter RJ45-to-DB25F	Allows a standard straight-pinned CAT5 cable to connect the EDS-MD RJ45 serial ports to the DB25M DTE interface of a serial device.
200.2069A	Adapter RJ45-to-DB9M	Allows a standard straight-pinned CAT5 cable to connect the EDS-MD RJ45 serial ports to the DB9F DTE interface of a serial device.
200.2070A	Adapter RJ45-to-DB9F	Allows a standard straight-pinned CAT5 cable to connect the EDS-MD to the DB9M DTE interface of a PC or serial device.
200.2071	Adapter RJ45-to-DB9M	Allows a standard straight-pinned CAT5 cable to connect the EDS-MD RJ45 serial ports to the DB9F DCE interface of a serial device.
200.2072	Adapter RJ45-to-DB9F	Allows a standard straight-pinned CAT5 cable to connect the EDS-MD to the DB9M DCE interface of a PC or serial device.
200.2073	Adapter RJ45-to-DB25M	Allows a standard straight-pinned CAT5 cable to connect the EDS-MD RJ45 serial ports to the DB25F DCE interface of a serial device.
200.2074	Adapter RJ45-to-DB25F	Allows a standard straight-pinned CAT5 cable to connect the EDS-MD RJ45 serial ports to the DB25M DCE interface of a serial device.
930-073-R	Power Cord, Hospital Grade US	Conducts power to the EDS-MD, for the United States.
930-074-R	Power Cord, Europe	Conducts power to the EDS-MD, for Europe.
930-075-R	Power Cord, United Kingdom	Conducts power to the EDS-MD, for the United Kingdom.
930-076-R	Power Cord, Australian	Conducts power to the EDS-MD, for Australia.
930-077-R	Power Cord, Israel	Conducts power to the EDS-MD, for Israel.
ADP010104-01	Adapter "Rolled" RJ45-to-RJ45	Allows a standard straight-pinned CAT5 cable to connect the EDS-MD to an RJ45 console port on products from Cisco and other manufacturers.

Adapters and Serial Port Pinouts

Figure 19-2 RJ45 Receptacle to DB25M DTE Adapter (PN 200.2066A)

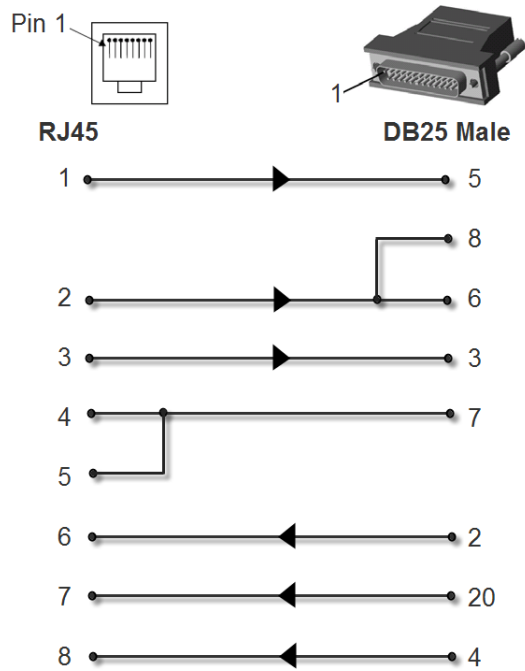

Figure 19-3 RJ45 Receptacle to DB25M DCE Adapter (PN 200.2073)

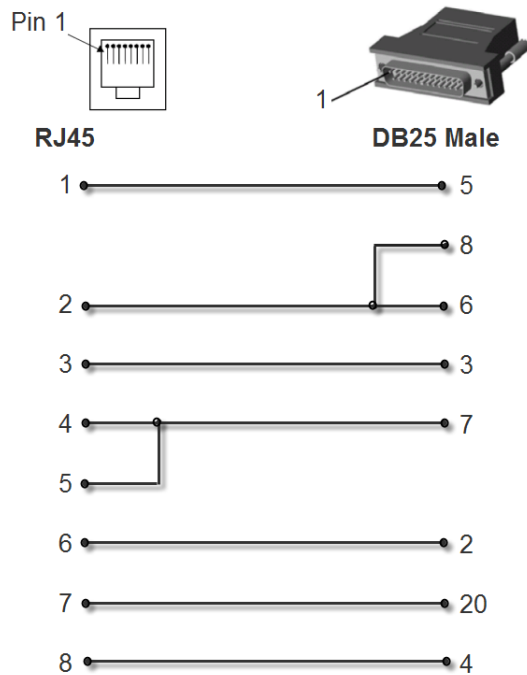

Figure 19-4 RJ45 Receptacle to DB25F DTE Adapter (PN 200.2067A)

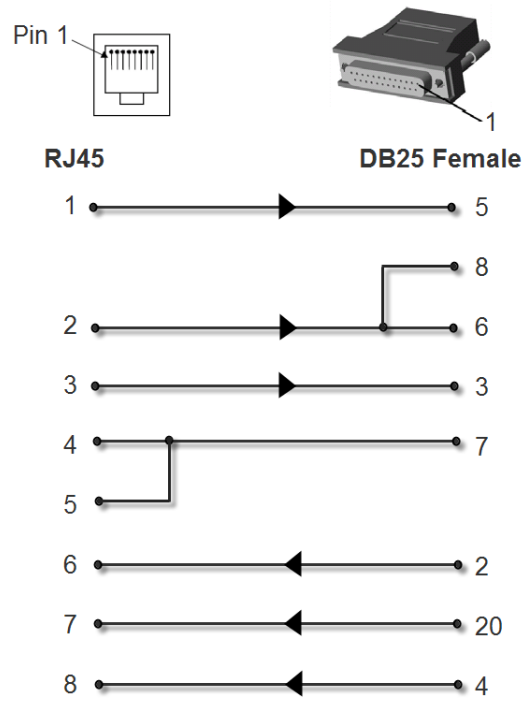

Figure 19-5 RJ45 Receptacle to DB25F DCE Adapter (PN 200.2074)

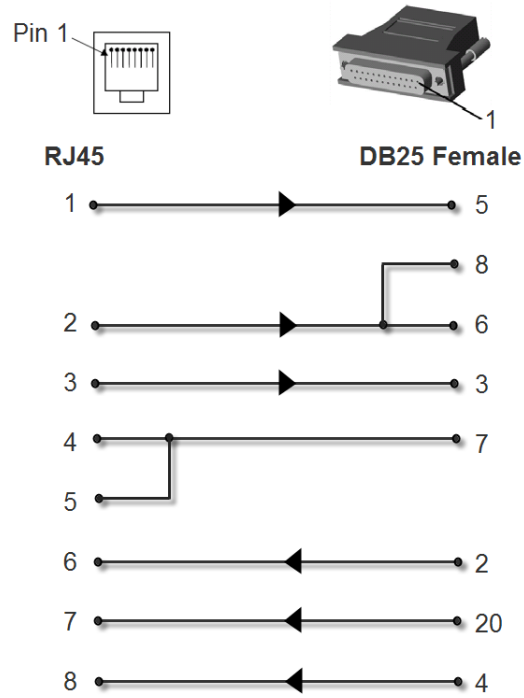

Figure 19-6 RJ45 Receptacle to DB9M DTE Adapter (PN 200.2069A)

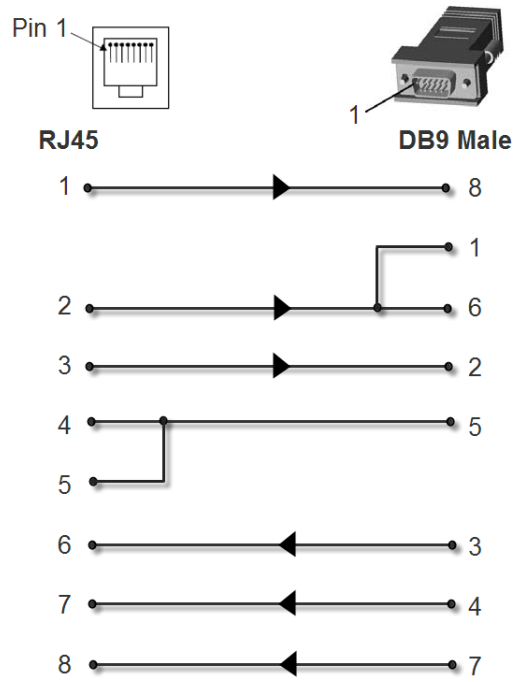

Figure 19-7 RJ45 Receptacle to DB9M DCE Adapter (PN 200.2071)

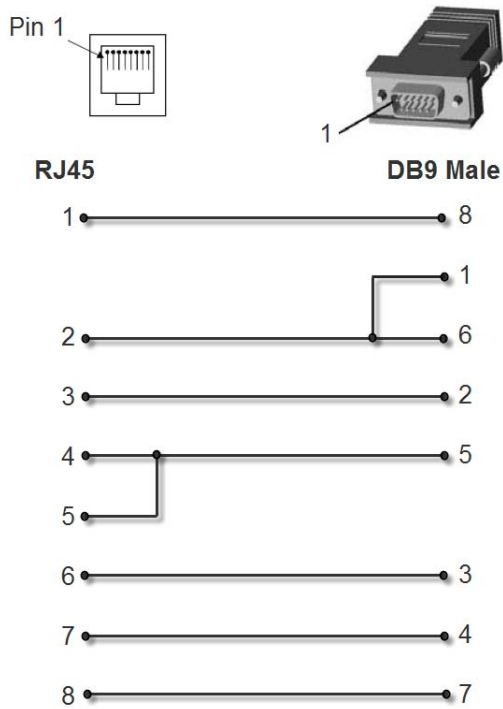

Figure 19-8 RJ45 Receptacle to DB9F DTE Adapter (PN 200.2070A)

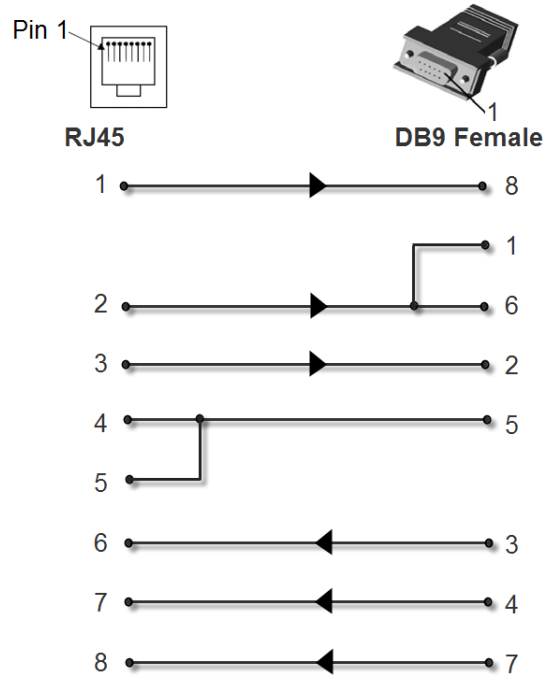

Figure 19-9 RJ45 Receptacle to DB9F DCE Adapter (PN 200.2072)

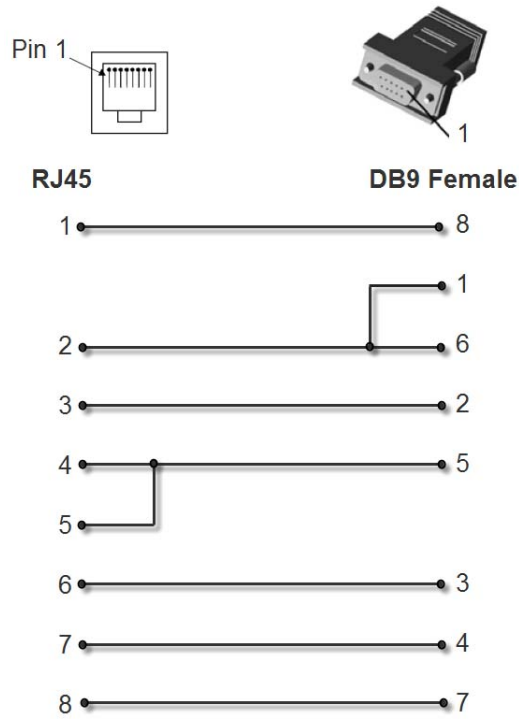
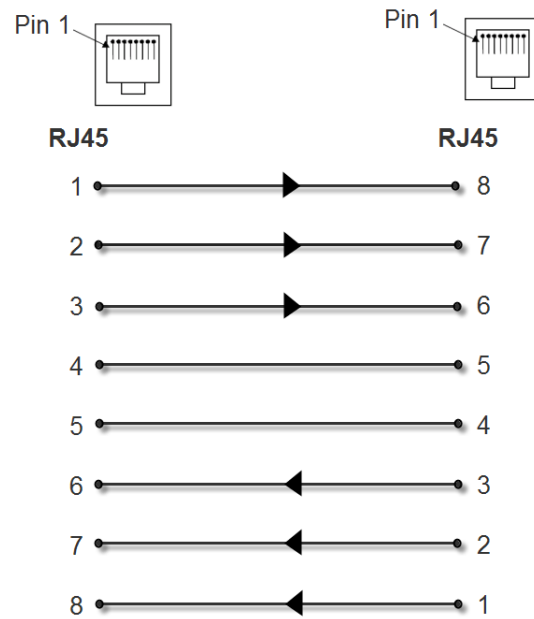

Figure 19-10 RJ45 to RJ45 Adapter (ADP010104-01)



Note: The cable ends of the ADP010104-01 are an RJ45 socket on one end and a RJ45 plug on the other instead of RJ45 sockets on both ends.

Free Manuals Download Website

<http://myh66.com>

<http://usermanuals.us>

<http://www.somanuals.com>

<http://www.4manuals.cc>

<http://www.manual-lib.com>

<http://www.404manual.com>

<http://www.luxmanual.com>

<http://aubethermostatmanual.com>

Golf course search by state

<http://golfingnear.com>

Email search by domain

<http://emailbydomain.com>

Auto manuals search

<http://auto.somanuals.com>

TV manuals search

<http://tv.somanuals.com>