

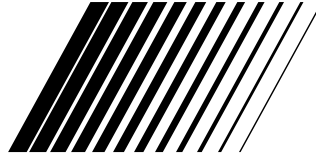

# JVC



## COMPACT VHS CAMCORDER

# GR-AX910 GR-AX810

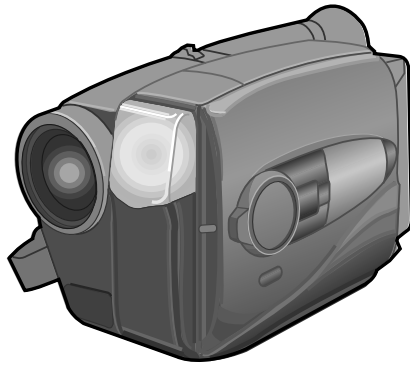

*Compact VHS*



## INSTRUCTIONS

**For Customer Use:**

Enter below the Serial Nos. of the GR-AX910U/GR-AX810U camcorder and the AA-V11U AC Power Adapter/Charger.

The serial numbers are located on the bottom of the GR-AX910U/GR-AX810U, and the AA-V11U.

Model No. GR-AX910U/GR-AX810U

AA-V11U

Serial No. \_\_\_\_\_

YU30052-537

**Dear Customer,**

Thank you for purchasing the JVC Compact VHS camcorder. Before use, please read the safety information and precautions contained in the following pages to ensure safe use of your new camcorder.

**Using This Instruction Manual**



- All major sections and subsections are listed in the Table Of Contents (☞ pg. 7).
- Notes appear after most subsections. Be sure to read these as well.
- Basic and advanced features/operation are separated for easier reference.

**It is recommended that you . . .**

- ..... refer to the Index (☞ pgs. 49 – 52) and familiarize yourself with button locations, etc. before use.
- ..... read thoroughly the Safety Precautions and Safety Instructions that follow. They contain extremely important information regarding the safe use of your new camcorder.

You are recommended to carefully read the cautions on pages 53 and 54 before use.

## SAFETY PRECAUTIONS

	<b>CAUTION</b> RISK OF ELECTRIC SHOCK DO NOT OPEN	
<p>CAUTION: TO REDUCE THE RISK OF ELECTRIC SHOCK, DO NOT REMOVE COVER (OR BACK). NO USER-SERVICEABLE PARTS INSIDE. REFER SERVICING TO QUALIFIED SERVICE PERSONNEL.</p>		



The lightning flash with arrowhead symbol, within an equilateral triangle, is intended to alert the user to the presence of uninsulated "dangerous voltage" within the product's enclosure that may be of sufficient magnitude to constitute a risk of electric shock to persons.



The exclamation point within an equilateral triangle is intended to alert the user to the presence of important operating and maintenance (servicing) instructions in the literature accompanying the appliance.

The AA-V11U AC Power Adapter/Charger should be used with:  
AC 120 V~, 60 Hz in the USA and Canada,  
AC 110 – 240 V~, 50/60 Hz in other countries.

**CAUTION (applies to the AA-V11U)**  
TO PREVENT ELECTRIC SHOCK MATCH WIDE BLADE OF PLUG TO WIDE SLOT, FULLY INSERT.

**ATTENTION (s'applique à l'AA-V11U)**  
POUR ÉVITER LES CHOCS ÉLECTRIQUES, INTRODUIRE LA LAME LA PLUS LARGE DE LA FICHE DANS LA BORNE CORRESPONDANTE DE LA PRISE ET POUSSER JUSQU'AU FOND.

**WARNING:**  
**TO PREVENT FIRE OR SHOCK HAZARD, DO NOT EXPOSE THIS UNIT TO RAIN OR MOISTURE.**

**Warning on lithium battery**

The battery used in this device may present a fire or chemical burn hazard if mistreated. Do not recharge, disassemble, heat above 100°C (212°F) or incinerate. Replace battery with Panasonic (Matsushita Electric), Sanyo or Maxell CR2025; use of another battery may present a risk of fire or explosion.

- Dispose of used battery promptly.
- Keep away from children.
- Do not disassemble and do not dispose of in fire.

**NOTES:**

- The rating plate (serial number plate) and safety caution are on the bottom and/or the back of the main unit.
- The rating plate (serial number plate) of the AC Power Adapter/Charger is on its bottom.

This Class B digital apparatus meets all requirements of the Canadian Interference – Causing Equipment Regulations.

“Cet appareil numérique de la classe B respecte toutes les exigences du Règlement sur le matériel brouilleur du Canada.”

This camcorder is designed to be used with NTSC-type color television signals. It cannot be used for playback with a television of a different standard. However, live recording and viewfinder playback are possible anywhere. Use the BN-V11U/V12U/V22U/V25U battery packs and, to recharge them, the provided multi-voltage AC Power Adapter/Charger. (An appropriate conversion adapter may be necessary to accommodate different designs of AC outlets in different countries.)

**ATTENTION:**

The product that you have purchased is powered by a rechargeable battery. The battery is recyclable. At the end of its useful life, under various state and local laws, it may be illegal to dispose of this battery into the municipal waste stream. Check with your local solid waste officials for details in your area for recycling options or proper disposal.



# IMPORTANT PRODUCT SAFETY INSTRUCTIONS

Electrical energy can perform many useful functions. But improper use can result in potential electrical shock or fire hazards. This product has been engineered and manufactured to assure your personal safety. In order not to defeat the built-in safeguards, observe the following basic rules for its installation, use and servicing.

### ATTENTION:

Follow and obey all warnings and instructions marked on your product and its operating instructions. For your safety, please read all the safety and operating instructions before you operate this product and keep this manual for future reference.

## INSTALLATION

### 1. Grounding or Polarization

- (A) Your product may be equipped with a polarized alternating-current line plug (a plug having one blade wider than the other). This plug will fit into the power outlet only one way. This is a safety feature. If you are unable to insert the plug fully into the outlet, try reversing the plug. If the plug should still fail to fit, contact your electrician to replace your obsolete outlet. Do not defeat the safety purpose of the polarized plug.
- (B) Your product may be equipped with a 3-wire grounding-type plug, a plug having a third (grounding) pin. This plug will only fit into a grounding-type power outlet. This is a safety feature. If you are unable to insert the plug into the outlet, contact your electrician to replace your obsolete outlet. Do not defeat the safety purpose of the grounding-type plug.

### 2. Power Sources

Operate your product only from the type of power source indicated on the marking label. If you are not sure of the type of power supply to your home, consult your product dealer or local power company. If your product is intended to operate from battery power, or other sources, refer to the operating instructions.

### 3. Overloading

Do not overload wall outlets, extension cords, or integral convenience receptacles as this can result in a risk of fire or electric shock.

### 4. Power Cord Protection

Power supply cords should be routed so that they are not likely to be walked on or pinched by items placed upon or against them, paying particular attention to cords at plugs, convenience receptacles, and the point where they exit from the product.

### 5. Ventilation

Slots and openings in the cabinet are provided for ventilation. To ensure reliable operation of the product and to protect it from overheating, these openings must not be blocked or covered.

- Do not block the openings by placing the product on a bed, sofa, rug or other similar surface.
- Do not place the product in a built-in installation such as a bookcase or rack unless proper ventilation is provided or the manufacturer's instructions have been adhered to.

### 6. Wall or Ceiling Mounting

The product should be mounted to a wall or ceiling only as recommended by the manufacturer.

## ANTENNA INSTALLATION INSTRUCTIONS

### 1. Outdoor Antenna Grounding

If an outside antenna or cable system is connected to the product, be sure the antenna or cable system is grounded so as to provide some protection against voltage surges and built-up static charges. Article 810 of the National Electrical Code, ANSI/NFPA 70, provides information with regard to proper grounding of the mast and supporting structure, grounding of the lead-in wire to an antenna discharge unit, size of grounding conductors, location of antenna discharge unit, connection to grounding electrodes, and requirements for the grounding electrode.

### 2. Lightning

For added protection for this product during a lightning storm, or when it is left unattended and unused for long periods of time, unplug it from the wall outlet and disconnect the antenna or cable system. This will prevent damage to the product due to lightning and power-line surges.

### 3. Power Lines

An outside antenna system should not be located in the vicinity of overhead power lines or other electric light or power circuits, or where it can fall into such power lines or circuits. When installing an outside antenna system, extreme care should be taken to keep from touching such power lines or circuits as contact with them might be fatal.

EXAMPLE OF ANTENNA GROUNDING AS PER NATIONAL ELECTRICAL CODE, ANSI/NFPA 70

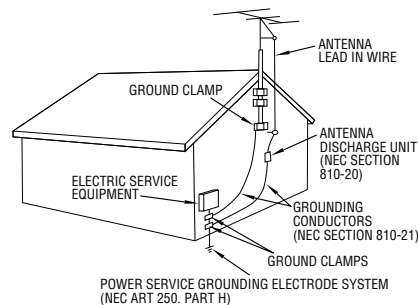

NEC - NATIONAL ELECTRICAL CODE

# 4

## USE

### 1. Accessories

#### To avoid personal injury:

- Do not place this product on an unstable cart, stand, tripod, bracket or table. It may fall, causing serious injury to a child or adult, and serious damage to the product.
- Use only with a cart, stand, tripod, bracket, or table recommended by the manufacturer or sold with the product.
- Use a mounting accessory recommended by the manufacturer and follow the manufacturer's instructions for any mounting of the product.
- Do not try to roll a cart with small casters across thresholds or deep-pile carpets.

### 2. Product and Cart Combination

A product and cart combination should be moved with care. Quick stops, excessive force, and uneven surfaces may cause the product and cart combination to overturn.

### 3. Water and Moisture

Do not use this product near water—for example, near a bath tub, wash bowl, kitchen sink or laundry tub, in a wet basement, or near a swimming pool and the like.

PORTABLE CART WARNING  
(Symbol provided by RETAC)



### 4. Object and Liquid Entry

Never push objects of any kind into this product through openings as they may touch dangerous voltage points or short-out parts that could result in a fire or electric shock. Never spill liquid of any kind on the product.

### 5. Attachments

Do not use attachments not recommended by the manufacturer of this product as they may cause hazards.

### 6. Cleaning

Unplug this product from the wall outlet before cleaning. Do not use liquid cleaners or aerosol cleaners. Use a damp cloth for cleaning.

### 7. Heat

The product should be situated away from heat sources such as radiators, heat registers, stoves, or other products (including amplifiers) that produce heat.

## SERVICING

### 1. Servicing

If your product is not operating correctly or exhibits a marked change in performance and you are unable to restore normal operation by following the detailed procedure in its operating instructions, do not attempt to service it yourself as opening or removing covers may expose you to dangerous voltage or other hazards. Refer all servicing to qualified service personnel.

### 2. Damage Requiring Service

Unplug this product from the wall outlet and refer servicing to qualified service personnel under the following conditions:

- a. When the power supply cord or plug is damaged.
- b. If liquid has been spilled, or objects have fallen into the product.
- c. If the product has been exposed to rain or water.
- d. If the product does not operate normally by following the operating instructions. Adjust only those controls that are covered by the operating instructions as an improper adjustment of other controls may result in damage and will often require extensive work by a qualified technician to restore the product to its normal operation.
- e. If the product has been dropped or damaged in any way.
- f. When the product exhibits a distinct change in performance—this indicates a need for service.

### 3. Replacement Parts

When replacement parts are required, be sure the service technician has used replacement parts specified by the manufacturer or have the same characteristics as the original part. Unauthorized substitutions may result in fire, electric shock or other hazards.

### 4. Safety Check

Upon completion of any service or repairs to this product, ask the service technician to perform safety checks to determine that the product is in safe operating condition.

**SUPPLY POWER**

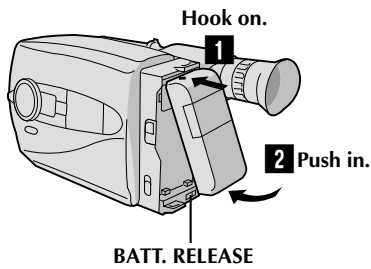

**Using the battery pack**

- 1 Hook-on the battery pack's top end to the camcorder. (Charging procedure, P. 8)
- 2 Push in the battery pack until it locks into place.

**To remove the battery pack**

Slide BATT. RELEASE and pull out the battery pack.

**INSERTING A VIDEO CASSETTE**

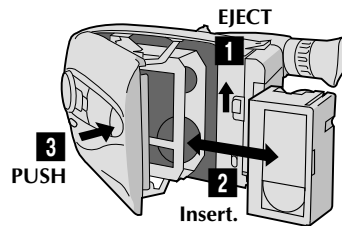

- 1 Slide EJECT.
- 2 Insert a video cassette.
- 3 Press PUSH.  
(For more details, P. 13)

**PLAYBACK**

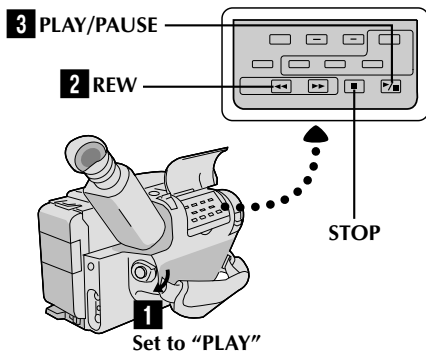

- 1 Set the power switch to "PLAY".
  - 2 Press **REW**.  
— The tape will automatically stop at the beginning of the tape.
  - 3 Press **PLAY/PAUSE**.  
— Playback starts and the playback picture appears in the viewfinder.
- To stop playback, press **STOP**.  
(For more details, P. 38.)

■ Or simply play back the tape on a VHS VCR using the Cassette Adapter (VHS Playpak). P. 36

**SHOOTING**

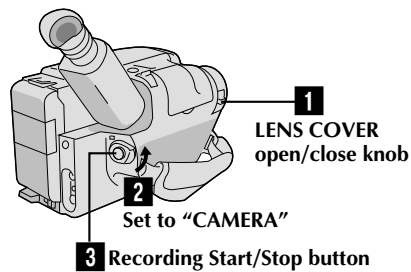

- 1 Slide the LENS COVER open/close knob to open the lens cover.
  - 2 Set the power switch to "CAMERA".  
— The power indicator will light and an image will appear in the viewfinder.
  - 3 Press **RECORDING START/STOP**.  
— Recording starts.
- To stop recording temporarily, momentarily press the Recording Start/Stop button once again.  
(For more details, P. 16)



# 6

## MAJOR FEATURES

### REMEMBER

### The Logical Choice

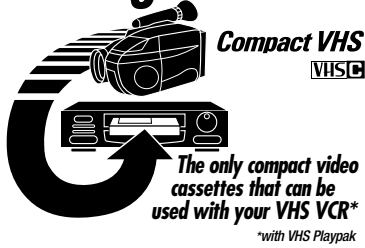

### Program AE with Special Effects (pg. 26)

- Cinema ■ Sepia ■ Twilight ■ Sports
- High Speed (1/2000 sec.) Shutter

### Digital Wipes and Fades (pg. 28)

- Black Fader ● Blue Fader
- Mosaic Fader ● Shutter Wipe
- Slide Wipe

### Built-In Auto Light (pg. 19)

### Multi Function Control (pg. 22 - 35)

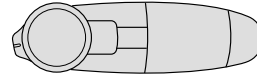

### Digital Hyper Zoom (pg. 17)

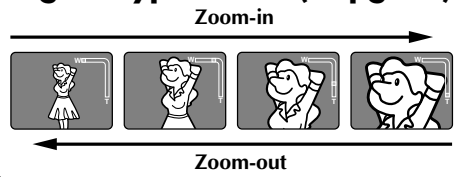

### Digital Image Stabilizer (pg. 22)

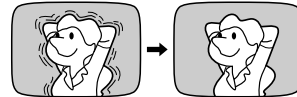

### Random Assemble Editing (pg. 40 - 43)

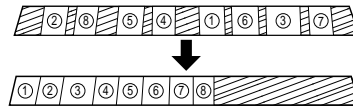

### PROVIDED ACCESSORIES

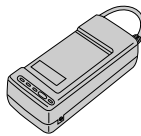

• AC Power Adapter/Charger AA-V11U

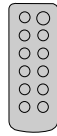

• Remote Control Unit RM-V705U

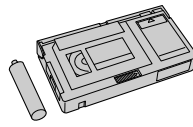

• Cassette Adapter (VHS PlayPak) C-P7U

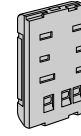

• Battery Pack BN-V11U



• DC Cord



• Lithium Battery CR2025

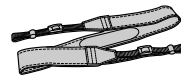

• Shoulder Strap



Cassettes marked **VHS** can be used with this camcorder.



# CONTENTS

# 7

<b>GETTING STARTED</b>	<b>8</b>
Power .....	8
Clock (Lithium) Battery Removal/Insertion .....	10
Viewfinder Adjustment .....	10
Date/Time Setting .....	11
Tape Length Setting .....	12
Recording Mode Setting .....	13
Loading/Unloading A Cassette .....	13
Grip Adjustment .....	14
Shoulder Strap Attachment .....	14
Tripod Mounting .....	14
Using The RM-V705U Remote Control Unit .....	15
<b>RECORDING</b>	<b>16</b>
Basic Recording .....	16
Basic Features .....	17
Video Light .....	19
Advanced Features .....	20
Date/Time Insert .....	20
Quick Rec. ....	21
Digital Image Stabilizer (D.I.S.) .....	22
Exposure Control .....	22
White Balance Adjustment .....	23
Focusing .....	24
Program AE With Special Effects .....	26
Fade/Wipe .....	28
Using Menu For Detailed Adjustment .....	30
Instant Titles .....	32
Self-Timer .....	34
Animation .....	35
Time Lapse .....	35
<b>PLAYBACK</b>	<b>36</b>
Using The Cassette Adapter .....	36
Basic Connections .....	37
Basic Playback .....	38
Features .....	39
<b>EDITING</b>	<b>40</b>
Tape Dubbing .....	40
Random Assemble Editing [R.A.Edit] .....	40
Insert Editing .....	44
Audio Dubbing .....	45
<b>USER MAINTENANCE</b>	<b>46</b>
<b>TROUBLESHOOTING</b>	<b>47</b>
<b>INDEX</b>	<b>49</b>
Controls .....	49
Connectors .....	50
Indicators .....	50
Other Parts .....	50
Viewfinder .....	51
Terms .....	52
<b>CAUTIONS</b>	<b>53</b>
<b>SPECIFICATIONS</b>	<b>55</b>
<b>ESPAÑOL</b>	<b>56</b>
<b>FOR SERVICING</b>	<b>58</b>
<b>WARRANTY</b>	<b>59</b>

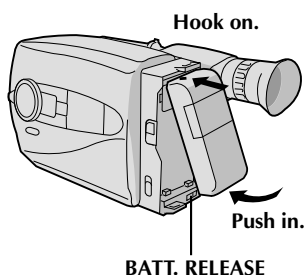
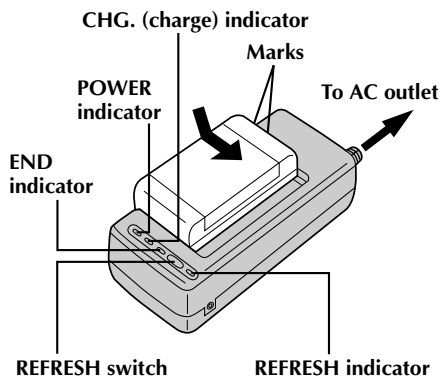

**ATTENTION:**

Before detaching the power source, make sure that the camcorder's power is turned off. Failure to do so can result in a camcorder malfunction.

**\*\*REFRESH**

The AC power adapter features a REFRESH function that allows you to fully discharge the battery pack before recharging.

**To discharge the battery . . .**

..... attach the battery pack to the adapter as shown in the illustration to the left. Then push REFRESH. The REFRESH indicator lights when discharging starts, and goes out when discharging is complete.

**Power**

This camcorder's 3-way power supply system lets you choose the most appropriate source of power.

**NOTES:**

- No function is available without power supply.
- Use only specified power supply.
- Do not use provided power supply units with other equipment.

**CHARGING THE BATTERY PACK****1 SUPPLY POWER**

1 Connect the charger's AC power cord to a wall outlet. The power indicator lights.

**2 ATTACH BATTERY PACK**

2 Align the marks and slide the battery pack in the direction of the arrow until it locks in place. The CHG. indicator lights.

**3 DETACH BATTERY PACK**

3 When charging is completed, the END indicator lights. Slide the battery pack opposite the direction of the arrow.

BATT. PACK	CHARGE	DISCHARGE
BN-V11U	approx. 1 hr. 10 min.	approx. 3 hrs. 30 min.
BN-V12U	approx. 1 hr. 10 min.	approx. 3 hrs. 30 min.
BN-V22U	approx. 2 hrs. 10 min.	approx. 7 hrs.
BN-V25U	approx. 2 hrs. 40 min.	approx. 10 hrs.

**USING THE BATTERY PACK****1 ATTACH BATTERY PACK**

1 Hook its top end to the camcorder and push the battery pack in until it locks in place.

**2 DETACH BATTERY PACK**

2 Slide BATT. RELEASE and pull out the battery pack.

**APPROXIMATE RECORDING TIME**

BATT. PACK	GR-AX910	GR-AX810
BN-V11U	1 hr. (35 min.)	1 hr. 5min. (35 min.)
BN-V12U	1 hr. (35 min.)	1 hr. 5min. (35 min.)
BN-V22U	2 hrs. 10 min. (1 hr. 20 min.)	2 hrs. 15 min. (1 hr. 25 min.)
BN-V25U	2 hrs. 50 min. (1 hr. 50 min.)	3 hrs. (1 hr. 50 min.)

( ) : When the Video Light is on



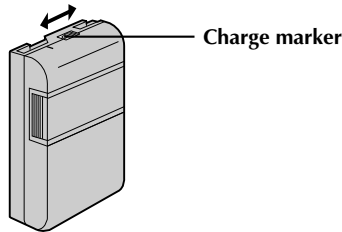

**\*\*CHARGE MARKER**

A charge marker is provided on the battery pack to help you remember whether it has been charged or not. Two colors are provided (red and black)—you choose which one means charged and which means discharged.

**NOTES:**

- The recording time per charge is affected by such factors as the time spent in Record/Standby mode and the frequency of zooming. It is safer to have spare battery packs.
- Charging times noted on page 8 are for fully discharged battery pack, and discharging times are for fully charged battery pack.
- Charging and discharging times vary according to the ambient temperature and the status of the battery pack.
- Remember to set the charge marker after charging a battery pack or after detaching a discharged one from your camcorder.
- Perform the REFRESH function after no less than 5 chargings.
- High temperatures can damage the battery pack, so use only where good ventilation is available. Don't allow it to discharge in container, such as a bag.
- If you stop recharging or discharging part way through, make sure to remove the battery pack before unplugging the adapter's AC cord.
- Remove the battery pack from the adapter immediately after discharging.
- To avoid interference with reception, do not use the AC Power Adapter/Charger near a radio.
- Make sure you unplug the DC cord before charging or discharging the battery pack.
- A blinking CHG. indicator means that the battery pack has become hot. Wait until it cools down to continue.
- The CHG. indicator may not light properly with a brand new battery pack, or with one that's been stored for an extended period. In this case, remove and reattach the battery pack and recharge it. The CHG. indicator should light during recharging. If not, contact your nearest JVC dealer.

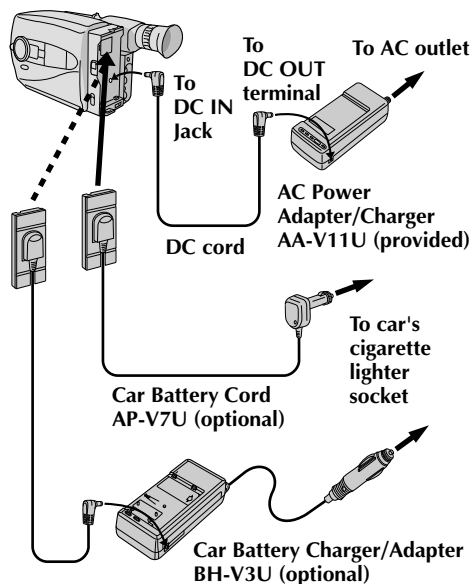

**USING A CAR BATTERY**

Use the optional Car Battery Cord or Car Battery Charger/Adapter (connect as shown in the illustration to the left).

**NOTES:**

- When using the car battery, leave the engine idling.
- The optional Car Battery Charger (BH-V3U) can also be used to charge the battery pack.
- When using the optional Car Battery Charger or Car Battery Cord (AP-V7U), refer to the respective instruction booklet.

**USING AC POWER**

Use the AC Power Adapter (connect as shown in the illustration to the left).

**NOTE:**

The supplied AC Power Adapter/Charger features automatic voltage selection in the AC range from 110 V to 240 V.



# 10

## GETTING STARTED (cont.)

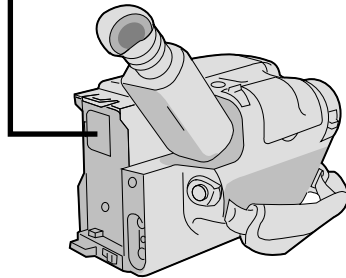
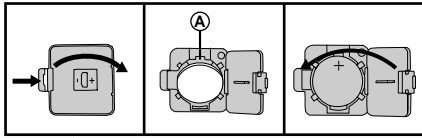

### Clock (Lithium) Battery Insertion/Removal

This battery is necessary for clock operation and to perform date/time settings.

- 1 SWITCH OFF POWER**  
Switch off the unit's power and remove the power supply unit.
- 2 OPEN COVER**  
Open the clock battery compartment cover while pressing the release tab.
- 3 REMOVE BATTERY (when replacing)**  
Insert a pointed, non-metallic object between the battery and the compartment (A) and pull the battery out.
- 4 INSERT BATTERY**  
Ensuring the plus (+) side is up, insert a CR2025 lithium battery and push it in.
- 5 CLOSE COVER**  
Close the compartment cover until it clicks in place.

### NOTE:

See "SAFETY PRECAUTIONS" (pg. 2) for information on safe handling of lithium batteries.

### Viewfinder Adjustment

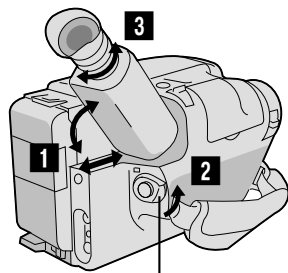

Set POWER to "CAMERA".

- 1 POSITION VIEWFINDER**  
Adjust the viewfinder manually for best viewability (see illustration at left).
- 2 SELECT MODE**  
Set the power switch to CAMERA.
- 3 ADJUST DIOPTR**  
Turn the diopter adjustment control until the indications in the viewfinder are clearly focused.

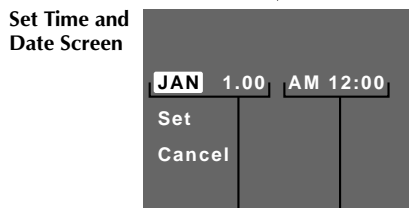
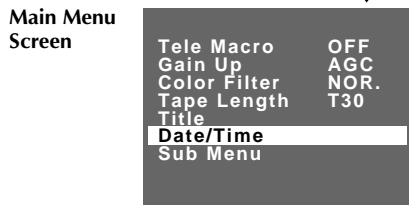
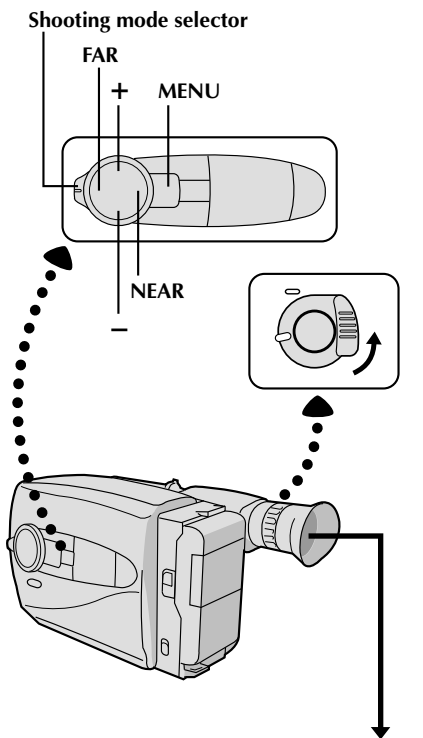

Date  
Month/Day/Year

Time  
12-hour indication with  
AM or PM

## Date/Time Setting

- 1 SELECT MODE**  
Set the Power switch to "CAMERA", and the Shooting Mode selector to "PRESET".
- 2 ACCESS MAIN MENU SCREEN**  
Press **MENU**.
- 3 SELECT FUNCTION**  
Press **-** to move the highlight bar down to "Date/Time", then press **NEAR**. The Set Date And Time screen appears.
- 4 SET DATE/TIME**  
Press **FAR** or **NEAR** until the item you want to set begins blinking, then press **+** or **-** to until the correct setting appears.
  - If you decide you want to return the date and time to the previous settings, press **FAR** or **NEAR** to move the highlight bar to "Cancel", then press **MENU**.
  - If you're satisfied with the settings, go on to step 5.
- 5 START CLOCK OPERATION**  
Once you've set the month, day, year and time, press **FAR** or **NEAR** until "Set" begins to blink, then press **MENU**. The Main Menu screen reappears.
- 6 CLOSE MAIN MENU**  
Press **MENU**.

### NOTES:

- To display the date and time in the viewfinder and on a connected TV, see "Date/Time Insert" (pg. 20).
- If, in step 4, you input an invalid date (FEB 30, JUN 31, etc.) and perform step 5, "Input Error" appears blinking at the bottom of the screen. Press **+**, **-**, **FAR** or **NEAR** to make the day blink, and input the correct number.



# 12

## GETTING STARTED (cont.)

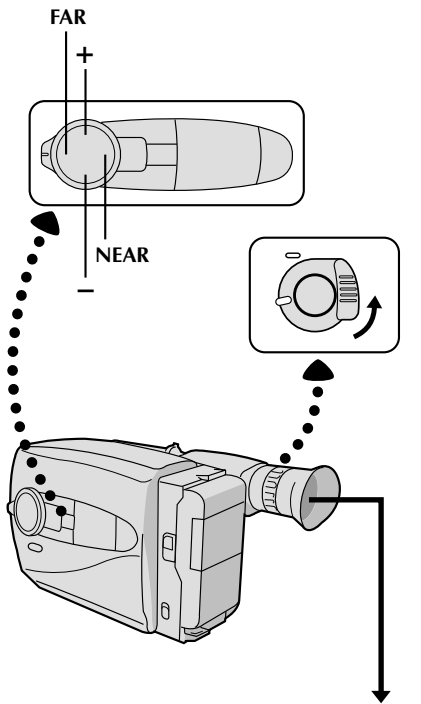

Main Menu Screen

Tele Macro	OFF
Gain Up	AGC
Color Filter	NOR.
<b>Tape Length</b>	<b>T40</b>
Title	
Date/Time	
Sub Menu	

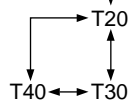

### Tape Length Setting

- 1 SELECT MODE**  
Set the Power switch to "CAMERA", and the Shooting Mode selector to "PRESET".
- 2 ACCESS MAIN MENU SCREEN**  
Press MENU.
- 3 SELECT FUNCTION**  
Press + or - to move the highlight bar to "Tape Length".
- 4 SET TAPE LENGTH**  
Press FAR or NEAR to cycle through until the correct setting appears (depending on the tape used). T20 = 20 minutes of recording time, T30 = 30 min., and T40 = 40 min. (when recording in SP mode).
- 5 CLOSE MAIN MENU**  
Press MENU.

#### NOTE:

The tape remaining time (☞ pg. 16) displayed in the viewfinder is correct only if the correct tape length has been selected.



SP/EP

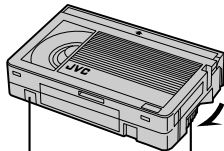
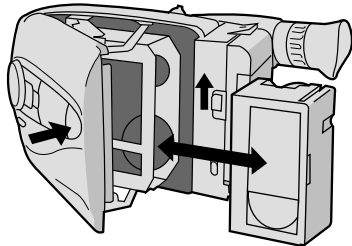
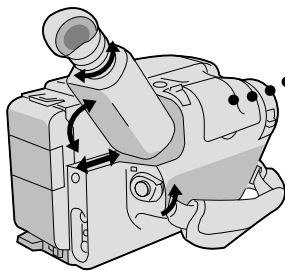
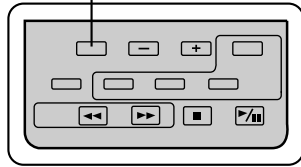

Erase Protection

Gear

Turn to take up  
slack.

## Recording Mode Setting

- 1 Pressing **SP/EP** alternates the setting between SP (standard play-provides higher picture and sound quality, better for dubbing) and EP (Extended Play-more economical, recording at 1/3 the speed of SP).

### NOTE:

If the recording mode is switched during recording, the playback picture will be blurred at the switching point.

## Loading/Unloading A Cassette

### 1 OPEN CASSETTE HOLDER

- 1 Slide **EJECT** until the holder opens. Do not use force to open.

### 2 INSERT/REMOVE CASSETTE

- 2 Make sure the label is facing outward.

### 3 CLOSE CASSETTE HOLDER

- 3 Press **PUSH** and make sure the holder is closed and locked.

### NOTES:

- A cassette holder can't be opened unless a power supply is attached.
- Make sure that the tape is not slack when loading the cassette. If there is any slack, turn the gear on the cassette in the direction of the arrow to take up the slack.
- Make sure the Erase Protection tab is present. If not, cover the hole with adhesive tape. (Some cassettes have sliding tabs – in this case, check the tab's position.)

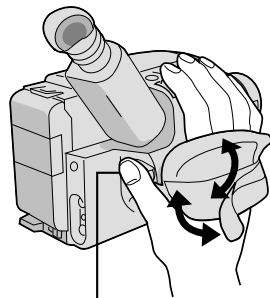

Recording Start/Stop button

### Grip Adjustment

#### EXPAND LOOP

- 1 Separate the Velcro strip.

#### INSERT HAND

- 2 Pass your right hand through the loop and grasp the grip.

#### ADJUST STRAP LENGTH

- 3 Adjust so your thumb and fingers can easily operate the Recording Start/Stop button and Power Zoom lever. Refasten the Velcro strip.

### Shoulder Strap Attachment

#### ATTACH STRAP

- 1 Following the illustration at left, thread the strap through the top of the eyelet (1), then fold it back and thread it through the keeper (2), and then through the buckle (3). Repeat the procedure to attach the other end of the strap to the other eyelet, making sure the strap isn't twisted.

#### ADJUST LENGTH

- 2 Adjust as shown in the illustration at left (1), then slide both keepers snug against the eyelets to prevent slipping (2).

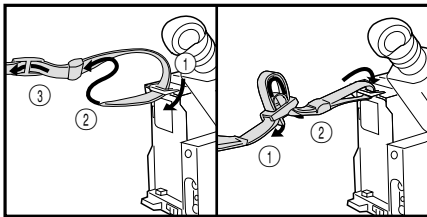

### Tripod Mounting

#### ALIGN AND TIGHTEN

- 1 Align the screw and camera direction stud on the tripod with the camera's mounting socket and stud hole. Then tighten the screw.

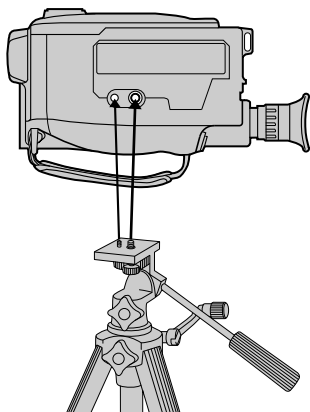

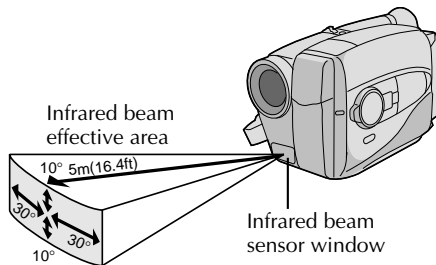

The transmitted beam may not be effective or may cause incorrect operation when the infrared beam sensor window is directly exposed to sunlight or powerful lighting.

## Using The RM-V705U Remote Control Unit

The Full-Function Remote Control Unit can operate this camcorder from a distance as well as the basic operations (PLAY, STOP, PAUSE, FF, and REW) of your VCR. This remote control unit makes additional recording functions possible.

- 1 PULL OUT BATTERY HOLDER**  
Pull out the battery holder by inserting a pointed instrument into slot (A).
  - 2 INSERT BATTERY**  
Insert the lithium battery \*(CR2025), with its plus (+) side up, into the battery holder.
  - 3 REPLACE BATTERY HOLDER**  
Insert the battery holder into the remote control unit, and push the holder until it clicks in place.
- \*Read warning on lithium battery. (P. 2)

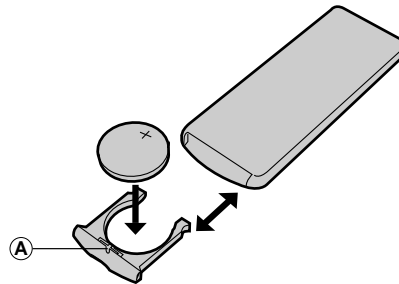
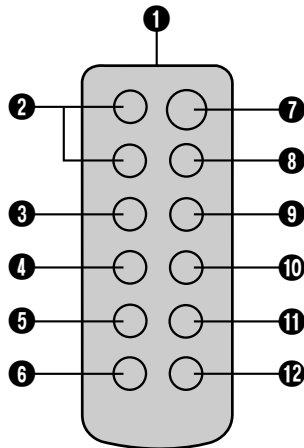

Buttons	Functions	
	With the camcorder's power switch set to "CAMERA".	With the camcorder's power switch set to "PLAY".
<b>1 Infrared beam transmitting window</b>	Transmits the beam signal.	
<b>2 ZOOM (T/W) buttons</b>	Zoom (invariable speed, P. 17)	—
<b>3 PLAY button</b>	—	Playback start (P. 38)
<b>4 STOP button</b>	—	Stop (P. 38)
<b>5 REW button</b>	Retake (Rewind) (P. 18)/ Quick Review (P. 17)	Rew/Rew Shuttle Search (P. 38)
<b>6 INSERT button</b>	—	Insert Editing (P. 44)
<b>7 START/STOP button</b>	Functions same as the Recording Start/Stop button of the camcorder.	
<b>8 INT. TIME button</b>	Self-Timer (P. 34)/Time Lapse (P. 35)	—
<b>9 REC TIME button</b>	Animation/Time lapse (P. 35)	—
<b>10 PAUSE button</b>	—	Pause/Play (during Pause mode) (P. 38)
<b>11 FF button</b>	Retake (Forward) (P. 18)	FF/FF Shuttle Search (P. 38)
<b>12 A. DUB button</b>	—	Audio dubbing (P. 45)



# 16

## RECORDING Basic Recording

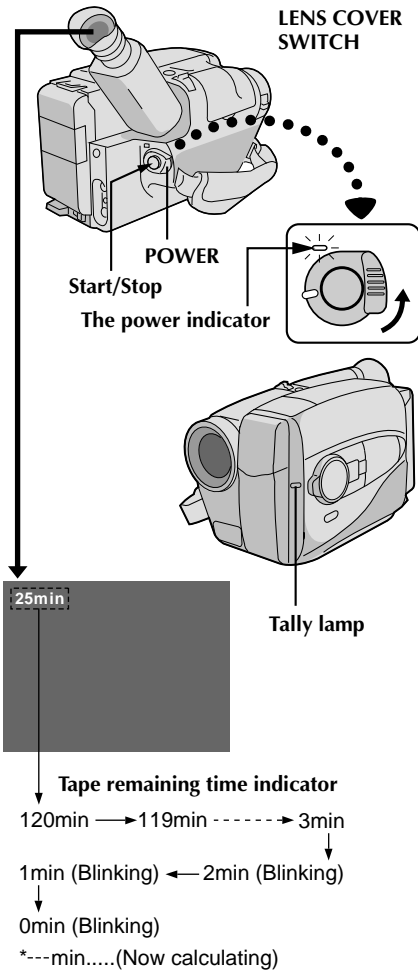

### NOTE:

You should already have performed the procedures listed below. If not, do so before continuing.

- Power (☞ pg. 8)
- Tape Length (☞ pg. 12)
- Recording Mode Setting (☞ pg. 13)
- Grip Adjustment (☞ pg. 14)

### LOAD A CASSETTE

- 1 Slide EJECT to open the cassette holder, then insert the cassette with the label facing out. Press PUSH to ensure the holder is closed and locked.

### ENTER RECORD-STANDBY MODE

- 2 Slide the LENS COVER open/close switch to open the lens cover, then set the power switch to "CAMERA".

- The power indicator lights and the camcorder enters the Record-Standby Mode.
- The scene you're aimed at appears on the viewfinder screen, with the word "PAUSE" superimposed upon it.

### START SHOOTING

- 3 Press the RECORDING START/STOP button.

- The tally lamp lights while recording is in progress, and "REC" appears in the viewfinder.
- If you want to turn the tally lamp off, see page 31.

### STOP RECORDING

- 4 Press the RECORDING START/STOP button again to stop recording.

- The camcorder re-enters the Record-Standby mode.

### NOTES:

- A cassette holder can't be opened unless a power supply is attached.
- There may be a delay after you slide EJECT until the holder opens. Do not use force.
- The tape's remaining time is displayed in the viewfinder as shown.
- The indicated remaining time is approximate.
- The time required to calculate the remaining tape length, and the accuracy of the calculation, may vary according to the type of tape used.
- The tape remaining time displayed in the viewfinder is correct only if the correct tape length has been selected (☞ pg. 12).
- "TAPE END" appears when the tape reaches its end, and the power goes off automatically if left in this condition for 5 minutes. "TAPE END" also appears when a cassette whose tape is already at its end is loaded.
- If the Record-Standby mode continues for 5 minutes without performing Zoom or any other operations, the camcorder's power shuts off automatically. Set the Power switch to "POWER OFF", and then back to "CAMERA" to turn the camcorder on again.
- If you're recording on a cassette from the middle, use the RETAKE function (☞ pg. 18) to find the end of the last recording so you don't erase any of it.
- The LENS COVER warning blinks for about 8 seconds when the camcorder is turned on, when the cover is closed.





## RECORDING Basic Features

# 17

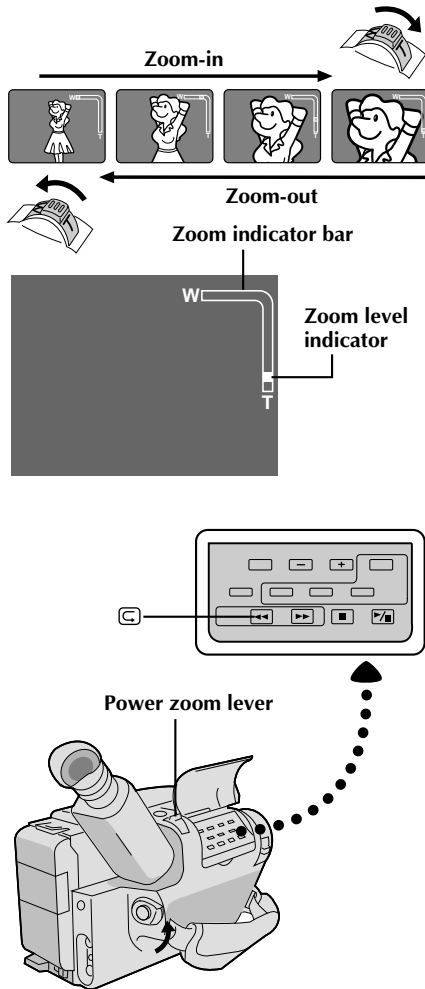

**FEATURE:**  
**PURPOSE:**

### Zooming

To produce the zoom in/out effect, or an instantaneous change in image magnification.

**OPERATION:**

#### 28X Hyper zoom

Digital circuitry doubles the maximum 14x magnification offered by optical zoom.

- 1) To zoom in, slide the Zoom Lever toward "T".
- 2) To zoom out, slide toward "W".

**NOTES:**

- During Hyper Zoom, the speed increases the further you slide the Zoom Lever.
- Focusing may become unstable during Hyper Zoom. In this case, set the zoom while in Record – Standby, set manual focus or Focus Lock (pg. 24, 25), then zoom in or out in Record mode.
- The Zoom Level Indicator (■) only moves during optical zoom. Once the indicator reaches "T", all magnification from that point is through digital processing.
- During digital image processing, the quality of the image may suffer.

**FEATURE:**  
**PURPOSE:**

### Quick Review

To check the end of the last recording.

**OPERATION:**

- 1) Press "C" and release quickly during the Record–Standby mode.
  - Tape is rewound for about 2 seconds and played back automatically, then pauses in Record–Standby mode for the next shot.

**NOTE:**

*Distortion may occur at start of playback. This is normal.*

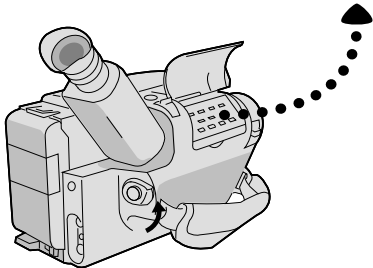
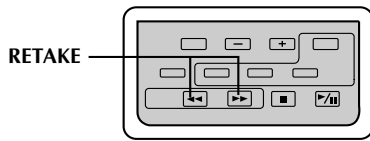
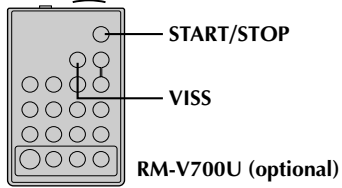
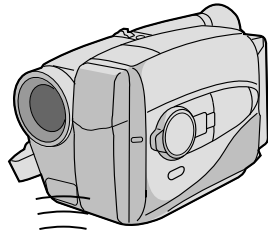

<p><b>FEATURE:</b></p> <p><b>PURPOSE:</b></p> <p><b>OPERATION:</b></p> <p><b>NOTE:</b></p>	<p><b>Index Code Marking</b></p> <p>To give you automatic access to any selected point on a recording. Auto Marking and Manual Marking are available.</p> <p><i>Auto Marking</i> An index code is marked to start the first recording after a cassette is inserted, as long as the Power switch is set to "CAMERA".</p> <p><i>Manual Marking</i> 1) Press <b>VISS</b> once to place the index code. INDEX blinks in the viewfinder during marking.</p> <p><i>If VISS is pressed during Record-Standby mode, the mark is placed where <b>RECORDING START/STOP</b> is pressed.</i></p>
<p><b>FEATURE:</b></p> <p><b>PURPOSE:</b></p> <p><b>OPERATION:</b></p> <p><b>NOTE:</b></p>	<p><b>Retake</b></p> <p>To re-record certain segments.</p> <p>1) Make sure the camcorder is in the Record-Standby mode.</p> <p>2) Press either <b>RETAKE</b> button to reach the start point for new recording.</p> <p>3) Press <b>RECORDING START/STOP</b> to start recording.</p> <p><i>Noise may appear during Retake. This is normal.</i></p>

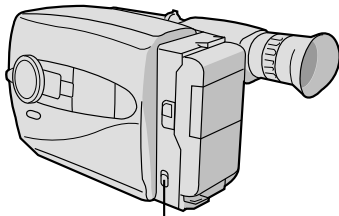

LIGHT ON/AUTO/OFF

## Video Light

When natural lighting is too dim, you can brighten the scene by using the built-in video light.

### SET VIDEO LIGHT

**1** Set the **LIGHT ON/AUTO/OFF** as required.

- ON** : Always keeps the light on as long as the camcorder is turned on.
- AUTO** : Automatically turns on the light when the camcorder senses insufficient lighting on the subject.
- OFF** : Turns off the light.

- The video light can be used with the camcorder's power on.
- It is recommended to set the white balance (☞ pg. 23) to indoor mode (☞) when you use the video light.
- When not using the video light, turn it off to save battery power.

### NOTES:

- Even if the battery indicator (☐) does not blink in the viewfinder, if the battery pack's charge is low, the camcorder may turn off automatically when you turn on the video light, or when you start recording with the video light turned on.
- When the **LIGHT ON/AUTO/OFF** switch is set to "AUTO":
  - Depending on the lighting conditions, the video light may keep turning on and off. In this case, manually switch the light on or off using the **LIGHT ON/AUTO/OFF** switch.
  - While the Sports or High-Speed Shutter mode (☞ pg. 27) is engaged, the light is likely to stay on.
  - While the Twilight mode (☞ pg. 27) is engaged, the light will not activate.

### DANGER

- The video light become extremely hot. Do not touch it either while in operation or soon after turning it off, otherwise serious injury may result.
- Do not place the camcorder into the carrying case immediately after using the video light, since it remains extremely hot.
- When operating, keep a distance of about 30 cm. (1 ft.) between the video light and people or objects.
- Do not use near flammable or explosive materials.
- It is recommended that you consult your nearest JVC dealer for replacing the video light.



# 20

## RECORDING Advanced Features

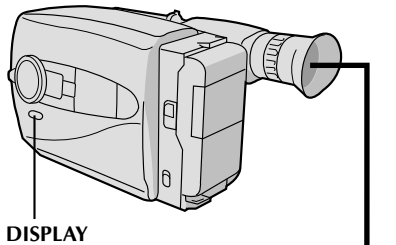

### Date/Time Insert

This feature allows you to display the date and time in your viewfinder and on a connected TV.

#### NOTE:

You should already have performed the Date/Time Setting procedure (pg. 11). If you haven't, do so before continuing.

#### DISPLAY

### 1 CHOOSE DISPLAY MODE

Press **DISPLAY** during Record-Standby to cycle through the available modes as shown in the illustration at left.

#### NOTES:

- The selected display can be recorded.
- If you don't want to record the display, select Date-off mode before shooting.
- If you want to delete the display during shooting, press **DISPLAY**.
- If you want to call back a deleted display, engage the Record-Standby mode and then press **DISPLAY** to select the desired display mode.

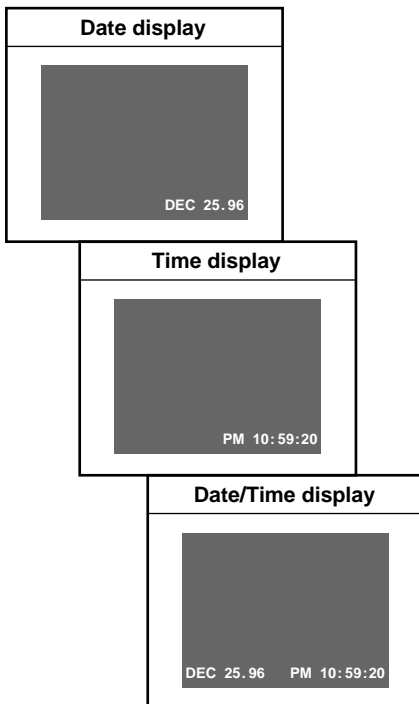
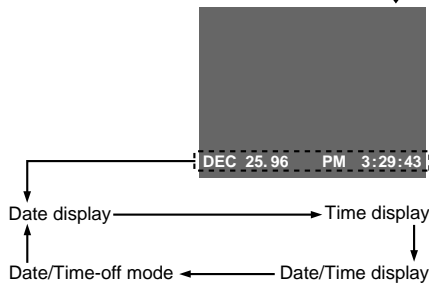

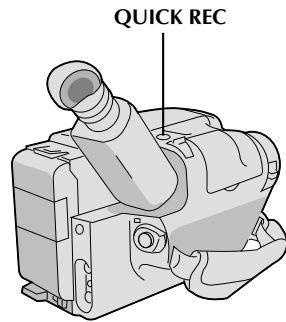

## Quick Rec

Records a scene for 5 seconds, providing quick scene transitions like those seen in TV programmes.

**1** During Record-Standby, press and release **QUICK REC**. Recording starts, and after 5-second recording is finished, the camcorder reenters the Record-Standby mode automatically.

- To continue shooting longer than 5 seconds, press and hold **QUICK REC**. Recording continues as long as **QUICK REC** is kept pressed.

### NOTES:

- The Fader (☞ pg. 24) cannot be activated by pressing **QUICK REC**.
- **QUICK REC** cannot be used during Animation and Time-Lapse (☞ pg. 35).



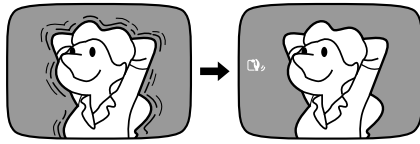

## Digital Image Stabilizer

This feature compensates for unstable images caused by camera-shake, particularly noticeable at high magnification.

### 1 ACTIVATE D. I. STABILIZER

Press **D.I.STABILIZER**. "D.I.S." appears in the viewfinder.

- To switch off the Digital Image Stabilizer, press **D.I.STABILIZER**. The indicator disappears.

### NOTES:

- Accurate stabilization may not be possible if hand shake is excessive, or under the following conditions:
  - When shooting subjects with vertical or horizontal stripes
  - When shooting dark or dim subjects
  - When shooting subjects with excessive backlighting
  - When shooting scenes with movement in various directions
  - When shooting scenes with low-contrast backgrounds
- Switch off DIS when recording with the camcorder on a tripod.

Shooting Mode Selector

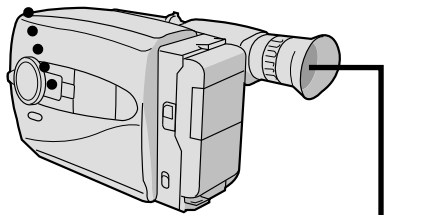
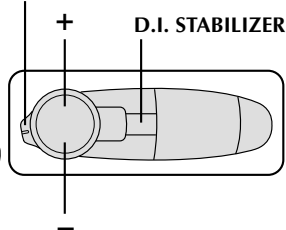

Viewfinder

D.I.S. Indicator



Exposure Level Indicator

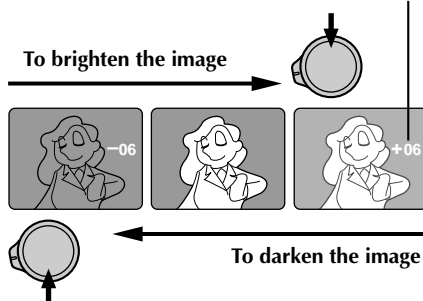

## Exposure Control

This feature automatically adjusts the iris for the best available picture quality, but you can override and make the adjustment manually.

### 1 SELECT SHOOTING MODE

Set the Shooting Mode selector to "PRESET".

### 2 BRIGHTEN IMAGE

Press + (maximum +06). The Exposure level indicator appears in the viewfinder.

OR . . .

### DARKEN IMAGE

Press - (maximum -06). The Exposure level indicator appears in the viewfinder.

When you want to return to the factory setting . . .

### 3 RESTORE INITIAL SETTING

Press + and - simultaneously. The standard setting is immediately restored and the Exposure level indicator disappears.

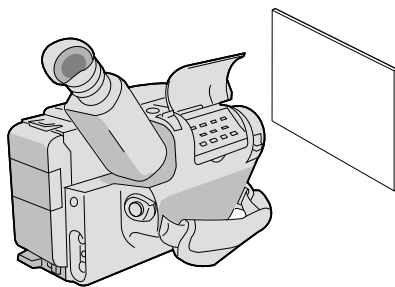
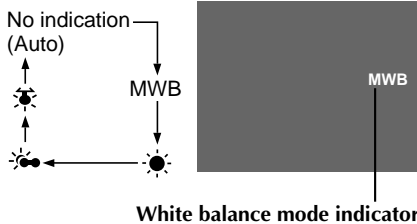
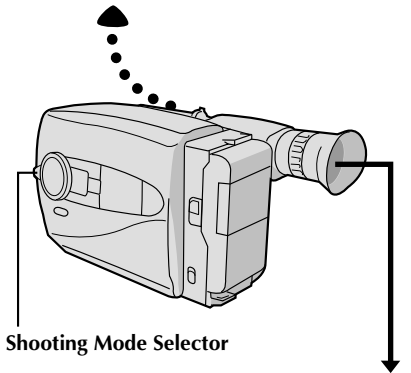
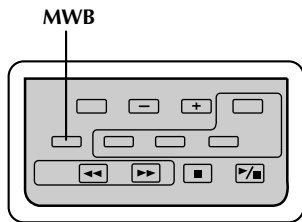

### White Balance Adjustment

This camcorder's Automatic Color Temperature system senses the color temperature of the ambient lighting for automatic white balance adjustment. However, precise color adjustment is not possible under the following conditions:

- When an object is in various shades of the same color.
- When a predominantly red or brown object is being shot outdoors.

In these cases, use the camcorder's built-in preset filters for white balance adjustment.

#### SELECT SHOOTING MODE

- 1 Set the Shooting Mode selector to "PRESET".

#### SELECT FUNCTION

- 2 Press **MWB** (Manual White Balance) until the required indication appears in the viewfinder.

- "MWB" .... With a memorized personal White Balance setting (see below)
- "☀" ..... Outdoors on sunny day
- "☁" ..... Outdoors on cloudy day
- "💡" ..... Light source is halogen or tungsten lamp

MWB sets the color temperature for the subject's light source so you can shoot with natural colors that are unaffected by surroundings, even when there are multiple subjects with different color temperatures.

#### SELECT SHOOTING MODE

- 1 Set the Shooting Mode selector to "PRESET".

#### ADJUST FOCUS

- 2 Point the camcorder at a white, flat object such as a sheet of white paper, and adjust focus manually (pg. 25).

#### ADJUST WHITE BALANCE

- 3 Press MWB until "MWB" appears, then press and hold **MWB** for more than 3 seconds.

- "MWB" blinks in the viewfinder during adjustment, then stops blinking but stays lit when adjustment is complete.

#### NOTES:

- To switch to automatic white balance adjustment, press **MWB** until the indication disappears, or turn the Shooting Mode selector to "FULL AUTO".
- Re-adjust the White Balance mode when the lighting has changed, when the camcorder has been turned on and off again, or when the Shooting Mode selector's position has been changed.
- It is helpful to connect your camcorder to a color monitor when adjusting the white balance ("Basic Connections" pg. 37).
- When adjusted by putting colored paper in front of the subject in step 2 ("ADJUST FOCUS"), this unit makes its color temperature standard for automatic white balance. So you can enjoy shooting with different colors. For example, when adjusting with red, blue or yellow colors, the image becomes the color which approximates to green, orange or purple respectively.

Focus  
detection zone

Shooting mode selector

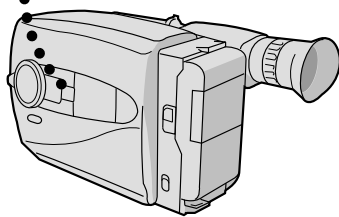
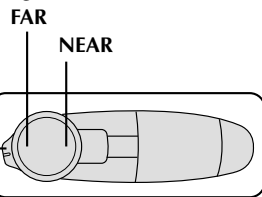

## Focusing

### Auto Focus

The camcorder's Full Range AF system offers continuous shooting ability from close-up to infinity. However, correct focus may not be obtainable in the situations listed below (in these cases use manual focusing):

- When two subjects overlap in the same scene.
- When illumination is low.\*
- When the subject has no contrast (difference in brightness and darkness), such as a flat, one-color wall, or a clear, blue sky.\*
- When a dark object is barely visible in the viewfinder.\*
- When the scene contains minute patterns or identical patterns that are regularly repeated.
- When the scene is affected by sunbeams or light reflecting off the surface of a body of water.
- When shooting a scene with a high-contrast background.

\* The low-contrast warning "▲▲" appears in the viewfinder.

### Focus Lock

This feature locks the focus in place, which is especially helpful in the following situations:

- When things pass between your subject and the camcorder. Engage the focus lock function to lock your subject in before recording.
- When you want your subject to be focused, and to appear in a corner of the screen. First, center on the subject and focus using auto focus mode. Then engage the focus lock function and move the camcorder until the subject is where you want it.

### 1 SELECT SHOOTING MODE

Set the Shooting Mode selector to "PRESET".

### 2 LOCK FOCUS

Press **FAR** or **NEAR**. The focus lock indication "▲▲" appears in the viewfinder.

### 3 RELEASE FOCUS LOCK

Press **FAR** and **NEAR** simultaneously. The focus lock indication disappears.

## NOTES:

- If the lens is smeared or blurred, accurate focusing is not possible. Keep the lens clean, wiping with a piece of soft cloth if it gets dirty. When condensation occurs, wipe with a soft cloth or wait for it to dry naturally.
- When shooting a subject close to the lens, zoom-out first (☞ pg. 17). If zoomed-in in the auto focus mode, the camcorder could automatically zoom out depending on the distance between the camcorder and the subject. \*When Tele Macro is activated, the camcorder will not zoom out automatically.



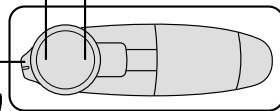

Shooting mode selector

FAR  
NEAR

Power zoom lever

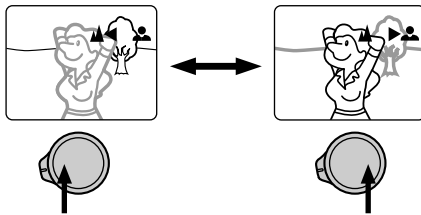
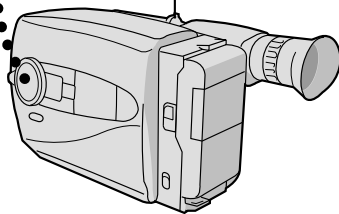

## Manual Focus

### NOTE:

You should already have made the necessary viewfinder adjustments (pg. 10). If you haven't, do so before continuing.

### 1 SELECT SHOOTING MODE

Set the Shooting Mode selector to "PRESET".

### 2 ADJUST FOCUS

#### **A** TO FARTHER SUBJECT

Press and hold FAR. The Manual Focus indications "▲▲" appear and "◀" blinks. Go to step 3.

#### **B** TO NEARER SUBJECT

Press and hold NEAR. The Manual Focus indications "▲▲" appear and "▶" blinks. Go to step 3.

### 3 LOCK FOCUS

Release FAR or NEAR. The focus indication is replaced by the focus lock indication "▲▲" and the adjusted focus is locked in.

### 4 RELEASE MANUAL FOCUS MODE

Press FAR and NEAR simultaneously. The Manual Focus mode is immediately released and the focus lock indication disappears.

### NOTES:

- Be sure to focus the lens in the maximum telephoto position when you use the Manual Focus mode. If you focus in on a certain subject in the wide-angle position, sharply focused images cannot be obtained when zoomed up because the depth-of-field is reduced at longer focal lengths.
- When the focus level cannot be adjusted any farther or closer, "▲" or "▶" will blink.



## Shooting Mode Selector

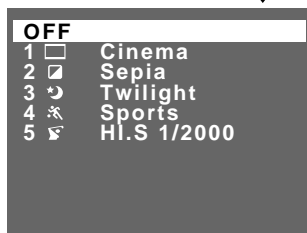
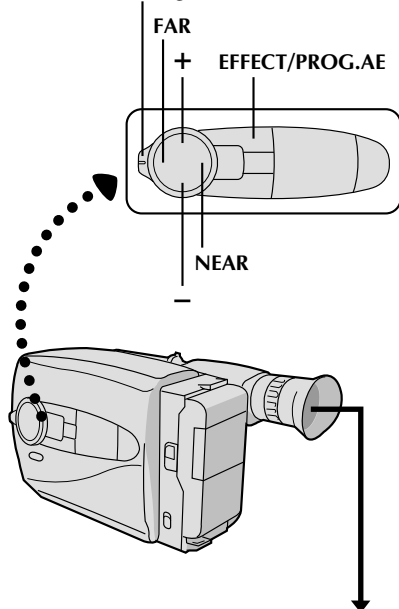

Effect menu



EFFECT/PROG. indicator

## Program AE With Special Effects

Useful in making the picture look creative and attractive. Effects can be selected during recording, as well as in Record-Standby.

## 1 SELECT SHOOTING MODE

Set the Shooting Mode selector to either "FULL AUTO" or "PRESET".

*If you set to "FULL AUTO",...*

.... only the Cinema mode can be activated.

*If you set to "PRESET",...*

.... you can choose any one of the 5 effects available.

## 2 SELECT EFFECT

*If you set to "FULL AUTO",...*

.... pressing **EFFECT/PROG.AE** turns the Cinema mode on and off.

*If you set to "PRESET",...*

.... pressing **EFFECT/PROG.AE** brings up the Effect menu. Press again to move the highlight bar to the desired effect. Once you decide on an effect, it is selected and activated, and its indicator appears, within 2 seconds.

• If you started this procedure in the Record-Standby mode, press **RECORDING START/STOP** to begin recording at this point.

## 3 DEACTIVATE EFFECT





*When the Shooting Mode Selector is set to "FULL AUTO",...*

.... press **EFFECT/PROG.AE**.

*When set to "PRESET",...*

.... press **EFFECT/PROG.AE** to bring up the Effect Menu, and press again to move the highlight bar to "OFF".



INDICATION	MODE	EFFECT
	CINEMA	Adds black bars to the top and bottom of the screen to produce a cinema-like "16:9 wide-screen" effect.
	SEPIA	The picture becomes sepia-tinted (reddish brown) monochrome, creating the look of an old photograph.
	TWILIGHT	Makes dusk and twilight scenes, etc. look more natural and dramatic. White balance is set to "☀️". Press <b>MWB</b> if you want to change the setting.
	SPORTS	Automatically adjusts to high shutter speed (1/250 to 1/500) to clearly capture fast-moving action with less blur. Clarity is especially noticeable during slow motion or still playback on a VCR. Great for sports, races, etc.
	HI-SPEED SHUTTER (1/2000)	Captures even faster action than Sports effect.

**NOTES:**

- When the Sepia effect is activated, pressing **MWB** (manual white balance) has no effect.
- Certain effects cannot be used together with other functions. When an effect not usable in the present situation is selected, its indicator blinks.



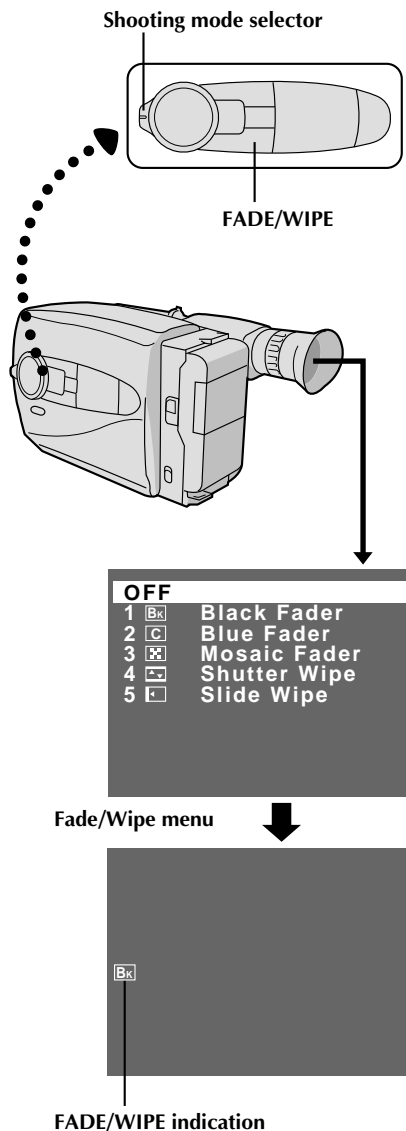

## Fade/Wipe

These effects let you make pro-style scene transitions.

### 1 SELECT SHOOTING MODE

Set the Shooting Mode selector to either "FULL AUTO" or "PRESET".

*If you set to "FULL AUTO", . . .*

.... only the Black Fader mode is available.

*If you set to "PRESET", . . .*

.... you can choose any one of the effects available.

### 2 RESERVE EFFECT

*If you set to "FULL AUTO", . . .*

.... pressing **FADE/WIPE** turns the Black Fader mode on and off.

*If you set to "PRESET", . . .*

.... pressing **FADE/WIPE** brings up the Fade/Wipe menu. Press again to move the highlight bar to the desired effect. Once you decide on an effect, it is selected and reserved, and its indicator appears, within 2 seconds.

### 3 START RECORDING

Press **RECORDING START/STOP** to start recording and activate a fade- or wipe-in.

**OR . . .**

### END RECORDING

Press **RECORDING START/STOP** to stop recording and engage a fade- or wipe-out.

### 4 DEACTIVATE EFFECT

*When the Shooting Mode Selector is set to "FULL AUTO", . . .*

.... press **FADE/WIPE**.

*When set to "PRESET", . . .*

.... press **FADE/WIPE** to bring up the Fade/Wipe menu, then press again to move the highlight bar to "OFF".

## NOTE:

*When the Shooting Mode selector is set to "FULL AUTO", after a fade-in, Black Fader is no longer reserved. To reserve it for a fade-out, press **FADE/WIPE**. "[Bk]" appears in the viewfinder.*

**BLACK FADER**

Fades in/out to a black screen.

**BLUE FADER**

Fades in/out to a blue screen.

**MOSAIC FADER**

Gradually turns/returns the picture into/from a mosaic pattern.

**SHUTTER WIPE**

A black screen moves in from the top and bottom, closing over the image like a shutter, or a new image pushes open the black screen vertically from the center.

**SLIDE WIPE**

A black screen moves in from the left to gradually cover the image, or a new image moves in from right to left.





Shooting mode selector

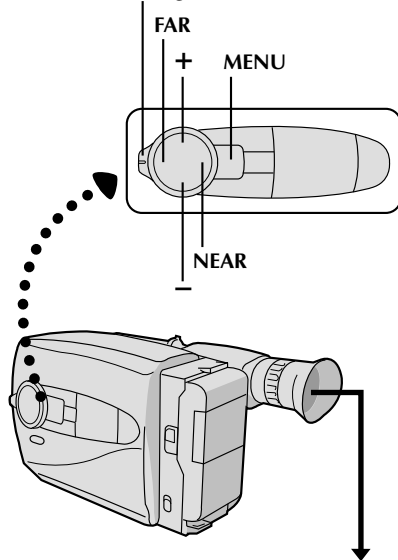

Tele Macro	OFF
Gain Up	AGC
Color Filter	NOR.
Tape Length	T30
Title	
Date/Time	
Sub Menu	

Main Menu screen

Tally	ON
Interval Timer	OFF
Rec Time	OFF
JLIP ID NO.	07

Sub Menu screen

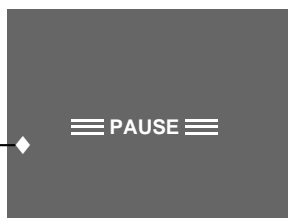

If any settings in the Main Menu have been changed from the factory settings, this mark appears in the viewfinder.

## Using Menu For Detailed Adjustment

This camcorder is equipped with Multi-Function Control, an easy-to-use, on-screen menu system that simplifies many of the more detailed camcorder settings.

### 1 SELECT SHOOTING MODE

Set the Shooting Mode selector to "PRESET".

### 2 ACCESS MAIN MENU SCREEN

Press MENU.

### 3 SELECT FUNCTION

Press + or - to place the highlight bar on the desired function.

### 4 MAKE SETTING

The setting procedure depends on the function you select.

*If you select, Tele Macro, Gain Up, Color Filter or Tape Length, . . .*

.... press FAR or NEAR to cycle through the choices until the desired setting appears. Then go to step 8.

*If you select Title or Date/Time, . . .*

.... press NEAR to access the selection menu for each function (Title – pg. 32; Date/Time – pg. 11).

*If you select "Sub Menu", . . .*

.... press NEAR to bring up the Sub Menu screen. Go to step 5.

### 5 SELECT FUNCTION AT SUB MENU

Press + or - to place the highlight bar on the desired option, then press NEAR. The selected item begins blinking.

### 6 CHANGE SETTINGS

Press + or - to change the displayed setting of the selected function, then press FAR to enter your choice. The selected item stops blinking.

### 7 CLOSE SUB MENU

Press FAR, and setting is complete. The Sub menu screen disappears and the Main Menu screen reappears.

- To go directly past the Main Menu screen to the normal screen, press MENU.

### 8 CLOSE MAIN MENU

Press MENU. The normal screen reappears.

**MAIN MENU**

<b>Tele Macro</b>	OFF	Usually set to this position.
	◆ ON	Usually the distance to a subject where the lens is in focus depends on the zoom magnification. Unless there is a distance more than 1m to the subject, the lens is out of focus at the maximum telephoto setting. When set to "ON", you can shoot a subject as large as possible at a distance of approx. 60 cm. • Depending on the zoom position, the lens may go out of focus.
<b>Gain UP</b>	AGC	Allows you to record a subject in a dark environment. It delivers a brighter, if slightly coarse, picture.
	◆ OFF	Allows you to shoot dark scenes with no picture brightness adjustment.
<b>Color Filter</b>	NOR	For normal shooting with no color adjustment.
	◆ RED	Gives recording a reddish tint.
	◆ BLUE	Gives recording a bluish tint.
<b>Tape Length</b>	Allows you to set the tape length depending on the tape used (☞ pg. 12).	
<b>Title</b>	Allows you to superimpose a preset title onto a scene (☞ pg. 32).	
<b>Date/Time</b>	Allows you to set the current date and time (☞ pg. 11).	

☐ = Factory setting

**SUB MENU**

<b>Tally</b>	ON	The tally lamp comes on to signal the start of recording.
	OFF	The tally lamp remains off at all times.
<b>Interval Timer and Rec. Time</b>	These features allow you to set the parameters for Self-Timer (☞ pg. 34), Animation and Time-Lapse recording (☞ pg. 35).	
<b>JLIP ID NO.</b>	This number will be necessary in the future when connecting the camcorder to a device such as a computer using the JLIP terminal. The numbers range from 01 — 99.	

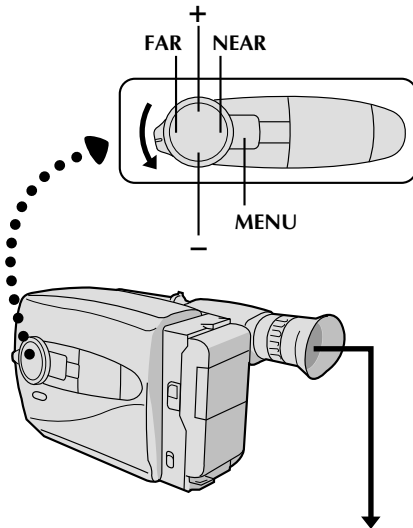

Tele Macro	OFF
Gain Up	AGC
Color Filter	NOR.
Tape Length	T30
<b>Title</b>	
Date/Time	
Sub Menu	

OFF
Happy Birthday
Our Vacation
Merry Christmas
A Special Day
Happy Holidays
Our New Baby
Wedding Day
<b>Congratulations</b>
(Set Character)

Congratulations

### Instant Titles

You can superimpose one of 8 preset titles, or a title you made yourself, onto a scene.

- 1 SELECT SHOOTING MODE**  
Set the Shooting Mode selector to "PRESET".

---

- 2 ACCESS MAIN MENU SCREEN**  
Press MENU.

---

- 3 ACCESS INSTANT TITLE MENU SCREEN**  
Press + or - to move the highlight bar to "Title", then press NEAR. The Title menu appears.

---

- 4 SELECT PRESET TITLE**  
Press + or - to move the highlight bar to the desired title. (To create an original title, refer to page 33.)

---

- 5 DISPLAY PRESET TITLE**  
Press MENU. The Title menu disappears, and the selected title is displayed on the screen.



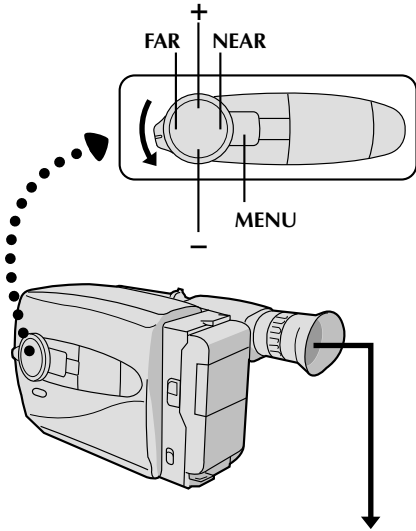

OFF  
 Happy Birthday  
 Our Vacation  
 Merry Christmas  
 A Special Day  
 Happy Holidays  
 Our New Baby  
 Wedding Day  
 Congratulations  
 (Set Character)

SET: MENU KEY

□	A	B	C	D	E	F	G	H	I
J	K	L	M	N	O	P	Q	R	S
T	U	V	W	X	Y	Z	À	Ó	&
À	È	Ì	Ò	Ù	Ñ	Æ	Ø	Å	♥
:	.	'	-	/	!	?	¿		
0	1	2	3	4	5	6	7	8	9
I	□	□	□	□	□	□	□	□	□

End Clear

SET: MENU KEY

□	A	B	C	D	E	F	G	H	I
J	K	L	M	N	O	P	Q	R	S
T	U	V	W	X	Y	Z	À	Ó	&
À	È	Ì	Ò	Ù	Ñ	Æ	Ø	Å	♥
:	.	'	-	/	!	?	¿		
0	1	2	3	4	5	6	7	8	9
I	□	I	K	E	Y	O	U	□	♥

End Clear

### Character Generator

You can enter an original title of up to 18 characters. Perform steps 1, 2 and 3 of the "Instant Title" procedure (pg. 32) before continuing.

#### 1 ACCESS CHARACTER SET MENU

Press + or - to move the highlight bar to "(Set Character)", then press NEAR. The Character Set menu appears.

#### 2 INPUT CHARACTERS

Press +, -, FAR or NEAR to move the blinking cursor to the desired character, then press MENU. The selected characters appear at the bottom of the screen. Repeat as many times as desired (max. 18).

- To select the location of the next character, press +, -, FAR or NEAR to move the blinking cursor to the row of squares at the bottom of the screen, then press FAR or NEAR to move the blinking cursor underneath the desired location. Press + when you're done, and the blinking cursor returns to the character grid.

#### 3 END CHARACTER SETTING

Press +, -, FAR or NEAR to move the cursor to "End", then press MENU. The Character Set menu disappears and the Preset Title menu reappears. Press MENU to return to the normal screen.

#### NOTE:

To erase a character you entered mistakenly, place the cursor by "Clear" by pressing +, -, FAR or NEAR, then press MENU. All characters are deleted at once. Or, to erase selected characters only, place the blinking cursor at the character at the bottom you want to replace, then press +/-." " in the top left corner is highlighted.

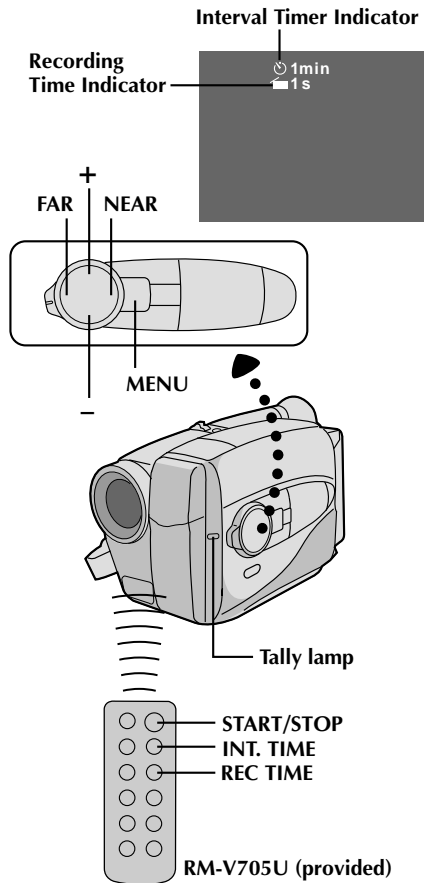

Tele Macro	OFF
Gain Up	AGC
Color Filter	NOR.
Tape Length	T30
Title	
Date/Time	
Sub Menu	

Main Menu Screen

Tally	ON
Interval Timer	OFF
Rec Time	OFF
JLIP ID NO.	07

Sub Menu Screen

## Self-Timer

You can set the delay between pressing **RECORDING START/STOP** and the actual start of recording. If you secure the camcorder, you (or whomever is operating the camcorder) can enter the scene before recording starts.

### 1 ENGAGE RECORD-STANDBY MODE

Make sure the lens cover is open, then set the Power switch to "CAMERA".

### 2 SELECT MODE

Set the Shooting Mode selector to "PRESET".

### 3 ACCESS MAIN MENU SCREEN

Press **MENU**.

### 4 ACCESS SUB MENU SCREEN

Press **-** to move the highlight bar down to "Sub Menu", then press **NEAR**. The Sub Menu screen appears.

### 5 SET INTERVAL TIME

Press **-** to move the highlight bar down to "Interval Timer", press **NEAR**, then press **+** or **-** to cycle through the choices. Stop when the desired time appears. Choose from "15S", "30S", "1min", "5min", or select to turn the function "OFF". Then press **FAR** twice to return to the Main Menu screen.

### 6 CLOSE MAIN MENU

Press **MENU**.

### 7 START DELAYED RECORDING

Press **RECORDING START/STOP**. If you set the tally lamp to "ON" (see pg. 31), it begins blinking, and the blinking frequency increases about 5 seconds before recording is to start. Once recording begins, the lamp stops blinking but stays lit.

#### To Release Self-Timer . . .

.... while the tally lamp is blinking, press **RECORDING START/STOP** to stop the blinking, then set "Interval Timer" to "OFF" or press **INT. TIME** on the remote control until "☺" disappears.

.... while the tally lamp is lit but not blinking, press set "Interval Timer" to "OFF" or press **INT. TIME** on the remote control until "☺" disappears.

#### NOTE:

Instead of performing steps 2 – 6, you can set the interval time by pressing **INT. TIME** on the remote control.



## Animation

Give stationary scenes or objects an illusion of movement. This function allows you to shoot a series of pictures, each slightly different, of the same object for a brief period of time.

### ENGAGE RECORD-STANDBY MODE

**1** Make sure the lens cover is open, then set the power switch to "CAMERA".

### SET RECORDING SPEED

**2** Set **SP/EP** to **SP** (☞ pg. 13).

### SET RECORDING TIME

**3** Press **REC TIME** on the remote control. Four choices are available, and they appear in the following order (each time **REC TIME** is pressed): 1/4S (one-fourth of a second), 1/2S (one-half of a second), 1S (one full second) and 5S (five seconds). Press again to release the Animation mode.

- You can also set the recording time in the Sub Menu screen (☞ pg. 32). Press "-" to move the highlight bar down to "Rec Time", press **NEAR**, and press + or - to cycle through the choices. Then press **MENU**.

### START RECORDING

**4** Press **RECORDING START/STOP** after focusing on the subject. The recording stops automatically after the selected period of time.

### ASSEMBLE SERIES OF PICTURES

**5** Repeat steps **3** and **4** for the desired number of pictures.

### CHECK YOUR WORK

**6** Play back the series of pictures to see if the results were satisfactory.

### RELEASE ANIMATION MODE

**7** Press **REC TIME** until "■" disappears from the viewfinder, or set "Rec Time" in the Sub Menu pscreen to "OFF".

#### NOTES:

- For best results, make sure the camcorder is secured when shooting in Animation or Time-Lapse mode.
- Fade-in/out cannot be performed during Animation or Time-Lapse shooting.
- Before performing other operations following Animation or Time-Lapse recording, make sure the Animation or Time-Lapse mode is deactivated.

## Time-Lapse

You can record sequentially at preset time spans. Leaving the camcorder aimed at a specific subject, you can record subtle changes over an extended period of time.

### ENGAGE RECORD-STANDBY MODE

**1** Make sure the lens cover is open, then set the power switch to "CAMERA".

### SET RECORDING SPEED

**2** Set **SP/EP** to **SP** (☞ pg. 13).

### SET RECORDING TIME

**3** Press **REC TIME** on the remote control. There are four choices available, and they appear in the following order (each time **REC TIME** is pressed): 1/4S, 1/2S, 1S, and 5S. Press again to reset.

- You can also set the recording time in the Sub Menu screen. Press "-" to move the highlight bar down to "Rec Time", and press **NEAR**, then press + or - to cycle through the choices.

### SET INTERVAL BETWEEN RECORDINGS

**4** Press **INT. TIME** on the remote control. There are five choices available, and they appear in the following order (each time **INT. TIME** is pressed): OFF, 15S, 30S, 1 min, and 5 min. Press again to reset.

- You can also set the interval time in the Sub Menu screen. Press "-" to move the highlight bar down to "Interval Time", press **NEAR**, and press + or - to cycle through the choices.
- Exposure control (☞ pg. 22), manual focusing (☞ pg. 25) and D.I.S. settings (☞ pg. 22) should be performed at this point. Once you perform step **5**, these settings cannot be changed.

### START TIME-LAPSE RECORDING

**5** Press **RECORDING START/STOP**. Recording and intervals alternate automatically.

### RELEASE TIME-LAPSE MODE

**6** To release when the tally lamp is not blinking, press **INT. TIME** and **REC TIME** repeatedly until "■" and "☺" disappear. To release when the tally lamp is blinking, press **RECORDING START/STOP** to stop the blinking, then press **INT. TIME** and **REC TIME** repeatedly until "■" and "☺" disappear, or set "Interval Timer" and "Rec Time" in the Sub Menu screen to "OFF".

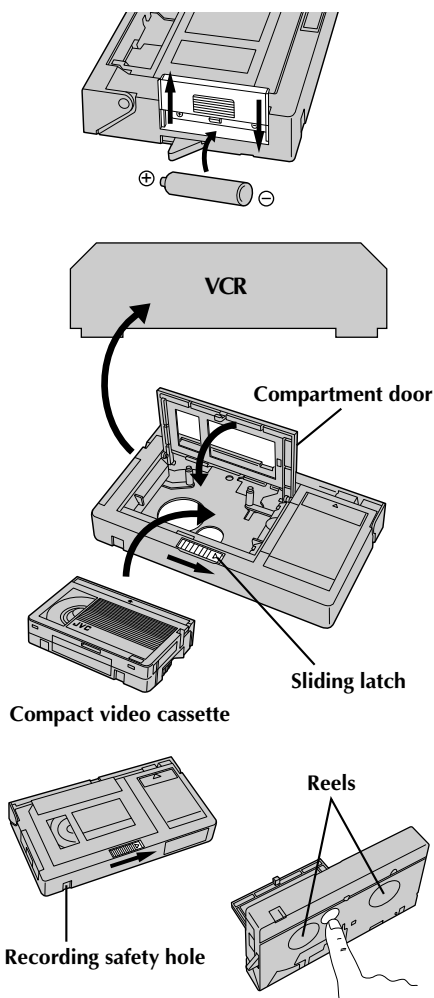

### Cassette Adapter (VHS PlayPak)

Use this to play back a VHS-C video cassette recorded with this camcorder. It is fully compatible with any VHS video cassette recorder. The C-P7U adapter is battery powered and automatically performs tape loading and unloading.

#### 1 INSERT BATTERY

Slide the battery cover up to remove it, and install one "AA(R6)" size battery as shown in the illustration at left. Then reattach the cover.

#### 2 INSERT CASSETTE IN ADAPTER

Slide the latch to open the adapter compartment door, then insert the cassette and close the compartment door.

#### 3 PLAY BACK ON CONNECTED VCR

Load the cassette adapter into the VCR and play the tape back as you would any other.

#### 4 REMOVE CASSETTE FROM ADAPTER

Slide the latch and the compartment door opens automatically. Then insert your finger in the hole on the underside of the adapter as shown in the illustration at left, push up and remove the cassette.

#### NOTES:

- During tape loading and unloading, do not touch the reels for safety and tape protection.
- During special-effect playback (slow motion, still frame, etc.), the picture may vibrate or noise bars may appear on the screen.
- To record on a VCR using a compact cassette and the adapter, cover the adapter's recording safety hole with adhesive tape.

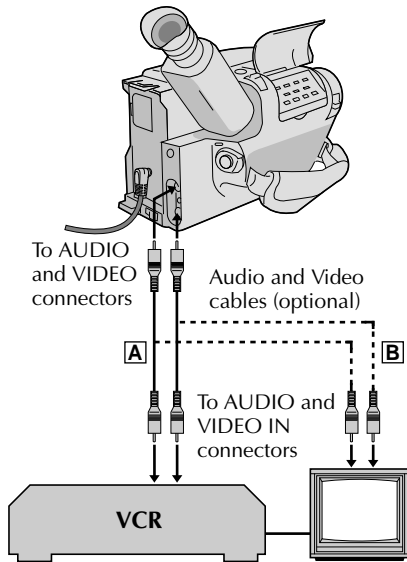

There are three basic types of connections. When making the connections, refer also to your VCR and TV instruction manuals.

**Connection To A VCR [A]  
(Editing, Dubbing and Playback)**

**NOTE:**

Use the optional Audio and Video cables.

- 1 CONNECT CAMCORDER TO VCR**  
As shown in the illustration at left, connect the optional Audio and Video cables between the AUDIO and VIDEO connectors on the camcorder and those on the VCR.
- 2 SUPPLY POWER**  
Turn on the camcorder, the VCR and the TV.
- 3 SELECT MODE**  
Set the VCR to its AUX input mode, and set the TV to its VIDEO mode or channel 3.

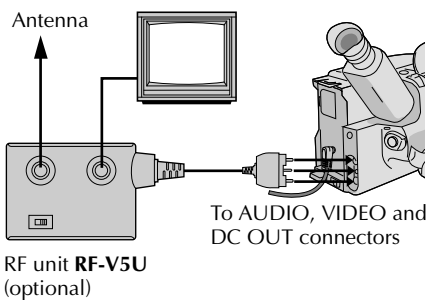

**Connection To A TV With A/V Input  
Connectors [B] (Playback ONLY)**

**NOTE:**

Use the optional Audio and Video cables.

- 1 CONNECT CAMCORDER TO TV**  
As shown in the illustration at left, connect the optional Audio and Video cables between the AUDIO and VIDEO connectors on the camcorder and those on the TV.
- 2 SELECT MODE**  
Set the TV to its VIDEO or AV mode (as specified in its instructions).

**NOTES:**

- It is recommended to use the AC Power Adapter/Charger as the power supply instead of the battery pack.
- To monitor the picture and sound from the camcorder without inserting a tape, set the camcorder's Power switch to "CAMERA", then set your TV to the appropriate input mode.
- If you have a TV or speakers that are not specially shielded, do not place the speakers adjacent to the TV as interference will occur in the camcorder playback picture.

**Connection To A TV With NO A/V Input  
Connectors (Playback ONLY)**

**NOTE:**

Use the optional RF-V5U RF unit.

\* Refer to the RF-V5U instruction manual for connection procedure.

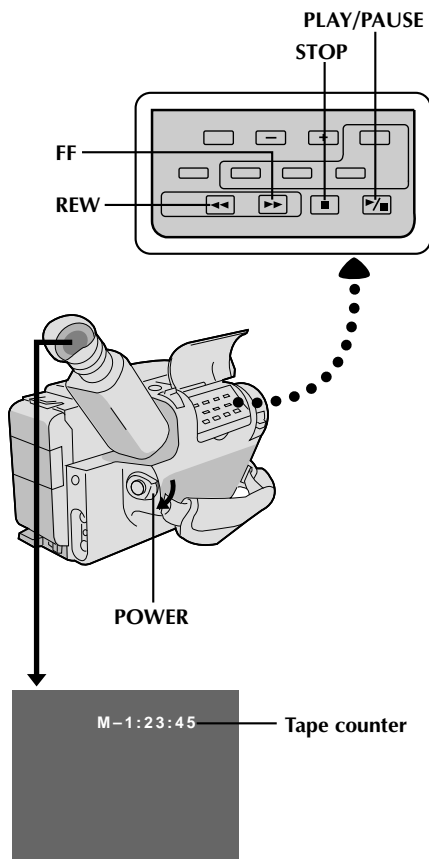

**NOTE:**

Make sure you connect your camcorder as directed in "Basic Connections" (pg. 37).

**1 LOAD A CASSETTE**

Slide EJECT to open the cassette holder, then insert the cassette with the label facing out. Press PUSH to ensure the holder is closed and locked.

**2 SELECT MODE**

Set the Power switch to "PLAY". The Power On indicator lights.

**3 PLAYBACK**

Press **PLAY/PAUSE**. The playback picture appears in the viewfinder and the connected TV.

**4 STOP PLAYBACK**

Press **STOP**.

**Rewind or Fast-forward the tape**

Press **REW** to rewind, or **FF** to fast-forward the tape during Stop mode.

**NOTE:**

The camcorder shuts off automatically after about 5 minutes in *STOP* mode. To turn on again, set the Power switch to "POWER OFF", then to "PLAY".



## PLAYBACK Features

# 39

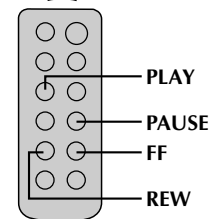
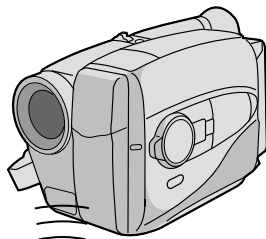
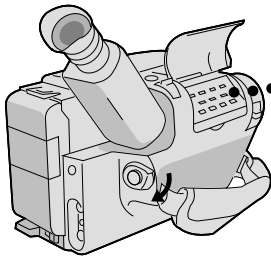
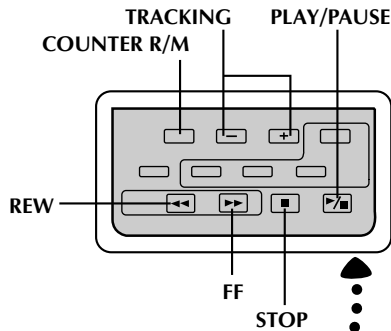

RM-V705U (provided)

<b>FEATURE:</b>	<b>Manual Tracking</b>
<b>PURPOSE:</b>	To eliminate noise bars that appear on the screen.
<b>OPERATION:</b>	1) Press either <b>TRACKING</b> button as many times as necessary for best picture.
<b>NOTES:</b>	<ul style="list-style-type: none"> <li>• To reset <b>TRACKING</b> to the original preset, press both <b>TRACKING</b> buttons simultaneously.</li> <li>• Manual Tracking may not work with tapes recorded on other VCRs or camcorders.</li> </ul>
<b>FEATURE:</b>	<b>Still Playback</b>
<b>PURPOSE:</b>	To pause during playback.
<b>OPERATION:</b>	1) Press <b>PLAY/PAUSE</b> during playback. 2) To resume normal playback, press <b>PLAY/PAUSE</b> again.
<b>NOTE:</b>	Noise bars appear and pictures may become monochrome during Still Playback. This is normal.
<b>FEATURE:</b>	<b>Shuttle Search</b>
<b>PURPOSE:</b>	To allow high-speed search in either direction.
<b>OPERATION:</b>	<p><i>Forward Search</i></p> 1) Press <b>FF</b> during playback. (Speed is 5 times normal in SP, and 15 times normal in EP mode.) <p><i>Reverse Search</i></p> 1) Press <b>REW</b> during playback. (Speed is as noted above.)
<b>NOTE:</b>	Noise bars appear and pictures may become monochrome or darken in Shuttle Search. This is normal.
<b>FEATURE:</b>	<b>Counter Memory Function</b>
<b>PURPOSE:</b>	To make it easier to locate a specific tape segment.
<b>OPERATION:</b>	1) Press <b>COUNTER R/M</b> and hold for more than 2 seconds. The counter resets to "0:00:00". 2) Press <b>COUNTER R/M</b> . "M" appears. 3) After recording or playback, press <b>STOP</b> , then <b>REW</b> . The tape automatically stops at or close to 0:00:00. 4) Press <b>PLAY/PAUSE</b> to start playback.
<b>NOTES:</b>	<ul style="list-style-type: none"> <li>• The counter memory functions in the FF and REW modes.</li> <li>• To disable Counter Memory Function, press <b>COUNTER R/M</b> so the "M" disappears.</li> </ul>

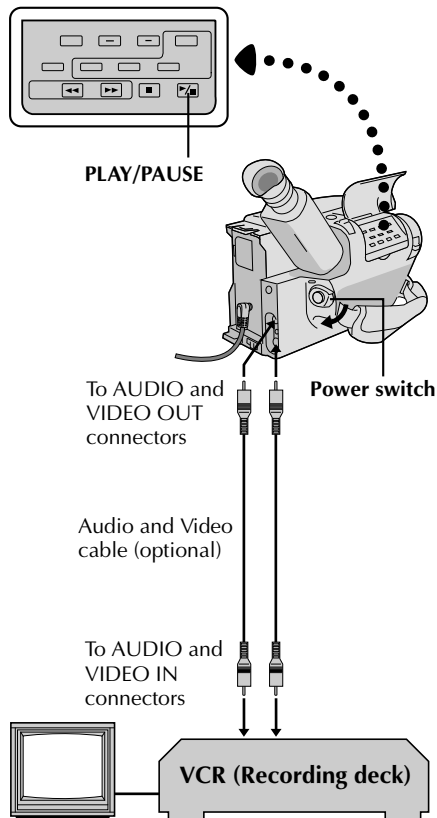

### Tape Dubbing

#### 1 CONNECT EQUIPMENT

Following the illustration at left, connect the camcorder and the VCR.

#### 2 PREPARE FOR DUBBING

Set the camcorder's Power switch to "PLAY", turn on the VCR's power, and insert the appropriate cassettes in the camcorder and the VCR.

#### 3 SELECT VCR MODE

Engage the VCR's AUX and Record-Pause modes.

#### 4 FIND EDIT-IN POINT

Engage the camcorder's Play mode to find a spot just before the edit-in point. Once it's reached, press **PAUSE** on the camcorder.

#### 5 START EDITING

Press **PLAY** on the camcorder and engage the VCR's Record mode.

#### 6 STOP EDITING TEMPORARILY

Engage the VCR's Record-Pause mode and press **PAUSE** on the camcorder.

#### 7 EDIT MORE SEGMENTS

Repeat steps 4 through 6 for additional editing, then stop the VCR and camcorder when finished.

### Random Assemble Editing [R.A.Edit]

Create edited videos easily using your camcorder as the source player. You can select up to 8 "cuts" for automatic editing, in any order you like. R.A.Edit is more easily performed when the optional RM-V700U MBR (Multi-Brand Remote) is set to operate with your brand of VCR (see VCR CODE LIST), but can also be performed by operating the VCR manually.

CONTINUED ON NEXT PAGE



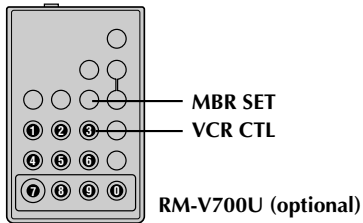

RM-V700U (optional)

VCR CODE LIST

VCR BRAND NAME	BUTTONS (A) (B)	VCR BRAND NAME	BUTTONS (A) (B)
GE	1 1	PHILIPS	1 2
	9 2		3 3
	9 0	PANASONIC	1 3
	9 4		1 7
6 6	1 1		
HITACHI	6 6	9 4	1 3
	6 8	RCA	9 2
JVC A	9 1		9 4
	9 6		6 6
	9 3		6 9
MAGNAVOX	9 5	9 0	SANYO
	1 1	3 6	
	7 1	3 5	
	7 6	SHARP	1 5
MITSUBISHI	6 7		1 0
	6 8	SONY	6 5
NEC	3 7		6 0
	3 8		3 9
PHILIPS	1 9	3 1	TOSHIBA
	9 5	6 9	
	1 1	6 1	
	9 4	ZENITH	1 6
	9 1		
9 6			

SET REMOTE/VCR CODE

SET REMOTE TO OPERATE VCR

1 Turn off the power to the VCR and point the remote toward the VCR's infrared sensor. Then, referring to the chart at left, press and hold MBR SET, and press button (A) and then (B).

- The code is automatically set once you release the MBR SET button, and the VCR's power comes on.

OPERATE THE VCR

2 Make sure the VCR's power is on. Then, while holding VCR CTL, press the button on the remote for the desired function. The functions the remote can control are PLAY, STOP, PAUSE, FF, REW and VCR REC STBY (you don't need to press VCR CTL for this one).

You're now ready to try Random Assemble Editing.

IMPORTANT

Although the MBR is compatible with JVC VCRs and those of many other makers, it may not work with yours or may offer limited functions.

NOTES:

- If the VCR's power doesn't come on in step 1, try another code from the chart.
- Some brands of VCR don't come on automatically. In this case, turn the power on manually and try step 2.
- If the RM-V700U is not able to control the VCR, use the controls on the VCR.

MAKE CONNECTIONS

CONNECT TO . . .

- A JVC VCR EQUIPPED WITH REMOTE PAUSE TERMINAL**  
Connect the editing cable to the Remote PAUSE terminal.

**B JVC VCR NOT EQUIPPED WITH REMOTE PAUSE TERMINAL**  
Connect the editing cable to the R.A. EDIT connector.

**C NON-JVC VCR WITH NEITHER**  
Connect the editing cable to the RM-V700U's Pause-In jack.

All other connections are as shown in the illustration on page 42.

CONTINUED ON NEXT PAGE

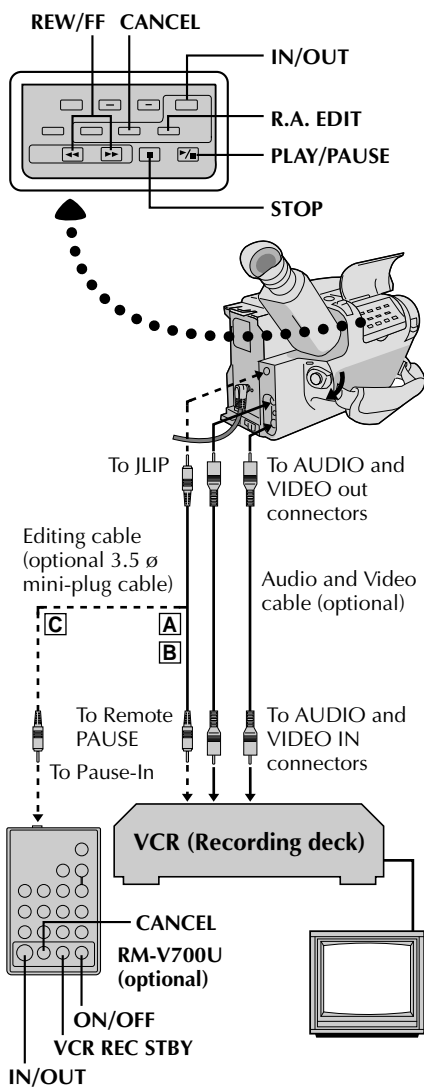

	IN	OUT
1	0:00:25	--:--:--
2		
3		
4		
5		
6		
7		
8		
COUNTER	0:00:25	
TOTAL	0:00:00	

	IN	OUT
1	0:00:25	0:01:05
2	0:03:18	0:03:31
3	0:02:33	0:02:53
4	0:04:11	--:--:--
5		
6		
7		
8		
COUNTER	0:04:11	
TOTAL	0:01:13	

**PREPARE CAMCORDER**

- 2 Insert a recorded tape and set the Power switch to "PLAY".

**PREPARE VCR**

- 3 Turn the power on, insert a recordable tape and engage the AUX mode (refer to VCR's instructions).

**SELECT SCENES****ACCESS R.A. EDIT COUNTER DISPLAY**

- 1 Press **PLAY/PAUSE**, then press **R.A. EDIT** and the counter display appears in the viewfinder and the screen of the connected TV.

**REGISTER BEGINNING OF SCENE**

- 2 Press **REW** or **FF** to locate the beginning of a scene you want, then press **IN/OUT** to register that point. The data appears under IN on the display.

**REGISTER END OF SCENE**

- 3 Press **REW** or **FF** to locate the end of the scene and press **IN/OUT** to register it. The data appears under OUT on the display. The total time of the registered scene(s) is displayed at the bottom of the screen.

**REGISTER ADDITIONAL SCENES**

- 4 Repeat steps 2 and 3 for each additional scene (as many as 8).

**MAKE CORRECTIONS**

- 5 Press **CANCEL** during steps 2 and 3 to erase the most recently registered point.

**NOTES:**

- The RM-V700U can be used to operate other camcorder functions as well. Point the RM-V700U at the camcorder's remote sensor and press any of the following buttons (function appears in parentheses):
  - ON/OFF (camcorder R.A. EDIT)
  - IN/OUT (camcorder IN/OUT)
  - CANCEL (camcorder CANCEL)
- There must be at least one second between an in-point and its corresponding out-point.
- To ensure correct operation, leave at least 15 seconds open between scenes.
- Blank portions of tape cannot be registered as in-points or out-points.
- If it takes more than 5 minutes to search for an in-point, the VCR's Record-Pause mode is cancelled and editing doesn't take place.
- Pressing **R.A.EDIT** clears all in- and out-points from memory.
- Leave a small margin for error around each in-point to ensure the scene is recorded in its entirety.



## ORIGINAL TAPE (camcorder)

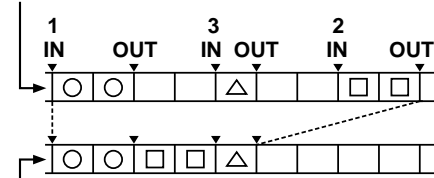

## EDITED TAPE (VCR)

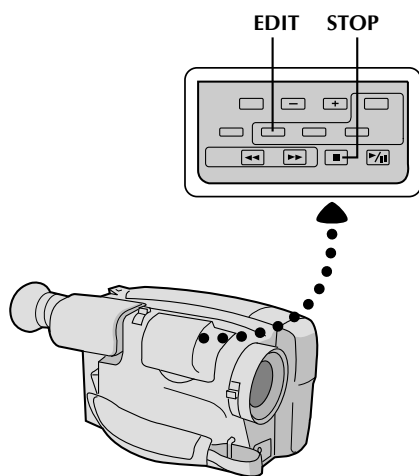

## AUTOMATIC EDITING TO VCR

**ENGAGE VCR'S RECORD-PAUSE MODE**

- 1 Point the remote control toward the VCR's infrared sensor and press **VCR REC STBY**, or manually engage the VCR's Record-Pause mode.

**BEGIN AUTOMATIC EDITING**

- 2 Press **EDIT** on the camcorder, and the previously selected scenes are copied to the VCR in the specified order.

**END AUTOMATIC EDITING**

- 3 When all selected scenes have been copied, the camcorder and VCR enter the still or pause mode. Press **STOP** on both units.

- When finished editing, be sure to disconnect the editing cable and the audio/video cable.

**NOTES:**

- If you performed step 1 on page 41 ("MAKE CONNECTIONS"), keep the remote control pointed at the VCR during editing.
- The on-screen display only appears while the camcorder searches for each scene.
- There may be noise at in- or out-points on the edited tape with certain VCRs.

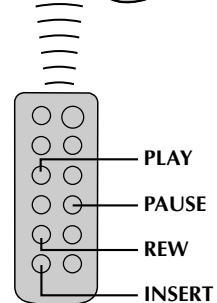
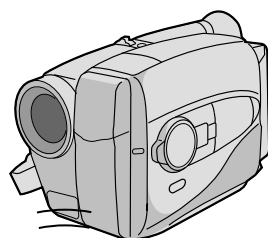
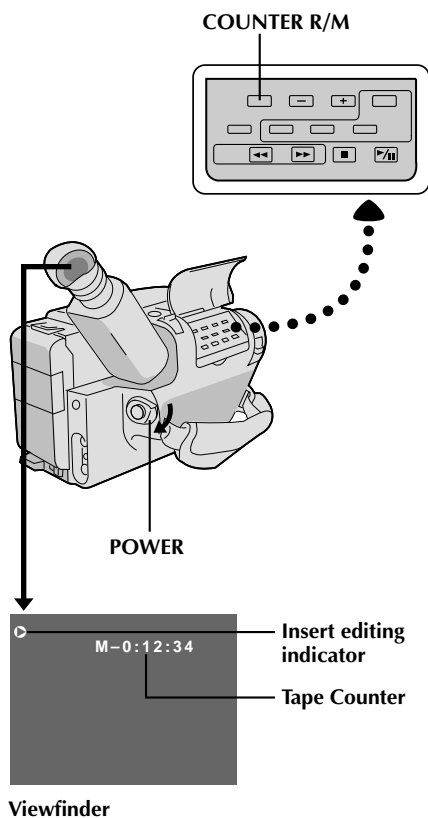

RM-V705U (provided)

## Insert Editing

You can record a new scene into a previously recorded tape, replacing a section of the original recording with minimal picture distortion at the in- and out-points. The original audio remains unchanged.

### NOTE:

Use the RM-V705U remote control unit to perform this procedure.

### 1 SELECT MODE

Set the Power switch to "PLAY".

### 2 FIND EDIT-OUT POINT

Locate the point and press **PAUSE** on the camcorder or the remote control.

### 3 RESET COUNTER

Press and hold **COUNTER R/M** for more than 2 seconds to reset the tape counter, then press for less than 1 second and make sure "M" appears in the viewfinder.

### 4 FIND EDIT-IN POINT

Press **REW** to go a little beyond the beginning of the scene you want to replace, press **PLAY** to view the recorded tape, and press **PAUSE** at exactly at the point where the new scene should start.

### 5 ENGAGE INSERT EDITING MODE

Press and hold **INSERT**, and without releasing **INSERT**, press and release **PAUSE**. The Insert mode is engaged, and the scene the camcorder is aimed at appears on the screen.

### 6 BEGIN INSERT EDITING

Press **RECORDING START/STOP**. When the counter reaches "0:00:00", editing stops automatically and the camcorder enters the Insert-Pause mode.

### 7 END INSERT EDITING

Press **STOP**.

• If a Fade/Wipe effect was in use during Insert Editing, wait about 10 seconds after pressing **STOP** before performing other operations.

### NOTES:

- After step 5, Retake (pg. 18) can be performed.
- The tape may stop slightly before or after the designated end point, and noise bars may appear. Neither indicates a defect in the unit.
- Only video signal is recorded in the Insert Editing mode.

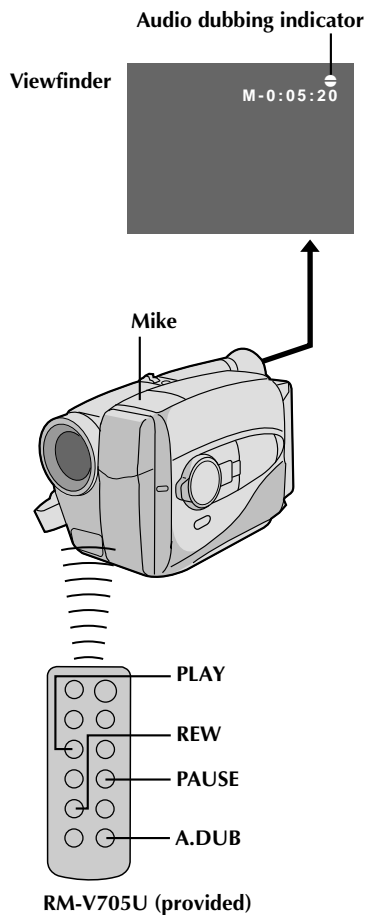

## Audio Dubbing

You can record a new soundtrack on a prerecorded tape (normal audio only).

\*\* Perform steps 1, 2 and 3 of the Insert Editing procedure (pg. 44) before continuing.

- The sound comes from the built-in mike.

### 1 FIND EDIT-IN POINT

- 1 Press **REW** to go a little beyond the beginning of the scene onto which you want to dub new audio, press **PLAY** to view the recorded tape, then press **PAUSE** at exactly the point where dubbing should start.

### 2 ENGAGE AUDIO DUB STANDBY MODE

- 2 Press and hold **A. DUB**, and without releasing **A. DUB**, press and release **PAUSE**.

### 3 BEGIN AUDIO DUBBING

- 3 Press **PLAY/PAUSE**. When the counter reaches "0:00:00", Audio Dubbing stops automatically and the camcorder enters the Audio Dub-Standby mode.

### 4 END AUDIO DUBBING

- 4 Press **STOP**.

#### NOTE:

- Do not press **FF** or **REW** during Audio Dub-Standby, or the edit points will not be accurate.
- If the mike is too close to the TV, or if the TV's volume is too high, whistling or howling may occur.

#### NOTES (for Insert Editing and Audio Dubbing):

- Insert Editing and audio Dubbing may not work correctly if the tape contains blank segments, or if the recording speed was changed during the original recording.
- To edit/dub onto a tape with the recording safety tab removed, cover the hole with adhesive tape.
- Do not press **STOP** during Insert Editing or Audio Dubbing, or the edit points will not be accurate.
- During Insert Editing and Audio Dubbing, when Insert-Pause or Audio Dub-Standby is engaged, the counter may go slightly past "0:00:00". Recording, however, stops at exactly 0:00:00.

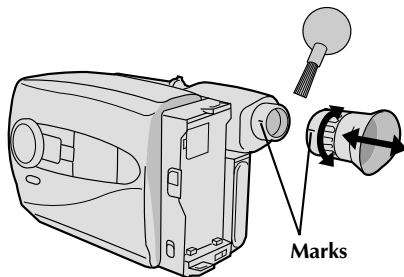
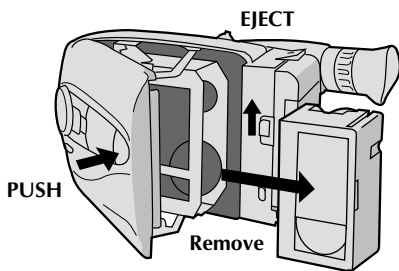
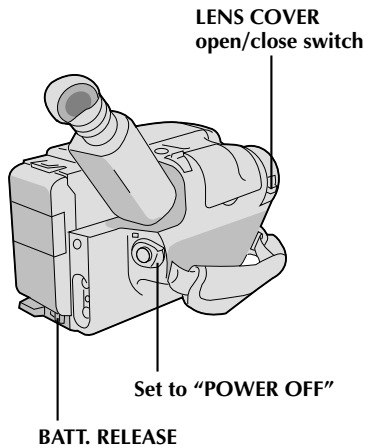
**After Use**

- 1** Set the Power switch to "POWER OFF" to turn off the camcorder.
- 2** Slide EJECT to open the cassette holder, then remove the cassette.
- 3** Close and lock the cassette holder by pressing PUSH.
- 4** Press BATT. RELEASE to remove the battery pack.
- 5** Slide the LENS COVER open/close switch to close the lens cover.

**Cleaning The Camcorder**

- 1** **CLEAN EXTERIOR**  
Wipe gently with a soft cloth.
- 2** **CLEAN LENS**  
Blow it with a blower brush, then wipe gently with lens cleaning paper.
- 3** **REMOVE EYEPIECE**  
Turn the eyepiece counterclockwise and pull it out.
- 4** **CLEAN VIEWFINDER**  
Remove dust using a blower brush.
- 5** **RE-ATTACH EYEPIECE**  
Align the marks, re-attach the eyepiece and turn it clockwise.

**NOTES:**

- Avoid using strong cleaning agents such as benzine or alcohol.
- Cleaning should be done only after the battery pack has been removed or other power units have been disconnected.
- Mold may form if the lens is left dirty.



## TROUBLESHOOTING

# 47

SYMPTOM	POSSIBLE CAUSE(S)
<b>POWER</b>	
No power is supplied.	<ul style="list-style-type: none"> <li>• The battery pack has not been attached correctly (☞ pg. 8).</li> <li>• The battery pack is not charged (☞ pg. 8).</li> <li>• The power supply has not been correctly connected (☞ pg. 9).</li> </ul>
The power suddenly goes off and doesn't come back on by itself.	<ul style="list-style-type: none"> <li>• The battery pack has completely discharged.</li> <li>• Remove the cassette and disconnect the power source, then after a few minutes, try turning the power back on. If it still doesn't come on, consult your nearest JVC dealer.</li> </ul>
<b>RECORDING</b>	
Recording cannot be performed.	<ul style="list-style-type: none"> <li>• The recording tape's Erase Protection tab is missing. Cover the hole with adhesive tape. (Some tapes have sliding tabs. In this case, check the position of the tab.)</li> </ul>
Recording does not start.	<ul style="list-style-type: none"> <li>• The camcorder Power switch has not been set to "CAMERA" (☞ pg. 16).</li> </ul>
<b>PLAYBACK</b>	
The tape is running, but there's no playback picture.	<ul style="list-style-type: none"> <li>• The TV has not been set to its VIDEO mode or channel.</li> <li>• If A/V connection is used, the TV's VIDEO/TV switch has not been set to VIDEO.</li> <li>• The RF unit has not been set to the correct channel.</li> </ul>
Noise bars appear in the playback picture.	<ul style="list-style-type: none"> <li>• Manual Tracking has not been performed (☞ pg. 39).</li> </ul>
Playback picture is blurred or interrupted.	<ul style="list-style-type: none"> <li>• The video heads are dirty or worn out. Consult your nearest JVC dealer for head cleaning or replacement.</li> </ul>
The counter indication is blurred during Still playback.	<ul style="list-style-type: none"> <li>• This is normal.</li> </ul>
<b>TAPE TRANSPORT</b>	
The tape stops during fast-forward or rewind.	<ul style="list-style-type: none"> <li>• The Counter Memory Function has been activated (☞ pg. 39).</li> </ul>
Rewinding or fast-forwarding cannot be performed.	<ul style="list-style-type: none"> <li>• The tape is already fully wound on one reel or the other.</li> </ul>



SYMPTOM	POSSIBLE CAUSE(S)
<b>OTHER</b>	
The tape won't eject.	<ul style="list-style-type: none"> <li>• The battery pack is running low.</li> </ul>
Some functions are not available.	<ul style="list-style-type: none"> <li>• The Shooting Mode selector is set to "FULL AUTO".</li> </ul>
Vertical white lines appear when shooting a very bright object.	<ul style="list-style-type: none"> <li>• This sometimes occurs when the contrast between the background and the object is great. It is not a defect of the camcorder.</li> </ul>
Bright, crystal-shaped spots appear in the viewfinder.	<ul style="list-style-type: none"> <li>• Sunlight is directly entering the lens.</li> </ul>
The picture is blurred in the Quick Review or Retake mode.	<ul style="list-style-type: none"> <li>• This is normal while recording in the EP mode. Some noise may be present while recording in the SP mode (☞ pg. 13).</li> </ul>
An error number (E03) appears in the viewfinder.	<ul style="list-style-type: none"> <li>• Turn the camcorder's power off, then disconnect the power source. After a few minutes, try turning the power on again. If the error number still appears in the viewfinder, consult your nearest JVC dealer.</li> </ul>
The image is out of focus.	<ul style="list-style-type: none"> <li>• The diopter needs to be adjusted (☞ pg. 10).</li> <li>• The scene being shot is adversely affecting the operation of Auto Focus (☞ pg. 24).</li> </ul>
A character generator title and the date and time displays disappear from the viewfinder.	<ul style="list-style-type: none"> <li>• If you remove the power source from the camcorder while the power is on, all settings and selections are erased. Make sure to turn the camcorder's power off before disconnecting the power source.</li> </ul>
Even though the Lens Cover is open, the Lens Cover Warning indicator blinks.	<ul style="list-style-type: none"> <li>• The Lens Cover Warning indicator may blink when the camcorder is used in dark areas, regardless of the position of the Lens Cover.</li> </ul>

The camcorder is a microcomputer-controlled device. External noise and interference (from a TV, a radio, etc.) might prevent it from functioning properly. In such cases, first disconnect its power supply unit (battery pack, AC Power Adapter/Battery Charger, etc.) and clock battery; and then re-connect it and proceed as usual from the beginning.





# INDEX Controls

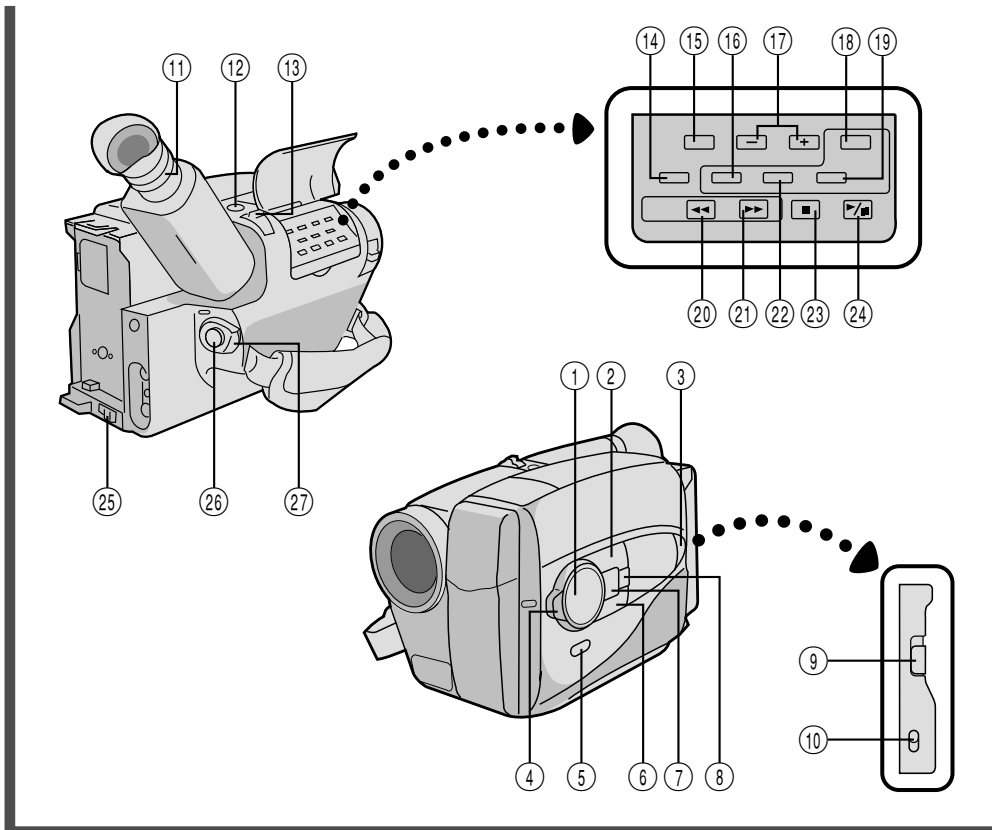

## Controls

- ① Multi-Function Control [FAR/NEAR/+/- Buttons] ..... pg. 11
- ② EFFECT/PROG.AE Button ..... pg. 26
- ③ PUSH Button ..... pg. 5
- ④ Shooting Mode Selector ..... pg. 11
- ⑤ DISPLAY Button ..... pg. 20
- ⑥ FADE/WIPE Button ..... pg. 28
- ⑦ MENU Button ..... pg. 11
- ⑧ D.I.S. [Digital Image Stabilizer] Button ..... pg. 22
- ⑨ EJECT Switch ..... pg. 5
- ⑩ LIGHT ON/AUTO/OFF select switch ..... pg. 19
- ⑪ Diopter Adjustment ..... pg. 10
- ⑫ QUICK REC Button ..... pg. 21
- ⑬ Power Zoom Lever ..... pg. 17
- ⑭ MWB [Manual White Balance] Button ..... pg. 23
- ⑮ Recording Mode [SP/EP] Select Button ..... pg. 13
- COUNTER R [Reset]/M [Memory] Button ..... pg. 39
- ⑯ EDIT Button ..... pg. 43
- ⑰ TRACKING +/- Buttons ..... pg. 39
- ⑱ R.A.EDIT IN/OUT Button ..... pg. 42
- ⑲ R.A.EDIT Button ..... pg. 42
- ⑳ REW Button ..... pg. 38
- RETAKE R [Quick Review] Button ..... pg. 17
- ㉑ FF Button ..... pg. 38
- RETAKE F Button ..... pg. 18
- ㉒ R.A.EDIT CANCEL Button ..... pg. 42
- ㉓ STOP Button ..... pg. 5
- ㉔ PLAY/PAUSE Button ..... pg. 5
- ㉕ BATT. [Battery] RELEASE Switch ..... pg. 5
- ㉖ Recording Start/Stop Button ..... pg. 5
- ㉗ POWER Switch ..... pg. 10



# 50

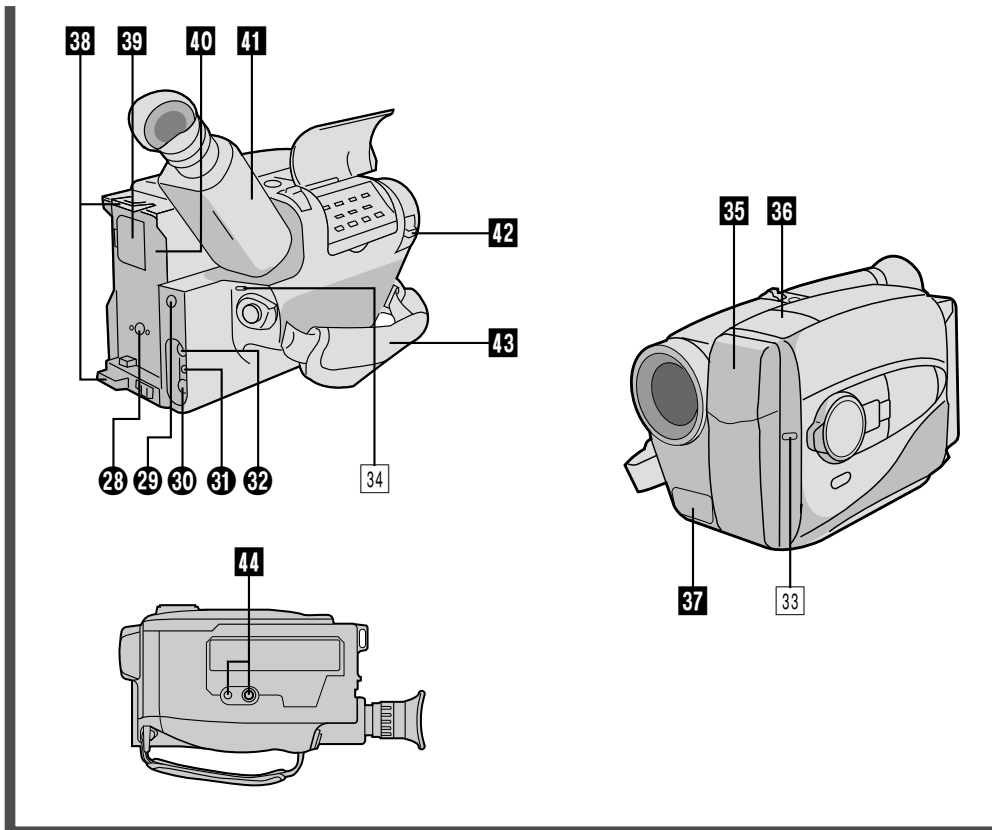

## Connectors

- 28 DC IN Jack ..... pg. 9
- 29 JLIP (Joint Level Interface Protocol) Connector.
  - Connect the Editing Cable when performing Random Assemble Editing (pg. 42).
  - In the future, it will be used to connect the camcorder to a device such as a personal computer.
- 30 VIDEO Out Jack ..... pg. 37
- 31 RF DC OUT Jack ..... pg. 37
- 32 AUDIO Out Jack ..... pg. 37

## Indicators

- 33 Tally Lamp ..... pg. 16
- 34 Power On Indicator ..... pg. 16

## Other Parts

- 35 Video Light ..... pg. 19
- 36 Microphone ..... pg. 45
- 37 Infrared beam sensor window ..... pg. 15  
(Be careful not to cover this area; built-in here is the sensor necessary for shooting.)
- 38 Shoulder Strap Eyelets ..... pg. 14
- 39 Clock Battery Compartment ..... pg. 10
- 40 Battery Pack Mount ..... pg. 8
- 41 Electronic Viewfinder ..... pg. 10
- 42 LENS COVER Switch ..... pg. 5
- 43 Grip Strap ..... pg. 14
- 44 Tripod Mounting Socket ..... pg. 14

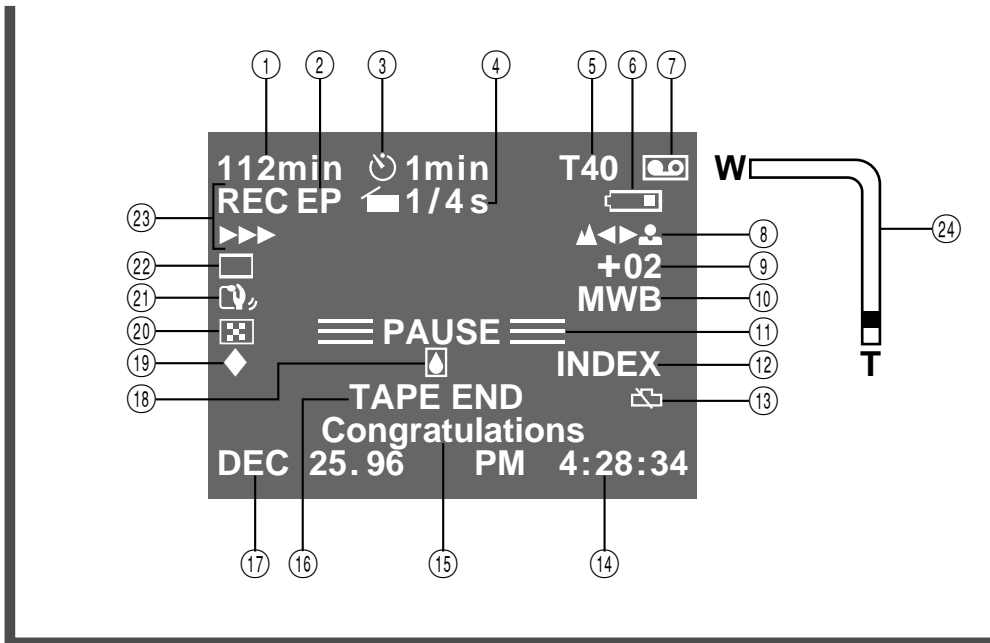

Viewfinder Indications

- ① Remaining Tape Time ..... pg. 16
- ② Recording Mode (SP/EP) Indicator ..... pg. 13
- ③ Interval Timer Indicator ..... pg. 34
- ④ Recording Time Indicator ..... pg. 35
- ⑤ Tape Length Display ..... pg. 12
- ⑥ Battery Pack Remaining Power Indicator ..... pg. 8  
Changes as follows according to the battery pack's remaining power level: "■■■■-■■■-■■-■-□". When the power is almost gone, the indicator blinks, then the unit shuts off. Replace the battery pack with a fully charged one.  
**(Note:** The symbol containing 3 darkened squares — ■■■ — does not necessarily mean that the battery pack is fully charged.)
- ⑦ Cassette Indicator  
Blinks when no cassette inserted; remains steadily lit when cassette inserted.
- ⑧ Focus Indicator ..... pg. 24
- ⑨ Exposure Level Display ..... pg. 22
- ⑩ White Balance Mode Indicator ..... pg. 23
- ⑪ Record-Standby Mode Indicator ..... pg. 16
- ⑫ Index Code Marking ..... pg. 18
- ⑬ Clock Warning  
Once the power is turned on and the indicator blinks for about 10 seconds, perform the date and time settings (pg. 11). After setting is complete, turn the power off and disconnect the power source. If you re-connect it and turn the power on and the indicator is blinking, that means that the clock (lithium) battery is either not installed or has discharged. Install, or replace the old battery with, a new one (pg. 10).
- ⑭ Time Display ..... pg. 20
- ⑮ Instant Title Display ..... pg. 32
- ⑯ Tape End Display ..... pg. 16  
Appears when the end of the tape is reached during playback, recording or fast-forward.
- ⑰ Date Display ..... pg. 20
- ⑱ Condensation Warning  
When this indication appears, all functions are disabled. Turn the unit off (without removing the power source) for a few hours, and when you turn it on again the indicator should disappear.
- ⑲ Main Menu Setting Change Indicator ..... pg. 31
- ⑳ FADE/WIPE indicator ..... pg. 28
- ㉑ D.I.S. (Digital Image Stabilizer) Indicator ..... pg. 22
- ㉒ EFFECT/PROG.AE indicator ..... pg. 26
- ㉓ Recording Indicator ..... pg. 16
- ㉔ Zoom Indicator Bar ..... pg. 17



**A**

- AC Power Adapter ..... pg. 9
- Animation Recording ..... pg. 35
- Audio Dubbing ..... pg. 45
- Auto Focus ..... pg. 24

**B**

- Battery Pack ..... pg. 8
- Brighten the Image ..... pg. 22

**C**

- Car Battery ..... pg. 9
- Cassette Adapter ..... pg. 36
- Character Generator ..... pg. 33
- Charge Marker ..... pg. 9
- Charging the Battery Pack ..... pg. 8
- Cinema Mode ..... pg. 27
- Clock (Lithium) Battery ..... pg. 10
- Connection to a VCR/TV ..... pg. 37
- Contents ..... pg. 7
- Counter Memory ..... pg. 39

**D**

- Darken the Image ..... pg. 22
- Date/Time Insert ..... pg. 20
- Date/Time Setting ..... pg. 11
- Digital Image Stabilizer ..... pg. 22
- Discharge the Battery pack ..... pg. 8
- Dioptr Adjust ..... pg. 10

**E**

- Erase Protection ..... pg. 13
- Exposure Control ..... pg. 22

**F**

- Fade-in/out ..... pg. 28
- Fast-Forward Tape ..... pg. 38
- Focus Lock ..... pg. 24

**G**

- Grip Adjustment ..... pg. 14

**H**

- High Speed Shutter Mode ..... pg. 27

**I**

- Index Code Marking ..... pg. 18
- Insert Cassette ..... pg. 13
- Insert Editing ..... pg. 44
- Instant Titles ..... pg. 32
- Interval Timer ..... pg. 34

**M**

- Main Menu ..... pg. 31
- Manual Focus ..... pg. 25
- MBR Code Setting ..... pg. 41

**P**

- Playback ..... pg. 36
- Program AE with Special Effects ..... pg. 27
- Provided Accessories ..... pg. 6

**Q**

- Quick Rec ..... pg. 21
- Quick Review ..... pg. 17

**R**

- Random Assemble Editing ..... pg. 40–43
- Record-Standby ..... pg. 16
- Recording, Advanced Features ..... pg. 20–35
- Recording ..... pg. 16
- Recording, Start/Stop ..... pg. 16
- Recording Mode Setting ..... pg. 13
- Remote Control Unit ..... pg. 15
- Remove Cassette ..... pg. 13
- Retake ..... pg. 18
- Rewind Tape ..... pg. 38

**S**

- Sepia Mode ..... pg. 27
- Shoulder Strap Attachment ..... pg. 14
- Shuttle Search ..... pg. 39
- Specifications ..... pg. 55
- Sports Mode ..... pg. 27
- Still Playback ..... pg. 39
- Sub Menu ..... pg. 31

**T**

- Tape Counter ..... pg. 38
- Tape Dubbing ..... pg. 40
- Tape Length Setting ..... pg. 12
- Time-Lapse Shooting ..... pg. 35
- Tracking ..... pg. 39
- Tripod Mounting ..... pg. 14
- Twilight Mode ..... pg. 27

**V**

- Viewfinder Adjustment ..... pg. 10
- Viewfinder, Indications ..... pg. 51

**W**

- White Balance Adjustment ..... pg. 23
- Wipe in/out ..... pg. 28

**Z**

- Zooming ..... pg. 17



## CAUTIONS

# 53

### DANGER: Video Light

- The video light becomes extremely hot. Do not touch it either while in operation or soon after turning it off, otherwise serious injury may result.
- Do not place the camcorder into the carrying case immediately after using the video light, since it remains extremely hot.
- When operating, keep a distance of about 30 cm (1 ft.) between the video light and people or object.
- Do not use near flammable or explosive materials.

### When using the AC Power Adapter/Charger in areas other than the USA

- The provided AC Power Adapter/Charger features automatic voltage selection in the AC range from 110 V to 240 V.

### USING HOUSEHOLD AC PLUG ADAPTER

In case of connecting the unit's power cord to an AC wall outlet other than American National Standard C73 series type use an AC plug adapter, called a "Siemens Plug", as shown. For this AC plug adapter, consult your nearest JVC dealer.

Plug adapter

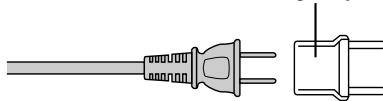

### INFORMATION

This device complies with Part 15 of FCC Rules. Operation is subject to the following two conditions:

- (1) This device may not cause harmful interference, and (2) this device must accept any interference received, including interference that may cause undesired operation. Change or modifications not approved by the party responsible for compliance could void the user's authority to operate the equipment. This equipment has been tested and found to comply with the limits for a Class B digital device, pursuant to Part 15 of the FCC Rules. These limits are designed to provide reasonable protection against harmful interference in a residential installation. This equipment generates, uses, and can radiate radio frequency energy and, if not installed and used in accordance with the instructions, may cause harmful interference to radio communications. However, there is no guarantee that interference will not occur in a particular installation. If this equipment does cause harmful interference to radio or television reception, which can be determined by turning the equipment off and on, the user is encouraged to try to correct the interference by one or more of the following measures:

- Reorient or relocate the receiving antenna.
- Increase the separation between the equipment and receiver.
- Connect the equipment into an outlet on a circuit different from that to which the receiver is connected.
- Consult the dealer or an experienced radio/TV technician for help.

### General Battery Precautions

- When the C-P6U or C-P7U (cassette adapter) are not functioning even when correctly operated, the batteries are exhausted. Replace them with fresh ones.
- Use only the following batteries:  
C-P6U or C-P7U ..... AA (R6) size

Please make note of the following rules for battery use. When misused, batteries can leak or explode.

1. Refer to the C-P6U/C-P7U instructions when replacing batteries.
2. **Do not** use old and new batteries together.
3. **Do not** use two different kinds of batteries. Although sizes may be the same, voltages may differ.
4. **Do not** expose batteries to excessive heat as they can leak or explode.
5. **Do not** dispose of batteries in a fire.
6. Remove batteries from the unit if it is to be stored for an extended period to avoid battery leakage which can cause malfunctions.

### Battery Packs

The supplied battery pack is a nickel-cadmium battery. Before using the supplied battery pack or an optional battery pack, be sure to read the following cautions:

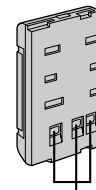

Terminals

1. **To avoid hazard . . .**
  - .... **do not** burn.
  - .... **do not** short-circuit the terminals.
  - .... **do not** modify or disassemble.
  - .... use only specified chargers.
2. **To prevent damage and prolong service life . . .**
  - .... **do not** subject to unnecessary shock.
  - .... avoid repeated charging without fully discharging.
  - .... charge in an environment where temperatures are within the tolerances shown in the chart below. This is a chemical reaction type battery—cooler temperatures impede chemical reaction, while warmer temperatures can prevent complete charging.
  - .... store in a cool, dry place. Extended exposure to high temperatures will increase natural discharge and shorten service life.
  - .... avoid prolonged uncharged storage.
  - .... remove from charger or powered unit when not in use, as some machines use current even when switched off.



- 3. To prevent damage to the camcorder . . .
  - .... replace the battery pack when it begins to deliver less recording time per charge.

**NOTE:**

*It is normal for the battery pack to be warm after charging, or after use.*

Temperature Range Specifications

Charging .....	10°C to 35°C
Operation .....	0°C to 40°C
Storage .....	-10°C to 30°C

**NOTES:**

- Recharging time is based on room temperature of 20°C.
- The lower the temperature, the longer recharging takes.

**Cassettes**

To properly use and store your cassettes, be sure to read the following cautions:

- 1. During use . . .
  - .... make sure the cassette bears the VHS-C mark.
  - .... be aware that recording onto prerecorded tapes automatically erases the previously recorded video and audio signals.
  - .... make sure the cassette is positioned properly when inserting.
  - .... do not load and unload the cassette repeatedly without allowing the tape to run at all. This slackens the tape and can result in damage.
  - .... do not open the front tape cover. This exposes the tape to fingerprints and dust.
- 2. Store cassettes . . .
  - .... away from heaters or other heat sources.
  - .... out of direct sunlight.
  - .... where they won't be subject to unnecessary shock or vibration.
  - .... where they won't be exposed to strong magnetic fields (such as those generated by motors, transformers or magnets).
  - .... vertically, in their original cases.

**Main Unit**

- 1. For safety, DO NOT . . .
  - .... open the camcorder's chassis.
  - .... disassemble or modify the unit.
  - .... short-circuit the terminals of the battery pack. Keep it away from metallic objects when not in use.
  - .... allow inflammables, water or metallic objects to enter the unit.
  - .... remove the battery pack or disconnect the power supply while the power is on.
  - .... leave the battery pack attached when the camcorder is not in use.

- 2. Avoid using the unit . . .

- .... in places subject to excessive humidity or dust.
- .... in places subject to soot or steam such as near a cooking stove.
- .... in places subject to excessive shock or vibration.
- .... near a television set.
- .... near appliances generating strong magnetic or electric fields (speakers, broadcasting antennas, etc.).
- .... in places subject to extremely high (over 40°C or 104°F) or extremely low (under 0°C or 32°F) temperatures.

- 3. DO NOT leave the unit . . .

- .... in places of over 50°C (122°F).
- .... in places where humidity is extremely low (below 35%) or extremely high (above 80%).
- .... in direct sunlight.
- .... in a closed car in summer.
- .... near a heater.

- 4. To protect the unit, DO NOT . . .

- .... allow it to become wet.
- .... drop the unit or strike it against hard objects.
- .... subject it to shock or excessive vibration during transportation.
- .... keep the lens directed at extremely bright objects for long periods.
- .... direct the eyepiece of the viewfinder at the sun.
- .... carry it by holding the viewfinder.
- .... swing it excessively when using the shoulder strap.

- 5. This camcorder features a built-in head cleaner which automatically cleans the heads and head drum when a cassette is loaded or unloaded. If, however, the heads become dirty and cause blurriness or interruption in the playback picture, consult your nearest JVC dealer.

**About moisture condensation . . .**

- You have observed that pouring a cold liquid into a glass will cause drops of water to form on the glass' outer surface. This same phenomenon occurs on the head drum of a camcorder when it is moved from a cool place to a warm place, after heating a cold room, under extremely humid conditions or in a place directly subjected to the cool air from an air conditioner.
- Moisture on the head drum can cause severe damage to the video tape, and can lead to internal damage to the camcorder itself.

**Serious malfunctioning**

If malfunctioning occurs, stop using the unit immediately and consult your local JVC dealer.



## SPECIFICATIONS

# 55

### GENERAL

Format	: VHS NTSC standard
Power source	: DC 6V
Power consumption	
GR-AX910	
Light on	: 8.9 W
Light off	: 5.9 W
GR-AX810	
Light on	: 8.7 W
Light off	: 5.7 W
Signal system	: NTSC-type
Video recording system	
Luminance	: FM recording
Color	: Converted sub-carrier direct recording * Conforms to VHS standard
Cassette	:  cassette
Tape speed	
SP	: 33.35 mm/sec. (1-5/16 ips)
EP	: 11.12 mm/sec. (7/16 ips)
Recording time (max.)	
SP	: 40 minutes
EP	: 120 minutes (with TC-40 cassette)
Operating temperature	: 0°C to +40°C (32°F to 104°F)
Operating humidity	: 35% to 80%
Storage temperature	: -20°C to +50°C (-4°F to 122°F)
Weight	
GR-AX910	: Approx. 760 g (1.7 lbs)
GR-AX810	: Approx. 780 g (1.8 lbs)
Dimensions (Including viewfinder)	
GR-AX910	: 109 (W) x 113 (H) x 206 (D) mm (4-5/16" x 4-1/2" x 8-1/8")
GR-AX810	: 109 (W) x 113 (H) x 226 (D) mm (4-5/16" x 4-1/2" x 8-15/16")

### CAMERA

Pick up	: 1/4" format CCD
Lens	: F1.2, f = 4.1 to 57.4 mm, 14:1 power zoom lens with auto iris and macro control, filter diameter 46 mm
Viewfinder	: Electronic viewfinder with • 0.5" black/white CRT (GR-AX810) • 0.55" color LCD (GR-AX910)
White balance adjustment	: Auto/Manual adjustment

### VIDEO

Output	: 1 Vp-p, 75 ohms, unbalanced (via VIDEO out connector)
--------	---

### AUDIO

Output	: -8 dBs, 1 k-ohm (via AUDIO out connector)
--------	---

### AC POWER ADAPTER/BATTERY CHARGER (AA-V11U)

Power requirement	
U.S.A. and Canada	: AC 120 V~, 60 HZ
Other countries	: AC 110 V to 240 V~, 50/60 HZ
Power consumption	: 23 W
Output	
Charge	: DC 8.5 V , 1.3 A
VTR	: DC 6.3 V , 1.8 A
Charging system	: Constant current, peak detection, timer controlled
Dimensions	: 150 (W) x 42 (H) x 68 (D) mm (5-15/16" x 1-11/16" x 2-11/16")
Weight	: Approx. 320 g (0.71 lbs)

### CASSETTE ADAPTER (C-P7U)

Dimensions	: 188 (W) x 25 (H) x 104 (D) mm (7-7/16" x 1" x 4-1/8")
Weight	: Approx. 240 g (0.53 lbs)
Accessory	: "AA (R6)"-size battery x 1

### Provided Accessories ..... pg. 6

### Optional Accessories

- Battery Packs BN-V12U, BN-V22U, BN-V25U
- Car Battery Charger BH-V3U
- Battery Charger BH-VC10U
- Car Battery Cord AP-V7U
- RF Unit RF-V5U
- Compact VHS-C Cassettes TC-40/30/20
- Active Carrying Bag CB-V7U

\* Some accessories are not available in some areas. Please consult your nearest JVC dealer for details on accessories and their availability.

*Specifications shown are for SP mode unless otherwise indicated. E. & O. E. Design and specifications subject to change without notice.*

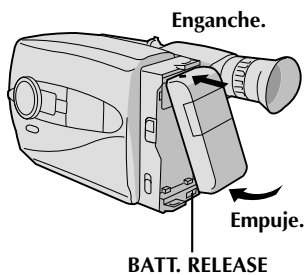
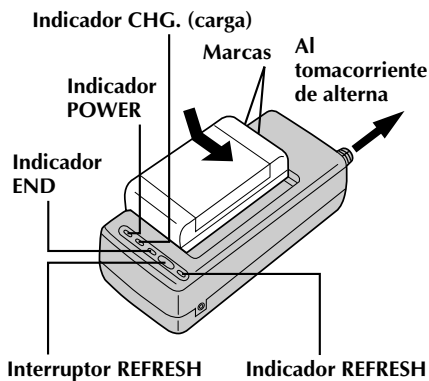

BATT. RELEASE

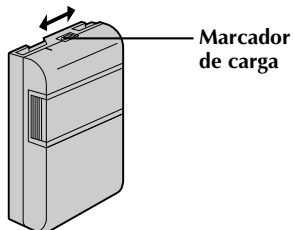
**\*\*INDICADOR DE CARGA**

Se ha suministrado un indicador de carga sobre el paquete de pilas para ayudarle a recordar si ha sido cargado o no. Los dos colores suministrados (rojo y negro), le permiten seleccionar la carga y la descarga.

**\*\*REFRESCADO**

El adaptador de CA se caracteriza por la función REFRESH que le permite descargar totalmente el paquete de pilas antes de recargarlo.

**Para descargar las pilas . . .**

..... coloque el paquete de pilas en el adaptador como se muestra en la ilustración de la izquierda. Luego presione REFRESH. El indicador REFRESH se enciende cuando se inicia la descarga y se apaga cuando la descarga ha terminado.

**Alimentación**

Esta cámara de video posee un sistema de alimentación de 3 vías que le permite seleccionar la fuente de alimentación más apropiada.

**NOTAS:**

- Sin alimentación no hay ninguna función disponible.
- Utilice exclusivamente la alimentación indicada.
- No utilice la unidades de alimentación suministradas con otro equipo.

**CARGA DEL PAQUETE DE PILAS****1 ALIMENTACION**

Conecte el cordón de alimentación de CA del cargador a un tomacorriente. Se encenderá la luz del indicador de alimentación.

**2 COLOCACION DEL PAQUETE DE PILAS**

Alinee las marcas y deslice el paquete de pilas en la dirección de la flecha hasta que quede bloqueado en su lugar. Se enciende la luz indicadora CHG.

**3 EXTRACCION DEL PAQUETE DE PILAS**

Cuando la carga está completa, se encenderá el indicador END. Deslice el paquete de pilas en el sentido opuesto al de la flecha.

PAQUETE DE PILAS	CARGA	DESCARGA
BN-V11U	aprox. 1 h. 10 m.	aprox. 3 h. 30 m.
BN-V12U	aprox. 1 h. 10 m.	aprox. 3 h. 30 m.
BN-V22U	aprox. 2 h. 10 m.	aprox. 7 h.
BN-V25U	aprox. 2 h. 40 m.	aprox. 10 h.

**USO DEL PAQUETE DE PILAS****1 COLOCACION DEL PAQUETE DE PILAS**

Enganche la parte superior del mismo en la cámara de video y empuje el paquete de pilas hasta que se bloquee en su lugar.

**2 EXTRACCION DEL PAQUETE DE PILAS**

Deslice BATT. RELEASE y extraiga el paquete de pilas.

**TIEMPO DE GRABACION APROXIMADO**

PAQUETE DE PILAS	GR-AX910	GR-AX810
BN-V11U	1 h. (35 m.)	1 h. 5m. (35 m.)
BN-V12U	1 h. (35 m.)	1 h. 5m. (35 m.)
BN-V22U	2 h. 10 m. (1 h. 20 m.)	2 h. 15 m. (1 h. 25 m.)
BN-V25U	2 h. 50 m. (1 h. 50 m.)	3 h. (1 h. 50 m.)

( ) : cuando la luz de video está encendida.



Si la unidad comienza a funcionar mal, deje de usarla inmediatamente y consulte a su concesionario local de JVC.

**ALIMENTACION**

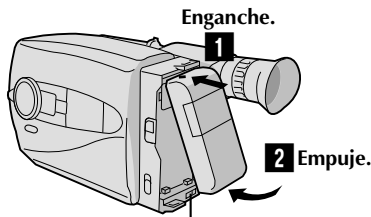

**BATT. RELEASE** (extracción de la batería)

**Utilización de la batería**

- 1 Enganche el extremo superior de la batería en la cámara de video. (Procedimiento para carga: P. 8)
- 2 Empuje la batería hacia adentro hasta que quede bloqueada en su lugar.

**Para extraer la batería**

Deslice BATT. RELEASE y extraiga la batería.

**INSERCIÓN DEL CASSETTE DE VIDEO**

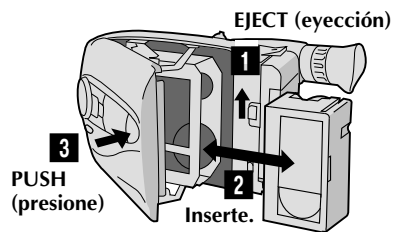

- 1 Deslice EJECT.
- 2 Inserte un cassette de video.
- 3 Presione PUSH. (Por más detalles, P. 13.)

**REPRODUCCION**

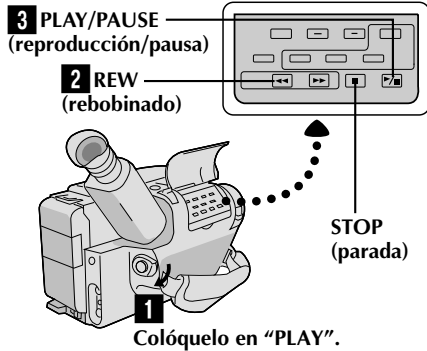

- 1 Ajuste el interruptor de alimentación en "PLAY".
  - 2 Presione **REW**.  
— La cinta se detiene automáticamente al comienzo de la misma.
  - 3 Presione **PLAY/PAUSE**.  
— Comienza la reproducción y la imagen aparece en el visor.
- Presione **STOP** para detener la grabación. (Por más detalles, P. 38.)

■ O simplemente reproduzca la cinta en un VCR de VHS utilizando el adaptador de cassette (VHS Playpak). P. 36.

**FILMACION**

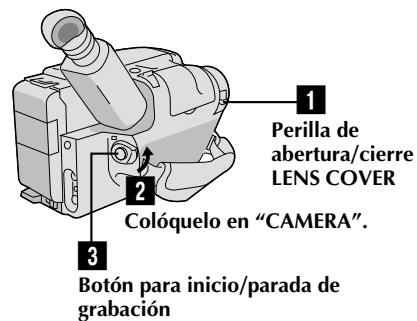

- 1 Deslice la perilla de apertura/cierre LENS COVER para abrir la tapa del objetivo.
  - 2 Ajuste el interruptor de alimentación en "CAMERA".  
— El indicador de alimentación se encenderá y aparecerá una imagen en el visor.
  - 3 Presione el botón inicio/parada de grabación.  
— Comenzará la grabación.
- Para detener temporalmente la grabación, presione nuevamente el botón de inicio/parada de grabación. (Por más detalles, P. 16.)



58

FOR SERVICING

## HOW TO LOCATE YOUR JVC SERVICE CENTER

**TOLL FREE: 1-800-252-5722**

**Dear customer:**

*In order to receive the most satisfaction from your purchase, read the instruction booklet before operating the unit. In the event that repair is necessary, or for the address nearest your location, please refer to the factory service center list below or within the Continental United States, call 1-800-252-5722 for your authorized servicer. Remember to retain your Bill of Sale for Warranty Service.*

— JVC

### JVC SERVICE & ENGINEERING COMPANY OF AMERICA

DIVISION OF US JVC CORP.

#### FACTORY SERVICE CENTER LOCATIONS

107 Little Falls Road  
Fairfield, NJ 07004-2105  
(201) 808-9279

1500 Lakes Parkway  
Lawrenceville, GA 30243-5357  
(770) 339-2522

705 Enterprise Street  
Aurora, IL 60504-8149  
(708) 851-7855

5665 Corporate Avenue  
Cypress, CA 90630-0024  
(714) 229-8011

10700 Hammerly, Suite 110  
Houston, TX 77043-2310  
(713) 935-9331

2969 Mapunapuna Place  
Honolulu, HI 96819-2040  
(808) 833-5828

230 Eliot Street  
Ashland, MA 01721-2377  
(508) 881-5923

14505 Commerce Way  
Miami Lakes, FL 33016-1512  
(305) 362-6252

890 Dubuque Avenue  
South San Francisco, CA 94080-1804  
(415) 871-2666

*Sophisticated electronic products may require occasional service. Just as quality is a keyword in the engineering and production of the wide array of JVC products, service is the key to maintaining the high level performance for which JVC is world famous. The JVC service and engineering organization stands behind our products.*

NATIONAL HEADQUARTERS  
JVC SERVICE & ENGINEERING COMPANY OF AMERICA  
DIVISION OF US JVC CORP.  
107 Little Falls Road  
Fairfield, NJ 07004-2105

#### ***If you ship the product...***

*Pack your JVC unit in the original carton or one of equivalent size and strength. Enclose, with the unit, a letter stating the problem or symptom that exists and also a copy of the receipt or bill of sale you received when you purchased your JVC unit. Print your home return address on the outside and the inside of the carton. Send to the appropriate JVC Factory Service Center as listed above.*

#### **ACCESSORIES**

*To purchase accessories for your JVC product, you may contact your local JVC Dealer.  
Or from the 48 Continental United States call toll free:  
1-800-882-2345.*

#### **Don't service it yourself.**

##### **CAUTION**

*To prevent electrical shock, do not open the cabinet. No user serviceable parts inside.  
Refer servicing to qualified service personnel.*



# WARRANTY

# 59

## LIMITED WARRANTY

## CONSUMER VIDEO 1-90

JVC COMPANY OF AMERICA warrants this product and all parts thereof, except as set forth below **ONLY TO THE ORIGINAL PURCHASER AT RETAIL** to be **FREE FROM DEFECTIVE MATERIALS AND WORKMANSHIP** from the date of original retail purchase for the period as shown below. ("The Warranty Period")

PARTS	<b>1</b> YR	LABOR	<b>90</b> DAYS
-------	-------------	-------	----------------

THIS LIMITED WARRANTY IS VALID ONLY IN THE FIFTY (50) UNITED STATES, THE DISTRICT OF COLUMBIA AND IN COMMONWEALTH OF PUERTO RICO.

### WHAT WE WILL DO:

If this product is found to be defective, JVC will repair or replace defective parts at no charge to the original owner. Such repair and replacement services shall be rendered by JVC during normal business hours at JVC authorized service centers. Parts used for replacement are warranted only for the remainder of the Warranty Period. All products and parts thereof may be brought to a JVC authorized service center on a carry-in basis except for Television sets having a screen size 25 inches and above which are covered on an in-home basis.

### WHAT YOU MUST DO FOR WARRANTY SERVICE:

Return your product to a JVC authorized service center with a copy of your bill of sale. For your nearest JVC authorized service center, please call toll free: (800) 252-5722.

If service is not available locally, box the product carefully, preferably in the original carton, and ship, insured, with a copy of your bill of sale plus a letter of explanation of the problem to the nearest JVC Factory Service Center, the name and location of which will be given to you by the toll-free number.

If you have any questions concerning your JVC Product, please contact our Customer Relations Department.

### WHAT IS NOT COVERED:

This limited warranty provided by JVC does not cover:

1. Products which have been subject to abuse, accident, alteration, modification, tampering, negligence, misuse, faulty installation, lack of reasonable care, or if repaired or serviced by anyone other than a service facility authorized by JVC to render such service, or if affixed to any attachment not provided with the products, or if the model or serial number has been altered, tampered with, defaced or removed;
2. Initial installation and installation and removal for repair;
3. Operational adjustments covered in the Owner's Manual, normal maintenance, video and audio head cleaning;
4. Damage that occurs in shipment, due to act of God, and cosmetic damage;
5. Signal reception problems and failures due to line power surge;
6. Video Pick-up Tubes/CCD Image Sensor, Cartridge, Stylus (Needle) are covered for 90 days from the date of purchase;
7. Accessories;
8. Batteries (except that Rechargeable Batteries are covered for 90 days from the date of purchase);from the date of purchase);

There are no other express warranties except as listed above.

THE DURATION OF ANY IMPLIED WARRANTIES INCLUDING THE IMPLIED WARRANTY OF MERCHANTABILITY, IS LIMITED TO THE DURATION OF THE EXPRESS WARRANTY HEREIN.

JVC SHALL NOT BE LIABLE FOR THE LOSS OF USE OF THE PRODUCT, INCONVENIENCE, LOSS OR ANY OTHER DAMAGES, WHETHER DIRECT, INCIDENTAL OR CONSEQUENTIAL (INCLUDING, WITHOUT LIMITATION, DAMAGE TO TAPES, RECORDS OR DISCS) RESULTING FROM THE USE OF THIS PRODUCT, OR ARISING OUT OF ANY BREACH OF THIS WARRANTY. ALL EXPRESS AND IMPLIED WARRANTIES, INCLUDING THE WARRANTIES OF MERCHANTABILITY AND FITNESS FOR PARTICULAR PURPOSE, ARE LIMITED TO THE WARRANTY PERIOD SET FORTH ABOVE.

Some states do not allow the exclusion of incidental or consequential damages or limitations on how long an implied warranty lasts, so these limitations or exclusions may not apply to you. This warranty gives you specific legal rights and you may also have other rights which vary from state to state.

JVC COMPANY OF AMERICA DIVISION OF US JVC CORP.	41 Slater Drive Elmwood Park, New Jersey 07407
--	---

REFURBISHED PRODUCTS CARRY A SEPARATE WARRANTY, THIS WARRANTY DOES NOT APPLY. FOR DETAILS OF REFURBISHED PRODUCT WARRANTY, PLEASE REFER TO THE REFURBISHED PRODUCT WARRANTY INFORMATION PACKAGED WITH EACH REFURBISHED PRODUCT.

### For customer use:

Enter below the Model No. and Serial No. which is located either on the rear, bottom or side of the cabinet. Retain this information for future reference.

**Model No.:** \_\_\_\_\_

**Serial No.:** \_\_\_\_\_

**Purchase date:** \_\_\_\_\_

**Name of dealer:** \_\_\_\_\_

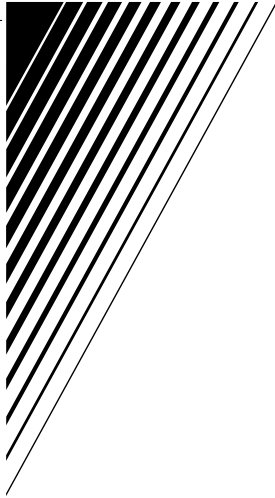

GR-AX910/AX810



# JVC



JVC COMPANY OF AMERICA  
DIVISION OF US JVC CORP.  
41 Slater Drive, Elmwood Park, N.J. 07407

COPYRIGHT© 1996 VICTOR COMPANY OF JAPAN, LTD.

U Printed in Japan  
0296TOV\*UN\*YP



## Free Manuals Download Website

<http://myh66.com>

<http://usermanuals.us>

<http://www.somanuals.com>

<http://www.4manuals.cc>

<http://www.manual-lib.com>

<http://www.404manual.com>

<http://www.luxmanual.com>

<http://aubethermostatmanual.com>

Golf course search by state

<http://golfingnear.com>

Email search by domain

<http://emailbydomain.com>

Auto manuals search

<http://auto.somanuals.com>

TV manuals search

<http://tv.somanuals.com>