

The JBL logo is displayed in white, bold, sans-serif capital letters on an orange square background.

Simply Cinema™



G Cinema simple set-up guide

thank you for choosing JBL. For over 50 years, JBL has been involved in every aspect of musical and film recording and reproduction, from live performances to monitoring the recordings you play in your home, car, or office.

We're confident that the **JBL system** you have chosen will provide every note of enjoyment that you expected – and that when you think about purchasing additional audio equipment for your home, car, or office, you will once again choose JBL.

Please take a moment to complete the enclosed profile card. It enables us to keep you posted on our latest advancements, and helps us to better understand our customers and build products that meet your needs and expectations.

JBL Consumer Products

included

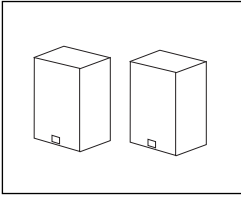

Two G40 satellite speakers.

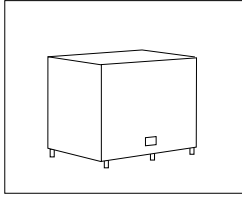

One subwoofer.

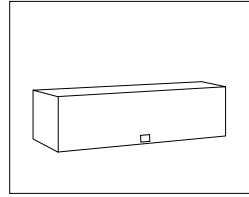

One center speaker.

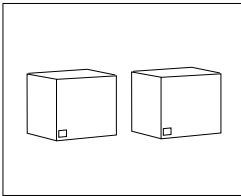

One pair of surround speakers.

features

- 2-way satellite speakers with 2" fiber cone high-frequency drivers
- 8" subwoofer with bass reflex enclosure for improved bass performance
- Video-shielded center speaker

one. Speaker Placement

Satellites

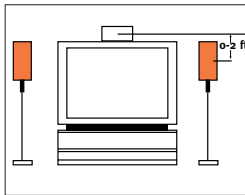
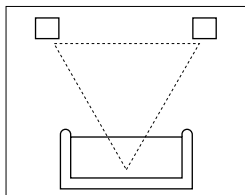

Subwoofer

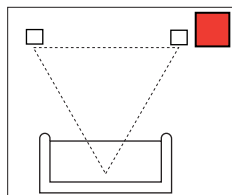

Surrounds

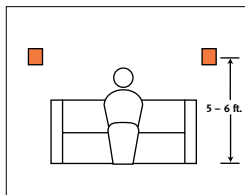
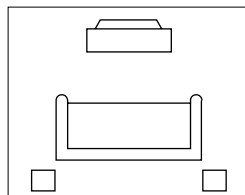

Center

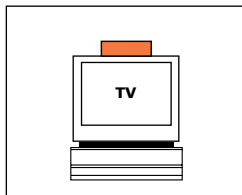

Mounting Options

Satellites

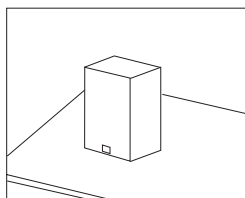

On shelves.

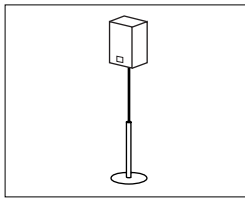

On stands.

Surrounds

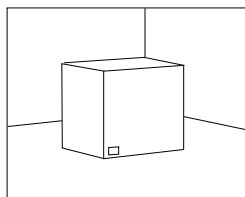

On shelves.

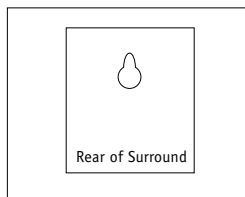

On walls.*

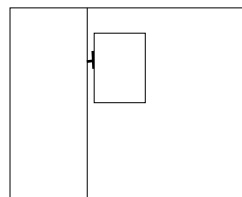

two. Speaker Connections

Connection Tips

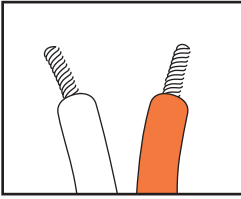

Separate and strip the ends of the speaker wire as shown. Speakers and electronics terminals have corresponding (+) and (-) terminals. It is impor-

tant to connect both speakers identically: (+) on the speaker to (+) on the amplifier and (-) on the speaker to (-) on the amplifier. Wiring "out of

phase" results in thin sound, weak bass and a poor stereo image.

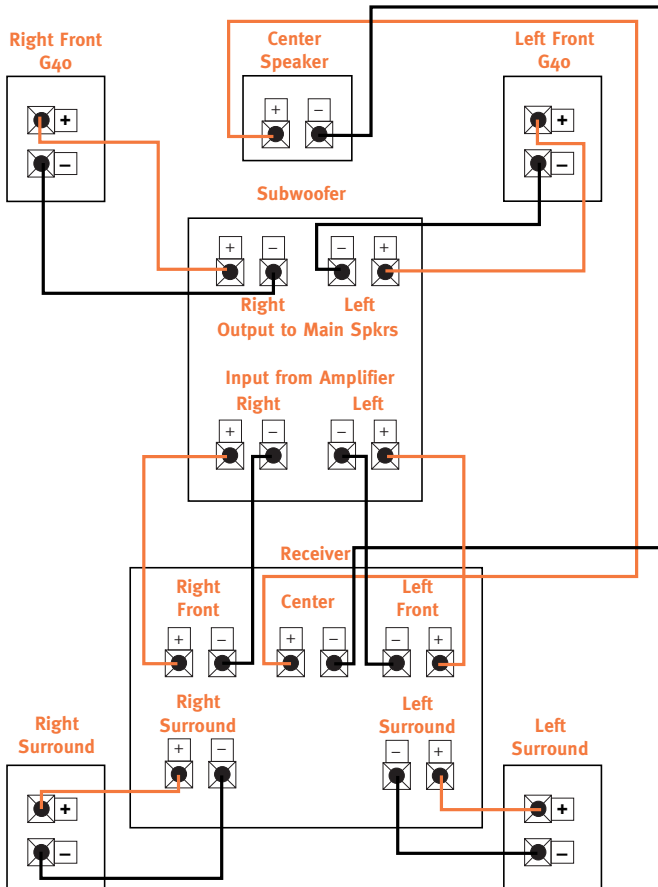

Troubleshooting

If the system plays at low volumes but shuts off as volume is increased, check the following:

- Check all wires and connections between receiver/amplifier and speakers. Make sure all wires are connected. Make sure none of the speaker wires are frayed, cut, or punctured.
- If more than one pair of main speakers is being used, check the minimum impedance requirements of your receiver/amplifier.

If there is low bass output, check the following:

- Make sure the connections to the left and right "Speaker Inputs" have the correct polarity (+ and -).

If there is no sound from the surround speakers, check the following:

- Check all wires and connections between receiver/amplifier and speakers. Make sure all wires are connected. Make sure none of the speaker

wires are frayed, cut, or punctured.

- Review proper operation of your receiver/amplifier and its surround sound features.
- Make sure the movie or TV show, you are watching is recorded in Dolby® surround. If it is not, check to see if your receiver/amplifier has other surround modes you may use.

Specifications

G Cinema System

Frequency Response

45Hz – 20kHz

G40 with G Cinema Subwoofer

Tweeter

2" fiber cone

Midrange

5" fiber cone

Subwoofer

8" fiber cone

Crossover Frequencies

2.2kHz (midrange to tweeter)

150Hz (subwoofer to satellite)

Frequency Response

45Hz – 20kHz

Sensitivity

87dB @ 1 watt/1 meter

Impedance

8 ohms nominal

Recommended Power**

10 – 70 watts

Dimensions (HxWxD)

Satellite:

11 x 6-1/2 x 7-1/4 inches

280 x 165 x 184mm

Subwoofer:

15 x 15-1/8 x 15-1/8 inches

381 x 384 x 384mm

Weight

Satellite: 7 lbs/3.2 kg

Subwoofer: 20 lbs/9.1 kg

G Movies Center

High Frequency Transducer

2" fiber cone

Low Frequency

Two 4-1/2" fiber cones

Crossover Frequency

9.0kHz

Frequency Response

100Hz – 20kHz

Sensitivity

89dB @ 1 watt/1 meter

Impedance

8 ohms nominal

Recommended Power**

10 – 70 watts

Dimensions (HxWxD)

6 x 16 x 6-1/4 inches

152 x 406 x 159mm

Weight

9 lbs/4.1 kg

Shipping Weight

19 lbs/8.7 kg

Surround

Driver

4-1/2" (full range)

Frequency Response

120Hz – 16kHz

Sensitivity

87dB @ 1 watt/1 meter

Impedance

8 ohms nominal

Recommended Power**

10 – 35 watts

Dimensions (HxWxD)

6 x 6-3/8 x 5-1/2 inches

152 x 162 x 140mm

Weight

3 lbs/1.4 kg

*The customer is responsible for proper selection and use of mounting hardware, available through hardware stores, to properly and safely wall-mount the speakers. This product is not intended for ceiling mounting.

**The maximum recommended amplifier power rating will ensure proper system headroom to allow for occasional program peaks. We do not recommend sustained operation at these maximum power levels.

Occasional refinements may be made to existing products without notice, but will always meet or exceed original specifications unless otherwise stated.

U.S. Warranty – For warranty information outside the U.S. please contact your local distributor.

JBL 5-Year Limited Warranty
This is an important document.
Attach your bill of sale to this page and keep it in a safe place. Your bill of sale is your warranty.

The JBL warranty on loudspeakers (except enclosures) remains in effect for *five years* from the date of the first consumer purchase. Enclosures are warranted for *two years* from the date of the first consumer purchase.

Who is protected by this warranty

The JBL warranty protects the original owner and all subsequent owners providing that the JBL product was purchased from an authorized dealer in the United States or purchased by military personnel from an authorized military outlet. *A copy of the original dated bill of sale must be presented whenever warranty service is required.*

For warranty policy outside of the U.S., please contact your local distributor.

What is covered by this warranty

Except as specified below, the JBL warranty covers all defects

in material and workmanship. The following are *not* covered: Damage caused by accident, misuse, abuse, product modification or neglect; damage occurring during shipment; damage from failure to follow instructions contained in the instruction manual; damage resulting from the performance of repairs by someone not authorized by JBL; damage caused by installation of parts that do not conform to JBL specifications; units used for other than home use; any claims based on misrepresentations by the seller; products sold on an "as-is" or final sale basis; or the cost of installing, removing, or reinstalling the unit. JBL's liability is limited to the repair or replacement, at our option, of any defective product and shall not include incidental or consequential damages. JBL reserves the right to replace a discontinued model with a comparable model. Any replacement units or parts may be new or rebuilt.

To obtain warranty service

If you require warranty service, please return the product to your dealer. If this is not possible and you live in the United States, please call 1-800-336-4JBL, for

information on how to obtain service or replacement. If purchased outside the United States, contact your local dealer for repair or replacement.

Do not return products to the JBL factory without authorization. They will be returned unopened.

You are responsible for transporting your product for repair or replacement. JBL will pay reasonable return charges for delivery to any location in the United States if the repair or replacement is covered under the warranty.

Correspondence with JBL should be addressed to: JBL Customer Service, 80 Crossways Park West, Woodbury, NY 11797 or fax us at 516-496-0812. Outside the United States, please contact your local distributor.

This warranty gives you specific legal rights. You may also have other rights which vary from state to state. Some states do not allow the exclusion or limitation of incidental or consequential damages or limitations on how long an implied warranty lasts, so the above may not apply to you.



JBL Consumer Products
80 Crossways Park West, Woodbury, NY 11797
8500 Balboa Boulevard, Northridge, CA 91329
1-800-336-4JBL (4525) (USA only)

© 1996 JBL, Incorporated. JBL is a registered trademark of JBL, Incorporated. Dolby Pro Logic is a registered trademark of Dolby Laboratories Licensing Corporation.

Printed in USA 5/96 Part No. GCINOM

harman consumer group

harman consumer group

Declaration of Conformity



We, JBL Europe A/S
Kongevejen 194B
DK-3460 Birkerød
DENMARK

declare in own responsibility, that the loudspeakers described in this owner's manual are in compliance with technical standards:
EN 50 081-1/1992
EN 50 082-1/3 1995

Steen Michaelsen
JBL Europe A/S
Birkerød, DENMARK, 5/96

Free Manuals Download Website

<http://myh66.com>

<http://usermanuals.us>

<http://www.somanuals.com>

<http://www.4manuals.cc>

<http://www.manual-lib.com>

<http://www.404manual.com>

<http://www.luxmanual.com>

<http://aubethermostatmanual.com>

Golf course search by state

<http://golfingnear.com>

Email search by domain

<http://emailbydomain.com>

Auto manuals search

<http://auto.somanuals.com>

TV manuals search

<http://tv.somanuals.com>