

# Intel® Server Board S3000PT

## Quick Start User's Guide

Thank you for buying an Intel® Server Board S3000PT. The following information will help you integrate your new server board into a third-party chassis.

For details on selecting a third-party chassis, please see <http://www.intel.com/go/serverbuilder> and <http://support.intel.com/support/motherboards/server>.

When installing the server board into a third-party chassis, refer to the instructions that came with the chassis.

If you are not familiar with ESD (Electrostatic Discharge) procedures used during system integration, please see the *Intel® Server Board and Server Chassis Safety Information* document at <http://support.intel.com/support/motherboards/server/sb/cs-010770.htm>.

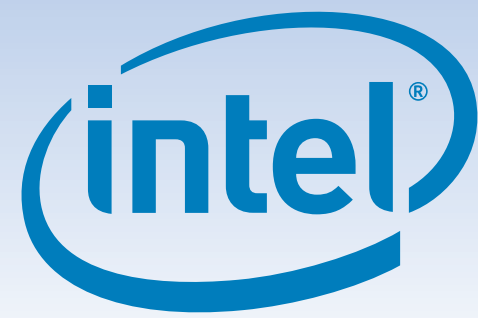
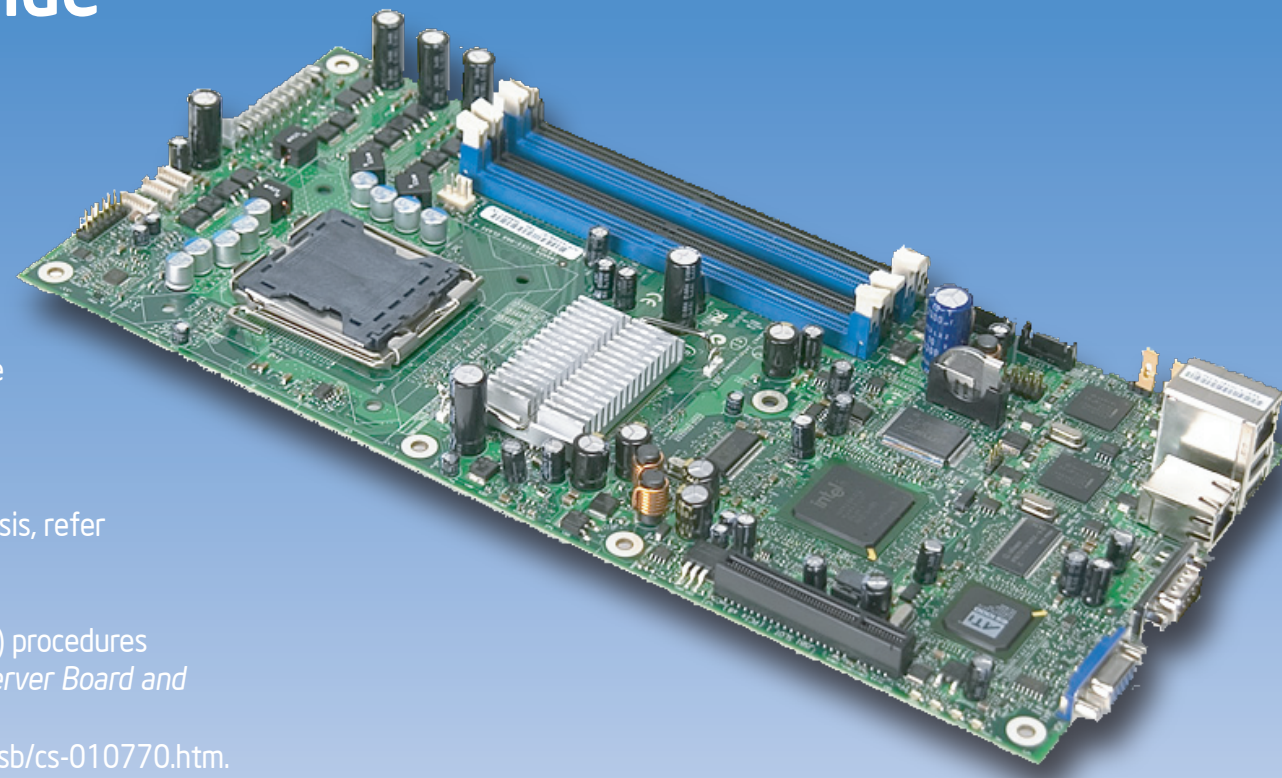

### Warning



**Safety information:** Read all the safety and caution statements in this document before performing any of the instructions. Also, see the *Intel® Server Board and Server Chassis Safety Information* document at: <http://support.intel.com/support/motherboards/server/sb/cs-010770.htm> for complete safety information.

### Caution



**Electrostatic discharge:** Observe normal Electrostatic Discharge (ESD) procedures during system integration to avoid possible damage to the server board and/or other components of the system.

### Tools Required

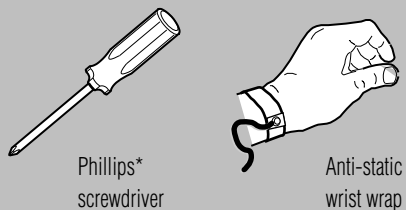

D69382-001



Intel is a registered trademark of Intel Corporation or its subsidiaries in the United States and other countries.

\*Other names and brands may be claimed as the property of others. Copyright © 2006, Intel Corporation. All rights reserved.

### Minimum Hardware Requirements

To avoid integration difficulties and possible board damage, your system must meet the following minimum requirements:

- **Processor:** Intel® Celeron® D processor, minimum 2.4 GHz with chassis compatible fan / heatsink
- **Memory Type:** Minimum of one 256-MB, DDR2 533/667 MHz compliant unbuffered, ECC or non-ECC, SPD SDRAM 240-pin gold DIMM
- **Power:** Per board, minimum of 200 W with 2 A of standby current, which meets the SSI EPS 12-V specification

## 1

### Prepare Chassis

Refer to the instructions that came with your chassis for preparatory steps.

## 2

### Install Server Board

Place the board(s) into the chassis, making sure that back panel I/O ports and chassis or I/O shield openings align correctly. Verify that server board mounting holes align correctly with the chassis standoffs.

Place the server board into the chassis as shown below. Use the fasteners that came with your chassis to secure the server board to the chassis.

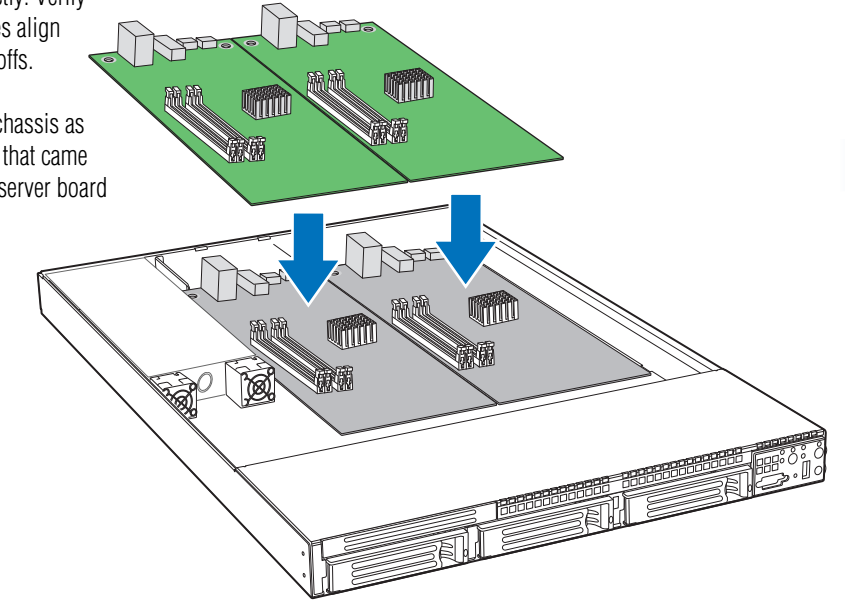

## 3

### Install Processor



#### Notes and Cautions

1. When unpackaging a processor, hold it by the edges to avoid touching the pins.
2. This server board has a "zero-insertion force" socket. If processor does not drop easily into socket, make sure lever is in the fully open position.

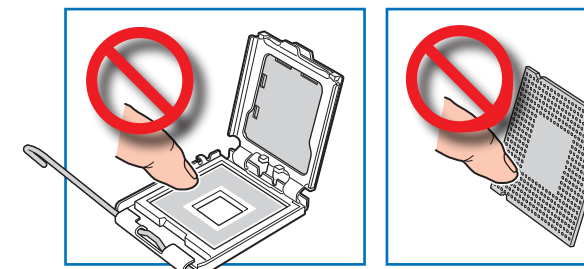

#### A. Open the Socket Lever

- 1 Push the lever handle down and away from the socket to release it.
- 2 Pull the lever and open all the way.

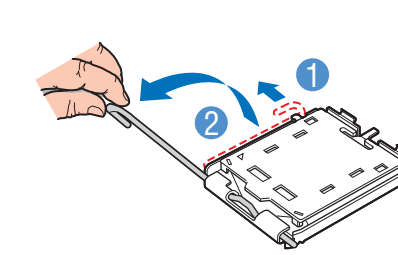

#### B. Open the Load Plate

- 1 Push the rear tab with your finger tip to bring the front end of the load plate up slightly.
- 2 Open the load plate as shown.

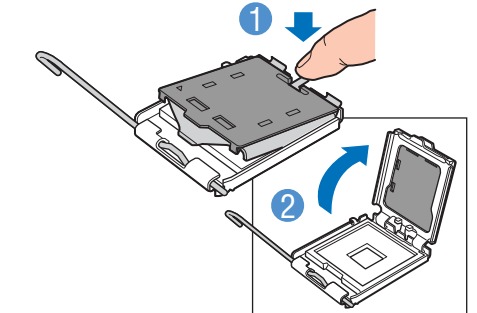

#### C. Remove the Processor Protective Cover

- 1 Take the processor out of the box and remove the protective shipping cover.

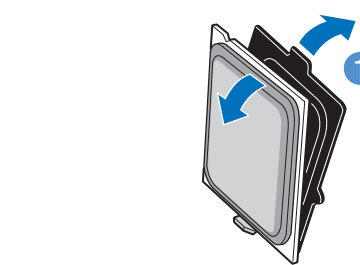

#### D. Install the Processor

- 1 Orient the processor with the socket so that the processor cutout matches the socket notch.
- 2 Install the processor as shown.

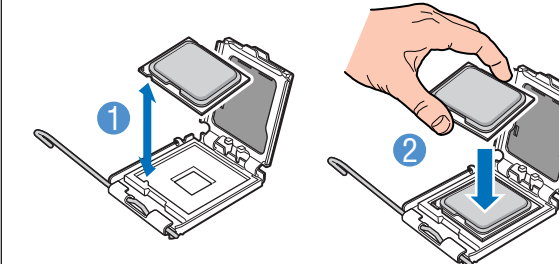

#### E. Remove Socket Protective Cover

- 1 Grasp the socket protective cover tab and pull away from the load plate as shown.
- 2 Remove the socket protective cover and store for future use.

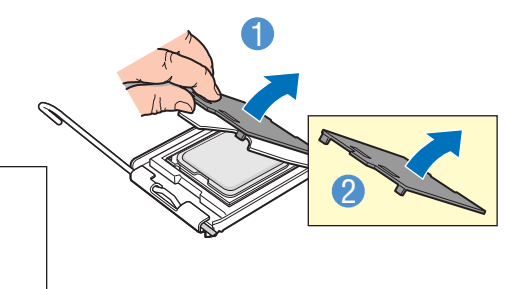

#### F. Close Load Plate and Socket Lever

- 1 Close the load plate all the way as shown.
- 2 With your finger, push down on the load plate as shown.
- 3 Close the socket lever and ensure that the load plate tab engages under the socket level when fully closed.

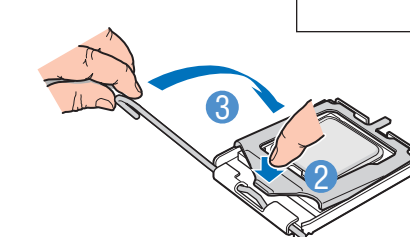
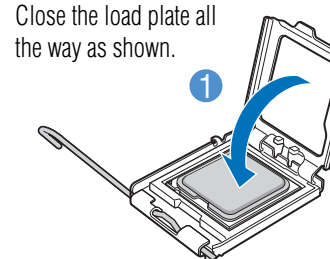

## 4

### Install Passive Heatsink



The heatsink may have thermal interface material (TIM) on the underside of it. Use caution so that you do not damage the TIM. Use gloves to avoid sharp edges.

- 1 If present, remove the protective film on the TIM. If no TIM is present, evenly coat the heatsink with a thermal compound.
- 2 Align heatsink fins to the front and back of the chassis for correct airflow.
- 3 Lightly tighten each fastener diagonally, according to the numbers shown.
- 4 Securely re-tighten each fastener again in the same order.

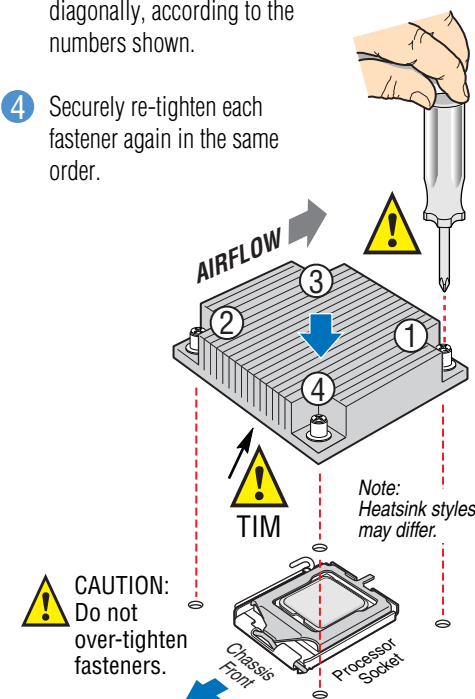

## 5

### Install DIMM Memory



This server board does not support DDR memory. You must use DDR2 DIMMs to avoid possible damage to server board DIMM sockets.

#### DDR2 DIMM Memory Identification

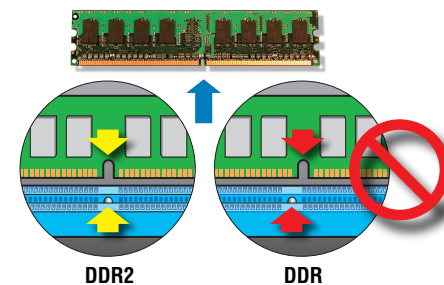

DIMM notch and socket bump must align as shown.

**Memory Type:** Minimum of one 256-MB, DDR2 533/667 MHz compliant unbuffered, ECC or non-ECC, SPD SDRAM 240-pin gold DIMM.

#### Notes and Cautions:

Populate DIMMs in the order of: 1A, 1B, 2A, 2B.

The DIMM size, speed, and vendor must be the same within a bank. However, the DIMM size can vary between banks. For example, Bank 1 can use two 256-MB DIMMs and Bank 2 can use two 512-MB DIMMs.

For additional memory configurations, go to: <http://support.intel.com/support/motherboards/server>

Memory sizing and configuration are guaranteed only for qualified DIMMs approved by Intel.

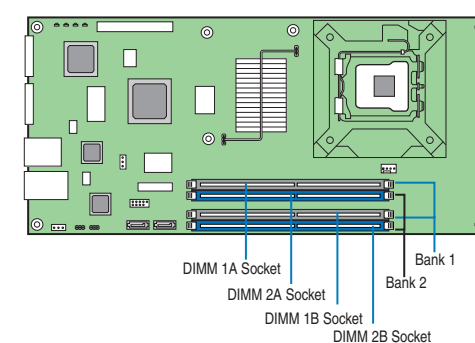

#### To Install DIMMs:

- 1 Open both DIMM socket levers.
- 2 Note location of alignment notch.
- 3 Insert DIMM, making sure the connector edge of the DIMM aligns correctly with the slot.
- 4 Push down firmly on the DIMM until it snaps into place and both levers close.

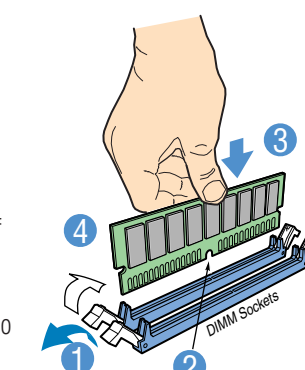

**Warning:** Avoid touching gold contacts when handling or installing DIMMs.

Go to Side 2.



### 6 Make Server Board Power Connections

See the documentation that came with your chassis for power connection information.

Attach the main power connector to the server board.

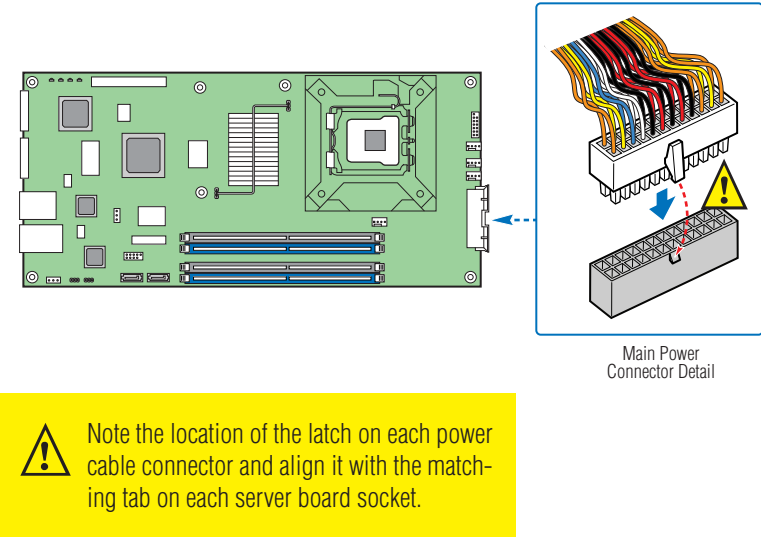

### 7 Connect SATA Drives / Front Control Panel Cable

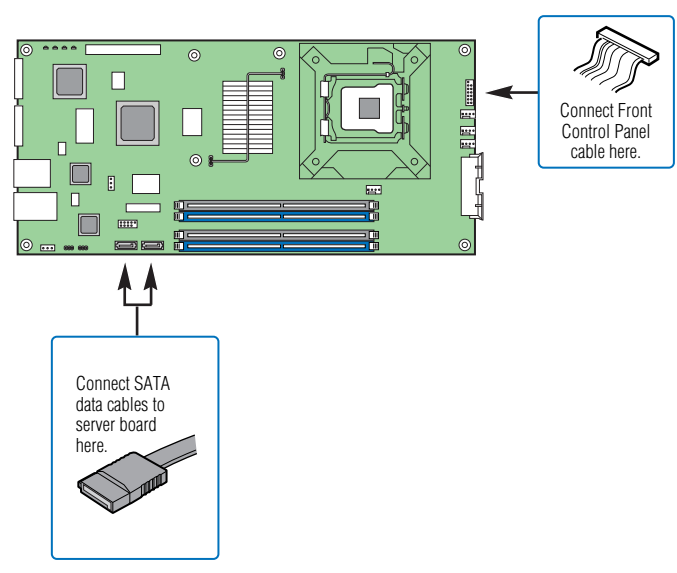

### 8 Connect Chassis Fans

See the documentation that came with your chassis for information on chassis fan connections.

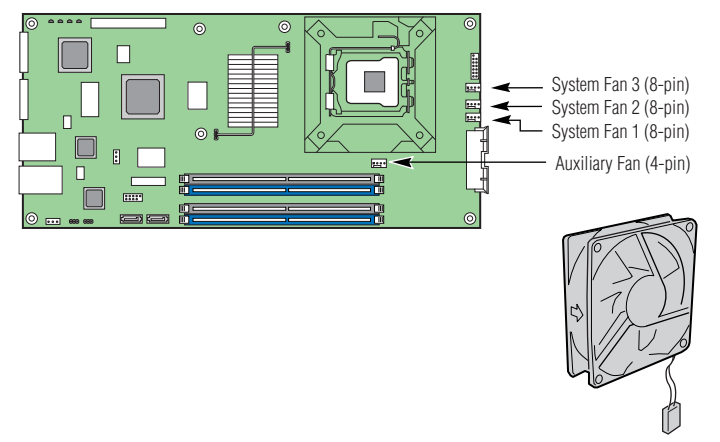

### 9 Complete Hardware Setup

Before installing your operating system, you must make I/O connections and plug in AC power.

- See the documentation that came with your chassis to complete rack or pedestal installation.
- Connect your keyboard, mouse, video, and other I/O cables as shown.
- Connect the AC power cable last.

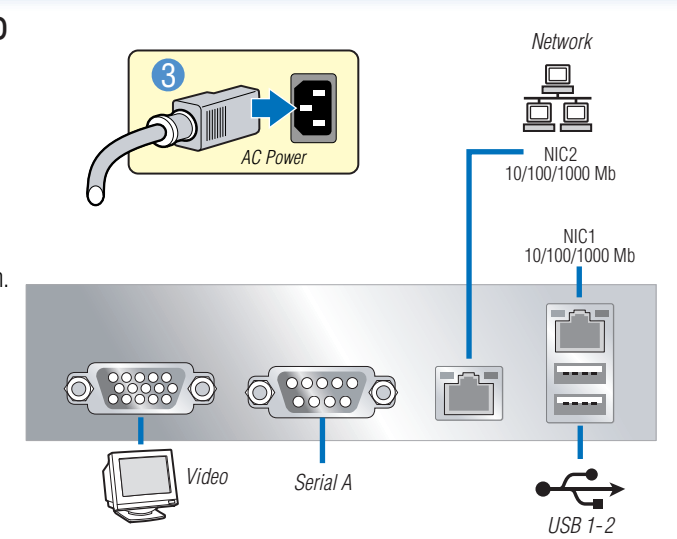

### 10 Install Software

- Confirm BIOS Version:** Look on the Server/System Management screen in the BIOS Setup Utility to determine the installed BIOS version. Compare this to the versions at: <http://support.intel.com/support/motherboards/server>. If new versions are available, update the BIOS on your system. See the BIOS `readme.txt` for update instructions.
- Configure On-board RAID via Ctrl-E:** Refer to the installation instructions provided with the RAID controller.
- Install Operating System:** Refer to the installation instructions provided with the operating system.
- Install Operating System Drivers:** Download the latest drivers from the product support website at: <http://support.intel.com/support/motherboards/server>.

## Reference

### Common Problems and Solutions

For a list of hardware components that have been tested with this system, see: <http://support.intel.com/support/motherboards/server/s3000PT/>

The system does not boot or show video at power-on:

- Check that +12V CPU power connector is plugged in. Without this cable the processor will not have any power.
- Beep code 4-3-2-1 means you have unrecognized or bad memory. Remove and replace DIMMs one bank at a time to isolate which one is causing problems.
- Remember, all DIMMs must be:
  - DDR2 400/533/667 MHz compliant unbuffered, ECC or non-ECC, SPD SDRAM 240-pin gold DIMMs.
  - The same speed.
  - From the same manufacturer.
  - Installed beginning with DIMM 1A.
- Your power supply must provide a minimum of 200-W with 2A standby current, which complies with the SSI EPS 12V specification.

The system sometimes works, but is exhibiting erratic behavior:

- This is typically the result of using an under-rated power supply. Make sure you are using at least a 200-W power supply.

### Component Layout

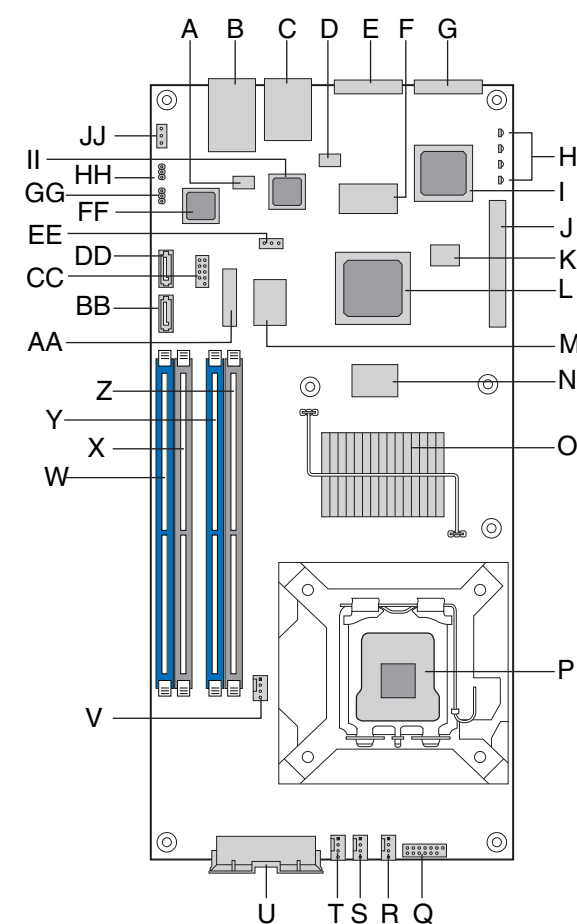

- A. NIC1 SP1 Flash
- B. NIC1 RJ-45 and USB 1 and 2 Connector
- C. NIC2 RJ-45 Connector
- D. NIC2 SP1 EEPROM
- E. Serial A Connector
- F. Video Memory
- G. VGA Connector
- H. POST LEDs
- I. ATI® ES1000 Video Controller
- J. PCI-E x8 Riser Slot
- K. BIOS Flash (SP1)
- L. Intel® 82802 ICH7R Controller Hub
- M. Super I/O (SIO)
- N. Clock Generator
- O. Intel® S3000 Memory Controller Hub (MCH)
- P. 775-Land (LGA) CPU Socket
- Q. 2x7 Front Panel Header
- R. System Fan 3 (8-pin)
- S. System Fan 2 (8-pin)
- T. System Fan 1 (8-pin)
- U. 2x9 Power Connector
- V. Auxiliary Fan (4-pin)
- W. Memory Slot DIMM 2B
- X. Memory Slot DIMM 1B
- Y. Memory Slot DIMM 2A
- Z. Memory Slot DIMM 1A
- AA. Battery
- BB. SATA Port 2
- CC. USB 3 and 4 Header
- DD. SATA Port 1
- EE. Serial B Header
- FF. Intel® 82573E LAN Controller
- GG. Intel® AMT Firmware (NIC1) Update Jumper
- HH. Clear CMOS Jumper
- II. Intel® 82573V LAN Controller
- JJ. SMBus Connector

Accessories and Order Codes	
1U Passive Heatsink (Intel)	AXXUPHS

Server Board SKUs	
10-pack Intel® Server Board S3000PT (horizontal power connector)	BPTHBB
10-pack Intel® Server Board S3000PT (vertical power connector)	BPTVBB

Reference Chassis Accessories	
1U Rack-mount Chassis (Evercase®)	R913-PTS
1U Passive Heatsink (Cooljag®)	OAK-B6

A complete list of accessories and spares can be found at: [www.intel.com/go/serverbuilder](http://www.intel.com/go/serverbuilder).

## Free Manuals Download Website

<http://myh66.com>

<http://usermanuals.us>

<http://www.somanuals.com>

<http://www.4manuals.cc>

<http://www.manual-lib.com>

<http://www.404manual.com>

<http://www.luxmanual.com>

<http://aubethermostatmanual.com>

Golf course search by state

<http://golfingnear.com>

Email search by domain

<http://emailbydomain.com>

Auto manuals search

<http://auto.somanuals.com>

TV manuals search

<http://tv.somanuals.com>