Kodak EasyShare ZD710 zoom digital camera



User's guide

www.kodak.com

For interactive tutorials, www.kodak.com/go/howto

For help with your camera, www.kodak.com/go/zd710support

Kodak

Eastman Kodak Company

Rochester, New York 14650

© Eastman Kodak Company, 2007

All screen images are simulated.

Kodak and EasyShare are trademarks of Eastman Kodak Company.

P/N 4J6235_en

Front view

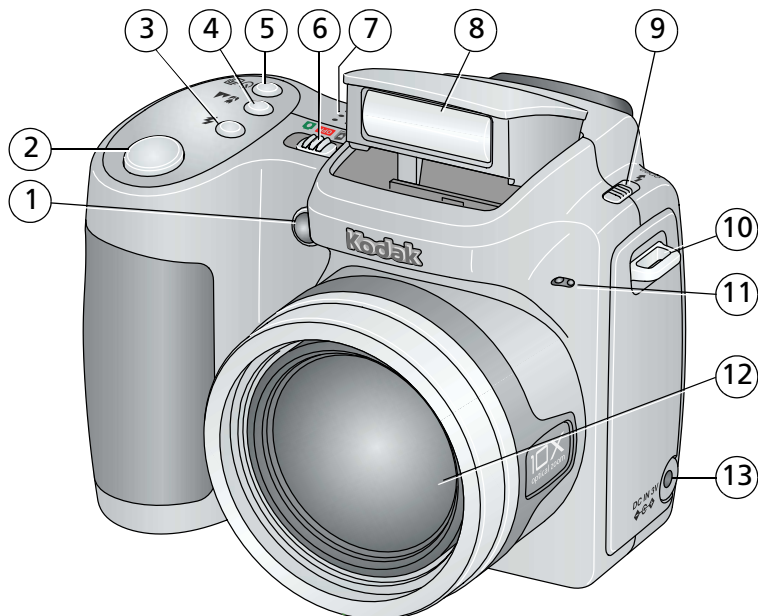

- | | | | |
|---|------------------------------------|----|------------------------------------|
| 1 | Low-light assist, Self-timer light | 8 | Flash |
| 2 | Shutter button | 9 | Open Flash switch |
| 3 | Flash button | 10 | Neck strap post |
| 4 | Focus (Close-up/Landscape) button | 11 | Microphone |
| 5 | Drive (Self-timer/Burst) button | 12 | Lens |
| 6 | Power/Favorites switch | 13 | DC-In (3V) for optional AC adapter |
| 7 | Speaker | | |

Back view

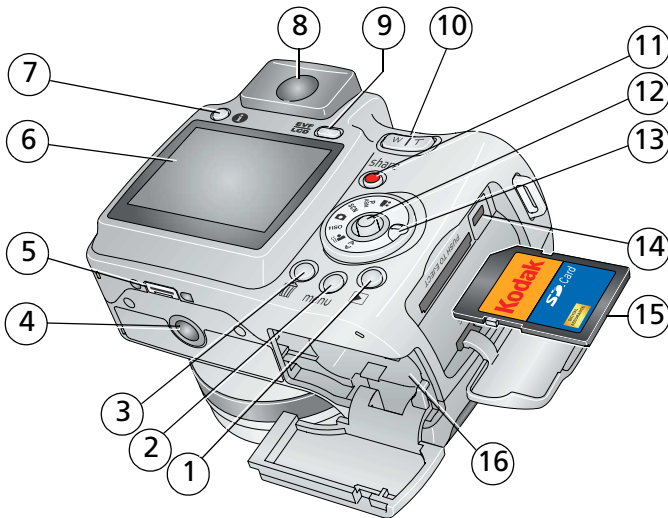

- | | |
|-------------------------------|--------------------------------|
| 1 Review button | 9 EVF/LCD button |
| 2 Menu button | 10 Zoom (Wide Angle/Telephoto) |
| 3 Delete button | 11 Share button |
| 4 Tripod socket | 12 Joystick/OK button |
| 5 Dock connector | 13 Mode dial |
| 6 LCD | 14 USB, A/V Out |
| 7 Help/Info button | 15 Optional SD card |
| 8 EVF (Electronic viewfinder) | 16 Battery compartment |

Table of contents

1	Setting up your camera	1
	Attaching the lens cap and strap	1
	Loading the battery	2
	Turning on the camera	3
	Setting the language and date/time	3
	Storing pictures on an SD card	4
2	Taking pictures/videos	5
	Taking a picture	5
	Using optical zoom	8
	Using the Flash button	9
	Using the Focus button	10
	Using the Drive button	11
	Using the Help/Info button	13
3	Working with pictures/videos	15
	Reviewing pictures and videos	15
	Deleting pictures and videos	16
	Using the Menu button in Review	17
	Cropping pictures	18
	Using Kodak Perfect Touch technology	18
	Adding sound tags	19
	Editing videos	20
	Running a slide show	22
	Viewing pictures/videos in different ways	24
	Selecting multiple pictures/videos	25
	Copying pictures and videos	26
	What the review icons mean	27

4	Doing more with your camera	28
	Capture modes	28
	Using the Menu button	30
	Using the Setup menu	33
	Taking panoramic pictures	36
	P, A, S, and M modes	37
	Sharing your pictures	39
	Using the histogram to view picture exposure	45
5	Transferring and printing pictures	46
	Installing the software	46
	Transferring pictures	47
	Printing pictures	48
	Accessories for your camera	50
6	Troubleshooting	51
	Camera problems	51
	Computer/connectivity problems	53
	Picture quality problems	54
	Direct printing (PictBridge) problems	55
7	Getting help	56
	Helpful links	56
8	Appendix	58
	Camera specifications	58
	Care and maintenance	60
	Storage capacities	61
	Important safety instructions	61
	Limited warranty	63
	Upgrading your software and firmware	64
	Regulatory compliance	65

1

Setting up your camera

Attaching the lens cap and strap

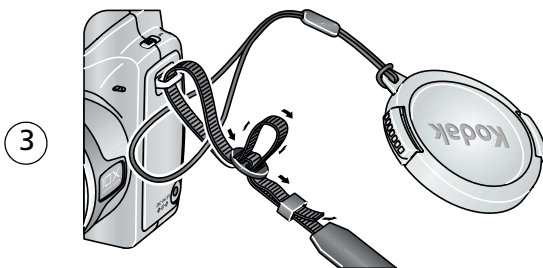
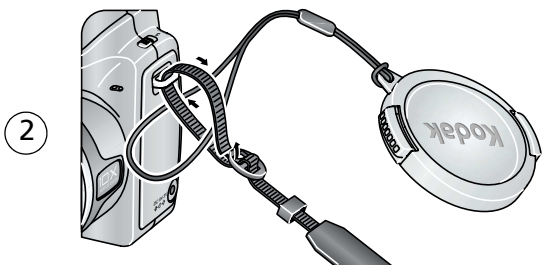
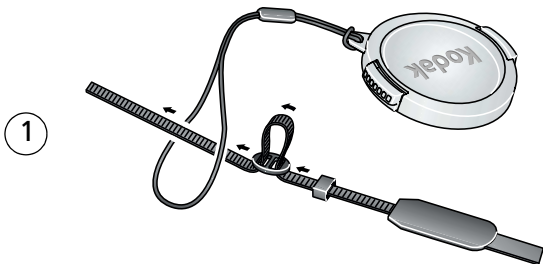

Loading the battery



2

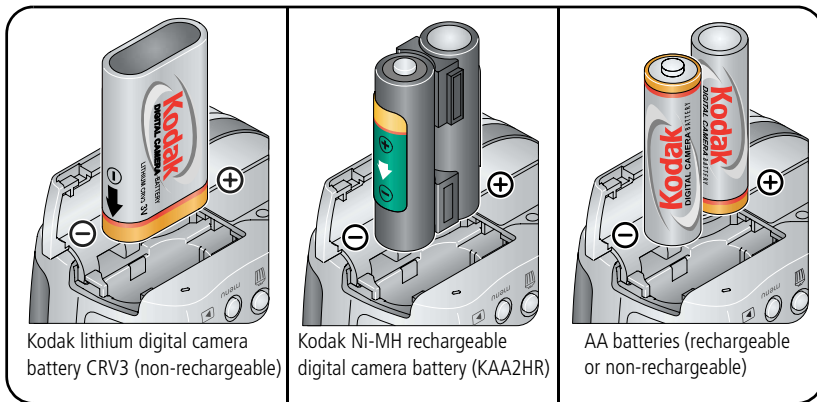

To replace batteries and extend battery life, see [page 62](#).

Turning on the camera

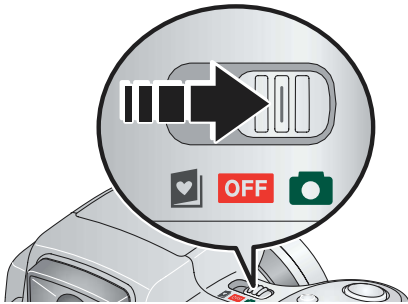

Setting the language and date/time

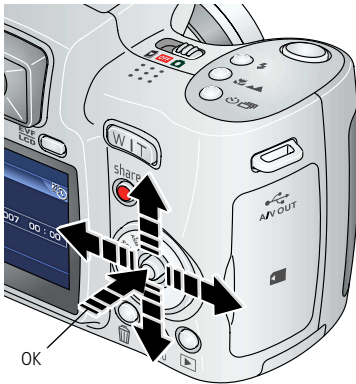

- Language:**
- 1 ▲/▼ to change.
 - 2 OK to accept.

- Date/Time:**
- 1 At the prompt, press OK.
 - 2 ▲/▼ to change.
◀/▶ for previous/next field.
OK to accept.

NOTE: To change the date/time and language in the future, use the Setup menu ([see page 33](#)).

Storing pictures on an SD card

Your camera has internal memory. You can purchase SD cards to store more pictures and videos. We recommend Kodak SD cards. (Visit www.kodak.com/go/zd710accessories.)



CAUTION:

A card can only be inserted one way; forcing it may cause damage. Inserting or removing a card while it is being accessed by the camera may damage pictures, card, or camera.

- 1 Turn off the camera.
- 2 Insert or remove the optional card.
- 3 Turn on the camera.

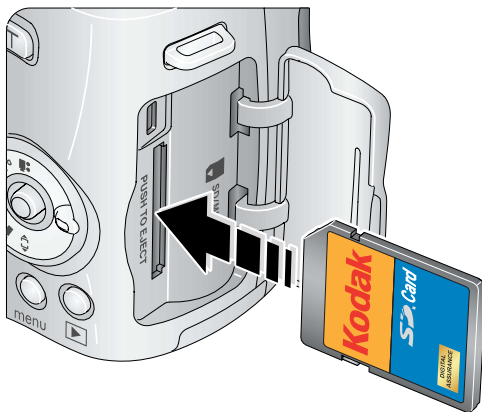

To choose a storage location for pictures/videos, [see page 33](#). For storage capacities, [see page 61](#).

2 Taking pictures/videos

Taking a picture

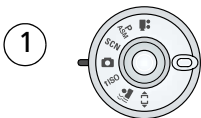

- 2 Press the EVF/LCD button to turn on:
- LCD or
 - EVF (electronic viewfinder)

- 3 Press the Shutter button halfway to focus and set exposure.

When the AF/AE indicator turns green, press the Shutter button completely down.

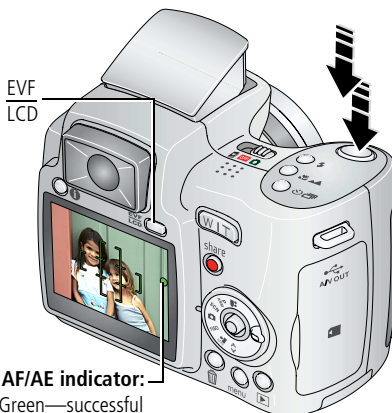

AF/AE indicator:

- Green—successful
- Red—failed
- Failed focus
- Failed exposure

NOTE: After you take a picture, the EVF/LCD displays a quickview for several seconds. The picture is saved unless you press the Delete button.

Using the auto-focus framing marks (for pictures)

When using the LCD or EVF as a viewfinder, framing marks indicate the camera focus area. The camera attempts to focus on foreground subjects, even if the subjects are not centered in the scene.

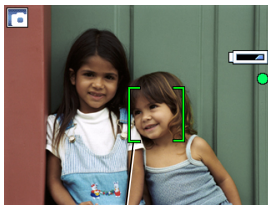

Framing marks

- 1 Press the Shutter button **halfway**.
When the framing marks turn green, focus is accomplished.
- 2 If the camera is not focusing on the desired subject (or if the framing marks disappear), release the Shutter button and recompose the scene.
- 3 Press the Shutter button **completely down** to take the picture.

NOTE: Framing marks do not appear in all modes. When you use Focus Zone and set Center Zone, the framing marks are fixed at Center Wide.

Taking a video

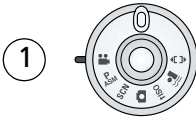

- 2 Press the EVF/LCD button to turn on:
- LCD or
 - EVF (electronic viewfinder)

- 3 Press the Shutter button completely down and release.
To stop recording, press and release the Shutter button again.



NOTE: After you take a video, the EVF/LCD displays a quickview for several seconds.
To play/pause the video during the quickview, press OK. The video is saved unless you press the Delete button.

Using optical zoom

Use optical zoom to get up to 10X closer to your subject. (You can use optical zoom before taking a video, but not while recording.)



Zoom indicator

Optical zoom range
Digital zoom range

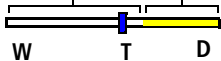

- 1 Use the EVF or LCD to frame your subject.
- 2 Press Telephoto (T) to zoom in. Press Wide Angle (W) to zoom out.

The zoom indicator shows zoom status.

- 3 Take the picture or video.

NOTE: To get a focused picture every time, remember:

- Always use the auto focus framing marks, [page 6](#).
- If you are using no zoom (1X, wide angle), you can be as close as 24 in. (60 cm) to your subject. (For Close-up/Macro mode, see [page 10](#)).
- As you zoom in, you need to move further from your subject.

Using digital zoom

Use digital zoom in any Still mode to get up to 5X magnification beyond optical zoom. To turn on/off digital zoom, or change how it is accessed, [see page 34](#).

- 1 Press the Telephoto (T) button past the optical zoom limit (10X).

The zoom indicator shows zoom status.

- 2 Take the picture or video.

NOTE: You cannot use digital zoom for video recording. You may notice decreased image quality when using digital zoom. The blue slider on the zoom indicator pauses and turns red when the picture quality reaches the limit for an acceptable 4 x 6-in. (10 x 15 cm) print.

Using the Flash button

Use the flash when you take pictures at night, indoors, or outdoors in heavy shadows.



- 1 Turn on the camera to open the flash.
- 2 Press the flash button repeatedly to scroll through flash modes. The current flash mode appears on the LCD/EVF.

NOTE:

To open the flash anytime, use the Open Flash switch.



Mode	Icon	The flash fires
Auto Flash		When the lighting conditions require it.
Off		Never
Fill		Every time you take a picture, regardless of the lighting conditions. Use when the subject is in shadow or is "backlit" (when light is behind the subject). In low light, hold the camera steady or use a tripod.
Red Eye		The flash fires once so the eyes become accustomed to the flash, then fires again when the picture is taken.

Zoom position	Flash distance
Wide angle	2–17.4 ft (0.6–5.3 m)
Telephoto	6.6–18.7 ft (2–5.7 m)



Using the Focus button

Press the Focus button  to have more control over camera focusing.







- 1 Turn the Mode dial to P, A, S, or M mode (see page 37).
- 2 Press the Focus button repeatedly until  or  appears in the status bar.
- 3 Take a picture.

NOTE: After you take the picture, the camera stays in the Close-up/Macro or Landscape setting. To exit, either press the  button until the icon turns off or turn off the camera.

Mode	Icon	Purpose	Details
Close-up/ Macro		To gain sharpness and detail in pictures at close range	Use available light instead of flash if possible. Camera automatically sets the focus distance depending on the zoom position: Wide angle: 4.7–27.6 in. (12–70 cm) Telephoto: 3.9–6.9 ft (1.2–2.1 m)
Landscape		To gain sharpness of distant scenes	Camera uses infinity auto-focus. Auto-focus framing marks are not available in Landscape.
Normal	(none)	Auto focus	The camera focuses when the Shutter button is pressed halfway down.

Using the Drive button

Mode	Icon(s)	Purpose
Self-timer	  2X 	See Using the self-timer
Burst	 	See page 12
Normal	(none)	Normal picture taking

Using the self-timer



- 1 Place camera on a tripod or flat surface.
- 2 In any Still mode, press the Drive button.
 - Once for a 10-sec. delay (so you have time to get into the scene)
 - Again for a 2-sec. delay (for a steady, shutter release on a tripod)
 - Again for 2 pictures (after a 10- and 18-second delay)
- 3 Compose the scene.
- 4 Press the Shutter button halfway, then completely down.



The picture is taken after the delay.

To cancel the Self-timer before the picture is taken, press the Drive button. (The Self-timer setting remains active.)



Use the same procedure to take a video, but:

- Turn the Mode dial to Video .
- Press the Shutter button completely down.

NOTE: The video stops when no storage space remains. Only the 2- and 10-second options are available in video mode.

Using burst

Press the Drive button to choose a burst mode.

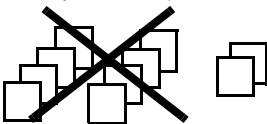
Mode	Icon	Description	Purpose
First Burst		Camera takes up to 2 pictures while the Shutter button is pressed. 	Capture an expected event. Example: A person swinging a golf club.
Last Burst		Camera takes up to 30 pictures while the Shutter button is pressed. When the Shutter button is released, only the last 2 pictures are saved. 	Capture an event when the precise timing is uncertain. Example: A child blowing out birthday candles.

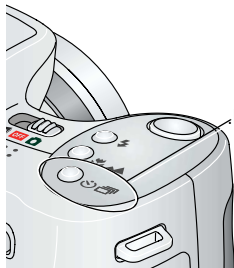



Drive

- 1 In most Still modes, press the Drive button repeatedly to choose an option.
- 2 Press the Shutter button **halfway** to focus and set exposure.
- 3 Press the Shutter button **completely down and hold it** to take pictures.

The camera stops taking pictures when you release the Shutter button, when the pictures are taken, or when there is no more storage space.

NOTE: During quickview, you can delete all pictures in the burst series. To delete selectively, do so in Review (see [page 16](#)). Burst is not available when shutter speeds are longer than 0.5 seconds.

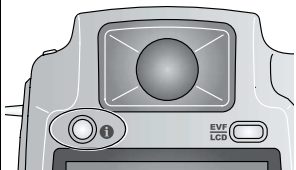
Using the Help/Info button

Repeatedly press info 	In	To turn on/off
	picture-taking mode	status icons, histogram
	review mode	status icons, histogram, and picture/video information
	any menu	Help (Press  /  to scroll.)

What the capture icons mean

Capture modes—no buttons pressed

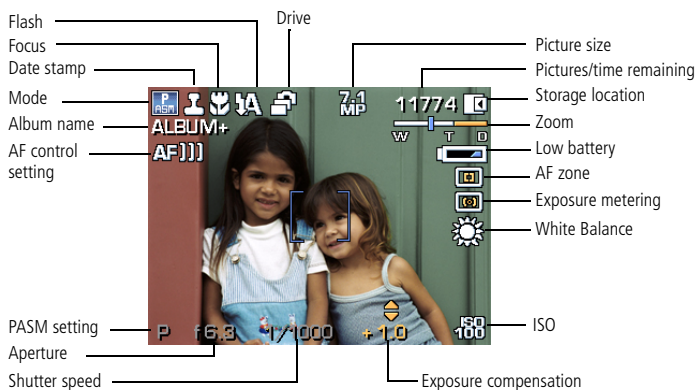

Capture modes—shutter pressed halfway

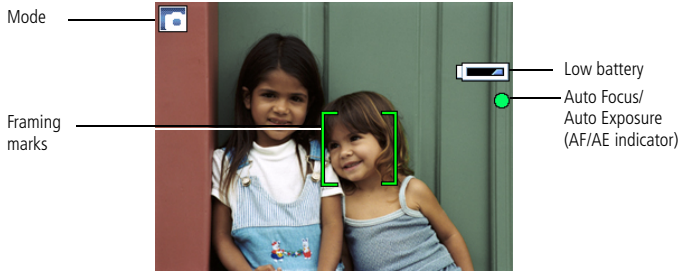

3

Working with pictures/videos

Reviewing pictures and videos

Press the Review button to view and work with your pictures and videos.

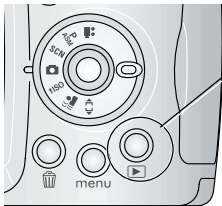

1 Press Review.
(Press again to exit.)

2 ◀/▶ View previous/next.

Videos:

OK Play/Pause

▶ 2X, 4X forward

◀ 2X, 4X reverse

▲/▼ Adjust the volume

◀/▶ Press and hold for 4 seconds to jump to a bookmark

NOTE: If you have pictures/videos on a card and in internal memory, you can scroll ◀/▶ from one storage location to the other. A video's duration is displayed at the top of the LCD.

Magnifying a picture



1 W/T Magnify 1X - 8X.

2 ◀/▶ ▲/▼ View other parts of the picture.

3 W Return to 1X.

Deleting pictures and videos

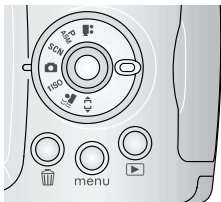

- 1 Press Review.
- 2 ◀/▶ View previous/next.
- 3 Press Delete.
- 4 Follow the screen prompts.

Using the undo delete feature

If you accidentally delete a picture/video, you may be able to use Undo Delete to retrieve it. This feature is only available immediately after you delete a single picture/video.

Protecting pictures and videos from deletion

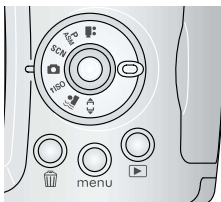

- 1 Press Review.
- 2 ◀/▶ View previous/next.
- 3 Press Menu.
- 4 ▲/▼ Highlight Protect, then press OK.

The picture/video cannot be deleted. The Protect icon  appears with the protected picture/video.







Press the Menu button to exit the menu.





CAUTION:

Formatting a card deletes all (including protected) pictures/videos. Formatting internal memory deletes all pictures/videos, email addresses, album names, and favorites.

Using the Menu button in Review

- 1 Press the Review button, then the Menu button.
- 2 Press   to choose a tab:
 -  **Review** to view pictures/videos (see page 24)
 -  **Edit** to edit pictures/videos (see page 18)
 -  **Setup** for other camera settings (see page 33)
- 3 Press   to highlight a setting, then press the OK button.
- 4 Highlight an option, then press the OK button.

Review  Options	
View By	See page 24
Album	See page 25
Protect/Unprotect	See page 16
Slide Show	See page 22
Copy To	See page 26
Multi-up	See page 24
Select/Deselect All	See page 25

Edit  Options		
Pictures	Perfect Touch tech.	See page 18
	Crop	See page 18
	Sound Tags	See page 19
Videos	Make Picture	See page 20
	Trim	See page 20
	Action Print	See page 21
	Bookmark	See page 22

Cropping pictures

You can crop a picture so that only the desired portion of the picture remains.

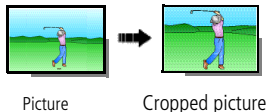

- 1 Press the Review button, then **◀/▶** to find a picture to crop.
 - 2 Press the Menu button, then **◀/▶** to highlight the Edit tab. Highlight Crop, then press the OK button.
 - 3 Press Telephoto (T) to zoom in, or **◀/▶** **▲/▼** to move the crop box. Press the OK button.
 - 4 Follow the screen prompts.
The picture is cropped. (The original is saved.) Cropped pictures cannot be cropped again on the camera.
- Press the Menu button to exit the menu.

Using Kodak Perfect Touch technology

Kodak Perfect Touch technology helps ensure better, brighter pictures.

- 1 Press the Review button.
 - 2 Press **◀/▶** for previous/next picture.
 - 3 Press the Menu button, then **◀/▶** to highlight the Edit tab. Highlight Perfect Touch tech, then press the OK button.
*The enhancement is previewed in a split screen. Press **◀/▶** to view other parts of the picture.*
 - 4 Press the OK button. Follow the screen prompts to replace the original picture or to save the enhanced picture as a new one.
Enhanced pictures cannot be enhanced again on the camera. Kodak Perfect Touch technology can only be used with pictures, not video.
- Press the Menu button to exit the menu.

Adding sound tags

You can record a voice or sound (up to 1 minute long) to a picture.

NOTE: Only one sound tag can be added to each picture (not to videos).

Recording a sound tag

- 1 Press the Review button, then ◀/▶ to find a picture.
- 2 Press the Menu button, then ◀/▶ to highlight the Edit tab. Highlight Sound Tag, then press the OK button.
- 3 Highlight Record, then press OK.
- 4 Follow the screen prompts.

The sound tag is applied to your picture.

- Press the Menu button to exit the menu.

Playing a sound tag

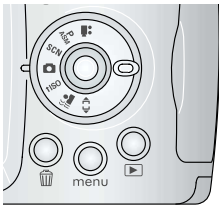

- 1 Press the Review button, then ◀/▶ to find a tagged picture.
- 2 Press ▼ to play the sound tag.
- 3 Press ▲/▼ to adjust the volume.
- 4 Press OK to stop. Press OK again to replay.

Editing videos

You can do incredible things with your videos!

Making a picture from a video

You can choose a single frame from a video, then make a picture suitable for a 4 x 6-inch (10 x 15 cm) print.

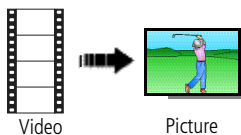

- 1 Press the Review button, then ◀/▶ to find a video.
- 2 Press the Menu button, then ◀/▶ to highlight the Edit tab. Highlight Make Picture, then press the OK button.
- 3 Follow the screen prompts.
A picture is created. (The original video is saved.)
 - Press the Menu button to exit the menu.

Trimming a video

You can trim an unwanted start or end from a video, saving only the desired portion.

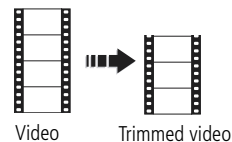

- 1 Press the Review button, then ◀/▶ to find a video.
- 2 Press the Menu button, then ◀/▶ to highlight the Edit tab. Highlight Trim, then press the OK button.
- 3 Follow the screen prompts.
The video is trimmed. (You can save it as a new video or replace the original.)
 - Press the Menu button to exit the menu.

Making a video action print

From a video, you can make a 4-, 9-, or 16-up picture, suitable for a 4 x 6-inch (10 x 15 cm) print.

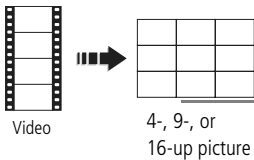

- 1 Press the Review button, then ◀/▶ to find a video.
- 2 Press the Menu button, then ◀/▶ to highlight the Edit tab. Highlight Action Print, then press the OK button.
- 3 Highlight an option, then press the OK button:

Auto—The camera includes the first and last frames, then 2, 7, or 14 equally spaced frames.

Manual—You choose the first and last frames; the camera chooses 2, 7, or 14 equally spaced frames.

Full Manual—You choose 4, 9, or 16 frames.

Use Bookmarks—The camera uses bookmarked frames.

A 4-, 9-, or 16-up picture is created. If you have less than 4 or 9 bookmarks, equally spaced video frames are used.

- Press the Menu button to exit the menu.

Using video bookmarks

You can set bookmarks at interesting places in your video, then jump from one bookmark to another.

Setting bookmarks

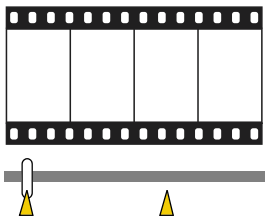

- 1 Press the Review button, then ◀/▶ to find a video.
- 2 Press the Menu button, then ◀/▶ to highlight the Edit tab. Highlight Bookmark, then press the OK button.
- 3 Press ▼ to add bookmarks. When finished adding up to 9 bookmarks, press ▲.
 - Press the Menu button to exit the menu.

Using bookmarks

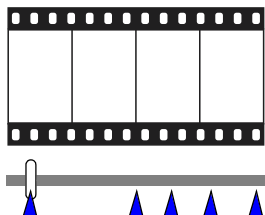

- 1 Press the Review button, then ◀/▶ to find a video.
- 2 Press ▼ to play the video. To jump to the first bookmark, press and hold ◀/▶ for 4 seconds while the video is playing.
 - After you jump to a bookmark, press ◀/▶ to jump to other bookmarks.
 - To view all bookmarked video frames, press the Zoom wide angle (W) button. To return to normal view, press the telephoto (T) button.

Running a slide show

Use the Slide Show to display pictures and videos on the camera. To run a slide show on a television or on any external device, see [page 24](#).

Starting the slide show

- 1 Press the Review button, then press the Menu button.
 - 2 Press ▲/▼ to highlight Slide Show, then press OK.
 - 3 Press ▲/▼ to highlight Begin Show, then press OK.
- To interrupt the Slide Show, press OK.

Changing the slide show display interval

The default interval setting displays each picture for 5 seconds. You can set the display interval from 3 to 60 seconds.

- 1 On the Slide Show menu, press ▲/▼ to highlight Interval, then press OK.
- 2 Select a display interval.
- 3 To scroll through the seconds quickly, press and hold ▲/▼.
- 4 Press OK.

The interval setting remains until you change it.

Running a continuous slide show loop

When you turn on Loop, the slide show is continuously repeated.

- 1 On the Slide Show menu, press ▲/▼ to highlight Loop, then press OK.
- 2 Press ▲/▼ to highlight On, then press OK.
- 3 Press ▲/▼ to highlight Begin Show, then press OK.

The slide show repeats until you press OK or until battery power is exhausted. The Loop feature remains until you change it.

Displaying pictures and videos on a television

You can display pictures/videos on a television, computer monitor, or any device equipped with a video input. To connect the camera to a television, use an optional A/V cable (visit www.kodak.com/go/zd710accessories).

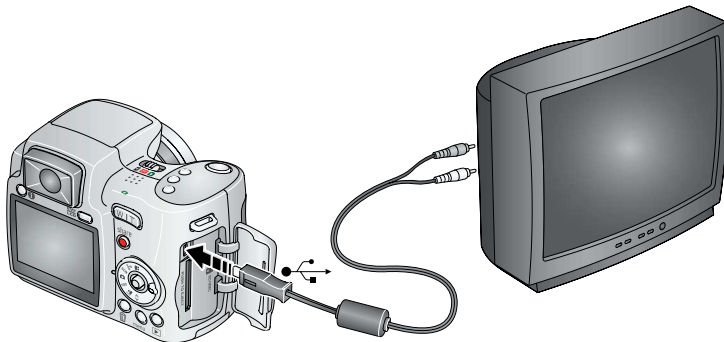

NOTE: Ensure that the Video Out setting (NTSC or PAL) is correct (see page 35). The slide show stops if you connect or disconnect the cable while the slide show is running. (Image quality on a television screen may not be as good as on a computer monitor or when printed.)

Viewing pictures/videos in different ways

Viewing as thumbnails (multi-up)

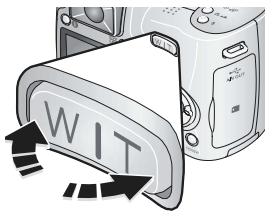

- 1 Press the Review button.
- 2 Press the Zoom Wide Angle (W) button to change from single-picture view to multi-up thumbnails.
- 3 Press Telephoto (T) to return to single-picture view.
 - To select multiple pictures/videos, see [page 25](#).
 - Press the Review button to exit Review.

Viewing by date, album, or image storage

- 1 Press the Review button, then press the Menu button.
- 2 Press **◀/▶** to highlight the Review tab. Highlight View By, then press the OK button.
- 3 Press **▲/▼** to highlight All (default), Date, Album, or Image Storage, then press OK.
 - Press **▲/▼ ◀/▶** to highlight a date, album, or image storage, then press the T button. To return to the list, press the W button.
 - Press the Review button to exit Review.
 - For more about albums, see [page 42](#).

Selecting multiple pictures/videos

Use the multi-select feature when you have two or more pictures/videos to print, email, copy, or delete. (Multi-select is used most effectively in Multi-Up mode, [page 24](#).)

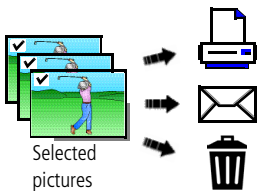

- 1 Press the Review button, then **◀/▶** to find a picture/video.
- 2 Press OK to select pictures/videos.

A check mark appears on the picture. You can now print, email, copy, or delete the selected pictures. You can press OK a second time to remove a check mark.

Copying pictures and videos

You can copy pictures and videos from a card to internal memory or from internal memory to a card.

Before you copy, make sure that a card is inserted in the camera.

Copy pictures or videos:

- 1 Press the Review button.
- 2 Press the Menu button, then ◀/▶ to highlight the Review tab. Highlight Copy To, then press the OK button.
- 3 Press ▲/▼ to highlight Memory Card or Internal Memory, then press OK.
- 4 Press ▲/▼ to highlight an option: Picture/Video, All Date, Selected, All Album, All Memory Card, All Internal Memory. (Options vary, depending on View By settings.)
- 5 Press OK.

NOTE: Pictures and videos are copied, not moved. To remove pictures from the original location after copying, delete them (see [page 16](#)). Tags that you applied for print, email, and favorites are not copied. Protection settings are not copied. To apply protection to a picture or video, see [page 16](#).

What the review icons mean

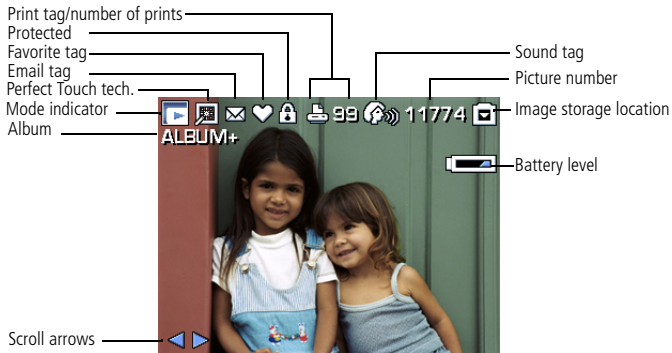



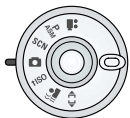

4

Doing more with your camera

Capture modes



Choose the mode that best suits your subjects and surroundings.

Capture mode	For
 Smart Scene	General picture taking—offers an excellent balance of image quality and ease of use. When the Shutter button is pressed halfway, faces are detected, the scene is analyzed, and the best settings are applied.
P, A, S, M	More creative control. (See page 37 .) Program, Aperture priority, Shutter priority, and Manual mode.
 Video	Video with sound. (See page 7 .)
SCN Scene	Point-and-shoot simplicity when taking pictures under special conditions. (See SCN (Scene) modes, page 29 .)
 High-ISO	People in low-light scenes.
 Digital Image Stabilization	Minimizing the effects of camera shake and subject movement.
 Panorama	“Stitching” 2 or 3 pictures into 1 panoramic scene. (See page 36 .)

SCN (Scene) modes

1 Turn the Mode dial to **SCN**.

2 Press **▲/▼ ◀/▶** to highlight a SCN mode and view its description.

NOTE: If the SCN mode description turns off, press OK.

3 Press OK (or keep the SCN mode highlighted) to choose the SCN mode.

To return to Smart Scene mode, turn the mode dial to Smart Scene .









SCN mode	For
Portrait	Full-frame portraits of people. Subject is sharp and the background is indistinct. Position your subject at least 6 ft (2 m) away and fill the frame with a head and shoulder pose. Use Telephoto to exaggerate background blur.
Sport	Subjects that are in motion. Shutter speed is fast. The camera pre-settings are Multi-Pattern Exposure Metering, and Multi-Zone Focus.
Landscape	Distant scenery. Flash does not fire. Auto-focus framing marks (see page 6) are not available in Landscape.
Night Portrait	Reducing red eye of people in night scenes or low-light conditions. NOTE: To avoid blur, place the camera on a tripod.
Night Landscape	Distant scenery at night. Flash does not fire. NOTE: To avoid blur, place the camera on a tripod.
Snow	Bright snow scenes.
Beach	Bright beach scenes.
Text	Documents NOTE: To avoid blur, place the camera on a tripod.
Fireworks	Fireworks. NOTE: To avoid blur, place the camera on a tripod.
Flower	Close-ups of flowers or other small subjects in bright light.
Manner/Museum	Quiet occasions, like a wedding or lecture. Flash and sound are disabled. Place the camera on a tripod.

SCN mode	For
Self-portrait	Close-ups of yourself. Assures proper focus and minimizes red eye.
Children	Action pictures of children in bright light.
Backlight	Subjects that are in shadow or "backlit" (when light is behind the subject).
Candle Light	Subjects illuminated by candle light.
Sunset	Subjects at dusk.

Using the Menu button

You can change settings to get the best results from your camera.

NOTE: Some settings remain until you change them; others, until you change modes or turn off the camera. Some modes offer limited settings.

- 1 Press the Menu button.
- 2 Press   to choose a tab:
 -  **Capture** for picture-taking settings
 -  **Capture Plus** for other picture-taking settings ([see page 32](#))
 -  **Video** for video-taking settings ([see page 33](#))
 -  **Setup** for other camera settings ([see page 33](#))
- 3 Press   to highlight a setting, then press OK.
- 4 Choose an option, then press OK.

Using the capture tab

Press Menu, ▲/▼, and OK to access settings	 Options
<p>Picture Size Choose a picture resolution. For recommended print sizes, visit www.kodak.com/go/printsizes</p>	<p>7.1 MP (4:3) (default)—highest resolution, largest file size 6.3 MP (3:2)—for printing on EasyShare printer docks and photo printers 5.3 MP (16:9)—HDTV format; mid-range resolution and file size 5.0 MP (4:3)—mid-range resolution and file size 3.1 MP (4:3)—mid-range resolution and file size 2.2 MP (3:2)—printing on EasyShare printer docks and photo printers; lower resolution, smaller file size 2.1 MP (16:9)—HDTV format; lower resolution, smaller file size 1.2 MP (4:3)—email, Internet, or to conserve space</p>
<p>Color Mode Choose picture color tones.</p>	<p>High Color Natural Color (default) Low Color Black & White Sepia EasyShare software also lets you change a color picture to black-and-white or sepia.</p>
<p>AF Control (Still) Choose an auto-focus setting.</p>	<p>Continuous AF (default)—because the camera is always focusing, there is no need to press the Shutter button halfway down to focus. Single AF—uses TTL-AF when the Shutter button is pressed halfway down.</p>
<p>Date Stamp Imprint the date on pictures.</p>	<p>On Off (default)</p>

Using the capture plus tab

Press Menu, ▲/▼, and OK to access settings	 Options
White Balance Choose your lighting condition. Available only in PASM mode.	Auto (default) —automatically corrects white balance. Ideal for general picture taking. Daylight —for pictures in natural lighting. Tungsten —corrects the orange cast of household light bulbs. Ideal for indoor pictures under tungsten or halogen lighting without flash. Fluorescent —corrects the green cast of fluorescent lighting. Ideal for indoor pictures under fluorescent lighting without flash. Open Shade —for pictures in the shade in natural lighting.
Exposure Metering Evaluate light levels at specific areas of a scene. Available only in PASM mode.	Multi-pattern (default) —evaluates lighting conditions throughout the image to give an optimum picture exposure. Ideal for general picture taking. Center-weight —evaluates the lighting conditions of the subject centered in the viewfinder. Ideal for backlit subjects. Spot —similar to Center-weight, except the metering is concentrated on a smaller area of the subject centered in the viewfinder. Ideal when you need exact exposure of a specific area in the picture.
AF (Auto Focus) Zone Select a large or concentrated area of focus. Available only in PASM mode.	Multi-zone (default) —evaluates 5 zones to give an even picture focus. Ideal for general picture taking. Center-zone —evaluates the small area centered in the viewfinder. Ideal when precise focus of a specific area in the picture is needed.
Sharpness Control picture sharpness. Available only in PASM mode.	High Normal (default) Low

Using the video tab

Press Menu, ▲/▼, and OK to access settings	 Options
Video Size Choose a video resolution. Available only in Video mode.	640 x 480 (VGA) —best quality; largest file size 320 x 240 (QVGA) —lower quality; smaller file size
AF Control (Video) Choose an auto-focus setting.	Continuous AF (default) —the camera continuously focuses. Use if you or your subject are moving. Single AF —the camera focuses once at the start of a video. Use if you and your subject are not moving.



Using the Setup menu

Use Setup to customize your camera settings.

- 1 In any mode, press the Menu button.
- 2 Press ► to highlight Setup , then press OK.
- 3 Press ▲/▼ to highlight a setting, then press OK.
- 4 Choose an option, then press OK.
- 5 Press the Menu button to exit.



Press Menu, ► to highlight Setup, ▲/▼ to access settings, then OK.	 Options
Image Storage Choose a storage location for pictures and videos.	Auto (default) —the camera uses the card if one is in the camera. If not, the camera uses internal memory. Internal Memory —the camera always uses internal memory, even if a card is installed.

<p>Press Menu, ► to highlight Setup, ▲/▼ to access settings, then OK.</p>	 Options
<p>Set Album Choose Album names. <i>You can apply different Set Album choices to videos and to pictures.</i></p>	<p>On Off (default) Pre-select album names before you take pictures or videos. Then, all the pictures or videos you take are tagged with those album names. (See page 44.)</p>
<p>Capture Frame Grid Turn framing grid on or off.</p>	<p>On Off (default)</p>
<p>Quickview Change Quickview default.</p>	<p>On (default) Off</p>
<p>Advanced Digital Zoom Choose how digital zoom is employed.</p>	<p>Continuous—no pause between optical and digital zoom. Pause—after reaching the optical zoom limit, the zoom button must be released, then activated again to begin digital zoom. None (default)—digital zoom is disabled.</p>
<p>Orientation Sensor Orient pictures so that they are displayed with the correct side up.</p>	<p>On (default) Off</p>
<p>Camera Sounds Choose a theme, or choose sounds for individual camera functions.</p>	<p>Default Sci-fi Fun Music None</p>
<p>Sound Volume</p>	<p>Off High Medium (default) Low</p>
<p>Date & Time</p>	<p>See page 3.</p>

<p>Press Menu, ▶ to highlight Setup, ▲/▼ to access settings, then OK.</p>	 Options
<p>Auto Power Off Choose amount of inactivity time until camera turns off.</p>	<p>10 minutes 5 minutes 3 minutes (default) 1 minute</p>
<p>Video Out Choose the regional setting that lets you connect the camera to a television or other external device.</p>	<p>NTSC (default)—used in North America and Japan; most common format. PAL—used in Europe and China.</p>
<p>Language</p>	<p>Choose from available languages.</p>
<p>Reset Camera Resets all settings to factory defaults.</p>	
<p>Format</p> <p> CAUTION: Formatting a card deletes all (including protected) pictures/videos. Formatting internal memory deletes all pictures/videos, email addresses, album names, and favorites.</p>	<p>Memory Card—deletes everything on the card; formats the card. Cancel—exits without making a change. Internal Memory—deletes everything in internal memory including email addresses, album names, and favorites; formats the internal memory.</p>
<p>About View camera information, including firmware version.</p>	

Taking panoramic pictures

Use panorama to “stitch” up to 3 pictures into a panoramic scene.

- 1 Turn the Mode dial to Panorama .
- 2 Press  to highlight Panorama Left-Right or Panorama Right-Left (depending on the direction you want to pan), then press OK.
- 3 Take the first picture.
After a quickview, the LCD displays the liveview and an “overlay” from the first picture.
- 4 Compose the second picture. Make the overlay from the first picture cover the same portion in the new picture. (You can press the Delete button to re-take a picture.)
- 5 If you are taking only 2 pictures, press the OK button to stitch them together.
After you take 3 pictures, the pictures are automatically stitched together.

Take 2 or 3 pictures.



Get 1 panoramic picture.



NOTE: For best results, use a tripod. Only the panoramic picture is saved; individual pictures are not. Picture size is set to 3.1 MP. To use a self-timer delay, see [page 11](#). Exposure, white balance, and focus are set with the first picture. The flash is set to Off.

P, A, S, and M modes

Use these modes when you want more control over your camera and pictures.

Use this mode	For
P Program	Controlling exposure compensation (how much light enters the camera) and ISO speed. The camera automatically sets the shutter speed and aperture (f-stop) based on the scene lighting. Program mode offers the ease of auto shooting with full access to all menu options. Press ◀/▶ ▲/▼ to select settings.
A Aperture Priority	Controlling aperture, exposure compensation, and ISO speed. Aperture priority mode is primarily used to control depth of field (the range of sharpness). NOTE: The aperture setting may be affected when using optical zoom. Press ◀/▶ ▲/▼ to select settings.
S Shutter Priority	Controlling the shutter speed, exposure compensation, and ISO speed. The camera automatically sets the aperture for proper exposure. Shutter priority mode is primarily used to prevent blur when your subject is moving. To prevent camera shake, use a tripod for slow shutter speeds. Press ◀/▶ ▲/▼ to select settings.
M Manual	The highest level of creative control. You set the aperture, shutter speed, and ISO speed. Exposure compensation acts as an exposure meter, recommending the proper combination of aperture and shutter speed to produce an acceptable exposure. To prevent camera shake, use a tripod for slow shutter speeds. Press ◀/▶ ▲/▼ to select settings.

NOTE: Settings you change in P, A, S, or M modes apply only to pictures taken in those modes. For example, if you change the Color Mode to Sepia while in P, A, S, or M mode, you retain the default setting of Color for Smart Scene and Scene modes.

The settings, including Flash, are maintained for P, A, S, and M modes—even when you change modes or turn off the camera. Use Reset Camera (see page 35) to reset P, A, S, or M mode to its default setting.

Changing P, A, S, or M mode settings

PASM modes control the aperture (f-number, also known as f-stop), shutter speed, exposure compensation, and ISO. Use the Menu button to control all other settings.

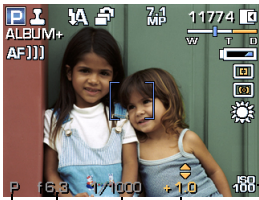

PASM Options

- White—selectable
- Grey—non-selectable
- Yellow—changeable value
- Red—out of range

- ISO
- Exposure compensation
- Shutter speed
- Aperture
- PASM mode

- 1 Turn the Mode dial to PASM.
- 2 Press $\blacktriangle/\blacktriangledown$ to choose P, A, S, or M.
- 3 Press $\blacktriangle/\blacktriangledown$ $\blacktriangle/\blacktriangleright$ to move between settings, open a setting, or change a setting.
- 4 Take a picture.

Aperture—(also known as f-stop) control the size of the lens opening, which determines the depth of field.

- Smaller f-stop numbers indicate a larger lens opening; for portraits and low-light.
- Larger f-stop numbers indicate a smaller lens opening; keeps the main subject sharp; for landscapes and well-lit conditions.

Shutter speed—control how long the shutter stays open. A shaking hand icon  warns of slow shutter speeds. (Use a tripod for slow shutter speeds.)

Exposure Compensation—adjust the exposure; for controlling backlit or non-standard scenes. If a picture is light, decrease the setting; if it's dark, increase it.

ISO speed—control sensitivity to light. If you can't use a flash, increase the ISO. 3200 available only at 1.2, 2.1, and 2.2 MP. Higher ISO can produce unwanted "noise."

Sharing your pictures

Press the Share button to tag your pictures/videos. When they are transferred to your computer, you can share them.

Tagging pictures for printing

- 1 Press the Share button. Press ◀/▶ to find a picture.
- 2 Press ▲/▼ to highlight Print, then press OK.*
- 3 Press ▲/▼ to select the number of copies (0–99). Zero removes the tag for that picture.
- 4 Optional: You can apply a print quantity to other pictures. Press ◀/▶ to find a picture. Keep the print quantity as is, or press ▲/▼ to change it. Repeat this step until the desired print quantity is applied to the pictures.
- 5 Press OK. Press the Share button to exit the menu.

The Print icon  appears in the status area. The default quantity is one.

* To tag all pictures in the storage location, highlight Print All, press OK, then indicate the number of copies. To remove print tagging for all pictures in the storage location, highlight Cancel Prints, then press OK.

Printing tagged pictures

When you transfer the tagged pictures to your computer, the EasyShare software print screen opens. For details on printing, see Help in EasyShare software.

For more information on printing from your computer, printer dock, PictBridge enabled printer, or card, see [page 48](#).

NOTE: For 4 x 6 in. (10 x 15 cm) prints, use one of the 3:2 picture sizes ([see page 31](#)).

Tagging pictures/videos for emailing

First—on your computer

Use Kodak EasyShare software to create an email address book on your computer. Then, copy up to 32 email addresses to the camera's internal memory. For details, see Help in EasyShare software.

Second—tag pictures/videos on your camera

- 1 Press the Share button. Press ◀/▶ to find a picture/video.
- 2 Press ▲/▼ to highlight Email, then press OK.
- 3 Press ▲/▼ to highlight an email address, then press OK.

To tag other pictures/videos with the same address, press ◀/▶ to scroll through them. When the picture you want is displayed, press OK.

To send the pictures/videos to more than one address, repeat step 3.

Selected addresses are checked.

- 4 To remove a selection, highlight a checked address and press OK. To remove all email selections, highlight Clear All.
- 5 Press ▲/▼ to highlight Exit, then press OK.
The Email icon appears in the status area.
- 6 Press the Share button to exit the menu.









Third—transfer and email

When you transfer the tagged pictures/videos to your computer, EasyShare software prompts you to send the pictures/videos. For details, see Help in EasyShare software.

Tagging pictures as favorites

Want to keep copies of your favorite pictures on your camera?

Start with the Share button!

1. Tag pictures as favorites	<ol style="list-style-type: none"> 1 Press the Share button. Press   to find a picture. 2 Press   to highlight Favorite, then press OK. <i>The Favorite icon  appears in the status area. To remove the tag, press OK again.</i>
2. View favorites on your camera	<ol style="list-style-type: none"> 1 Slide the Power switch to Favorites . 2 Press   to view favorites.

The next time you transfer pictures to your computer, EasyShare software helps you make choices about your favorite pictures. Favorite pictures (smaller versions of the originals) are loaded to the Favorites section of your camera's internal memory.

NOTE: Videos tagged as favorites remain in the Favorites folder in EasyShare software. For details, see Help in EasyShare software.

Preventing camera favorites from synchronizing with the software

If you don't want to use the favorites feature:

- 1 Open EasyShare software.
- 2 From the Tools menu, select Cameras/Viewers > Sync and Transfer Manager.
- 3 Click to highlight your camera, then click Camera Favorites Album Properties.

NOTE: If your camera model is not visible, use the USB cable to connect your camera to the computer.

- 4 Drag the Internal Memory slider to 0%, then click OK.
- 5 Close the Sync and Transfer Manager window.



Camera favorites will no longer synchronize with EasyShare software.

To turn on the sync feature, select Yes, synchronize with my software.

To delete favorites from your camera, press the Delete button while in Favorites mode.

Optional settings

In Favorites mode, press the Menu button to access optional settings.

	Slide Show (page 22)
	Multi-Up (page 24)

NOTE: Pictures taken at the 3:2 picture size are displayed at a 3:2 aspect ratio with a black bar at the top and bottom of the screen.

Printing and emailing favorites

- 1 Slide the Power switch to Favorites . Press ◀/▶ to find a picture.
- 2 Press the Share button.
- 3 Highlight Print or Email, then press OK.

NOTE: Favorites that were taken on this camera (not imported from another source) are good for prints up to 4 x 6 in. (10 x 15 cm).

Tagging pictures/videos for albums

Use the Album feature to tag the pictures/videos in your camera with album names.

First—on your computer

Use EasyShare software to create album names on your computer, then copy up to 32 album names to the camera's internal memory.

Second—on your camera

- 1 Press the Review button, then find the picture/video.
- 2 Press the Menu button.
- 3 Press $\blacktriangle/\blacktriangledown$ to highlight Album, then press OK.
- 4 Press $\blacktriangle/\blacktriangledown$ to highlight an album name, then press OK.

To add other pictures to the same album, press $\blacktriangleleft/\blacktriangleright$ to scroll through the pictures. When the picture you want is displayed, press OK.

- 5 Press $\blacktriangle/\blacktriangledown$ to highlight Exit, then press OK.

The album name appears with the picture. To add the pictures to more than one album, repeat step 4 and 5 for each album. A plus (+) after the album name means the picture was added to more than one album.

To remove a selection, highlight an album name and press OK. To remove all album selections, select Clear All, then exit the menu.

Third—transfer to your computer

When you transfer the tagged pictures/videos to your computer, EasyShare software opens and categorizes your pictures/videos in the appropriate album.

Pre-tagging for album names

Use the Set Album (Still or Video) feature to pre-select album names before you take pictures/videos. Then, all the pictures/videos you take are tagged with those album names.

First—on your computer

Use the EasyShare software to create album names on your computer. The next time you connect the camera to the computer, up to 32 album names are copied to the camera's internal memory.

Second—on your camera

- 1 In any mode, press the Menu button.
- 2 Press ► to highlight Setup , then press OK.
- 3 Press ▲/▼ to highlight Set Album, then press OK.
- 4 Press ▲/▼ to highlight an album name, then press OK.
- 5 Highlight Exit, then press OK.
- 6 Press the Menu button to exit the menu.

Your selections are saved. Your album selection is displayed on the LCD. A plus (+) after the album name means more than one album is selected.

Third—transfer to your computer

When you transfer the tagged pictures/videos to your computer, EasyShare software opens and categorizes your pictures/videos in the appropriate album. For details, see Help in EasyShare software.

Using the histogram to view picture exposure

Use the histogram to evaluate the distribution of light before or after you take a picture. If the peak is to the right of the graph, the subject is bright; if it's to the left, the subject is dark. Optimal exposure is achieved when the peak is in the middle of the histogram.

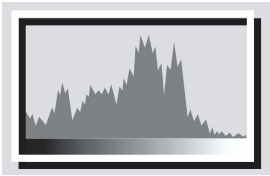

To turn on the histogram in PASM mode or in Review, press the Help/Info **i** button until the histogram appears.

NOTE: If a scene is dark or light, you can adjust the exposure compensation (see [page 38](#)) before taking the picture. The flash may affect a picture's light and shadow and will not affect the histogram until after the picture is taken.

For more about the Help/Info **i** button, see [page 13](#).

5

Transferring and printing pictures

Installing the software

- 1 Close all open software applications before starting the installation.

NOTE: If running Windows OS and installing EasyShare software from the Kodak Web site, do not close the WinZip application. If prompted, allow EasyShare software to access the Internet.

- 2 Place the Kodak EasyShare software CD into the CD-ROM drive.

- 3 Load the software:

Windows OS—if the install window does not appear, choose Run from the Start menu and type **d:\setup.exe** where **d** is the drive letter that contains the CD.

Mac OS X—double-click the CD icon on the desktop, then click the Install icon.

- 4 Follow the on-screen instructions to install the software.

NOTE: When prompted, register your camera and software. Registering lets you sign up for information that keeps your system up-to-date. To register later, visit www.kodak.com/go/register.

- 5 If prompted, restart the computer.

For information on the software applications included on the Kodak EasyShare software CD, see Help in EasyShare software.

Transferring pictures

IMPORTANT: If your camera was packaged with a Kodak EasyShare dock, use the dock to transfer pictures to your computer. (See [page 50](#) and the dock user's guide for details.) If you do not have an EasyShare dock, use the USB cable (U-8) that came with your camera.

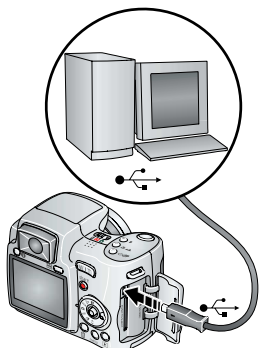

- 1 Turn off the camera.
- 2 Plug the labeled  end of the USB cable into the labeled USB port on your computer. See your computer user's guide for details.
- 3 Plug the other end of the USB cable into the USB port on the camera. The arrow icon on the cable should face you.
- 4 Turn on the camera.

EasyShare software opens on your computer. The software prompts you through the transfer process.

NOTE: Visit www.kodak.com/go/howto for an online tutorial on connecting.

Also available for transferring

You can also use these Kodak products to transfer your pictures and videos.

- Kodak EasyShare camera dock, Kodak EasyShare printer dock (see [page 50](#))
- Kodak multi-card reader, Kodak SD multimedia card reader-writer

Purchase these and other accessories at a dealer of Kodak products or www.kodak.com/go/zd710accessories.

Printing pictures

Printing with a Kodak EasyShare printer dock

Dock your camera to the Kodak EasyShare printer dock and print directly—with or without a computer. Purchase this and other accessories at a dealer of Kodak products or www.kodak.com/go/zd710accessories.

Direct printing with a PictBridge enabled printer

Your camera features PictBridge technology, so you can print directly to PictBridge enabled printers. You need:

- Camera with fully charged batteries, or with optional Kodak 3-volt AC adapter
- PictBridge enabled printer
- USB cable included with your camera

Connecting the camera to a PictBridge enabled printer

- 1 Turn off the camera and printer.
- 2 Optional: If you have a Kodak 3-volt AC adapter (optional accessory), plug it into the camera and into an electrical outlet.

IMPORTANT: *Do not use the AC adapter included with the Kodak EasyShare camera dock or printer dock to power your camera.*

- 3 Connect the USB cable from the camera to the printer. (See your printer user guide for details. See www.kodak.com/go/zd710accessories to order cables.)

Printing from a PictBridge enabled printer

- 1 Turn on the printer. Turn on the camera.

The PictBridge logo is displayed, followed by the current picture and menu. (If no pictures are found, a message is displayed.) If the menu interface turns off, press any button to redisplay it.

- 2 Press ▲/▼ to choose a printing option, then press OK.

Current Picture—Press ◀/▶ to choose a picture. Choose the number of copies.

Tagged Pictures—If your printer is capable, print pictures that you tagged for printing.

Index Print—Print thumbnails of all pictures. This requires one or more sheets of paper. If the printer is capable, choose a print size.

All Pictures—Print all pictures in internal memory, on a card, or in Favorites. Choose the number of copies.

Image Storage—Access Internal/Card or Favorites.

NOTE: During direct printing, pictures are not permanently transferred or saved to the computer or printer. To transfer pictures to your computer, see [page 46](#). In Favorites mode, the current favorite picture is displayed.

Disconnecting the camera from a PictBridge enabled printer

- 1 Turn off the camera and printer.
- 2 Disconnect the USB cable from the camera and the printer.

Ordering prints online

Kodak EasyShare Gallery is one of the many online print services offered in EasyShare software. You can easily:

- Upload your pictures.
- Edit, enhance, and add borders to your pictures.
- Store pictures, and share them with family and friends.
- Order high-quality prints, photo greeting cards, frames, and albums—and have them delivered to your door.

Printing pictures from your computer

For details on printing pictures from your computer, see EasyShare software Help.

Printing from an optional SD card

- Automatically print tagged pictures when you insert your card into a printer with an SD slot. See your printer user's guide for details.
- Make prints at an SD card-capable Kodak picture maker/picture kiosk. (Contact a location before visiting. See www.kodak.com/go/picturemaker.)
- Take the card to your local photo retailer for professional printing.

Accessories for your camera

To see which EasyShare camera and printer docks are compatible with your camera, visit www.kodak.com/go/dockcompatibility.

To purchase camera docks, printer docks, chargers, and other accessories, visit www.kodak.com/go/zd710accessories.

6

Troubleshooting

Camera problems

For step-by-step product support, visit www.kodak.com/go/zd710support and select Interactive Troubleshooting & Repairs.

If	Try one or more of the following
Camera does not turn on	<ul style="list-style-type: none"> ■ Insert a new or charged battery. ■ If practical, connect the camera to a Kodak 3-volt AC adapter (sold separately), then try again. See page 62 for more battery information.
Camera does not turn off and the lens does not retract	
Camera buttons and controls do not function	
Lens does not extend when camera turns on or does not retract	<ul style="list-style-type: none"> ■ Confirm that the battery in camera is charged. ■ Turn camera off, then on again. (Lens does not extend in Favorites mode.) ■ If problem still exists, get help (see page 56).
EVF/LCD is black or does not turn on	<ul style="list-style-type: none"> ■ Remove the lens cap. ■ Push the EVF/LCD button to change the display.
In Review, a blue or black screen is displayed instead of a picture	<ul style="list-style-type: none"> ■ Transfer the picture to the computer. ■ Transfer <i>all</i> pictures to the computer (see page 47). ■ Take another picture. If problem continues, try internal memory and/or another memory card.
Pictures remaining number does not decrease after taking a picture	<ul style="list-style-type: none"> ■ Continue taking pictures. The camera is operating normally. (The camera estimates the number of pictures remaining after each picture is taken, based on picture size and content.)

If	Try one or more of the following
Picture orientation is not accurate	<ul style="list-style-type: none"> ■ Set the Orientation Sensor to ON (see page 34)
Flash does not fire	<ul style="list-style-type: none"> ■ Open the flash unit. ■ Check the flash setting and change as needed (see page 9). <p>NOTE: The flash does not fire in all modes.</p>
Storage location is almost or entirely full	<ul style="list-style-type: none"> ■ Transfer pictures to the computer (see page 47). ■ Delete pictures from the card (see page 16) or insert a new card. ■ Change image storage location to internal memory (see page 33).
Battery life is short	<ul style="list-style-type: none"> ■ Make sure the correct battery type is installed (see page 62). ■ Wipe the contacts with a clean, dry cloth before inserting a battery in the camera. ■ Insert a new or charged battery (see page 2).
You cannot take a picture	<ul style="list-style-type: none"> ■ Turn camera off, then on again. Make sure the camera is not in Favorites mode. If prompted, set language and date/time. ■ Press Shutter button all the way (see page 5). ■ Insert a new or charged battery (see page 2). ■ Wait until the AF/AE indicator turns green before attempting to take another picture. ■ Memory full. Transfer pictures to the computer (see page 47), delete pictures (see page 16), change image storage location (see page 33), or insert another card.
Error message appears on EVF/LCD	<ul style="list-style-type: none"> ■ Follow the EVF/LCD prompts. ■ Turn the camera off, then on again. ■ Remove memory card from the camera. ■ Remove the battery and wipe the contacts with a clean, dry cloth. ■ Insert a new or charged battery (see page 2). ■ Get customer support help (see page 56).

If	Try one or more of the following
Memory card not recognized or camera freezes with card.	<ul style="list-style-type: none"> ■ Card may be corrupted. Format card in camera (see page 35.) ■ Change image storage location to internal memory (see page 33).

Computer/connectivity problems

If	Try one or more of the following
Computer does not communicate with the camera	<ul style="list-style-type: none"> ■ Insert a charged battery (see page 2). ■ Turn on the camera. ■ Make sure the proper USB cable is connected on camera and computer port (see page 47). (If using an EasyShare dock, check all cable connections. Make sure the camera is seated on the dock.) ■ Make sure the EasyShare software is installed (see page 46).
Pictures do not transfer to computer	<ul style="list-style-type: none"> ■ Click the Help button in the EasyShare software.
Slide Show does not run on an external video device	<ul style="list-style-type: none"> ■ Adjust the camera Video Out setting (see page 35). ■ Make sure the external device settings are correct (see the device's user's guide).

Picture quality problems

If	Try one or more of the following
Picture is too dark	<ul style="list-style-type: none"> ■ Reposition camera for more available light. ■ Use Fill flash (see page 9) or change your position so light is not behind the subject. ■ Move so that the distance between you and the subject is within the effective flash range (see page 9). ■ To automatically set exposure and focus, press the Shutter button halfway. When the AF/AE indicator turns green, press the Shutter button completely down to take the picture. ■ If using P, A, or S mode, adjust exposure compensation (see page 37).
Picture is too light	<ul style="list-style-type: none"> ■ Reposition camera to reduce the amount of available light. ■ Turn flash off (see page 9). ■ Move so that the distance between you and the subject is within the effective flash range (see page 9). ■ To automatically set exposure and focus, press the Shutter button halfway. When the AF/AE indicator turns green, press the Shutter button completely down to take the picture. ■ If using P, A, or S mode, adjust exposure compensation (see page 37).
Picture is not clear	<ul style="list-style-type: none"> ■ To automatically set exposure and focus, press the Shutter button halfway. When the AF/AE indicator turns green, press the Shutter button completely down to take the picture. ■ Clean the lens (see page 60). ■ Make sure camera is not in Close-up/Macro mode if you are more than 27.6 in. (70 cm) from your subject. (Move further away if you are using the zoom lens in Close-up/Macro.) ■ Place the camera on a flat, steady surface or use a tripod, especially in high-zoom settings or in low light.

Direct printing (PictBridge) problems

If	Try one or more of the following
Cannot locate desired picture.	<ul style="list-style-type: none"> ■ Turn on the camera. Make sure the camera is accessing internal memory/card or Favorites. ■ If you are using Direct print, use the menu to change the image storage location.
The Direct print menu interface turns off.	Press any button to redisplay the menu.
Cannot print pictures.	<ul style="list-style-type: none"> ■ Ensure that there is a connection between camera and printer (see page 47). ■ Ensure the printer and camera have power.

7

Getting help

Helpful links

Camera

Email Kodak customer support	www.kodak.com/go/contact
Get support for your product (FAQs, troubleshooting information, arrange for repairs, etc.)	www.kodak.com/go/zd710support
Purchase camera accessories (camera docks, printer docks, lenses, cards, chargers, etc.)	www.kodak.com/go/zd710accessories
Download the latest camera firmware and software	www.kodak.com/go/zd710downloads
See online demonstrations of your camera	www.kodak.com/go/howto

Software

Get information on EasyShare software	www.kodak.com/go/easysharesw (or click Help in EasyShare software)
Get help with the Windows operating system and working with digital pictures	www.kodak.com/go/pcbasics

Other

Get support for other cameras, software, accessories, more	www.kodak.com/go/support
Get information on Kodak EasyShare printer docks	www.kodak.com/go/printerdocks
Get information on Kodak inkjet products	www.kodak.com/go/inkjet
Optimize your printer for truer, more vibrant colors	www.kodak.com/go/onetouch
Register your camera	www.kodak.com/go/register

NOTE: If you have questions concerning this product, you may speak with Kodak customer support.

Australia	1800 267 588
Austria	0179 567 357
Belgium	02 713 14 45
Brazil	0800 891 42 13
Canada	1 800 465 6325
China	800 820 6027
Czech Republic	00 800 56325000
Denmark	3 848 71 30
Ireland	01 407 3054
Finland	0800 1 17056
France	01 55 1740 77
Germany	069 5007 0035
Greece	00800 44140775
Hong Kong	800 901 514
Hungary	06 80 456 325
India	91 80 41374555 (toll free 000800 440 1227)
Italy	02 696 33452
Japan	03 5540 9002
Korea	080 708 5600

Netherlands	020 346 9372
New Zealand	0800 880 120
Norway	23 16 21 33
Philippines	1 800 1 888 9600
Poland	00800 4411625
Portugal	021 415 4125
Russia	8 495 929 9166
Singapore	800 6363 036
Slovakia	00 800 56325000
Spain	91 749 76 53
Sweden	08 587 704 21
Switzerland	01 838 53 51
Taiwan	0800 096 868
Thailand	001 800 631 0017
Turkey	00800 448827073
United Kingdom	0870 243 0270
United States	1 800 235 6325
International Toll Line	+44 131 458 6714
International Toll Fax	+44 131 458 6962

Camera specifications

CCD—1/2.5 in. CCD, 4:3 aspect ratio

Picture size—

7.1 MP (4:3): 3072 x 2304 pixels

6.3 MP (3:2): 3072 x 2048 pixels

5.3 MP (16:9): 3072 x 1728 pixels

5.0 MP (4:3): 2592 x 1944 pixels

3.1 MP (4:3): 2048 x 1536 pixels

2.2 MP (3:2): 1800 x 1200 pixels

2.1 MP (16:9): 1920 x 1080 pixels

1.2 MP (4:3): 1280 x 960 pixels

LCD—2 in. (5 cm) color LCD; 150 K pixels

Electronic viewfinder—0.2 in. (5.1 mm) 201 K pixels

Lens—10X optical zoom; aspheric all-glass lens; f/2.8–3.7 (35 mm equivalent: 38–380 mm)

Accessory lens thread—Yes

Lens protection—Lens cap

Digital zoom—Combined zoom settings up to 50X in 0.2X increments. (Not supported for movie capture.)

Focus system—TTL-AF; Multi-zone AF and Center-zone AF. Working range:

24 in. (60 cm)—infinity @ wide

6.6 ft (2 m)—infinity @ telephoto

4.7–27.6 in. (12–70 cm) @ wide close-up

3.9–6.9 ft (1.2–2.1 m) @ telephoto close-up

Exposure metering—Multi-pattern, center-weighted, center spot

Exposure compensation—+/-2.0 EV with 1/3 EV step

White Balance—Auto, Daylight, Open Shade, Tungsten, Fluorescent (available only in PASM)

Shutter speed—

Smart Scene mode: 1/2–1/2000 sec.

Shutter priority and Manual mode: 8–1/1000 sec.

ISO speed—

Auto: 64 to 400

Selectable: 80, 100, 200, 400, 800, 1600, 3200 (3200 available only at 1.2, 2.1, and 2.2 MP in PASM mode only)

Electronic flash—Guide no. 10.6 (@ ISO 100); auto flash with pre-flash control.

Working range @ ISO Auto:

2–17.4 ft (0.6–5.3 m) @ Wide

6.6–18.7 ft (2–5.7 m) @ Tele

Flash modes—Auto, Fill, Red Eye, Off

Capture modes—Smart Scene, SCN (Scene), Video, P, A, S, M, High-ISO, Digital Image Stabilization, Panorama

Burst mode—First burst up to 2 pictures; Last burst up to 2 pictures; both @ approx. 2 fps (Exposure, focus, and white balance executed for first shot only.)

Color modes—High Color, Natural Color, Low Color, Black & White, Sepia

Sharpness—High, Normal, Low

Video capture—

VGA (640 x 480) @ 30 fps

QVGA (320 x 240) @ 30 fps

Image file format—

Still: EXIF 2.2.1 (JPEG compression); file organization DCF

Video: QuickTime (CODEC Motion JPEG)

Image storage—Optional SD Card  (The SD logo is a trademark of the SD Card Association.)

Internal storage capacity—32 MB internal memory (25 MB available for image storage. 1 MB equals one million bytes.)

Quickview—Yes

Video output—NTSC or PAL

Power—Kodak lithium digital camera battery CRV3; Kodak Ni-MH rechargeable digital camera battery (KAA2HR); AA lithium, Ni-MH, or Oxy-Alkaline batteries; 3V AC adapter; EasyShare dock

Communication with computer—USB 2.0 full speed (PIMA 15740 protocol), via USB cable (U-8), EasyShare dock

PictBridge support—Yes

Self-timer—2 seconds, 10 seconds, 2-shot

Date stamp—On, Off

Tripod mount—1/4 inch

Operating temperature—32–104° F (0–40° C)

Size—3.9 x 3.1 x 2.9 in. (9.8 x 7.8 x 7.3 cm) @ power off

Weight—9.9 oz (282 g) without card or battery

Care and maintenance

- If you suspect water has gotten inside the camera, remove the battery and card. Allow all components to air-dry for at least 24 hours before using the camera.
- Blow gently on the lens or LCD to remove dust and dirt. Wipe gently with a soft, lint-free cloth or an untreated lens-cleaning tissue. Do not use cleaning solutions unless designed specifically for camera lenses. Do not allow chemicals, such as suntan lotion, to contact painted surfaces.

- Service agreements may be available in your country. Contact a dealer of Kodak products for more information.
- For digital camera disposal or recycling information, contact your local authorities. In the US, visit the Electronics Industry Alliance Web site at www.eiae.org or www.kodak.com/go/zd710support.

Storage capacities

The LCD displays the approximate number of pictures (or minutes/seconds of video) remaining. For average SD card capacities, visit www.kodak.com/go/SDcapacities. Actual storage capacity varies depending on subject composition, card size, and other factors. You may be able to store more or fewer pictures and videos. Favorites take up additional space in internal memory.

Important safety instructions



CAUTION:

Do not disassemble this product; there are no user-serviceable parts inside. Refer servicing to qualified service personnel. Kodak AC adapters and battery chargers are intended for indoor use only. The use of controls, adjustments, or procedures other than those specified herein may result in exposure to shock and/or electrical or mechanical hazards. If the LCD breaks, do not touch the glass or liquid. Contact Kodak customer support.

- The use of an accessory that is not recommended by Kodak may cause fire, electric shock, or injury. For approved accessories, visit www.kodak.com/go/accessories.
- Use only a USB-certified computer equipped with a current-limiting motherboard. Contact your computer manufacturer if you have questions.
- If using this product in an airplane, observe all instructions of the airline.
- When removing the battery, allow it to cool; it may be hot.
- Follow all warnings and instructions supplied by the battery manufacturer.
- Use only batteries approved for this product to avoid risk of explosion.

www.kodak.com/go/support

- Keep batteries out of the reach of children.
- Do not allow batteries to touch metal objects, including coins. Otherwise, a battery may short circuit, discharge energy, become hot, or leak.
- Do not disassemble, install backward, or expose batteries to liquid, moisture, fire, or extreme temperature.
- Remove the battery when the product is stored for an extended period of time. If battery fluid leaks inside the product, contact Kodak customer support.
- In the unlikely event that battery fluid leaks onto your skin, wash immediately with water and contact your local health provider. For additional health-related information, contact your local Kodak customer support.
- Dispose of batteries according to local and national regulations. Visit www.kodak.com/go/kes.
- Do not charge non-rechargeable batteries. Visit www.kodak.com/go/batterytypes.

Battery life

- Kodak lithium digital camera battery CRV3 (non-rechargeable): > 500 pictures
- Kodak Ni-MH rechargeable digital camera battery (KAA2HR): > 300 pictures
- Kodak oxy-alkaline digital camera battery AA: > 120 pictures

Battery life per CIPA testing method (Approx. number of pictures). Actual life may vary based on usage.

Extending battery life

- Use power-saving features (see [Using the Setup menu, page 33](#)). Limit activities such as reviewing pictures/videos on the LCD.
- Dirt on the battery contacts can affect battery life. Wipe the contacts with a clean, dry cloth before loading the battery in the camera.
- Battery performance is reduced at temperatures below 41° F (5° C). When using your camera in cold weather, keep spare batteries warm. Do not discard cold batteries; when they return to room temperature, they may be usable.

Limited warranty

Kodak warrants Kodak consumer electronic products and accessories ("Products"), excluding batteries, to be free from malfunctions and defects in both materials and workmanship for one year from the date of purchase. Retain the original dated sales receipt. Proof of the date of purchase will be required with any request for warranty repair.

Limited warranty coverage

Warranty service is only available from within the country where the Products were originally purchased. You may be required to ship Products, at your expense, to the authorized service facility for the country where the Products were purchased. Kodak will repair or replace Products if they fail to function properly during the warranty period, subject to any conditions and/or limitations stated herein. Warranty service will include all labor as well as any necessary adjustments and/or replacement parts. If Kodak is unable to repair or replace a Product, Kodak will, at its option, refund the purchase price paid for the Product provided the Product has been returned to Kodak along with proof of the purchase price paid. Repair, replacement, or refund of the purchase price are the sole remedies under the warranty. If replacement parts are used in making repairs, those parts may be remanufactured, or may contain remanufactured materials. If it is necessary to replace the entire Product, it may be replaced with a remanufactured Product. Remanufactured Products, parts and materials are warranted for the remaining warranty term of the original Product, or 90 days after the date of repair or replacement, whichever is longer.

Limitations

This warranty does not cover circumstances beyond Kodak's control. This warranty does not apply when failure is due to shipping damage, accident, alteration, modification, unauthorized service, misuse, abuse, use with incompatible accessories or attachments (such as third party ink or ink tanks), failure to follow Kodak's operation, maintenance or repacking instructions, failure to use items supplied by Kodak (such as adapters and cables), or claims made after the duration of this warranty. Kodak makes no other express or implied warranty for this product, and disclaims the implied warranties of merchantability and fitness for a particular

purpose. In the event that the exclusion of any implied warranty is ineffective under the law, the duration of the implied warranty will be one year from the purchase date or such longer period as required by law. The option of repair, replacement, or refund is Kodak's only obligation. Kodak will not be responsible for any special, consequential or incidental damages resulting from the sale, purchase, or use of this product regardless of the cause. Liability for any special, consequential or incidental damages (including but not limited to loss of revenue or profit, downtime costs, loss of the use of the equipment, cost of substitute equipment, facilities or services, or claims of your customers for such damages resulting from the purchase, use, or failure of the Product), regardless of cause or for breach of any written or implied warranty is expressly disclaimed.

Your rights

Some states or jurisdictions do not allow exclusion or limitation of incidental or consequential damages, so the above limitation or exclusion may not apply to you. Some states or jurisdictions do not allow limitations on how long an implied warranty lasts, so the above limitation may not apply to you. This warranty gives you specific rights, and you may have other rights which vary from state to state or by jurisdiction.

Outside the United States and Canada

In countries other than the United States and Canada, the terms and conditions of this warranty may be different. Unless a specific Kodak warranty is communicated to the purchaser in writing by a Kodak company, no warranty or liability exists beyond any minimum requirements imposed by law, even though defect, damage, or loss may be by negligence or other act.

Upgrading your software and firmware

Download the latest versions of the software included on the Kodak EasyShare software CD and the camera firmware (the software that runs on the camera). See www.kodak.com/go/zd710downloads.

Regulatory compliance

FCC compliance and advisory



Kodak EasyShare ZD710 zoom digital camera

This equipment has been tested and found to comply with the limits for a Class B digital device, pursuant to Part 15 of the FCC Rules. These limits are designed to provide reasonable protection against harmful interference in a residential installation.

This equipment generates, uses, and can radiate radio frequency energy and, if not installed or used in accordance with the instructions, may cause harmful interference to radio communications. However, there is no guarantee that interference will not occur in a particular installation.

If this equipment does cause harmful interference to radio or television reception, which can be determined by turning the equipment off and on, the user is encouraged to try to correct the interference by one or more of the following measures: 1) reorient or relocate the receiving antenna; 2) increase the separation between the equipment and the receiver; 3) connect the equipment to an outlet on a circuit different from that to which the receiver is connected; 4) consult the dealer or an experienced radio/TV technician for additional suggestions.

Any changes or modifications not expressly approved by the party responsible for compliance could void the user's authority to operate the equipment. Where shielded interface cables have been provided with the product or specified additional components or accessories elsewhere defined to be used with the installation of the product, they must be used in order to ensure compliance with FCC regulation.

Canadian DOC statement

DOC Class B Compliance—This Class B digital apparatus complies with Canadian ICES-003.

Observation des normes-Classe B—Cet appareil numérique de la classe B est conforme à la norme NMB-003 du Canada.

Australian C-Tick



Waste Electrical and Electronic Equipment labeling



In Europe: For human/environmental protection, it is your responsibility to dispose of this equipment at a collection facility established for this purpose (separate from municipal waste). For more information, contact your retailer, collection facility, or appropriate local authorities; or visit www.kodak.com/go/recycle. (Product weight: 282 g.)

China RoHS

环保使用期限 (EPUP)

在中国大陆, 该值表示产品中存在的任何危险物质不得释放, 以免危及人身健康、财产或环境的时间期限(以年计)。该值根据操作说明中所规定的产品正常使用而定。

有毒有害物质或元素名称及含量标识表						
部件名称	有毒有害物质或元素					
	铅	汞	镉	六价铬	多溴联苯	多溴二苯醚
数码相机电路板元件	×	○	○	○	○	○

○: 表示该有毒有害物质在该部件所有均质材料中的含量均在SJ/T 11363-2006规定的限量要求以下。
 ×: 表示该有毒有害物质至少在该部件的某一均质材料中的含量超出SJ/T 11363-2006规定的限量要求。



USB 数据线



音频/视频电缆

VCCI Class B ITE

この装置は、情報処理装置等電波障害自主規制協議会（VCCI）の基準に基づいたクラスB情報技術装置です。この装置は、家庭環境で使用することを目的としていますが、この装置がラジオやテレビジョン受信機に近接して使用されると、受信障害を引き起こすことがあります。
取扱説明書に従って正しい取り扱いをして下さい。

Korean Class B ITE

이 기기는 가정용으로 전자파적합등록을 한 기기로서 주거지역에서는 물론 모든 지역에서 사용할 수 있습니다.

Russian GOST-R



Eastman Kodak Company
Rochester, NY 14650

A10-40

Фотокамера изготовлена в Китае; остальные элементы -
в соответствии с маркировкой.

Index

A

- A/V out, 24
- about this camera, 35
- accessories
 - battery, 62
 - buying, 50
 - picture transfer, 47
 - printer dock, 48
 - SD card, 4
- AF control, 31, 33
- album
 - set, 34
 - tagging pictures for, 44
- aperture priority, 37
- auto
 - enhancement, 18
 - flash, 9
 - focus control, 17
 - focus framing marks, 6

B

- backlight, 30
- batteries
 - expected life, 62
 - extending life, 62
 - loading, 2
 - types, 62
- beach, 29
- bookmarks, 22
- burst, using, 12
- button
 - close-up/landscape, i

- delete, ii
- drive, 12
- EVF/LCD, ii
- flash, i, 9
- focus, 10
- info, ii
- menu, ii, 30
- power/favorites, i
- review, ii, 15
- self-timer/burst, i
- share, ii
- zoom, ii, 8

C

- cable
 - audio/video, 24
 - USB, 47
- camera sounds, 34
- candle light, 30
- care and maintenance, 60
- children, 30
- clock, setting, 3
- close-up, 10
- close-up/landscape button, i
- color mode, 31
- computer
 - connecting camera, 46
 - transfer to, 46
- copy pictures
 - card to memory, 26
 - memory to card, 26
 - to computer via USB cable, 46

cropping pictures, 18
customer support, 57
customizing camera settings, 33

D

date setting, 3
date stamp, 31
DC-in, i
delete button, ii
deleting
 from internal memory, 16
 from SD card, 16
 protecting pictures, videos, 16
digital
 image stabilization, 28
 zoom, 8
displaying slide show, 22
disposal, recycling, 61
distant scenes, 10
dock
 connector, ii
 printer, 48
downloading pictures, 46

E

edit videos, 20
emailing pictures, videos, 40
EVF (electronic viewfinder), ii
EVF/LCD button, ii
exposure
 compensation, 37
 metering, 32
external video device
 viewing pictures, videos, 24

F

favorites
 settings, 42
 switch, i
 tagging, 41
fireworks, 29
firmware, upgrading, 64
flash, i
 button, i
 settings, 9
flower, 29
focus
 close-up, 10
 framing marks, 6
 landscape, 10
 zone, 32
format card, internal memory, 35
framing grid, 34

G

guidelines, battery, 62

H

HDTV format, 31
help
 web links, 56
high-ISO, 28
histogram, 45

I

icons, mode dial, 28
image
 stabilizer, 17
 storage, 33
Image stabilizer, 17

info button, ii
installing
 batteries, 2
 SD card, 4
 software, 46
internal memory
 storage capacity, 61
ISO speed, 38

J

joystick, ii

K

Kodak EasyShare software
 installing, 46
 upgrading, 64
Kodak Perfect Touch technology, 18
Kodak Web sites, 56

L

landscape, 10, 29
language, 35
LCD, ii
 reviewing pictures, 15
 reviewing videos, 15
lens, i
 cap, 1
 cleaning, 60
liveview, 34
loading
 batteries, 2
 SD card, 4
 software, 46

M

Mac OS, installing software, 46
maintenance, camera, 60
make picture from video, 20
manner/museum, 29
manual mode, 37
memory
 inserting card, 4
 storage capacities, 61
menu button, ii, 30
microphone, i
mode dial, ii, 28
modes
 aperture priority, 37
 backlight, 30
 beach, 29
 candle light, 30
 children, 30
 digital image stabilization, 28
 fireworks, 29
 flower, 29
 high-ISO, 28
 landscape, 29
 manner/museum, 29
 manual, 37
 night landscape, 29
 night portrait, 29
 portrait, 29
 program, 37
 SCN (scene), 28
 shutter priority, 37
 smart scene, 28
 snow, 29
 sunset, 30

text, 29
multiple selections, 25
multi-up, 24

N

neck strap post, i
night landscape, 29
night portrait, 29

O

online prints, ordering, 50
open flash switch, i
optical zoom, 8
orientation sensor, 34

P

panoramic pictures, 36
PASM mode, 37
Perfect Touch technology, 18
PictBridge printer, 48
picture quality, 31
pictures
 checking settings, 27
 copying, 26
 cropping, 18
 deleting, 16
 emailing tagged, 40
 Kodak Perfect Touch, 18
 printing, 50
 printing tagged, 39
 protecting, 16
 reviewing, 15
 storage capacity, 61
 tagging, 44
 taking, modes, 28

transfer via USB cable, 46
portrait, 29
power
 camera, 3
 switch, i
printer dock, 48
printing
 from a card, 50
 from computer, 50
 optimizing printer, 56
 order online, 50
 PictBridge, 48
 tagged pictures, 50
 with EasyShare printer dock, 48
program mode, 37
protecting pictures, videos, 16

R

recycling, disposal, 61
red eye, flash, 9
regulatory information, 65
repair, 56
reset camera, 35
review, ii
review button, 15
reviewing pictures, 15
 deleting, 16
 protecting, 16
 slide show, 22
reviewing videos, 15
 deleting, 16
 protecting, 16
 slide show, 22
running slide show, 22

S

- safety, 61
- scene (SCN) modes
 - panorama, 36
- scene modes
 - sport, 29
- SCN (scene), 28
- SD card
 - buying, 50
 - inserting, 4
 - printing from, 50
 - slot, ii
 - storage capacities, 61
- select multiple pictures/videos, 25
- self-portrait, 30
- self-timer, 11
- self-timer/burst button, i
- service and support telephone
 - numbers, 57
- setting
 - AF control, 31, 33
 - album, 34
 - auto-focus, 17
 - camera sounds, 34
 - color mode, 31
 - date and time, 3
 - date stamp, 31
 - exposure metering, 32
 - flash, 9
 - focus zone, 32
 - framing grid, 34
 - image storage, 33
 - ISO speed, 38
 - language, 35
 - liveview, 34
 - orientation sensor, 34
 - picture quality, 31
 - picture taking mode, 28
 - reset camera, 35
 - self-timer, 11
 - sharpness, 32
 - video date display, 35
 - video out, 35
 - video size, 17
 - white balance, 32
- setup menu, using, 33
- share button, ii
- sharpness, 32
- shutter
 - priority, 37
 - self-timer delay, 11
 - speed, 37
- slide show
 - continuous loop, 23
 - problems, 53
 - running, 22
- smart scene, 28
- snow, 29
- software
 - installing, 46
 - upgrading, 64
- speaker, i
- specifications, camera, 58
- sport, 29
- storage capacity, 61
- sunset, 30
- support, technical, 57

T

tagging

- favorites, 41
- for albums, 44
- for email, 40
- for print, 39

telephone support, 57

television, slide show, 24

text, 29

time, setting, 3

timer, shutter delay, 11

tips

- battery guidelines, 62
- care & maintenance, 60

transfer, via USB cable, 46

trimming a video, 20

tripod socket, ii

troubleshooting, 51

turning camera on and off, 3

U

undelete, undo, 16

upgrading software, firmware, 64

URLs, Kodak Web sites, 56

USB

- transferring pictures, 46

USB, A/V out, ii

V

VCCI compliance, 66

video

- action print, 21
- checking settings, 27
- copying, 26

date display, 35

deleting, 16

edit, 20

emailing tagged, 40

out, 35

protecting, 16

reviewing, 15

size, 17, 33

storage capacities, 61

transfer to computer, 46

viewing, 15

video bookmarks, 22

viewfinder, ii

viewing

- by date, album, 25

- by multi-up, 24

viewing picture

- after taking, 15

W

warranty, 63

white balance, 32

Windows OS, installing software, 46

Z

zoom

- button, ii

- using, 8

Free Manuals Download Website

<http://myh66.com>

<http://usermanuals.us>

<http://www.somanuals.com>

<http://www.4manuals.cc>

<http://www.manual-lib.com>

<http://www.404manual.com>

<http://www.luxmanual.com>

<http://aubethermostatmanual.com>

Golf course search by state

<http://golfingnear.com>

Email search by domain

<http://emailbydomain.com>

Auto manuals search

<http://auto.somanuals.com>

TV manuals search

<http://tv.somanuals.com>