

Kodak EasyShare Z612 zoom digital camera

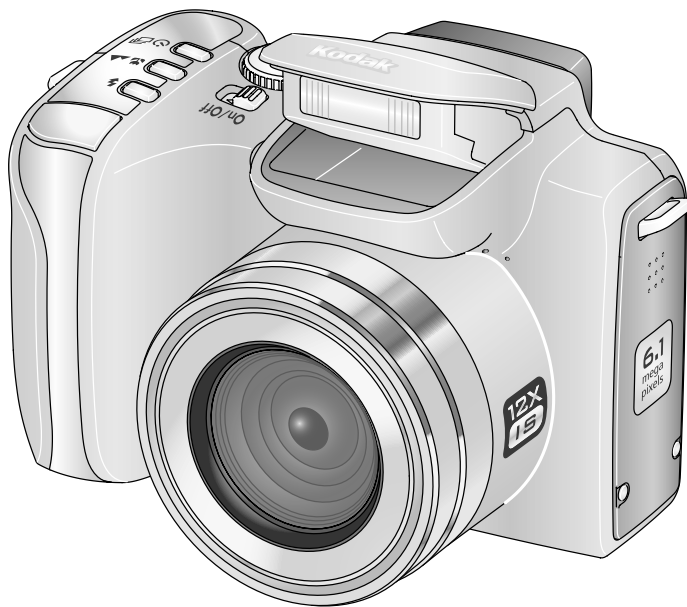

User's guide

www.kodak.com

For interactive tutorials, www.kodak.com/go/howto

For help with your camera, www.kodak.com/go/z612support



Eastman Kodak Company
Rochester, New York 14650
© Eastman Kodak Company, 2006

All screen images are simulated.

Kodak, EasyShare, and Perfect Touch are trademarks of Eastman Kodak Company.
Schneider-Kreuznach and Xenar are trademarks of Jos. Schneider Optische Werke
GmbH used under license by Eastman Kodak Company.

P/N 4J4801_en

Front View

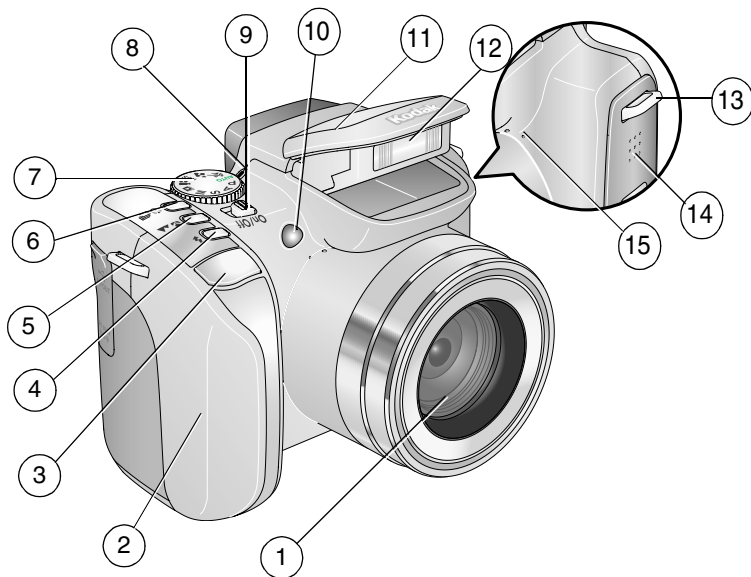

- | | | | |
|---|---------------------------|----|----------------------------|
| 1 | Lens | 9 | On/Off switch |
| 2 | Grip | 10 | Self-Timer/AF Assist light |
| 3 | Shutter button | 11 | Flash hood |
| 4 | Flash button (⚡) | 12 | Flash |
| 5 | Focus button (🏔️) | 13 | Strap post |
| 6 | Drive button (🔄 📄) | 14 | Speaker |
| 7 | Mode dial | 15 | Microphone |
| 8 | Mode-dial-indicator light | | |

Back View

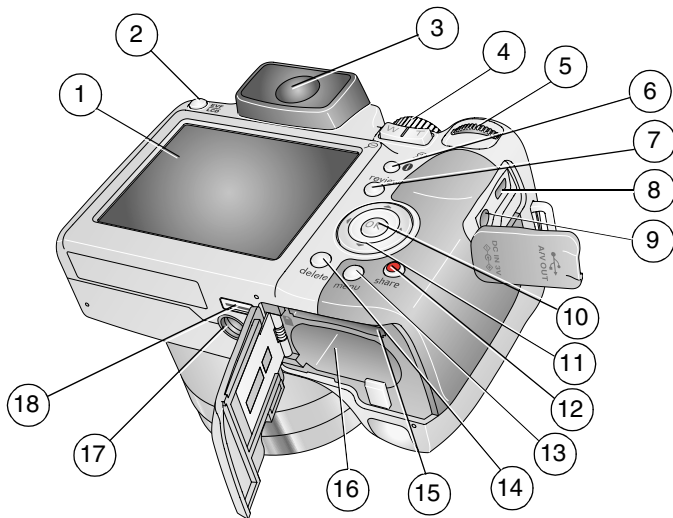

- | | |
|-------------------------------|--|
| 1 LCD Screen | 10 OK button (press) |
| 2 EVF/LCD toggle button | 11 4-way \leftarrow/\rightarrow \uparrow/\downarrow button |
| 3 EVF (Electronic Viewfinder) | 12 Share button |
| 4 Zoom lever/Review magnifier | 13 Menu button |
| 5 Jog dial | 14 Delete button |
| 6 Info button | 15 Slot for optional SD or MMC card |
| 7 Review button | 16 Battery compartment |
| 8 USB, A/V Out | 17 Tripod socket |
| 9 DC-In (3V) | 18 Dock connector |

Table of contents

1	Setting up your camera	1
	Attaching the lens cap and camera strap	1
	Charging the battery	2
	Loading the battery	2
	Turning on the camera	3
	Setting the language and date/time, first time	3
	Setting the language and date/time, other times	4
	Storing pictures on an SD or MMC card	4
2	Taking pictures and videos	5
	Taking a picture	5
	Reviewing pictures and videos	9
	Using optical zoom	12
	Using the flip-up flash	13
	Protecting pictures and videos from deletion	14
	Deleting pictures and videos	14
3	Transferring and printing pictures	15
	Installing the software	15
	Transferring pictures	16
	Printing pictures	17
	Dock compatibility for your camera	20
4	Doing more with your camera	21
	Picture-taking modes	21
	Changing the flash settings	25
	Using the focus button	26
	Using self-timer, burst, and exposure bracketing	27
	Using the histogram to view picture brightness	29
	Using exposure compensation with exposure bracketing	29
	PASM modes	30
	Changing picture-taking settings	32

Customizing your camera	36
Viewing picture/video information	39
Copying pictures and videos	40
Making a video action print or picture	41
Using Kodak Perfect Touch technology	43
Cropping pictures	43
Running a slide show	44
Pre-tagging for album names	45
Sharing your pictures	48
5 Troubleshooting	54
Camera problems	54
Computer/connectivity problems	56
Picture quality problems	56
Mode-dial-light indicator status	57
Direct printing (PictBridge) problems	58
6 Getting help	59
Helpful links	59
Telephone customer support	60
7 Appendix	61
Camera specifications	61
Storage capacities	65
Power-saving features	67
Important safety instructions	68
Battery information	70
Upgrading your software and firmware	71
Additional care and maintenance	71
Warranty	72
Regulatory compliance	74

1

Setting up your camera

Attaching the lens cap and camera strap

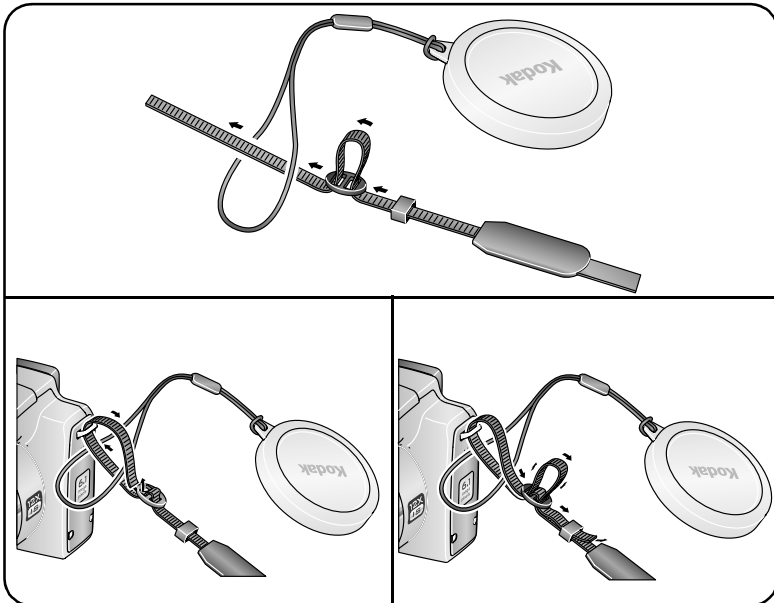

Charging the battery

Charge the Li-Ion rechargeable battery before first use.

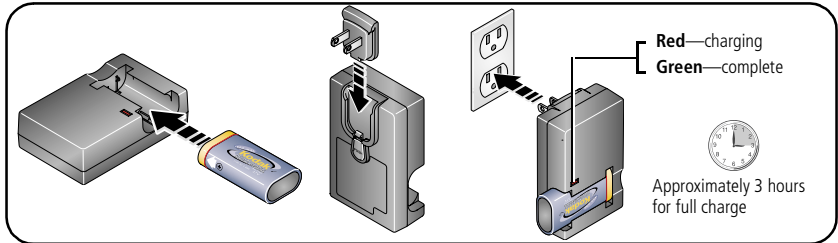

You can also charge the battery using a Kodak EasyShare printer dock or camera dock. Purchase these and other accessories at a dealer of Kodak products or visit www.kodak.com/go/z612accessories.

Loading the battery

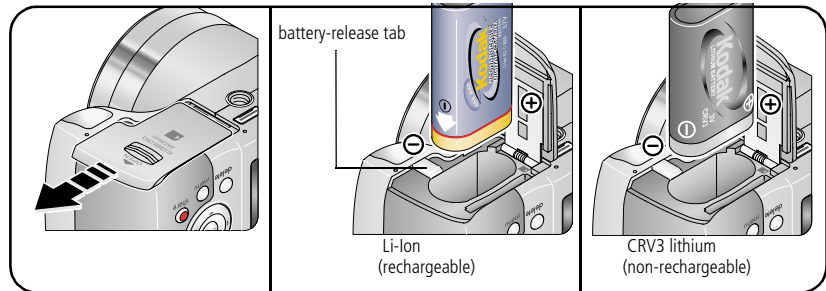

For more battery information, see [page 70](#).

Turning on the camera

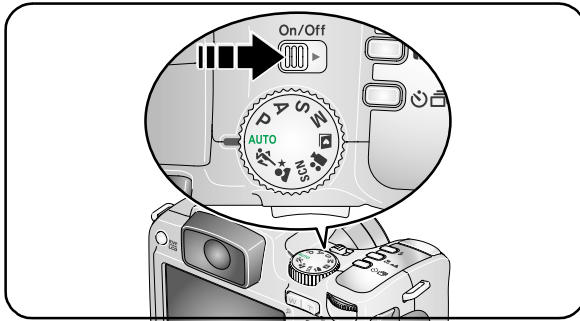

Setting the language and date/time, first time

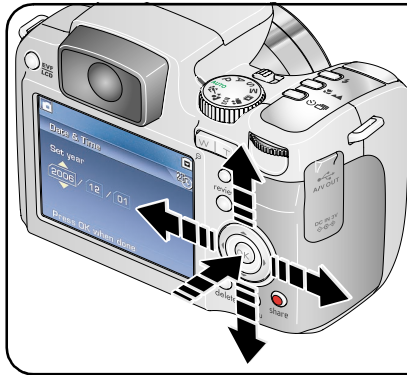

Language:

Move $\blacktriangle/\blacktriangledown$ to choose a Language, then press OK.

Date & Time:

- 1 Press OK.
- 2 $\blacktriangle/\blacktriangledown$ to change.
 $\blacktriangle/\blacktriangledown$ for previous/next field.
- 3 Press OK to accept.

Setting the language and date/time, other times

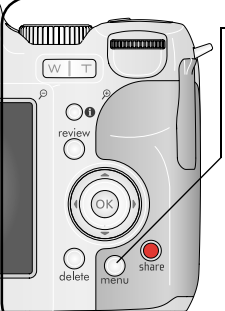

- 1 Press Menu.
- 2 ▲/▼ to highlight Setup Menu , then press OK.
- 3 ▲/▼ to highlight Language or Date/Time, then press OK.

If setting the date/time:

- ▲/▼ to change.
- ◀/▶ for previous/next field.
- OK to accept.

Storing pictures on an SD or MMC card

Your camera has internal memory. You can purchase an SD or MMC card to conveniently store more pictures and videos.

NOTE: When using the card for the first time, format it in this camera before taking pictures (see table on [page 36](#)). We recommend Kodak SD or MMC cards.

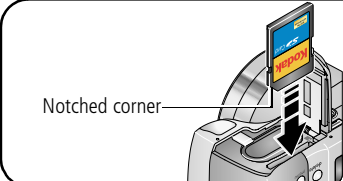

- 1 Turn off the camera.
- 2 Insert card.
SD or MMC card (optional)



CAUTION:

A card can only be inserted one way; forcing it may cause damage.

See [page 65](#) for storage capacities. Purchase SD or MMC cards at a dealer of Kodak products or www.kodak.com/go/z612accessories.

2

Taking pictures and videos

Taking a picture

1 Turn the mode dial to **P** (Program).

2 View the scene through the **EVF** or **LCD**.

3 Press the Shutter button halfway to set the **AF/AE** (Auto Focus /Auto Exposure).
When the **AF/AE** indicator turns green, press the Shutter button completely down.

AF/AE indicator:
● Green—successful
● Red—failed
AF failed focus
AE failed exposure

Taking a video

1 Turn the mode dial to **V** (Video).

2 View the scene through the **EVF** or **LCD**.

3 Press the Shutter button completely down and release.
To stop recording, press and release the Shutter button again.

Capture modes in liveview

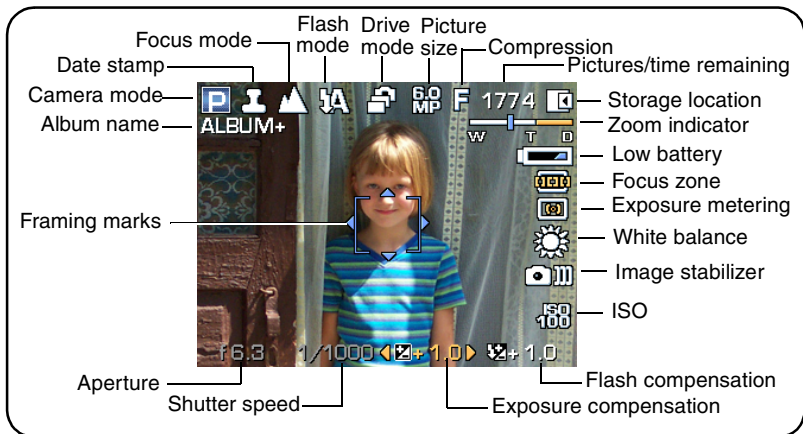

Capture modes—shutter pressed halfway

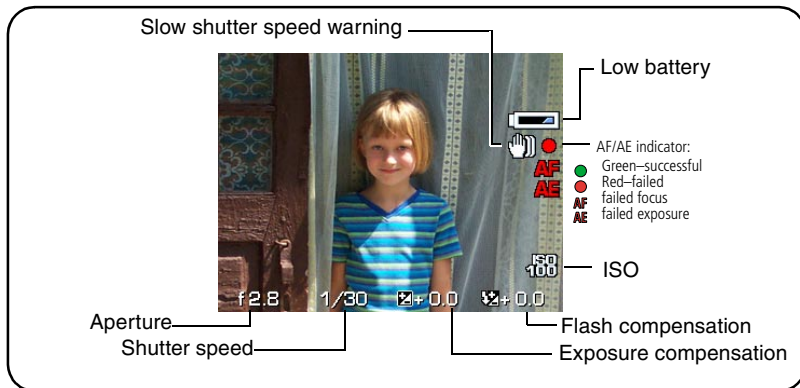

Reviewing a quickview of the picture or video just taken

After you take a picture or video, the EVF/LCD screen displays a quickview for approximately 5 seconds. To view pictures and videos anytime, see [page 9](#).

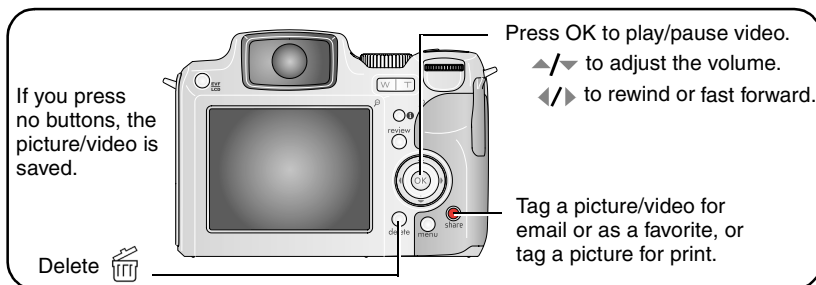

NOTE: You can change the Quickview default from On to Off in the Setup menu ([page 36](#)).

Viewing multi-up (thumbnails)

- 1 Press Review.
(Press again to exit.)
 - 2 Press ▼.
 - 3 ◀/▶ ▲/▼ to view previous/
next picture or video.
- NOTE: You can also press Menu, highlight Multi-up, then press OK.
- 4 Press OK to display a single view.



Using the Auto-Focus (AF) framing marks (pictures)

When using the EVF/LCD screen as a viewfinder, framing marks indicate where the camera is focusing. For the best pictures, the camera attempts to focus on foreground subjects, even if the subjects are not centered in the scene.

- 1 Press the Shutter button **halfway**. When the framing marks turn green, focus is accomplished.

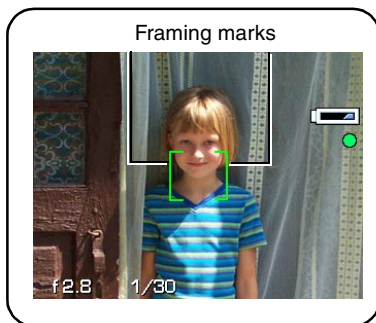

- 2 If the camera is not focusing on the desired subject (or if the framing marks disappear), release the Shutter button and recompose the scene.
- 3 Press the Shutter button **completely down** to take the picture.

NOTE: Framing marks do not appear in Landscape, Night Landscape, or Video mode. When you use AF Zone (see table on [page 32](#)) and set Center Zone, the framing marks are fixed at a center wide location.

Reviewing pictures and videos

Press Review to view and work with your pictures and videos.

Pictures

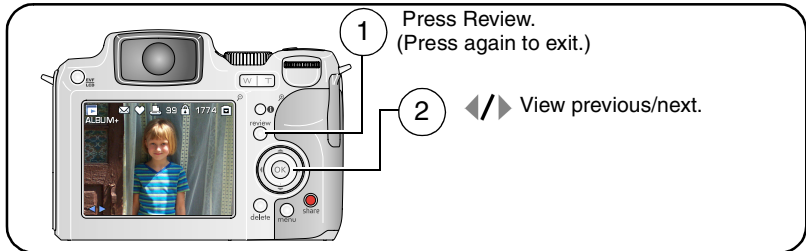

NOTE: Pictures taken at the 5.3 MP (3:2) quality setting are displayed at a 3:2 aspect ratio with a black bar at the top and bottom of the screen.

Videos

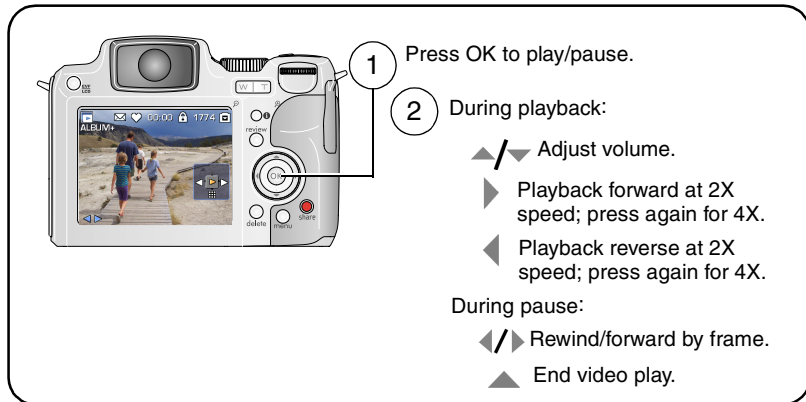

To save battery power, use the optional Kodak EasyShare camera or printer dock, or Kodak 3-volt AC adapter. (See www.kodak.com/go/z612accessories.)

Identifying the review icons

Picture

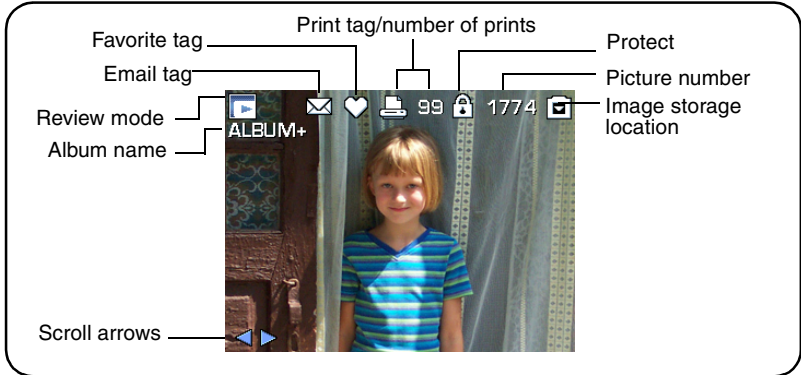



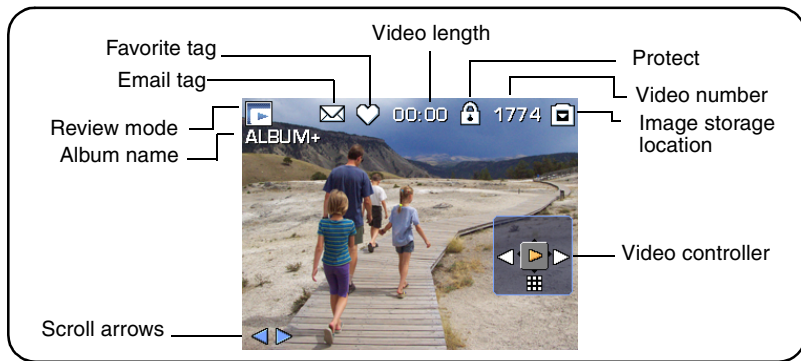







Video



Review options

In Review, press the Menu button to access review options for pictures and videos. Some settings may be unavailable in some modes.

	Album (page 45)		Slide Show (page 44)
	Perfect Touch tech. (page 43)		Copy (page 40)
	Crop (page 43)		Image Storage (see table on page 32)
	Make Picture (page 42)		Multi-up (page 7)
	Action Print (page 41)		Setup Menu (page 36)
	Protect (page 14)		

Checking camera and picture status

1 Press Review.
(Press again to exit.)

2 Repeatedly press **i** for:

- Status icons on
- Status icons off
- Histogram and picture/video info

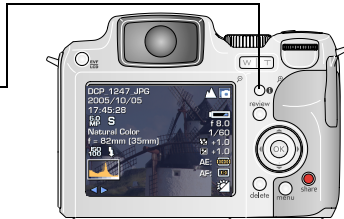

Magnifying a picture during review

Use this feature to view the magnification of the picture.

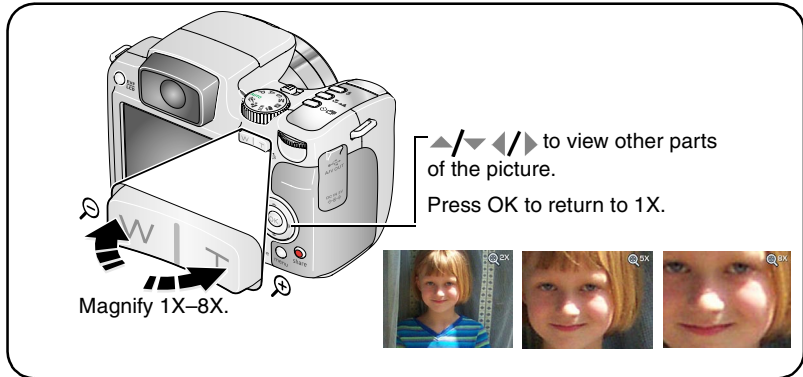

Using optical zoom

Use optical zoom to get up to 12X closer to your subject. You can use optical zoom for pictures and videos.

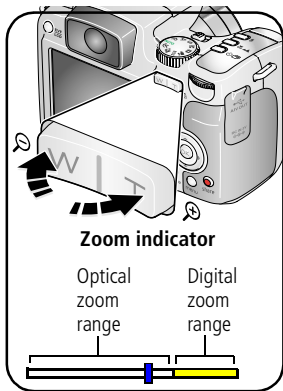

- 1 Use the EVF or LCD screen to frame your subject.
- 2 Press Telephoto (T) to zoom in. Press Wide Angle (W) to zoom out.
The Zoom indicator shows zoom status.
- 3 Press the Shutter button **halfway** to set the exposure and focus, then press **completely down** to take the picture. (When taking videos, press and release the Shutter button.)

Using advanced digital zoom

Use digital zoom in any Still mode to get up to an additional 4.2X magnification beyond optical zoom. Combined zoom settings are from 12X to 50X.

- 1 Change the default setting from None to Continuous or Pause in the Setup menu, [page 36](#).
- 2 Press the Telephoto (T) button to the optical zoom limit (12X). Release the button, then press it again to enter digital zoom range.

The Zoom indicator shows zoom status.

- 3 Take the picture or video.

NOTE: You cannot use digital zoom for video recording. You may notice decreased image quality when using digital zoom for pictures. The blue slider on the zoom indicator pauses and turns red when the picture quality reaches the limit for an acceptable 4 x 6 in. (10 x 15 cm) print.

Using the flip-up flash

Use the flash when you take pictures at night, indoors, or outdoors in heavy shadows. Make sure you are within the flash range.

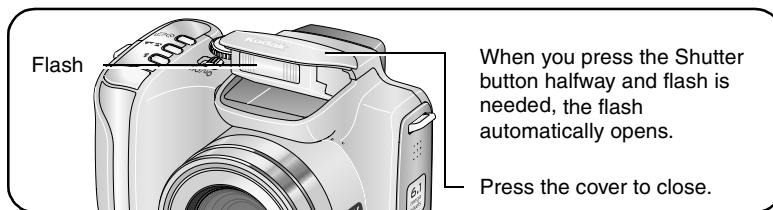

To change the flash settings, see [page 25](#).

Flash-to-subject distance	
Zoom position	Flash distance
Wide angle	1.6–15.4 ft (0.5–4.7 m) @ ISO, Auto
Telephoto	3.9–8.9 ft (1.2–2.7 m) @ ISO, Auto

Protecting pictures and videos from deletion

- 1 Press the Review button. (Press again to exit.)
- 2 Press ◀/▶ for previous/next.
- 3 Press the Menu button.
- 4 Press ▲/▼ to highlight Protect, then press the OK button.
- 5 To remove protection, press the OK button again.
- 6 Press the Menu button to exit.

The picture or video is protected and cannot be deleted. The Protect icon appears with the protected picture or video.



CAUTION:

Formatting internal memory or an SD or MMC card deletes all (including protected) pictures, videos. (Formatting internal memory also deletes email addresses, album names, and favorites. To restore them, see EasyShare software Help.)

Deleting pictures and videos

- 1 Press the Review button. (Press again to exit.)
- 2 Press ◀/▶ for previous/next.
- 3 Press the Delete button.
- 4 Follow the screen prompts.

PICTURE or VIDEO—deletes the displayed picture or video.

EXIT—exits the Delete screen.

ALL—deletes all pictures and videos from your current storage location.

NOTE: To delete protected pictures and videos, remove protection before deleting.

3

Transferring and printing pictures

Installing the software



CAUTION:

Install Kodak EasyShare software *before* connecting the camera or optional dock to the computer. Failure to do so may cause the software to load incorrectly.

- 1 Close all software applications that are open on your computer (including anti-virus software).
- 2 Place the Kodak EasyShare software CD into the CD-ROM drive.
- 3 Load the software:

Windows OS—if the install window does not appear, choose Run from the Start menu and type **d:\setup.exe** where **d** is the drive letter that contains the CD.

Mac OS X—double-click the CD icon on the desktop, then click the Install icon.

- 4 Follow the on-screen instructions to install the software.

Windows OS—select Complete to automatically install the most commonly used applications. Select Custom to choose the applications you wish to install.

Mac OS X—follow the on-screen instructions.

NOTE: When prompted, register your camera and software. Registering lets you sign up for information that keeps your system up-to-date. To register later, visit www.kodak.com/go/register.

- 5 If prompted, restart the computer. If you turned off anti-virus software, turn it back on. See the anti-virus software manual for details.

For information on the software applications included on the Kodak EasyShare software CD, click the Help button in the Kodak EasyShare software.

Transferring pictures

You can transfer pictures to your computer using a USB cable (U-8), EasyShare dock, or Kodak multi-card reader/Kodak SD multimedia card reader-writer.

Purchase these and other accessories at a dealer of Kodak products or www.kodak.com/go/z612accessories.

Transferring pictures with a USB cable, model U-8

If your package does not include an EasyShare dock, use the USB cable (model U-8) that came with your camera.

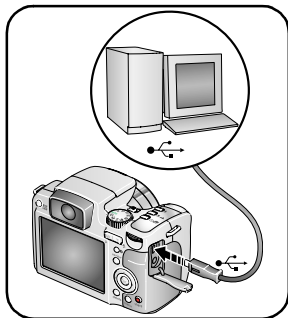

- 1 Turn off the camera.
- 2 Plug the labeled end of the USB cable into the labeled USB port on your computer. See your computer user's guide for details.
- 3 Plug the other end of the USB cable into the labeled USB port on the camera.
- 4 Turn on the camera.

Kodak EasyShare software opens on your computer. The software prompts you through the transfer process.

NOTE: Visit www.kodak.com/go/howto for an online tutorial on connecting.

Also available for transferring

You can also use these Kodak products to transfer your pictures and videos.

- Kodak EasyShare camera dock, Kodak EasyShare printer dock
- Kodak multi-card reader, Kodak SD multimedia card reader-writer

Purchase these and other accessories at a dealer of Kodak products or www.kodak.com/go/z612accessories.

Printing pictures

Printing with a Kodak EasyShare printer dock

Dock your camera to the Kodak EasyShare printer dock and print directly—with or without a computer. Purchase this and other accessories at a dealer of Kodak products or www.kodak.com/go/z612accessories.

Printing from an optional SD or MMC card

- Automatically print tagged pictures when you insert your card into a printer with an SD or MMC card slot. See your printer user's guide for details.
- Make prints at an SD or MMC card-capable Kodak picture maker/picture kiosk. (Contact a location prior to visiting. See www.kodak.com/go/picturemaker.)
- Take the card to your local photo retailer for professional printing.

Direct printing with a PictBridge enabled printer

Your camera is compatible with PictBridge technology, which lets you print directly to PictBridge enabled printers, without a computer. You need:

- Camera with fully charged batteries, or with optional Kodak 3-volt AC adapter
- PictBridge enabled printer
- USB cable (U-8)

Connecting the camera to the printer

- 1 Turn off the camera and printer.
- 2 Optional: If you have a Kodak 3-volt AC adapter (optional accessory), plug it into the camera and into an electrical outlet.
- 3 Connect the appropriate USB cable from the camera to the printer. (See your printer user guide or www.kodak.com/go/z612accessories for details.)

Printing pictures

NOTE: Print size is dependant on printer capabilities.

- 1 Turn the Mode dial to Auto or Favorites.
- 2 Turn on the printer.

The PictBridge logo is displayed, followed by the current picture and menu. (If no pictures are found, a message is displayed.) If the menu interface turns off, press any button to redisplay it.

- 3 Move $\blacktriangle/\blacktriangledown$ to choose a printing option, then press the OK button.

NOTE: During direct printing, pictures are not transferred or saved to the computer or printer.

Current Picture	Move $\blacktriangle/\blacktriangleright$ to choose a picture. Move $\blacktriangle/\blacktriangledown$ to choose the number of copies.
Tagged Pictures	If your printer is capable, print pictures that you tagged for printing (see page 48).
Index Print	Print thumbnails of all pictures. This option requires one or more sheets of paper.
All Pictures	Print all pictures in internal memory, on a memory card, or in Favorites. Choose the number of copies.
Image Storage	Access internal memory, a memory card, or Favorites.

NOTE: During direct printing, pictures are not permanently transferred or saved to the computer or printer. To transfer pictures to your computer, see [page 16](#). In Favorites mode, the current favorite picture is displayed.

Disconnecting the camera from a PictBridge printer

- 1 Turn off the camera and printer.
- 2 Disconnect the USB cable from the camera and the printer.

Ordering prints online

Kodak EasyShare Gallery, www.kodakgallery.com, (formerly Ofoto) is one of the many online print services offered in the Kodak EasyShare software. You can easily:

- Upload your pictures.
- Edit, enhance, and add borders to your pictures.
- Store pictures, and share them with family and friends.
- Order high-quality prints, photo greeting cards, frames, and albums—and have them delivered to your door.

Printing pictures from your computer

For details on printing pictures from your computer, click the Help button in the Kodak EasyShare software.

Dock compatibility for your camera

You can also check dock compatibility for your camera at www.kodak.com/go/dockcompatibility.

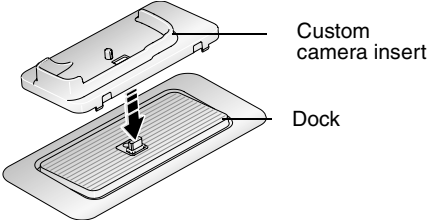
Kodak EasyShare dock	Docking configuration
<ul style="list-style-type: none">■ series 3 printer docks and camera docks■ photo printer 500	 <p>Custom camera insert</p> <p>Dock</p>

Purchase camera docks, printer docks, and other accessories at a dealer of Kodak products or www.kodak.com/go/z612accessories.



4

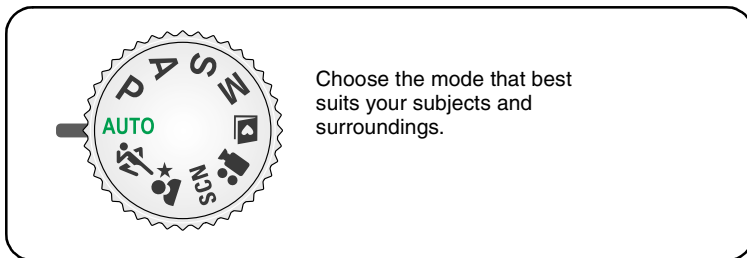

Doing more with your camera

Picture-taking modes



Choose the mode that best suits your subjects and surroundings.

Use this mode	For
 Auto AUTO	General picture-taking—offers an excellent balance of image quality and ease of use.
 Sport	Subjects that are in motion. Shutter speed is fast.
 Night Portrait	Reduces red eye of people in night scenes or low-light conditions. Place the camera on a flat, steady surface or use a tripod.
SCN Scene	Point-and-shoot simplicity when taking pictures under special conditions (see page 23).
P Program	Controlling the exposure compensation, flash compensation (how much light enters the camera), and ISO speed. The camera automatically sets the shutter speed and aperture (f-number) based on the scene lighting. Program mode offers the ease of auto shooting with full access to all menu options. Use the Jog dial to select and adjust settings (see page 31). Press the Menu button to change other settings.

Use this mode	For
A Aperture Priority	Controlling the aperture, exposure compensation, flash compensation, and ISO speed. Aperture priority mode is primarily used to control depth of field (the range of sharpness). NOTE: The aperture setting may be affected when using optical zoom. Use the Jog dial to select and adjust settings (see page 31). Press the Menu button to change other settings.
S Shutter Priority	Controlling the shutter speed, exposure compensation, flash compensation, and ISO speed. The camera automatically sets the aperture for proper exposure. Shutter priority mode is primarily used to prevent blur when your subject is moving. To prevent camera shake, use a tripod for slow shutter speeds. Use the Jog dial to select and adjust settings (see page 31). Press the Menu button to change other settings.
M Manual	Enjoying the highest level of creative control. You can set the aperture, shutter speed, flash compensation, and ISO speed. Exposure compensation acts as an exposure meter, recommending the proper combination of aperture and shutter speed to produce an acceptable exposure. To prevent camera shake, use a tripod for slow shutter speeds. Use the Jog dial to select and adjust settings (see page 31). Press the Menu button to change other settings.
 Video	Capturing video with sound (see page 5).
 Favorites	Viewing your favorites (see page 48).





Scene modes

- 1 Turn the Mode dial to Scene **SCN**.
- 2 Press to select a Scene mode.

NOTE: If the Help text turns off, press the OK button.

- 3 Press the OK button to close the selection process.



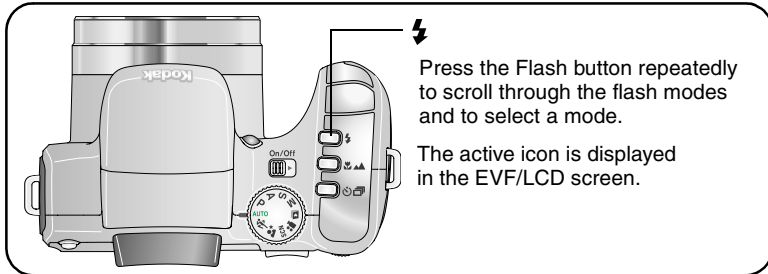

Use this SCN mode	For
	Portrait Full-frame portraits of people. Use telephoto to reduce focus of distracting backgrounds.
	Landscape Distant subjects. Flash does not fire unless you turn it on. Auto-focus framing marks (page 8) are not available in Landscape.
	Night Landscape Distant scenery at night. Flash does not fire. Place the camera on a flat, steady surface or use a tripod.
	Self-Portrait Close-ups of yourself. Assures proper focus and minimizes red eye.
	Flower Close-ups of flowers or other small subjects in bright light. Focus is set to Macro AF (page 26).
	Sunset Preserves the deep hues seen in sunsets.
	Backlight Subjects that are in shadow or "backlit" (when light is behind the subject).
	Candle light Captures the ambiance of candle light.
	Manner/Museum Quiet occasions, like a wedding or lecture. Flash and sound are disabled.
	Text Documents. Focus is set to Macro AF (page 26).

Use this SCN mode	For
	Beach Bright beach scenes.
	Snow Bright snow scenes.
	Fireworks Flash does not fire. Place the camera on a flat, steady surface or use a tripod.
	Children Action pictures of children in bright light.

Changing the flash settings



NOTE: Flash settings are pre-set for each picture-taking mode. Some of the flash settings may not be available in all Capture or Scene modes. When you change to Auto or Red-eye in some of these modes, it becomes the default until you change it.

Flash modes	Flash fires
 Auto Flash	When the lighting conditions require it.
 Fill	Every time you take a picture, regardless of the lighting conditions. Use when the subject is in shadow or is "backlit" (when the light is behind the subject). In low light, hold the camera steady or use a tripod.
 Red-eye	The flash fires once so the eyes become accustomed to the flash, then fires again when the picture is taken.
 Off	Never.

Flash-icon behavior

When  blinks, the flash is charging.
Take a picture when the icon stops blinking.

Using the focus button

Set the focus for close-up and far-away scenes. Some settings may be unavailable in some modes.

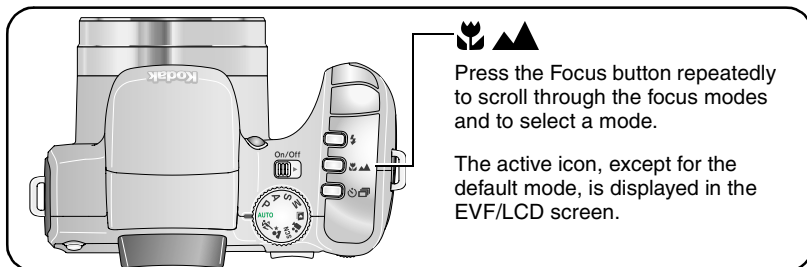





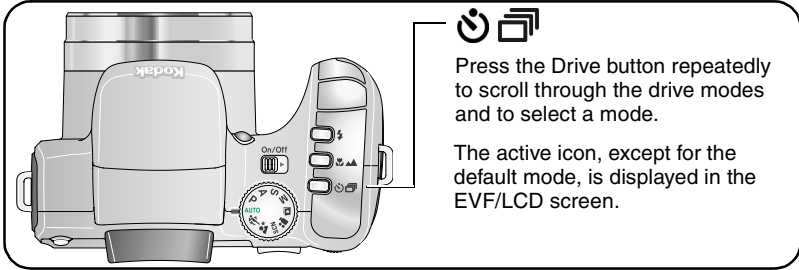

Focus mode		Description
	Normal AF (default)	Focus setting for general picture-taking: 1.6 ft. (0.5 m)–infinity @ wide 3.9 ft. (1.2 m)–infinity @ tele
	Macro AF	Sharpness and detail in pictures at close range. Use available light instead of flash, if possible. The close-up distance: Macro wide: 4.7 in.–24 in. (12 cm–60 cm) Macro tele: 24 in.–4.3 ft. (60 cm–1.3 m)
	Infinity AF	Distant subjects. Auto-focus framing marks are unavailable in Focus Landscape.
	Manual	Focus is at center position. A magnified image appears on the screen when using the Joystick ◀/▶ to set the focus adjustment. A graphic shows the approximate degree of focus.

Using self-timer, burst, and exposure bracketing

Some settings may be unavailable in some modes.



Drive mode	Description
 Single (default)	Camera takes one picture.
 Self-timer (10-second delay)	Time to get yourself into the picture. Place camera on a tripod or flat surface.
 Self-timer (2-second delay)	Allows for a steady, auto-shutter release on a tripod.
 Self-timer (2 pictures)	Capture 2 shots (one picture taken after 10 seconds and another picture taken 8 seconds later).
 First Burst Flash forced off.	Camera takes up to 8 pictures (2 per second) while the Shutter button is held. The first 8 are saved. (Capture an expected event e.g., a person swinging a golf club.)
 Last Burst Flash forced off.	Camera takes up to 30 pictures (2 per second up to 15 seconds) while the Shutter button is held. When the shutter button is released, only the last 8 pictures are saved. (Capture an event when the precise timing is uncertain e.g., a child blowing out birthday candles.)

	Exposure Bracketing 3 Flash forced off.	Camera takes 3 pictures at a selected interval of 1/3, 2/3, or 1.0 EV. Determine the best exposure level for your conditions based on your evaluation of 3 pictures.
---	---	--

- 1 Set the Drive button to the desired option, [page 27](#).
- 2 Press the Shutter button **halfway** to set the AF/AE.
- 3 For all settings, except Burst, press the Shutter button **completely down** and release it to take the picture.

For Burst settings, press the Shutter button **completely down and hold it**. The camera stops taking pictures when you release the Shutter button, all pictures are taken, or there is no more storage space.

NOTE: To cancel self-timer and shutter delay during countdown, press the Shutter button again. (The setting remains on.)

NOTE: During quickview you can delete all pictures in the burst series. To delete selectively, do so in Review (see [page 14](#)).

Using the histogram to view picture brightness

Use the histogram in Capture or Review to evaluate the distribution of light before or after you take a picture. If the peak is to the right of the graph, the subject is bright; if the peak is to the left, the subject is dark. Optimal exposure is achieved when the peak is in the middle of the histogram. Available only in PASM modes.

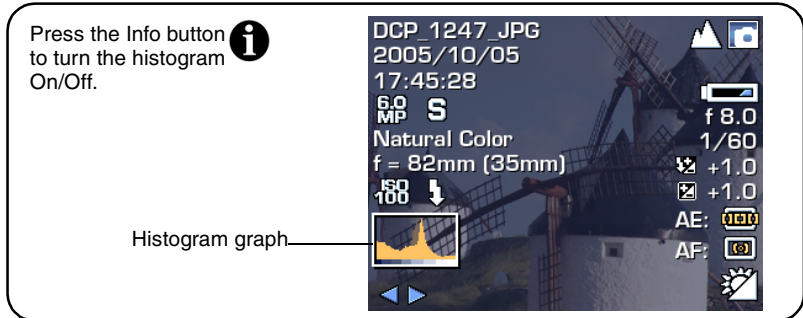

NOTE: If a scene is dark or light, you can adjust the exposure compensation before taking the picture. The flash may affect a picture's light and shadow.

Using exposure compensation with exposure bracketing

In PASM modes, you can use exposure compensation in conjunction with exposure bracketing.

If exposure compensation is set to	And if the exposure bracketing interval is set to	Then the exposures taken are
0.0	the default +/-0.3	-0.3, 0.0, +0.3
+1.0		+0.7, +1.0, +1.3
-1.0		-1.3, -1.0, -0.7

PASM modes

Settings you change in P, A, S, or M modes apply only to pictures taken in those modes.

For example, if you change the Color Mode to Sepia while in P, A, S, or M mode, you still retain the default setting of Color for Auto and SCN modes.

NOTE: The settings, including Flash, are maintained for P, A, S, and M modes—even when you change modes or turn off the camera. Use Reset Camera (see table on [page 36](#)) to reset P, A, S, or M to its default setting.

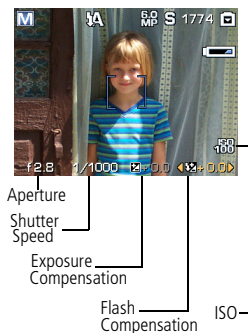

Aperture—also known as f-stop or f-number, controls the size of the lens opening, which determines the depth of field. Smaller f-numbers, for example f/2.8, refer to a bigger lens opening. Larger f-numbers, for example f/8, refer to a smaller lens opening. Larger f-numbers keep the main subject sharp; good for landscapes and well-lit conditions. Smaller f-numbers are good for portraits and low-light conditions. The highest and lowest aperture numbers may be affected by optical zoom.

Shutter Speed—controls how long the shutter stays open. A shaking hand icon  warns of slow shutter speeds. (Use a tripod for slow shutter speeds.)

Exposure Compensation—lets you manually adjust the exposure (± 2.0 in $1/3$ steps); good for controlling backlit or non-standard scenes. If the picture is too light, decrease the setting; if it's too dark, increase the setting.

Flash Compensation—controls the flash brightness (± 1.0 in $1/2$ steps). You must be within flash range. Unavailable if flash setting is Off.

ISO—controls sensitivity of the camera sensor (80, 100, 200, 400, 800). Higher settings are more sensitive to light, but may produce unwanted "noise" in a picture. You can only use ISO 800 if you are in the 1.1 MP Picture Size setting.

Changing PASM mode settings

The PASM modes control the aperture (f-number), shutter speed, exposure and flash compensations, and ISO. Use the Menu button to control all other settings.

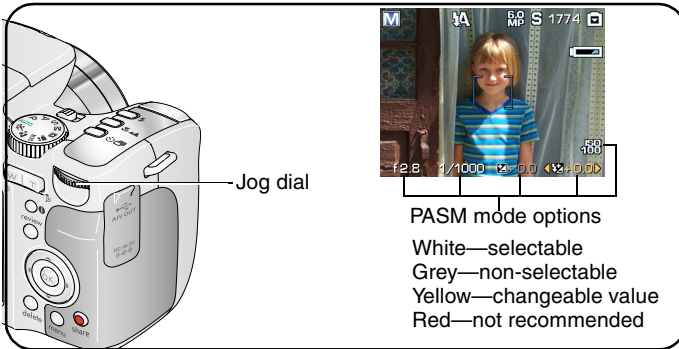

- 1 Turn the Mode dial to P, A, S, or M.

The mode settings are displayed.

NOTE: The settings for each mode may be different.

- 2 Use the Jog dial:

- Rotate to move between the available settings.
- Press to open a setting.
- Rotate to change the setting.
- Press to save the setting.



- 3 Press the Menu button to change other settings.



- 4 Take a picture.







Changing picture-taking settings





You can change settings to get the best results from your camera:

- 1 Press the Menu button. (Some settings are unavailable in some modes.)
- 2 Press ▲/▼ to highlight the setting you wish to change, then press the OK button.
- 3 Choose an option, then press the OK button.
- 4 Press the Menu button to exit.

Setting	Icon	Options
<p>Picture Size Choose a picture resolution. <i>This setting remains until you change it.</i></p>		<p>6.0 MP (default)—for printing up to 20 x 30 in. (51 x 76 cm); pictures are highest resolution and largest file size.</p> <p>5.3. MP (3:2)— ideal for printing 4 x 6 in. (10 x 15 cm) prints without cropping. Also for printing up to 20 x 30 in. (51 x 76 cm).</p> <p>4.0 MP— for printing up to 11 x 14 in. (28 x 36 cm); pictures are medium resolution with smaller file size.</p> <p>3.1 MP—for printing up to 8 x 10 in. (20 x 25 cm); pictures are medium resolution with smaller file size.</p> <p>1.1 MP—for printing 4 x 6 in. (10 x 15 cm) prints, emailing, Internet, screen display, or for conserving space.</p>
<p>Compression Choose a compression. <i>This setting remains until you change it.</i></p>		<p>Fine—take higher quality pictures.</p> <p>Standard (default)—take standard quality pictures.</p> <p>Basic—take more pictures.</p> <p>See Storage capacities on page 65.</p>
<p>Video Size Choose a video resolution. <i>This setting remains until you change it.</i></p>		<p>640 x 480 (default)—higher resolution and file size. Video plays in a 640 x 480 pixel window (VGA).</p> <p>320 x 240—lower resolution and file size. Video plays in a 320 x 240 pixel window (QVGA).</p>

Setting	Icon	Options
<p>Video Length Choose video record length. <i>This setting remains until you turn the Mode dial or turn off the camera.</i></p>		<p>Continuous (default) 5 seconds 15 seconds 30 seconds NOTE: Maximum recording time at Continuous is 80 minutes.</p>
<p>White Balance Choose your lighting condition to reproduce colors more accurately. Only available in PASM modes.</p>		<p>Auto (default)—automatically corrects white balance. Ideal for general picture taking. Daylight—for pictures in natural lighting. Tungsten—corrects the orange cast of household light bulbs. Ideal for indoor pictures under tungsten or halogen lighting without flash. Fluorescent—corrects the green cast of fluorescent lighting. Ideal for indoor pictures under fluorescent lighting without flash. Open shade—for pictures in the shade in natural lighting.</p>
<p>Exposure Bracketing Interval <i>This setting remains until you change it or take pictures.</i> Only available in PASM modes.</p>		<p>+/- 0.3 (default) +/- 0.7 +/- 1.0 See page 27.</p>





Setting	Icon	Options
<p>Exposure Metering Evaluate light levels at specific areas of a scene. Only available in PASM modes.</p>		<p>Multi-pattern (default)—evaluates lighting conditions throughout the image to give an optimum picture exposure. Ideal for general picture taking.</p> <p>Center-weighted—evaluates the lighting conditions of the subject centered in the viewfinder. Ideal for backlit subjects.</p> <p>Spot—similar to Center-weight, except the metering is concentrated on a smaller area of the subject centered in the viewfinder. If used with Selectable AF zones, the exposure spot follows the focus zone. Ideal when you need an exact exposure of a specific area in the picture.</p>
<p>AF Zone Select a large or concentrated area of focus. Only available in PASM modes.</p>		<p>Multi-zone AF (default)—evaluates zones to give an even picture focus. Ideal for general picture taking.</p> <p>Center-zone AF—evaluates the small area centered in the viewfinder. Ideal when precise focus of a specific area in the picture is needed.</p> <p>Selectable-zone AF—use  /  /  /  to move the focus brackets to any focus zones.</p> <p>NOTE: For the best pictures, the camera is set to Multi-zone when in Landscape mode.</p>
<p>AF Control Choose an auto-focus setting. <i>This setting remains until you change it.</i></p>		<p>Continuous AF (default)—camera continuously adjusts to keep the picture in focus. There is no need to press the Shutter button halfway down to focus. This option uses the most battery power.</p> <p>Single AF—minimizes camera noise. Camera is only in focus when the Shutter button is pressed halfway down. This option uses less battery power.</p>







Setting	Icon	Options
<p>Color Mode Choose color tones. <i>This setting remains until you turn the Mode dial or turn off the camera.</i> Unavailable in Video mode.</p>		<p>High Color Natural Color (default) Low Color Black & White Sepia—for pictures with a reddish-brown, antique look. NOTE: EasyShare software also lets you change a color picture to black-and-white or sepia.</p>
<p>Sharpness Control picture sharpness. <i>This setting remains until you change it.</i> Only available in PASM modes.</p>		<p>High Normal (default) Low</p>
<p>Set Album (Still, Video) Choose Album names. <i>This setting remains until you change it. You can apply different Set Album choices.</i></p>		<p>On Off (default) Pre-select album names before you take pictures or videos. Then, all the pictures or videos you take are tagged with those album names. See page 45.</p>
<p>Image Storage Choose a storage location for pictures and videos. <i>This setting remains until you change it.</i></p>		<p>Auto (default)—the camera uses the card if one is in the camera. If not, the camera uses internal memory. Internal Memory—the camera always uses internal memory, even if a card is installed.</p>
<p>Setup Menu Choose additional settings.</p>		See Customizing your camera (page 36).







Customizing your camera



Use Setup to customize your camera settings.

- 1 In any mode, press the Menu button.
- 2 Press $\blacktriangle/\blacktriangledown$ to highlight Setup , then press the OK button.
- 3 Press $\blacktriangle/\blacktriangledown$ to highlight the setting you wish to change, then press the OK button.
- 4 Choose an option, then press the OK button.
- 5 Press the Menu button to exit.

Setting	Icon	Options
Return to previous menu.		
LCD Brightness Adjust the brightness of the LCD screen.		Normal (default) High
Capture Frame Grid Use the frame grid to compose a picture. The grid divides the LCD screen into thirds—vertically and horizontally. It's helpful if you want to balance a picture between water, earth, and sky.		On Off (default)
Image Stabilizer The optical image stabilization helps to minimize hand movement to ensure sharp, clear results for still and video picture-taking.		Continuous (default) —image stabilization is continuously on. Single —image stabilization activates when the Shutter button is pressed halfway. Off —setting is off.

Setting	Icon	Options
Date Stamp Imprint the date on pictures.		Choose a date option, or turn off the feature. (Default is off.)
Quickview Change Quickview default to on or off (see page 7).		On (default) Off
Advanced Digital Zoom Choose how digital zoom is employed.		Continuous —no pause between optical and digital zoom. Pause —after reaching 12X optical zoom, release the zoom button, then activate it again to begin digital zoom. None (default) —digital zoom is disabled.
Orientation Sensor Orient pictures so that they are displayed with the correct side up.		On (default) Off On Transfer —sets Orientation Sensor on camera LCD to Off. When picture is transferred to the computer, it is rotated to the proper orientation.
Camera Sounds Choose an overall theme or individual sounds.		Theme (default) —overall. Power On Focus Lock Shutter Self-timer Error
Sound Volume Turn off all sounds, or choose a volume level.		Off Low (default) Medium High
Date & Time		See page 4 .

Setting	Icon	Options
Auto Power-Off Select when you would like the camera to turn off.		1, 3 (default), 5, or 10 minutes
Video Out Choose the regional setting that lets you connect the camera to a television or other external device.		NTSC (default) —used in North America and Japan; most common format. PAL —used in Europe and China.
Video Date Display Display Date/Time at the start of video playback.		On (default) — choose from 3 date formats. Off
Mode Description Display mode description at camera start-up or mode change.		On (default) Off
Print Warning		Pause (default) —when the blue slider on the zoom indicator pauses during digital zoom, release the zoom lever and reactivate it. The slider turns red when the picture may no longer render an acceptable 4 x 6 in. (10 x 15 cm) print. None —no pause.
Language Choose a language.		See page 4 .
Reset Camera Reset all picture-taking settings to the camera defaults.		Reset

Setting	Icon	Options
Format  CAUTION: Formatting deletes all pictures and videos, including those that are protected. Removing a card during formatting may damage the card.		Memory Card —deletes everything on the card; formats the card. Cancel —exits without making a change. Internal Memory —deletes everything in internal memory including email addresses, album names, and favorites; formats the internal memory.
About View camera information.		Camera name and firmware version.

Viewing picture/video information

In Review mode, press the Info button to view the settings.

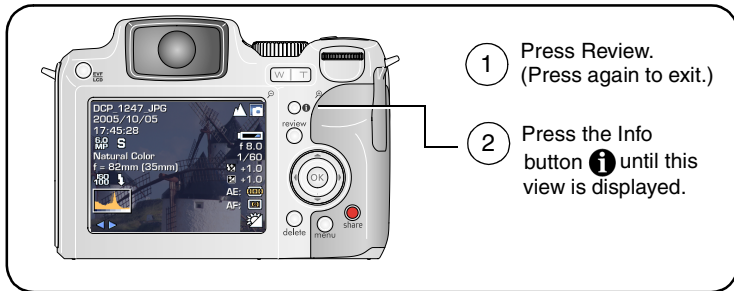

Copying pictures and videos

You can copy pictures and videos from a memory card to internal memory or from internal memory to a memory card.

Before you copy, make sure that:

- A card is inserted in the camera.
- The camera's picture storage location is set to the location **from** which you are copying. See Image Storage, table on [page 32](#).

Copy pictures or videos:

- 1 Press the Review button, then press the Menu button.
- 2 Press **▲/▼** to highlight Copy, then press the OK button.
- 3 Press **▲/▼** to highlight an option:

PICTURE or VIDEO—copies the current picture or video.

EXIT—returns to the Review menu.

ALL—copies all pictures and videos from your selected storage location to the other location.

- 4 Press the OK button.

NOTE: Pictures and videos are copied, not moved. To remove pictures and from the original location after copying, delete them (see [page 14](#)).

Tags that you applied for print, email, and favorites are not copied. Protection settings are not copied. To apply protection to a picture or video, see [page 14](#).

Making a video action print or picture

Video action picture

From a video, you can make a 4-, 9-, or 16-up picture. The picture is suitable for a 4 x 6-inch (10 x 15 cm) print.

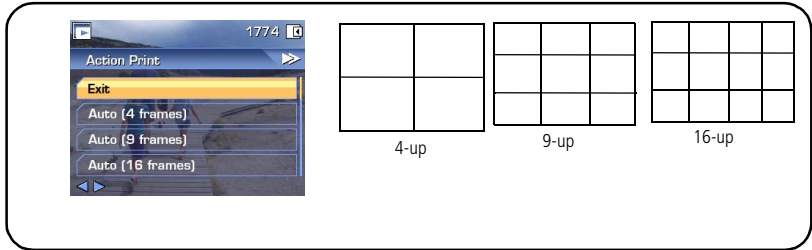

- 1 Press the Review button, then press ◀/▶ to locate a video.
- 2 Press the Menu button, choose Action Print, then press the OK button.
- 3 Choose an option, then press OK.

Option	Video frames
Auto (4, 9, or 16 Frames); default 9	4, 9, or 16 frames are automatically selected (first, last, and 2, 7, or 14 equally spaced frames).

- 4 Follow the screen prompts.
A multi-up picture is created. The original video is saved.
- 5 Press the Menu button to exit the menu.

Video picture

You can make a still picture from a single frame of a video. There may be limitations to the size you can print because of the small picture size (much smaller than minimum picture size).

- 1 Press the Review button, then press ◀/▶ to locate a video.
- 2 Press the Menu button, choose Make Picture, then press the OK button.

The original video is saved.

- 3 Follow the screen prompts.
- 4 Press the Menu button to exit the menu.

Using Kodak Perfect Touch technology

Kodak Perfect Touch technology helps ensure better, brighter pictures.



- 1 Press Review.
- 2 ◀/▶ for previous/next picture.
- 3 Press Menu, choose Perfect Touch tech, then press OK.
The enhancement is previewed in a split screen.
Press ◀/▶ to view other parts of the picture.
- 4 Follow the screen prompts to apply or discard the enhancement.

The picture is copied, then enhanced. (The original picture is saved.) An enhanced picture cannot be enhanced again on the camera. Kodak Perfect Touch technology can only be used with pictures, not video.

Press the Menu button to exit the menu.

Cropping pictures

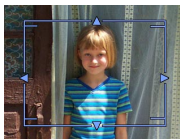
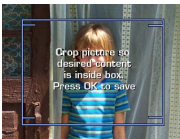

- 1 Press Review.
- 2 ◀/▶ for previous/next picture.
- 3 Press Menu, select Crop, then press OK.
- 4 Press the Zoom lever to adjust the size.
◀/▶ ▲/▼ to adjust the position.
- 5 Press OK to save the cropped picture.
- 6 Press Menu to exit the menu.

The picture is copied, then cropped. (The original picture is saved.) A cropped picture cannot be cropped again on the camera.

Running a slide show

Use the Slide Show to display your pictures and videos on the LCD screen. To run a slide show on a television or on any external device, see [page 45](#). To save battery power, use an optional Kodak 3-volt AC adapter. (Visit www.kodak.com/go/z612accessories.)

Starting the slide show

- 1 Press the Review button, then press the Menu button.
- 2 Press $\blacktriangle/\blacktriangledown$ to highlight Slide Show, then press the OK button.
- 3 Press $\blacktriangle/\blacktriangledown$ to highlight Begin Show, then press the OK button.

Each picture and video is displayed once.

To interrupt the Slide Show, press the OK button.

Changing the slide show display interval

The default interval setting displays each picture for 5 seconds. You can set the display interval from 3 to 60 seconds.

- 1 On the Slide Show menu, press $\blacktriangle/\blacktriangledown$ to highlight Interval, then press the OK button.
- 2 Select a display interval.
To scroll through the seconds quickly, press and hold $\blacktriangle/\blacktriangledown$.
- 3 Press the OK button.

The interval setting remains until you change it.

Running a continuous slide show loop

When you turn on Loop, the slide show is continuously repeated.

- 1 On the Slide Show menu, press ▲/▼ to highlight Loop, then press the OK button.
- 2 Press ▲/▼ to highlight On, then press the OK button.

The slide show repeats until you press the OK button or until battery power is exhausted. The Loop feature remains until you change it.

Displaying pictures and videos on a television

You can display pictures and videos on a television, computer monitor, or any device equipped with a video input. (Image quality on a television screen may not be as good as on a computer monitor or when printed.)

NOTE: Ensure that the Video Out setting (NTSC or PAL) is correct (see table on [page 36](#)). The slide show stops if you connect or disconnect the cable while the slide show is running.

- 1 Connect an audio/video cable from the camera USB, A/V Out port to the television video-in port (yellow) and audio-in port (white). See your television user's guide for details.
- 2 Review pictures and videos on the television.

Pre-tagging for album names

Use the Set Album (Still or Video) feature to pre-select album names before you take pictures or videos. Then, all the pictures or videos you take are tagged with those album names.

First—on your computer

Use Kodak EasyShare software that came with your camera to create album names on your computer. Then copy up to 32 album names to the album name list the next time you connect the camera to the computer. See Kodak EasyShare software Help for details.

Second—on your camera

- 1 In any mode, press the Menu button.
- 2 Press ▲/▼ to highlight Set Album, then press the OK button.
- 3 Press ▲/▼ to highlight an album name, then press the OK button. Repeat to choose more than one album, if desired.

Selected albums are noted with a check mark.

- 4 To remove a selection, highlight an album name and press the OK button. To remove all album selections, select Clear All.
- 5 Highlight Exit, then press the OK button.

Your selections are saved. If you turn on the LCD screen, your album selection is displayed on the screen. A plus (+) after the album name means more than one album is selected.

- 6 Press the Menu button to exit the menu.

Third—transfer to your computer

When you transfer the tagged pictures or videos to your computer, Kodak EasyShare software opens and categorizes your pictures in the appropriate album. See the Kodak EasyShare software Help for details.

Tagging pictures/videos for albums

Use the Album feature in Review mode to tag the pictures and videos in your camera with album names.

First—on your computer

Use Kodak EasyShare software that came with your camera to create album names on your computer, then copy up to 32 album names to the camera's internal memory. See Kodak EasyShare software Help for details.

Second—on your camera

- 1 Press the Review button, then locate the picture or video.
- 2 Press the Menu button.
- 3 Press $\blacktriangle/\blacktriangledown$ to highlight Album, then press the OK button.
- 4 Press $\blacktriangle/\blacktriangledown$ to highlight an album, then press the OK button.

To add other pictures to the same album, press $\blacktriangle/\blacktriangledown$ to scroll through the pictures. When the picture you want is displayed, press the OK button.

To add the pictures to more than one album, repeat step 4 for each album.

The album name appears with the picture. A plus (+) after the album name means the picture was added to more than one album.

To remove a selection, highlight an album name and press the OK button. To remove all album selections, select Clear All.

- 5 Press $\blacktriangle/\blacktriangledown$ to highlight Exit, then press the OK button.



Third—transfer to your computer

When you transfer the tagged pictures and videos to your computer, the Kodak EasyShare software opens and categorizes your pictures and videos in the appropriate album folder. See Kodak EasyShare software Help for details.

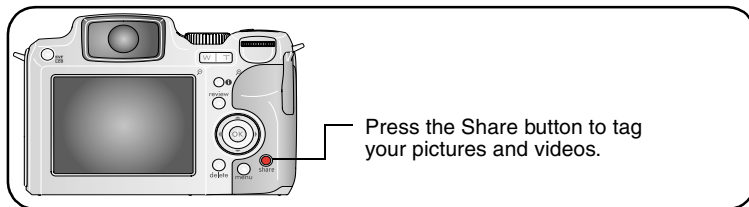
Sharing your pictures



When they are transferred to your computer, you can share them by:







-  Print ([page 49](#))
-  Email ([page 49](#))
-  Favorites ([page 50](#))

When can I tag my pictures and videos?





Press the Share button to tag pictures/videos:

- Any time. (The most recent picture/video taken is then displayed.)
- Just after you take a picture/video, during Quickview (see [page 7](#)).
- After pressing the Review button (see [page 9](#)).

Tagging pictures for printing

- 1 Press the Share button. Press   to locate a picture.
- 2 Press   to highlight Print, then press the OK button.*
- 3 Press   to select the number of copies (0-99). Zero (0) removes the tag for that picture.

The icon appears at the top of the screen. The default quantity is one.

- 4 **Optional** (for single picture): You can apply a print quantity to other pictures. Press   to locate a picture. Keep the print quantity as is, or   to change it. Repeat this step until the desired print quantity is applied to the pictures.

5 Press the OK button. Then press the Share button to exit the menu.

* To remove print tagging for all pictures in the storage location, highlight Cancel Prints, then press the OK button. Cancel Prints is not available in Quickview.

Printing tagged pictures

When you transfer the tagged pictures to your computer, the Kodak EasyShare software print screen opens. For details on printing, click the Help button in the Kodak EasyShare software.

For more information on printing from your computer, printer dock, PictBridge enabled printer, or card, see [page 17](#).

NOTE: For the best 4 x 6 in. (10 x 15 cm) prints, set the camera to the 5.3 MP (3:2) print Picture Size (see table, [page 32](#)).

Tagging pictures and videos for emailing

First—on your computer

Use Kodak EasyShare software to create an email address book on your computer. Then, copy up to 32 email addresses to the camera's internal memory. For details, click the Help button in the Kodak EasyShare software.

Second—tag pictures/videos on your camera

- 1 Press the Share button. Press **◀/▶** to locate a picture/video.
- 2 Press **▲/▼** to highlight Email, then press the OK button.
- 3 Press **▲/▼** to highlight an email address, then press the OK button. Press OK again to deselect.

If you tagged a single picture/video, you can tag other pictures/videos with the same address. Press **◀/▶** to scroll through them. When the picture you want is displayed, press OK.

To send the pictures/videos to more than one address, repeat step 3 for each address.

Selected addresses are checked.

- 4 To remove a selection, highlight a checked address and press the OK button. To remove all email selections, highlight Clear All.
- 5 Press ▲/▼ to highlight Exit, then press the OK button.
The Email icon appears in the status area.
- 6 Press the Share button to exit the menu.

Third—transfer and email

When you transfer the tagged pictures/videos to your computer, the Email screen opens and lets you send them to the addresses you specified. For details, click the Help button in the Kodak EasyShare software.

Tagging pictures as favorites

You can preserve your favorite pictures in the Favorites  section of your camera's internal memory, then share them with friends and family.

NOTE: When you transfer pictures from your camera to your computer, all pictures (including favorites) are stored on your computer at full size. Favorite pictures—smaller copies of your originals—are loaded back to your camera, so you can share and enjoy more.

Share your favorite pictures in 4 easy steps:

1. Take pictures



2. Tag pictures as favorites



- 1 Press the Share button. Press ◀/▶ to locate a picture.
- 2 Press ▲/▼ to highlight Favorite, then press the OK button.





The Favorite icon appears in the status area. To remove the tag, press the OK button again.

<p>3. Transfer pictures to your computer</p>	<p>1 To enjoy full functionality, install and use the EasyShare software that was packaged with this camera. (See page 15.)</p> <p>2 Connect the camera to the computer using the USB cable (see page 16) or an EasyShare dock.</p> <p><i>The first time you transfer pictures, the software helps you make choices about your favorite pictures. Then, your pictures are transferred to the computer. Favorite pictures (smaller versions of the originals) are loaded to the Favorites section of your camera's internal memory.</i></p>
<p>4. View favorites on your camera</p> 	<p>1 Turn the Mode dial to Favorites.</p> <p>2 Press ◀/▶ to scroll through favorites.</p> <p>To exit Favorites mode, turn the Mode dial to any other position.</p>

NOTE: The camera holds a limited number of favorites. Use Camera Favorites in the EasyShare software to customize the size of your camera Favorites section. Videos tagged as favorites remain in the Favorites folder in the EasyShare software. For more information, click the Help button in the Kodak EasyShare software.

Optional favorite settings

In Favorites mode, press the Menu button to access optional settings.

	<p>Slide Show (page 44)</p>		<p>Remove all favorites (page 52)</p>
	<p>Multi-up (page 7)</p>		<p>Setup Menu (page 36)</p>

NOTE: Pictures taken at the 5.3 MP (3:2) picture size are displayed at a 3:2 aspect ratio with a black bar at the top and bottom of the screen. (See table for Picture Size, [page 32](#).)

Removing all favorites from your camera

When you remove favorites from your camera, you increase the storage capacity in the internal memory. This lets you take more pictures.

- 1 Turn the Mode dial to Favorites .
- 2 Press the Menu button.
- 3 Highlight Remove favorites, then press the OK button.

All pictures stored in the Favorites section of internal memory are removed. Favorites are restored the next time you transfer pictures to the computer.





- 4 Press the Menu button to exit the menu.

Preventing favorites from transferring to the camera

- 1 Open the Kodak EasyShare software. Click the My Collection tab.
- 2 Go to the Albums view.
- 3 Click the Camera Favorites Album for your camera.
- 4 Click Remove Album. (The original pictures remain unchanged.)

The next time you transfer pictures from your camera to the computer, use the Camera Favorites Wizard/Assistant to either recreate your Camera Favorites Album or to turn off the Camera Favorites feature.

Printing favorites

- 1 Turn the Mode dial to Favorites . Press /  to locate a picture.
- 2 Press the Share button.
- 3 Highlight Print, then press the OK button.
- 4 Press /  to highlight Print quantity, then press the OK button.

The icon appears in the status area.

NOTE: Favorites that were taken on this camera (not imported from another source) can make prints up to 4 x 6 in. (10 x 15 cm).

Emailing favorites

- 1 Turn the Mode dial to Favorites. Press ◀/▶ to locate a picture.
- 2 Press the Share button.
- 3 Highlight Email, then press the OK button.
- 4 Press ▲/▼ to highlight one or more addresses, then press the OK button.
- 5 To remove a selection, highlight a checked address and press the OK button. To remove all email selections, highlight Clear All.
- 6 Press ▲/▼ to highlight Exit, then press the OK button.
The Email icon appears in the status area.
- 7 Press the Share button to exit the menu.

5

Troubleshooting

Camera problems

For step-by-step product support, visit www.kodak.com/go/z612support and select Interactive Troubleshooting and Repairs.

If...	Try one or more of the following
Camera does not turn on	<ul style="list-style-type: none"> ■ Remove battery and verify that it's the correct type, then reinsert it. ■ Insert a new or charged battery.
Camera does not turn off and the lens does not retract	<ul style="list-style-type: none"> ■ Connect the camera to a Kodak 3-volt AC adapter (sold separately), then try again. See page 70 for more battery information.
Camera buttons and controls do not function	
Lens does not extend when camera turns on or does not retract	<ul style="list-style-type: none"> ■ Confirm that the battery in camera is charged. ■ Turn camera off, then on again. (Lens does not extend in Favorites mode.) ■ If problem still exists, get help (page 60).
In Review, a blue or black screen is displayed instead of a picture	<ul style="list-style-type: none"> ■ Transfer the picture to the computer. ■ Transfer <i>all</i> pictures to the computer (page 16). ■ Take another picture. If problem still continues try internal memory and/or another memory card.
Pictures remaining number does not decrease after taking a picture	<ul style="list-style-type: none"> ■ Continue taking pictures. The camera is operating normally. (The camera estimates the number of pictures remaining after each picture is taken, based on picture size and content.)
Flash does not fire	<ul style="list-style-type: none"> ■ Check the flash setting and change as needed (page 25). <p>NOTE: The flash does not fire in all modes.</p>

If...	Try one or more of the following
Storage location is almost or entirely full	<ul style="list-style-type: none"> ■ Delete some or all pictures and videos in the storage location (page 14). ■ Transfer pictures and videos to the computer (page 16), then delete pictures and videos in the storage location (page 14). ■ Insert a memory card (page 4), then change the image storage location, if necessary (see table on page 32).
Battery life is short	<ul style="list-style-type: none"> ■ Make sure the correct battery type is loaded (page 2). ■ Wipe the contacts with a clean, dry cloth (page 69) before inserting a battery in the camera. ■ Insert a new or charged battery (page 2).
You cannot take a picture	<ul style="list-style-type: none"> ■ Turn the camera off, then on again. Make sure the camera is not in Favorites mode. ■ Depress shutter button completely down (page 5). ■ Insert a new or charged battery (page 2). ■ Memory full. Transfer pictures to the computer (page 16), delete pictures from the camera (page 14), change image storage location, or insert a new card. ■ Wait until processing or saving function e.g., bursts, video, edits, formatting, and deleting is complete
Error message appears on EVF/LCD screen	<ul style="list-style-type: none"> ■ Turn the camera off. ■ Remove memory card from the camera. ■ Remove the battery and wipe the contacts with a clean, dry cloth (page 71). ■ Insert a new or charged battery (page 2). ■ If all else fails, get customer support help (page 59).
Memory card not recognized or camera freezes with card.	<ul style="list-style-type: none"> ■ Card may be corrupted. Format card in camera (see table on page 36). ■ Use another memory card.

Computer/connectivity problems

If...	Try one or more of the following
Computer does not communicate with the camera	<ul style="list-style-type: none"> ■ Insert a charged battery (page 2). ■ Turn on the camera. ■ Make sure proper USB cable is securely connected on camera and computer port (page 16). (If using an EasyShare dock, check all cable connections. Make sure the camera is seated on the dock.) ■ Make sure the EasyShare software is installed (page 15).
Pictures do not transfer to computer	<ul style="list-style-type: none"> ■ Click the Help button in the EasyShare software.
Slide Show does not run on an external video device	<ul style="list-style-type: none"> ■ Adjust the camera Video Out setting (NTSC or PAL, see table on page 36). ■ Make sure the external device settings are correct (see the device's user's guide).

Picture quality problems

If...	Try one or more of the following
Picture is too dark or underexposed	<ul style="list-style-type: none"> ■ Reposition camera for more available light. ■ Use Fill flash (page 25) or change your position so light is not behind the subject. ■ Move so that the distance between you and the subject is within the effective flash range (page 13). ■ To automatically set exposure and focus, press the Shutter button halfway. When the AF/AE indicator is green, press the Shutter button completely down to take the picture. ■ Use P mode to adjust the exposure compensation (page 30).

If...	Try one or more of the following
Picture is too light or overexposed	<ul style="list-style-type: none"> ■ Reposition camera to reduce the amount of available light. ■ Turn flash off (page 13). ■ Move so that the distance between you and the subject is within the effective flash range (page 13). ■ To automatically set exposure and focus, press the Shutter button halfway. When the AF/AE indicator is green, press the Shutter button completely down to take the picture. ■ Use P mode to adjust the exposure compensation.
Picture is not clear	<ul style="list-style-type: none"> ■ To automatically set exposure and focus, press the Shutter button halfway. When the AF/AE indicator is green, press the Shutter button completely down to take the picture. ■ Clean the lens (page 71). ■ Make sure camera is not in Macro AF mode if you are more than 24 in. (61 cm) from your subject. ■ Place the camera on a flat, steady surface or use a tripod, especially in high-zoom settings or in low light.

Mode-dial-light indicator status

If...	Try one or more of the following
Mode dial light does not turn on and the camera does not work	<ul style="list-style-type: none"> ■ Turn on the camera (page 3). ■ Recharge the battery or install a new one (page 2). ■ Camera may have turned off automatically. Turn on the camera and change the auto power-off setting (see page 36).
Mode dial light blinks	<ul style="list-style-type: none"> ■ Picture is being processed and saved to the camera. Camera is operating normally. ■ Camera is connected. Camera is operating normally. ■ Recharge the battery or install a new one (page 2).
Mode dial light glows steady	<ul style="list-style-type: none"> ■ Shutter button is pressed halfway down. Focus and exposure are set. Camera is operating normally. ■ Camera is operating normally.

Direct printing (PictBridge) problems

Status	Solution
Cannot locate desired picture.	■ Use the Direct printing menu to change the image storage location to locate the picture.
The Direct printing menu interface turns off.	■ Press any button to redisplay the menu.
Cannot print pictures.	■ Ensure that there is a connection between camera and printer (page 17). ■ Ensure the printer and camera have power (page 17).
Camera or printer display an error message.	■ Follow the prompts to resolve the issue.

6

Getting help

Helpful links

Camera	Email, write, or phone Kodak	www.kodak.com/go/contact
	Get support for your product (FAQs, troubleshooting information, arrange for repairs, etc.)	www.kodak.com/go/z612support
	Purchase camera accessories (camera docks, printer docks, lenses, cards, etc.)	www.kodak.com/go/z612accessories
	Download the latest camera firmware and software	www.kodak.com/go/z612downloads
	See online demonstrations of your camera	www.kodak.com/go/howto
Software	Get information on EasyShare software	www.kodak.com/go/easysharesw (or click the Help button in the EasyShare software)
	Get help with the Windows operating system and working with digital pictures	www.kodak.com/go/pcbasics
Other	Get support for other cameras, software, accessories, more	www.kodak.com/go/support
	Get information on Kodak EasyShare printer docks	www.kodak.com/go/printerdocks
	Get information on Kodak inkjet products	www.kodak.com/go/inkjet
	Optimize your printer for truer, more vibrant colors	www.kodak.com/go/onetouch
	Register your camera	www.kodak.com/go/register

Telephone customer support

If you have questions concerning the operation of the software or camera, you may speak with a customer support representative. Before you call, have the camera or dock connected to your computer. Be at your computer, and have the following information available:

- Computer model, Operating system
- Processor type and speed (MHz)
- Amount of memory (MB) & free hard disk space
- Camera serial number
- Version of Kodak EasyShare software
- Exact error message you received

Australia	1800 147 701	Greece	00800 441 25605	Singapore	800 6363 036
Austria	0179 567 357	Hong Kong	800 901 514	Spain	91 749 76 53
Belgium	02 713 14 45	India	91 22 617 5823	Sweden	08 587 704 21
Brazil	0800 150000	Italy	02 696 33452	Switzerland	01 838 53 51
Canada	1 800 465 6325	Japan	03 5540 9002	Taiwan	0800 096 868
China	800 820 6027	Korea	00798 631 0024	Thailand	001 800 631 0017
Denmark	3 848 71 30	Netherlands	020 346 9372	UK	0870 243 0270
Indonesia	001 803 631 0010	New Zealand	0800 440 786	US	1 800 235 6325
Ireland	01 407 3054	Norway	23 16 21 33	Outside US	585 726 7260
Finland	0800 1 17056	Philippines / Metro Manila	1 800 1 888 9600 / 632 6369600	International Toll Line	+44 131 458 6714
France	01 55 1740 77	Portugal	021 415 4125	International Toll Fax	+44 131 458 6962
Germany	069 5007 0035	Russia	007-(095)929-91-66		

Visit: <http://www.kodak.com/go/dfswwcontacts>

7

Appendix

Camera specifications

For more specifications, visit www.kodak.com/go/z612support.

Kodak EasyShare Z612 zoom digital camera	
CCD (charge-coupled device)	
CCD	1/2.5 in. CCD, 6.4 MP, 4:3 aspect ratio
Output image size	2832 x 2128 (6.0 MP) 2832 x 1888 (5.3 MP) (3:2) 2304 x 1728 (4.0 MP) 2048 x 1536 (3.1 MP) 1200 x 900 (1.1 MP)
Displays	
LCD Color display	2.5 in. (6.4 cm) color hybrid LCD, 230 K pixels; screen brightness adjustment
Color viewfinder— Electronic (EVF)	LCD and EVF not simultaneous; 202 K pixels
Preview/Review	Frame rate: 30 fps
Lens	
Taking lens (Optical zoom)	12X optical zoom, f/2.8–f/4.8 (35 mm equivalent: 35–420 mm)
Digital zoom	4.2X
Combined zoom	50X

Kodak EasyShare Z612 zoom digital camera	
Focus system	Auto-focusing, TTL-AF, Multi-zone AF, Center-zone AF, and Selectable-zone AF. Working range: Standard wide: 20 in. (0.5 m)–infinity Standard tele: 3.9 ft. (1.2 m)–infinity Macro wide: 4.7 in.–24 in. (12 cm–60 cm) Macro tele: 24 in.–4.3 ft. (60 cm–1.3 m)
Lens protection	Lens cap
Lens thread	Supported
Exposure	
Exposure metering	Modes: Multi-pattern, Center-weighted, Spot
Exposure compensation	+/-2.0 EV in 1/3 EV step
Exposure bracketing	1.0 EV in 1/3 EV step, 3 images
AE lock	Exposure is locked with focus when shutter button is pressed
Shutter speed	Mechanical and CCD electronic 16 to 1/1000 sec. in 1/3 stop increments
ISO speed	Auto: 80 to 160 Selectable: Auto, 80, 100, 200, 400, 800 (800 only available at 1.1 MP picture size)
Flash	
Electronic flash (auto flip-up)	Auto flash by pre-flash Working range @ ISO, Auto: 1.6–15.4 ft (0.5–4.7 m) @ Wide; 3.9–8.9 ft (1.2–2.7 m) @ Tele
Flash modes	Auto, Fill, Red-eye, Off
Flash compensation	+/-1.0 EV in 1/2 EV step
Guide No.	11 @ ISO 100
Capture	

Kodak EasyShare Z612 zoom digital camera	
Capture modes	Auto, Sport, Night Portrait, SCN (14), P, A, S, M & Video
Burst mode	First burst, last burst, minimum 2 fps
Video capture	VGA (640 x 480) @ 30 fps QVGA (320 x 240) @ 30 fps
Image file format	Still: format, EXIF 2.21 (JPEG compression); File organization, DCF Video: format, QuickTime; MPEG4 (video); G. 711 (stereo audio)
Image stabilizer	Yes
Internal memory/ Removable	32 MB internal memory/27.7 MB available for image storage (1 MB equals one million bytes); Optional MMC or SD Card  (The SD logo is a trademark of the SD Card Association.)
Image capacity	8 images @ 6 M, JPEG images at fine compression mode & 4:3 aspect in internal memory
Still image buffer	32 MB internal memory
Review	
Quickview	Yes
Video output	NTSC or PAL
Power	
Kodak Li-Ion rechargeable digital camera battery KLIC-8000, CRV3, 3V AC adapter	
Communication with computer/TV	
USB 2.0 (PIMA 15740 protocol), via USB, 8-pin cable (Model U-8), EasyShare camera dock or printer dock, AV cable, 8-pin (Model AV-8)	
Other features	
PictBridge support	Yes
Self-timer	2-second, 10-second, or 2-shot
White balance	Auto, Semi-Auto (Daylight, Tungsten, Fluorescent, Open shade)

Kodak EasyShare Z612 zoom digital camera	
Auto power off	Selectable: 1, 3, 5, 10 minutes
Color modes	High Color, Natural Color, Low Color, B & W, Sepia
Sharpness	High, Normal, Low
Picture quality	Fine, Standard, Basic
Date stamp	None, YYYY/MM/DD, MM/DD/YYYY, DD/MM/YYYY
Tripod mount	1/4 inch
Operating temperature	32–104° F (0–40° C)
Size	4.0 x 2.9 x 2.7 in. (103.6 x 74.2 x 68.7 mm) @ power off
Weight	10.6 oz (300 g) without battery or card

Storage capacities

Actual storage capacity varies depending on subject composition, card brand, and other factors. You may be able to store more or fewer pictures and videos. Favorites take up additional space in internal memory

Fine compression

	Number of JPEG pictures				
	6.0 MP	5.3 MP (3:2)	4.0 MP	3.1 MP	1.1 MP
Internal memory	6	7	10	12	33
32 MB SD/MMC	7	8	11	14	38
64 MB SD/MMC	15	17	23	28	76
128 MB SD/MMC	30	34	46	57	153
256 MB SD/MMC	61	69	92	115	307
512 MB SD/MMC	123	139	185	231	615
1 GB SD/MMC	247	278	370	463	1231

Standard compression

	Number of JPEG pictures				
	6.0 MP	5.3 MP (3:2)	4.0 MP	3.1 MP	1.1 MP
Internal memory	14	16	21	26	64
32 MB SD/MMC	16	18	24	30	73
64 MB SD/MMC	33	37	48	60	146
128 MB SD/MMC	66	74	97	121	293
256 MB SD/MMC	133	149	196	242	588
512 MB SD/MMC	266	298	392	485	1176
1 GB SD/MMC	533	596	784	970	2352

Basic compression

	Number of JPEG pictures				
	6.0 MP	5.3 MP (3:2)	4.0 MP	3.1 MP	1.1 MP
Internal memory	22	25	32	40	89
32 MB SD/MMC	25	28	37	45	101
64 MB SD/MMC	51	57	74	91	203
128 MB SD/MMC	103	114	149	182	407
256 MB SD/MMC	206	229	298	365	815
512 MB SD/MMC	412	459	596	730	1632
1 GB SD/MMC	824	919	1193	1460	3264

Video storage capacity

	Minutes/seconds of video		
	VGA (640 x 480)	VGA (640 x 480) Long	QVGA (320 x 240)
Internal memory	53 sec.	1 min. 39 sec.	2 min. 8 sec.
32 MB SD/MMC	59 sec.	1 min. 53 sec.	2 min. 25 sec.
64 MB SD/MMC	1 min. 59 sec.	3 min. 46 sec.	4 min. 50 sec.
128 MB SD/MMC	3 min. 59 sec.	7 min. 32 sec.	9 min. 40 sec.
256 MB SD/MMC	7 min. 59 sec.	15 min. 4 sec.	19 min. 21 sec.
512 MB SD/MMC	15 min. 58 sec.	30 min. 8 sec.	38 min. 43 sec.
1 GB SD/MMC	31 min. 57 sec.	60 min. 17 sec.	77 mins. 27 sec.

Power-saving features

If no action for	The camera	To turn it back on
1 minute	EVF/LCD screen turns off.	Press any button.
1, 3 (default), 5, or 10 minutes	Turns off.	Turn camera Off/On.

Important safety instructions

Using this product

- Read and follow these instructions before using Kodak products. Always follow basic safety procedures.
- Use only a USB-certified computer. Contact your computer manufacturer if you have questions.
- The use of an accessory attachment that is not recommended by Kodak, such as an AC adapter, may cause fire, electric shock, or injury.
- If using this product in an airplane, observe all instructions of the airline.



CAUTION:

Do not disassemble this product; there are no user-serviceable parts inside. Refer servicing to qualified service personnel. Do not expose this product to liquid, moisture, or extreme temperatures. Kodak AC adapters and battery chargers are intended for indoor use only. The use of controls, adjustments, or procedures other than those specified herein may result in exposure to shock and/or electrical or mechanical hazards. If the LCD breaks, do not touch the glass or liquid. Contact Kodak Support.



CAUTION:

This appliance is not intended for use by young children or infirm persons unless they have been adequately supervised by a responsible person to ensure that they can use the appliance safely. Young children should be supervised to ensure that they do not play with the appliance.

Battery safety and handling



CAUTION:

When removing batteries, allow them to cool first; batteries may be hot.

- Use only batteries that are approved for this product to avoid risk of explosion.
- Read and follow all warnings and instructions supplied by the battery manufacturer.
- Keep batteries out of the reach of children.
- Do not allow batteries to touch metal objects, including coins. Otherwise, a battery may short circuit, discharge energy, become hot, or leak.
- Do not disassemble, install backward, or expose batteries to liquid, moisture, fire, or extreme temperature.
- Replace all batteries of a set at the same time. Do not mix new batteries with used ones. Do not mix rechargeable and non-rechargeable batteries. Do not mix lithium, Ni-MH, and Ni-Cd batteries together. Do not mix batteries of different chemistry types, grades, or brands. Failure to observe this precaution may cause leakage.
- Remove batteries when the product is stored for an extended period of time. In the unlikely event that battery fluid leaks inside the product, contact your local Kodak Customer Service representative.
- In the unlikely event that battery fluid leaks onto your skin, wash immediately with water and contact your local health provider. For additional health-related information, contact your local Kodak Customer Service representative.
- Dispose of batteries according to local and national regulations.
- Do not charge non-rechargeable batteries.

For more information on batteries, see

www.kodak.com/global/en/service/batteries/batteryUsage.jhtml

Battery information

Kodak battery replacement types/battery life

Actual battery life may vary based on usage.

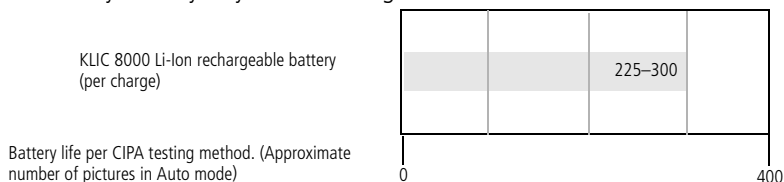

We recommend using only a Kodak Li-Ion rechargeable digital camera battery KLIC-8000 or Kodak lithium digital camera battery CRV3. Not all manufacturers' Li-Ion rechargeable batteries are compatible with the camera. Damage caused by unauthorized accessories is not covered under warranty.

We do not recommend any size alkaline batteries. For acceptable battery life, and to make sure your camera operates dependably, use the batteries listed.

Extending battery life

- Limit the following activities that quickly deplete battery power:
 - Reviewing your pictures on the camera screen
 - Using the camera screen as a viewfinder
 - Excessive use of the flash
 - Excessive use of Continuous AF (see table on [page 32](#))
- Dirt on the battery contacts can affect battery life. Wipe the contacts with a clean, dry cloth before loading batteries in the camera.
- Battery performance is reduced at temperatures below 41°F (5°C). When using your camera in cold weather, carry spare batteries and keep them warm. Do not discard cold batteries that do not work; when they return to room temperature, they may be usable.

Visit www.kodak.com/go/z612accessories for:

Kodak EasyShare camera dock—powers your camera, transfers pictures to your computer, and charges the Kodak Li-Ion rechargeable digital battery KLIC-8000.

Kodak EasyShare printer dock—powers your camera, makes 4 x 6 in. (10 x 15 cm) prints with or without a computer, transfers pictures, and charges the Kodak Li-Ion rechargeable digital battery KLIC-8000.

Kodak 3-volt AC adapter—powers your camera.

IMPORTANT: *Do not use the AC adapter included with the Kodak EasyShare camera dock or printer dock to power your camera. Your camera may use a different AC adapter.*

Upgrading your software and firmware

Download the latest versions of the software included on the Kodak EasyShare software CD and the camera firmware (the software that runs on the camera). See www.kodak.com/go/z612downloads.

Additional care and maintenance

- If the camera has been subjected to inclement weather or you suspect water has gotten inside the camera, turn off the camera and remove the batteries and card. Allow all components to air-dry for at least 24 hours before using the camera again.
- Blow gently on the lens or camera screen to remove dust and dirt. Wipe gently with a soft, lint-free cloth or an untreated lens-cleaning tissue. Do not use cleaning solutions unless designed specifically for camera lenses. Do not allow chemicals, such as suntan lotion, to contact painted surfaces.
- Service agreements are available in some countries. Contact a dealer of Kodak products for more information.
- For digital camera disposal or recycling information, contact your local authorities. In the US, visit the Electronics Industry Alliance Web site at www.eiae.org or the Kodak Web site at www.kodak.com/go/z612support.

www.kodak.com/go/support

Warranty

Limited warranty

Kodak warrants Kodak digital cameras and accessories (excluding batteries) to be free from malfunctions and defects in both materials and workmanship for one year from the date of purchase.

Retain the original dated sales receipt. Proof of the date of purchase will be required with any request for warranty repair.

Limited warranty coverage

This limited warranty will be honored only within the geographical location that Kodak digital cameras and accessories were purchased.

Kodak will REPAIR or REPLACE Kodak digital cameras and accessories if they fail to function properly during the warranty period, subject to any conditions and/or limitations stated herein. Such repair service will include all labor as well as any necessary adjustments and/or replacement parts. Such repair or replacement is the sole remedy under this warranty.

If replacement parts are used in making repairs, these parts may be remanufactured, or may contain remanufactured materials. If it is necessary to replace the entire product, it may be replaced with a remanufactured product.

Limitations

Request for Warranty service will not be accepted without proof of date of purchase, such as a copy of the original dated Kodak digital camera or accessory sales receipt. (Always keep the original for your records.)

This warranty does not apply to the battery(s) used in digital cameras or accessories. This warranty does not cover circumstances beyond Kodak's control, nor problems caused by failure to follow the operating instructions in the Kodak digital cameras and accessories User's Guides.

THIS WARRANTY DOES NOT APPLY WHEN FAILURE IS DUE TO SHIPPING DAMAGE, ACCIDENT, ALTERATION, MODIFICATION, UNAUTHORIZED SERVICE, MISUSE, ABUSE, USE WITH INCOMPATIBLE ACCESSORIES OR ATTACHMENTS, FAILURE TO FOLLOW KODAK'S OPERATION, MAINTENANCE OR REPACKING INSTRUCTIONS, FAILURE TO USE ITEMS SUPPLIED BY KODAK (SUCH AS ADAPTERS AND CABLES), OR CLAIMS MADE AFTER THE DURATION OF THIS WARRANTY.

Kodak makes no other express or implied warranty for this product. In the event that the exclusion of any implied warranty is ineffective under the law, the duration of the implied warranty will be one year from the purchase date.

The option of replacement is Kodak's only obligation. Kodak will not be responsible for any special, consequential or incidental damages resulting from the sale, purchase, or use of this product, regardless of the cause. Liability for any special, consequential or incidental damages (including but not limited to loss of revenue or profit, downtime costs, loss of the use of the equipment, cost of substitute equipment, facilities or services, or claims of your customers for such damages resulting from the purchase, use or failure of the product), regardless of cause or for breach of any written or implied warranty is expressly disclaimed and excluded here from.

Your rights

Some states or jurisdictions do not allow exclusion or limitation of incidental or consequential damages, so the above limitation or exclusion may not apply to you. Some states or jurisdictions do not allow limitations on how long an implied warranty lasts, so the above limitation may not apply to you.

This warranty gives you specific rights, and you may have other rights which vary from state to state or by jurisdiction.

Outside the United States and Canada

In countries other than the United States and Canada, the terms and conditions of this warranty may be different. Unless specific Kodak warranty is communicated to the purchaser in writing by a Kodak company, no warranty or liability exists beyond any minimum requirements imposed by law, even though defect, damage, or loss may be by negligence or other act.

Regulatory compliance

FCC compliance and advisory

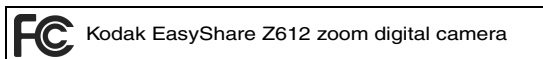

This equipment has been tested and found to comply with the limits for a Class B digital device, pursuant to Part 15 of the FCC Rules. These limits are designed to provide reasonable protection against harmful interference in a residential installation.

This equipment generates, uses, and can radiate radio frequency energy and, if not installed or used in accordance with the instructions, may cause harmful interference to radio communications. However, there is no guarantee that interference will not occur in a particular installation.

If this equipment does cause harmful interference to radio or television reception, which can be determined by turning the equipment off and on, the user is encouraged to try to correct the interference by one or more of the following measures: 1) reorient or relocate the receiving antenna; 2) increase the separation between the equipment and the receiver; 3) connect the equipment to an outlet on a circuit different from that to which the receiver is connected; 4) consult the dealer or an experienced radio/TV technician for additional suggestions.

Any changes or modifications not expressly approved by the party responsible for compliance could void the user's authority to operate the equipment. Where shielded interface cables have been provided with the product or specified additional

components or accessories elsewhere defined to be used with the installation of the product, they must be used in order to ensure compliance with FCC regulation.

Canadian DOC statement

DOC Class B Compliance—This Class B digital apparatus complies with Canadian ICES-003.

Observation des normes-Classe B—Cet appareil numérique de la classe B est conforme à la norme NMB-003 du Canada.

Australian C-Tick



Waste Electrical and Electronic Equipment labeling



In the European Union, do not discard the product as unsorted municipal waste. Contact your local authorities or go to www.kodak.com for recycling program information.

Korea Class B ITE

이 기기는 가정용으로 전자파적합등록을 한 기기로서 주거지역에서는 물론 모든 지역에서 사용할 수 있습니다.

English translation:

As this equipment has obtained EMC registration for household use, it can be used in any area including residential areas.

VCCI Class B ITE

この装置は、情報処理装置等電波障害自主規制協議会（VCCI）の基準に基づくクラスB 情報技術装置です。この装置は、家庭環境で使用することを目的としていますが、この装置がラジオやテレビジョン受信機に近接して使用されると、受信障害を引き起こすことがあります。
取扱説明書に従って正しい取り扱いをして下さい。

English translation:

This is a Class B product based on the standard of the Voluntary Control Council for Interference from Information Technology Equipment (VCCI). If this is used near a radio or television receiver in a domestic environment, it may cause radio interference. Install and use the equipment according to the instruction manual.

MPEG-4

Use of this product in any manner that complies with the MPEG-4 visual standard is prohibited, except for use by a consumer engaging in personal and non-commercial activities.

Index

Numerics

4-way button, ii

A

A/V out, ii, 45

about picture, video, 39

about this camera, 39

AC adapter, 71

AC adapter connector, ii

accessories

AC adapter, 71

battery, 70

buying, 59

camera dock, 71

printer dock, 17, 71

SD/MMC card, 4

action print, 11

adjust

LCD brightness, 36

volume, 37

advanced digital zoom, 13, 37

AF assist light/self-timer, i

AF control, 34

AF framing marks, 8

AF zone, 34

AF/AE (Auto Focus/Auto Exposure)

indicator, 5

album, 11, 35

albums, tagging pictures for, 45, 46

aperture, 30

aperture priority, 22

auto

enhancement, 43

mode, 21

power-off, 38, 67

B

backlight, 23

batteries

extending life, 70

battery

charging, 2

expected life, 70

inserting, 2

safety, 69

battery compartment, ii

beach, 24

black & white, 35

burst mode, 27

button

4-way, ii

delete, ii, 7

drive, i

flash, i

info, ii

menu, ii

OK, ii

review, ii

share, ii

shutter, i

C

cable

audio/video, 45

camera defaults, return to, 38
camera dock, 71
camera sounds, 37
camera strap
 attaching, 1
camera, view information, 39
Canadian compliance, 75
candle light, 23
capture frame grid, 36
capture mode
 liveview, 6
caring for your camera, 71
charging battery, 2
checking
 camera status, 11
 picture status, 11
 problems with camera, 54
children, 24
Class B ITE, 75
clock, setting, 3, 4
close-up, 26
cloudy, lighting, 33
color mode, 35
compression
 basic, 32, 65
 fine, 32, 65
 standard, 32, 65
computer
 connecting camera, 15, 16
 transfer to, 15, 16
continuous shooting, 27
copy, 11
copy pictures
 card to memory, 40
 memory to card, 40

 to computer via USB cable, 15, 16
crop, 11
cropping pictures, 43
custom camera insert, 20
customer support, 60
customizing camera settings, 36

D

D-22 adapter, 20
date & time, 3, 4, 37
date stamp, 37
daylight, lighting, 33
delete button, ii
deleting
 during quickview, 7
 from internal memory, 14
 from SD/MMC card, 14
 protecting pictures, videos, 14
digital zoom, 37
digital zoom, using, 13
displaying slide show, 44
disposal, recycling, 71
dock
 camera, 20, 71
 compatibility, 20
 connector, ii
 printer, 17, 20, 71
docking configuration, 20
downloading pictures, 15, 16
drive button, i
drive modes
 first burst, 27
 last burst, 27
 self-timer, 27
 shutter delay, 27

E

EasyShare
 gallery, 19
 software, 15
emailing pictures, videos, 49
EVF (Electronic Viewfinder), ii
EVF/LCD toggle button, ii
exposure bracketing, 28
exposure bracketing interval, 33
exposure compensation, 30
exposure compensation with exposure
 bracketing, 29
exposure metering, 34
external video device
 viewing pictures, videos, 45

F

favorites
 emailing, 53
 removing, 52
 settings, 51
 tagging, 50
favorites mode, 22
FCC compliance, 74
fireworks, 24
firmware, upgrading, 71
flash
 auto, 25
 fill, 25
 hood, 13
 off, 25
 red-eye, 25

flash button, i
flash compensation, 30
flash hood, i
flash-icon behavior, 25
flip-up flash, 13
flower, 23
fluorescent, lighting, 33
focus
 button, i
focus button, i
focus mode
 AF control, 34
 AF zone, 34
 infinity, 26
 macro AF, 26
 normal AF, 26
format, 39
framing marks, 8
framing video, 41

G

guidelines, battery, 70

H

help
 web links, 59
histogram, 29

I

icons, mode dial, 21
image stabilizer, 36
image storage, 11, 35

imprint date, 37
infinity focus, 26
info button, ii, 39
information
 about pictures, videos, 39
installing
 battery, 2
 SD/MMC card, 4
 software, 15
internal memory
 setup, 35
 storage capacity, 65

J

jog dial, ii, 31

K

Kodak EasyShare software
 installing, 15
 upgrading, 71
Kodak Perfect Touch technology, 43
Kodak web sites, 59

L

landscape, 23
language, 3, 4, 38
LCD brightness, 36
LCD screen, ii
Lens, i
lens
 cleaning lens, 71
lens aperture, 30
lens cap
 attaching, 1
lighting

auto, 33
cloudy, 33
daylight, 33
fluorescent, 33
open shade, 33
sunset, 33
tungsten, 33

lights
 battery charger, 2
liveview, 6
loading
 battery, 2
 SD/MMC card, 4
 software, 15

M

Macintosh computers, installing
 software on, 15
macro AF, 26
magnifying a picture, 12
maintenance, camera, 71
make picture, 11
manner/museum, 23
manual priority, 22
memory
 formatting card, 39
 inserting card, 4
 storage capacities, 65
menu button, ii
microphone, i
mode description, 38
mode dial, i, 21
mode-dial-light indicator status, 57
modes
 aperture priority, 22

auto, 21
 backlight, 23
 beach, 24
 candle light, 23
 children, 24
 favorites, 22
 fireworks, 24
 flower, 23
 landscape, 23
 manner/museum, 23
 manual priority, 22
 night landscape, 23
 night portrait, 21
 party, 23, 26
 program, 21
 SCN, 21
 self-portrait, 23
 shutter priority, 22
 snow, 24
 sport, 21
 sunset, 23
 text, 23
 video, 22
 MP (Megapixel), 32, 65
 multi-selecting pictures, 7
 multi-up, 11

N

night landscape, 23
 night portrait, 21

O

on/off switch, i
 online prints, ordering, 19
 open shade, lighting, 33

optical zoom, 12
 orientation sensor, 37

P

party, 23, 26
 PASM modes, 30
 Perfect Touch technology, 11, 43
 PictBridge printer, 17
 picture size/quality, 32
 pictures

- checking settings, 11
- copying, 40
- cropping, 43
- deleting, 14
- emailing tagged, 49
- Kodak Perfect Touch, 43
- making video picture, 42
- printing, 19
- printing tagged, 48
- protecting, 14
- resolution, 32
- storage capacity, 65
- tagging, 45, 46
- taking, modes, 21
- transfer via USB cable, 15, 16

 picture-taking, 5
 portrait, 23, 27
 power

- auto-off, 67
- camera, 3

 printer dock, 17, 71
 printing

- from computer, 19
- optimizing printer, 59
- order online, 19

PictBridge, 17
with EasyShare printer dock, 17
program mode, 21
protect, 11
protecting pictures, videos, 14
putting yourself in the picture, 27

Q

quickview, 37
using, 7

R

recycling, disposal, 71
regulatory information, 74
Class B ITE, 75
removing favorites, 52
reset camera, 38
return to previous menu, 36
review button, ii
review icons, 10
review magnifier, ii
review options, 11
review thumbnails, 9
reviewing pictures
as you take them, 7
deleting, 14
magnifying a picture, 12
multi-selecting pictures, 7
protecting, 14
slide show, 44
reviewing videos
deleting, 14
protecting, 14
slide show, 44

rotate picture, 37
rotecting, 14
running slide show, 44

S

safety
battery, 69
SCN, scene mode, 21, 23
screen, LCD, ii
SD/MMC card
inserting, 4
storage capacities, 65
self-portrait, 23
self-timer, 27
sepia, 35
service and support
telephone numbers, 60
set album, 35
setting, 4
about, 39
advanced digital zoom, 37
AF control, 34
AF zone, 34
album, 35
aperture, 30
auto power-off, 38
camera sounds, 37
capture frame grid, 36
color mode, 35
date & time, 3, 4, 37
date stamp, 37
exposure bracketing interval, 33
exposure compensation, 30
exposure metering, 34

- flash compensation, 30
 - format, 39
 - image stabilizer, 36
 - image storage, 35
 - language, 4, 38
 - LCD brightness, 36
 - mode description, 38
 - orientation sensor, 37
 - PASM, 30
 - picture size/quality, 32
 - picture-taking mode, 21
 - quickview, 37
 - reset camera, 38
 - return, 36
 - review, 11
 - set album, 35
 - sharpness, 35
 - sound volume, 37
 - video date display, 38
 - video length, 33, 38
 - video out, 38
 - video size/quality, 32
 - white balance, 33
 - setup menu, 11
 - setup mode, using, 36
 - share button, ii, 48
 - sharpness, 35
 - shutoff, auto, 67
 - shutter button, i
 - press halfway, 5
 - shutter priority, 22
 - shutter speed, 30
 - shutter, problems, 55
 - sleep mode, 67
 - slide show, 11
 - continuous loop, 45
 - problems, 56
 - running, 44
 - snow, 24
 - software
 - installing, 15
 - upgrading, 71
 - sound
 - setting, 37
 - speaker, i
 - specifications, camera, 61
 - sport, 21
 - storage capacity, 65, 66, 67
 - storage location, 35
 - sunset, 23, 33
 - support, technical, 60
- T**
- tagging
 - favorites, 50
 - for email, 49
 - for print, 49
 - tagging pictures
 - for albums, 45, 46
 - taking a picture, 5
 - telephone support, 60
 - telephoto, 12, 13
 - television, slide show, 45
 - text, 23
 - thumbnails, viewing, 9
 - tips
 - battery guidelines, 70
 - care & maintenance, 71
 - transfer, via USB cable, 15, 16
 - trash can, deleting, 7

tripod socket, ii
troubleshooting, 54
tungsten, lighting, 33
turning camera on and off, 3

U

upgrading software, firmware, 71
URLs, Kodak web sites, 59
USB (universal serial bus)
 transferring pictures, 15, 16
USB, A/V out, ii

V

VCCI compliance, 76
video
 action print, 41
video date display, 38
video length, 33, 38
video mode, 22
video out, regional setting
 NTSC, 38
 PAL, 38
video size/quality, 32
video taking, 5
videos
 checking settings, 11
 copying, 40
 date/time display, 38

 deleting, 14
 emailing tagged, 49
 making still picture, 42
 making video action print, 41
 protecting, 14
 resolution, 32
 reviewing, 9
 storage capacities, 65
 transfer to computer, 15, 16
viewing picture
 after taking, 7
viewing picture, video information, 39

W

warranty, 72
web sites, 59
white balance, 33
wide angle, 12, 13
Windows OS
 installing software, 15

Z

zoom
 digital, 13
 indicator, 12
 lever, ii
 optical zoom, 12

Free Manuals Download Website

<http://myh66.com>

<http://usermanuals.us>

<http://www.somanuals.com>

<http://www.4manuals.cc>

<http://www.manual-lib.com>

<http://www.404manual.com>

<http://www.luxmanual.com>

<http://aubethermostatmanual.com>

Golf course search by state

<http://golfingnear.com>

Email search by domain

<http://emailbydomain.com>

Auto manuals search

<http://auto.somanuals.com>

TV manuals search

<http://tv.somanuals.com>