KODAK EASYSHARE Camera / M583



Extended user guide

www.kodak.com

For interactive tutorials:

www.kodak.com/go/m583demos

For help with your camera:

www.kodak.com/go/m583support

Kodak

Eastman Kodak Company

Rochester, New York 14650

© Eastman Kodak Company, 2011

All screen images are simulated.

Kodak, EasyShare, and Pulse are trademarks of Eastman Kodak Company.

4H8514_en

Front view



Back view



Table of contents

1	Setting up your camera	1
	Attaching the strap	1
	Loading the KLIC-7006 battery	1
	Charging the battery	2
	Turning on the camera	5
	Setting the language and date/time	5
	Storing pictures on a MicroSD/SDHC Card	6
2	Taking pictures/videos	7
	Taking pictures	7
	Your camera, the way you want it	8
	Using Tools to choose actions, preferences	9
	Understanding the picture-taking icons	10
	Watch the battery level	10
	Taking a video	11
	Using the optical zoom	12
	Using the flash	13
	Using different modes and effects	14
	Using the photobooth feature	15
	Using Program mode	16
	Using the self-timer	17
	Using the burst feature	17
	Taking panoramic pictures	18
3	Reviewing and editing	19
	Reviewing pictures/videos	19
	Deleting pictures/videos	21
	Viewing pictures/videos in different ways	22
	A smarter way to find and enjoy your pictures	23
	Understanding the review icons	24

Adding a border to a picture.....	25
Using photo effects to change a picture's tint	26
Cropping a picture	27
Trimming a video	28
Making a picture from a video.....	29
Making an action print from a video.....	30
Selecting multiple pictures/videos	31
Displaying pictures/videos on a television.....	32
4 Sharing pictures/videos	33
Sharing through email and social networks.....	33
Tagging pictures	35
Marking pictures/videos as favorites	38
5 Doing more with your camera	39
Changing settings	39
6 Install software	42
Install software, transfer pictures, and share	42
Printing pictures.....	43
Marking pictures for print.....	44
7 Troubleshooting	45
Troubleshooting.....	45
Getting help on the Web.....	48
8 Appendix	49
Specifications.....	49
Care and maintenance	51
Upgrading your software and firmware.....	51
Storage capacities.....	52
Important safety instructions	52
Battery replacement, battery life.....	53
Limited warranty.....	54
Regulatory compliance	55

1

Setting up your camera

Attaching the strap



Loading the KLIC-7006 battery

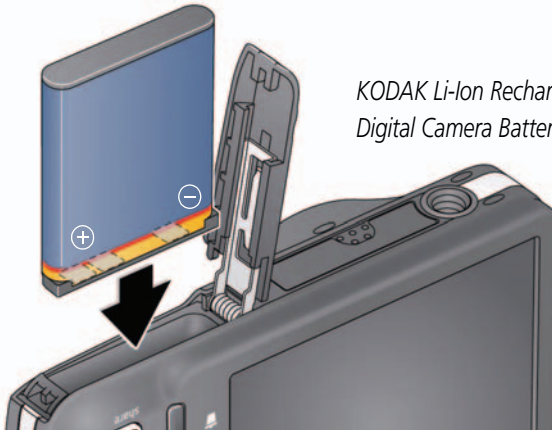

*KODAK Li-Ion Rechargeable
Digital Camera Battery KLIC-7006*

Charge the battery [see page 2](#)

Watch the battery level [see page 10](#)

Purchase extra batteries www.kodak.com/go/accessories

Charging the battery

If your package includes an in-camera battery charger

Maximize the number of pictures you can take—fully charge the battery before using. (All rechargeable batteries lose power over time, even if they're not being used.) You can charge the Li-Ion battery whenever necessary.

- 1 Turn off the camera.
- 2 Connect a KODAK Camera USB Cable, Micro B / 5-Pin and charger. (Use only the cable included with this camera.)

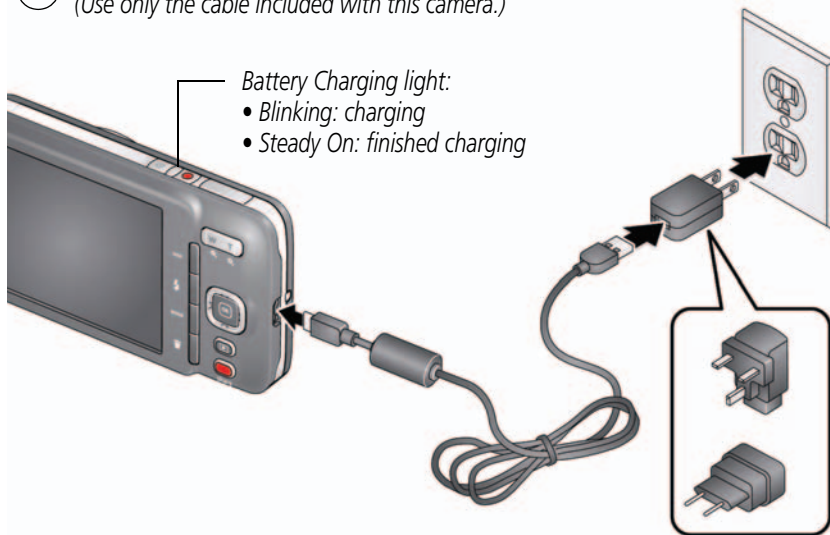

Watch the battery level [see page 10](#)

Purchase extra batteries www.kodak.com/go/accessories

If your package includes an external battery charger

You can charge the Li-Ion battery whenever necessary.

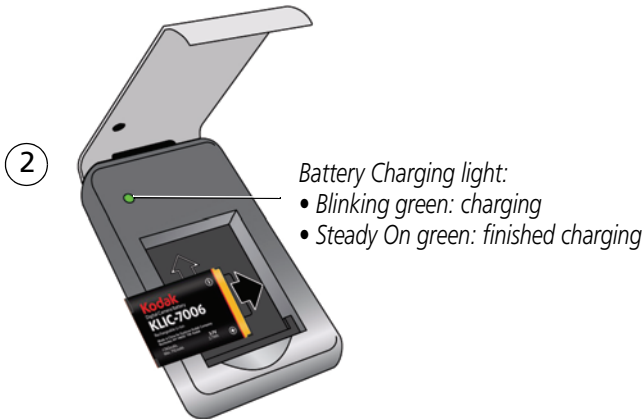
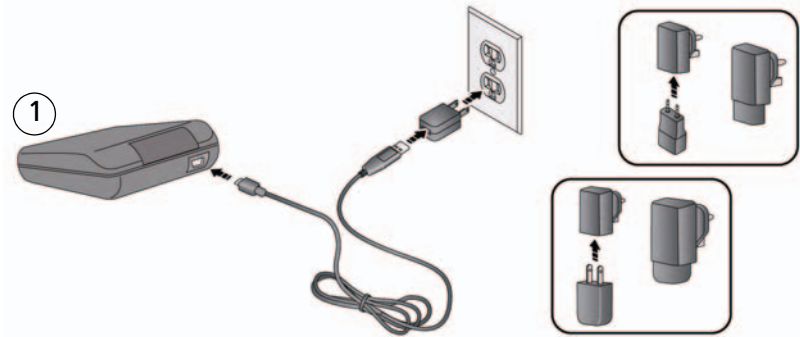

Watch the battery level [see page 10](#)

Purchase extra batteries www.kodak.com/go/accessories

Charge via your computer's USB port

You can charge the Li-Ion battery whenever necessary.

IMPORTANT: *The camera charges when the computer is on and awake. Turn off the computer's hibernation, sleep, and standby modes.*

- 1 Turn off the camera.
- 2 Connect a KODAK Camera USB Cable, Micro B / 5-Pin and charger.

Battery Charging light:

- *Blinking:* charging
- *Steady On:* finished charging

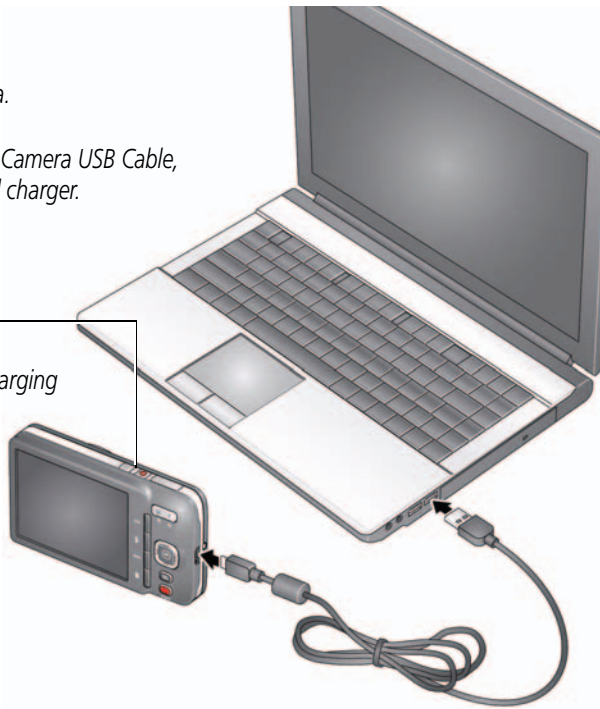

Watch the battery level [see page 10](#)

Purchase extra batteries www.kodak.com/go/accessories

Turning on the camera

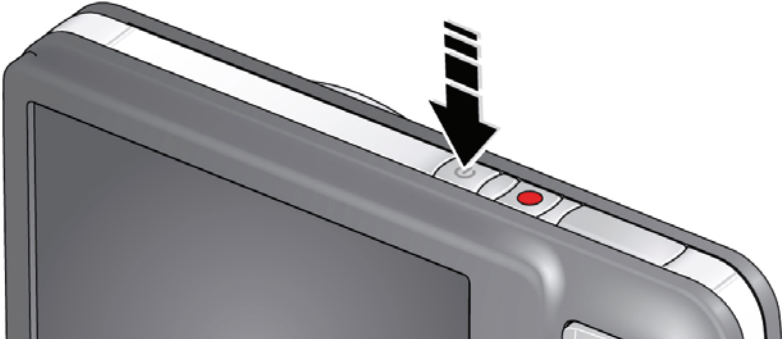

Setting the language and date/time

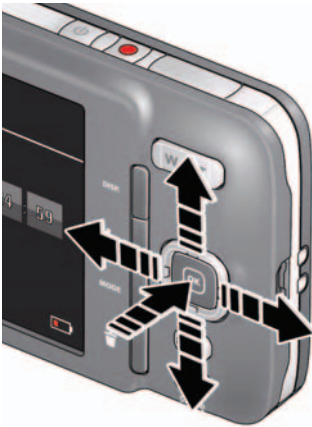

Language:

▲▼ to change.

OK to accept.

Date/Time:

At the prompt, press OK.

◀▶ to change current field.

▲▼ for previous/next field.

OK to accept.

Sharing Destinations:

You can select which sharing sites to offer when it's time to share pictures/videos.

▲▼ to highlight a site.

OK to check/uncheck a site.

NOTE: To change language in the future, use the Setup menu (see page 40).

Storing pictures on a MicroSD/SDHC Card

Your camera has internal memory. We recommend purchasing a MicroSD or MicroSDHC Card to conveniently store more pictures/videos.



CAUTION:

A card can only be inserted one way; forcing it may cause damage. Inserting or removing a card while the camera is on may damage the pictures, the card, or the camera.

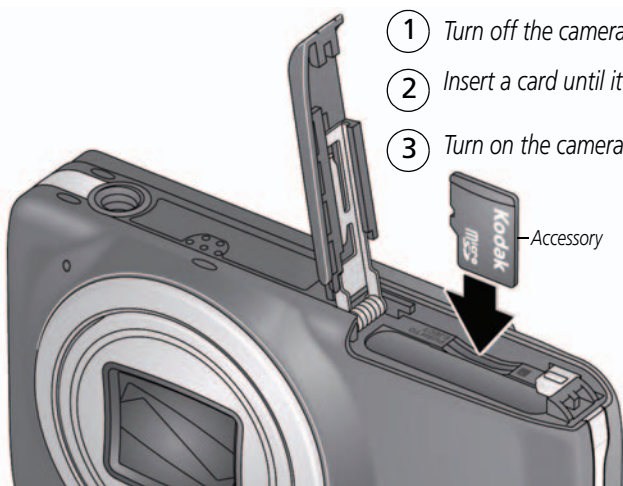

To remove a card, press and release it.

IMPORTANT: When you turn on the camera, it checks to see if a card is inserted. If so, new pictures/videos are stored on the card. If no card is inserted, new pictures/videos are stored in the camera's internal memory. If pictures/videos are detected in internal memory and a card is inserted, the camera prompts you to move the pictures to the card (and erase those in internal memory).

Purchase accessories www.kodak.com/go/accessories

2

Taking pictures/videos

Taking pictures

When you turn on the camera for the first time, it's in Smart Capture mode—great for general picture taking. (After that, the camera “remembers” the last mode you used. To change modes, see page 14.)



- 1 Use the LCD to compose the picture.
- 2 Press the Shutter button **halfway** to focus and set exposure.

Framing marks indicate the camera focus area. If the camera is not focusing on the desired subject, release the Shutter button and recompose the scene.

- 3 Press the Shutter button **completely down**.

A quickview—showing the new picture—is briefly displayed. If you're in a hurry to take more pictures, press the Shutter button halfway down and release it. The quickview is dismissed.

IMPORTANT: Press the Share button to share anytime. To learn more, see page 33.

In Liveview

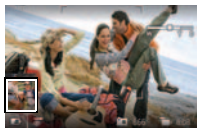

In Quickview



In Review

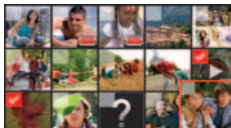

Other picture-taking features



Display

OK

Review

- To view available tools, press the Display button **DISP.**. Press **◀▶** to choose a tool, then press OK.
- To review, tag, and edit pictures and videos, press the Review button **▶** (see page 19).
- If it's hard to see the LCD, you can adjust the brightness, see page 40.

Your camera, the way you want it

Sometimes, you want to see everything available! (Other times, you want everything out of your way.) Press the Display button **DISP.** to change between Clean view and Tools view.

Clean view



Tools view
(Tools vary by camera mode.)

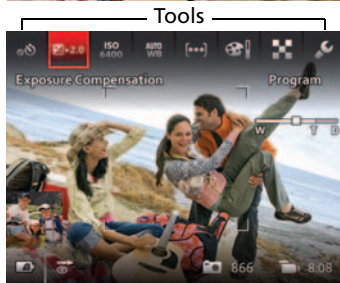

Using Tools to choose actions, preferences

- 1 In Liveview, press ▲▼ to move between Tools and the most recent picture.

or

- 1 In Review, press ▲▼ to move between Tools and Previous or Next picture/video.

- 2 Press ◀▶ to choose a tool, then press OK.
Press ◀▶ to change a tool's setting, then press OK.

NOTE: If you chose 📷, press ▲▼ to choose a setting, then press OK.

You can choose some settings using ◀▶.

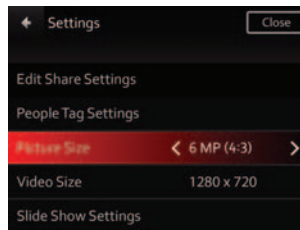





Understanding the picture-taking icons



Watch the battery level

Don't miss out on great pictures and videos—keep your battery fully charged.

Full	
Three quarters	
Half	
Critical	
AC Power	

Charge the battery [see page 2](#)

Purchase extra batteries www.kodak.com/go/accessories

Taking a video

The camera is always ready to take a video—just press the Record button!



- 1 Use the LCD to compose the video.
- 2 To start recording, press the Record button  **completely down** then release it. To stop recording, press and release the button again. *The first frame of the new video and the play button are displayed for a few seconds.*
 - To play/pause the video, press the OK button.
 - If you don't like the video, press the Delete button, then follow the prompts.

Other video-taking features

- To review and work with pictures and videos, see [page 19](#).
- To change camera settings, [see page 39](#).
- If it's hard to see the LCD, you can adjust the brightness, [see page 40](#).

Using the optical zoom

You can use the zoom while taking a video or before taking a picture.

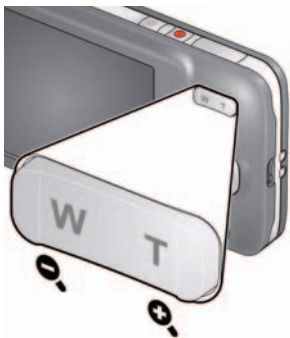

- 1 Use the LCD to frame your subject.
- 2 To zoom in, press Telephoto (T).
To zoom out, press Wide Angle (W).
- 3 Take the picture or video.

NOTE: For focus distances, see Specifications starting on [page 49](#).

Using digital zoom





Use digital zoom to get up to 5X magnification beyond optical zoom. (Digital zoom is not available in Smart Capture mode.) Press Telephoto (T) until the slider on the LCD is at the end of the optical zoom range. Release Telephoto (T), then press it again.

NOTE: You may notice decreased image quality when using digital zoom.

Using the flash

Press the Flash button repeatedly until the LCD displays the desired flash mode. Flash modes differ between capture modes.



Flash modes	Flash fires
Auto 	When the lighting conditions require it. The camera processes the picture to correct red eye.
Flash On (Fill) 	Every time you take a picture, regardless of the lighting conditions. Use when the subject is in shadow or is "backlit" (when the light is behind the subject).
Red-eye Reduction 	A preflash fires, shrinking the eye pupil, before the picture is taken.
Off 	Never

Using different modes and effects

To take pictures/videos in different modes or effects:



- 1 Press the Mode button **MODE**.
- 2 Press ◀▶ to choose:
 - **Smart Capture:** For general picture taking.
 - **Film Effects:** Experiment with picture/video effects. (Each effect shows an example of what your picture/video will look like.)
 - **Scene modes:** (See table below.) Choose the Scene mode that matches your picture-taking situation—for the best possible pictures.
 - **Photobooth:** Like a vintage photobooth, the camera uses a self-timer to take 4 pictures, then combines them into a single strip. (See [page 15](#).)

SCN mode	For
Program	Access to more advanced settings. (See page 16 .)
Portrait	Full-frame portraits of people.
Sport	Action pictures.
Landscape	Distant scenes.
Close-up	Close range. Use available light instead of flash, if possible.
Sunset	Subjects at dusk.
Backlight	Subjects that are in shadow or “backlit.”
Candle Light	Subjects illuminated by candle light.
Children	Action pictures of children in bright light.
Bright	Bright beach or snow scenes.

SCN mode	For
Fireworks	Fireworks. For best results, place the camera on a steady surface or tripod.
Self-Portrait	Close-ups of yourself. Assures proper focus and minimizes red eye.
Night Portrait	Reduces red eye of people in night scenes or low-light conditions.
Night Landscape	Distant scenery at night. Flash does not fire.
Blur Reduction	Reducing blur caused by camera shake or subject motion.
High ISO	People indoors, in low-light scenes.
Panorama R-L, L-R	"Stitching" 2 or 3 pictures into 1 panoramic scene. (See page 18.)
Long Time Exposure	Conveying a sense of motion. The settings are: None, 0.5 Sec., 1.0 Sec., 2.0 Sec., 4.0 Sec., 8.0 sec.

Using the photobooth feature

Like a vintage photobooth, the camera uses a self-timer to take 4 pictures, then combines them into a single strip. For best results, place the camera on a tripod or steady surface.

- 1 Press the Mode button **MODE**.
- 2 Press **◀▶** to choose Photobooth, then press OK.
- 3 Compose the scene. Press the Shutter button **halfway**, then **completely down**.

The camera takes 4 pictures after 8-second delays, then produces a single strip.

Using Program mode

Program mode gives access to manual settings like ISO, White Balance, Focus Zone, and Exposure Compensation.





- 1 Press the Mode button **MODE**, choose Scene mode (see [page 14](#)), and press OK. Choose Program, then press OK.
- 2 Press **▲▼◀▶** to choose a setting, then press OK.
Press **◀▶** to change a setting, then press OK to save it.





Self-timer/Burst	Include yourself in a picture (page 17). Burst takes a series of pictures in rapid succession.
Exposure Compensation	Adjust the exposure. If a scene is too light, decrease the setting; if it's dark, increase the setting.
ISO	Adjust the camera's sensitivity to light. Higher ISO indicates greater sensitivity. NOTE: A higher ISO may produce unwanted "noise" in a picture.
White Balance	To make picture color more accurate, choose the setting that matches the current lighting.
Focus Zone	Choose Multi-Zone, Center-Zone, Face Priority.
Focus Mode	Choose Auto or Infinity.

Using the self-timer

Use the self-timer when you want to be included in a picture or to ensure a steady Shutter button press. For best results, place the camera on a tripod or steady surface.

- 1 Press the Display button  until tools appear at the top of the LCD.
- 2 Press  and  to choose the Self-timer/Burst icon.
- 3 Press  to choose a self-timer setting:





Self-timer setting	Description
10 Seconds 	A picture is taken after a 10-second delay (so you have time to get into the scene).
2 Seconds 	A picture is taken after a 2-second delay.
2 Picture Timer 	The first picture is taken after a 10-second delay. A second picture is taken 8 seconds later.

- 4 Compose the scene. Press the Shutter button **halfway**, then **completely down**.
The camera takes the picture/pictures after the delay.

You can use the same procedure to take a video (after a 2- or 10-second delay), but press the Record button **completely down**.

Using the burst feature

Use the burst feature to take pictures in rapid succession.

- 1 Press the Display button  until tools appear at the top of the LCD.
- 2 Press  and  to choose the Self-timer/Burst icon, then press OK.
- 3 Press  to choose Burst, then press OK.
- 4 Compose the scene. Press the Shutter button **halfway**, then **down and hold it**.

The camera takes pictures until you release the Shutter button, when the burst pictures are taken, or when there is no more storage space. The flash does not fire.

Taking panoramic pictures

Use panorama to “stitch” up to 3 pictures into a panoramic scene.

NOTE: For best results, use a tripod. Only the panoramic picture is saved; individual pictures are not. (Exposure and white balance are set with the first picture. The flash is set to Off.)

- 1 Press the Mode button **MODE**.
- 2 Press ◀▶ to choose Scene Modes, then press OK.
- 3 Press ◀▶ ▲▼ to choose Panorama Left-Right or Panorama Right-Left (depending on the direction you want to pan), then press OK.
- 4 Take the first picture.
After a quickview, the LCD displays the liveview and an “overlay” from the first picture.
- 5 Compose the second picture. Make the overlay from the first picture cover the same portion in the new picture.
- 6 If you are taking/stitching only 2 pictures, press OK to stitch them together.
After you take 3 pictures, the pictures are automatically stitched together.

Take
2 or 3
pictures.



Get 1
panoramic
picture.



NOTE: To use the self-timer 10-second or 2-second setting, see [page 17](#).

3 Reviewing and editing

Reviewing pictures/videos



- 1 Press the Review button to enter/exit Review.
- 2 Press to choose All, People, Date, Keywords, or Videos, then press OK.

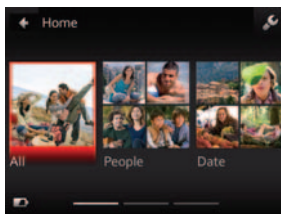

- 3 If you chose People, Date, or Keywords, highlight a name, date, or keyword, then press OK.

You can also review pictures/videos by pressing:

- OK in Liveview, when the most recent picture is highlighted (bottom left of the LCD), or
- during Quickview, while reviewing a new picture

IMPORTANT: Press the Share button to share anytime.

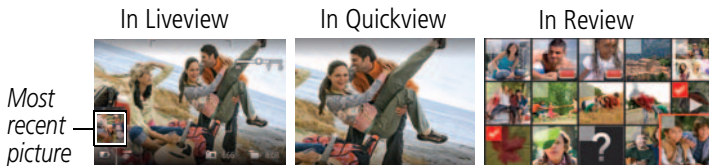

Other things you can do in Review

- Press ◀▶ to see previous or next picture/video.
- Press OK to play videos.
- Press **DISP.** to show/hide tools.
- Press  to delete pictures/videos.



Playing a video

When a video is displayed, the Play button appears. Press OK to play the video. During playback:

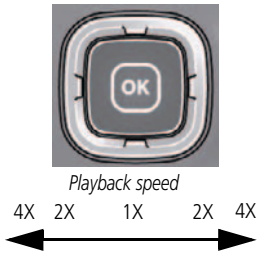

- To play/pause the video, press the OK button.
- To fast forward/rewind, press ◀▶ while the video is playing. To change the speed, press ◀▶ again. To return to 1X speed, release the ◀▶ button.
- To forward/rewind one frame at a time, press ▶◀ while the video is paused.
- If you don't like the video, press the Delete button, then follow the prompts.

Deleting pictures/videos

- 1 Press the Review button .
- 2 Press ◀▶ to choose a stack of pictures (All, or sorted by People, Date, Keywords, or Videos), then press OK.
If you chose All, People, Date, or Keywords, press ▶◀ to find a picture/video to delete. (If you chose Videos, thumbnails are displayed.)
- 3 Press the Delete button, then ▲▼ to choose Picture/Video or All, then press OK.
To delete other pictures, press ◀▶ and repeat this step. When finished, press ▲ to choose Exit, then press OK.

NOTE: Pictures/videos cannot be deleted if the camera is in Safe mode ([see page 41](#)).





To return to picture-taking mode, press the Shutter button halfway down.

Viewing pictures/videos in different ways

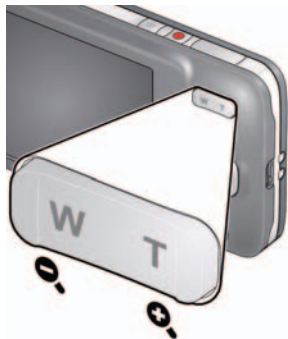

Magnifying a picture

You can magnify a picture while in review.







- 1 Press the Review button , then find a picture.
- 2 Press Telephoto (T) to magnify 2X–8X.
- 3 Press     to view other parts of a picture.
 - Press OK to return to 1X.

Viewing as thumbnails

- 1 Press the Review button .
- 2 Press   to choose a stack of pictures (All, or sorted by People, Date, Keywords, or Videos), then press OK.

If you chose All, People, Date, or Keywords, a single-up picture is shown. (If you chose Videos, multi-up is already displayed.)

- 3 Press the Display button  until tools appear at the top of the LCD.
- 4 Press  and  to choose Multi-up , then press OK.



Thumbnails are shown.

To select multiple pictures/videos, [see page 31](#).

To return to picture-taking mode, press the Shutter button halfway down.

A smarter way to find and enjoy your pictures

Tag pictures—by people or keywords—to make them easy to find, later. For example, the camera can find all pictures that contain “Mary” or “Dad’s 60th Birthday.”

- 1 Press the Review button .
- 2 Press   to see All pictures/videos or those sorted by Date, People, Keywords or Videos.

If you chose All, People, Date, or Keywords, a single-up picture is shown. (If you chose Videos, thumbnails are displayed.) If you press OK while a video is highlighted, the video plays.)

To return to picture-taking mode, press the Shutter button halfway down.

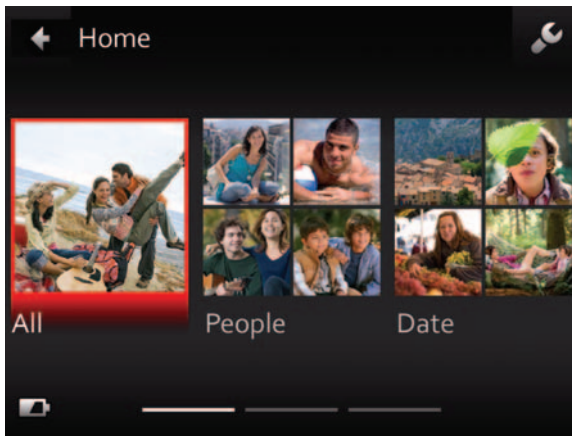

Use   to access Keywords and Videos.



















Tip: For best results, make sure the camera date/time is current ([see page 40](#)).

Understanding the review icons



Adding a border to a picture



















You can enhance a picture by adding a border.

- 1 Press the Review button .
- 2 Press   to choose a stack of pictures (All, or sorted by People, Date, or Keywords), then press OK.
A single-up picture is shown. Press   to choose a different picture.
- 3 Press the Display button  until tools appear at the top of the LCD.
- 4 Press  and   to choose Edit , then press OK.
- 5 Press   to choose Effects , then press OK.
- 6 Press   to choose Borders, then press OK.
- 7 Press   to choose a border style, then press OK.
- 8 Press  to choose Cancel or Apply, then follow the prompts.

To return to picture-taking mode, press the Shutter button halfway down.

Using photo effects to change a picture's tint













You can enhance a picture by tinting it.

- 1 Press the Review button .
- 2 Press   to choose a stack of pictures (All, or sorted by People, Date, or Keywords), then press OK.
A single-up picture is shown. Press   to choose a different picture.
- 3 Press the Display button  until tools appear at the top of the LCD.
- 4 Press  and   to choose Edit , then press OK.
- 5 Press   to choose Effects , then press OK.
- 6 Press   to choose Tint, then press OK.
- 7 Press   to choose a tint, then press OK.
- 8 Press  to choose Cancel or Apply, then follow the prompts.

To return to picture-taking mode, press the Shutter button halfway down.

Cropping a picture

























You can crop a picture so that only the desired portion of the picture remains.

- 1 Press the Review button .
- 2 Press   to choose a stack of pictures (All, or sorted by People, Date, or Keywords), then press OK.
A single-up picture is shown. Press   to choose a different picture.
- 3 Press the Display button  until tools appear at the top of the LCD.
- 4 Press  and   to choose Edit , then press OK.
- 5 Press   to choose Crop , then press OK.
- 6 Follow the prompts to crop the picture.

To return to picture-taking mode, press the Shutter button halfway down.

Trimming a video

















You can remove the start or end of a video, saving only the desired portion.

- 1 Press the Review button .
- 2 Press   to choose Videos, then press OK.
Thumbnails are displayed.
- 3 Press  and   to choose Select Images, then press OK.
- 4 Press  and   to choose a video, then press OK.
- 5 Press  and   to choose the Edit icon .
- 6 Press   to choose Trim , then press OK.
- 7 Press  to choose the Start trim mark , then press OK. Press   to move the Start position. When you're satisfied, press OK to lock it.
Press  to choose the End trim mark , then press OK. Press   to move the End position. When you're satisfied, press OK to lock it.
- 8 Press  to choose Done, then press the OK button. Follow the prompts to Save as New, Cancel, or Replace Original.

To return to picture-taking mode, press the Shutter button halfway down.

Making a picture from a video

You can choose a single frame from a video, then make it into a picture. (Size and quality depend on video resolution.)















- 1 Press the Review button .
- 2 Press   to choose Videos, then press OK.
Thumbnails are displayed.
- 3 Press  and  to choose Select Images, then press OK.
- 4 Press  and  to choose a video, then press OK.
- 5 Press  and  to choose the Edit icon .
- 6 Press  to choose Make Picture , then press the OK button.
- 7 Press  to play/pause the video, or to forward/rewind frame-by-frame.
- 8 When you reach the desired frame, press  and  to choose Make Picture , then press OK

The picture is created. (The original video is saved.)

To return to picture-taking mode, press the Shutter button halfway down.

Making an action print from a video

From a video, you can make a 9-up picture. (Size and quality depend on video resolution.)

- 1 Press the Review button .
- 2 Press   to choose Videos, then press OK.
Thumbnails are displayed.
- 3 Press  and   to choose Select Images, then press OK.
- 4 Press  and   to choose a video, then press OK.
- 5 Press  and   to choose the Edit icon .
- 6 Choose Action Print , then press OK.









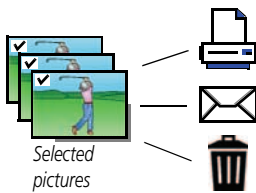

A 9-up picture is created.

To return to picture-taking mode, press the Shutter button halfway down.

Selecting multiple pictures/videos

Use the multi-select feature when you have two or more pictures to print, share, delete, tag with keyword, etc. Multi-select is only available in thumbnail view (see [page 22](#)).





- 1 Press the Review button .
- 2 Press   to choose a stack of pictures (All, or sorted by People, Date, Keywords, or Videos), then press OK.
- 3 If you chose All, People, Date, or Keywords, a single-up picture is shown. Press  and  to choose Multi-up , then press OK. (If you chose Videos, multi-up is already displayed.)
- 4 Press  and  to choose Select Images, then press OK.
- 5 Press    to choose a picture/video. Press OK to select it.
A check mark appears on the picture. (Press OK again to remove a check mark.) Repeat this step to select other pictures/videos.
- 6 You can now share, delete, choose a tool, etc. and apply it to the selected pictures/videos.

NOTE: You can also share multiple pictures/videos using the Share button ([see page 33](#)).

Displaying pictures/videos on a television

You can display pictures/videos on a television, computer monitor, or any device equipped with a composite video input. To connect the camera directly to a television, use a composite cable (may be sold separately).

Once you're connected, the camera becomes a "tethered remote." Use the camera buttons—Review , , , and OK— to control the pictures on your TV like you'd control them on your camera LCD.

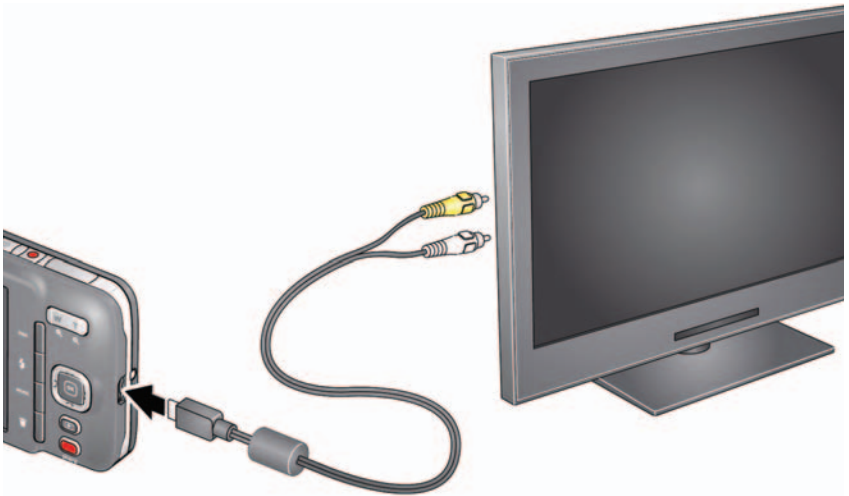

NOTE: Image quality on a television screen may not be as good as on a computer monitor or when printed.

Purchase accessories www.kodak.com/go/accessories

4

Sharing pictures/videos

Sharing through email and social networks

It's never been easier to share pictures on your favorite social networking sites. As new sites become available, they'll be offered when you connect the camera to a networked computer.

IMPORTANT: *To use the sharing and social networking features, you must install the KODAK Share Button App. (See page 42.)*

- 1 Press the Share button to share anytime:



- 2 Press ▲▼ and OK to choose social networking sites or email addresses.













- 3 Press ▲ to choose Done, then press OK.

When you transfer these pictures/videos to your computer, they are sent to the sharing destinations you chose.

Choose which social networking sites to display on your camera

You can show/hide networking sites on your camera so that only your favorite sites appear.















- 1 Press the Review button .
- 2 Press the Display button  until tools appear at the top of the LCD.
- 3 Press    to choose Settings , then press the OK button.
- 4 Press   to choose Edit Share Settings, then press OK.
- 5 Press   to choose Websites, then press OK.
- 6 Press OK to check/uncheck each social networking site.

When you are in Review and press the Share button, your chosen sites appear.

To return to picture-taking mode, press the Shutter button halfway down.

Manage email addresses and KODAK PULSE Digital Frames

You can add, edit, or delete email addresses and KODAK PULSE Digital Frames on your camera. (To use the keyboard, see [page 37](#).)

- 1 Press the Review button .
- 2 Press the Display button  until tools appear at the top of the LCD.
- 3 Press    to choose Settings , then press the OK button.
- 4 Press   to choose Edit Share Settings, then press OK.
- 5 Press   to choose Edit People, Websites, Title/Subject, or Message (to include when you share pictures). The keyboard appears when you need to type. (See [page 37](#).)
- 6 When finished, press     to choose Done or Next, then press OK.













Tagging pictures



Tag pictures to make them easy to find, later. You can tag pictures in 2 ways:

- **People**, and then find all pictures of “Mary.”
- **Keywords**, and then find all pictures from “Dad’s 60th Birthday.”

Tagging people

When you tag faces, you’re helping your camera to recognize people by name. Then it matches names and faces in pictures you’ve taken—and those you take in the future!

- 1 Press the Review button .
- 2 Press   to choose a stack of pictures (All, or sorted by People, Date, or Keywords), then press OK.
A single-up picture is shown. Press   to choose a different picture.
- 3 Press the Display button  until tools appear at the top of the LCD.
- 4 Press   to choose Tags , then press the OK button.
- 5 Press   to choose Tag People, then press OK.
- 6 Press   to choose an existing name or Enter New Name to add a new one (see [page 37](#)), then press OK.

If more than one face is detected, a name or question mark is assigned to each detected face. To resolve an incorrect name or a question mark, press   to select a face, then press OK.

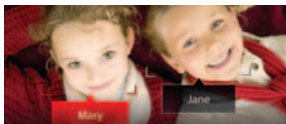















- 7 If prompted to Update People Tags, press   to choose Yes, then press OK.
Other pictures are scanned and updated with the name(s) you applied here. Press   to add names to other pictures. When finished, press   to choose Done, then press OK.

Need to update a name?

If you meet a new friend—James—but you already have pictures tagged with your old friend, James, you can:

- Tag the new James with “James Smith” and/or
- Update the old James to “James Monroe”

















Here’s how:

- 1 Press the Review button .
- 2 Press    to choose Settings , then press the OK button.
- 3 Press   to choose People Tag Settings (or Keyword Tag for videos), then press OK.
- 4 Press   to choose Modify Names List, then press OK.
- 5 Press   to choose the name you want to modify, then press OK. (The keyboard appears when you need to type. [See page 37.](#))
- 6 Edit the name, press   to choose OK, then press OK. (If prompted to Update People Tags, press   to choose Yes, then press OK.)

NOTE: You can have up to 20 names.





Tagging with keywords

Tag pictures to make them easy to find, later.

- 1 Press the Review button .
- 2 Press   to choose a stack of pictures (All, or sorted by People, Date, or Keywords), then press OK.
A single-up picture is shown. Press   to choose a different picture.
- 3 Press the Display button  until tools appear at the top of the LCD.
- 4 Press   to choose Tags , then press the OK button.
- 5 Press   to choose Keyword Tag, then press OK.
- 6 Press   to choose a tag (or  and  to add a tag using the "+" sign), then press OK.
- 7 Press  and  to choose Done, then press OK.









Using the keyboard

The keyboard appears when you need to type.

- 1 Press     to choose a letter, then press OK.
- 2 When finished, press  to choose Done, then press OK.

Marking pictures/videos as favorites

Mark pictures as favorites to make them easy to find, later.

- 1 Press the Review button .
- 2 Press  to choose a stack of pictures (All, or sorted by People, Date, Keywords, or Videos), then press OK.
- 3 Press the Display button  until tools appear at the top of the LCD.
- 4 Press  to choose Tags , then press OK.
- 5 Press  and  to choose Keyword Tags, then press OK.
- 6 Press  to choose Favorite, then press OK.
- 7 Press  to choose Done, then press OK.

5

Doing more with your camera

Changing settings

You can change settings to get the best results from your camera.

NOTE: Some modes offer limited settings. Some settings remain until you change them; others, until you change modes or turn off the camera.

- 1 In liveview or review mode, press the Display button **DISP.** until tools appear at the top of the LCD.
- 2 Press **▲◀▶** to choose Settings , then press the OK button.

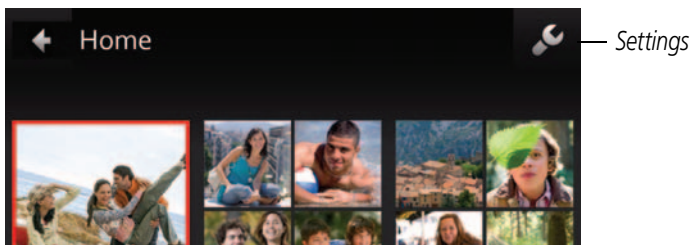

- 3 Press **▲▼** to choose a setting, then press OK.

NOTE: Some settings let you press **◀▶** to change a setting.

- 4 When finished with a setting, press OK.

Setting	More information
Edit Share Settings Choose the people and Web sites with whom you share pictures and videos.	Edit People —Add, modify, or delete people, email addresses, and digital picture frames so that you can share with your favorite people. Edit Web Sites —Decide which sites (such as KODAK Gallery, FACEBOOK, YouTube, etc.) are offered on your camera.

Setting	More information
People Tag Settings Maintain names and faces.	Update People Tags —Matches recently tagged people with other pictures that may include these people. Modify Names List —Edit or delete existing names.
Picture or Video Size Choose a picture or video resolution.	See Specifications, starting on page 49 .
Slide Show Settings Set your slide show preferences.	Transition —The visual effect between one slide and the next. Loop —The repeating of a slide show. Interval —The duration that a slide is shown.
AF Control (Still) Choose an auto-focus setting.	Continuous AF —Because the camera is always focusing, there is no need to press the Shutter button halfway down to focus. Single AF —Focuses when the Shutter button is pressed halfway down. (This setting uses less battery power.)
LCD Brightness Choose LCD brightness during picture/video capture. (During Review, the LCD is set to High Power.)	High Power —Brighter LCD; uses more battery power. Power Save —Dimmer LCD; uses less power. Auto —LCD brightness is automatically adjusted according to environment.
Sound Volume Choose volume.	High Medium Low Mute
Date & Time	Set date and time.
Language	Choose your language.
Reset All Camera Settings	Reset settings to their default.

Setting	More information
<p>Computer Connection</p> <p>Choose which application is downloaded or launched when you connect the camera to the computer.</p>	<p>KODAK Software</p> <p>Other Application (APPLE iPHOTO, etc.)</p> <p>IMPORTANT: <i>To use the social networking features, you must install the KODAK Share Button App (page 42).</i></p>
<p>Safe Mode</p> <p>In Safe mode, pictures/videos cannot be deleted or modified.</p>	<p>On</p> <p>Off</p>
<p>Format</p> <p> CAUTION: Formatting deletes all pictures/videos. Removing a card during formatting may damage the card.</p>	<p>Memory Card—Deletes everything on the card; formats the card.</p> <p>Cancel—Exits without making a change.</p> <p>Internal Memory—Deletes everything in internal memory including email addresses and keyword tags; formats the internal memory.</p>
<p>About</p>	<p>View camera information.</p>

6

Install software

Install software, transfer pictures, and share

IMPORTANT: *To use the sharing and social networking features, you must install the KODAK Share Button App.*

Make sure the computer is connected to the Internet. When you connect the camera to the computer, the KODAK Camera Setup App automatically runs. Follow the prompts to install the KODAK Share Button App.



- 1 Turn off the camera.
- 2 Use the KODAK Camera USB Cable, Micro B / 5-Pin to connect the camera to the computer. Use only the cable included with this camera.
- 3 Turn on the camera.

IMPORTANT: *If the app does not run, download and install the right version for your operating system:*
www.kodak.com/go/camerasw

- 4 After the software is installed, follow the prompts to transfer pictures and videos to your computer.

NOTE: You can also use a card reader to transfer pictures/videos.

Download KODAK Share Button App	www.kodak.com/go/camerasw
Get Software help	www.kodak.com/go/support
See How-To videos	www.kodak.com/go/m583demos

Printing pictures

Direct printing with a KODAK All-in-One Printer

IMPORTANT: To print using PICTBRIDGE Technology, you must change the Computer Connection setting (in the Settings menu) to Other Application (see page 41).

You need a camera, a PICTBRIDGE enabled Printer, and a USB cable.

Connecting the camera to a KODAK All-in-One Printer

- 1 Turn off the camera and printer.
- 2 Use the KODAK Camera USB Cable, Micro B / 5-Pin (included with the camera) to connect the camera to the printer.

Printing from a KODAK All-in-One Printer

- 1 Turn on the printer. Turn on the camera.

The PictBridge logo is displayed, followed by the current picture and menu. (If no pictures are found, a message is displayed.) If the menu turns off, press any button to redisplay it.

- 2 Choose a printing option, then press OK.

Current Picture—Press ◀▶ to choose a picture.

Tagged Pictures—If your printer is capable, print pictures that you marked for printing.

Index Print—Print thumbnails of all pictures. (This option requires one or more sheets of paper.)

All Pictures—Print all pictures in internal memory or on a card.

NOTE: During direct printing, pictures are not permanently transferred or saved to the printer. To transfer pictures to your computer, see page 42.

Purchase cables, accessories www.kodak.com/go/accessories

Ordering prints online







KODAK Gallery (www.kodakgallery.com) makes it easy to:

- Upload your pictures.
- Edit, enhance, and add borders to your pictures.
- Store pictures, and share them with family and friends.
- Have prints, photo greeting cards, frames, and albums delivered to your door.

Printing from an accessory MicroSD or MicroSDHC Card

- Automatically print tagged pictures when you insert your card into a printer. See your printer user's guide for details.
- Make prints at a KODAK Picture Kiosk. Go to www.kodak.com/go/picturemaker.
- Take the card to your local photo retailer for professional printing.

Marking pictures for print

- 1 Press the Review button .
- 2 Press   to choose a stack of pictures (All, or sorted by People, Date, or Keywords). Press OK until you see a single-up picture or press OK to choose multiple pictures.
- 3 Press the Display button  until tools appear at the top of the LCD.
- 4 Press  to choose Print, then press OK.
- 5 Press   to choose the number of copies, then press OK.

The pictures are printed when you transfer them to your computer.

To return to picture-taking mode, press the Shutter button halfway down.

7

Troubleshooting

Troubleshooting

Camera problems

Status	Solution
Short battery life	<ul style="list-style-type: none"> ■ Watch the battery level (see page 10). ■ Make sure the battery is charged (see page 2). ■ Limit the time you review pictures/videos on the camera LCD. ■ Purchase a spare battery at www.kodak.com/go/accessories.
Camera does not turn on/off or function	<ul style="list-style-type: none"> ■ Make sure the battery is installed correctly (see page 1) and charged (see page 2).
LCD is too dark.	<ul style="list-style-type: none"> ■ Adjust the LCD Brightness setting in the Settings menu (see page 40).
Flash does not fire	<ul style="list-style-type: none"> ■ The flash does not fire in all modes. Change modes as needed (see page 13).
Memory card is almost or entirely full	<ul style="list-style-type: none"> ■ Transfer the pictures to the computer (see page 42). ■ Delete pictures from the card (see page 21) or insert a new card.
You cannot take a picture	<ul style="list-style-type: none"> ■ Turn the camera off, then on again. ■ Depress the Shutter button all the way (see page 7). ■ Insert a new/charged battery (see page 1). ■ Memory is full. Transfer pictures to the computer (see page 42), delete pictures (see page 21), or insert another card.
Pictures remaining number does not decrease after taking a picture	<ul style="list-style-type: none"> ■ Continue taking pictures. The camera is operating normally. (The camera estimates the number of pictures remaining after each picture is taken, based on picture size and content.)

Status	Solution
Memory card not recognized or camera freezes with card	<ul style="list-style-type: none">■ Card may be corrupted. Format the card in the camera (see page 41). CAUTION: Everything on the card is erased.■ Use another memory card. Only MicroSD or MicroSDHC Cards are supported.
Cannot find the desired picture/video	<ul style="list-style-type: none">■ To view pictures on a card or in internal memory, see page 19.

Computer/connectivity problems

Status	Solution
Computer does not communicate with the camera	<ul style="list-style-type: none">■ Turn off the camera, then turn it back on.■ Make sure the battery is installed correctly (see page 1) and charged (see page 2).■ Make sure the KODAK Camera USB Cable, Micro B / 5-Pin is connected to the camera and the computer (see page 42). Then turn on the camera.■ See KODAK Software Downloads at www.kodak.com/go/camerasw.

Direct printing (PICTBRIDGE enabled Printer) problems

Status	Solution
Cannot print	<ul style="list-style-type: none">■ Change the Computer Connection setting (in the Settings menu) to Other Application (see page 41).

Picture quality problems

Status	Solution
Picture is not clear	<ul style="list-style-type: none"> ■ To automatically set exposure and focus, press the Shutter button halfway. When the framing marks turn green, press the Shutter button completely down to take the picture. ■ Clean the lens (see page 51). ■ Place the camera on a flat, steady surface or use a tripod (especially in high-zoom settings or in low light). ■ Use a larger picture size (see page 40). ■ If you're manually adjusting the ISO speed, realize that a high ISO setting may cause grainy pictures (see page 16).
Picture is too dark	<ul style="list-style-type: none"> ■ Reposition the camera for more available light. ■ Use Fill flash (see page 13) in Program mode, change your position so light is not behind the subject, or use the Backlight SCN mode. ■ Move so that the distance between you and the subject is within the effective flash range. (See Specifications starting on page 49.) ■ To automatically set exposure and focus, press the Shutter button halfway. When the framing marks turn green, press the Shutter button completely down to take the picture. ■ In Program mode, increase the Exposure Compensation (see page 16).
Picture is too light	<ul style="list-style-type: none"> ■ Reposition the camera to reduce the amount of available light. ■ Turn the flash off (see page 13). ■ Move so that the distance between you and the subject is within the effective flash range. (See Specifications starting on page 49.) ■ To automatically set exposure and focus, press the Shutter button halfway. When the framing marks turn green, press the Shutter button completely down to take the picture. ■ In Program mode, decrease the Exposure Compensation (see page 16).

Getting help on the Web

Get support for your product (FAQs, troubleshooting information, etc.)	www.kodak.com/go/m583support
--	--

Download the latest camera firmware and software	www.kodak.com/go/m583downloads
--	--

See videos of your camera	www.kodak.com/go/m583demos
---------------------------	--

Purchase camera accessories	www.kodak.com/go/accessories
-----------------------------	--

Register your camera	www.kodak.com/go/register
----------------------	--

Chat, email, write, or phone Kodak (Chat not available in all languages)	www.kodak.com/go/contact
---	--

8

Appendix

Specifications

CCD—1/2.3-type

Effective pixels—14 MP (4352 x 3264)

LCD—3.0 in. (6.9 cm) LCD; 230K dots; 4:3 aspect ratio

Image storage—Accessory MicroSD/SDHC Card  (The SD logo is a trademark of the SD Card Association.) Maximum supported card size: 32 GB

Internal storage capacity—32 MB internal memory (18 MB available for image storage. 1 MB equals one million bytes.)

Taking lens—8X optical zoom; f/3.3–f/5.8; 35 mm equivalent: 28–224 mm

Digital zoom—5X continuous

Focus system—TTL-AF (through-the-lens auto focus); Multi-Zone, Center-Zone, Face Priority. Working range:

0.6 m (2.0 ft)—infinity @ wide, normal

2.0 m (6.6 ft)—infinity @ telephoto, normal

0.1–0.7 m (0.3–2.3 ft) @ wide, Macro mode

1.0–2.1 m (3.3–6.9 ft) @ telephoto, Macro mode

Auto focus control—Continuous and Single AF

Face detection—Yes

Face recognition—Yes

Shutter speed—1/8–1/1600 seconds

Long time exposure—1/2–8 seconds

ISO speed—Auto: 64–400; Manual: 64, 100, 200, 400, 800, 1600

Focus/Exposure Zone—TTL-AE; Face Priority, Multi-Zone, Center-Zone

Exposure compensation—+/-2.0 EV with 1/3 EV step

White Balance—Auto, Daylight, Tungsten, Fluorescent, Open Shade

Electronic Flash—Auto flash; Auto, Fill, Red Eye, Off; Guide No. 5.9 (m) @ ISO 400; working range in Smart Capture mode: 0.6–3.4 m (2–11.2 ft) @ wide; 0.7–2.0 m (2.3–6.6 ft) @ telephoto

Self-timer mode—2 seconds, 10 seconds, 2 picture timer

Burst mode—Maximum 3 pictures @ 1.5 fps

Capture modes—Smart Capture, Film Effects, Scene modes, Photobooth, Video (see [page 14](#))

Image file format—

Still: EXIF 2.3 (JPEG compression); file organization DCF

Video: MP4, CODEC H.264

Picture size—14 MP (4:3): 4288 x 3216 pixels

12 MP (3:2): 4288 x 2848 pixels

10 MP (16:9): 4288 x 2416 pixels

6 MP (4:3): 2880 x 2160 pixels

3 MP (4:3): 2048 x 1536 pixels

Video size—

HDV (1280 x 720 @ 30 fps)

VGA (640 x 480 @ 30 fps)

Recording limit—VGA: < 4 GB; HD: < 4 GB or < 29 mins.

Color modes—Vivid Color, Full Color, Basic Color, Black & White, Sepia

Sharpness modes—Sharp, Normal, Soft

Communication with computer—USB 2.0 high speed (PIMA 15740 protocol); via KODAK Camera USB Cable, Micro B / 5-Pin

Microphone—Yes

Speaker—Yes

PICTBRIDGE support—Yes

Power—KODAK Li-Ion Rechargeable Digital Camera Battery KLIC-7006; 5V AC

Tripod mount—1/4 inch

Size—99.8 x 57.1 x 23.9 mm (3.9 x 2.2 x 0.9 in.) @ power off

Weight—150 g (5.3 oz) with battery and card

Operating temperature—0–40° C (32–104° F)

Care and maintenance

- If you suspect water has gotten inside the camera, remove the battery and card. Allow all components to air-dry for at least 24 hours before using the camera.
- Blow gently on the lens or LCD to remove dust and dirt. Wipe gently with a soft, lint-free cloth or an untreated lens-cleaning tissue. Do not use cleaning solutions unless designed specifically for camera lenses. Do not allow chemicals, such as suntan lotion, to contact painted surfaces.
- Service agreements may be available in your country. Contact a dealer of KODAK Products for more information.
- For digital camera disposal or recycling information, contact your local authorities. In the US, go to the Electronics Industry Alliance site at www.eiae.org or go to www.kodak.com/go/support.

Upgrading your software and firmware

We occasionally update KODAK Software and firmware (the software that runs on the camera). Download the latest versions: www.kodak.com/go/m583downloads.

Storage capacities

The LCD displays the approximate number of pictures (or minutes/seconds of video) remaining. Actual storage capacity varies depending on subject composition, card size, and other factors. You may be able to store more or fewer pictures and videos.

Important safety instructions



CAUTION:

Do not disassemble this product; there are no user-serviceable parts inside. Refer servicing to qualified service personnel. KODAK AC Adapters and Battery Chargers are intended for indoor use only. The use of controls, adjustments, or procedures other than those specified herein may result in exposure to shock and/or electrical or mechanical hazards. If the LCD breaks, do not touch the glass or liquid. Contact Kodak customer support.

- The use of an accessory that is not recommended by Kodak may cause fire, electric shock, or injury. For approved accessories, go to www.kodak/go/accessories.
- Use only a USB-certified computer equipped with a current-limiting motherboard. Contact your computer manufacturer if you have questions.
- If using this product in an airplane, observe all instructions of the airline.
- When removing the battery, allow it to cool; it may be hot.
- Follow all warnings and instructions supplied by the battery manufacturer.
- Use only batteries approved for this product to avoid risk of explosion.
- Keep batteries out of the reach of children.
- Do not allow batteries to touch metal objects, including coins. Otherwise, a battery may short circuit, discharge energy, become hot, or leak.
- Do not disassemble, install backward, or expose batteries to liquid, moisture, fire, or extreme temperature.

- Remove the battery when the product is stored for an extended period of time. In the unlikely event that battery fluid leaks inside the product, contact Kodak customer support.
- In the unlikely event that battery fluid leaks onto your skin, wash immediately with water and contact your local health provider. For additional health-related information, contact your local Kodak customer support.
- Go to www.kodak.com/go/reach for information about the presence of substances included on the candidate list according to article 59(1) of Regulation (EC) No. 1907/2006 (REACH).
- Dispose of batteries according to local and national regulations. Go to www.kodak.com/go/kes.
- Do not charge non-rechargeable batteries. For more information on batteries, go to www.kodak.com/go/batterychart.

Battery replacement, battery life

KODAK Li-Ion Rechargeable Digital Camera Battery KLIC-7006: 200 pictures per charge. Battery life per CIPA testing method. (Approximate number of pictures in Smart Capture mode, using a MicroSD Card.) Actual life may vary based on usage.

Extending battery life

- Use a power-saving LCD Brightness setting (see page 40).
- Charge the battery whenever necessary.
- Dirt on the battery contacts can affect battery life. Wipe the contacts with a pencil eraser before loading the battery in the camera.
- Battery performance is reduced at temperatures below 41° F (5° C). When using your camera in cold weather, carry spare batteries and keep them warm. Do not discard cold batteries that do not work; when they return to room temperature, they may be usable.

Limited warranty

Kodak warrants its digital cameras and accessories (excluding batteries) to be free from malfunctions and defects in both materials and workmanship for the warranty period specified on your KODAK Product packaging. Retain the original dated sales receipt. Proof of purchase date is required with any request for warranty repair.

Limited warranty coverage

Warranty service is only available from within the country where the Products were originally purchased. You may be required to ship Products, at your expense, to the authorized service facility for the country where the Products were purchased. Kodak will repair or replace Products if they fail to function properly during the warranty period, subject to any conditions and/or limitations stated herein. Warranty service will include all labor as well as any necessary adjustments and/or replacement parts. If Kodak is unable to repair or replace a Product, Kodak will, at its option, refund the purchase price paid for the Product provided the Product has been returned to Kodak along with proof of the purchase price paid. Repair, replacement, or refund of the purchase price are the sole remedies under the warranty. If replacement parts are used in making repairs, those parts may be remanufactured, or may contain remanufactured materials. If it is necessary to replace the entire Product, it may be replaced with a remanufactured Product. Remanufactured Products, parts and materials are warranted for the remaining warranty term of the original Product, or 90 days after the date of repair or replacement, whichever is longer.

Limitations

This warranty does not cover circumstances beyond Kodak's control. This warranty does not apply when failure is due to shipping damage, accident, alteration, modification, unauthorized service, misuse, abuse, use with incompatible accessories or attachments (such as third party ink or ink tanks), failure to follow Kodak's operation, maintenance or repacking instructions, failure to use items supplied by Kodak (such as adapters and cables), or claims made after the duration of this warranty. Kodak makes no other express or implied warranty for this product. In the event that the exclusion of any implied warranty is ineffective under the law, the duration of the implied warranty will be the length of the express warranty period

specified on your Kodak product packaging. The option of repair, replacement, or refund is Kodak's only obligation. Kodak will not be responsible for any special, consequential or incidental damages resulting from the sale, purchase, or use of this product regardless of the cause. Liability for any special, consequential or incidental damages (including but not limited to loss of revenue or profit, downtime costs, loss of the use of the equipment, cost of substitute equipment, facilities or services, or claims of your customers for such damages resulting from the purchase, use, or failure of the Product), regardless of cause or for breach of any written or implied warranty is expressly disclaimed. The limitations and exclusions of liability set forth herein apply to both Kodak and its suppliers.

Your rights

Some states or jurisdictions do not allow exclusion or limitation of incidental or consequential damages, so the above limitation or exclusion may not apply to you. Some states or jurisdictions do not allow limitations on how long an implied warranty lasts, so the above limitation may not apply to you. This warranty gives you specific rights, and you may have other rights which vary from state to state or by jurisdiction.

Outside the United States and Canada

In countries other than the United States and Canada, the terms and conditions of this warranty may be different. Unless a specific Kodak warranty is communicated to the purchaser in writing by a Kodak company, no warranty or liability exists beyond any minimum requirements imposed by law, even though defect, damage, or loss may be by negligence or other act.

Regulatory compliance

FCC compliance and advisory

This equipment has been tested and found to comply with the limits for a Class B digital device, pursuant to Part 15 of the FCC Rules. These limits are designed to provide reasonable protection against harmful interference in a residential installation. This equipment generates, uses, and can radiate radio frequency energy and, if not installed or used in accordance with the instructions, may cause harmful

interference to radio communications. However, there is no guarantee that interference will not occur in a particular installation. If this equipment does cause harmful interference to radio or television reception, which can be determined by turning the equipment off and on, the user is encouraged to try to correct the interference by one or more of the following measures: 1) reorient or relocate the receiving antenna; 2) increase the separation between the equipment and the receiver; 3) connect the equipment to an outlet on a circuit different from that to which the receiver is connected; 4) consult the dealer or an experienced radio/TV technician for additional suggestions. Any changes or modifications not expressly approved by the party responsible for compliance could void the user's authority to operate the equipment. Where shielded interface cables have been provided with the product or specified additional components or accessories elsewhere defined to be used with the installation of the product, they must be used in order to ensure compliance with FCC regulation. The KODAK High Performance USB AC Adapter K20-AM complies with part 15 of the FCC Rules. Operation is subject to the following two conditions: (1) This device may not cause harmful interference, and (2) this device must accept any interference received, including interference that may cause undesired operation.

Waste Electrical and Electronic Equipment/Battery disposal



In Europe: For human/environmental protection, it is your responsibility to dispose of this equipment and batteries at a collection facility established for this purpose (separate from municipal waste.) For more information, contact your retailer, collection facility, or appropriate local authorities; or go to www.kodak.com/go/recycle. Product weight: 150 g (5.3 oz) with battery



Canadian DOC statement

DOC Class B Compliance—This Class B digital apparatus complies with Canadian ICES-003.

Observation des normes-Classe B—Cet appareil numérique de la classe B est conforme à la norme NMB-003 du Canada.

CE

Hereby, Eastman Kodak Company declares that this KODAK Product is in compliance with the essential requirements and other relevant provisions of Directive 1999/5/EC.

Australian C-Tick



VCCI Class B ITE

この装置は、クラスB情報技術装置です。この装置は、家庭環境で使用することを目的としていますが、この装置がラジオやテレビジョン受信機に近接して使用されると、受信障害を引き起こすことがあります。

取扱説明書に従って正しい取り扱いをして下さい。

VCCI-B

China RoHS

环保使用期限 (EPUP)

在中国大陆，该值表示产品中存在的任何危险物质不得释放，以免危及人身健康、财产或环境的时间期限（以年计）。该值根据操作说明中所规定的产品正常使用而定。

有毒有害物质或元素名称及含量标识表

部件名称	有毒有害物质或元素					
	铅	汞	镉	六价铬	多溴联苯	多溴二苯醚
数码相机电路板元件	×	○	○	○	○	○
锂电池	×	○	○	○	○	○
交流变压器	×	○	○	○	○	○
电池充电器	×	○	○	○	○	○

○：表示该有毒有害物质在该部件所有均质材料中的含量均在SJ/T 11363-2006规定的限量要求以下。
 ×：表示该有毒有害物质至少在该部件的某一均质材料中的含量超出SJ/T 11363-2006规定的限量要求。



USB 数据线

Korean Class B ITE

B급 기기
(가정용 방송통신기기)

이 기기는 가정용(B급)으로 전자파적합등록을 한 기기로서 주로 가정에서 사용하는 것을 목적으로 하며, 모든 지역에서 사용할 수 있습니다.

Korean Li-Ion Regulatory

취급상의 주의사항

- < 경고 > 발열, 화재, 폭발 등의 위험을 수반할 수 있으니 다음 사항을
- 육안으로 식별이 가능할 정도의 부풀음이 발생한 전지는 위험할 수 있으므로 제조자 또는 판매자로 즉시 문의할 것
 - 지정된 정품 충전기만을 사용할 것
 - 화기에 가까이 하지 말 것(전자레인지에 넣지 말 것)
 - 여름철 자동차 내부에 방치하지 말 것
 - 찜질방 등 고온다습한 곳에서 보관, 사용하지 말 것
 - 이불, 전기장판, 카펫 위에 올려 놓고 장시간 사용하지 말 것
 - 전원을 켜 상태로 밀폐된 공간에 장시간 보관하지 말 것
 - 전지 단자에 목걸이, 동전, 열쇠, 시계 등 금속 제품이 닿지 않도록 주의할 것
 - 휴대 기기, 제조업체가 보증한 리튬2차전지 사용할 것
 - 분해, 압착, 관통 등의 행위를 하지 말 것
 - 높은 곳에서 떨어뜨리는 등 비정상적 충격을 주지 말 것.
 - 60℃ 이상의 고온에 노출하지 말 것
 - 습기에 접촉되지 않도록 할 것

기타정보

- 폐기지침 : 각 지방자치단체의 법규에 의거하여 폐기할 것
- 충전방법에 대한 권고지침
 - 본 충전지와 함께 사용할 디지털카메라 사용자 설명서의 충전설명 참조하세요.
 - 코닥 정품 충전기 및 카메라에서만 충전하세요. (타사 충전셋 사용 금지)

제조년월 : Y = Year(제조년도의 마지막 숫자), WW = Week(제조년도의 주)

제조년월 표시 예 : 901 = 9 (2009년), 01 (첫째주)

Russian GOST-R



Eastman Kodak Company
Rochester, NY 14650

Фотокамера изготовлена в Китае, остальные элементы -
АЮ-40 в соответствии с маркировкой.

Index

A

- A/V out, 32
- about this camera, 41
- accessories
 - battery, 53
 - buying, 48
 - MicroSD/SDHC Card, 6
- action print, 30
- add keywords, names, 37
- adding a border, 25
- AF control, 40
- auto
 - focus control, 40
 - focus framing marks, 7

B

- backlight, 14
- battery
 - charging, 2
 - expected life, 53
 - icons, 10
 - loading, 1
 - types, 53
- beach, 14
- brightness, LCD, 11
- burst, 17
- button
 - delete, 7
 - Mode, 14
 - Review, 39
 - telephoto/zoom, 12

C

- cable
 - audio/video, 32
- Camera Setup App, 42
- camera sounds, 40
- Canadian compliance, 56
- care and maintenance, 51
- charging
 - battery icon, 10
 - USB, 4
- charging the battery, 2
- children, 14
- clock, setting, 5
- computer
 - connect camera, 42
 - transfer to, 42
- computer connection, 41
- connector, USB / A/V, 32
- copy pictures
 - to computer, 42
- cropping pictures, 27

D

- date setting, 5
- deleting
 - during quickview, 7
 - from internal memory, 21
 - from MicroSD/SDHC Card, 21
- digital zoom, 12
- display, brightness, 11
- disposal, recycling, 51
- download

KODAK Software, 42
download pictures, 42

E

edit videos, 28
email, 33
emailing pictures, videos, 38
erase, 41
expected battery life, 53
exposure
 long time, 39
external video device
 viewing pictures, videos, 32

F

faces, tagging, recognition, 35
FCC compliance, 55
find pictures, 23
fireworks, 15
firmware, upgrading, 51
flash, using, 13
flower, 14
focus framing marks, 7
format, 41
framing marks, 7

G

guidelines, battery, 53

H

help
 Web links, 45
high ISO, 15

I

icons
 battery, 10
icons, modes, 14
installing
 battery, 1
 MicroSD/SDHC Card, 6

K

keyboard, 37
keywords, 37
KODAK Camera Setup App, 42
KODAK EASYSHARE Software
 upgrading, 51
KODAK Software, download, 42
Kodak Web sites, 45

L

language, 40
LCD
 brightness, 40
 reviewing pictures, 19
 reviewing videos, 19
LCD brightness, 11
lens
 cleaning lens, 51
loading
 battery, 1
 MicroSD/SDHC Card, 6
locate pictures, 23
long time exposure, 39

M

magnify a picture, 22
maintenance, camera, 51

make picture from video, 29

marking

for email, 38

memory

inserting card, 6

menu settings, 39

MicroSD/SDHC Card

inserting, 6

printing from, 44

mode

safe, 41

Mode button, 14

modes, 14

backlight, 14

beach, 14

children, 14

fireworks, 15

flower, 14

high ISO, 15

night landscape, 15

night portrait, 15

self-portrait, 15

multiple selections, 31

multi-up, thumbnail, 22

N

night landscape, 15

night portrait, 15

O

online prints, ordering, 44

optical zoom, 12

P

panoramic pictures, 18

people, tagging, 35

photo effect, tinting, 26

photobooth, 15

PICTBRIDGE enabled printer, 43

picture size, 40

pictures

border, adding, 25

cropping, 27

emailing marked, 38

marking, 44

review icons, 24

reviewing, 19

taking, modes, 14

tinting, 26

transfer to computer, 42

pictures/video

deleting, 21

playing a video, 21

power

camera, 5

power icon, 10

print from a video, 30

printing

from a card, 44

optimizing printer, 45

order online, 44

PICTBRIDGE, 43

tagged pictures, 44

Q

quickview, using, 7

R

recycling, disposal, 51

regulatory information, 55
reset camera, 40
Review button, 39
reviewing pictures/video
 as you take them, 7
 deleting, 21
 LCD, 19

S

safe mode, 41
safety, 52
search pictures, 23
select multiple pictures/videos, 31
self-portrait, 15
self-timer, 17
setting
 about this camera, 41
 auto focus, 40
 camera sounds, 40
 computer connection, 41
 date and time, 5
 format, 41
 language, 40
 LCD brightness, 40
 long time exposure, 39
 picture size, 40
 picture-taking mode, 14
 reset all settings, 40
 safe mode, 41
 self-timer, 17
 slide show, 40
 tag people, 40
setting up the camera, 1
settings

 picture, video size, 40
 Share, 39
settings menu, 39
Share settings, 39
shutter
 problems, 45
 self-timer delay, 17
single frame, 30
slide show settings, 40
smart find, 23
social networks, 33
software
 upgrading, 51
software downloader, 42
sounds, 40
specifications, camera, 49
strap, 1

T

tag people setting, 40
tagging
 keywords, 37
 people, faces, 35
taking pictures, videos, 7
television, slide show, 32
thumbnail view, 22
time, setting, 5
timer, shutter delay, 17
tinting a picture, 26
tips
 battery guidelines, 53
 care & maintenance, 51
transfer pictures, 42
trash can, deleting, 7

trimming a video, 28
troubleshooting, 45
turning camera on and off, 5
typing, 37

U

upgrading software, firmware, 51
URLs, Kodak Web sites, 45
USB
 transfer pictures, 42
USB charging, 4

V

VCCI compliance, 57
video
 edit, 28
 emailing marked, 38
 playback, 21
 review icons, 24
 transfer to computer, 42
 viewing, 19
video action print, 30
video size, 40
viewing
 by multi-up, thumbnails, 22
 picture, after taking, 7, 19

W

warranty, 54

Z

zoom
 digital, 12
 optical, 12

Free Manuals Download Website

<http://myh66.com>

<http://usermanuals.us>

<http://www.somanuals.com>

<http://www.4manuals.cc>

<http://www.manual-lib.com>

<http://www.404manual.com>

<http://www.luxmanual.com>

<http://aubethermostatmanual.com>

Golf course search by state

<http://golfingnear.com>

Email search by domain

<http://emailbydomain.com>

Auto manuals search

<http://auto.somanuals.com>

TV manuals search

<http://tv.somanuals.com>