Kodak EasyShare C875 zoom digital camera



User's guide

www.kodak.com

For interactive tutorials, www.kodak.com/go/howto

For help with your camera, www.kodak.com/go/c875support

Kodak

Eastman Kodak Company

Rochester, New York 14650

© Eastman Kodak Company, 2006

All screen images are simulated.

Kodak, EasyShare, and Perfect Touch are trademarks of Eastman Kodak Company.

Schneider-Kreuznach and Xenar are trademarks of Jos. Schneider Optische Werke GmbH used under license by Eastman Kodak Company.

Panorama Stitching Technology developed by ArcSoft, Inc. © 2004–2005, ArcSoft, Inc. All rights reserved.

P/N4J4806_en

Front view

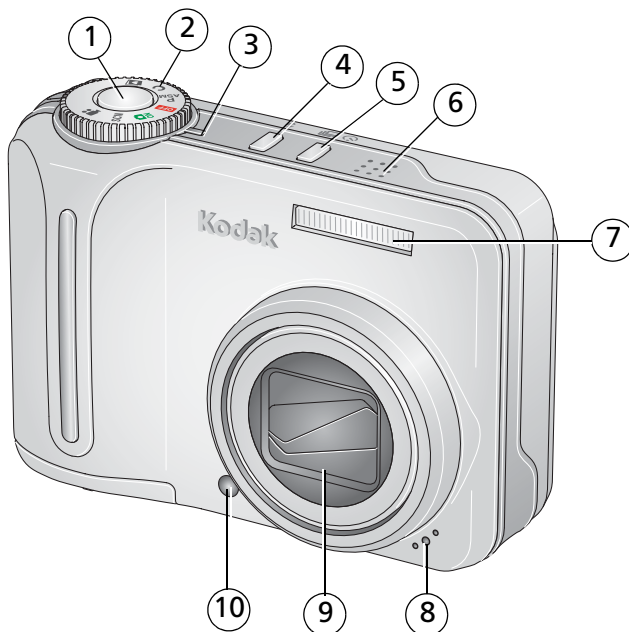

- | | | | |
|---|-------------------------|----|----------------------------|
| 1 | Shutter button | 6 | Speaker |
| 2 | Mode dial | 7 | Flash |
| 3 | Power light | 8 | Microphone |
| 4 | Flash button | 9 | Lens |
| 5 | Self-timer/Burst button | 10 | Self-timer/AF Assist light |

Back view

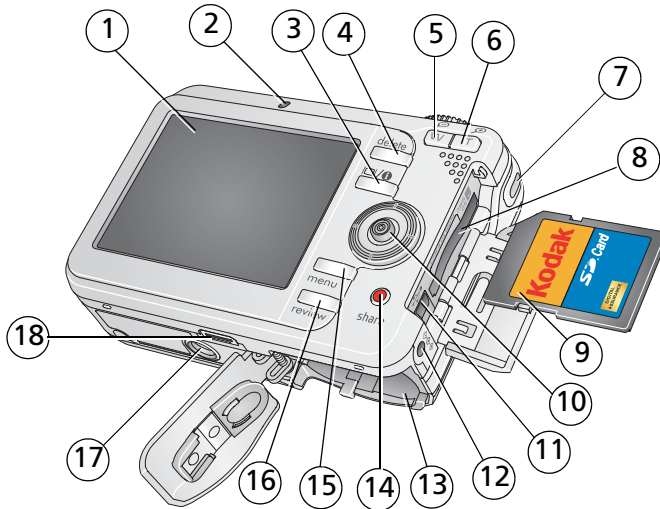

- | | |
|------------------------------------|---|
| 1 LCD | 10 Joystick ( , press for OK) |
| 2 Ready light | 11 USB, A/V Out |
| 3 LCD/Info/Help button | 12 DC-In (3V), for optional AC adapter |
| 4 Delete button | 13 Share button |
| 5 Zoom lever W (Wide angle) | 14 Battery compartment |
| 6 Zoom lever T (Telephoto) | 15 Menu button |
| 7 Strap post | 16 Review button |
| 8 Slot for optional SD or MMC card | 17 Tripod socket |
| 9 SD or MMC card | 18 Dock connector |

Table of contents

1	Setting up your camera	1
	Installing the software.....	1
	Attaching the strap	1
	Loading the battery.....	2
	Turning on the camera	3
	Setting the language, date/time first time	4
	Storing pictures on an SD or MMC card	5
2	Taking pictures and videos	6
	Taking a picture	6
	Reviewing pictures and videos on your camera	11
3	Transferring and printing pictures	14
	Installing the software.....	14
	Transferring pictures.....	15
	Printing pictures.....	16
	Dock compatibility for your camera.....	19
4	Doing more with your camera	20
	Using optical zoom	20
	Using the flash.....	21
	Picture-taking modes	22
	Taking panoramic pictures.....	26
	Using exposure compensation to adjust brightness	27
	Using the histogram to view picture brightness.....	27
	Using PASM/C mode settings	28
	Using the self-timer	30
	Using burst	31
	Using camera Help	32
	Changing picture-taking settings	33
	Customizing your camera	37
	Running a slide show	39

Using Kodak Perfect Touch technology	41
Cropping pictures.....	41
Editing videos	42
Viewing pictures/videos in different ways.....	43
Selecting multiple pictures/videos	44
Copying pictures and videos	44
Pre-tagging for album names	45
Tagging pictures/videos for albums.....	46
Sharing your pictures.....	47
5 Troubleshooting	52
Camera problems.....	52
Computer/connectivity problems.....	54
Picture quality problems	54
Camera ready-light status	56
Direct printing (PictBridge enabled printer) problems.....	57
6 Getting help	58
Helpful links.....	58
Telephone customer support	59
7 Appendix	60
Camera specifications	60
Storage capacities.....	63
Important safety instructions	64
Battery safety and handling.....	64
Upgrading your software and firmware.....	66
Additional care and maintenance	66
Warranty.....	67
Regulatory compliance	69

1

Setting up your camera

Installing the software

IMPORTANT: Before connecting any cables, install the software that was included with your camera. For details, see [Transferring and printing pictures, page 14](#).

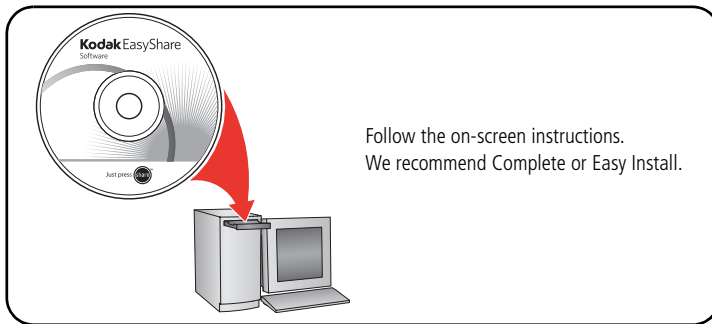

Attaching the strap

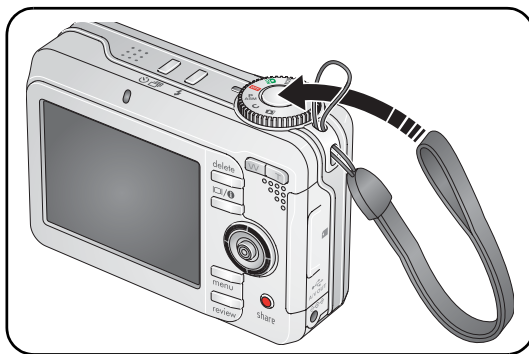

Loading the battery

If your package does not include a charger or dock...

Install other batteries as shown.

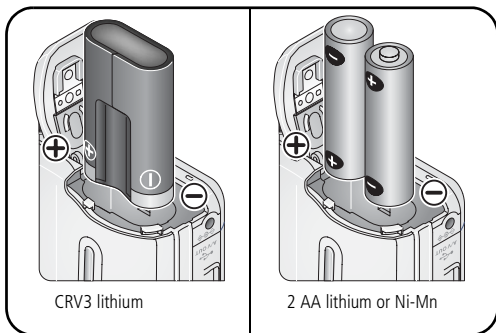

See [Extending battery life, page 66](#).

If your package includes a battery charger...

Use the charger to charge the Kodak Ni-MH rechargeable digital camera battery.

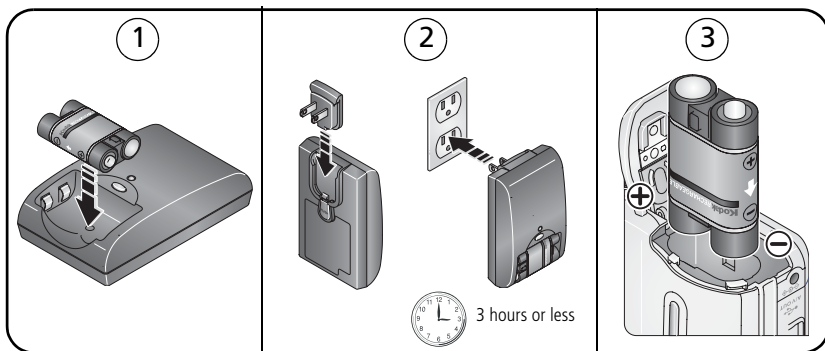

If your package includes an EasyShare dock...

Use the camera dock or printer dock to charge the Kodak Ni-MH rechargeable digital camera battery. (See the dock user's guide for details.)

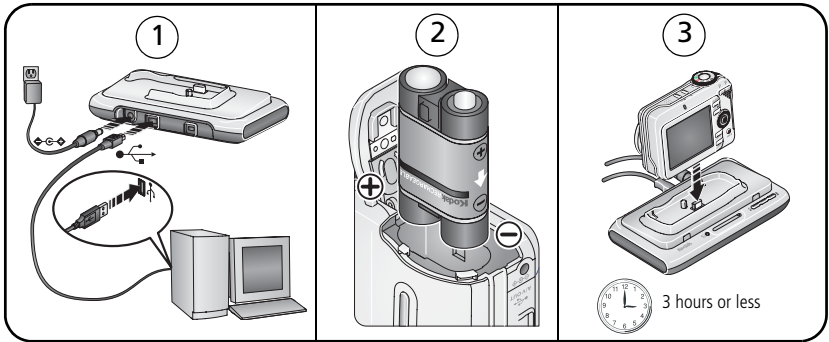

Turning on the camera

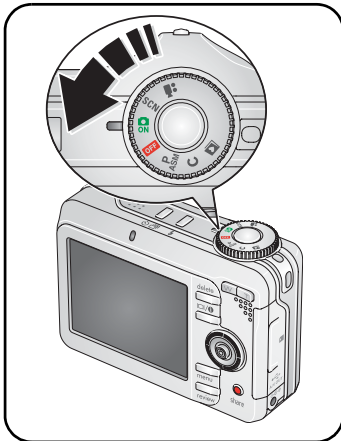

Setting the language, date/time first time

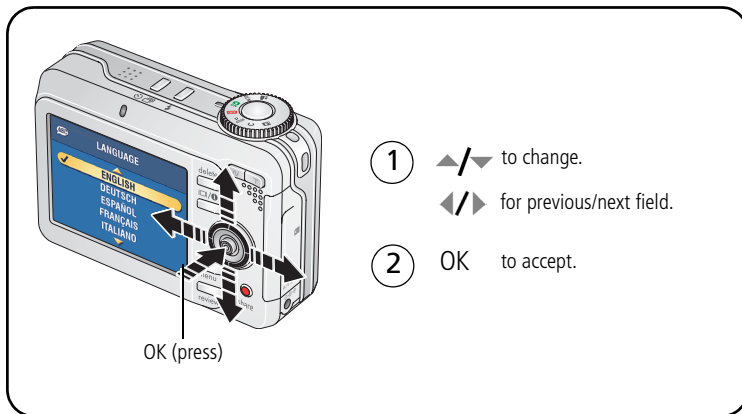

Setting the language, date/time other times

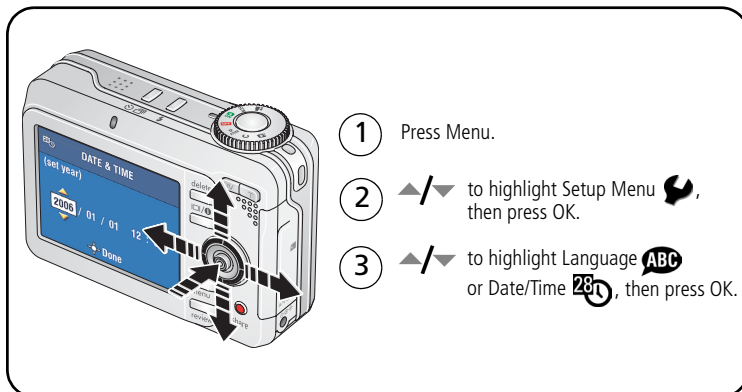

Storing pictures on an SD or MMC card

Your camera has internal memory. You can purchase an SD or MMC card to conveniently store more pictures and videos.

NOTE: When using the card for the first time, format it in this camera before taking pictures (see [Customizing your camera, page 37](#)). We recommend Kodak SD or MMC cards.

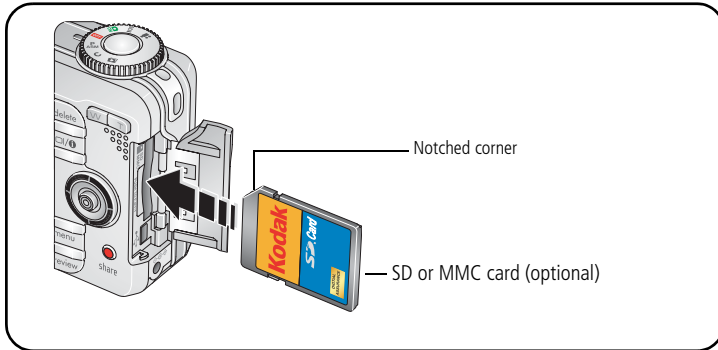

CAUTION:

A card can only be inserted one way; forcing it may cause damage. Inserting or removing a card when the Ready light is blinking may damage the pictures, the card, or the camera.

See [Storage capacities, page 63](#). Purchase SD or MMC cards at a dealer of Kodak products or www.kodak.com/go/c875accessories.

Reviewing the picture or video just taken

After you take a picture or video, the LCD displays a quickview for approximately 5 seconds. The picture or video is saved unless you press the Delete button.

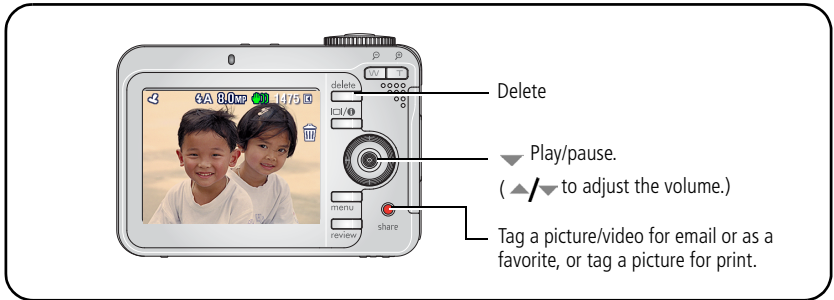

To view pictures and videos anytime, see [Reviewing pictures and videos on your camera, page 11](#).

Understanding quickview blur warning icons

A picture blur warning icon  is displayed during quickview.

Green—Picture is sharp enough for an acceptable 4 x 6-inch (10 x 15 cm) print.

Yellow—Picture may be sharp enough for an acceptable 4 x 6-inch (10 x 15 cm) print or sharpness is not determined.

Red—Picture is not sharp enough for an acceptable 4 x 6-inch (10 x 15 cm) print.

White—Printability is still being determined.

To turn off the blur warning feature, see [Customizing your camera, page 37](#).

Understanding picture-taking icons

In Smart Scene mode —no buttons pressed

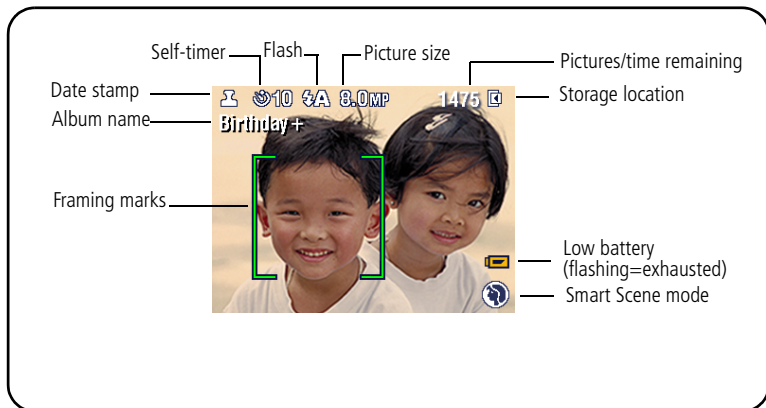

In Smart Scene mode —shutter pressed halfway

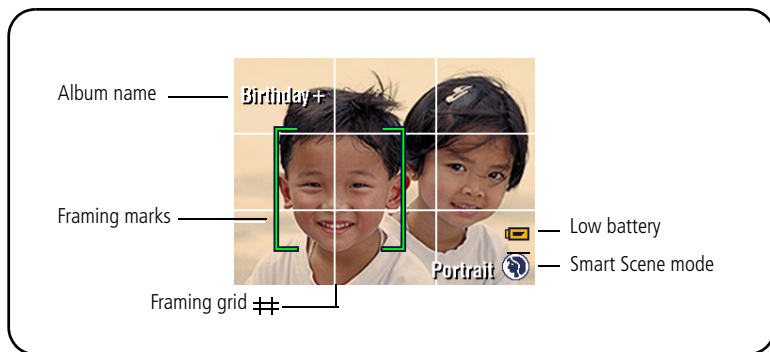

In manual mode (PASM/C)—no buttons pressed

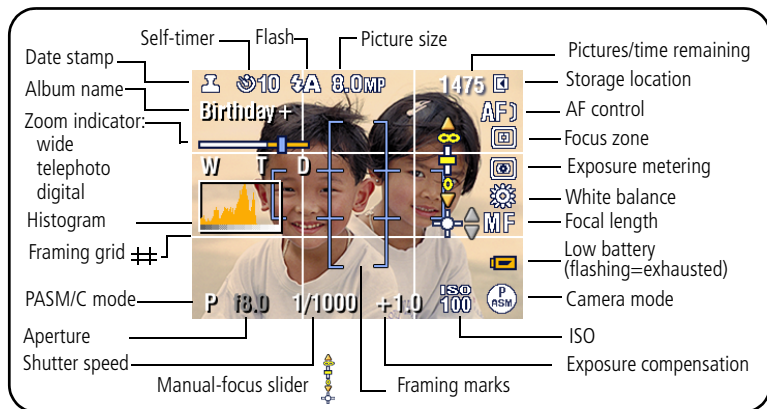

In manual mode (PASM/C)—shutter pressed halfway

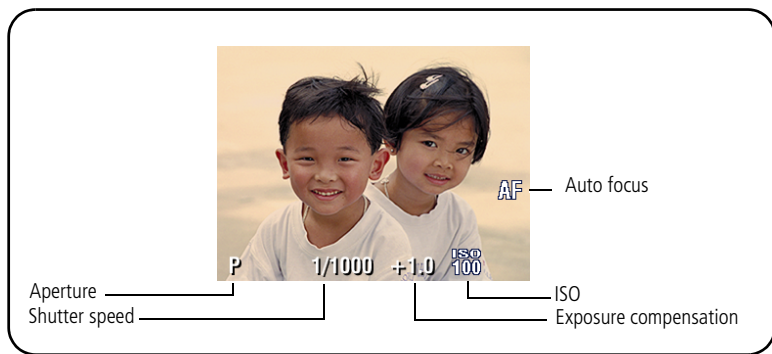

Using the auto-focus framing marks (to take pictures)

Framing marks in the LCD indicate the camera focus area. The camera attempts to focus on foreground subjects, even if the subjects are not centered in the scene.

NOTE: Multiple framing marks appear when Face Detection search (see [Scene modes, page 24](#)) is running.

- 1 Press the Shutter button **halfway**. When the framing marks turn green, focus is accomplished.

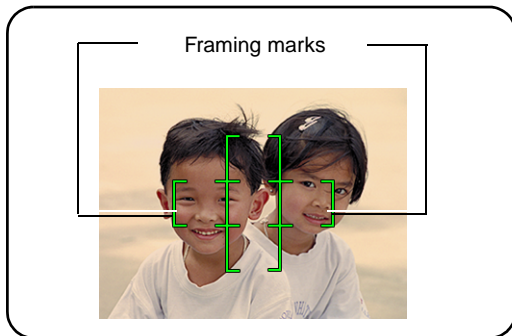

- 2 If the camera is not focusing on the desired subject (or if the framing marks disappear), release the Shutter button and recompose the scene.
- 3 Press the Shutter button **completely down** to take the picture.

NOTE: Framing marks do not appear in Landscape or Video mode. When you use Focus Zone (see [Changing picture-taking settings, page 33](#)) and set Center Zone, the framing marks are fixed at Center Wide.

Reviewing pictures and videos on your camera

View and work with your pictures and videos in Review mode.



Pictures:	Videos:
<p>1 Press Review. (Press again to exit.)</p>	<p>▼ Play/pause.</p>
<p>2 ◀▶ for previous/next.</p>	<p>▲/▼ Adjust the volume.</p>
	<p>▶ Press once to play at 2X speed; press again for 4X (during playback).</p>
	<p>◀ Press once to reverse at 2X speed; press again for 4X (during playback).</p>

To save battery power, use an optional Kodak EasyShare dock or Kodak 3-volt AC adapter. (See www.kodak.com/go/c875accessories.)

NOTE: Pictures taken at the 7.1 MP (3:2) quality setting are displayed at a 3:2 aspect ratio with a black bar at the top and bottom of the screen. A video's duration is displayed at the top of the LCD.

Magnifying a picture during review



T	magnify 2X–8X.
◀▶ ▲/▼	view other parts of the picture.
OK	return to 1X.

NOTE: If you press W while at 1X, the view changes from single picture to multi-up thumbnails. (See [Viewing pictures/videos in different ways, page 43.](#))

Understanding review icons

Pictures

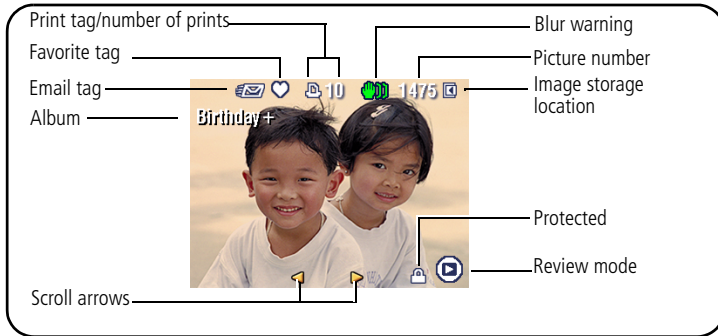

Videos

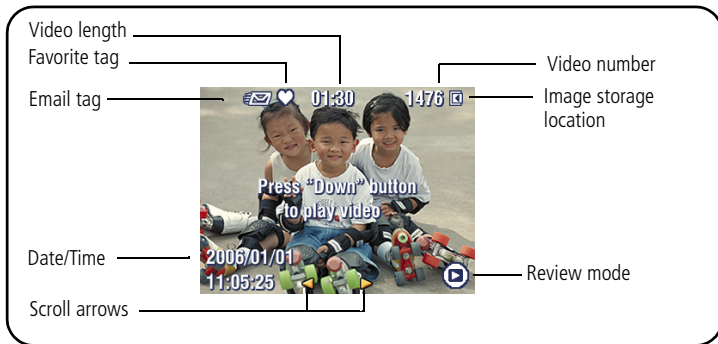

Deleting pictures and videos during review

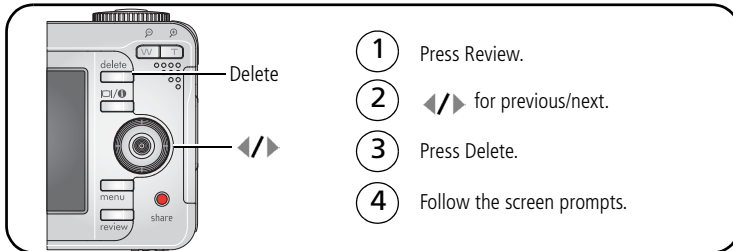

Using the undo delete feature

If you accidentally delete a picture, you can Undo Delete to retrieve it. This feature is only available immediately after you delete a picture. The undo delete feature is not available in video mode.

Protecting pictures and videos from deletion

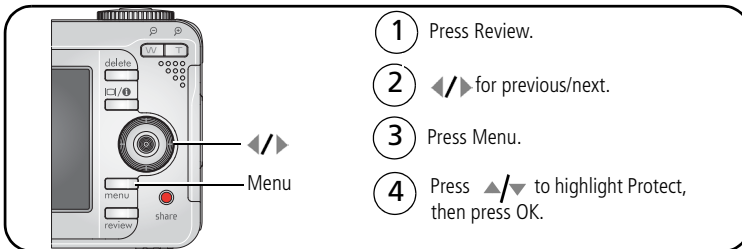

The picture or video is protected and cannot be deleted. The Protect icon  appears with the protected picture or video.

Press the Menu button to exit the menu.

3

Transferring and printing pictures

Installing the software



CAUTION:

Install EasyShare software *before* connecting the camera to the computer. Failure to do so may cause the software to load incorrectly.

- 1 Close all software applications that are open on your computer (including anti-virus software).
- 2 Place the EasyShare software CD into the CD-ROM drive.
- 3 Load the software:
Windows OS—if the install window does not appear, choose Run from the Start menu and type **d:\setup.exe** where **d** is the drive letter that contains the CD.
Mac OS X—double-click the CD icon on the desktop, then click the Install icon.
- 4 Follow the on-screen instructions to install the software.
- 5 If prompted, restart the computer. If you turned off anti-virus software, turn it back on. See the anti-virus software manual for details.

Transferring pictures

If your package includes an EasyShare dock...

Use the camera dock or printer dock to transfer pictures to your computer. (For details, see the dock user's guide. To purchase accessories, see www.kodak.com/go/c875accessories. For dock compatibility, see [page 19](#).)

If your package does not include an EasyShare dock...

Use the USB cable (U-8) included with your camera. (The U-8 cable is **not** included with an EasyShare dock.)

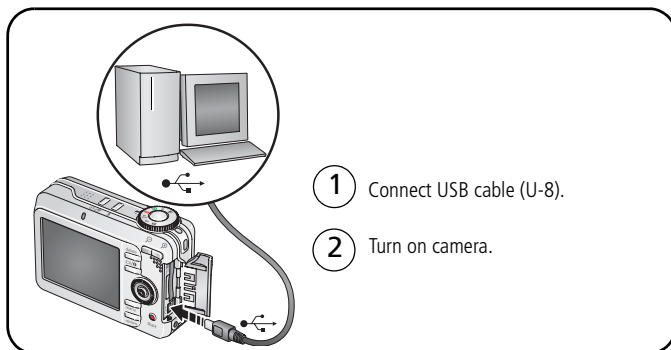

NOTE: Visit www.kodak.com/go/howto for an online tutorial on connecting.

Also available for transferring

You can also use Kodak card readers to transfer your pictures and videos. Purchase these and other accessories at a dealer of Kodak products or www.kodak.com/go/c875accessories.

Printing pictures

Printing with a Kodak EasyShare printer dock

Dock your camera to the Kodak EasyShare printer dock and print directly—with or without a computer. Purchase this and other accessories at a dealer of Kodak products or visit www.kodak.com/go/c875accessories.

Direct printing with a PictBridge enabled printer

Your camera is compatible with PictBridge technology, so you can print directly to PictBridge enabled printers. You need:

- Camera with fully charged batteries
- PictBridge enabled printer
- USB cable (may be sold separately)

Connecting the camera to a PictBridge enabled printer

- 1 Turn off the camera and printer.
- 2 Connect the USB cable from the camera to the printer. (See your printer user guide or visit www.kodak.com/go/c875accessories.)

Printing from a PictBridge enabled printer

- 1 Turn on the printer. Turn on the camera.

The PictBridge logo is displayed, followed by the current picture and menu. (If no pictures are found, a message is displayed.) If the menu interface turns off, press any button to redisplay it.

- 2 Press ▲/▼ to choose a printing option, then press the OK button.

Current Picture	Press ◀/▶ to choose a picture. Choose the number of copies.
Tagged Pictures	If your printer is capable, print pictures that you tagged for printing and choose a print size.
Index Print	Print thumbnails of all pictures. This option requires one or more sheets of paper. If the printer is capable, choose a print size.
All Pictures	Print all pictures in internal memory, on a card, or in Favorites. Choose the number of copies.
Image Storage	Access internal memory, a card, or Favorites.

NOTE: During direct printing, pictures are not permanently transferred or saved to the computer or printer.

Disconnecting the camera from a PictBridge enabled printer

- 1 Turn off the camera and printer.
- 2 Disconnect the USB cable from the camera and the printer.

Using a printer that is not PictBridge enabled

See EasyShare software Help for details.

Ordering prints online

Kodak EasyShare Gallery (www.kodakgallery.com) is one of the many online print services offered in the Kodak EasyShare software. You can easily:

- Upload your pictures.
- Edit, enhance, and add borders to your pictures.
- Store pictures, and share them with family and friends.
- Order high-quality prints, photo greeting cards, frames, and albums—and have them delivered to your door.

Printing from an optional SD/MMC card

- Automatically print tagged pictures when you insert your card into a printer with an SD/MMC card slot. See your printer user's guide for details.
- Make prints at an SD/MMC card-capable Kodak picture maker/picture kiosk. (Contact a location prior to visiting. See www.kodak.com/go/picturemaker.)
- Take the card to your local photo retailer for professional printing.

Dock compatibility for your camera

You can also check dock compatibility for your camera at www.kodak.com/go/dockcompatibility.

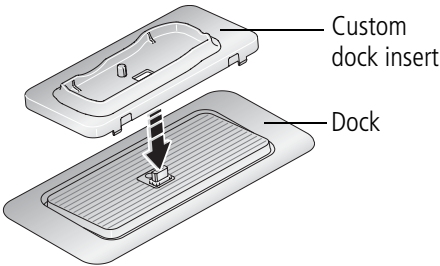
Kodak EasyShare dock	Docking configuration
<ul style="list-style-type: none"> ■ series 3 printer docks and camera docks ■ photo printer 500 	 <p>Custom dock insert</p> <p>Dock</p>

Purchase camera docks, printer docks, and other accessories at a dealer of Kodak products or www.kodak.com/go/c875accessories.

4

Doing more with your camera

Using optical zoom

Use optical zoom to get up to 5X closer to your subject. You can change optical zoom before and during video recording. Optical zoom is effective when the lens is no closer to the subject than:

- 2 ft (60 cm) @ Wide
- 4 in. (10 cm) @ Close-up, Wide
- 3.3 ft (100 cm) @ Telephoto
- 2.3 ft (70 cm) @ Close-up, Telephoto

- 1 Use the LCD to frame your subject.
- 2 Press the Zoom lever T (Telephoto) to zoom in. Press W (Wide Angle) to zoom out.

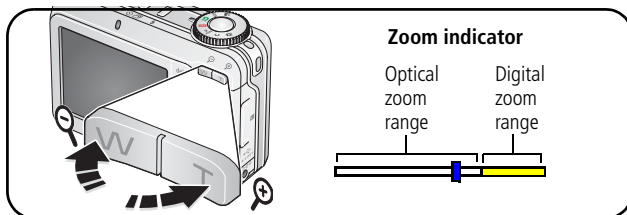

- 3 Take the picture or video.

Using digital zoom

Use digital zoom in any Still mode to get up to 25X magnification.



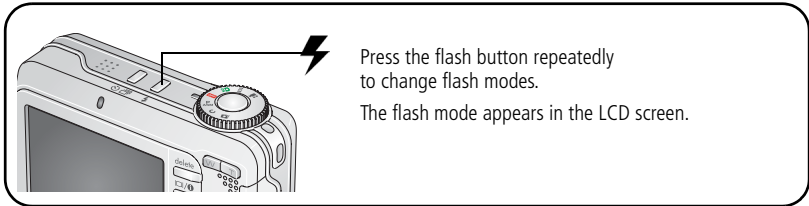

- 1 Press T to the optical zoom limit (5X). Release the lever, then press it again.
- 2 Take the picture.

NOTE: You cannot use digital zoom for video recording. You may notice decreased image quality when using digital zoom. The blue slider on the zoom indicator pauses and turns red when the picture quality reaches the limit for an acceptable 4 x 6-in. (10 x 15 cm) print.

Using the flash





NOTE: Flash settings are preset for each picture-taking mode and are not available in all Capture or SCN modes. When you change to Auto or Red-eye in some of these modes, it becomes the default until you change it.

Flash mode	Description
 Auto Flash	The flash fires when the lighting conditions require it.
 Fill	The flash fires every time you take a picture, regardless of the lighting conditions. Use when the subject is in shadow or is “backlit” (when light is behind the subject). In low light, hold the camera steady or use a tripod.
 Red Eye	The camera automatically detects and removes red eye from the picture. (For Red Eye Preflash, see page 38 .) IMPORTANT: <i>When the flash is set to Red Eye, the camera cannot take more than 2 pictures in quick succession. Take more pictures when the Ready light turns green.</i>
 Off	The flash never fires.
Flash-to-subject distances	
Wide angle	2–13.5 ft (0.6–4.1 m) @ ISO 200
Telephoto	2–8.5 ft (0.6–2.6 m) @ ISO 200

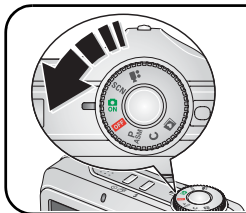
Picture-taking modes



Choose the mode that best suits your subjects and surroundings.

Use this mode	For
 Smart Scene	Camera automatically analyzes and selects the best Scene mode available from Smart Scene. If the camera cannot determine the best Scene mode, it will take the picture in standard Auto.
SCN Scene	Manually selecting a specific Scene mode for picture-taking under special conditions. (See Scene modes, page 24.)
 Video	Capturing video with sound. (See Taking a video, page 6.)
 Favorites	Viewing your favorites. (See Tagging pictures/videos for albums, page 46.)
P ASM P Program	Controlling exposure compensation (how much light enters the camera) and ISO speed. The camera automatically sets the shutter speed and aperture (f-stop) based on the scene lighting. Program mode offers the ease of auto shooting with full access to all menu options. Use the Joystick to select settings. (See Changing PASM/C mode settings, page 29.) Press the Menu button to change other settings.

Use this mode	For
P ASM A Aperture Priority	Controlling the aperture, exposure compensation, and ISO speed. Aperture priority mode is primarily used to control depth of field (the range of sharpness). NOTE: The aperture setting may be affected when using optical zoom. Use the Joystick to select settings. (See Changing PASM/C mode settings, page 29.) Press the Menu button to change other settings.
P ASM S Shutter Priority	Controlling the shutter speed, exposure compensation, and ISO speed. The camera automatically sets the aperture for proper exposure. Shutter priority mode is primarily used to prevent blur when your subject is moving. To prevent camera shake, use a tripod for slow shutter speeds. Use the Joystick to select settings. (See Changing PASM/C mode settings, page 29.) Press the Menu button to change other settings.
P ASM M Manual	Enjoying the highest level of creative control. You set the aperture, shutter speed, and ISO speed. Exposure compensation acts as an exposure meter, recommending the proper combination of aperture and shutter speed to produce an acceptable exposure. Use the Joystick to select settings. (See Changing PASM/C mode settings, page 29.) Press the Menu button to change other settings. To prevent camera shake, use a tripod for slow shutter speeds.
C Custom	The "user-created" mode. For applying P, A, S, M plus any Custom settings (exposure compensation and ISO speed) which are saved independent of other camera settings. Use the Joystick to select settings. (See Changing PASM/C mode settings, page 29.) Press the Menu button to change other settings.

Scene modes

- 1 Turn the Mode dial to Scene **SCN**.
- 2 Press ◀/▶▲/▼ to display Scene mode descriptions.

NOTE: If the mode descriptions turn off, press the OK button.

- 3 Press the OK button to choose a Scene mode.

Use this SCN mode	For
Portrait*	Full-frame portraits of people.
Panorama Left-Right	See Taking panoramic pictures, page 26 .
Panorama Right-Left	See Taking panoramic pictures, page 26 .
Sport	Subjects that are in motion.
Landscape	Far-away scenes. The camera uses infinity auto-focus. Auto-focus framing marks are not available in Landscape.
Close-up	Close range. Use available light instead of flash if possible. The camera automatically sets the focus distance depending on the zoom position.
Night Portrait*	Reduces red eye of people in night scenes or low-light conditions. Place the camera on a flat, steady surface or use a tripod.
Night Landscape	Distant scenery at night. Flash does not fire. Place the camera on a flat, steady surface or use a tripod.
Snow	Bright snow scenes.
Beach	Bright beach scenes.
Text	B & W text documents. (Use Close-up mode for color text.)
Fireworks	Flash does not fire. Place the camera on a flat, steady surface or use a tripod.
Flower	Close-ups of flowers or other small subjects in bright light.

Use this SCN mode	For
Manner/Museum	Quiet occasions, like a wedding or lecture. Flash and sound are disabled.
Self-Portrait	Close-ups at least 2.5 ft (64 cm) away from yourself. Assures proper focus and minimizes red eye.
Party	People indoors. Minimizes red eye.
Children	Action pictures of children in bright light.
Backlight*	Subjects that are in shadow or “backlit” (when light is behind the subject).
Panning Shot	Shooting a fast-moving subject. The background gives the sense of movement, while the subject appears still. Shutter speed > 1/180 sec.
Candle Light	Capturing the ambiance of the candle light.
Sunset	Preserving the deep hues seen in sunsets.

* This camera features Face Detection in Portrait, Night Portrait, and Backlight settings. It automatically selects the proper exposure for the face when taking pictures indoors or outdoors, in bright or low-light conditions, or at night.

Using the framing grid to compose a picture

The framing grid divides the LCD into thirds—vertically and horizontally. This is helpful if, for example, you want to balance a picture between water, earth, and sky.

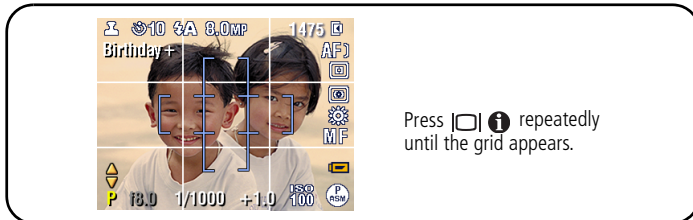

Taking panoramic pictures

Use panorama to “stitch” up to 3 pictures into a panoramic scene.

NOTE: For best results, use a tripod. Only the panoramic picture is saved; individual pictures are not. (Picture size is set to 3.1 MP for each picture. Exposure and white balance are set with the first picture. The flash is set to Off.)

- 1 Turn the Mode dial to **SCN**.
- 2 Press **◀/▶** to highlight Panorama Left-Right or Panorama Right-Left (depending on the direction you want to pan), then press the OK button.
- 3 Take the first picture.
After a quickview, the LCD displays the liveview and an “overlay” from the first picture.
- 4 Compose the second picture. Make the overlay from the first picture cover the same portion in the new picture. (You may press the Delete button to re-take a picture.)
- 5 If you are taking only 2 pictures, press the OK button to stitch them together.
After you take 3 pictures, the pictures are automatically stitched together.

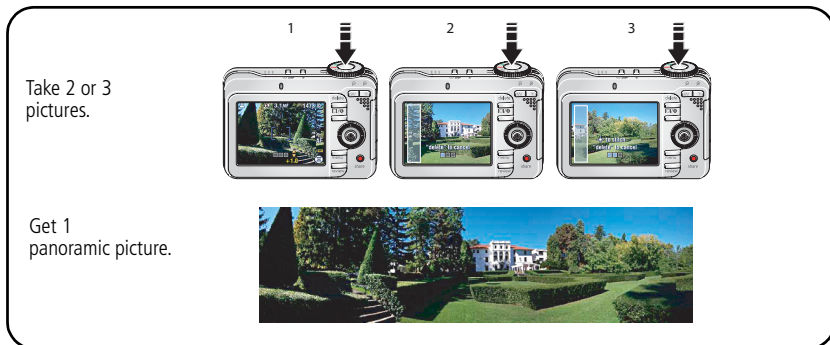

NOTE: For printing options, visit the Kodak EasyShare Gallery at www.kodakgallery.com.

Using exposure compensation to adjust brightness



In PASM/C modes and first picture in Panarama (page 26) mode, you can adjust exposure compensation to make your pictures darker or lighter. Press ▲ to increase exposure compensation, and ▼ to decrease exposure compensation.

The exposure compensation level is shown on the LCD +0.3 and the LCD gets brighter or dimmer.

Using the histogram to view picture brightness

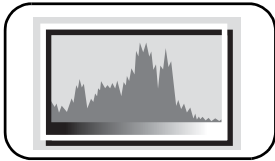
Use the histogram to evaluate the distribution of light before or after you take a picture. If the peak is to the right of the graph, the subject is bright; if the peak is to the left, the subject is dark. Optimal exposure is achieved when the peak is in the middle of the histogram.



To turn on the histogram in PASM/C or Review, press   until the histogram appears.

NOTE: If a scene is dark or light, you can adjust the exposure compensation before taking the picture.

Using PASM/C mode settings

Settings apply only in PASM/C

Settings you change in PASM modes apply only to pictures taken in those modes. Settings you change in C mode apply only to pictures taken in that mode.

For example, if you change the Color Mode to Sepia while in P, A, S, or M mode, then Smart Scene mode and the manually-selected Scene modes retain the default setting of Color.

NOTE: The settings, including Flash, are maintained for PASM/C modes—even when you change modes or turn off the camera.

The PASM/C modes control:

Aperture—also known as f-stop or f-number, controls the size of the lens opening, which determines the depth of field. Smaller f-numbers, for example f/2.8, refer to a bigger lens opening. Larger f-numbers, for example f/8, refer to a smaller lens opening.

Larger f-numbers keep the main subject sharp; good for landscapes and well-lit conditions. Smaller f-numbers are good for portraits and low-light conditions. The highest and lowest aperture numbers may be affected by optical zoom.

Shutter Speed—controls how long the shutter stays open. A shaking hand icon  warns of slow shutter speeds. (Use a tripod for slow shutter speeds.)

Exposure Compensation—lets you manually adjust the exposure (± 2.0 in 1/3 steps); good for controlling backlit or non-standard scenes. If the picture is too light, decrease the setting; if it's too dark, increase the setting.

ISO Speed—controls sensitivity of the camera sensor (64, 100, 200, 400, 800). Higher settings are more sensitive to light, but may produce unwanted "noise" in a picture.

Changing PASM/C mode settings

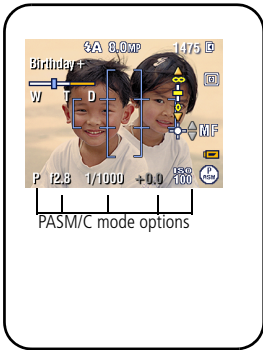

- 1 Turn the Mode dial to PASM or C.
The mode options are displayed.
- 2 Press to:
 - Move between available settings.
 - Open a setting.
 - Change the setting.
- 3 Press the Menu button to change other settings.
- 4 Take a picture.

Using the self-timer

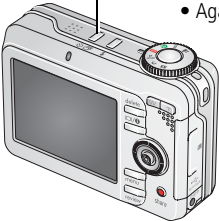

- 1 Place the camera on a tripod or flat surface.
- 2 In any Still mode, except for Panorama, press :
 - Once for a 10-second delay (so you have time to get into the scene)
 - Again for a 2-second delay (for a steady, auto-shutter release on a tripod)
 - Again for 2 pictures (after a 10- and 18-second delay)
- 3 Compose the scene.
- 4 Press the Shutter button halfway, then completely down.



To cancel the Self-timer before the picture is taken, press the Self-timer button. (The Self-timer setting remains active.)

Use the same procedure to take a video, but:

- Turn the Mode dial to Video .
- Press the Shutter button completely down.

NOTE: The video stops when no storage space remains. Only the 2- and 10-second options are available in video mode.

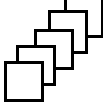
Using burst

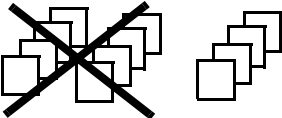
Option	Description	Purpose
 <p>First Burst</p>	<p>Camera takes up to 5 pictures (2 per second) while the Shutter button is pressed.</p>  <p>First 5 pictures are saved.</p>	<p>Capture an expected event.</p> <p>Example: A person swinging a golf club.</p>
 <p>Last Burst</p>	<p>Camera takes up to 30 pictures (2 per second for up to 15 seconds) while the Shutter button is pressed. When the Shutter button is released, only the last 4 pictures are saved.</p>  <p>Last 4 pictures are saved.</p>	<p>Capture an event when the precise timing is uncertain.</p> <p>Example: A child blowing out birthday candles.</p>

- 1 In most Still modes, press the Burst button repeatedly to choose an option.
- 2 Press the Shutter button **halfway** to focus and set exposure.
- 3 Press the Shutter button **completely down and hold it** to take pictures.

The camera stops taking pictures when you release the Shutter button, when the pictures are taken, or when there is no more storage space.

NOTE: During quickview, you can delete all pictures in the burst series. To delete selectively, do so in Review (see [Deleting pictures and videos during review, page 13](#)).

Using camera Help

Use camera Help to familiarize yourself with the camera and to better understand the various camera settings and options. It is also helpful when the User's Guide is not readily available and you need to obtain information quickly. The Help screen operates when you are in the main menu or in most submenu selections.

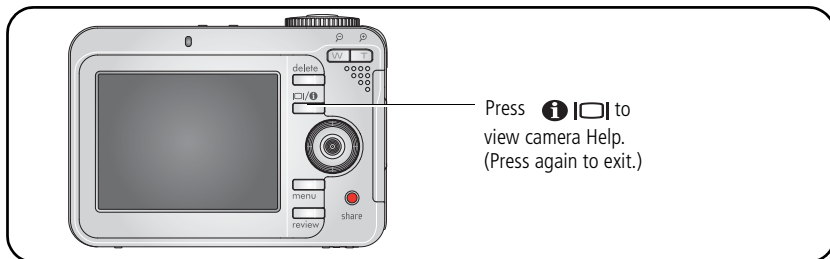

Changing picture-taking settings

You can change settings to get the best results from your camera:

- 1 Press the Menu button.
- 2 Press $\blacktriangle/\blacktriangledown$ to highlight a setting, then press the OK button.
- 3 Choose an option, then press the OK button. (Press the Menu button to exit.)

NOTE: Some settings remain until you change them; others, until you turn the mode dial or turn off the camera.

NOTE: Some modes offer limited settings.

Setting	Options
<p>Exposure Bracketing Determine the best exposure level for your conditions based on your evaluation of 3 pictures.</p>	<p>Off (default) +/- 0.3 +/- 0.7 +/- 1.0 The camera takes 3 pictures—at +, at 0, and at – exposure. Available only in PASM/C mode.</p>
<p>Picture Size Choose a picture resolution.</p>	<p>8.0 MP (default)—for printing up to 20 x 30 in. (51 x 76 cm); pictures are highest resolution and largest file size. 7.1 MP (3:2)—ideal for printing 4 x 6 in. (10 x 15 cm) prints without cropping. Also for printing up to 20 x 30 in. (51 x 76 cm). 5.0 MP— for printing up to 20 x 30 in. (51 x 76 cm); pictures are medium resolution with smaller file size. 3.1 MP—for printing up to 11 x 14 in. (28 x 36 cm); pictures are medium resolution with smaller file size. 1.1 MP—for printing 4 x 6 in. (10 x 15 cm), emailing, Internet, screen display, or for conserving space.</p>

Setting	Options
<p>White Balance Choose your lighting condition.</p>	<p>Auto (default)—automatically corrects white balance. Ideal for general picture taking.</p> <p>Daylight—for pictures in natural lighting.</p> <p>Tungsten—corrects the orange cast of household light bulbs. Ideal for indoor pictures under tungsten or halogen lighting without flash.</p> <p>Fluorescent—corrects the green cast of fluorescent lighting. Ideal for indoor pictures under fluorescent lighting without flash.</p> <p>Open Shade—for pictures in shade in natural lighting. Available only in PASM/C mode.</p>
<p>Exposure Metering Evaluate light levels at specific areas of a scene.</p>	<p>Multi-pattern (default)—evaluates lighting conditions throughout the image to give an optimum picture exposure. Ideal for general picture taking.</p> <p>Center-weight—evaluates the lighting conditions of the subject centered in the LCD screen. Ideal for backlit subjects.</p> <p>Center-spot—similar to Center-weight, except the metering is concentrated on a smaller area of the subject centered in the LCD screen. Ideal when you need an exact exposure of a specific area in the picture. Available only in PASM/C mode.</p>
<p>Focus Zone Select a large or concentrated area of focus.</p>	<p>Multi-zone (default)—evaluates 5 zones to give an even picture focus. Ideal for general picture taking.</p> <p>Center-zone—evaluates the small area centered in the LCD screen. Ideal when precise focus of a specific area in the picture is needed. Available only in PASM/C mode.</p> <p>NOTE: For the best pictures, the camera is set to Multi-zone when in Landscape mode.</p>

Setting	Options
<p>AF Control Choose an auto-focus setting.</p>	<p>Continuous AF—uses TTL (Through The Lens) AF. Because the camera is always focusing, there is no need to press the Shutter button halfway down to focus.</p> <p>Single AF (default)—uses TTL-AF when the Shutter button is pressed halfway down.</p>
<p>Color Mode Choose color tones.</p>	<p>High Color Natural Color (default) Low Color Black & White Sepia—for pictures with a reddish-brown, antique look.</p> <p>NOTE: EasyShare software also lets you change a color picture to black-and-white or sepia.</p> <p>Unavailable in Video mode.</p>
<p>Sharpness Control picture sharpness.</p>	<p>High Normal (default) Low</p> <p>Available only in PASM/C mode.</p>
<p>Reset to Default</p>	<p>All picture-taking settings return to their default. Available only in PASM/C mode.</p>
<p>Set Album Choose Album names. <i>You can apply different Set Album choices to videos and to pictures.</i></p>	<p>On Off (default)</p> <p>Pre-select album names before you take pictures or videos. Then, all the pictures or videos you take are tagged with those album names. See Tagging pictures/videos for albums, page 46.</p> <p>Available only in PASM/C mode.</p>

Setting	Options
Image Storage Choose a storage location for pictures/videos.	Auto (default) —the camera uses the card if one is in the camera. If not, the camera uses internal memory. Internal Memory —the camera always uses internal memory, even if a card is installed. NOTE: If you fill up a storage location while taking pictures, the camera prompts you to switch to the other storage location.
Setup Menu	See Customizing your camera, page 37 .
Video Size	640 x 480 320 x 240 Available only in Video mode.

Customizing your camera

Use Setup to customize your camera settings.

- 1 In any mode, press the Menu button.
- 2 Press $\blacktriangle/\blacktriangledown$ to highlight Setup , then press the OK button.
- 3 Press $\blacktriangle/\blacktriangledown$ to highlight the setting you wish to change, then press the OK button.
- 4 Choose an option, then press the OK button. (Press the Menu button to exit.)

NOTE: These settings remain until you change them.

Setting	Options
Return to previous menu.	
Camera Sounds Choose sound effects.	Theme —applies the same sound effect set to all functions. Individual —choose a sound effect for each function.
Sound Volume	Off Low (default) Medium High
LCD Brightness <i>This setting remains until you turn off the camera.</i>	Power Save (default) High Power
Auto Power Off Choose inactivity time until camera turns off.	10 minutes 5 minutes 3 minutes (default) 1 minute
Date & Time	See Setting the language, date/time first time, page 4.





Setting	Options
<p>Video Out Choose the regional setting that lets you connect the camera to a television or other external device.</p>	<p>NTSC (default)—used in North America and Japan; most common format. PAL—used in Europe and China.</p>
<p>Orientation Sensor Orient pictures so that they are displayed with the correct side up.</p>	<p>On (default) Off</p>
<p>Red Eye Preflash Choose if the Red Eye flash fires automatically before a picture is taken. NOTE: The camera automatically corrects red eye, even if the Red Eye Preflash is set to Off.</p>	<p>On (default) Off</p>
<p>Date Stamp Imprint the date on pictures.</p>	<p>On Off (default)</p>
<p>Video Date Display Display Date/Time at the start of video playback.</p>	<p>On (default)—choose from date formats. Off</p>
<p>Blur Warning</p>	<p>On (default) Off (See Understanding quickview blur warning icons, page 7.)</p>
<p>Language</p>	<p>See Setting the language, date/time first time, page 4.</p>

Setting	Options
<p>Format</p> <p> CAUTION: Formatting deletes all pictures/videos, including those that are protected. Removing a card during formatting may damage the card.</p>	<p>Memory Card—deletes everything on the card; formats the card.</p> <p>Cancel—exits without making a change.</p> <p>Internal Memory—deletes everything in internal memory including email addresses, album names, and favorites; formats the internal memory. Use EasyShare software to restore addresses and albums.</p>
<p>About</p> <p>View camera information.</p>	

Running a slide show

Use the Slide Show to display your pictures/videos on the LCD. To run a slide show on a television or on any external device, see [page 40](#). To save battery power, use an optional Kodak 3-volt AC adapter. (Visit www.kodak.com/go/c875accessories.)

Starting the slide show

- 1 Press the Review button, then press the Menu button.
- 2 Press / to highlight Slide Show , then press the OK button.
- 3 Press / to highlight Begin Show, then press the OK button.

Each picture and video is displayed once.

To interrupt the Slide Show, press the OK button.

Changing the slide show display interval

The default interval setting displays each picture for 5 seconds. You can set the display interval from 3 to 60 seconds.

- 1 On the Slide Show menu, press ▲/▼ to highlight Interval, then press the OK button.
- 2 Select a display interval.
- 3 Press the OK button.

The interval setting remains until you change it.

Running a continuous slide show loop

When you turn on Loop, the slide show is continuously repeated.

- 1 On the Slide Show menu, press ▲/▼ to highlight Loop, then press the OK button.
- 2 Press ▲/▼ to highlight On, then press the OK button.

The slide show repeats until you press the OK button or until battery power is exhausted. The Loop feature remains until you change it.

Displaying pictures and videos on a television

You can display pictures/videos on a television, computer monitor, or any device equipped with a video input. (Image quality on a television screen may not be as good as on a computer monitor or when printed.)

NOTE: Ensure that the Video Out setting (NTSC or PAL) is correct (see [Customizing your camera, page 37](#)).

The slide show stops if you connect a cable while the slide show is running.

- 1 Connect the audio/video cable (included) from the camera USB, A/V Out port to the television video-in port (yellow) and audio-in port (white). See your television user's guide for details.
- 2 Review pictures/videos on the television.

Using Kodak Perfect Touch technology

Kodak Perfect Touch technology helps ensure better, brighter pictures.

- 1 Press the Review button.
- 2 Press ◀/▶ for previous/next picture.
- 3 Press the Menu button, choose Perfect Touch tech. , then press the OK button.

The enhancement is previewed in a split screen. Press ◀/▶ to view other parts of the picture.

- 4 Follow the screen prompts to apply or discard the enhancement, and to save as a new picture or replace the original.

The picture is enhanced. An enhanced picture cannot be enhanced again on the camera. Kodak Perfect Touch technology can only be used with pictures, not video.

Press the Menu button to exit the menu.

Cropping pictures

You can crop a picture so that only the desired portion of the picture remains.

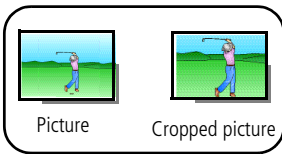

- 1 Press the Review button, then ◀/▶ to find a picture to crop.
- 2 Press the Menu button, choose Crop, then press the OK button.
- 3 Press Telephoto (T) to zoom in, or ◀/▶ ▲/▼ to move the crop box. Press the OK button.
- 4 Follow the screen prompts.

The picture is cropped. (The original is saved.) Cropped pictures cannot be cropped again on the camera.

Press the Menu button to exit the menu.

Editing videos

You can do incredible things with your videos!

Trimming a video

You can delete an unwanted portion from the beginning or end of a video.

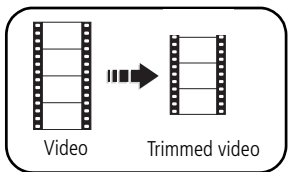

- 1 Press the Review button, then ◀/▶ to find a video.
- 2 Press the Menu button, choose Edit Video, then press the OK button. Choose Trim, then press OK.
- 3 Follow the screen prompts.

The video is trimmed. (You can save it as a new video or replace the original.)

Press the Menu button to exit the menu.

Making a video action print

From a video, you can make a 4-, 9-, or 16-up picture, suitable for a 4 x 6-inch (10 X 15 cm) print.

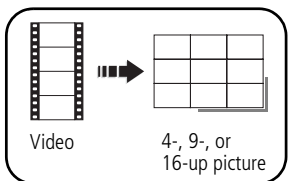

- 1 Press the Review button, then ◀/▶ to find a video.
- 2 Press the Menu button, choose Edit Video, then press the OK button. Choose Action Print, then press the OK button.
- 3 Choose an option, then press the OK button.

Auto options: The camera includes the first and last frames, then 2, 7, or 14 equally spaced frames.

Manual options: You choose the first and last frames; the camera chooses 2, 7, or 14 equally spaced frames.

Press the Menu button to exit the menu.

Viewing pictures/videos in different ways

Viewing by date or by album



- 1 Press the Review button, then the Menu button.
- 2 Press $\blacktriangle/\blacktriangledown$ to highlight View By, then press the OK button.
- 3 Press $\blacktriangle/\blacktriangledown$ to highlight All (default), Date, or Album, then press the OK button. For more about albums, see [Pre-tagging for album names, page 45](#). Press the Review button to exit Review.

Viewing picture/video information



- 1 Press the Review button.
- 2 Repeatedly press $\text{Info} \text{ [icon]}$ to turn on/off status icons and picture/video info. Press the Review button to exit Review.

Viewing as thumbnails (multi-up)

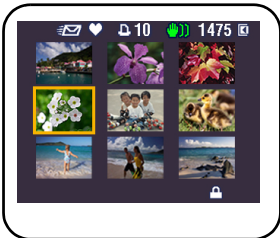

- 1 Press the Review button.
- 2 Press W on the Zoom lever to change from single-picture view to multi-up thumbnails.
- 3 Press T on the Zoom lever to return to single-picture view. See [Selecting multiple pictures/videos, page 44](#). Press the Review button to exit Review.

Selecting multiple pictures/videos

Use the multi-select feature when you have two or more pictures/videos to print, transfer, delete, etc. (Multi-select is used most effectively in [Viewing as thumbnails \(multi-up\)](#), page 43.)

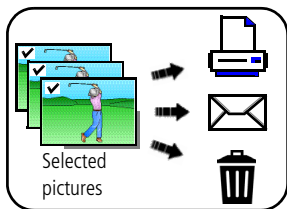

1 Press the Review button, then ◀/▶ to find a picture/video.

2 Press the OK button to select pictures/videos.

A check mark appears on the picture. You can now print, transfer, delete, etc. the selected pictures. You can press OK a second time to remove a check mark.

Copying pictures and videos

You can copy pictures/videos from a card to internal memory or from internal memory to a card.

Before you copy, make sure that:

- A card is inserted in the camera.
- The camera's picture storage location is set to the location **from** which you are copying. (See [Changing picture-taking settings](#), page 33.)

Copy pictures or videos:

- 1 Press the Review button, then press the Menu button.
- 2 Press ▲/▼ to highlight Copy ►►, then press the OK button.
- 3 Press ▲/▼ to highlight an option.
- 4 Press the OK button.

NOTE: Pictures/videos are copied, not moved. To remove pictures/videos from the original location after copying, delete them. See [Deleting pictures and videos during review](#), page 13. Tags that you applied for print, email, and favorites are not copied. Protection settings are not copied. See [Protecting pictures and videos from deletion](#), page 13.

Pre-tagging for album names

Use the Set Album (Still or Video) feature to pre-select album names before you take pictures or videos. Then, all the pictures or videos you take are tagged with those album names.

First—on your computer

Use the EasyShare software that was packaged with your camera to create album names on your computer. The next time you connect the camera to the computer, copy up to 32 albums to the album name list. See EasyShare software Help for details.

Second—on your camera

- 1 In any mode, press the Menu button.
- 2 Press $\blacktriangle/\blacktriangledown$ to highlight Set Album , then press the OK button.
- 3 Press $\blacktriangle/\blacktriangledown$ to highlight an album name, then press the OK button. Repeat to mark pictures or videos for albums.

Selected albums are noted with a check mark.

- 4 To remove a selection, highlight an album name and press the OK button. To remove all album selections, select Clear All.
- 5 Highlight Exit, then press the OK button.

Your selections are saved. If you turn on the LCD, your album selection is displayed on the screen. A plus (+) after the album name means more than one album is selected.

- 6 Press the Menu button to exit the menu.

Third—transfer to your computer

When you transfer the tagged pictures or videos to your computer, EasyShare software opens and categorizes your pictures in the appropriate album. See EasyShare software Help for details.

Tagging pictures/videos for albums

Use the Album feature in Review mode to tag the pictures/videos in your camera with album names.

First—on your computer

Use EasyShare software to create albums on your computer, then copy up to 32 album names to the camera's internal memory. See EasyShare software Help for details.

Second—on your camera

- 1 Press the Review button, then locate the picture or video.
- 2 Press the Menu button.
- 3 Press $\blacktriangle/\blacktriangledown$ to highlight Picture/Video, Selected, or All, then press the OK button.
- 4 Press $\blacktriangle/\blacktriangledown$ to highlight Album , then press the OK button.
- 5 Press $\blacktriangle/\blacktriangledown$ to highlight an album folder, then press the OK button.

To add other pictures to the same album, press $\blacktriangle/\blacktriangleright$ to scroll through the pictures. When the picture you want is displayed, press the OK button.

To add the pictures to more than one album, repeat step 4 for each album.

The album name appears with the picture. A plus (+) after the album name means the picture was added to more than one album.

To remove a selection, highlight an album name and press the OK button. To remove all album selections, select Clear All.

Third—transfer to your computer

When you transfer the tagged pictures/videos to your computer, EasyShare software opens and categorizes your pictures/videos in the appropriate album folder. See EasyShare software Help for details.

Sharing your pictures

Press the Share button to tag your pictures and videos. When they are transferred to your computer, you can share them. Use the Share button:

- Any time. (The most recent picture/video taken is then displayed.)
- Just after you take a picture/video, during quickview.
- After pressing the Review button.

Tagging pictures for printing

- 1 Press the Share button. Press ◀/▶ to locate a picture.
- 2 Press ▲/▼ to highlight Print  or Print Selected, then press the OK button.*
- 3 Press ▲/▼ to select the number of copies (0–99).
Optional: You can apply a print quantity to other pictures. Press ◀/▶ to locate another picture. Press ▲/▼ to change the print quantity.

- 4 Press the OK button.

The Print icon  appears in the status area.

- 5 Press the Share button to exit the menu.

* To tag all pictures in the storage location, highlight Print All, press the OK button, then indicate the number of copies. Print All is not available in quickview. To remove print tagging for all pictures in the storage location, highlight Cancel Prints, then press the OK button. Cancel Prints is not available in quickview.

Printing tagged pictures

When you transfer the tagged pictures to your computer, Kodak EasyShare software print screen opens. See EasyShare software Help for details.

For more information on printing from your computer, printer dock, PictBridge enabled printer, or card, see [Printing pictures, page 16](#).



NOTE: For the best 4 x 6 in. (10 x 15 cm) prints, set the camera to the 7.1 MP (3:2) picture size setting.

Tagging pictures and videos for emailing

First—on your computer

Use EasyShare software to create an email address book on your computer. Then copy up to 32 email addresses to the camera's internal memory. See EasyShare software Help for details.

Second—tag pictures/videos on your camera

- 1 Press the Share button. Press ◀/▶ to locate a picture/video.
- 2 Press ▲/▼ to highlight Email  or Email Selected, then press the OK button.
The Email icon  appears in the status area.
- 3 Press ▲/▼ to highlight an email address, then press the OK button.
To tag other pictures/videos with the same address, press ◀/▶ to scroll through them. When the picture you want is displayed, press OK.
To send the pictures/videos to more than one address, repeat step 3 for each address.
Selected addresses are checked.
- 4 To remove a selection, highlight a checked address and press the OK button. To remove all email selections, highlight Clear All.
- 5 Press ▲/▼ to highlight Exit, then press the OK button.
- 6 Press the Share button to exit the menu.



Third—transfer and email

When you transfer the tagged pictures/videos to your computer, the Email screen opens and lets you send them to the addresses you specified. See EasyShare software Help for details.

Tagging pictures as favorites

You can preserve your favorite pictures in the Favorites section of your camera's internal memory, then share them with friends and family.

NOTE: When you transfer pictures from your camera to your computer, all pictures (including favorites) are stored on your computer at full size. Favorite pictures - smaller copies of your originals - are loaded back to your camera, so you can share and enjoy more.

1. Tag pictures as favorites	<ol style="list-style-type: none"> 1 Press the Share button. Press ◀/▶ to locate a picture. 2 Press ▲/▼ to highlight Favorite  or Favorite Selected, then press the OK button. <i>The Favorite icon  appears in the status area. To remove the tag, press the OK button again. Press the Share button to exit the menu.</i>
2. Transfer pictures to your computer	<ol style="list-style-type: none"> 1 To enjoy full functionality, load and use the EasyShare software that was packaged with this camera. (See Installing the software, page 14.) 2 Connect the camera to the computer using the USB cable (see Transferring pictures, page 15) or an EasyShare dock. <i>The first time you transfer pictures, the software helps you make choices about your favorite pictures. Then, your pictures are transferred to the computer. Favorite pictures (smaller versions of the originals) are loaded to the Favorites section of your camera's internal memory.</i>
3. View favorites on your camera	<ol style="list-style-type: none"> 1 Turn the Mode dial to Favorites . 2 Press ◀/▶ to scroll through favorites.

NOTE: The camera holds a limited number of favorites. Use Camera Favorites in the EasyShare software to customize the size of your camera Favorites section. Videos tagged as favorites remain in the Favorites folder in EasyShare software. See EasyShare software Help for details.



Optional settings

In Favorites mode, press the Menu button to access optional settings.

Slide Show (See Starting the slide show, page 39)	Remove all favorites (See Removing all favorites from your camera, page 50)
Multi-up (See Viewing as thumbnails (multi-up), page 43)	Setup Menu (See Customizing your camera, page 37)

NOTE: Pictures taken at the 7.1 MP (3:2) quality setting are displayed at a 3:2 aspect ratio with a black bar at the top and bottom of the screen.

Removing all favorites from your camera

- 1 Turn the Mode dial to Favorites .
- 2 Press the Menu button.
- 3 Highlight Remove Favorites , then press the OK button.

All pictures stored in the Favorites section of internal memory are removed. Favorites are restored the next time you transfer pictures to the computer.





- 4 Press the Menu button to exit the menu.

Preventing favorites from transferring to the camera

- 1 Open Kodak EasyShare software. Click the My Collection tab.
- 2 Go to the Albums view.
- 3 Click the Camera Favorites Album for your camera.
- 4 Click Remove Album.

The next time you transfer pictures from your camera to the computer, use the Camera Favorites Wizard/Assistant to either recreate your Camera Favorites Album or to turn off the Camera Favorites feature.

Printing and emailing favorites

- 1 Turn the Mode dial to Favorites . Press /  to locate a picture.
- 2 Press the Share button.
- 3 Highlight Print  or Email , then press the OK button.

NOTE: Favorites that were taken on this camera (not imported from another source) are good for prints up to 4 x 6 in. (10 x 15 cm).

5

Troubleshooting

For step-by-step product support, visit www.kodak.com/go/c875support and select Interactive Troubleshooting & Repairs.

Camera problems

Status	Possible solution
Camera does not turn on	<ul style="list-style-type: none"> ■ Remove battery and verify that it's the correct type, then reinsert it. ■ Insert a new or charged battery.
Camera does not turn off and the lens does not retract	<ul style="list-style-type: none"> ■ Connect the camera to a Kodak 3-volt AC adapter (sold separately), then try again. See Battery safety and handling, page 64.
Camera buttons and controls do not function	
Lens does not extend when camera turns on or does not retract	<ul style="list-style-type: none"> ■ Confirm that the battery in camera is charged. ■ Turn camera off, then on again. (Lens does not extend in Favorites mode.) ■ If problem still exists, get help (page 58).
In Review, a blue or black screen is displayed instead of a picture	<ul style="list-style-type: none"> ■ Transfer the picture to the computer. ■ Transfer <i>all</i> pictures to the computer (page 15). ■ Take another picture. If problem continues, try internal memory and/or another memory card.
Picture orientation is not accurate	<ul style="list-style-type: none"> ■ Set the Orientation Sensor to ON (see page 38).

Status	Possible solution
Pictures remaining number does not decrease after taking a picture	<ul style="list-style-type: none"> ■ Continue taking pictures. The camera is operating normally. (The camera estimates the number of pictures remaining after each picture is taken, based on picture size and content.)
Flash does not fire	<ul style="list-style-type: none"> ■ Check the flash setting and change as needed (page 21). <p>NOTE: The flash does not fire in all modes.</p>
Storage location is almost or entirely full	<ul style="list-style-type: none"> ■ Transfer pictures to the computer (page 15). Delete pictures from the card (page 13) or insert a new card. ■ Change image storage location to internal memory (page 36).
Battery life is short	<ul style="list-style-type: none"> ■ Make sure the correct battery type is installed (page 2). ■ Wipe the contacts with a clean, dry cloth before inserting a battery in the camera. ■ Insert a new or charged battery.
You cannot take a picture	<ul style="list-style-type: none"> ■ Turn the camera off, then on again. Make sure the camera is not in Favorites mode. ■ Depress shutter button all the way (page 6). ■ Insert a new or charged battery (page 2). ■ Wait until the Ready light turns green before attempting to take another picture. ■ Memory full. Transfer pictures to the computer (page 15), delete pictures (page 13), change image storage location (page 36), or insert another card.
Error message appears on LCD	<ul style="list-style-type: none"> ■ Turn the camera off, then on again. ■ Remove memory card from the camera. ■ Remove the battery and wipe the contacts with a clean, dry cloth. ■ Insert a new or charged battery (page 2). ■ If problem still exists, get help (page 58).

Status	Possible solution
Memory card not recognized or camera freezes with card.	<ul style="list-style-type: none"> ■ Card may be corrupted. Format card in camera (see page 39). ■ Use another memory card.

Computer/connectivity problems

Status	Possible solution
Computer does not communicate with the camera	<ul style="list-style-type: none"> ■ Insert a charged battery (page 2). ■ Turn on the camera. ■ Make sure the proper USB cable is connected on camera and computer port (page 15). (If using an EasyShare dock, check all cable connections. Make sure the camera is seated on the dock.) ■ Make sure the EasyShare software is installed (page 14).
Pictures do not transfer to computer	<ul style="list-style-type: none"> ■ See EasyShare software Help for details.
Slide Show does not run on an external video device	<ul style="list-style-type: none"> ■ Adjust the camera Video Out setting (see page 38). ■ Make sure the external device settings are correct (see the device's user's guide).

Picture quality problems

Status	Possible solution
Picture is not clear	<ul style="list-style-type: none"> ■ To automatically set exposure and focus, press the Shutter button halfway. When the Ready light turns green, press the Shutter button completely down to take the picture. ■ Clean the lens (page 66). ■ Make sure camera is not in Close-up mode. ■ Place the camera on a flat, steady surface or use a tripod, especially in high-zoom settings or in low light.

Status	Possible solution
Picture is too dark	<ul style="list-style-type: none"> ■ Reposition camera for more available light. ■ Use Fill flash (page 21) or change your position so light is not behind the subject. ■ Move so that the distance between you and the subject is within the effective flash range (page 21). ■ To automatically set exposure and focus, press the Shutter button halfway. When the Ready light turns green, press the Shutter button completely down to take the picture. ■ Adjust exposure compensation (page 27).
Picture is too light	<ul style="list-style-type: none"> ■ Reposition the camera to reduce the amount of available light. ■ Turn off the flash (page 21). ■ Move so that the distance between you and the subject is within the effective flash range (page 21). ■ To automatically set exposure and focus, press the Shutter button halfway. When the Ready light turns green, press the Shutter button completely down to take the picture. ■ Adjust exposure compensation (page 27).

Camera ready-light status

Status	Possible solution
Does not turn on and the camera does not work	<ul style="list-style-type: none"> ■ Turn on the camera. ■ Recharge the battery or install a new one. ■ Mode dial was on when batteries were reloaded. Turn Mode dial off, then back on.
Glows steady green	<ul style="list-style-type: none"> ■ Shutter button is pressed halfway down. Focus and exposure are set. Camera is operating normally.
Blinks green	<ul style="list-style-type: none"> ■ Picture is being processed and saved to the camera. Camera is operating normally. ■ Camera operating normally at power up. Take pictures when the blinking stops. ■ Camera is connected to computer, USB connection is active. ■ Video is recording. ■ Self-timer is counting down. ■ Camera is powering off.
Blinks red and/or camera turns off	<ul style="list-style-type: none"> ■ Turn on the camera. ■ Recharge the battery or install a new one. ■ Auto exposure or auto-focus are not set. Release the Shutter button and recompose the picture.
Blinks amber	<ul style="list-style-type: none"> ■ Flash is not charged. Wait. Resume picture-taking when the light stops blinking and turns off.
Glows steady red	<ul style="list-style-type: none"> ■ Camera's internal memory or card is full. Transfer pictures to the computer, delete pictures from camera, switch image-storage locations, or insert card with available memory. ■ Camera processing memory is full. Wait. Resume picture-taking when the light turns off. ■ Card is read-only. Change image storage location to internal memory, or use a different card. ■ The Mode dial is set to Favorites. Camera is operating normally.

Direct printing (PictBridge enabled printer) problems

Status	Possible solution
Cannot locate desired picture.	<ul style="list-style-type: none"> ■ Turn on the camera. ■ Use the Direct print menu to change the image storage location.
The Direct print menu interface turns off.	<ul style="list-style-type: none"> ■ Press any button to redisplay the menu.
Cannot print pictures.	<ul style="list-style-type: none"> ■ Ensure that there is a connection between the camera and the printer. ■ Ensure the printer and camera have power.
Camera or printer display an error message.	<ul style="list-style-type: none"> ■ Follow the prompts to resolve the issue.

6

Getting help

Helpful links

Camera

Email, write, or phone Kodak	www.kodak.com/go/contact
Get support for your product (FAQs, troubleshooting information, arrange for repairs, etc.)	www.kodak.com/go/c875support
Purchase camera accessories (camera docks, printer docks, lenses, cards, etc.)	www.kodak.com/go/c875accessories
Download the latest camera firmware and software	www.kodak.com/go/c875downloads
See online demonstrations of your camera	www.kodak.com/go/howto

Software

Get information on EasyShare software	www.kodak.com/go/easysw (or click the Help button in EasyShare software)
Get help with the Windows operating system and working with digital pictures	www.kodak.com/go/pcbasics

Other

Get support for other cameras, software, accessories	www.kodak.com/go/support
Get information on Kodak EasyShare printer docks	www.kodak.com/go/printerdocks
Get information on Kodak inkjet products	www.kodak.com/go/inkjet
Optimize your printer for truer, more vibrant colors	www.kodak.com/go/onetouch
Register your camera	www.kodak.com/go/register

Telephone customer support

If you have questions concerning the operation of the software or camera, call a customer support representative. Before you call, have the camera or dock connected to your computer. Be at your computer, and have the following information available:

- Computer model, Operating system
- Processor type and speed (MHz)
- Amount of memory (MB) & free hard disk space
- Camera serial number
- Version of Kodak EasyShare software
- Exact error message you received

Australia	1800 147 701
Austria	0179 567 357
Belgium	02 713 14 45
Brazil	0800 891 4213
Canada	1 800 465 6325
China	800 820 6027
Denmark	3 848 71 30
Ireland	01 407 3054
Finland	0800 1 17056
France	01 55 1740 77
Germany	069 5007 0035
Greece	00800 44140775
Hong Kong	800 901 514
India	91 22 617 5823
Italy	02 696 33452
Japan	03 5540 9002
Korea	080 708 5600
Netherlands	020 346 9372

New Zealand	0800 440 786
Norway	23 16 21 33
Philippines	1 800 1 888 9600
Poland	00800 4411625
Portugal	021 415 4125
Russia	8 495 929 9166
Singapore	800 6363 036
Spain	91 749 76 53
Sweden	08 587 704 21
Switzerland	01 838 53 51
Taiwan	0800 096 868
Thailand	001 800 631 0017
Turkey	00800 448827073
United Kingdom	0870 243 0270
United States	1 800 235 6325 585 781 6231 (toll)
International Toll Line	+44 131 458 6714
International Toll Fax	+44 131 458 6962

www.kodak.com/go/support

Camera specifications

For more specifications, visit www.kodak.com/go/c875support.

Kodak EasyShare C875 zoom digital camera	
CCD (charge-coupled device)	
CCD	1/1.8 in. CCD, 4:3 aspect ratio
Output image size	8.0 MP: 3264 x 2448 pixels 7.1 MP (3:2): 3264 x 2176 pixels 5.0 MP: 2560 x 1920 pixels 3.1 MP: 2048 x 1536 pixels 1.1 MP: 1200 x 900 pixels
Displays	
LCD Color display	2.5 in. (6.35 cm) color hybrid LCD; 115 K pixels
Color viewfinder	No optical/electrical viewfinder
Preview/Review	Frame rate: 30 fps
Lens	
Taking lens (Optical zoom)	5X optical zoom, aspheric all-glass Schneider-Kreuznach Variogon lens, f/2.8–7.1 wide; f/4.4–f/8.0 tele (35 mm equivalent: 37–185 mm)
Digital zoom	Combined zoom settings 5X continuous at 0.2X increments.

Kodak EasyShare C875 zoom digital camera	
Focus system	TTL-AF; multi-zone, center-zone. Working range: 2 ft (60 cm)–infinity @ Wide 3.3 ft (100 cm)–infinity @ Telephoto 4 in. (10 cm)– 2.3 ft (70 cm) @ Macro, Wide 2.3 ft (70 cm)– 3.3 ft (100 cm) @ Macro, Telephoto
Lens protection	Built-in
Exposure	
Exposure metering	TTL-AE; Multi-pattern, Center-weight, Center-spot
Exposure compensation	+/-2.0 EV with 1/3 EV step
Shutter speed	Auto: 1/60–1/1400 sec. Shutter Priority: 8–1/1600 sec. in 1/3-stop increments
ISO speed	Auto: 64–200 Selectable: 64, 100, 200, 400, 800
Flash	
Electronic flash	TTL Auto flash
Flash modes	Auto, Fill, Red Eye, Off
Guide No.	8.3 @ ISO 100
Capture	
Capture modes	Smart Scene, PASM/C modes, Video, Scene modes
Burst mode	Maximum 5 pictures at First Burst and 4 pictures at Last Burst
Video capture	VGA (640 x 480) @ 30 fps; QVGA (320 x 240) @ 30 fps
Image file format	Still: EXIF 2.21 (JPEG compression); file organization DCF Video: QuickTime (CODEC MPEG-4); G.711 (Audio)
Internal storage	Optional MMC or SD Card  (The SD logo is a trademark of the SD Card Association.)

Kodak EasyShare C875 zoom digital camera	
Image capacity	32 MB internal memory (28 MB available for image storage. 1 MB equals one million bytes.)
Review	
Quickview	Yes
Video output	NTSC or PAL
Power	
CRV3; 2-AA lithium; 2-AA Ni-MH; Kodak Ni-MH rechargeable digital camera battery (KAA2HR); 3V AC adapter	
Communication with computer/TV	
High-speed: USB 2.0 via cable (U-8), for camera to PC connection Full-speed: USB 2.0 via EasyShare camera dock or printer dock connection	
Other features	
PictBridge support	Yes
Self-timer	2-second, 10-second, or 2-shot
White balance	Auto, Daylight, Open Shade, Tungsten, Fluorescent
Auto power off	Selectable: 1, 3 (default), 5, or 10 minutes
Color modes	High, Natural, Low, Black & White, Sepia
Date stamp	None, YYYY/MM/DD, MM/DD/YYYY, DD/MM/YYYY
Tripod mount	1/4 inch
Operating temperature	32–104° F (0–40° C)
Size	1.4 in. (36.6 mm) x 2.5 in. (63 mm) x 3.6 in. (90.5 mm) @ power off
Weight	6.2 oz (177 g) without card or battery

Storage capacities

Actual storage capacity varies depending on subject composition, card brand, and other factors. You may be able to store more or fewer pictures and videos. Favorites take up additional space in internal memory.

Picture storage capacity—standard compression

	Number of pictures				
	8.0 MP	7.1 MP (3:2)	5.0	3.1 MP	1.1 MP
Internal memory	11	12	17	26	64
32 MB SD/MMC	12	14	20	30	73
64 MB SD/MMC	25	28	40	60	146
128 MB SD/MMC	50	57	80	121	293
256 MB SD/MMC	102	114	161	242	588
512 MB SD/MMC	204	228	322	485	1176
1 GB SD/MMC	408	456	645	970	2352

Video storage capacity

	Minutes/seconds of video	
	VGA (640 x 480)	QVGA (320 x 240)
Internal memory	54 sec.	2 min. 18 sec.
32 MB SD/MMC	1 min. 1 sec.	2 min. 36 sec.
64 MB SD/MMC	2 min. 3 sec.	5 min. 13 sec.
128 MB SD/MMC	4 min. 7 sec.	10 min. 26 sec.
256 MB SD/MMC	8 min. 14 sec.	20 min. 53 sec.
512 MB SD/MMC	16 min. 28 sec.	41 min. 46 sec.
1 GB SD/MMC	32 min. 56 sec.	83 min. 32 sec.

Important safety instructions



CAUTION:

Do not disassemble this product; there are no user-serviceable parts inside. Refer servicing to qualified service personnel. Do not expose this product to liquid, moisture, or extreme temperatures. Kodak AC adapters and battery chargers are intended for indoor use only. The use of controls, adjustments, or procedures other than those specified herein may result in exposure to shock and/or electrical or mechanical hazards. If the LCD breaks, do not touch the glass or liquid. Contact Kodak customer support.

Using this product

- The use of an accessory attachment that is not recommended by Kodak, such as an AC adapter, may cause fire, electric shock, or injury.
- Use only a USB-certified computer. Contact your computer manufacturer if you have questions.
- If using this product in an airplane, observe all instructions of the airline.

Battery safety and handling



CAUTION:

When removing the battery, allow it to cool; it may be hot.

- Use only batteries approved for this product to avoid risk of explosion.
- Keep batteries out of the reach of children.
- Do not allow batteries to touch metal objects, including coins. Otherwise, a battery may short circuit, discharge energy, become hot, or leak.
- Do not disassemble, install backward, or expose batteries to liquid, moisture, fire, or extreme temperature.

- Remove the battery when the product is stored for an extended period of time. In the unlikely event that battery fluid leaks inside the product, contact Kodak customer support.
- In the unlikely event that battery fluid leaks onto your skin, wash immediately with water and contact your local health provider. For additional health-related information, contact your local Kodak customer support.
- Dispose of batteries according to local and national regulations.
- Do not charge non-rechargeable batteries.

For more information on batteries, see www.kodak.com/go/batterytupes

Battery life

Use these Kodak batteries. (Battery types are also molded into the battery door.)

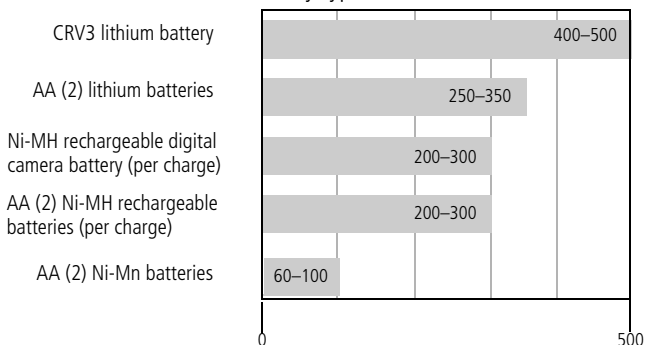

Battery life per CIPA testing method (Approx. number of pictures in Auto mode, using 128 MB SD card.). Actual life may vary based on usage.

We do not recommend or support alkaline batteries. For acceptable battery life, and to make sure your camera operates dependably, use the batteries listed.

Extending battery life

- See LCD Brightness (page 37) and Auto Power Off (page 37).
- Limit the following activities that quickly deplete battery power:
 - Reviewing your pictures on the LCD (see page 11)
 - Excessive use of the flash
- Dirt on the battery contacts can affect battery life. Wipe the contacts with a clean, dry cloth before loading batteries in the camera.
- Battery performance is reduced at temperatures below 41° F (5° C). When using your camera in cold weather, carry spare batteries and keep them warm. Do not discard cold batteries that do not work; when they return to room temperature, they may be usable.

Upgrading your software and firmware

Download the latest versions of the software included on the Kodak EasyShare software CD and the camera firmware (the software that runs on the camera). See www.kodak.com/go/c875downloads.

Additional care and maintenance

- If the camera has been subjected to inclement weather or you suspect water has gotten inside the camera, turn off the camera and remove the battery and card. Allow all components to air-dry for at least 24 hours before using the camera again.
- Blow gently on the lens or LCD to remove dust and dirt. Wipe gently with a soft, lint-free cloth or an untreated lens-cleaning tissue. Do not use cleaning solutions unless designed specifically for camera lenses. Do not allow chemicals, such as suntan lotion, to contact painted surfaces.

- Service agreements may be available in your country. Contact a dealer of Kodak products for more information.
- For digital camera disposal or recycling information, contact your local authorities. In the US, visit the Electronics Industry Alliance Web site at www.eiae.org or the Kodak Web site at www.kodak.com/go/kes.

Warranty

Limited warranty

Kodak warrants Kodak EasyShare digital cameras and accessories (excluding batteries) to be free from malfunctions and defects in both materials and workmanship for one year from the date of purchase.

Retain the original dated sales receipt. Proof of the date of purchase will be required with any request for warranty repair.

Limited warranty coverage

This limited warranty will be honored only within the geographical location that Kodak digital cameras and accessories were purchased.

Kodak will REPAIR or REPLACE Kodak EasyShare digital cameras and accessories if they fail to function properly during the warranty period, subject to any conditions and/or limitations stated herein. Such repair service will include all labor as well as any necessary adjustments and/or replacement parts. Such repair or replacement is the sole remedy under this warranty.

If replacement parts are used in making repairs, these parts may be remanufactured, or may contain remanufactured materials. If it is necessary to replace the entire product, it may be replaced with a remanufactured product.

Limitations

Request for Warranty service will not be accepted without proof of date of purchase, such as a copy of the original dated Kodak EasyShare digital camera or accessory sales receipt. (Always keep the original for your records.)

www.kodak.com/go/support

This warranty does not apply to the battery(s) used in digital cameras or accessories. This warranty does not cover circumstances beyond Kodak's control, nor problems caused by failure to follow the operating instructions in the Kodak EasyShare digital cameras and accessories User's Guides.

This warranty does not apply when failure is due to shipping damage, accident, alteration, modification, unauthorized service, misuse, abuse, use with incompatible accessories or attachments, failure to follow Kodak's operation, maintenance or repacking instructions, failure to use items supplied by Kodak (such as adapters and cables), or claims made after the duration of this warranty.

Kodak makes no other express or implied warranty for this product. In the event that the exclusion of any implied warranty is ineffective under the law, the duration of the implied warranty will be one year from the purchase date.

The option of replacement is Kodak's only obligation. Kodak will not be responsible for any special, consequential or incidental damages resulting from the sale, purchase, or use of this product, regardless of the cause. Liability for any special, consequential or incidental damages (including but not limited to loss of revenue or profit, downtime costs, loss of the use of the equipment, cost of substitute equipment, facilities or services, or claims of your customers for such damages resulting from the purchase, use or failure of the product), regardless of cause or for breach of any written or implied warranty is expressly disclaimed and excluded herefrom.

Your rights

Some states or jurisdictions do not allow exclusion or limitation of incidental or consequential damages, so the above limitation or exclusion may not apply to you. Some states or jurisdictions do not allow limitations on how long an implied warranty lasts, so the above limitation may not apply to you.

This warranty gives you specific rights, and you may have other rights which vary from state to state or by jurisdiction.

Outside the United States and Canada

In countries other than the United States and Canada, the terms and conditions of this warranty may be different. Unless specific Kodak warranty is communicated to the purchaser in writing by a Kodak company, no warranty or liability exists beyond any minimum requirements imposed by law, even though defect, damage, or loss may be by negligence or other act.

Regulatory compliance

FCC compliance and advisory

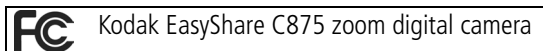

This equipment has been tested and found to comply with the limits for a Class B digital device, pursuant to Part 15 of the FCC Rules. These limits are designed to provide reasonable protection against harmful interference in a residential installation.

This equipment generates, uses, and can radiate radio frequency energy and, if not installed or used in accordance with the instructions, may cause harmful interference to radio communications. However, there is no guarantee that interference will not occur in a particular installation.

If this equipment does cause harmful interference to radio or television reception, which can be determined by turning the equipment off and on, the user is encouraged to try to correct the interference by one or more of the following measures: 1) reorient or relocate the receiving antenna; 2) increase the separation between the equipment and the receiver; 3) connect the equipment to an outlet on a circuit different from that to which the receiver is connected; 4) consult the dealer or an experienced radio/TV technician for additional suggestions.

Any changes or modifications not expressly approved by the party responsible for compliance could void the user's authority to operate the equipment. Where shielded interface cables have been provided with the product or specified additional components or accessories elsewhere defined to be used with the installation of the product, they must be used in order to ensure compliance with FCC regulation.

Australian C-Tick



Canadian DOC statement

DOC Class B Compliance—This Class B digital apparatus complies with Canadian ICES-003.

Observation des normes-Class B—Cet appareil numérique de la classe B est conforme à la norme NMB-003 du Canada.

Waste Electrical and Electronic Equipment labeling



In the European Union, do not discard this product as unsorted municipal waste. Contact your local authorities or go to www.kodak.com/go/recycle for recycling program information.

Korea Class B ITE

이 기기는 가정용으로 전자파적합등록을 한 기기로서 주거지역에서는 물론 모든 지역에서 사용할 수 있습니다.

English translation: As this equipment has obtained EMC registration for household use, it can be used in any area including residential areas.

VCCI Class B ITE

この装置は、情報処理装置等電波障害自主規制協議会（VCCI）の基準に基づいたクラスB情報技術装置です。この装置は、家庭環境で使用することを目的としていますが、この装置がラジオやテレビジョン受信機に近接して使用されると、受信障害を引き起こすことがあります。
取扱説明書に従って正しい取り扱いをして下さい。

English translation: This is a Class B product based on the standard of the Voluntary Control Council for Interference from Information Technology Equipment (VCCI). If this is used near a radio or television receiver in a domestic environment, it may cause radio interference. Install and use the equipment according to the instruction manual.

MPEG-4

Use of this product in any manner that complies with the MPEG-4 visual standard is prohibited, except for use by a consumer engaging in personal and non-commercial activities.

Index

A

- A/V out, ii, 40
- about picture, video, 43
- about this camera, 39
- accessories, 15
 - battery, 66
 - buying, 58
 - printer dock, 16
 - SD/MMC card, 5
- AF assist light, i
- album
 - set, 35
 - tagging pictures, 45
- aperture priority mode, 23
- appendix, 60
- auto
 - enhancement, 41
 - flash, 21
 - focus control, 35
 - focus framing marks, 10
 - mode, 22

B

- backlight, 25
- battery
 - compartment, ii
 - expected life, 65
 - extending life, 66
 - life, 65
 - loading, 2
 - safety, 64
 - types, 65

- beach, 24
- blur, 7
- blur warning, 38
- burst, using, 31
- burst/self-timer button, i
- button
 - burst, i, 31
 - delete, ii, 7
 - flash, i, 21
 - LCD/info/help, ii
 - menu, ii
 - OK, ii
 - review, ii
 - self-timer, i
 - share, ii
 - shutter, i
 - telephoto, ii
 - zoom, 20

C

- cable
 - audio/video, 40
 - USB, 15
- camera screen
 - getting help, 32
 - reviewing videos, 11
- camera sounds, 37
- candle light mode, 25
- caring for your camera, 66
- caution
 - formatting, 13
- children, 25

Class B ITE, 70
clock, setting, 4
color mode, 35
compatibility, dock, 19
copy pictures
 card to memory, 44
 memory to card, 44
 to computer, 14
custom mode, 23
customer support, 59
customizing camera, 36

D

date setting, 4
date stamp, 38
DC-in, ii
delete button, ii
deleting
 during quickview, 7
 pictures, videos, 13
 protecting pictures, videos, 13
displaying slide show, 39
disposal, recycling, 67, 70
dock
 compatibility, 19
 connector, ii
 printer, 16
download pictures, 14

E

EasyShare software
 installing, 14
emailing pictures, videos, 48
expected battery life, 65

exposure
 compensation, 27
 metering, 34
exposure bracketing, 33
exposure compensation, 28
external video device
 viewing pictures, videos, 40

F

face detection, 25
favorites
 removing, 50
 settings, 50
 tagging, 49
fill flash, 21
fireworks, 24
firmware, upgrading, 66
flash button, i
flash off, 21
flash settings, 21
flash-to-subject distances, 21
flower, 24
focus
 framing marks, 10
 zone, 34
format, 39
formatting
 caution, 13
framing grid, 25

G

guidelines, battery, 66

H

help, 52

camera help, 32
web links, 58
histogram, 27

I

icon
blur, 7
icons
picture-taking, 8
reviewing pictures, 12
icons, mode dial, 22
image storage, 36
information
about pictures, videos, 43
installing
battery, 2
SD/MMC card, 5
software, 14
internal memory
storage capacity, 63
interval, slide show, 40

J

joystick, ii

K

Kodak EasyShare software
upgrading, 66
Kodak Perfect Touch technology, 41
Kodak web sites, 58

L

LCD, ii
LCD/info/help button, ii, 6
lens, i

cleaning lens, 66
light
AF assist, i
ready, ii
self-timer, i
loading
batteries, 2
SD/MMC card, 5
software, 14
loop, slide show, 40

M

Macintosh OS, installing software on, 14
magnify picture, 11
maintenance, camera, 66
manner, 25
manual mode, 23
memory
inserting card, 5
storage capacities, 63
menu button, ii
microphone, i
mode dial, i, 22
modes
aperture priority, 23
auto, 22
backlight, 25
beach, 24
candle light, 25
children, 25
custom, 23
fireworks, 24
flower, 24
manner, 25

manual, 23
 night landscape, 24
 night portrait, 24
 panning shot, 25
 panorama, 24
 party, 25
 program, 22
 SCN, 22
 self-portrait, 25
 shutter priority, 23
 snow, 24
 text, 24

N

night landscape, 24
 night portrait, 24

O

OK button, ii
 online prints, ordering, 18
 optical zoom, 20
 orientation sensor, 38

P

panning-shot mode, 25
 panorama mode, 24
 panoramic pictures, 26
 party, 25
 PASM, 22, 23
 Perfect Touch technology, 41
 PictBridge enabled printer, 16
 picture
 magnify, 11
 picture size, 33
 pictures

copying, 44
 deleting, 13
 emailing tagged, 48
 Kodak Perfect Touch technology, 41
 printing, 17
 protecting, 13
 reviewing, 11
 storage capacity, 63
 tagging, 45
 taking, modes, 22
 transfer, 14

picture-taking settings, 33
 power

camera, 3
 power light, i
 printer dock, 16
 printing
 from a card, 18
 from computer, 17
 optimizing printer, 58
 order online, 18
 PictBridge technology, 16
 tagged pictures, 18
 with EasyShare printer dock, 16
 problem-solving, 52
 Program mode, 22
 protecting pictures, videos, 13

Q

quickview
 using, 7

R

ready light, ii

recycling, disposal, 67, 70
red eye flash, 21
regulatory information, 69
 Class B ITE, 70
removing favorites, 50
repair, 58
return, 37
review button, ii
reviewing pictures
 as you take them, 7
 camera screen, 11
reviewing pictures, videos
 slide show, 39
reviewing videos
 camera screen, 11
running slide show, 39

S

safety, battery, 64
scene modes, 24
 panorama, 26
SCN, 22
SD/MMC card
 inserting, 5
 printing from, 18
 slot, ii
 storage capacities, 63
self-portrait, 25
self-timer
 with pictures, 30
self-timer/burst button, i
service and support
 telephone numbers, 59
setting

 about, 39
 album, 35
 auto focus, 35
 blur warning, 38
 camera sounds, 37
 color mode, 35
 date and time, 4
 date stamp, 38
 exposure bracketing, 33
 exposure metering, 34
 focus zone, 34
 image storage, 36
 orientation sensor, 38
 picture size, 33
 picture taking mode, 22
 return, 37
 self-timer, 30
 setup menu, 36
 sharpness, 35
 sound volume, 37
 video date display, 38
 video out, 38
 video size, 36
 white balance, 34
settings
 picture taking, 33
setup menu, 36
shaking hand, 7
share button, ii
sharing pictures, videos, 47
sharpness, 35
shutter
 problems, 53
 self-timer delay, 30

shutter button, i
shutter priority mode, 23
shutter speed, 28
slide show
 continuous loop, 40
 interval, 40
 problems, 54
 running, 39
slot for optional SD or MMC card, ii
smart scene, 8, 22
snow, 24
software
 installing, 14
 upgrading, 66
sound volume, 37
sounds, 37
speaker, i
specifications, camera, 60
status
 blur, 7
storage capacity, 63
strap post, ii
support, technical, 59

T

tagging
 favorites, 49
 for albums, 45
 for email, 48
 for print, 47
taking a picture, 6
taking a video, 6
telephone support, 59
telephoto button, ii

television, slide show, 40
text, 24
time, setting, 4
timer, shutter delay, 30
transferring pictures, videos, 14
trash can, deleting, 7
tripod socket, ii
troubleshooting, 52
turning camera on and off, 3

U

undelete, 13
undo, 13
upgrading software, firmware, 66
URLs, Kodak web sites, 58
USB, ii
USB cable, 15
using, 20

V

VCCI compliance, 71
video
 action print, 42
 copying, 44
 date display, 38
 out, 38
 protecting, 13
 storage capacities, 63
 viewing, 11
video size, 36
videos
 deleting, 13
 emailing tagged, 48
 transfer, 14

viewing

by date, album, 43

viewing picture

after taking, 7, 11

viewing picture, video information, 43

volume, 37

W

warranty, 67

WEEE, 70

white balance, 34

Windows OS-based computers

installing software, 14

wrist strap, 1

Z

zoom lever, wide angle & telephoto, ii

zoom, using, 20

Free Manuals Download Website

<http://myh66.com>

<http://usermanuals.us>

<http://www.somanuals.com>

<http://www.4manuals.cc>

<http://www.manual-lib.com>

<http://www.404manual.com>

<http://www.luxmanual.com>

<http://aubethermostatmanual.com>

Golf course search by state

<http://golfingnear.com>

Email search by domain

<http://emailbydomain.com>

Auto manuals search

<http://auto.somanuals.com>

TV manuals search

<http://tv.somanuals.com>