

Dell Storage Center

SCv2000 and SCv2020 Storage System

Deployment Guide



Notes, Cautions, and Warnings

 **NOTE:** A NOTE indicates important information that helps you make better use of your computer.

 **CAUTION:** A CAUTION indicates either potential damage to hardware or loss of data and tells you how to avoid the problem.

 **WARNING:** A WARNING indicates a potential for property damage, personal injury, or death.

Copyright © 2015 Dell Inc. All rights reserved. This product is protected by U.S. and international copyright and intellectual property laws. Dell™ and the Dell logo are trademarks of Dell Inc. in the United States and/or other jurisdictions. All other marks and names mentioned herein may be trademarks of their respective companies.

2015 - 04

Rev. A00

Contents

About this Guide.....	7
Revision History.....	7
Audience.....	7
Contacting Dell.....	7
Related Publications.....	7
1 About the SCv2000/SCv2020 Storage System.....	9
Storage Center Hardware Components.....	9
SCv2000/SCv2020 Storage System.....	9
Switches.....	9
Expansion Enclosures.....	10
Storage Center Architecture Options.....	10
Storage Center Replication.....	11
Storage Center Communication.....	11
Front-End Connectivity.....	11
Back-End Connectivity.....	14
System Administration.....	15
SCv2000/SCv2020 Storage System Hardware.....	15
SCv2000/SCv2020 Storage System Front Panel Features and Indicators.....	15
SCv2000/SCv2020 Back-Panel Features and Indicators.....	16
SCv2000/SCv2020 Storage Controller Features and Indicators	17
SCv2000/SCv2020 Drives.....	23
SCv2000/SCv2020 Storage System Drive Numbering.....	23
SC100/SC120 Expansion Enclosure Overview.....	24
SC100/SC120 Expansion Enclosure Front Panel Features and Indicators.....	24
SC100/SC120 Expansion Enclosure Back Panel Features and Indicators.....	25
SC100/SC120 Expansion Enclosure EMM Features and Indicators.....	26
SC100/SC120 Expansion Enclosure Drives.....	27
SC100/SC120 Expansion Enclosure Drive Numbering.....	27
2 Install the Storage Center Hardware.....	28
Unpack and Inventory the Storage Center Equipment.....	28
Prepare the Installation Environment.....	28
Safety Precautions.....	28
Installation Safety Precautions.....	29
Electrical Safety Precautions.....	29
Electrostatic Discharge Precautions.....	30

General Safety Precautions.....	30
Install the Storage System in a Rack.....	30
3 Front-End Cabling.....	32
Types of Redundancy for Front-End Connections.....	32
Port Redundancy.....	32
Storage Controller Redundancy.....	33
Multipath IO.....	33
Cabling SAN-Attached Host Servers.....	34
Connecting to Fibre Channel Host Servers.....	34
Connecting to iSCSI Host Servers.....	46
Cabling Direct-Attached Host Servers.....	55
Preparing Host Servers.....	55
SAS Virtual Port Mode.....	56
Two Servers Connected to Dual 12 Gb 4–Port SAS Storage Controllers.....	56
Four Servers Connected to Dual 12 Gb 4–Port SAS Storage Controllers.....	57
Two Servers Connected to a Single 12 Gb 4–Port SAS Storage Controller.....	59
Labeling the Front-End Cables.....	60
Cabling the Ethernet Management Port.....	61
Labeling the Ethernet Management Cables.....	61
Cabling the Embedded Ports for iSCSI Replication.....	62
Cabling the Replication Port for iSCSI Replication.....	62
Cabling the Management Port and Replication Port for iSCSI Replication.....	63
Cabling the Embedded Ports for iSCSI Host Connectivity.....	64
Two iSCSI Networks with Dual Storage Controllers and Embedded Ethernet Ports.....	64
One iSCSI Network with Dual Storage Controllers and Embedded Ethernet Ports.....	65
4 Back-End Cabling and Connecting Power.....	67
SC100/SC120 Expansion Enclosure Cabling Guidelines.....	67
SAS Redundancy.....	67
SAS Port Types.....	67
Back-End Connections for an SCv2000/SCv2020 without Expansion Enclosures.....	68
Back-End Connections for an SCv2000/SCv2020 with Expansion Enclosures.....	68
SCv2000/SCv2020 and One SC100/SC120 Expansion Enclosure.....	69
SCv2000/SCv2020 and Two or More SC100/SC120 Expansion Enclosures.....	70
Label the Back-End Cables.....	71
Connect Power Cables and Turn on the Storage System.....	72
5 Discover and Configure the Storage Center.....	74
Worksheet to Record System Information.....	74
Storage Center Information.....	74
iSCSI Fault Domain Information.....	75

Additional Storage Center Information.....	75
Fibre Channel Zoning Information.....	76
Locating Your Service Tag.....	77
Supported Operating Systems for Storage Center Automated Setup	77
Install and Use the Dell Storage Client.....	77
Discover and Select an Uninitialized Storage Center.....	77
Set System Information.....	78
Set Administrator Information.....	78
Configure iSCSI Fault Domains.....	79
Confirm the Storage Center Configuration.....	79
Initialize the Storage Center.....	79
Review Fibre Channel Front-End Configuration.....	80
Review SAS Front-End Configuration.....	80
Configure Time Settings.....	80
Configure SMTP Server Settings.....	80
Configure Key Management Server Settings.....	81
Review the SupportAssist Data Collection and Storage Agreement.....	81
Advantages and Benefits of Dell SupportAssist.....	81
Provide Contact Information.....	82
Update Storage Center.....	82
Complete Configuration and Perform Next Steps.....	82
Set Up a localhost or VMware Host.....	83
Set Up a localhost from Initial Setup.....	83
Set Up a VMware vSphere Host from Initial Setup.....	83
Set Up a VMware vCenter Host from Initial Setup.....	84
Configure Embedded iSCSI Ports.....	85
6 Perform Post-Setup Tasks.....	86
Verify Connectivity and Failover.....	86
Create Test Volumes.....	86
Test Basic Connectivity.....	87
Test Storage Controller Failover.....	87
Test MPIO.....	87
Clean up Test Volumes.....	88
Sending Diagnostic Data Using Dell SupportAssist.....	88
Label SC100/SC120 Expansion Enclosures.....	88
A Adding or Removing an Expansion Enclosure.....	89
Adding Multiple Expansion Enclosures to a Storage System Deployed without Expansion Enclosures.....	89
Cable the Expansion Enclosures Together.....	90

Check the Current Disk Count before Adding Expansion Enclosures.....	90
Add the Expansion Enclosures to the A-Side Chain.....	90
Add the Expansion Enclosures to the B-Side Chain.....	91
Label the Back-End Cables.....	93
Adding a Single Expansion Enclosure to a Chain Currently in Service.....	94
Check the Disk Count before Adding an Expansion Enclosure.....	95
Add an Expansion Enclosure to the A-side Chain.....	95
Add an Expansion Enclosure to the B-side Chain.....	97
Label the Back-End Cables.....	99
Removing an Expansion Enclosure from a Chain Currently in Service.....	100
Release the Disks in the Expansion Enclosure.....	101
Disconnect the A-Side Chain from the SC100/SC120 Expansion Enclosure.....	102
Disconnect the B-Side Chain from the SC100/SC120 Expansion Enclosure.....	103
B Troubleshooting Storage Center.....	107
Troubleshooting Storage Controllers.....	107
Troubleshooting Hard Drives.....	107
Troubleshooting Expansion Enclosures.....	107

About this Guide

This guide describes the features and technical specifications of an SCv2000/SCv2020 storage system.

Revision History

Document Number: 8X7FK

Revision	Date	Description
A00	April 2015	Initial release

Audience

The information provided in this Deployment Guide is intended for storage or network administrators and deployment personnel.

Contacting Dell

Dell provides several online and telephone-based support and service options. Availability varies by country and product, and some services may not be available in your area.

To contact Dell for sales, technical support, or customer service issues go to www.dell.com/support.

- For customized support, enter your system Service Tag on the support page and click **Submit**.
- For general support, browse the product list on the support page and select your product.

Related Publications

The following documentation is available for the SCv2000/SCv2020 storage system.

- *Dell Storage Center SCv2000 and SCv2020 Storage System Getting Started Guide*
Provides information about an SCv2000/SCv2020 storage system, such as installation instructions and technical specifications.
- *Dell Storage Center SCv2000 and SCv2020 Storage System Owner's Manual*
Provides information about an SCv2000/SCv2020 storage system, such as hardware features, replacing customer replaceable components, and technical specifications.
- *Dell Storage Center SCv2000 Series Virtual Media Update Instructions*
Describes how to install Storage Center software on an SCv2000/SCv2020 storage system using virtual media. Installing Storage Center software using the Storage Center Virtual Media option is intended for use only by sites that cannot update Storage Center using standard methods.
- *Dell Storage Center Release Notes*
Contains information about new features and known and resolved issues for the Storage Center software.

- *Dell Storage Client Administrator's Guide*
Provides information about the Dell Storage Client and how it can be used to manage a Storage Center.
- *Dell Storage Center Software Update Guide*
Describes how to upgrade Storage Center software from an earlier version to the current version.
- *Dell Storage Center Command Utility Reference Guide*
Provides instructions for using the Storage Center Command Utility. The Command Utility provides a command-line interface (CLI) to enable management of Storage Center functionality on Windows, Linux, Solaris, and AIX platforms.
- *Dell Storage Center Command Set for Windows PowerShell*
Provides instructions for getting started with Windows PowerShell cmdlets and scripting objects that interact with the Storage Center via the PowerShell interactive shell, scripts, and PowerShell hosting applications. Help for individual cmdlets is available online.
- *Dell TechCenter*
Provides technical white papers, best practice guides, and frequently asked questions about Dell Storage products. Go to: <http://en.community.dell.com/techcenter/storage/>.

About the SCv2000/SCv2020 Storage System

The SCv2000/SCv2020 storage system provides the central processing capabilities for the Storage Center Operating System (OS) and management of RAID storage.

The SCv2000/SCv2020 storage system holds the physical disks that provide storage for the Storage Center. If additional storage is needed, the SCv2000/SCv2020 also supports SC100/SC120 expansion enclosures.

Storage Center Hardware Components

The Storage Center described in this document consists of an SCv2000 or SCv2020 storage system, enterprise-class switches, and SC100/SC120 expansion enclosures.

The SCv2000/SCv2020 storage system supports multiple SC100/SC120 expansion enclosures to allow for storage expansion.

 **NOTE:** The cabling between the storage system, switches, and host servers is referred to as front-end connectivity. The cabling between the storage system and expansion enclosures is referred to as back-end connectivity.

SCv2000/SCv2020 Storage System

The SCv2000 and SCv2020 are 2U storage systems with built-in storage. The SCv2000 is a 2U storage system that supports up to 12 internal 3.5-inch hot-swappable SAS hard drives installed in a four-column, three-row configuration. The SCv2020 is a 2U storage system that supports up to 24 internal 2.5-inch hot-swappable SAS hard drives installed vertically side-by-side.

The SCv2000/SCv2020 storage system contains two redundant power supply/cooling fan modules and up to two storage controllers with multiple IO ports that provide communication with servers and expansion enclosures.

Switches

Dell offers enterprise-class switches as part of the total Storage Center solution.

The SCv2000/SCv2020 supports Fibre Channel (FC) and Ethernet switches, which provide robust connectivity to servers and allow for the use of redundant transport paths. Fibre Channel (FC) or Ethernet switches can provide connectivity to a remote Storage Center to allow for replication of data. In addition, Ethernet switches provide connectivity to a management network to allow configuration, administration, and management of the Storage Center.

Expansion Enclosures

An SCv2000/SCv2020 storage system supports multiple SC100/SC120 expansion enclosures. The expansion enclosures allow the data storage capabilities of the SCv2000/SCv2020 to be expanded beyond the 12 or 24 internal drives in the storage system chassis.

The SCv2000/SCv2020 storage system supports a total of 168 drives per Storage Center system. This total includes the drives in the SCv2000/SCv2020 storage system chassis and the drives in SC100/SC120 expansion enclosures chassis.

- The SCv2000 supports up to thirteen SC100 expansion enclosures, up to six SC120 expansion enclosures, or any combination of SC100/SC120 expansion enclosures as long as the total drive count of the system does not exceed 168.
- The SCv2020 supports up to twelve SC100 expansion enclosures, up to six SC120 expansion enclosures, or any combination of SC100/SC120 expansion enclosures as long as the total drive count of the system does not exceed 168.

Storage Center Architecture Options

A Storage Center with an SCv2000/SCv2020 storage system can be deployed in two configurations:

- An SCv2000/SCv2020 storage system without SC100/SC120 expansion enclosures.



Figure 1. SCv2000/SCv2020 without Expansion Enclosures

- An SCv2000/SCv2020 storage system with one or more SC100/SC120 expansion enclosures.
 **NOTE:** A storage system with a single storage controller cannot be deployed with expansion enclosures. The storage system must have dual storage controllers to deploy expansion enclosures.

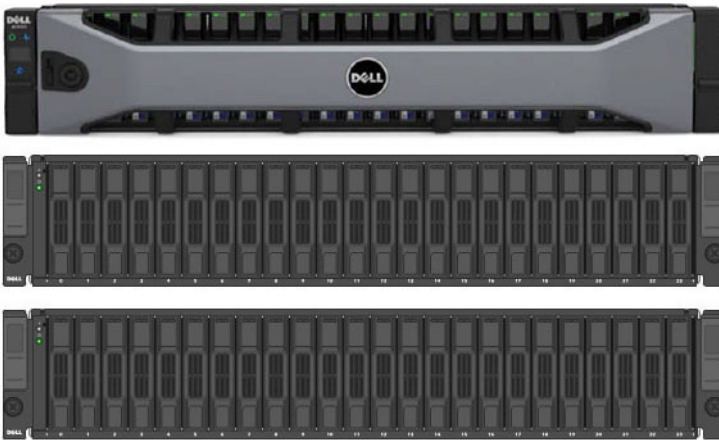

Figure 2. SCv2000/SCv2020 with Two Expansion Enclosures

Storage Center Replication

Storage Center sites can be collocated or remotely connected and data can be replicated between sites. Storage Center replication can duplicate volume data to another site in support a disaster recovery plan or to provide local access to a remote data volume. Typically, data is replicated remotely as part of an overall disaster avoidance or recovery plan.

The SCv2000 series Storage Center supports replication to other SCv2000 series Storage Centers. However, an Enterprise Manager Data Collector must be used to replicate data between the storage systems.

- For more information on installing an Enterprise Manager Data Collector, see the *Dell Enterprise Manager Installation Guide*.
- For more information on managing the Data Collector and setting up replications, see the *Dell Enterprise Manager Administrator's Guide*.

Storage Center Communication

A Storage Center uses multiple types of communication for both data transfer and administrative functions.

Storage Center communication is classified into three types: front end, back end, and system administration.

Front-End Connectivity

Front-end connectivity provides IO paths from servers to a storage system and replication paths from one Storage Center to another Storage Center. The SCv2000/SCv2020 provides three types of front-end connectivity:

- **Fibre Channel:** Hosts, servers, or Network Attached Storage (NAS) appliances access storage by connecting to the storage system Fibre Channel ports through one or more Fibre Channel switches. Connecting host servers directly to the storage system without using Fibre Channel switches is not supported.

When replication is licensed, the SCv2000/SCv2020 can use the Fibre Channel ports to replicate data to another Storage Center.

- **iSCSI:** Hosts, servers, or Network Attached Storage (NAS) appliances access storage by connecting to the storage system iSCSI ports through one or more Ethernet switches. Connecting host servers directly to the storage system without using Ethernet switches is not supported.

When replication is licensed, the SCv2000/SCv2020 can use the iSCSI ports to replicate data to another Storage Center

 **NOTE:** If replication is licensed, the SCv2000/SCv2020 can use the embedded REPL port to perform iSCSI replication to another SCv2000 series Storage Center.

If replication is licensed and the Flex Port license is installed, the SCv2000/SCv2020 can use the embedded MGMT port to perform iSCSI replication to another SCv2000 series Storage Center.

In addition, the SCv2000/SCv2020 can use the embedded MGMT and REPL ports as front-end iSCSI ports for connectivity to host servers when the Flex Port license is installed.

- **SAS:** Hosts or servers access storage by connecting directly to the storage system SAS ports.

 **NOTE:** The front-end connectivity ports are located on the back of the storage system, but are designated as front-end ports.

SCv2000/SCv2020 Storage System with Fibre Channel Front-End Connectivity

An SCv2000/SCv2020 storage system with Fibre Channel front-end connectivity may communicate with the following components of a Storage Center system.

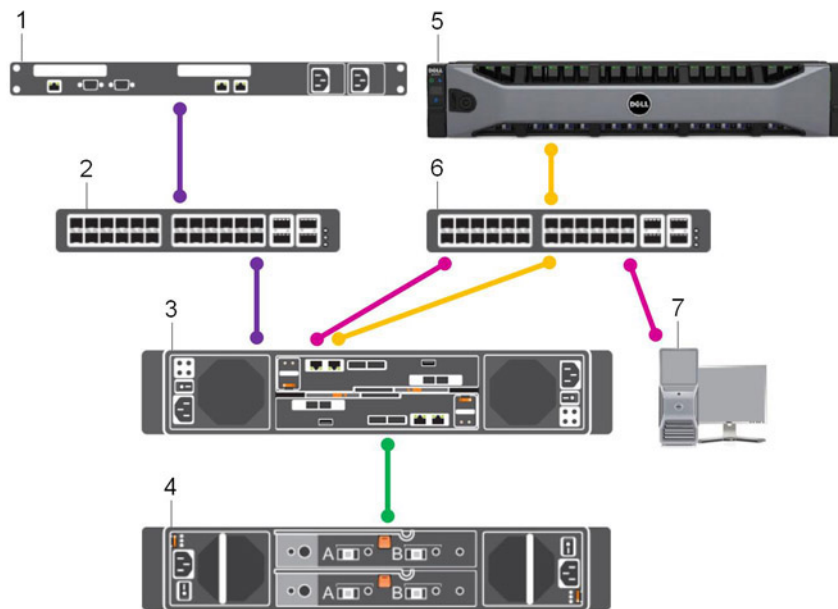

Figure 3. Storage System with Fibre Channel Front-End Connectivity

Item	Description	Speed	Communication Type
1	Server with Fibre Channel Host Bus Adapters (HBAs)	8 Gbps or 16 Gbps	Front End
2	Fibre Channel switch	8 Gbps or 16 Gbps	Front End
3	SCv2000/SCv2020 storage system with FC front-end connectivity	8 Gbps or 16 Gbps	Front End
4	SC100/SC120 expansion enclosures	6 Gbps per channel	Back End
5	Remote Storage Center connected via iSCSI for replication	1 Gbps	Front End
6	Ethernet switch	1 Gbps	Front End
7	Management network (Computer connected to the storage system through the Ethernet switch)	Up to 1 Gbps	System Administration

SCv2000/SCv2020 Storage System with iSCSI Front-End Connectivity

An SCv2000/SCv2020 storage system with iSCSI front-end connectivity may communicate with the following components of a Storage Center system.

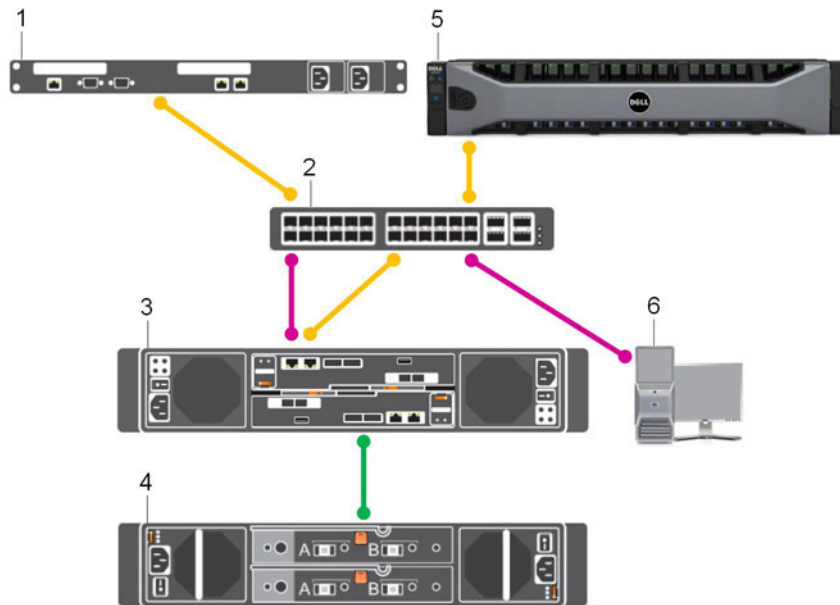

Figure 4. Storage System with iSCSI Front-End Connectivity

Item	Description	Speed	Communication Type
1	Server with Ethernet (iSCSI) ports or iSCSI Host Bus Adapters (HBAs)	1 Gbps or 10 Gbps	Front End
2	Ethernet switch	1 Gbps or 10 Gbps	Front End
3	SCv2000/SCv2020 storage system with iSCSI front-end connectivity	1 Gbps or 10 Gbps	Front End
4	SC100/SC120 expansion enclosures	6 Gbps per channel	Back End
5	Remote Storage Center connected via iSCSI for replication	1 Gbps or 10 Gbps	Front End
6	Management network (Computer connected to the storage system through the Ethernet switch)	Up to 1 Gbps	System Administration

SCv2000/SCv2020 Storage System with SAS Front-End Connectivity

An SCv2000/SCv2020 storage system with SAS front-end connectivity may communicate with the following components of a Storage Center system.

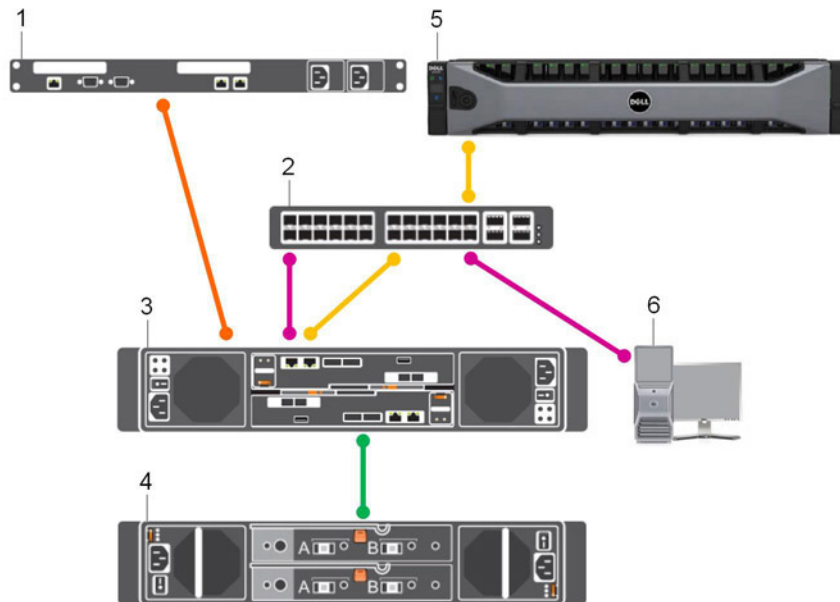

Figure 5. Storage System with SAS Front-End Connectivity

Item	Description	Speed	Communication Type
1	Server with SAS Host Bus Adapters (HBAs)	12 Gbps per channel	Front End
2	Ethernet switch	1 Gbps	Front End
3	SCv2000/SCv2020 storage system with SAS front-end connectivity	12 Gbps per channel	Front End
4	SC100/SC120 expansion enclosures	6 Gbps per channel	Back End
5	Remote Storage Center connected via iSCSI for replication	1 Gbps	Front End
6	Management network (Computer connected to the storage system through the Ethernet switch)	Up to 1 Gbps	System Administration

Back-End Connectivity

Back-end connectivity is strictly between the storage system and expansion enclosures, which hold the physical drives that provide back-end expansion storage.

The SCv2000/SCv2020 supports SAS connectivity to multiple SC100/SC120 expansion enclosures.

System Administration

To perform system administration, the Storage Center communicates with computers using the Ethernet management (MGMT) port.

The Ethernet management port is used for Storage Center configuration, administration, and management.

NOTE: The baseboard management controller (BMC) does not have a separate physical port on the SCv2000/SCv2020. The BMC is accessed through the same Ethernet management port that is used for Storage Center configuration, administration, and management.

SCv2000/SCv2020 Storage System Hardware

The SCv2000/SCv2020 storage system ships with Dell Enterprise drives, two power supply/cooling fan modules, and either one storage controller or two redundant storage controllers.

Each storage controller contains the front-end, back-end, and management communication ports of the storage system.

SCv2000/SCv2020 Storage System Front Panel Features and Indicators

The front panel of the SCv2000/SCv2020 contains power and status indicators, a system identification button, and a seven-segment display.

In addition, the hard drives are installed and removed through the front of the storage system chassis.

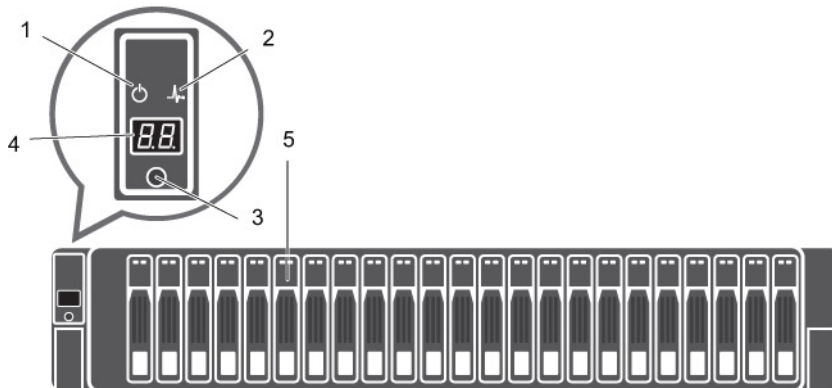

Figure 6. SCv2000 Front Panel View

Item	Name	Icon	Description
1	Power indicator		Lights when the storage system power is on. <ul style="list-style-type: none">• Off: No power• On steady green: At least one power supply is providing power to the storage system
2	Status indicator		Lights when at least one power supply is supplying power to the storage system. <ul style="list-style-type: none">• Off: No power• On steady blue: Power is on and firmware is running• Blinking blue: Storage system is busy booting or updating

Item	Name	Icon	Description
			<ul style="list-style-type: none"> • On steady amber: Hardware detected fault • Blinking amber: Software detected fault
3	Identification button	?	Lights when the storage system identification is enabled. <ul style="list-style-type: none"> • Off: Normal status • Blinking blue: Storage system identification enabled
4	Unit ID display	—	Displays the storage system identification number (01).
5	Hard drives	—	Up to 12 3.5-inch or 24 2.5-inch SAS hard drives

SCv2000/SCv2020 Back-Panel Features and Indicators

The back panel of the SCv2000/SCv2020 shows the storage controller indicators and power supply indicators.

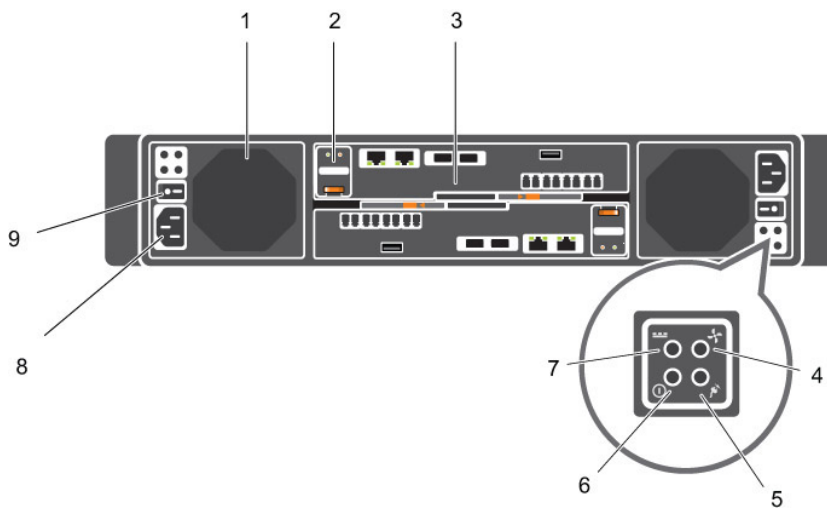







Figure 7. SCv2000/SCv2020 Back Panel View

Item	Name	Icon	Description
1	Power supply/ cooling fan module (PSU) (2)	—	Contains a 580 W power supply and fans that provide cooling for the storage system.
2	Battery backup unit (BBU) (2)	—	Allows the storage controller to shut down gracefully when a loss of AC power is detected.
3	Storage controller (1 or 2)	—	Each storage controller module contains: <ul style="list-style-type: none"> • Back-end ports: Two 6 Gbps SAS ports • Front-end ports: Fibre Channel ports, iSCSI ports, or SAS ports • MGMT port: Embedded Ethernet/iSCSI port, which is typically used for system management <p> NOTE: The MGMT port can share iSCSI traffic if the Flex Port license is installed.</p>

Item	Name	Icon	Description
			<ul style="list-style-type: none"> • REPL port: Embedded iSCSI port, which is typically used for replication to another Storage Center
4	Cooling fan fault indicator (2)		<ul style="list-style-type: none"> • Off: Normal operation • Steady amber: Fan fault or there is a problem communicating with the PSU • Blinking amber: PSU is in programming mode
5	AC power fault indicator (2)		<ul style="list-style-type: none"> • Off: Normal operation • Steady Amber: A PSU has been removed or there is a problem communicating with the PSU • Blinking amber: PSU is in programming mode
6	AC power status indicator (2)		<ul style="list-style-type: none"> • Off: AC power is off, or the power is on but the module is not in a controller, or it may indicate a hardware fault • Steady green: AC power is on • Blinking green: AC power is on and the PSU is in standby mode
7	DC power fault indicator (2)		<ul style="list-style-type: none"> • Off: Normal operation • Steady amber: A PSU has been removed, or there is a DC or other hardware fault, or there is a problem communicating with the PSU • Blinking amber: PSU is in programming mode
8	Power socket (2)	—	Accepts a standard computer power cord.
9	Power switch (2)	—	Controls power for the storage system. There is one switch for each power supply/cooling fan module.

SCv2000/SCv2020 Storage Controller Features and Indicators

The SCv2000/SCv2020 includes up to two storage controllers in two interface slots. The storage controllers support Fibre Channel, iSCSI, or SAS front-end ports.

SCv2000/SCv2020 Storage Controller with Fibre Channel Front-End Ports

Features and indicators on a storage controller with Fibre Channel front-end ports.

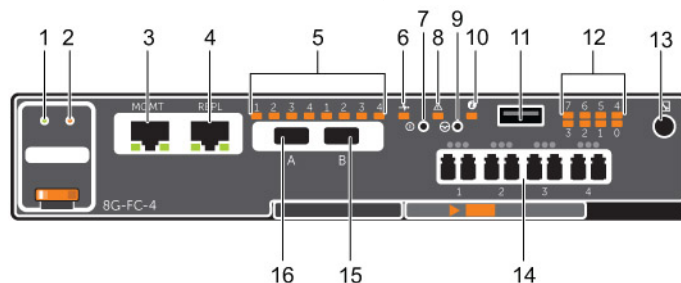

Figure 8. Storage Controller with Four 8 Gb Fibre Channel Front-End Ports

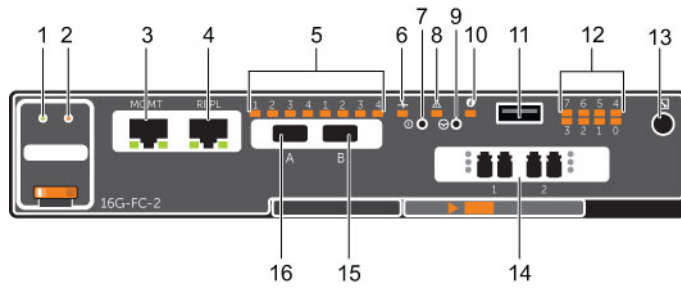

Figure 9. Storage Controller with Two 16 Gb Fibre Channel Front-End Ports

Item	Control/Feature	Icon	Description
1	Battery status indicator		<ul style="list-style-type: none"> Blinking green (on 0.5 sec. / off 1.5 sec.): Battery heartbeat Fast blinking green (on 0.5 sec. / off 0.5 sec.): Battery is charging Steady green: Battery is ready
2	Battery fault indicator		<ul style="list-style-type: none"> Off: No faults Blinking amber: Correctable fault detected Steady amber: Uncorrectable fault detected; replace battery
3	MGMT port	—	<p>10 Mbps, 100 Mbps, or 1 Gbps Ethernet/iSCSI port used for storage system management and access to the BMC</p> <p> NOTE: To use the MGMT port as an iSCSI port for replication to another Storage Center, a Flex Port license and replication license are required. To use the MGMT port as a front-end connection to host servers, a Flex Port license is required.</p>
4	REPL port	—	<p>10 Mbps, 100 Mbps, or 1 Gbps Ethernet/iSCSI port used for replication to another Storage Center (requires a replication license)</p> <p> NOTE: To use the RELP port as a front-end connection to host servers, a Flex Port license is required.</p>
5	SAS activity indicators	—	<ul style="list-style-type: none"> Off: Port is off Steady green: Port is on, but without activity Blinking green: Port is on and there is activity
6	Storage controller module status		On: Storage controller completed POST
7	Recessed power off button		Powers down the storage controller if held for more than five seconds
8	Storage controller module fault		<ul style="list-style-type: none"> Off: No faults Steady amber: Firmware has detected an error Blinking amber: Storage controller is performing POST
9	Recessed reset button		Reboots the storage controller forcing it to restart at the POST process

Item	Control/Feature	Icon	Description
10	Identification LED		<ul style="list-style-type: none"> Off: Identification disabled Blinking blue (for 15 sec.): Identification is enabled Blinking blue (continuously): Storage controller shut down to the Advanced Configuration and Power Interface (ACPI) S5 state
11	USB port		Not for customer use on SCv2000/SCv2020 Storage Systems.
12	Diagnostic LEDs (8)	—	<ul style="list-style-type: none"> Green LEDs 0–3: Low byte hex POST code Green LEDs 4–7: High byte hex POST code
13	Serial port (3.5 mm mini jack)		Not for customer use.
14	Four or two Fibre Channel ports with three LEDs per port	—	<ul style="list-style-type: none"> All off: No power All on: Booting up Blinking amber: 2 Gbps activity Blinking green: 4 Gbps activity Blinking yellow: 8 Gbps activity Blinking amber and yellow: Beacon All blinking (simultaneous): Firmware initialized All blinking (alternating): Firmware fault
15	Mini-SAS port B		Back-end expansion port B
16	Mini-SAS port A		Back-end expansion port A

SCv2000/SCv2020 Storage Controller with iSCSI Front-End Ports

Features and indicators on a storage controller with iSCSI front-end ports.

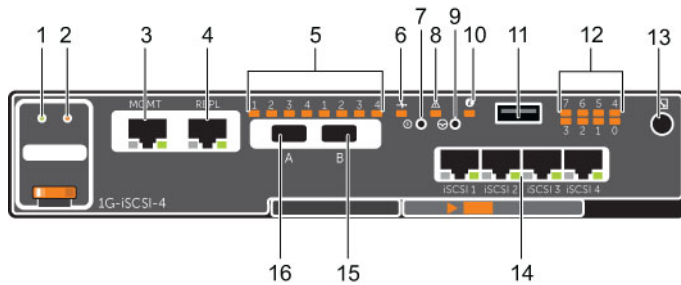

Figure 10. SCv2000/SCv2020 Storage Controller with Four 1 GbE iSCSI Front-End Ports

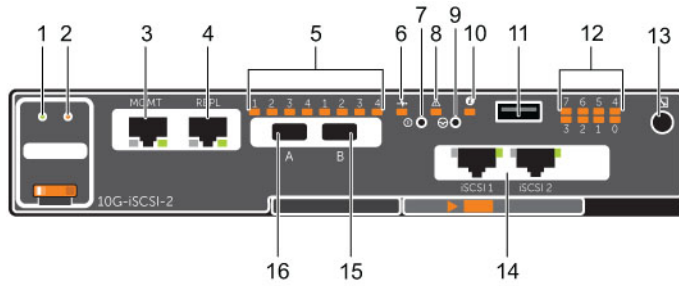





Figure 11. SCv2000/SCv2020 Storage Controller with Two 10 GbE iSCSI Front-End Ports

Item	Control/Feature	Icon	Description
1	Battery status indicator		<ul style="list-style-type: none"> Blinking green (on 0.5 sec. / off 1.5 sec.): Battery heartbeat Fast blinking green (on 0.5 sec. / off 0.5 sec.): Battery is charging Steady green: Battery is ready
2	Battery fault indicator		<ul style="list-style-type: none"> Off: No faults Blinking amber: Correctable fault detected Steady amber: Uncorrectable fault detected; replace battery
3	MGMT port	—	<p>10 Mbps, 100 Mbps, or 1 Gbps Ethernet port used for storage system management and access to the BMC</p> <p> NOTE: To use the MGMT port as an iSCSI port for replication to another Storage Center, a Flex Port license and replication license are required. To use the MGMT port as a front-end connection to host servers, a Flex Port license is required.</p>
4	REPL port	—	<p>10 Mbps, 100 Mbps, or 1 Gbps Ethernet/iSCSI port used for replication to another Storage Center</p> <p> NOTE: To use the RELP port as a front-end connection to host servers, a Flex Port license is required.</p>
5	SAS activity indicators	—	<ul style="list-style-type: none"> Off: Port is off Steady green: Port is on, but without activity Blinking green: Port is on and there is activity
6	Storage controller module status		On: Storage controller completed POST
7	Recessed power off button		Powers down the storage controller if held for more than five seconds
8	Storage controller module fault		<ul style="list-style-type: none"> Off: No faults Steady amber: Firmware has detected an error Blinking amber: Storage controller is performing POST
9	Recessed reset button		Reboots the storage controller forcing it to restart at the POST process
10	Identification LED		<ul style="list-style-type: none"> Off: Identification disabled Blinking blue (for 15 sec.): Identification is enabled

Item	Control/Feature	Icon	Description
			<ul style="list-style-type: none"> • Blinking blue (continuously): Storage controller shut down to the Advanced Configuration and Power Interface (ACPI) S5 state
11	USB port		Not for customer use on SCv2000/SCv2020 Storage Systems.
12	Diagnostic LEDs (8)	—	<ul style="list-style-type: none"> • Green LEDs 0–3: Low byte hex POST code • Green LEDs 4–7: High byte hex POST code
13	Serial port (3.5 mm mini jack)		Not for customer use.
14	Four or two iSCSI ports with two LEDs per port	—	<ul style="list-style-type: none"> • Off: No power • Steady Amber: Link • Blinking Green: Activity
15	Mini-SAS port B		Back-end expansion port B
16	Mini-SAS port A		Back-end expansion port A

SCv2000/SCv2020 Storage Controller with SAS Front-End Ports

Features and indicators on a storage controller with SAS front-end ports.

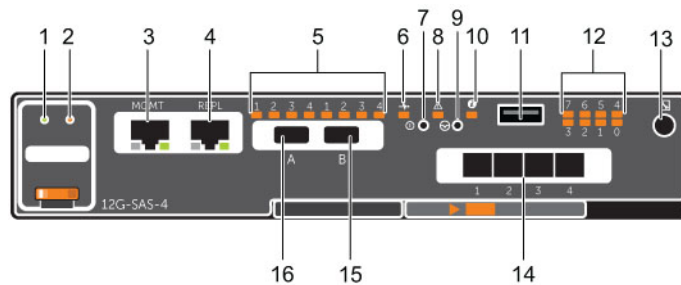















Figure 12. SCv2000/SCv2020 Storage Controller with Four 12 Gb SAS Front-End Ports

Item	Control/Feature	Icon	Description
1	Battery status indicator		<ul style="list-style-type: none"> • Blinking green (on 0.5 sec. / off 1.5 sec.): Battery heartbeat • Fast blinking green (on 0.5 sec. / off 0.5 sec.): Battery is charging • Steady green: Battery is ready
2	Battery fault indicator		<ul style="list-style-type: none"> • Off: No faults • Blinking amber: Correctable fault detected • Steady amber: Uncorrectable fault detected; replace battery
3	MGMT port	—	10 Mbps, 100 Mbps, or 1 Gbps Ethernet port used for storage system management and access to the BMC

Item	Control/Feature	Icon	Description
			 NOTE: To use the MGMT port as an iSCSI port for replication to another Storage Center, a Flex Port license and replication license are required. To use the MGMT port as a front-end connection to host servers, a Flex Port license is required.
4	REPL port	—	10 Mbps, 100 Mbps, or 1 Gbps Ethernet/iSCSI port used for replication to another Storage Center
			 NOTE: To use the RELP port as a front-end connection to host servers, a Flex Port license is required.
5	SAS activity indicators	—	<ul style="list-style-type: none"> • Off: Port is off • Steady green: Port is on, but without activity • Blinking green: Port is on and there is activity
6	Storage controller module status		On: Storage controller completed POST
7	Recessed power off button		Powers down the storage controller if held for more than five seconds
8	Storage controller module fault		<ul style="list-style-type: none"> • Off: No faults • Steady amber: Firmware has detected an error • Blinking amber: Storage controller is performing POST
9	Recessed reset button		Reboots the storage controller forcing it to restart at the POST process
10	Identification LED		<ul style="list-style-type: none"> • Off: Identification disabled • Blinking blue (for 15 sec.): Identification is enabled • Blinking blue (continuously): Storage controller shut down to the Advanced Configuration and Power Interface (ACPI) S5 state
11	USB port		Not for customer use on SCv2000/SCv2020 Storage Systems.
12	Diagnostic LEDs (8)	—	<ul style="list-style-type: none"> • Green LEDs 0–3: Low byte hex POST code • Green LEDs 4–7: High byte hex POST code
13	Serial port (3.5 mm mini jack)		Not for customer use.
14	Four Mini-SAS High Density (HD) ports	—	Front-end connectivity ports  NOTE: The mini-SAS HD ports are for front-end connectivity only and cannot be used for back-end expansion.
15	Mini-SAS port B		Back-end expansion port B
16	Mini-SAS port A		Back-end expansion port A

SCv2000/SCv2020 Drives

Dell Enterprise hard disk drives (HDDs) and Enterprise Solid-State Drives (eSSDs) are the only drives that can be installed in an SCv2000/SCv2020 storage system. If a non-Dell Enterprise drive is installed, Storage Center prevents the drive from being managed.

The drives in an SCv2000 storage system are installed horizontally. The drives in an SCv2020 storage system are installed vertically. The indicators on the drives provide status and activity information.



Figure 13. SCv2000/SCv2020 Drive Indicators

Item	Name	Indicator Code
1	Drive activity indicator	<ul style="list-style-type: none"> Blinking green: Drive activity Steady green: Drive is detected and there are no faults
2	Drive status indicator	<ul style="list-style-type: none"> Off: Normal operation Blinking amber (on 1 sec. / off 1 sec.): Drive identification is enabled Blinking amber (on 2 sec. / off 1 sec.): Drive failed Steady amber: Drive is safe to remove

SCv2000/SCv2020 Storage System Drive Numbering

In an SCv2000/SCv2020 storage system, the drives are numbered from left to right.

Dell Storage Client identifies drives as *XX-YY*, where *XX* is the number of the unit ID of the storage system, and *YY* is the drive position inside the storage system.

- An SCv2000 holds up to 12 drives, which are numbered left to right in rows starting from 0 at the top-left drive.

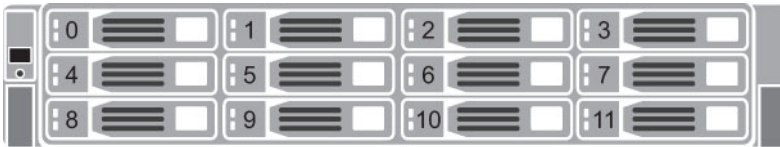

Figure 14. SCv2000 Drive Numbering

- An SCv2020 holds up to 24 drives, which are numbered left to right starting from 0.



Figure 15. SCv2020 Drive Numbering

SC100/SC120 Expansion Enclosure Overview

The SC100 is a 2U expansion enclosure that supports up to 12 3.5-inch hard drives installed in a four-column, three-row configuration. The SC120 is a 2U expansion enclosure that supports up to 24 2.5-inch hard drives installed vertically side-by-side.

The SC100/SC120 expansion enclosure ships with two redundant power supply/cooling fan modules and two redundant enclosure management modules (EMMs).

SC100/SC120 Expansion Enclosure Front Panel Features and Indicators

The SC100/SC120 front panel shows the expansion enclosure status and power supply status.



Figure 16. SC100 Front-Panel Features and Indicators

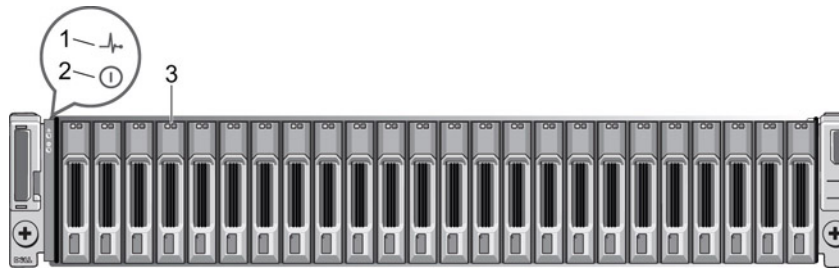

Figure 17. SC120 Front-Panel Features and Indicators

Item	Name	Icon	Description
1	Expansion enclosure status indicator		Lights when the expansion enclosure power is on. <ul style="list-style-type: none"> • Off: No power • On steady blue: Normal operation • Blinking blue: Indicates that Storage Center is identifying the enclosure • On steady amber: Expansion enclosure is turning on or was reset • Blinking amber: Expansion enclosure is in the fault state.
2	Power supply status indicator		Lights when at least one power supply is supplying power to the expansion enclosure. <ul style="list-style-type: none"> • Off: Both power supplies are off. • On steady green: At least one power supply is providing power to the expansion enclosure

Item	Name	Icon	Description
3	Hard drives	—	Dell Enterprise Plus Drives <ul style="list-style-type: none"> • SC100: Up to 12 3.5-inch hard drives • SC120: Up to 24 2.5-inch hard drives

SC100/SC120 Expansion Enclosure Back Panel Features and Indicators

The SC100/SC120 back panel provides controls to power up and reset the expansion enclosure, indicators to show the expansion enclosure status, and connections for back-end cabling.

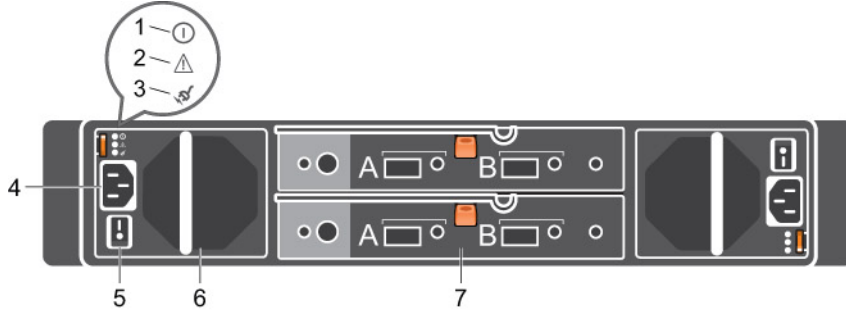

Figure 18. SC100/SC120 Back Panel View

Item	Name	Icon	Description
1	DC power indicator	①	<ul style="list-style-type: none"> • Green: Normal operation. The power supply module is supplying DC power to the expansion enclosure • Off: Power switch is off, the power supply is not connected to AC power, or there is a fault condition
2	Power supply/cooling fan indicator	⚠	<ul style="list-style-type: none"> • Amber: Power supply/cooling fan fault is detected • Off: Normal operation
3	AC power indicator	⚡	<ul style="list-style-type: none"> • Green: Power supply module is connected to a source of AC power, whether or not the power switch is on • Off: Power supply module is disconnected from a source of AC power
4	Power socket (2)	—	Accepts a standard computer power cord.
5	Power switches (2)	—	Controls power for the expansion enclosure. There is one switch for each power supply/cooling fan module.
6	Power supply/cooling fan modules (2)	—	Contains a 700 W power supply and fans that provide cooling for the expansion enclosure.
7	Enclosure Management Modules (2)	—	EMMs provide the data path and management functions for the expansion enclosure.

SC100/SC120 Expansion Enclosure EMM Features and Indicators

The SC100/SC120 includes two Enclosure Management Modules (EMMs) in two interface slots.

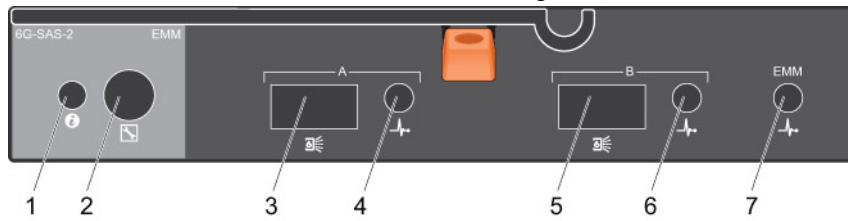

Figure 19. SC100/SC120 EMM Features and Indicators

Item	Name	Icon	Description
1	System status indicator		Not used on SC100/SC120 expansion enclosures.
2	Serial port		Not for customer use.
3	SAS port A (in)		Connects to a storage controller or to other SC100/SC120 expansion enclosures. SAS ports A and B can be used for either input or output. However for cabling consistency, use port A as an input port.
4	Port A link status		<ul style="list-style-type: none"> Green: All the links to the port are connected Amber: One or more links are not connected Off: Expansion enclosure is not connected
5	SAS port B (out)		Connects to a storage controller or to other SC100/SC120 expansion enclosures. SAS ports A and B can be used for either input or output. However for cabling consistency, use port B as an output port.
6	Port B link status		<ul style="list-style-type: none"> Green: All the links to the port are connected Amber: One or more links are not connected Off: Expansion enclosure is not connected
7	EMM status indicator		<ul style="list-style-type: none"> On steady green: Normal operation Amber: Expansion enclosure did not boot or is not properly configured Blinking green: Automatic update in process Blinking amber (two times per sequence): Expansion enclosure is unable to communicate with other expansion enclosures Blinking amber (four times per sequence): Firmware update failed Blinking amber (five times per sequence): Firmware versions are different between the two EMMs

SC100/SC120 Expansion Enclosure Drives

Dell Enterprise hard disk drives (HDDs) and Enterprise Solid-State Drives (eSSDs) are the only drives that can be installed in SC100/SC120 expansion enclosures. If a non-Dell Enterprise drive is installed, Storage Center prevents the drive from being managed.

The drives in an SC100 expansion enclosure are installed horizontally. The drives in an SC120 expansion enclosure are installed vertically. The indicators on the drives provide status and activity information.



Figure 20. SC100/SC120 Drive Indicators

Item	Name	Indicator Code
1	Drive activity indicator	<ul style="list-style-type: none"> Blinking green: Indicates drive activity Steady green: Indicates no drive activity
2	Drive status indicator	<ul style="list-style-type: none"> Steady green: Normal operation Blinking green (on 1 sec. / off 1 sec.): Drive identification is enabled Off: No power to the drive

SC100/SC120 Expansion Enclosure Drive Numbering

In an SC100/SC120 expansion enclosure, the drives are numbered from left to right starting from 0. Dell Storage Client identifies drives as *XX-YY*, where *XX* is the unit ID of the expansion enclosure that contains the drive, and *YY* is the drive position inside the expansion enclosure.

- An SC100 holds up to 12 drives, which are numbered in rows starting from 0 at the top-left drive.



Figure 21. SC100 Drive Numbering

- An SC120 holds up to 24 drives, which are numbered left to right starting from 0.

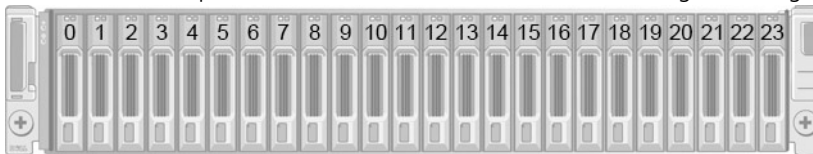

Figure 22. SC120 Drive Numbering

Install the Storage Center Hardware

Prepare for the installation, mount the equipment in a rack, and install the disks.

Unpack and Inventory the Storage Center Equipment

Unpack the storage system and identify the items in your shipment.

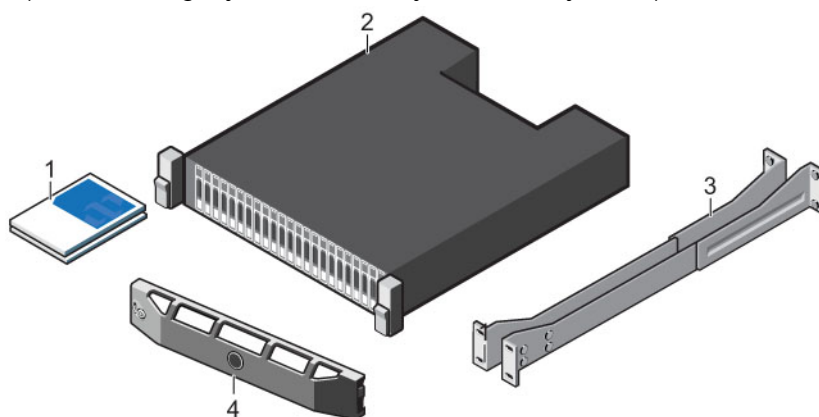

Figure 23. SCv2000/SCv2020 Storage System Components

- | | |
|------------------|-------------------|
| 1. Documentation | 2. Storage system |
| 3. Rack rails | 4. Front bezel |

Prepare the Installation Environment

Make sure that the environment is ready for Storage Center installation.

- **Rack Space:** There must be sufficient space in the rack to accommodate the storage system chassis, expansion enclosures, and switches.
- **Power:** Power must be available in the rack, and the power delivery system must meet the requirements of the Storage Center.
- **Connectivity:** The rack must be wired for connectivity to the management network and any networks that carry front-end IO from the Storage Center to servers.

Safety Precautions

Always follow these safety precautions to avoid injury and damage to Storage Center equipment.

If equipment described in the document is used in a manner not specified by Dell, the protection provided by the equipment may be impaired. For your safety and protection, observe the rules described in the following sections.

 **NOTE:** See the safety and regulatory information that shipped with each Storage Center component. Warranty information may be included within this document or as a separate document.

Installation Safety Precautions

Follow these safety precautions:

- Dell recommends that only individuals with rack-mounting experience install an SCv2000/SCv2020 storage system in a rack.
- Make sure the storage system is fully grounded at all times to prevent damage from electrostatic discharge.
- When handling the storage system hardware, you should use an electrostatic wrist guard (not included) or a similar form of protection.

The storage system chassis **MUST** be mounted in a rack; the following safety requirements must be considered when doing so:

- The rack construction must be capable of supporting the total weight of the installed chassis and the design should incorporate stabilizing features suitable to prevent the rack tipping or being pushed over during installation or in normal use.
- To avoid danger of the rack toppling over, do not slide more than one chassis out of the rack at a time.
- The rack design should take into consideration the maximum operating ambient temperature for the unit, which is 57°C.

Electrical Safety Precautions

Always follow electrical safety precautions to avoid injury and damage to Storage Center equipment.

 **WARNING: Disconnect power from the storage system when removing or installing components that are not hot-swappable. When disconnecting power, first power down the storage system using the Dell Storage Client and then unplug the power cords from all the power supplies in the storage system.**

- Provide a suitable power source with electrical overload protection. All Storage Center components must be grounded before applying power. Make sure that there is a safe electrical earth connection to power supply cords. Check the grounding before applying power.
- The plugs on the power supply cords are used as the main disconnect device. Make sure that the socket outlets are located near the equipment and are easily accessible.
- Know the locations of the equipment power switches and the room's emergency power-off switch, disconnection switch, or electrical outlet.
- Do not work alone when working with high-voltage components.
- Use rubber mats specifically designed as electrical insulators.
- Do not remove covers from the power supply unit. Disconnect the power connection before removing a power supply from the storage system.
- Do not remove a faulty power supply unless you have a replacement model of the correct type ready for insertion. A faulty power supply must be replaced with a fully operational module power supply within 24 hours.
- Unplug the storage system chassis before you move it or if you think it has become damaged in any way. When powered by multiple AC sources, disconnect all supply power for complete isolation.

Electrostatic Discharge Precautions

Always follow electrostatic discharge (ESD) precautions to avoid injury and damage to Storage Center equipment.

Electrostatic discharge (ESD) is generated by two objects with different electrical charges coming into contact with each other. The resulting electrical discharge can damage electronic components and printed circuit boards. Follow these guidelines to protect your equipment from ESD:

- Dell recommends that you always use a static mat and static strap while working on components in the interior of the storage system chassis.
- Observe all conventional ESD precautions when handling plug-in modules and components.
- Use a suitable ESD wrist or ankle strap.
- Avoid contact with backplane components and module connectors.
- Keep all components and printed circuit boards (PCBs) in their antistatic bags until ready for use.

General Safety Precautions

Always follow general safety precautions to avoid injury and damage to Storage Center equipment.

- Keep the area around the storage system chassis clean and free of clutter.
- Place any system components that have been removed away from the storage system chassis or on a table so that they are not in the way of foot traffic.
- While working on the storage system chassis, do not wear loose clothing such as neckties and unbuttoned shirt sleeves, which can come into contact with electrical circuits or be pulled into a cooling fan.
- Remove any jewelry or metal objects from your body because they are excellent metal conductors that can create short circuits and harm you if they come into contact with printed circuit boards or areas where power is present.
- Do not lift a storage system chassis by the handles of the power supply units (PSUs). They are not designed to hold the weight of the entire chassis, and the chassis cover may become bent.
- Before moving a storage system chassis, remove the PSUs to minimize weight.
- Do not remove drives until you are ready to replace them.

 **NOTE:** To ensure proper storage system cooling, hard drive blanks must be installed in any hard drive slot that is not occupied.

Install the Storage System in a Rack

Install the storage system and other Storage Center system components in a rack.

About this task

Mount the storage system and expansion enclosures in a manner that allows for expansion in the rack and prevents the rack from becoming top-heavy.

Steps

1. Secure the rails that are pre-attached to both sides of the storage system chassis.
 - a. Lift the locking tab on the rail.
 - b. Push the rail towards the back of the chassis until it locks in place.
2. Determine where to mount the storage system and mark the location at the front and rear of the rack.

NOTE: The storage system and expansion enclosures each require 2U of rack space for installation.

3. Position a rail at the marked location and extend the rail to fit the rack.
4. Insert the two rail pins into the pin holes.

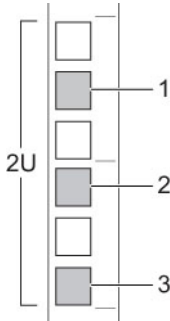

Figure 24. Hole Locations in Rack

1. Pin hole
2. Rack mounting screw hole
3. Pin hole

5. Insert a screw into the rack mounting screw hole and tighten the screw to secure the rail to the rack.
6. Repeat the previous steps for the second rail.
7. Slide the storage system chassis onto the rails.

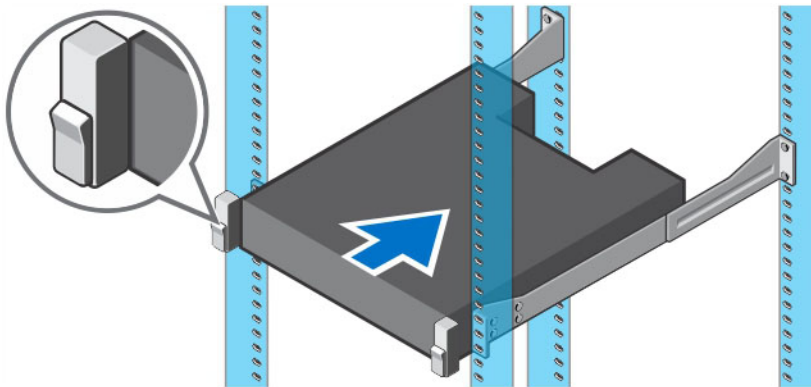

Figure 25. Mount the SCv2000/SCv2020 Storage System Chassis

8. Secure the storage system chassis to the rack using the mounting screws within each chassis ear.
 - a. Lift the latch on each chassis ear to access the screws.
 - b. Tighten the screws to secure the chassis into the rack.
 - c. Close the latch on each chassis ear.
9. If the Storage Center system includes expansion enclosures, mount the expansion enclosures in the rack. See the instructions included with the expansion enclosure for detailed steps.

Front-End Cabling

Front-end cabling refers to the connections between the storage system and external devices such as host servers or another Storage Center.

Front-end connections can be made using Fibre Channel, iSCSI, or SAS interfaces. Dell recommends connecting the storage system to host servers using the most redundant option available.

Types of Redundancy for Front-End Connections

Front-end redundancy is achieved by eliminating single points of failure that could cause a server to lose connectivity to Storage Center.

Depending on how Storage Center is cabled and configured, the following types of redundancy are available.

Table 1. Redundancy and Failover Behavior

Redundancy	Failover Behavior
Port redundancy	If a single port becomes unavailable, the port can fail over to another available port in the same fault domain.
Storage controller redundancy	If a storage controller becomes unavailable, the ports on the offline storage controller can move to the available storage controller.
Asymmetric Logical Unit Access (ALUA)	If a storage controller becomes unavailable, all of the standby paths on the other storage controller become active.
Multipath IO (MPIO)	When multiple paths are available from a server to a storage system, a server configured for multipath IO can use multiple paths for IO. If a path becomes unavailable, the server continues to use the remaining available paths.

Port Redundancy

To allow for port redundancy, two front-end ports on a storage controller must be connected to the same switch or server.

Fault domains group front-end ports that are connected to the same network. Ports that belong to the same fault domain can fail over to each other because they have the same connectivity.

If a port becomes unavailable because it is disconnected or there is a hardware failure, the port moves over to another port in the same fault domain.

Storage Controller Redundancy

To allow for storage controller redundancy, a front-end port on each storage controller must be connected to the same switch or server.

If a storage controller becomes unavailable, the front-end ports on the offline storage controller move over to the ports (in the same fault domain) on available storage controller.

Multipath IO

MPIO allows a server to use multiple paths for IO if they are available.

MPIO software offers redundancy at the path level. MPIO typically operates in a round-robin manner by sending packets first down one path and then the other. If a path becomes unavailable, MPIO software continues to send packets down the functioning path. MPIO is required to enable redundancy for servers connected to a Storage Center with SAS front-end connectivity.

 **NOTE:** MPIO is operating-system specific and it loads as a driver on the server or it is part of the server operating system.

MPIO Behavior

The server must have at least two FC, iSCSI, or SAS ports to use MPIO.

When MPIO is configured, a server can send IO to multiple ports on the same storage controller.

MPIO Configuration Instructions for Host Servers

To use MPIO, configure MPIO on the host server.

If a Dell Storage Client wizard is used to configure host server access to Storage Center, the Dell Storage Client attempts to automatically configure MPIO with best practices.

 **NOTE:** Compare the host server settings applied by the Dell Storage Client wizard against the latest Dell Storage Center Best Practices document located on the Dell TechCenter (<http://en.community.dell.com/techcenter/storage/>).

Table 2. MPIO Configuration Documents

Operating System	Document with MPIO Instructions
Linux	<ul style="list-style-type: none"><i>Dell Compellent Storage Center Linux Best Practices</i><i>Red Hat Enterprise Linux (RHEL) 6x Best Practices</i><i>Dell Compellent Best Practices: Storage Center with SUSE Linux Enterprise Server 11</i>
VMware vSphere 5.x	<i>Dell Compellent Storage Center Best Practices with vSphere 5.x</i>
Windows Server 2008, 2008 R2, 2012, and 2012 R2	<i>Dell Compellent Storage Center Microsoft Multipath IO (MPIO) Best Practices Guide</i>

To manually configure MPIO on a host server, see the Dell Best Practices document that corresponds to the server operating system. Depending on the operating system, you may need to install MPIO software or configure server options.

Cabling SAN-Attached Host Servers

An SCv2000/SCv2020 storage system with Fibre Channel or iSCSI front-end ports connects to host servers through Fibre Channel or Ethernet switches.

- A storage system with Fibre Channel front-end ports connects to one or more FC switches, which connect to one or more host servers.
- A storage system with iSCSI front-end ports connects to one or more Ethernet switches, which connect to one or more host servers.

Connecting to Fibre Channel Host Servers

Choose the Fibre Channel connectivity option that best suits the front-end redundancy requirements and network infrastructure.

Preparing Host Servers

Install the Fibre Channel host bus adapters (HBAs), install the drivers, and make sure that the latest supported firmware is installed.

About this task

 **NOTE:** Refer to the *Dell Storage Compatibility Matrix* for a list of supported Fibre Channel HBAs.

Steps

1. Install Fibre Channel HBAs in the host servers.
 -  **NOTE:** Do not install Fibre Channel HBAs from different vendors in the same server.
2. Install supported drivers for the HBAs and make sure that the HBAs have the latest supported firmware
3. Use the Fibre Channel cabling diagrams to cable the host servers to the switches. Connecting host servers directly to the storage system without using Fibre Channel switches is not supported.

Two Fibre Channel Fabrics with Dual 16 Gb 2-Port Storage Controllers

Use two Fibre Channel (FC) fabrics to prevent an unavailable port, switch, or storage controller from causing a loss of connectivity between host servers and a storage system with dual 16 Gb 2-port storage controllers

About this task

In this configuration, there are two fault domains, two FC fabrics, and two FC switches. The storage controllers connect to each FC switch using one FC connection.

- If a physical port or FC switch becomes unavailable, the storage system is accessed from the switch in the other fault domain.
- If a storage controller becomes unavailable, the virtual ports on the offline storage controller move to the physical ports on the other storage controller.

Steps

1. Connect each server to both FC fabrics.
2. Connect fault domain 1 (shown in orange) to fabric 1.
 - Storage controller 1: port 1 to FC switch 1
 - Storage controller 2: port 1 to FC switch 1
3. Connect fault domain 2 (shown in blue) to fabric 2.

- Storage controller 1: port 2 to FC switch 2
- Storage controller 2: port 2 to FC switch 2

Example

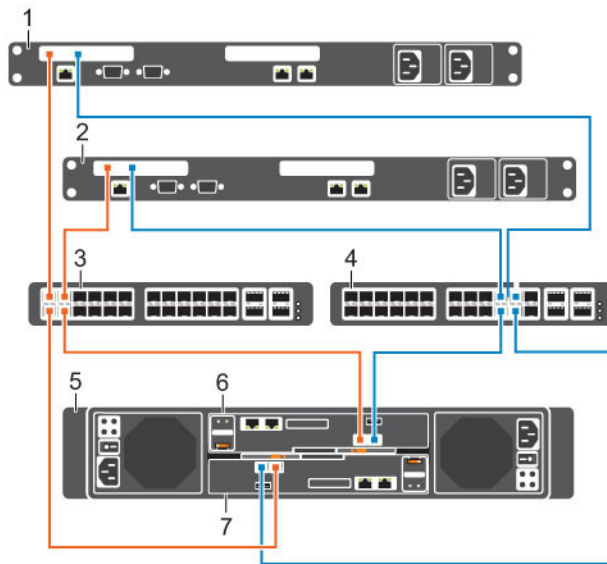

Figure 26. Storage System with Dual 16 Gb Storage Controllers and Two FC Switches

- | | |
|---------------------------------|---------------------------------|
| 1. Server 1 | 2. Server 2 |
| 3. FC switch 1 (Fault Domain 1) | 4. FC switch 2 (Fault Domain 2) |
| 5. Storage system | 6. Storage controller 1 |
| 7. Storage controller 2 | |

Next steps

Install or enable MPIO on the host servers.

NOTE: After the Storage Center configuration is complete, run the host access wizard to configure host server access and apply MPIO best practices. For the latest best practices, see the Dell Storage Center Best Practices document located on the Dell TechCenter (<http://en.community.dell.com/techcenter/storage/>).

Two Fibre Channel Fabrics with Dual 8 Gb 4-Port Storage Controllers

Use two Fibre Channel (FC) fabrics to prevent an unavailable port, switch, or storage controller from causing a loss of connectivity between host servers and a storage system with dual 8 Gb 4-port storage controllers.

About this task

In this configuration, there are two fault domains, two FC fabrics, and two FC switches. The storage controllers connect to each FC switch using two FC connections.

- If a physical port becomes unavailable, the virtual port moves to another physical port in the same fault domain on the same storage controller.
- If an FC switch becomes unavailable, the storage system is accessed from the switch in the other fault domain.
- If a storage controller becomes unavailable, the virtual ports on the offline storage controller move to the physical ports on the other storage controller.

Steps

1. Connect each server to both FC fabrics.
2. Connect fault domain 1 (shown in orange) to fabric 1.
 - Storage controller 1: port 1 to FC switch 1
 - Storage controller 1: port 3 to FC switch 1
 - Storage controller 2: port 1 to FC switch 1
 - Storage controller 2: port 3 to FC switch 1
3. Connect fault domain 2 (shown in blue) to fabric 2.
 - Storage controller 1: port 2 to FC switch 2
 - Storage controller 1: port 4 to FC switch 2
 - Storage controller 2: port 2 to FC switch 2
 - Storage controller 2: port 4 to FC switch 2

Example

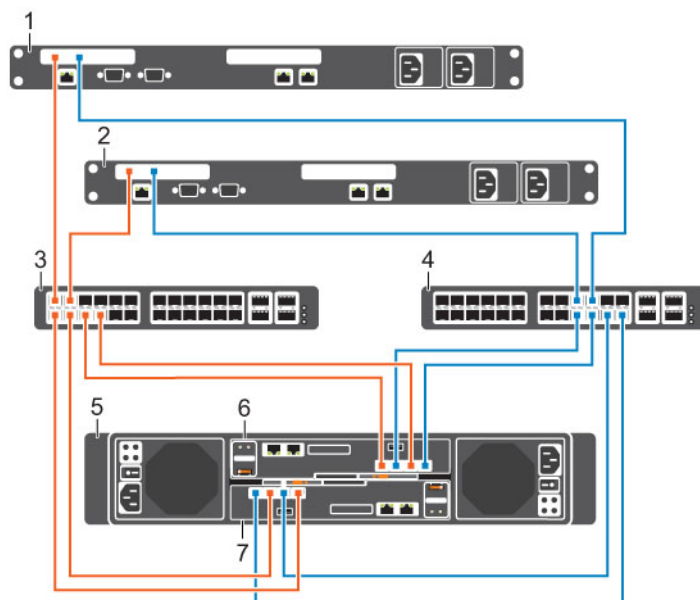



Figure 27. Storage System with Dual 8 Gb Storage Controllers and Two FC Switches

- | | |
|---------------------------------|---------------------------------|
| 1. Server 1 | 2. Server 2 |
| 3. FC switch 1 (Fault domain 1) | 4. FC switch 2 (Fault domain 2) |
| 5. Storage system | 6. Storage controller 1 |
| 7. Storage controller 2 | |

Next steps

Install or enable MPIO on the host servers.

-  **NOTE:** After the Storage Center configuration is complete, run the host access wizard to configure host server access and apply MPIO best practices. For the latest best practices, see the Dell Storage Center Best Practices document located on the Dell TechCenter (<http://en.community.dell.com/techcenter/storage/>).

One Fibre Channel Fabric with Dual 16 Gb 2–Port Storage Controllers

Use one Fibre Channel (FC) fabric to prevent an unavailable port or storage controller from causing a loss of connectivity between the host servers and a storage system with dual 16 Gb 2–port storage controllers.

About this task

In this configuration, there are two fault domains, one fabric, and one FC switch. Each storage controller connects to the FC switch using two FC connections.

- If a physical port becomes unavailable, the storage system is accessed from another port on the FC switch.
- If a storage controller becomes unavailable, the virtual ports on the offline storage controller move to physical ports on the other storage controller.

 **NOTE:** This configuration is vulnerable to switch unavailability, which results in a loss of connectivity between the host servers and storage system.

Steps

1. Connect each server to the FC fabric.
2. Connect fault domain 1 (shown in orange) to the fabric.
 - Storage controller 1: port 1 to the FC switch
 - Storage controller 2: port 1 to the FC switch
3. Connect fault domain 2 (shown in blue) to the fabric.
 - Storage controller 1: port 2 to the FC switch
 - Storage controller 2: port 2 to the FC switch

Example

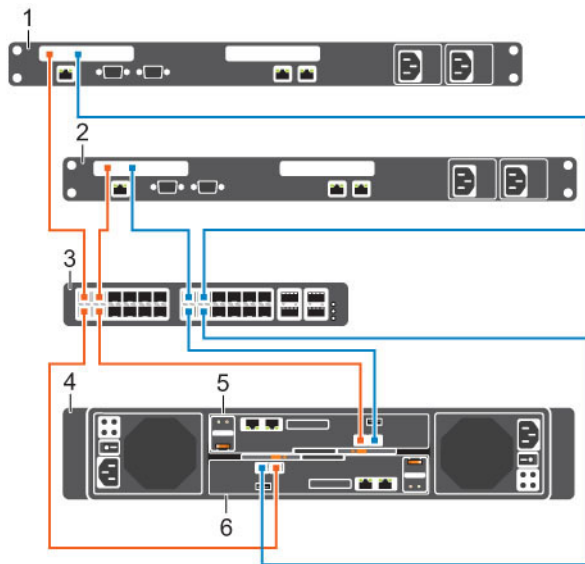



Figure 28. Storage System with Dual 16 Gb Storage Controllers and One FC Switch

- | | |
|--|-------------------------|
| 1. Server 1 | 2. Server 2 |
| 3. FC switch (Fault domain 1 and fault domain 2) | 4. Storage system |
| 5. Storage controller 1 | 6. Storage controller 2 |

Next steps

Install or enable MPIO on the host servers.

-  **NOTE:** After the Storage Center configuration is complete, run the host access wizard to configure host server access and apply MPIO best practices. For the latest best practices, see the Dell Storage Center Best Practices document located on the Dell TechCenter (<http://en.community.dell.com/techcenter/storage/>).

One Fibre Channel Fabric with Dual 8 Gb 4–Port Storage Controllers

Use one Fibre Channel (FC) fabric to prevent an unavailable port or storage controller from causing a loss of connectivity between the host servers a storage system with dual 8 Gb 4–portstorage controllers.

About this task

In this configuration, there are two fault domains, one fabric, and one FC switch. Each storage controller connects to the FC switch using four FC connections.

- If a physical port becomes unavailable, the virtual port moves to another physical port in the same fault domain on the same storage controller.
- If a storage controller becomes unavailable, the virtual ports on the offline storage controller move to the physical ports on the other storage controller.

-  **NOTE:** This configuration is vulnerable to switch unavailability, which results in a loss of connectivity between the host servers and storage system.

Steps

1. Connect each server to the FC fabric.
2. Connect fault domain 1 (shown in orange) to the fabric.
 - Storage controller 1: port 1 to the FC switch
 - Storage controller 1: port 3 to the FC switch
 - Storage controller 2: port 1 to the FC switch
 - Storage controller 2: port 3 to the FC switch
3. Connect fault domain 2 (shown in blue) to the fabric.
 - Storage controller 1: port 2 to the FC switch
 - Storage controller 1: port 4 to the FC switch
 - Storage controller 2: port 2 to the FC switch
 - Storage controller 2: port 4 to the FC switch

Example

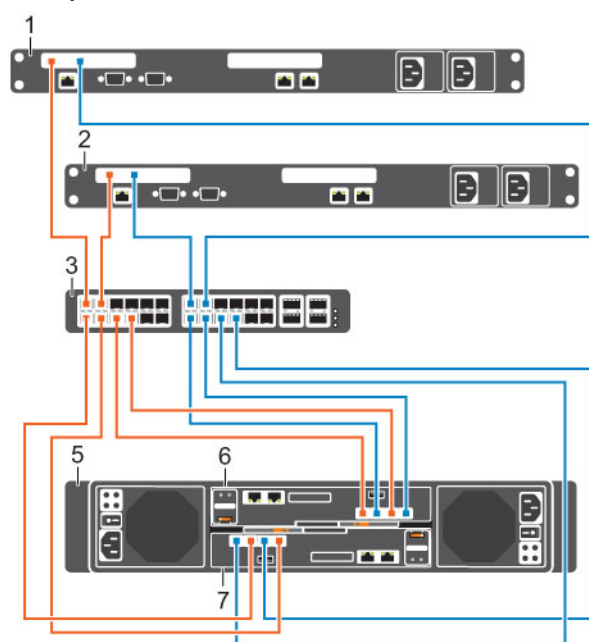

Figure 29. Storage System with Dual 8 Gb Storage Controllers and One FC Switch

- | | |
|--|-------------------------|
| 1. Server 1 | 2. Server 2 |
| 3. FC switch (Fault domain 1 and fault domain 2) | 4. Storage system |
| 5. Storage controller 1 | 6. Storage controller 2 |

Next steps

Install or enable MPIO on the host servers.

NOTE: After the Storage Center configuration is complete, run the host access wizard to configure host server access and apply MPIO best practices. For the latest best practices, see the Dell Storage Center Best Practices document located on the Dell TechCenter (<http://en.community.dell.com/techcenter/storage/>).

Two Fibre Channel Fabrics with a Single 16 Gb 2-Port Storage Controller

Use two Fibre Channel (FC) fabrics to prevent an unavailable port or switch from causing a loss of connectivity between the host servers and a storage system with a single 16 Gb 4-port storage controller.

About this task

In this configuration, there are two fault domains, two FC fabrics, and two FC switches. The storage controller connects to each FC switch using one FC connection.

If a physical port or FC switch becomes unavailable, the storage system is accessed from the switch in the other fault domain.

NOTE: This configuration is vulnerable to storage controller unavailability, which results in a loss of connectivity between the host servers and storage system.

Steps

1. Connect each server to the FC fabric.
2. Connect fault domain 1 (shown in orange) to the fabric 1.

- Storage controller: port 1 to FC switch 1.
3. Connect fault domain 2 (shown in blue) to the fabric 2.
Storage controller: port 2 to FC switch 2.

Example

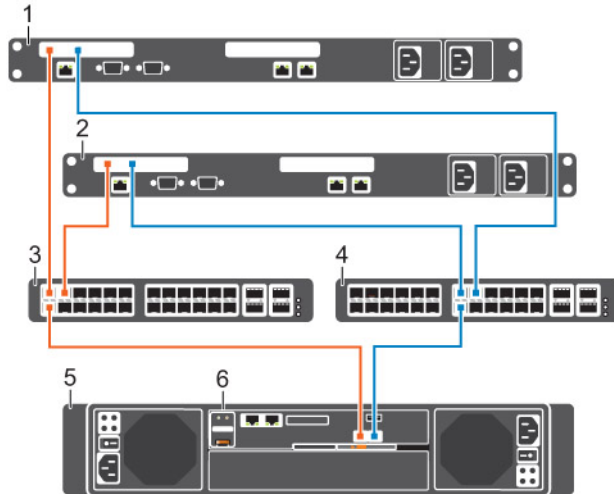

Figure 30. Storage System a Single 16 Gb Storage Controller and Two FC Switches

- | | |
|---------------------------------|---------------------------------|
| 1. Server 1 | 2. Server 2 |
| 3. FC switch 1 (Fault domain 1) | 4. FC switch 2 (Fault domain 2) |
| 5. Storage system | 6. Storage controller |

Next steps

Install or enable MPIO on the host servers.

NOTE: After the Storage Center configuration is complete, run the host access wizard to configure host server access and apply MPIO best practices. For the latest best practices, see the Dell Storage Center Best Practices document located on the Dell TechCenter (<http://en.community.dell.com/techcenter/storage/>).

Two Fibre Channel Fabrics with a Single 8 Gb 4–Port Storage Controller

Use two Fibre Channel (FC) fabrics to prevent an unavailable port or switch from causing a loss of connectivity between the host servers and a storage system with a single 8 Gb 4–port storage controller.

About this task

In this configuration, there are two fault domains, two FC fabrics, and two FC switches. The storage controller connects to each FC switch using two FC connections.

- If a physical port becomes unavailable, the virtual port moves to another physical port in the same fault domain on the storage controller.
- If an FC switch becomes unavailable, the storage system is accessed from the switch in the other fault domain.

NOTE: This configuration is vulnerable to storage controller unavailability, which results in a loss of connectivity between the host servers and storage system.

Steps

1. Connect each server to both FC fabrics.
2. Connect fault domain 1 (shown in orange) to fabric 1.
 - Storage controller 1: port 1 → FC switch 1
 - Storage controller 1: port 3 → FC switch 1
3. Connect fault domain 2 (shown in blue) to fabric 2.
 - Storage controller 1: port 2 → FC switch 2
 - Storage controller 1: port 4 → FC switch 2

Example

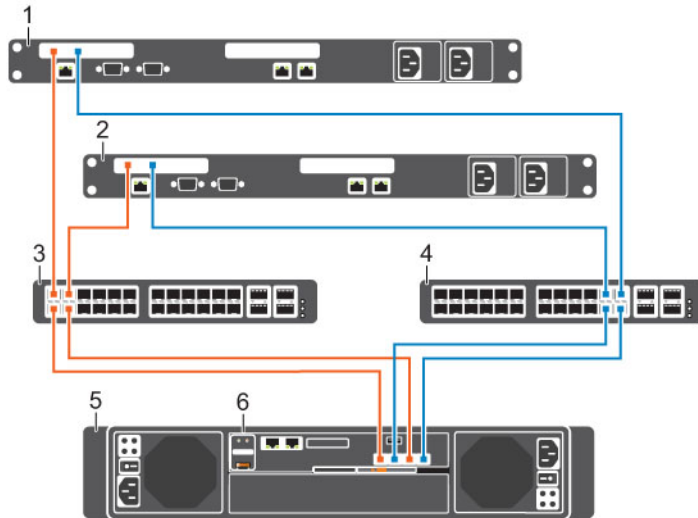



Figure 31. Storage System a Single 8 Gb Storage Controller and Two FC Switches

- | | |
|---------------------------------|---------------------------------|
| 1. Server 1 | 2. Server 2 |
| 3. FC switch 1 (Fault domain 1) | 4. FC switch 2 (Fault domain 2) |
| 5. Storage system | 6. Storage controller 1 |

Next steps

Install or enable MPIO on the host servers.

-  **NOTE:** After the Storage Center configuration is complete, run the host access wizard to configure host server access and apply MPIO best practices. For the latest best practices, see the Dell Storage Center Best Practices document located on the Dell TechCenter (<http://en.community.dell.com/techcenter/storage/>).

Using SFP+ Transceiver Modules

An SCv2000/SCv2020 storage system with 16 Gb Fibre Channel storage controllers comes with short range small-form-factor pluggable (SFP+) transceiver modules.

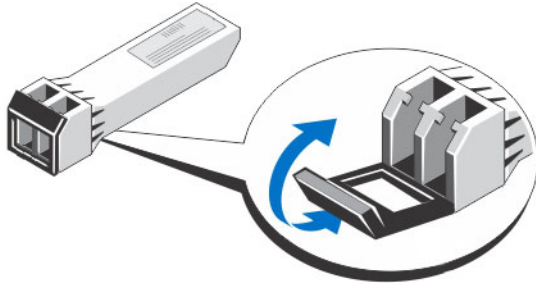

Figure 32. SFP+ Transceiver Module with a Bail Clasp Latch

The SFP+ transceiver modules are installed into the ports of the SCv2000/SCv2020 storage controller. Fiber-optic cables are connected from the SFP+ transceiver modules in the SCv2000/SCv2020 to SFP+ transceiver modules in Fibre Channel switches.

Guidelines for Using SFP+ Transceiver Modules

The SCv2000/SCv2020 storage system supports the use of SFP+ transceiver modules for 16 Gb FC connectivity.

Before installing SFP+ transceiver modules and fiber-optic cables, read the following guidelines:

⚠ CAUTION: When handling static-sensitive devices, take precautions to avoid damaging the product from static electricity.

- Use only Dell supported SFP+ transceiver modules with the SCv2000/SCv2020. Other generic SFP+ transceiver modules are not supported and may not work with the SCv2000/SCv2020.
- The SFP+ transceiver module housing has an integral guide key that is designed to prevent you from inserting the transceiver module incorrectly.
- Use minimal pressure when inserting an SFP+ transceiver module into an FC port. Forcing the SFP+ transceiver module into a port may damage the transceiver module or the port.
- The SFP+ transceiver module must be installed into a port before you connect the fiber-optic cable.
- The fiber-optic cable must be removed from the SFP+ transceiver module before you remove the transceiver module from the port.

Install an SFP+ Transceiver Module

Complete the following steps to install an SFP+ transceiver module in a 16 Gb FC storage controller.

About this task

Read the following cautions and information before installing an SFP+ transceiver module.

⚠ WARNING: To reduce the risk of injury from laser radiation or damage to the equipment, observe the following precautions:

- Do not open any panels, operate controls, make adjustments, or perform procedures to a laser device other than those specified herein.
- Do not stare into the laser beam.

⚠ CAUTION: Transceiver modules can be damaged by electrostatic discharge (ESD). To prevent ESD damage to the transceiver module, take the following precautions:

- Wear an antistatic discharge strap while handling transceiver modules.
- Place transceiver modules in antistatic packing material when transporting or storing them.

Steps

1. Position the transceiver module so that the key is oriented correctly to the port in the storage controller.

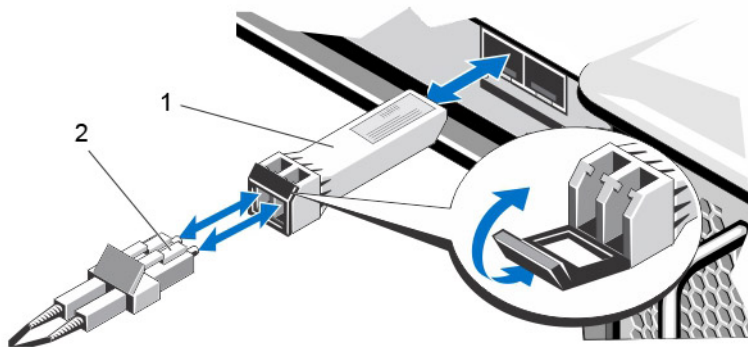

Figure 33. Install the SFP+ Transceiver Module

1. SFP+ transceiver module
2. Fiber-optic cable connector

2. Insert the transceiver module into the port until it is firmly seated and the latching mechanism clicks. The transceiver modules are keyed so that they can only be inserted with the correct orientation. If a transceiver module does not slide in easily, ensure that it is correctly oriented.

⚠ CAUTION: To reduce the risk of damage to the equipment, do not use excessive force when inserting the transceiver module.

3. Position fiber-optic cable so that the key (the ridge on one side of the cable connector) is aligned with the slot in the transceiver module.

⚠ CAUTION: Touching the end of a fiber-optic cable damages the cable. Whenever a fiber-optic cable is not connected, replace the protective covers on the ends of the cable.

4. Insert the fiber-optic cable into the transceiver module until the latching mechanism clicks.
5. Insert the other end of the fiber-optic cable into the SFP+ transceiver module of a Fibre Channel switch.

Remove an SFP+ Transceiver Module

Complete the following steps to remove an SFP+ transceiver module from a 16 Gb FC storage controller.

Prerequisites

Use failover testing to make sure that the connection between host servers and Storage Center remains up if the port is disconnected.

About this task

Read the following cautions and information before beginning removal or replacement procedures.

⚠ WARNING: To reduce the risk of injury from laser radiation or damage to the equipment, observe the following precautions:

- Do not open any panels, operate controls, make adjustments, or perform procedures to a laser device other than those specified herein.
- Do not stare into the laser beam.

⚠ CAUTION: Transceiver modules can be damaged by electrostatic discharge (ESD). To prevent ESD damage to the transceiver module, take the following precautions:

- Wear an antistatic discharge strap while handling modules.
- Place modules in antistatic packing material when transporting or storing them.

Steps

1. Remove the fiber-optic cable that is inserted into the transceiver.
 - a. Make certain the fiber-optic cable is labeled before removing it.
 - b. Press the release clip on the bottom of the cable connector to remove the fiber-optic cable from the transceiver.

⚠ CAUTION: Touching the end of a fiber-optic cable damages the cable. Whenever a fiber-optic cable is not connected, replace the protective covers on the ends of the cables.

2. Open the transceiver module latching mechanism.
3. Grasp the bail clasp latch on the transceiver module and pull the latch out and down to eject the transceiver module from the socket.
4. Slide the transceiver module out of the port.

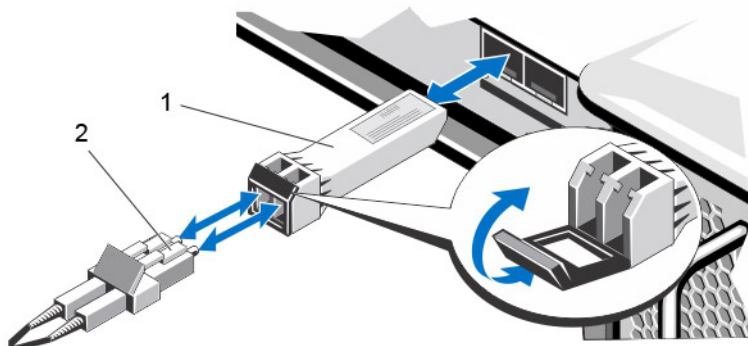

Figure 34. Remove the SFP+ Transceiver Module

1. SFP+ transceiver module

2. Fiber-optic cable connector

Fibre Channel Zoning

When using Fibre Channel for front-end connectivity, zones must be established to ensure that storage is visible to the servers. Use the zoning concepts discussed in this section to plan the front-end connectivity before starting to cable the storage system.

Zoning can be applied to either the ports on switches or to the World Wide Names (WWNs) of the end devices.

Dell recommends creating zones using a single initiator host port and multiple Storage Center ports.

WWN Zoning Guidelines

When WWN zoning is configured, a device may reside on any port or change physical ports and still be visible because the switch is seeking a WWN.

List of guidelines for WWN zoning.

- Include all Storage Center virtual WWNs in a single zone.
- Include all Storage Center physical WWNs in a single zone.
- For each host server HBA port, create a zone that includes the single HBA WWN and multiple Storage Center virtual WWNs on the same switch.
- For Fibre Channel replication:
 - Include all Storage Center physical WWNs from Storage Center system A and Storage Center system B in a single zone.
 - Include all Storage Center physical WWNs of Storage Center system A and the virtual WWNs of Storage Center system B on the particular fabric.
 - Include all Storage Center physical WWNs of Storage Center system B and the virtual WWNs of Storage Center system A on the particular fabric.

 **NOTE:** Some ports may not be used or dedicated for replication, however ports that are used must be in these zones.

Port Zoning Guidelines

When port zoning is configured, only specific switch ports are visible. If a storage device is moved to a different switch port that is not part of the zone, it is no longer visible to the other ports in the zone.

List of port zoning guidelines.

- Include all Storage Center front-end ports.
- For each host server port, create a zone that includes a single server HBA port and all Storage Center ports.
- Create server zones which contain all Storage Center front-end ports and a single server port.
- For Fibre Channel replication, include all Storage Center front-end ports from Storage Center system A and Storage Center system B in a single zone.

Labeling the Front-End Cables

Label the front-end cables to indicate the storage controller and port to which they are connected.

Prerequisites

Locate the pre-made front-end cable labels that shipped with the storage system.

About this task

Apply cable labels to both ends of each cable that connects a storage controller to a front-end fabric or network, or directly to host servers.

Steps

1. Starting with the top edge of the label, attach the label to the cable near the connector.

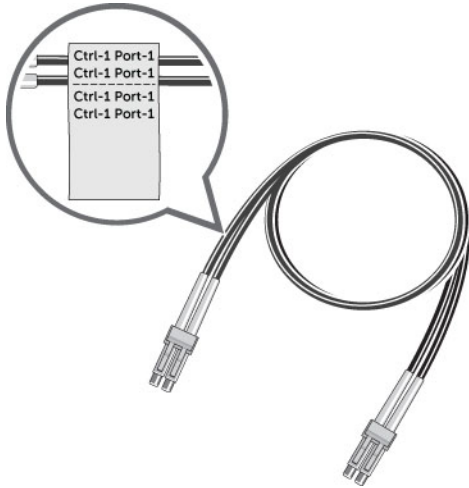

Figure 35. Attach Label to Cable

2. Wrap the label around the cable until it fully encircles the cable. The bottom of each label is clear so that it does not obscure the text.



Figure 36. Wrap Label Around Cable

3. Apply a matching label to the other end of the cable.





Connecting to iSCSI Host Servers

Choose the iSCSI connectivity option that best suits the front-end redundancy requirements and network infrastructure.

Preparing Host Servers

Install the iSCSI host bus adapters (HBAs) or iSCSI network adapters, install the drivers, and make sure that the latest supported firmware is installed.

 **NOTE:** Refer to the *Dell Storage Compatibility Matrix* for a list of supported iSCSI HBAs and network adapters.

- If the host server is a Windows or Linux host:
 - a. Install the iSCSI HBAs or network adapters dedicated for iSCSI traffic in the host servers.
 -  **NOTE:** Do not install iSCSI HBAs or network adapters from different vendors in the same server.
 - b. Install supported drivers for the HBAs or network adapters and make sure that the HBAs or network adapter have the latest supported firmware
 - c. Use the host operating system to assign IP addresses for each iSCSI port. The IP addresses must match the subnets for each fault domain.
 -  **CAUTION: Correctly assign IP addresses to the HBAs or network adapters. Assigning IP addresses to the wrong ports can cause connectivity issues.**
 -  **NOTE:** If using jumbo frames, they must be enabled and configured on all devices in the data path, adapter ports, switches, and storage system.
 - d. Use the iSCSI cabling diagrams to cable the host servers to the switches. Connecting host servers directly to the storage system without using Ethernet switches is not supported.
- If the host server is a vSphere host:
 - a. Install the iSCSI HBAs or network adapters dedicated for iSCSI traffic in the host servers.
 - b. Install supported drivers for the HBAs or network adapters and make sure that the HBAs or network adapter have the latest supported firmware
 - c. If the host uses network adapters for iSCSI traffic, create a VMkernel port for each network adapter. (1 VMkernel per vSwitch)
 - d. Use the host operating system to assign IP addresses for each iSCSI port. The IP addresses must match the subnets for each fault domain..
 -  **CAUTION: Correctly assign IP addresses to the HBAs or network adapters. Assigning IP addresses to the wrong ports can cause connectivity issues.**
 -  **NOTE:** If using jumbo frames, they must be enabled and configured on all devices in the data path, adapter ports, switches, and storage system.
 - e. If the host uses network adapters for iSCSI traffic, add the VMkernel ports to the iSCSI software initiator.
 - f. Use the iSCSI cabling diagrams to cable the host servers to the switches. Connecting host servers directly to the storage system without using Ethernet switches is not supported.

Two iSCSI Networks with Dual 10 GbE 2–Port Storage Controllers

Use two iSCSI networks to prevent an unavailable port, switch, or storage controller from causing a loss of connectivity between the host servers and a storage system with dual 10 GbE 2–port storage controllers.

About this task

In this configuration, there are two fault domains, two iSCSI networks, and two Ethernet switches. The storage controllers connect to each Ethernet switch using one iSCSI connection.

- If a physical port or Ethernet switch becomes unavailable, the storage system is accessed from the switch in the other fault domain.
- If a storage controller becomes unavailable, the virtual ports on the offline storage controller move to the physical ports on the other storage controller.

Steps

1. Connect each server to both iSCSI networks.
2. Connect fault domain 1 (shown in orange) to iSCSI network 1.
 - Storage controller 1: port 1 to Ethernet switch 1

- Storage controller 2: port 1 to Ethernet switch 1
3. Connect fault domain 2 (shown in blue) to iSCSI network 2.
 - Storage controller 1: port 2 to Ethernet switch 2
 - Storage controller 2: port 2 to Ethernet switch 2

Example

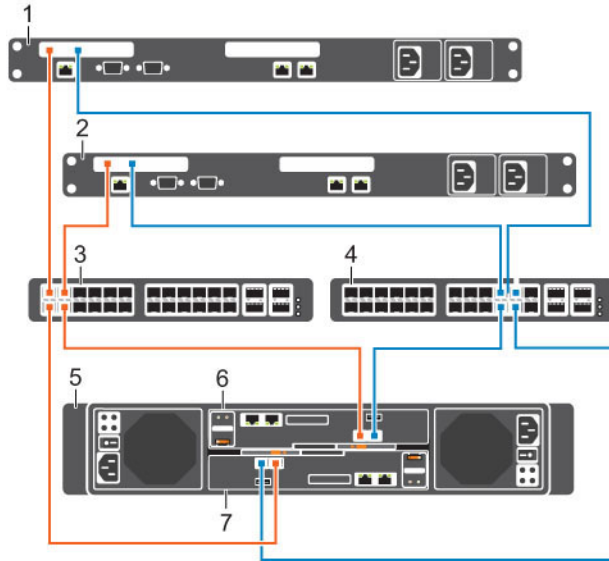

Figure 37. Storage System with Dual 10 GbE Storage Controllers and Two Ethernet Switches

- | | |
|---------------------------------------|---------------------------------------|
| 1. Server 1 | 2. Server 2 |
| 3. Ethernet switch 1 (Fault domain 1) | 4. Ethernet switch 2 (Fault domain 2) |
| 5. Storage system | 6. Storage controller 1 |
| 7. Storage controller 2 | |

Next steps

Install or enable MPIO on the host servers.

NOTE: After the Storage Center configuration is complete, run the host access wizard to configure host server access and apply MPIO best practices. For the latest best practices, see the Dell Storage Center Best Practices document located on the Dell TechCenter (<http://en.community.dell.com/techcenter/storage/>).

Two iSCSI Networks with Dual 1 GbE 4-Port Storage Controllers

Use two iSCSI networks to prevent an unavailable port, switch, or storage controller from causing a loss of connectivity between the host servers and a storage system with dual 1 GbE 4-port storage controllers.

About this task

In this configuration, there are two fault domains, two iSCSI networks, and two Ethernet switches. The storage controllers connect to each Ethernet switch using two iSCSI connections.

- If a physical port becomes unavailable, the virtual port moves to another physical port in the same fault domain on the same storage controller.
- If an Ethernet switch becomes unavailable, the storage system is accessed from the switch in the other fault domain.

- If a storage controller becomes unavailable, the virtual ports on the offline storage controller move to physical ports on the other storage controller.

Steps

1. Connect each server to both iSCSI networks.
2. Connect fault domain 1 (shown in orange) to iSCSI network 1.
 - Storage controller 1: port 1 to Ethernet switch 1
 - Storage controller 2: port 1 to Ethernet switch 1
 - Storage controller 1: port 3 to Ethernet switch 1
 - Storage controller 2: port 3 to Ethernet switch 1
3. Connect fault domain 2 (shown in blue) to iSCSI network 2.
 - Storage controller 1: port 2 to Ethernet switch 2
 - Storage controller 2: port 2 to Ethernet switch 2
 - Storage controller 1: port 4 to Ethernet switch 2
 - Storage controller 2: port 4 to Ethernet switch 2

Example

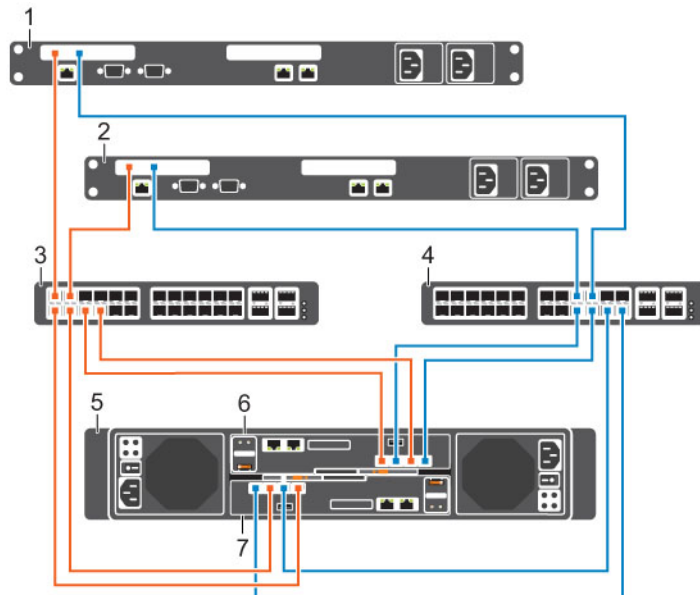

Figure 38. Storage System with Dual 1 GbE Storage Controllers and Two Ethernet Switches

- | | |
|---------------------------------------|---------------------------------------|
| 1. Server 1 | 2. Server 2 |
| 3. Ethernet switch 1 (Fault domain 1) | 4. Ethernet switch 2 (Fault domain 2) |
| 5. Storage system | 6. Storage controller 1 |
| 7. Storage controller 2 | |

Next steps

Install or enable MPIO on the host servers.

- NOTE:** After the Storage Center configuration is complete, run the host access wizard to configure host server access and apply MPIO best practices. For the latest best practices, see the Dell Storage Center Best Practices document located on the Dell TechCenter (<http://en.community.dell.com/techcenter/storage/>).

One iSCSI Network with Dual 10 GbE 2–Port Storage Controllers

Use one iSCSI network to prevent an unavailable port or storage controller from causing a loss of connectivity between the host servers and a storage system with dual 10 GbE 2–Port storage controllers .

About this task

In this configuration, there are two fault domains, one iSCSI network, and one Ethernet switch. Each storage controller connects to the Ethernet switch using two iSCSI connections.

- If a physical port becomes unavailable, the storage system is accessed from another port on the Ethernet switch.
- If a storage controller becomes unavailable, the virtual ports on the offline storage controller move to the physical ports on the other storage controller.

 **NOTE:** This configuration is vulnerable to switch unavailability, which results in a loss of connectivity between the host servers and storage system.

Steps

1. Connect each server to the iSCSI network.
2. Connect fault domain 1 (shown in orange) to the iSCSI network.
 - Storage controller 1: port 1 to the Ethernet switch
 - Storage controller 2: port 1 to the Ethernet switch
3. Connect fault domain 2 (shown in blue) to the iSCSI network.
 - Storage controller 1: port 2 to the Ethernet switch
 - Storage controller 2: port 2 to the Ethernet switch

Example

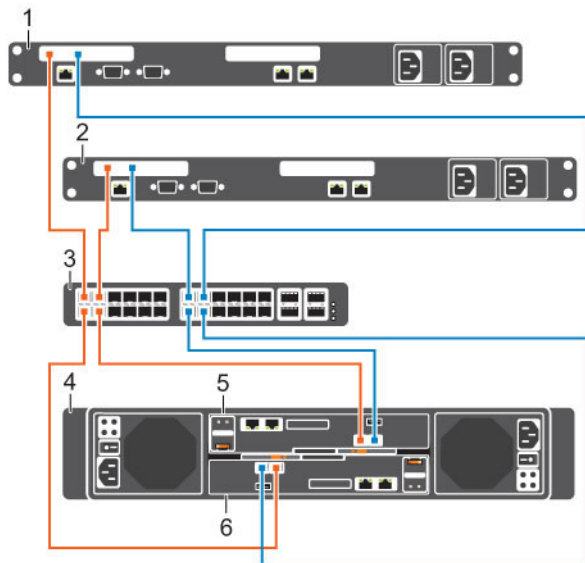



Figure 39. Storage System with Dual 10 GbE Storage Controllers and One Ethernet Switch

- | | |
|--|-------------------------|
| 1. Server 1 | 2. Server 2 |
| 3. Ethernet switch (Fault domain 1 and fault domain 2) | 4. Storage system |
| 5. Storage controller 1 | 6. Storage controller 2 |

Next steps

Install or enable MPIO on the host servers.

 **NOTE:** After the Storage Center configuration is complete, run the host access wizard to configure host server access and apply MPIO best practices. For the latest best practices, see the Dell Storage Center Best Practices document located on the Dell TechCenter (<http://en.community.dell.com/techcenter/storage/>).

One iSCSI Network with Dual 1 GbE 4–Port Storage Controllers

Use one iSCSI network to prevent an unavailable port or storage controller from causing a loss of connectivity between the host servers and a storage system with dual 1 GbE 4–port storage controllers.

About this task

In this configuration, there are two fault domains, one iSCSI network, and one Ethernet switch. Each storage controller connects to the Ethernet switch using four iSCSI connections.

- If a physical port becomes unavailable, the virtual port moves to another physical port in the same fault domain on the same storage controller.
- If a storage controller becomes unavailable, the virtual ports on the offline storage controller move to the physical ports on the other storage controller.

 **NOTE:** This configuration is vulnerable to switch unavailability, which results in a loss of connectivity between the host servers and storage system.

Steps

1. Connect each server to the iSCSI network.
2. Connect fault domain 1 (shown in orange) to the iSCSI network.
 - Storage controller 1: port 1 to the Ethernet switch
 - Storage controller 1: port 3 to the Ethernet switch
 - Storage controller 2: port 1 to the Ethernet switch
 - Storage controller 2: port 3 to the Ethernet switch
3. Connect fault domain 2 (shown in blue) to the iSCSI network.
 - Storage controller 1: port 2 to the Ethernet switch
 - Storage controller 1: port 4 to the Ethernet switch
 - Storage controller 2: port 2 to the Ethernet switch
 - Storage controller 2: port 4 to the Ethernet switch

Example

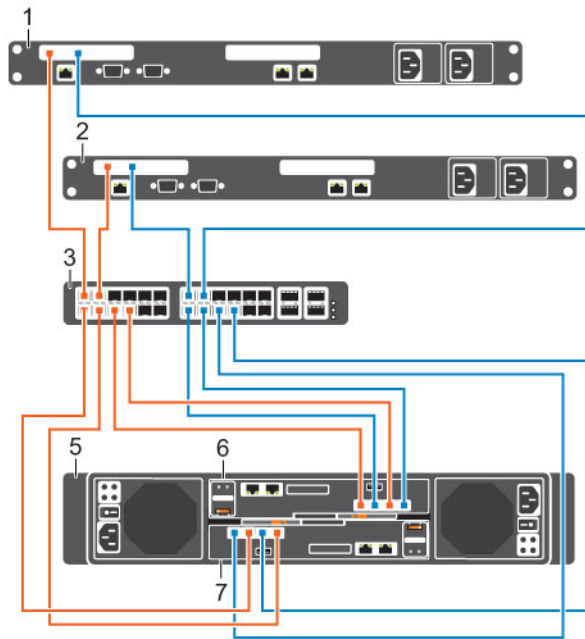

Figure 40. Storage System with Dual 1 GbE Storage Controllers and One Ethernet Switch

- | | |
|--|-------------------------|
| 1. Server 1 | 2. Server 2 |
| 3. Ethernet switch (Fault domain 1 and fault domain 2) | 4. Storage system |
| 5. Storage controller 1 | 6. Storage controller 2 |

Next steps

Install or enable MPIO on the host servers.

NOTE: After the Storage Center configuration is complete, run the host access wizard to configure host server access and apply MPIO best practices. For the latest best practices, see the Dell Storage Center Best Practices document located on the Dell TechCenter (<http://en.community.dell.com/techcenter/storage/>).

Two iSCSI Networks with a Single 10 GbE 2-Port Storage Controller

Use two iSCSI networks to prevent an unavailable port or switch from causing a loss of connectivity between the host servers and a storage system with a single 10 GbE 2-port storage controller.

About this task

In this configuration, there are two fault domains, two iSCSI networks, and two Ethernet switches. The storage controller connects to the Ethernet switches using two iSCSI connections.

If a physical port or Ethernet switch becomes unavailable, the storage system is accessed from the switch in the other fault domain.

NOTE: This configuration is vulnerable to storage controller unavailability, which results in a loss of connectivity between the host servers and storage system.

Steps

1. Connect each server to the iSCSI network.
2. Connect the fault domain 1 (shown in orange) to iSCSI network 1.

- Storage controller: port 1 to Ethernet switch 1
3. Connect the fault domain 2 (shown in orange) to iSCSI network 2.
Storage controller: port 2 to Ethernet switch 2

Example

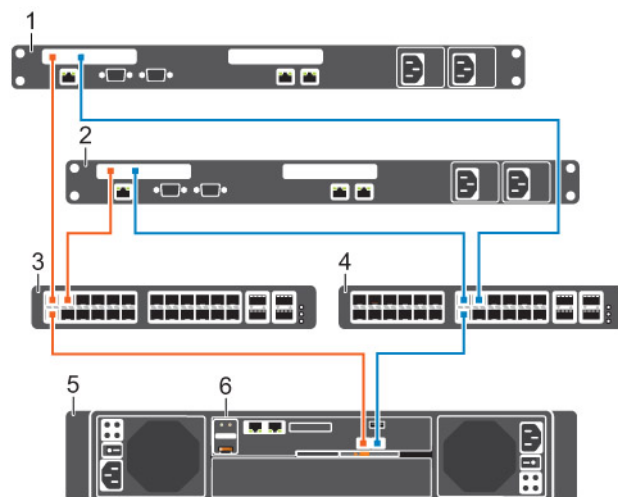

Figure 41. Storage System with One 10 GbE Storage Controller and Two Ethernet Switches

- | | |
|---------------------------------------|---------------------------------------|
| 1. Server 1 | 2. Server 2 |
| 3. Ethernet switch 1 (Fault domain 1) | 4. Ethernet switch 2 (Fault domain 2) |
| 5. Storage system | 6. Storage controller |

Next steps

Install or enable MPIO on the host servers.

NOTE: After the Storage Center configuration is complete, run the host access wizard to configure host server access and apply MPIO best practices. For the latest best practices, see the Dell Storage Center Best Practices document located on the Dell TechCenter (<http://en.community.dell.com/techcenter/storage/>).

Two iSCSI Networks with a Single 1 GbE 4–Port Storage Controller

Use two iSCSI networks to prevent an unavailable port or switch from causing a loss of connectivity between the host servers and a storage system with a single 1 GbE 4–port storage controller.

About this task

In this configuration, there are two fault domains, two iSCSI networks, and two Ethernet switches. The storage controller connects to each Ethernet switch using two iSCSI connections.

- If a physical port becomes unavailable, the virtual port moves to another physical port in the same fault domain on the storage controller.
- If an Ethernet switch becomes unavailable, the storage system is accessed from the switch in the other fault domain.

NOTE: This configuration is vulnerable to storage controller unavailability, which results in a loss of connectivity between the host servers and storage system.

Steps

1. Connect each server to both iSCSI networks.
2. Connect fault domain 1 (shown in orange) to iSCSI network 1.
 - Storage controller 1: port 1 to Ethernet switch 1
 - Storage controller 1: port 3 to Ethernet switch 1
3. Connect fault domain 2 (shown in blue) to iSCSI network 2.
 - Storage controller 1: port 2 to Ethernet switch 2
 - Storage controller 1: port 4 to Ethernet switch 2

Example

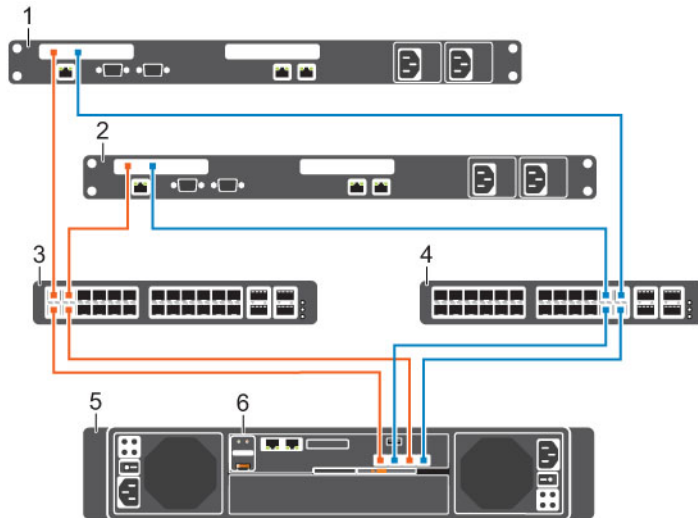

Figure 42. Storage System with One 1 GbE Storage Controller and Two Ethernet Switches

- | | |
|---------------------------------------|---------------------------------------|
| 1. Server 1 | 2. Server 2 |
| 3. Ethernet switch 1 (Fault domain 1) | 4. Ethernet switch 2 (Fault domain 2) |
| 5. Storage system | 6. Storage controller |

Next steps

Install or enable MPIO on the host servers.

NOTE: After the Storage Center configuration is complete, run the host access wizard to configure host server access and apply MPIO best practices. For the latest best practices, see the Dell Storage Center Best Practices document located on the Dell TechCenter (<http://en.community.dell.com/techcenter/storage/>).

Labeling the Front-End Cables

Label the front-end cables to indicate the storage controller and port to which they are connected.

Prerequisites

Locate the pre-made front-end cable labels that shipped with the storage system.

About this task

Apply cable labels to both ends of each cable that connects a storage controller to a front-end fabric or network, or directly to host servers.

Steps

1. Starting with the top edge of the label, attach the label to the cable near the connector.



Figure 43. Attach Label to Cable

2. Wrap the label around the cable until it fully encircles the cable. The bottom of each label is clear so that it does not obscure the text



Figure 44. Wrap Label Around Cable

3. Apply a matching label to the other end of the cable.

Cabling Direct-Attached Host Servers

An SCv2000/SCv2020 storage system with SAS front-end ports connects directly to host servers.

Preparing Host Servers

On each host server, install the SAS host bus adapters (HBAs), install the drivers, and make sure that the latest supported firmware is installed.

About this task

 **NOTE:** Refer to the *Dell Storage Compatibility Matrix* for a list of supported SAS HBAs.

Steps

1. Install the SAS HBAs in the host servers.

 **NOTE:** Do not install SAS HBAs from different vendors in the same server.

2. Install supported drivers for the HBAs and make sure that the HBAs have the latest supported firmware installed.
3. Use the SAS cabling diagram to cable the host servers directly to the storage system.

 **NOTE:** If deploying vSphere hosts, configure only one host at a time.

SAS Virtual Port Mode

To provide redundancy in SAS virtual port mode, the front-end ports on each storage controller must be directly connected to the server.

In SAS virtual port mode, a volume is active on only one storage controller, but it is visible to both storage controllers. Asymmetric Logical Unit Access (ALUA) controls the path that a server uses to access a volume.

If a storage controller becomes unavailable, the volume becomes active on the other storage controller. The state of the paths on the available storage controller are set to Active/Optimized and the state of the paths on the other storage controller are set to Standby. When the storage controller becomes available again and the ports are rebalanced, the volume moves back to its preferred storage controller and the ALUA states are updated.

If a SAS path becomes unavailable, the Active/Optimized volumes on that path become active on the other storage controller. The state of the failed path for those volumes is set to Standby and the state of the active path for those volumes is set to Active/Optimized.

 **NOTE:** Failover in SAS virtual port mode occurs within a single fault domain. Therefore, a server must have both connections in the same fault domain. For example, if a server is connected to SAS port 2 on one storage controller, it must be connected to SAS port two on the other storage controller. If a server is not cabled correctly when a storage controller or SAS path becomes unavailable, access to the volume is lost.

Two Servers Connected to Dual 12 Gb 4–Port SAS Storage Controllers

A storage system with four 12 Gb front-end SAS ports on each storage controller can connect up to two host servers, if each host server has two SAS HBAs with dual SAS ports.

About this task

In this configuration, there are four fault domains spread across both storage controllers. The storage controllers are connected to each host server using four SAS connections.

If a storage controller becomes unavailable, all of the standby paths on the other storage controller become active.

Steps

1. Connect fault domain 1 (shown in orange) to the host server 1.
 - a. Connect a SAS cable from storage controller 1: port 1 to host server 1.
 - b. Connect a SAS cable from storage controller 2: port 1 to host server 1.
2. Connect fault domain 2 (shown in blue) to the host server 1.
 - a. Connect a SAS cable from storage controller 1: port 2 to host server 1.
 - b. Connect a SAS cable from storage controller 2: port 2 to host server 1.
3. Connect fault domain 3 (shown in gray) to the host server 2.
 - a. Connect a SAS cable from storage controller 1: port 3 to host server 2.

- b. Connect a SAS cable from storage controller 2: port 3 to host server 2.
4. Connect fault domain 4 (shown in red) to the host server 2.
 - a. Connect a SAS cable from storage controller 1: port 4 to host server 2.
 - b. Connect a SAS cable from storage controller 2: port 4 to host server 2.

Example

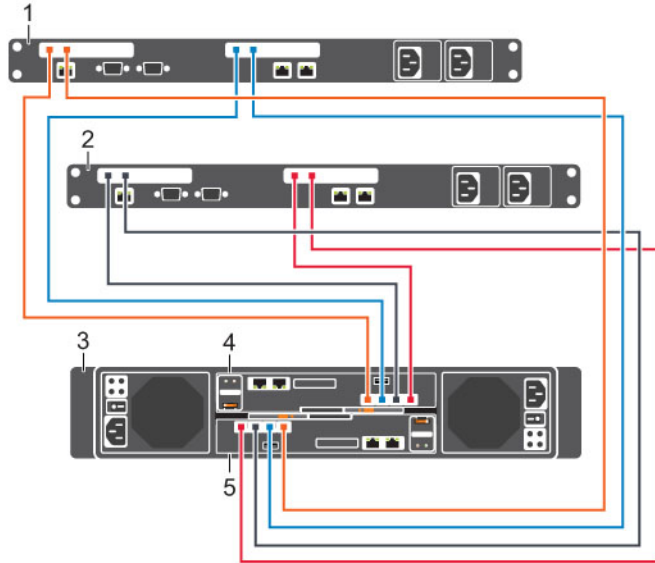

Figure 45. Storage System with Dual 12 Gb SAS Storage Controllers Connected to Two Host Servers

- | | |
|-------------------------|-------------------------|
| 1. Server 1 | 2. Server 2 |
| 3. Storage system | 4. Storage controller 1 |
| 5. Storage controller 2 | |

Next steps

Install or enable MPIO on the host servers.

NOTE: After the Storage Center configuration is complete, run the host access wizard to configure host server access and apply MPIO best practices. For the latest best practices, see the Dell Storage Center Best Practices document located on the Dell TechCenter (<http://en.community.dell.com/techcenter/storage/>).

Four Servers Connected to Dual 12 Gb 4–Port SAS Storage Controllers

A storage system with four 12 Gb front-end SAS ports on each storage controller can connect to up to four host servers, if each host server has one HBA with dual SAS ports.

About this task

In this configuration, four fault domains are spread across both storage controllers. The storage controllers are connected to each host server using two SAS connections.

If a storage controller becomes unavailable, all of the standby paths on the other storage controller become active.

Steps

1. Connect fault domain 1 (shown in orange) to the host server 1.

- a. Connect a SAS cable from storage controller 1: port 1 to host server 1.
- b. Connect a SAS cable from storage controller 2: port 1 to host server 1.
2. Connect fault domain 2 (shown in blue) to the host server 2.
 - a. Connect a SAS cable from storage controller 1: port 2 to host server 2.
 - b. Connect a SAS cable from storage controller 2: port 2 to host server 2.
3. Connect fault domain 3 (shown in gray) to the host server 3.
 - a. Connect a SAS cable from storage controller 1: port 3 to host server 3.
 - b. Connect a SAS cable from storage controller 2: port 3 to host server 3.
4. Connect fault domain 4 (shown in red) to the host server 4.
 - a. Connect a SAS cable from storage controller 1: port 4 to host server 4.
 - b. Connect a SAS cable from storage controller 2: port 4 to host server 4.

Example

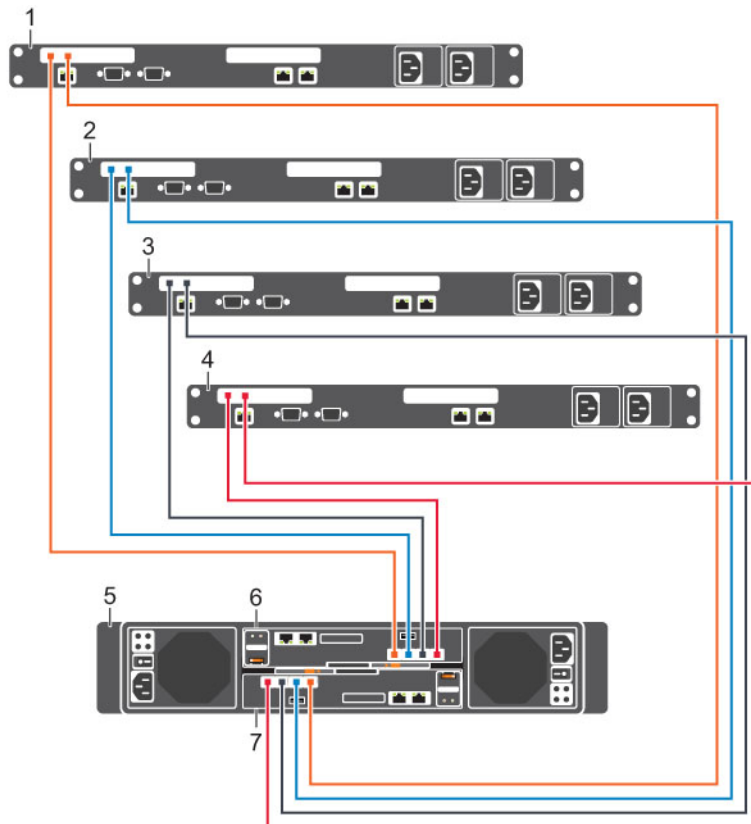

Figure 46. Storage System with Dual 12 Gb SAS Storage Controllers Connected to Four Host Servers

- | | |
|-------------------------|-------------------------|
| 1. Server 1 | 2. Server 2 |
| 3. Server 3 | 4. Server 4 |
| 5. Storage system | 6. Storage controller 1 |
| 7. Storage controller 2 | |

Next steps

Install or enable MPIO on the host servers.

NOTE: After the Storage Center configuration is complete, run the host access wizard to configure host server access and apply MPIO best practices. For the latest best practices, see the Dell Storage Center Best Practices document located on the Dell TechCenter (<http://en.community.dell.com/techcenter/storage/>).

Two Servers Connected to a Single 12 Gb 4-Port SAS Storage Controller

A storage system with four 12 Gb front-end SAS ports on a single storage controller can connect up to two host servers, if each host server has two SAS HBAs.

About this task

In this configuration, there are four fault domains and the storage controller is connected to each host server using two SAS connections.

NOTE: This configuration is vulnerable to storage controller unavailability, which results in a loss of connectivity between the host servers and storage system.

Steps

1. Connect fault domain 1 to the host server 1, by connecting a SAS cable from storage controller 1: port 1 to host server 1.
2. Connect fault domain 2 to the host server 1, by connecting a SAS cable from storage controller 1: port 2 to host server 1.
3. Connect fault domain 3 to the host server 2, by connecting a SAS cable from storage controller 1: port 3 to host server 2.
4. Connect fault domain 4 to the host server 2, by connecting a SAS cable from storage controller 1: port 4 to host server 2.

Example

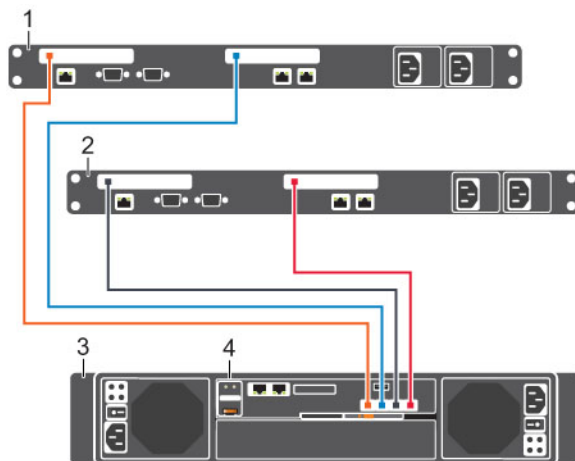

Figure 47. Storage System with One 12 Gb SAS Storage Controller Connected to Two Host Servers

- | | |
|-------------------|-----------------------|
| 1. Server 1 | 2. Server 2 |
| 3. Storage system | 4. Storage controller |

Next steps

Install or enable MPIO on the host servers.

NOTE: After the Storage Center configuration is complete, run the host access wizard to configure host server access and apply MPIO best practices. For the latest best practices, see the Dell Storage Center Best Practices document located on the Dell TechCenter (<http://en.community.dell.com/techcenter/storage/>).

Labeling the Front-End Cables

Label the front-end cables to indicate the storage controller and port to which they are connected.

Prerequisites

Locate the pre-made front-end cable labels that shipped with the storage system.

About this task

Apply cable labels to both ends of each cable that connects a storage controller to a front-end fabric or network, or directly to host servers.

Steps

1. Starting with the top edge of the label, attach the label to the cable near the connector.



Figure 48. Attach Label to Cable

2. Wrap the label around the cable until it fully encircles the cable. The bottom of each label is clear so that it does not obscure the text.



Figure 49. Wrap Label Around Cable

3. Apply a matching label to the other end of the cable.

Cabling the Ethernet Management Port

To manage Storage Center, the Ethernet management (MGMT) port of each storage controller must be connected to an Ethernet switch that is part of the management network.

About this task

The management port provides access to the storage system through the Dell Storage Client software and is used to send emails, alerts, SNMP traps, and SupportAssist diagnostic data. The management port also provides access to the baseboard management controller (BMC) software.

NOTE: If the Flex Port license is installed, the management port becomes a shared iSCSI port. To use the management port as an iSCSI port, it must be cabled to a network switch dedicated to iSCSI traffic. Special considerations must be taken into account when sharing the management port.

Steps

1. Connect the Ethernet management port on storage controller 1 to the Ethernet switch.
2. Connect the Ethernet management port on storage controller 2 to the Ethernet switch.

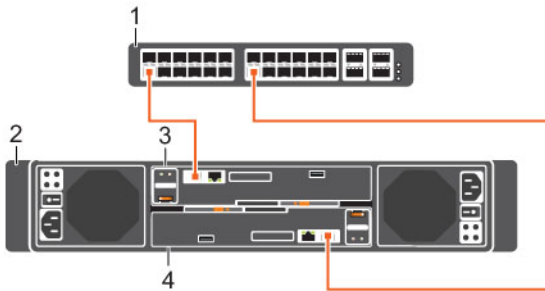

Figure 50. Storage System Connected to a Management Network

- | | |
|-------------------------|-------------------------|
| 1. Ethernet switch | 2. Storage system |
| 3. Storage controller 1 | 4. Storage controller 2 |

Labeling the Ethernet Management Cables

Label the Ethernet management cables that connect each storage controller to an Ethernet switch.

Prerequisites

Locate the pre-made Ethernet management cable labels that shipped with the SCv2000/SCv2020 storage system.

About this task

Apply cable labels to both ends of each Ethernet management cable.

Steps

1. Starting with the top edge of the label, attach the label to the cable near the connector.



Figure 51. Attach Label to Cable

2. Wrap the label around the cable until it fully encircles the cable. The bottom of each label is clear so that it does not obscure the text.



Figure 52. Wrap Label Around Cable

3. Apply a matching label to the other end of the cable.

Cabling the Embedded Ports for iSCSI Replication

If the Storage Center is licensed for replication, the replication port can be connected to an Ethernet switch and used for iSCSI replication. If the Storage Center is licensed for replication and the Flex Port license is installed, the management port and replication port can be connected to an Ethernet switch and used for iSCSI replication.

Cabling the Replication Port for iSCSI Replication

If replication is licensed, the replication (REPL) port can be used to replicate data to another Storage Center.

About this task

Connect the replication port of each storage controller to an Ethernet switch through which the Storage Center can perform iSCSI replication.

Steps

1. Connect the replication port on storage controller 1 to Ethernet switch 2.
2. Connect the replication port on storage controller 2 to Ethernet switch 2.

 **NOTE:** The management port on each storage controller is connected to an Ethernet switch on the management network.

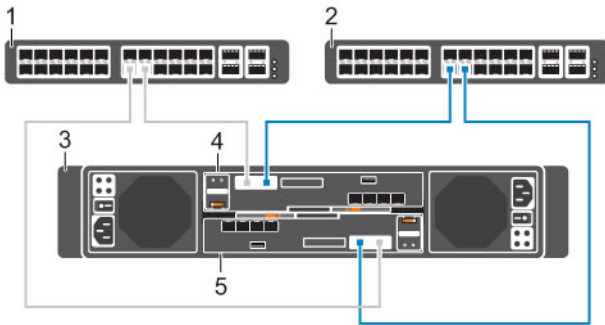

Figure 53. Replication Ports Connected to an iSCSI Network

1. Ethernet switch 1 (Management network)
 2. Ethernet switch 2 (iSCSI network)
 3. Storage system
 4. Storage controller 1
 5. Storage controller 2
3. To configure the fault domain and ports, click the **Configure Embedded iSCSI Ports** link on the **Configuration Complete** page of the **Discover and Configure Uninitialized SCv2000 Series Storage Centers** wizard.
 4. To configure replication, refer to the *Dell Enterprise Manager Administrator's Guide*.

Related Links

[Configure Embedded iSCSI Ports](#)

Cabling the Management Port and Replication Port for iSCSI Replication

If replication is licensed and the Flex Port license is installed, both the management (MGMT) and replication (REPL) ports can be used to replicate data to another Storage Center.

About this task

Connect the management port and replication port on each storage controller to an Ethernet switch through which the Storage Center can perform replication.

Steps

1. Connect Flex Port Domain 1 (shown in orange) to the iSCSI network.
 - a. Connect the management port on storage controller 1 to the Ethernet switch.
 - b. Connect the management port on storage controller 2 to the Ethernet switch.
2. Connect iSCSI Embedded Domain 2 (shown in blue) to the iSCSI network.
 - a. Connect the replication port on storage controller 1 to the Ethernet switch.
 - b. Connect the replication port on storage controller 2 to the Ethernet switch.

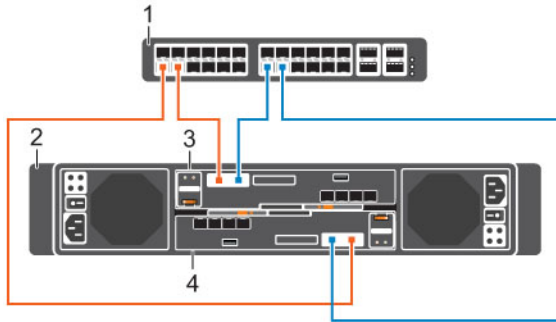

Figure 54. Management and Replication Ports Connected to an iSCSI Network

- | | |
|------------------------------------|-------------------------|
| 1. Ethernet switch (iSCSI network) | 2. Storage system |
| 3. Storage controller 1 | 4. Storage controller 2 |
- To configure the fault domains and ports, click the **Configure Embedded iSCSI Ports** link on the **Configuration Complete** page of the **Discover and Configure Uninitialized SCv2000 Series Storage Centers** wizard.
 - To configure replication, refer to the *Dell Enterprise Manager Administrator's Guide*.

Related Links

[Configure Embedded iSCSI Ports](#)

Cabling the Embedded Ports for iSCSI Host Connectivity

If the Flex Port license is installed on the Storage Center, the management port and replication port can be connected to an Ethernet switch and used for iSCSI host connectivity.

Two iSCSI Networks with Dual Storage Controllers and Embedded Ethernet Ports

Use two iSCSI networks to prevent an unavailable port, switch, or storage controller from causing a loss of connectivity between the host servers and a storage system with dual storage controllers.

About this task

In this configuration, there are two fault domains, two iSCSI networks, and two Ethernet switches. The storage controllers connect to each Ethernet switch using one iSCSI connection.

- If a physical port or Ethernet switch becomes unavailable, the storage system is accessed from the switch in the other fault domain.
- If a storage controller becomes unavailable, the virtual ports on the offline storage controller move to the physical ports on the other storage controller.

Steps

- Connect each server to both iSCSI networks.
- Connect embedded fault domain 1 (shown in orange) to iSCSI network 1.
 - Connect the management port on storage controller 1 to Ethernet switch 1.
 - Connect the management port on storage controller 2 to Ethernet switch 1.
- Connect embedded fault domain 2 (shown in blue) to iSCSI network 2.
 - Connect the replication port on storage controller 1 to Ethernet switch 2.
 - Connect the replication port on storage controller 2 to Ethernet switch 2.

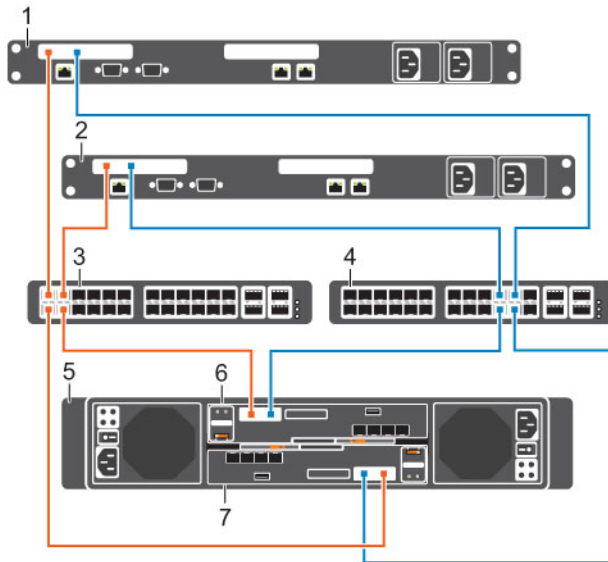

Figure 55. Storage System with Dual Storage Controllers and Two Ethernet Switches

- | | |
|---------------------------------------|---------------------------------------|
| 1. Server 1 | 2. Server 2 |
| 3. Ethernet switch 1 (Fault domain 1) | 4. Ethernet switch 2 (Fault domain 2) |
| 5. Storage system | 6. Storage controller 1 |
| 7. Storage controller 2 | |

- To configure the fault domains and ports, click the **Configure Embedded iSCSI Ports** link on the **Configuration Complete** page of the **Discover and Configure Uninitialized SCv2000 Series Storage Centers** wizard.

Next steps

Install or enable MPIO on the host servers.

NOTE: After the Storage Center configuration is complete, run the host access wizard to configure host server access and apply MPIO best practices. For the latest best practices, see the Dell Storage Center Best Practices documents located on the Dell TechCenter (<http://en.community.dell.com/techcenter/storage/>).

Related Links

[Configure Embedded iSCSI Ports](#)

One iSCSI Network with Dual Storage Controllers and Embedded Ethernet Ports

Use one iSCSI network to prevent an unavailable port or storage controller from causing a loss of connectivity between the host servers and a storage system with dual storage controllers .

About this task

In this configuration, there are two fault domains, one iSCSI network, and one Ethernet switch. Each storage controller connects to the Ethernet switch using two iSCSI connections.

- If a physical port becomes unavailable, the storage system is accessed from another port on the Ethernet switch.
- If a storage controller becomes unavailable, the virtual ports on the offline storage controller move to the physical ports on the other storage controller.

NOTE: This configuration is vulnerable to switch unavailability, which results in a loss of connectivity between the host servers and storage system.

Steps

1. Connect each server to the iSCSI network.
2. Connect embedded fault domain 1 (shown in orange) to the iSCSI network.
 - a. Connect the management port on storage controller 1 to the Ethernet switch
 - b. Connect the management port on storage controller 2 to the Ethernet switch
3. Connect embedded fault domain 2 (shown in blue) to the iSCSI network.
 - a. Connect the replication port on storage controller 1 to the Ethernet switch
 - b. Connect the replication port on storage controller 2 to the Ethernet switch

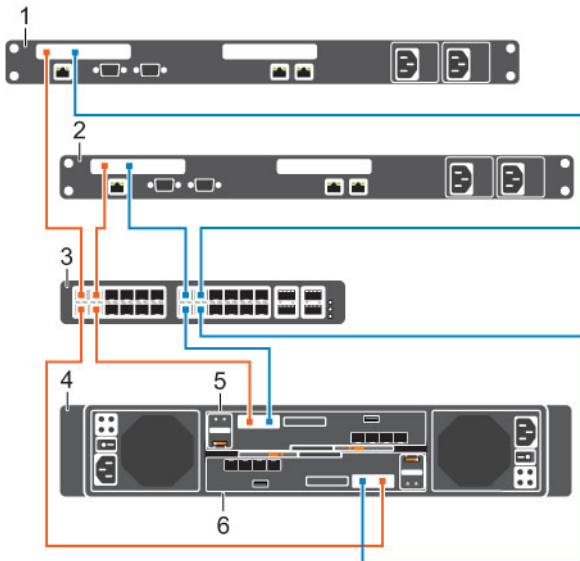

Figure 56. Storage System with Dual Storage Controllers and One Ethernet Switch

- | | |
|--|-------------------------|
| 1. Server 1 | 2. Server 2 |
| 3. Ethernet switch (Fault domain 1 and fault domain 2) | 4. Storage system |
| 5. Storage controller 1 | 6. Storage controller 2 |
4. To configure the fault domains and ports, click the **Configure Embedded iSCSI Ports** link on the **Configuration Complete** page of the **Discover and Configure Uninitialized SCv2000 Series Storage Centers** wizard.

Next steps

Install or enable MPIO on the host servers.

NOTE: After the Storage Center configuration is complete, run the host access wizard to configure host server access and apply MPIO best practices. For the latest best practices, see the Dell Storage Center Best Practices documents located on the Dell TechCenter (<http://en.community.dell.com/techcenter/storage/>).

Related Links

[Configure Embedded iSCSI Ports](#)

Back-End Cabling and Connecting Power

Back-end cabling refers to the connections between the storage system and expansion enclosures. After the back-end cabling is complete, connect power cables to the storage system components and turn on the hardware.

An SCv2000/SCv2020 storage system can be deployed with or without expansion enclosures.

- When an SCv2000/SCv2020 is deployed without expansion enclosures, the storage controllers must be interconnected using SAS cables. This connection enables SAS path redundancy between the storage controllers and the internal disks.
- When an SCv2000/SCv2020 is deployed with expansion enclosures, the expansion enclosures connect to the SAS ports on the storage controllers.

SC100/SC120 Expansion Enclosure Cabling Guidelines

You can connect multiple SC100/SC120 expansion enclosures to an SCv2000/SCv2020 by cabling the expansion enclosures in series.

The connection between a storage system and the expansion enclosures is referred to as a SAS chain. A SAS chain is made up of two paths, which are referred to as the A side and B side. Each side of the SAS chain starts at the initiator only SAS port on one storage controller and ends at the initiator/target SAS port the other storage controller.

SAS Redundancy

Use redundant SAS cabling to make sure that an unavailable IO port or storage controller does not cause a Storage Center outage.

If an IO port or storage controller becomes unavailable, the Storage Center IO moves to the redundant path.

SAS Port Types

There are two types of back-end SAS ports on each storage controller: initiator only and initiator/target.

The ports labeled A are initiator only ports and the ports labeled B are initiator/target ports.

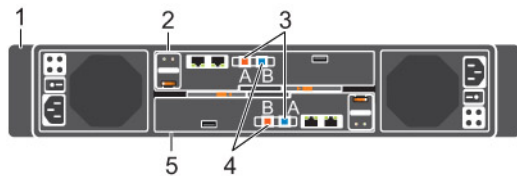

Figure 57. SCv2000/SCv2020 SAS Ports

1. Storage system
2. Storage controller 1

3. Initiator only ports (ports A)
4. Initiator/target ports (ports B)
5. Storage controller 2

Back-End Connections for an SCv2000/SCv2020 without Expansion Enclosures

When you deploy an SCv2000/SCv2020 without expansion enclosures, you must interconnect the storage controllers using SAS cables.

About this task

NOTE: The top storage controller is storage controller 1 and the bottom storage controller is storage controller 2.

Steps

1. Connect a SAS cable between storage controller 1: port A and storage controller 2: port B.
2. Connect a SAS cable between storage controller 1: port B and storage controller 2: port A.

Example

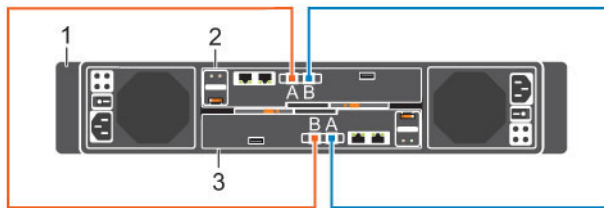

Figure 58. Interconnected Storage Controllers

1. SCv2000/SCv2020 storage system
2. Storage controller 1
3. Storage controller 2

Back-End Connections for an SCv2000/SCv2020 with Expansion Enclosures

This section shows common cabling between the SCv2000/SCv2020 and SC100/SC120 expansion enclosures. Locate the scenario that most closely matches the Storage Center that you are configuring and follow the instructions, modifying them as necessary.

The SCv2000/SCv2020 supports up to eight SC100 expansion enclosures, up to four SC120 expansion enclosures, or any combination of SC100/SC120 expansion enclosures as long as the total disk count does not exceed 168 disks.

SC100/SC120 expansion enclosures chains are cabled as follows.

- Side A (Orange): Expansion enclosures are connected from port B to port A, using the top EMMs.
- Side B (Orange): Expansion enclosures are connected from port A to port B, using the bottom EMMs.

SCv2000/SCv2020 and One SC100/SC120 Expansion Enclosure

This figure shows an SCv2000/SCv2020 cabled to one expansion enclosure forming a single chain.

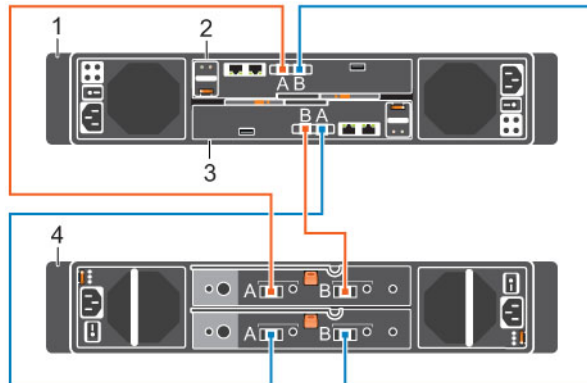

Figure 59. SCv2000/SCv2020 and One SC100/SC120 Expansion Enclosure

- | | |
|-------------------------|-------------------------|
| 1. Storage system | 2. Storage controller 1 |
| 3. Storage controller 2 | 4. Expansion enclosure |

Table 3. Storage System Connected to One Expansion Enclosure

Path	Connections
Chain 1: A Side (Orange)	<ol style="list-style-type: none"> Storage controller 1: port A to the expansion enclosure: top EMM, port A. Expansion enclosure: top EMM, port B to storage controller 2: port B.
Chain 1: B Side (Blue)	<ol style="list-style-type: none"> Storage controller 2: port A to the expansion enclosure: bottom EMM, port A. Expansion enclosure: bottom EMM, port B to storage controller 1: port B.

SCv2000/SCv2020 and Two or More SC100/SC120 Expansion Enclosures

This figure shows an SCv2000/SCv2020 cabled to two expansion enclosures forming a single chain.

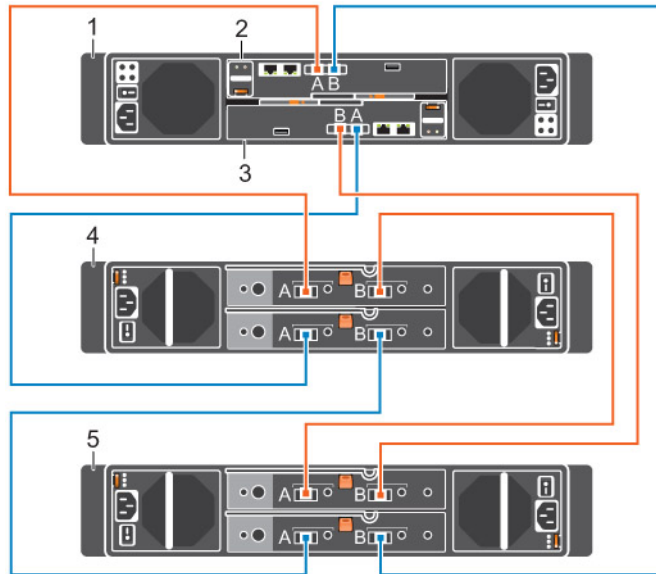

Figure 60. SCv2000/SCv2020 and Two SC100/SC120 Expansion Enclosures

- | | |
|--------------------------|--------------------------|
| 1. Storage system | 2. Storage controller 1 |
| 3. Storage controller 2 | 4. Expansion enclosure 1 |
| 5. Expansion enclosure 2 | |

To connect additional expansion enclosures, cable the expansion enclosures in series. Cable the top EMM, port B from last enclosure in the chain to the top EMM, port A of the enclosure to add. Then, cable the bottom EMM, port B from last enclosure in the chain to the bottom EMM, port A of the enclosure to add.

Table 4. Connected to Two Expansion Enclosures

Path	Connections
Chain 1: A Side (Orange)	<ol style="list-style-type: none"> Storage controller 1: port A to expansion enclosure 1: top EMM, port A. Expansion enclosure 1: top EMM, port B to expansion enclosure 2: top EMM, port A. Expansion enclosure 2: top EMM, port B to storage controller 2: port B.
Chain 1: B Side (Blue)	<ol style="list-style-type: none"> Storage controller 2: port A to expansion enclosure 1: bottom EMM, port A. Expansion enclosure 1: bottom EMM, port B to expansion enclosure 2: bottom EMM, port A. Expansion enclosure 2: bottom EMM, port B to storage controller 1: port B.

Label the Back-End Cables

Label the back-end cables that interconnect the storage controllers or label the back-end cables that connect the storage system to the expansion enclosures.

Prerequisites

Locate the pre-made cable labels provided with the expansion enclosures.

About this task

Apply cable labels to both ends of each SAS cable to indicate the chain number and side (A or B).

Steps

1. Starting with the top edge of the label, attach the label to the cable near the connector.

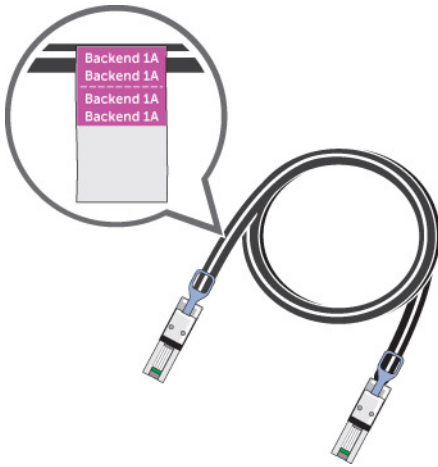

Figure 61. Attach Label to Cable

2. Wrap the label around the cable until it fully encircles the cable. The bottom of each label is clear so that it does not obscure the text.



Figure 62. Wrap Label Around Cable

3. Apply a matching label to the other end of the cable.

Connect Power Cables and Turn on the Storage System

Connect power cables to the storage system components and turn on the hardware.

About this task

- If the storage system is installed without expansion enclosures, connect power cables to the storage system chassis and turn on the storage system.
- If the storage system is installed with expansion enclosures, connect power cables to the expansion enclosure chassis and turn on the expansion enclosures as described in the *Dell Storage Center SC100/SC120 Expansion Enclosure Getting Started Guide*. After the expansion enclosures are powered on, connect power to the storage system chassis and turn on the storage system.

Steps

1. Ensure that the power switches are in the OFF position before connecting the power cables.
2. Connect the power cables to both power supply/cooling fan modules in the storage system chassis and secure the power cables firmly to the brackets using the straps provided.

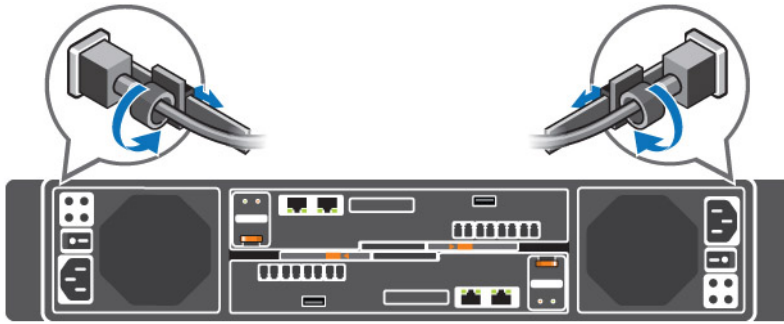

Figure 63. Connect the Power Cables

3. Plug the other end of the power cables into a grounded electrical outlet or a separate power source such as an uninterruptible power supply (UPS) or a power distribution unit (PDU).
4. Press both power switches on the rear of the storage system chassis to turn on the storage system.

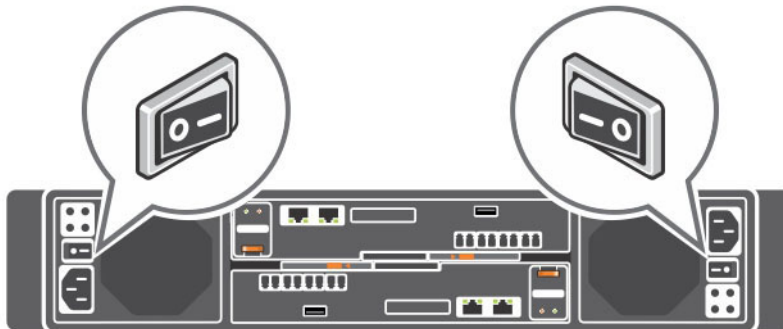



Figure 64. Turn on the Storage System

When the SCv2000/SCv2020 storage system is powered on, there is a delay while the storage system prepares to start up. During the first minute, the only indication that the storage system is

powered on are the LEDs on the storage controllers. After the one-minute delay, the fans and LEDs turn on as an indication that the storage controllers are starting up.

5. Wait until the green diagnostic LEDs on the back of each storage controller match the pattern shown in [Figure 65. Storage Controller Diagnostic LEDs](#). This pattern indicates that a storage controller has started up successfully.

 **NOTE:** It may take up to five minutes for a storage controller to completely start up.

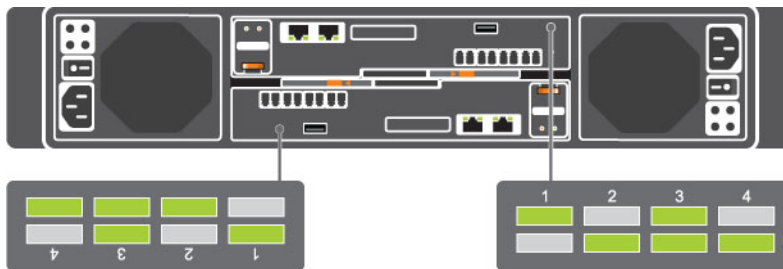

Figure 65. Storage Controller Diagnostic LEDs

Discover and Configure the Storage Center

The Discover and Configure Uninitialized SCv2000 Series Storage Centers wizard allows you to set up a Storage Center to make it ready for volume creation.

Use the Dell Storage Client to discover and configure the Storage Center. After configuring a Storage Center, you can set up a localhost, VMware vSphere host, or VMware vCenter host using the host setup wizards.

The storage system hardware must be installed and cabled before the Storage Center can be configured.

Worksheet to Record System Information

Use the following worksheet to record the information that is needed to install the SCv2000/SCv2020 storage system.

Storage Center Information

Gather and record the following information about the Storage Center network and the administrator user.

Table 5. Storage Center Network

Service Tag	_____
Management IPv4 address (Storage Center management address)	____ . ____ . ____ . ____
Top Controller IPv4 address (Controller 1 MGMT port)	____ . ____ . ____ . ____
Bottom Controller IPv4 address (Controller 2 MGMT port)	____ . ____ . ____ . ____
Subnet mask	____ . ____ . ____ . ____
Gateway IPv4 address	____ . ____ . ____ . ____
Domain name	_____
DNS server address	____ . ____ . ____ . ____
Secondary DNS server address	____ . ____ . ____ . ____

Table 6. Storage Center Administrator

Password for the default Storage Center "Admin" user	_____
Email address of the default Storage Center "Admin" user	_____

iSCSI Fault Domain Information

For a storage system with iSCSI front-end ports, gather and record network information for the iSCSI fault domains. This information is needed to complete the **Discover and Configure Uninitialized SCv2000 Series Storage Centers** wizard.

 **NOTE:** For a storage system deployed with two Ethernet switches, Dell recommends setting up each fault domain on separate subnets.

Table 7. iSCSI Fault Domain 1

Target IPv4 address	_____ . _____ . _____ . _____
Subnet mask	_____ . _____ . _____ . _____
Gateway IPv4 address	_____ . _____ . _____ . _____
IPv4 address for storage controller module 1: port 1	_____ . _____ . _____ . _____
IPv4 address for storage controller module 2: port 1	_____ . _____ . _____ . _____
(Four port I/O card only) IPv4 address for storage controller module 1: port 3	_____ . _____ . _____ . _____
(Four port I/O card only) IPv4 address for storage controller module 2: port 3	_____ . _____ . _____ . _____

Table 8. iSCSI Fault Domain 2

Target IPv4 address	_____ . _____ . _____ . _____
Subnet mask	_____ . _____ . _____ . _____
Gateway IPv4 address	_____ . _____ . _____ . _____
IPv4 address for storage controller module 1: port 2	_____ . _____ . _____ . _____
IPv4 address for storage controller module 2: port 2	_____ . _____ . _____ . _____
(Four port I/O card only) IPv4 address for storage controller module 1: port 4	_____ . _____ . _____ . _____
(Four port I/O card only) IPv4 address for storage controller module 2: port 4	_____ . _____ . _____ . _____

Additional Storage Center Information

The Network Time Protocol (NTP) and Simple Mail Transfer Protocol (SMTP) server information is optional. The proxy server information is also optional, but it may be required to complete the **Discover and Configure Uninitialized SCv2000 Series Storage Centers** wizard.

Table 9. NTP, SMTP, and Proxy Servers

NTP server IPv4 address	_____ . _____ . _____ . _____
SMTP server IPv4 address	_____ . _____ . _____ . _____
Backup SMTP server IPv4 address	_____ . _____ . _____ . _____

SMTP server login ID _____
 SMTP server password _____
 Proxy server IPv4 address ____ . ____ . ____ . ____

Fibre Channel Zoning Information

For a storage system with Fibre Channel front-end ports, record the physical and virtual WWNs of the Fibre Channel ports in Fault Domain 1 and Fault Domain 2. This information is displayed on the **Review Front-End** page of the **Discover and Configure Uninitialized SCv2000 Series Storage Centers** wizard. Use this information to configure zoning on each Fibre Channel switch.

Table 10. Physical WWNs in Fault Domain 1

Physical WWN of storage controller 1: port 1 _____
 Physical WWN of storage controller 2: port 1 _____
 (Four port I/O card only) Physical WWN of storage controller 1: port 3 _____
 (Four port I/O card only) Physical WWN of storage controller 2: port 3 _____

Table 11. Virtual WWNs in Fault Domain 1

Virtual WWN of storage controller 1: port 1 _____
 Virtual WWN of storage controller 2: port 1 _____
 (Four port I/O card only) Virtual WWN of storage controller 1: port 3 _____
 (Four port I/O card only) Virtual WWN of storage controller 2: port 3 _____

Table 12. Physical WWNs in Fault Domain 2

Physical WWN of storage controller 1: port 2 _____
 Physical WWN of storage controller 2: port 2 _____
 (Four port I/O card only) Physical WWN of storage controller 1: port 4 _____
 (Four port I/O card only) Physical WWN of storage controller 2: port 4 _____

Table 13. Virtual WWNs in Fault Domain 2

Virtual WWN of storage controller 1: port 2 _____
 Virtual WWN of storage controller 2: port 2 _____
 (Four port I/O card only) Virtual WWN of storage controller 1: port 4 _____
 (Four port I/O card only) Virtual WWN of storage controller 2: port 4 _____

Locating Your Service Tag

Your storage system is identified by a unique Service Tag number.

You can find the Service Tag number on the service luggage tag located next to the front panel display. The Service Tag number is also located on the back of the storage system chassis. Dell uses this information to route support calls to the appropriate personnel.

Supported Operating Systems for Storage Center Automated Setup

Setting up a Storage Center using the Discover and Configure Uninitialized SCv2000 Series Storage Centers wizard and the Host Setup wizards requires 64-bit versions of the following operating systems.

- Red Hat Enterprise Linux 6 or later
- SUSE Linux Enterprise 12 or later
- Windows Server 2008 R2 or later

Install and Use the Dell Storage Client

You must start the Dell Storage Client as an Administrator to run the Discover and Configure Uninitialized SCv2000 Series Storage Centers wizard.

1. Go to www.dell.com/support and download the Dell Enterprise Manager software.
2. Install the Enterprise Manager Client on the host server.
To discover and configure a Storage Center, the software must be installed on a host server that is on the same subnet as the storage system.
3. To start the software on a Windows computer, double-click the Enterprise Manager Client shortcut. To start the software on a Linux computer, execute `./Client` from the `var/lib/dell/bin` directory.
4. Click **Discover and Configure Uninitialized SCv2000 Series Storage Centers**. The **Discover and Configure Uninitialized SCv2000 Series Storage Centers** wizard appears.

Discover and Select an Uninitialized Storage Center

The first page of the **Discover and Configure Uninitialized SCv2000 Series Storage Centers** wizard provides a list of prerequisite actions and information required before setting up a Storage Center.

Prerequisites

- Make sure that the Storage Center hardware is physically attached to all necessary networks and powered on.
- The host server, on which the Dell Storage Client software is installed, must be on the same subnet or VLAN as the Storage Center.
- Layer 2 multicast must be allowed on the network.

Steps

1. Make sure that you have the required information that is listed on the first page of the wizard. This information is needed to configure the Storage Center.
2. Click **Next**. The **Select a Storage Center to Initialize** page appears and lists the uninitialized Storage Centers discovered by the wizard.

-  **NOTE:** If the wizard does not discover the Storage Center that you want to initialize, perform one of the following actions:
- Ensure that the Storage Center is physically attached to all necessary networks and powered on. Then click **Rediscover**.
 - Click **Troubleshoot Storage Center Hardware Issue** to learn more about reasons why the Storage Center is not discoverable.
 - Click **Manually Discover Storage Center via MAC Address** to enter the MAC address for the Storage Center.
3. Select the Storage Center to initialize.
 4. (Optional) Click **Enable Storage Center Indicator** to turn on the indicator light for the selected Storage Center. You can use the indicator to verify that you have selected the correct Storage Center.
 5. Click **Next**.
 6. If the Storage Center is partially configured, the Storage Center login pane appears. Enter the management IPv4 address and the Admin password for the Storage Center, then click **Next** to continue.

Set System Information

The Set System Information page allows you to enter Storage Center and controller configuration information to use when connecting to the Storage Center using Dell Storage Client.

1. Enter a descriptive name for the Storage Center in the **Storage Center Name** field.
2. Enter the system management IPv4 address for the Storage Center in the **Management IPv4 Address** field. The Management IPv4 Address is the IP address used to manage the Storage Center and is different than a controller IPv4 address.
3. Enter an IPv4 address for the management port of each controller.

 **NOTE:** The controller IPv4 addresses and Management IPv4 Address must be within the same subnet.
4. Enter the subnet mask of the management network in the **Subnet Mask** field.
5. Enter the gateway address of the management network in the **Gateway IPv4 Address** field.
6. Enter the domain name of the management network in the **Domain Name** field.
7. Enter the DNS server addresses of the management network in the **DNS Server** and **Secondary DNS Server** fields.
8. Click **Next**. The **Set Administration Information** page appears.



Set Administrator Information

The Set Administrator Information page allows you to set a new password and an email address for the Admin user.

1. Enter a new password for the default Storage Center administrator user in the **New Admin Password** and **Confirm Password** fields.
2. Enter the email address of the default Storage Center administrator user in the **Admin Email Address** field.
3. Click **Next**.
 - For a Fibre Channel or SAS storage system, the **Confirm Configuration** page appears.
 - For an iSCSI storage system, the **Configure iSCSI Fault Domains** page appears.

Configure iSCSI Fault Domains

For a Storage Center with iSCSI front-end ports, use the Configure iSCSI Fault Domains page and the Fault Domain pages to enter network information for the fault domains and ports.

1. (Optional) On the **Configure iSCSI Fault Domains** page, click **More information about fault domains** or **How to set up an iSCSI network** to learn more about these topics.
2. Click **Next**.
 -  **NOTE:** If there are down iSCSI ports, a dialog box appears that allows you to unconfigure down iSCSI ports. Unconfiguring the down iSCSI ports will prevent unnecessary alerts.
3. On the **Configure iSCSI HBA Fault Domain 1** page, enter network information for the fault domain and its ports.
 -  **NOTE:** Make sure that all the IP addresses for iSCSI Fault Domain 1 are in the same subnet.
4. Click **Next**.
5. On the **Configure iSCSI HBA Fault Domain 2** page, enter network information for the fault domain and its ports. Then click **Next**.
 -  **NOTE:** Make sure that all the IP addresses for iSCSI Fault Domain 2 are in the same subnet.
6. Click **Next**.

Confirm the Storage Center Configuration

Make sure that the configuration information shown on the Confirm Configuration page is correct before continuing.

1. Verify that the Storage Center settings are correct.
 - For an iSCSI storage system, verify that the iSCSI Fault Domain settings are correct.
 - To copy the configuration information to the clipboard so it can be pasted into a document, click **Copy to clipboard**.
2. If the configuration information is correct, click **Apply Configuration**.
 - If the configuration information is incorrect, click **Back** and enter the correct information.
 -  **NOTE:** After the **Apply Configuration** button is clicked, the configuration cannot be changed until after the Storage Center is fully configured.

Initialize the Storage Center

The Storage Center sets up the system using the information provided on the previous pages.

1. The Storage Center performs system setup tasks. The **Initialize Storage Center** page displays the status of the system setup tasks.
 - To learn more about the initialization process, click **More information about Initialization**.
 - If one or more of the system setup tasks fails, click **Troubleshoot Initialization Error** to learn how to resolve the issue.
 - If the Configuring Disks task fails, click **View Disks** to see the status of the disks detected by the Storage Center.

- If any of the Storage Center front-end ports are down, the **Storage Center Front-End Ports Down** dialog box appears. Select the ports that are not connected to the storage network, and then click **OK**.
2. When all of the Storage Center setup tasks are complete, click **Next**.

Review Fibre Channel Front-End Configuration

For a Storage Center with Fibre Channel front-end ports, the Fault Domains page displays an example fault domain topology based on the number of controllers and type of front-end ports. The Review Front-End Configuration page displays information about the fault domains created by the Storage Center.

1. (Optional) On the **Fault Domains** page, click **More information about fault domains** to learn more about fault domains.
2. Click **Next**.
3. On the **Review Front-End Configuration** page, make sure that the information about the fault domains is correct.
4. Using the information provided on the **Review Front-End Configuration** page, configure Fibre Channel zoning to create the physical and virtual zones described in [Fibre Channel Zoning](#).
5. Click **Next**.

Review SAS Front-End Configuration

For a Storage Center with SAS front-end ports, the Fault Domains page displays an example fault domain topology based on the number of controllers and type of front-end ports. The Review Front-End Configuration page displays information about the fault domains created by the Storage Center.

1. (Optional) On the **Fault Domains** page, click **More information about fault domains** to learn more about fault domains.
2. Click **Next**.
3. On the **Review Front-End Configuration** page, make sure that the information about the fault domains is correct.
4. Click **Next**.

Configure Time Settings

Configure an NTP server to set the time automatically or set the time and date manually.

1. From the **Region** and **Time Zone** drop-down menus, select the region and time zone used to set the time.
2. Select **Use NTP Server** and enter the host name or IPv4 address of the NTP server, or select **Set Current Time** and set the time and date manually.
3. Click **Next**.

Configure SMTP Server Settings

Enable SMTP email to receive information from the Storage Center about errors, warnings, and events.

1. Place a check next to **Enable SMTP Email**.
2. Enter the SMTP mail server, backup SMTP mail server, email address, and subject line information.

3. Click **Test Server** to check the connectivity from the Storage Center to the SMTP server.
4. (Optional) Place a check next to **Use Authorized Login**, and then enter the ID and password.
5. Click **Next**.

Configure Key Management Server Settings

The Key Management Server Settings page appears if supported by the Storage Center license. Use this page to enter network settings and select the certificate files.

1. Enter network settings for the server.
2. Enter the user name and password.
3. Select the SSL certificate files.
4. Click **Next**.
The **Configure Ports** page appears.

Review the SupportAssist Data Collection and Storage Agreement

The SupportAssist Data Collection and Storage page displays the text of the SupportAssist data agreement and allows you to accept or opt out of SupportAssist.

1. To allow SupportAssist to collect diagnostic data and send this information to technical support, select **By checking this box you accept the above terms**.
2. Click **Next**.
3. If you did not select **By checking this box you accept the above terms**, the **SupportAssist Recommended** pane appears.
 - Click **No** to return to the **SupportAssist Data Collection and Storage** page and accept the agreement.
 - Click **Yes** to opt out of SupportAssist and proceed to the **Update Storage Center** page.

Advantages and Benefits of Dell SupportAssist

As an integral part for Dell's ability to provide best of class support for your Enterprise class products, Dell SupportAssist proactive provides the information required to diagnose support issues, enabling the most efficient support possible and reducing the effort required by you.

A few key benefits of SupportAssist are:

- Enables proactive service requests and real-time troubleshooting
- Automatic support case creation based on event alerting
- Enables ProSupport Plus and optimizes service delivery
- Automatic health checks
- Enables remote Storage Center updates

Dell strongly recommends enabling comprehensive support service at time of incident and proactive service with SupportAssist.

Provide Contact Information

Enter contact information for technical support to use when sending support-related communications using **Dell SupportAssist**.

1. Enter contact information.
2. To receive SupportAssist emails, select **Yes, I would like to receive emails from Dell SupportAssist when issues arise, including hardware failure notifications**.
3. Select the preferred contact method, language, and available times.
4. Enter a shipping address where replacement Storage Center components can be sent.
5. Click **Next**.

Update Storage Center

The Storage Center attempts to contact the SupportAssist Update Server to check for updates.

- If no update is available, the **Storage Center Up to Date** page appears. Click **Next**.
- If an update is available, the current and available versions are listed.
 - a. Click **Install** to update to the latest version.
 - b. If the update fails, click **Retry Update** to try to update again.
 - c. When the update is complete, click **Next**.
- If the SupportAssist Data Collection and Storage Agreement was not accepted, the Storage Center cannot check for updates.
 - To proceed without checking for an update, click **Next**.
 - To accept the agreement and check for an update:
 - a. Click **Accept SupportAssist Data Collection and Storage Agreement** to review the agreement.
 - b. Select **By checking this box you accept the above terms**.
 - c. Click **Next**. The Storage Center attempts to contact the SupportAssist Update Server to check for updates.
- The **Setup SupportAssist Proxy Settings** dialog box appears if the Storage Center cannot connect to the Dell SupportAssist Update server. If the site does not have direct access to the Internet but uses a web proxy, configure the proxy settings:
 - a. Select **Enabled**.
 - b. Enter the proxy settings.
 - c. Click **OK**. The Storage Center attempts to contact the SupportAssist Update Server to check for updates.

Complete Configuration and Perform Next Steps

The Storage Center is now configured. The Configuration Complete page provides links to a Dell Storage Client tutorial and wizards to perform the next setup tasks.

1. (Optional) Click one of the **Next Steps** to configure a localhost, configure a VMware host, or create a volume.

When you have completed the step, you are returned to the **Configuration Complete** page.
2. (Optional) Click one of the **Advanced Steps** to configure embedded iSCSI ports or modify BMC settings.

When you have completed the step, you are returned to the **Configuration Complete** page.

3. Click **Finish** to exit the wizard.

Set Up a localhost or VMware Host

After configuring a Storage Center, you can set up block level storage for a localhost, VMware vSphere host, or VMware vCenter.

Set Up a localhost from Initial Setup

Configure a localhost to access block level storage on the Storage Center.

Prerequisites

- Client must be running on a system with a 64-bit operating system.
- The Dell Storage Client must be run by a Dell Storage Client user with the Administrator privilege.
- On a Storage Center with Fibre Channel IO ports, configure Fibre Channel zoning before starting this procedure.

Steps

1. On the **Configuration Complete** page of the **Discover and Configure Storage Center** wizard, click **Set up block level storage for this host**.
The **Set up localhost for Storage Center** wizard appears.
 - If the Storage Center has iSCSI ports and the host is not connected to any interface, the **Log into Storage Center via iSCSI** page appears. Select the target fault domains, and then click **Log In**.
 - In all other cases, the **Verify localhost Information** page appears. Proceed to the next step.
2. On the **Verify localhost Information** page, verify that the information is correct. Then click **Create Server**.
The server definition is created on the Storage Center for the connected and partially connected initiators.
3. The **Host Setup Successful** page displays the best practices that were set by the wizard and best practices that were not set. Make a note of any best practices that were not set by the wizard. It is recommended that these updates are applied manually before starting IO to the Storage Center.
4. (Optional) Place a check next to **Create a Volume for this host** to create a volume after finishing host setup.
5. Click **Finish**.

Set Up a VMware vSphere Host from Initial Setup

Configure a VMware vSphere host to access block level storage on the Storage Center.

Prerequisites

- Client must be running on a system with a 64-bit operating system.
- The Dell Storage Client must be run by a Dell Storage Client user with the Administrator privilege.
- On a Storage Center with Fibre Channel IO ports, configure Fibre Channel zoning before starting this procedure.

About this task

 **NOTE:** Block level storage cannot be set up for a VMware cluster on a Storage Center with SAS IO ports.

Steps

1. On the **Configuration Complete** page of the **Discover and Configure Storage Center** wizard, click **Configure VMware vSpheres to access a Storage Center**.
The **Set up VMware Host on Storage Center** wizard appears.
2. Enter the IP address or hostname, the user name and password. Then click **Next**.
 - If the Storage Center has iSCSI ports and the host is not connected to any interface, the **Log into Storage Center via iSCSI** page appears. Select the target fault domains, and then click **Log In**.
 - In all other cases, the **Verify vSpheres Information** page appears. Proceed to the next step.
3. Select an available port, and then click **Create Server**.
The server definition is created on the Storage Center.
4. The **Host Setup Successful** page displays the best practices that were set by the wizard and best practices that were not set. Make a note of any best practices that were not set by the wizard. It is recommended that these updates are applied manually before starting IO to the Storage Center.
5. (Optional) Place a check next to **Create a Volume for this host** to create a volume after finishing host setup.
6. Click **Finish**.

Set Up a VMware vCenter Host from Initial Setup

Configure a VMware vCenter cluster to access block level storage on the Storage Center.

Prerequisites

- Client must be running on a system with a 64-bit operating system.
- The Dell Storage Client must be run by a Dell Storage Client user with the Administrator privilege.
- On a Storage Center with Fibre Channel IO ports, configure Fibre Channel zoning before starting this procedure.

About this task



 **NOTE:** Block level storage cannot be set up for a VMware vCenter on a Storage Center with SAS IO ports.

Steps

1. On the **Configuration Complete** page of the **Discover and Configure Storage Center** wizard, click **Configure VMware vSpheres to access a Storage Center**.
The **Set up VMware Host on Storage Center** wizard appears.
2. Enter the IP address or hostname, the user name and password. Then click **Next**.
 - If the Storage Center has iSCSI ports and the host is not connected to any interface, the **Log into Storage Center via iSCSI** page appears. Select the hosts and target fault domains, and then click **Log In**.
 - In all other cases, the **Verify vCenters Information** page appears. Proceed to the next step.
3. Select an available port, and then click **Create Servers**.
The server definition is created on the Storage Center for each of the connected or partially connected hosts.
4. The **Host Setup Successful** page displays the best practices that were set by the wizard and best practices that were not set. Make a note of any best practices that were not set by the wizard. It is recommended that these updates are applied manually before starting IO to the Storage Center.
5. Click **Finish**.

Configure Embedded iSCSI Ports

Configure the embedded Ethernet ports on the Storage Center for use as iSCSI ports.

1. Configure the fault domain and ports for iSCSI Embedded Domain 1.
 - a. Enter the target IPv4 address, subnet mask, and gateway for the fault domain.
 - b. Enter an IPv4 address for each port in the fault domain.
 **NOTE:** Make sure that all the IP addresses for iSCSI Embedded Domain 1 are in the same subnet.
2. If the Flex Port license is installed, configure the fault domain and ports for Flex Port Domain 1.
 - a. Enter the target IPv4 address, subnet mask, and gateway for the fault domain.
 - b. Enter an IPv4 address for each port in the fault domain.
 **NOTE:** Make sure that all the IP addresses for iSCSI Embedded Domain 1 are in the same subnet.
3. Click **OK**.

Perform Post-Setup Tasks

Perform connectivity and failover tests to make sure that the Storage Center deployment was successful.

Verify Connectivity and Failover

This section describes the general steps needed to verify that Storage Center is set up properly and performs failover correctly.

The process includes creating test volumes, copying data to verify connectivity, and shutting down a storage controller to verify failover and MPIO functionality.

Create Test Volumes

Connect a server to the Storage Center, create one or more test volumes, and map them to the server to prepare for connectivity and failover testing.

About this task

Steps

1. Configure a localhost to access the Storage Center using the **Set up localhost on Storage Center** wizard.
2. Connect to the Storage Center using the Dell Storage Client.
3. Create a 25 GB test volume named TestVol1 and map it to the top storage controller (storage controller 1).
 - a. Click the **Storage** tab.
 - b. From the **Storage** tab navigation pane, select the **Volumes** node.
 - c. Click **Create Volume**. The **Create Volume** wizard appears.
 - d. Enter `TestVol1` in the **Name** field, then click **Next**.
 - e. Set the volume size to 25 GB, then click **Next**.
 - f. Select the disk folder to use, then click **Next**.
 - g. Select the replay profile to use, then click **Next**.
 - h. Select the server to which to map the volume and click **Advanced Mapping**.
 - i. Clear the check box under **Restrict Mapping Paths** and select the controller on which to activate the volume.
 - j. Click **OK** and click **Next**.
 - k. Click **Finish**.
4. Repeat the previous steps to create 25 GB volume named TestVol2 and map it to the bottom storage controller (storage controller 2).
5. Partition and format the test volumes on the server.

Test Basic Connectivity

Verify basic connectivity by copying data to the test volumes.

1. Connect to the server to which the volumes are mapped.
2. Create a folder on the TestVol1 volume, copy at least 2 GB of data to the folder, and verify that the data copied successfully.
3. Create a folder on the TestVol2 volume, copy at least 2 GB of data to the folder, and verify that the data copied successfully.

Test Storage Controller Failover

Test the Storage Center to make sure that a storage controller failover does not interrupt IO.

1. Connect to the server, create a Test folder on the server, and copy at least 2 GB of data into it.
2. Restart the top storage controller while copying data to verify that the failover event does not interrupt IO.
 - a. Copy the Test folder to the TestVol1 volume.
 - b. During the copy process, restart the top storage controller (the storage controller through which TestVol1 is mapped) by selecting it from the **Hardware** tab and clicking **Shutdown/Restart Controller**.
 - c. Verify that the copy process continues while the storage controller restarts.
 - d. Wait several minutes and verify that the storage controller has finished restarting.
3. Restart the bottom storage controller while copying data to verify that the failover event does not interrupt IO.
 - a. Copy the Test folder to the TestVol2 volume.
 - b. During the copy process, restart the bottom storage controller (the storage controller through which the TestVol2 is mapped) by selecting it from the **Hardware** tab and clicking **Shutdown/Restart Controller**.
 - c. Verify that the copy process continues while the storage controller restarts.
 - d. Wait several minutes and verify that the storage controller has finished restarting.

Test MPIO

Perform the following tests for a Storage Center with Fibre Channel or iSCSI front-end connectivity if the network environment and servers are configured for MPIO. Always perform the following tests for a Storage Center with SAS front-end connectivity.

1. Create a Test folder on the server and copy at least 2GB of data into it.
2. Make sure that the server is configured to use load balancing MPIO (round-robin).
3. Manually disconnect a path while copying data to TestVol1 to verify that MPIO is functioning correctly.
 - a. Copy the Test folder to the TestVol1 volume.
 - b. During the copy process, disconnect one of the paths and verify that the copy process continues.
 - c. Reconnect the path.
4. Repeat the previous steps as necessary to test additional paths.
5. Restart the storage controller that contains the active path while IO is being transferred and verify that the IO process continues.
6. If the front-end connectivity of the Storage Center is Fibre Channel or iSCSI and the Storage Center is not in a production environment, restart the switch that contains the active path while IO is being transferred, and verify that the IO process continues.

Clean up Test Volumes

After testing is complete, delete the volumes used for testing.

1. Connect to the server to which the volumes are mapped and remove the volumes.
2. Connect to the Storage Center using the Dell Storage Client.
3. Click the **Storage** tab.
4. From the **Storage** tab navigation pane, select the **Volumes** node.
5. Select the volumes to delete.
6. Right-click on the selected volumes and select **Delete**. The **Delete** dialog box appears.
7. Click **OK**

Sending Diagnostic Data Using Dell SupportAssist

Use Dell SupportAssist to send diagnostic data to Dell Technical Support Services.

1. Click **Send SupportAssist Data Now**. The **Send Support Assist Data Now** dialog box appears.
2. Select **Storage Center Configuration** and **Detailed Logs**.
3. Click **OK**.

Label SC100/SC120 Expansion Enclosures

SC100/SC120 expansion enclosures do not have displays to indicate the expansion enclosure ID assigned by Storage Center.

About this task

To facilitate easy identification in the rack, use Dell Storage Client to match each expansion enclosure ID to a Service Tag. Locate the Service Tag on the back of each expansion enclosure and then label it with the correct expansion enclosure ID.

 **NOTE:** If the expansion enclosure is deleted from Storage Client and then added back in, the expansion enclosure is assigned a new index number, requiring a label change.

Steps

1. Click the **Hardware** tab.
2. In the **Hardware** tab navigation pane, select the **Enclosures** node.
3. In the right-pane, locate the enclosure to label and record the Service Tag.
4. Create a label with the enclosure ID.
 **NOTE:** If the name of the enclosure is Enclosure - 2, the enclosure ID is 2.
5. Locate the expansion enclosure with the recorded Service Tag and apply the ID label to the left-front of the enclosure.

Adding or Removing an Expansion Enclosure

This section describes how to add an expansion enclosure to a storage system and how to remove an expansion enclosure from a storage system.

Adding Multiple Expansion Enclosures to a Storage System Deployed without Expansion Enclosures

Use caution when adding expansion enclosures to a live Storage Center system to preserve the integrity of the existing data.

Prerequisites

Install the expansion enclosures in a rack and, but do not connect the expansion enclosures to the storage system. For more information, see the *Dell Storage Center SC100/SC120 Expansion Enclosure Getting Started Guide*

Steps

1. Cable the expansion enclosures together to form a chain.
2. Connect to the Storage Center using the Dell Storage Client.
3. Check the disk count of the Storage Center system before adding the expansion enclosure.
4. Click the **Hardware** tab and select **Enclosures** node in the Hardware tab navigation pane.
5. Click **Add Enclosure**. The **Add New Enclosure** wizard starts.
 - a. Click **Next** to validate the existing cabling.
 - b. Select the enclosure type and click **Next**.
 - c. If the drives are not installed, install the drives in the expansion enclosures.
 - d. Turn on the expansion enclosure. When the drives spin up, make sure that the front panel and power status LEDs show normal operation.
 - e. Click **Next**.
 - f. Add the expansion enclosure to the A-side chain. Click **Next** to validate the cabling.
 - g. Add the expansion enclosure to the B-side chain. Click **Next** to validate the cabling.
 - h. Click **Finish**.
6. To manually manage new unassigned disks:
 - a. Click the **Storage** tab.
 - b. In the **Storage** tab navigation pane, select the **Disks** node.
 - c. Click **Manage Unassigned Disks**. The **Manage Unassigned Disks** dialog box appears.
 - d. From the **Disk Folder** drop-down menu, select the disk folder for the unassigned disks.
 - e. Select **Perform RAID rebalance immediately**.
 - f. Click **OK**.

For more information, see the *Dell Enterprise Manager Administrator's Guide*.
7. Label the new back-end cables.

Related Links

[Cable the Expansion Enclosures Together](#)

[Check the Current Disk Count before Adding Expansion Enclosures](#)

- [Add the Expansion Enclosures to the A-Side Chain](#)
- [Add the Expansion Enclosures to the B-Side Chain](#)
- [Label the Back-End Cables](#)

Cable the Expansion Enclosures Together

Cable the expansion enclosures together to form a chain, but do not connect the chain to the storage system.

1. Connect a SAS cable from expansion enclosure 1: top, port B to expansion enclosure 2: top, port A.
2. Connect a SAS cable from expansion enclosure 1: bottom, port B to expansion enclosure 2: bottom, port A.

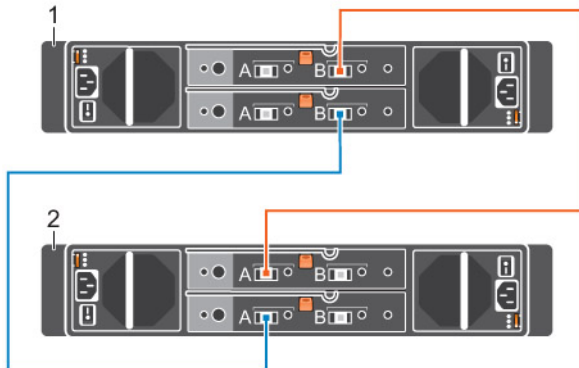

Figure 66. Cable the Expansion Enclosures Together

1. Expansion enclosure 1
2. Expansion enclosure 2
3. Repeat the previous steps to connect additional expansion enclosures to the chain.

Check the Current Disk Count before Adding Expansion Enclosures

Use the Dell Storage Client to determine the number of drives that are currently accessible to the Storage Center.

1. Connect to the Storage Center using the Dell Storage Client.
2. Select the **Storage** tab.
3. In the **Storage** tab navigation pane, select the **Disks** node.
4. On the **Disks** tab, record the number of drives that are accessible by Storage Center.
Compare this value to the number of drives accessible by the Storage Center after adding expansion enclosures to the storage system.

Add the Expansion Enclosures to the A-Side Chain

Connect the expansion enclosures to one chain at a time to maintain drive availability.

1. Disconnect the A-side chain that interconnects the storage controllers.
Remove the SAS cable that connects storage controller 1: port A to storage controller 2: port B.

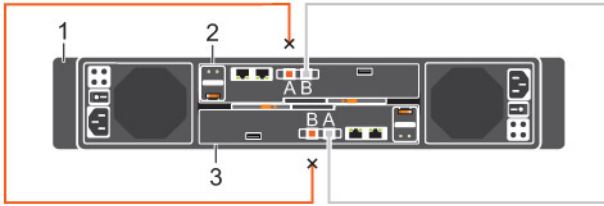

Figure 67. Remove the A-Side Cable from the Storage Controllers

1. Storage system
 2. Storage controller 1
 3. Storage controller 2
2. Add the expansion enclosures to the A-side chain.
 - a. Connect a SAS cable from storage controller 1: port A to the first expansion enclosure in the chain, top EMM, port A.
 - b. Connect a SAS cable from storage controller 2: port B to the last expansion enclosure in the chain, top EMM, port B.

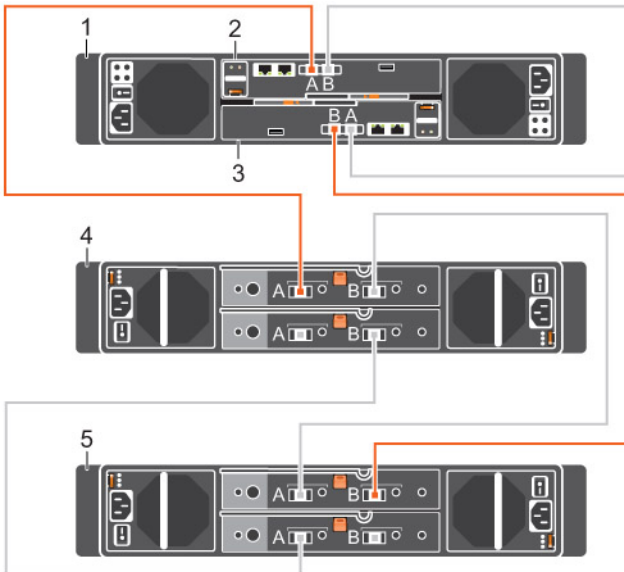

Figure 68. Connect the A-Side Cables to the Expansion Enclosures

1. Storage system
2. Storage controller 1
3. Storage controller 2
4. Expansion enclosure 1
5. Expansion enclosure 2

Add the Expansion Enclosures to the B-Side Chain

Connect the expansion enclosures to one chain at a time to maintain drive availability.

1. Disconnect the B-side chain that interconnects the storage controllers.
Remove the SAS cable that connects storage controller 1: port B to storage controller 2: port A.

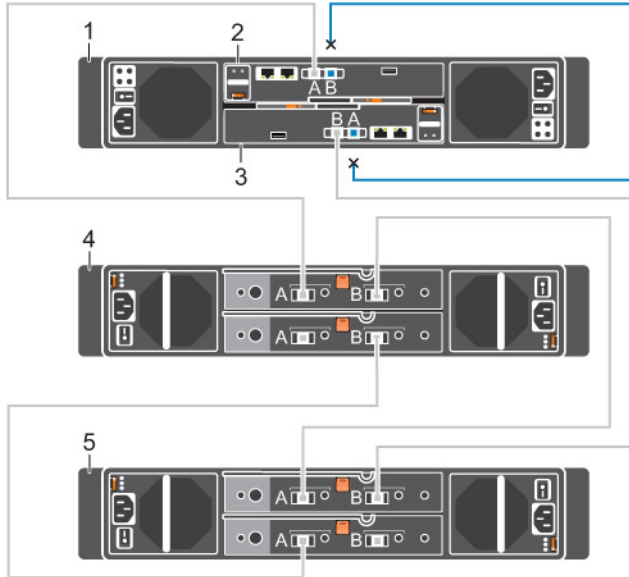

Figure 69. Remove the B-Side Cable from the Storage Controllers

1. Storage system
 2. Storage controller 1
 3. Storage controller 2
 4. Expansion enclosure 1
 5. Expansion enclosure 2
2. Add the expansion enclosures to the B-side chain.
 - a. Connect a SAS cable from storage controller 1: port B to expansion enclosure 2: bottom EMM, port B.
 - b. Connect a SAS cable from storage controller 2: port A to expansion enclosure 1: bottom EMM, port A.

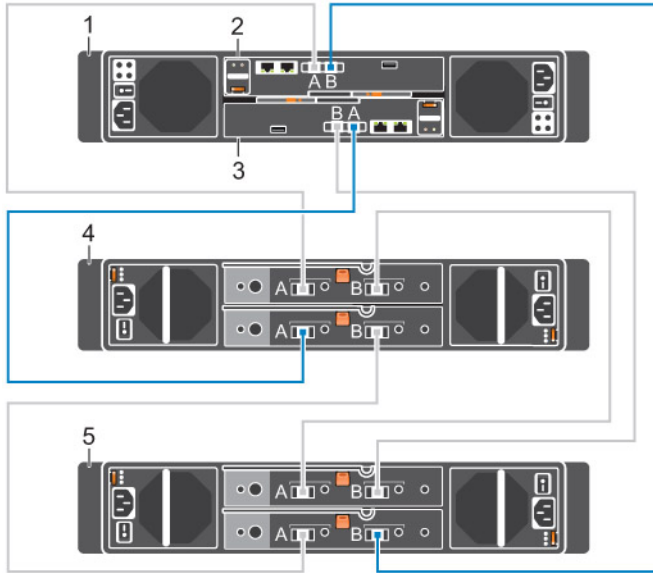

Figure 70. Connect the B-Side Cables to the Expansion Enclosures

- | | |
|--------------------------|--------------------------|
| 1. Storage system | 2. Storage controller 1 |
| 3. Storage controller 2 | 4. Expansion enclosure 1 |
| 5. Expansion enclosure 2 | |

Label the Back-End Cables

Label the back-end cables that interconnect the storage controllers or label the back-end cables that connect the storage system to the expansion enclosures.

Prerequisites

Locate the pre-made cable labels provided with the expansion enclosures.

About this task

Apply cable labels to both ends of each SAS cable to indicate the chain number and side (A or B).

Steps

1. Starting with the top edge of the label, attach the label to the cable near the connector.

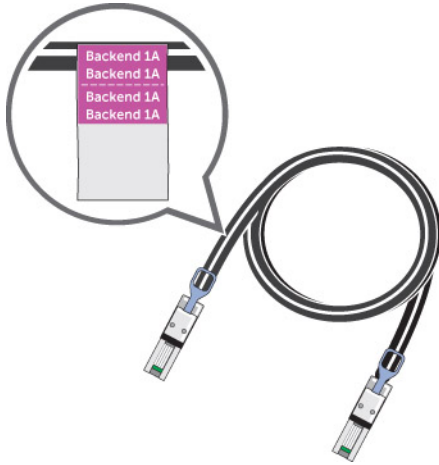

Figure 71. Attach Label to Cable

2. Wrap the label around the cable until it fully encircles the cable. The bottom of each label is clear so that it does not obscure the text.



Figure 72. Wrap Label Around Cable

3. Apply a matching label to the other end of the cable.

Adding a Single Expansion Enclosure to a Chain Currently in Service

Use caution when adding an expansion enclosure to a live Storage Center system to preserve the integrity of the existing data.

Prerequisites

Install the expansion enclosure in a rack, but do not connect the expansion enclosure to the storage system. For more information, see the *Dell Storage Center SC100/SC120 Expansion Enclosure Getting Started Guide*.

About this task

To add an expansion enclosure to an existing chain, connect the expansion enclosure to the end of the chain.

Steps

1. Connect to the Storage Center using the Dell Storage Client.
2. Check the disk count of the Storage Center system before adding the expansion enclosure.
3. Click the **Hardware** tab and select **Enclosures** in the Hardware tab navigation pane.
4. Click **Add Enclosure**. The **Add New Enclosure** wizard starts.
 - a. Confirm the details of your current install and click **Next** to validate the existing cabling.
 - b. Select the enclosure type and click **Next**.
 - c. If the drives are not installed, install the drives in the expansion enclosure.
 - d. Turn on the expansion enclosure. When the drives spin up, make sure that the front panel and power status LEDs show normal operation.
 - e. Click **Next**.
 - f. Add the expansion enclosure to the A-side chain. Click **Next** to validate the cabling.
 - g. Add the expansion enclosure to the B-side chain. Click **Next** to validate the cabling.
 - h. Click **Finish**.
5. To manually manage new unassigned disks:
 - a. Click the **Storage** tab.
 - b. In the **Storage** tab navigation pane, select the **Disks** node.
 - c. Click **Manage Unassigned Disks**. The **Manage Unassigned Disks** dialog box appears.
 - d. From the **Disk Folder** drop-down menu, select the disk folder for the unassigned disks.
 - e. Select **Perform RAID rebalance immediately**.
 - f. Click **OK**.

For more information, see the *Dell Enterprise Manager Administrator's Guide*.

6. Label the new back-end cables.

Related Links

- [Check the Current Disk Count before Adding Expansion Enclosures](#)
- [Add an Expansion Enclosure to the A-side Chain](#)
- [Add an Expansion Enclosure to the B-side Chain](#)
- [Label the Back-End Cables](#)

Check the Disk Count before Adding an Expansion Enclosure

Use the Dell Storage Client to determine the number of drives that are currently accessible to the Storage Center.

1. Connect to the Storage Center using the Dell Storage Client.
2. Select the **Storage** tab.
3. In the **Storage** tab navigation pane, select the **Disks** node.
4. On the **Disks** tab, record the number of drives that are accessible by Storage Center.
Compare this value to the number of drives accessible by the Storage Center after adding an expansion enclosure to the storage system.

Add an Expansion Enclosure to the A-side Chain

Connect the expansion enclosure to one chain at a time to maintain drive availability

1. Turn on the expansion enclosure being added. When the drives spin up, make sure that the front panel and power status LEDs show normal operation.
2. Disconnect the A-side cables (shown in orange) from the storage controllers. The storage system IO continues through the B-side cables.

- Disconnect the SAS cable from storage controller 1, port A
- Disconnect the SAS cable from storage controller 2, port B

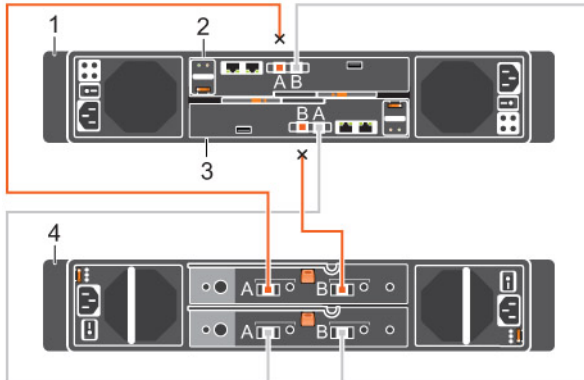

Figure 73. Disconnect A-Side Cables from the Storage Controllers

- | | |
|-------------------------|--------------------------|
| 1. Storage system | 2. Storage controller 1 |
| 3. Storage controller 2 | 4. Expansion enclosure 1 |
3. Move the cable from expansion enclosure 1: top EMM, port B to the new expansion enclosure (2): top EMM, port B.
 4. Use a new SAS cable to connect expansion enclosure 1: top EMM, port B to the new expansion enclosure (2): top EMM, port A.

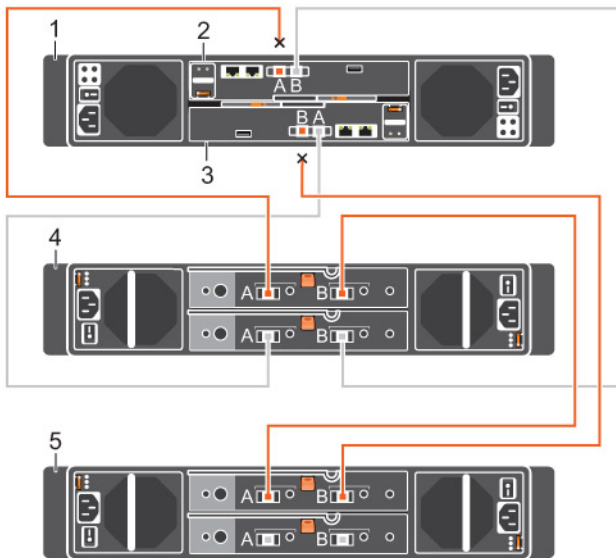

Figure 74. Connect A-Side Cables to the New Expansion Enclosure

- | | |
|--------------------------------|--------------------------|
| 1. Storage system | 2. Storage controller 1 |
| 3. Storage controller 2 | 4. Expansion enclosure 1 |
| 5. New expansion enclosure (2) | |
5. Reconnect the A-side cables to the storage controllers:
 - a. Reconnect expansion enclosure 1: top EMM, port A to storage controller 1: port A.

- b. Connect the new expansion enclosure (2): top EMM, port B to storage controller 2: port B.

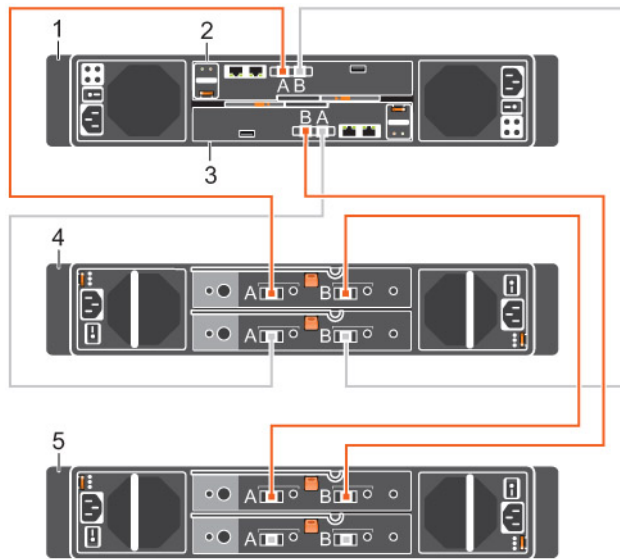

Figure 75. Reconnect A-side Cables to the Storage Controllers

- | | |
|--------------------------------|--------------------------|
| 1. Storage system | 2. Storage controller 1 |
| 3. Storage controller 2 | 4. Expansion enclosure 1 |
| 5. New expansion enclosure (2) | |

Add an Expansion Enclosure to the B-side Chain

Connect the expansion enclosure to one chain at a time to maintain drive availability.

1. Disconnect the B-side cables (shown in blue) from the storage controllers. The storage system IO continues through the A-side cables.
 - Disconnect the SAS cable from storage controller 1: port B.
 - Disconnect the SAS cable from storage controller 2, port A.

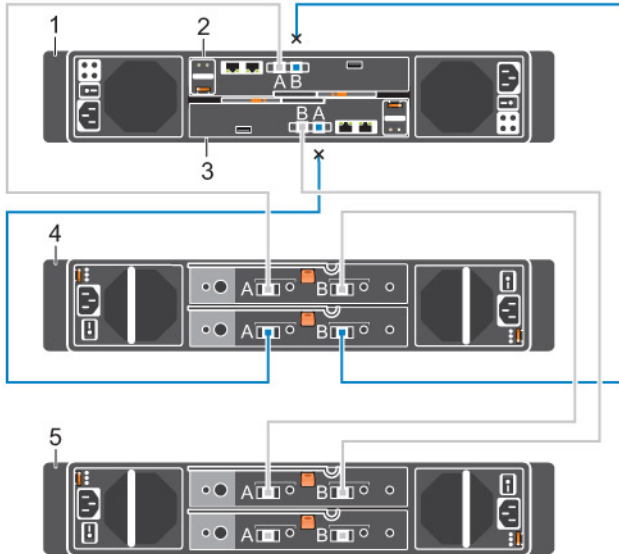

Figure 76. Disconnect B-Side Cables from the Storage Controllers

- | | |
|--------------------------------|--------------------------|
| 1. Storage system | 2. Storage controller 1 |
| 3. Storage controller 2 | 4. Expansion enclosure 1 |
| 5. New expansion enclosure (2) | |
2. Move the cable from expansion enclosure 1: bottom EMM, port B to the new expansion enclosure (2): bottom EMM, port B.
 3. Use a new SAS cable to connect expansion enclosure 1: bottom EMM, port B to the new expansion enclosure (2): bottom EMM, port A.

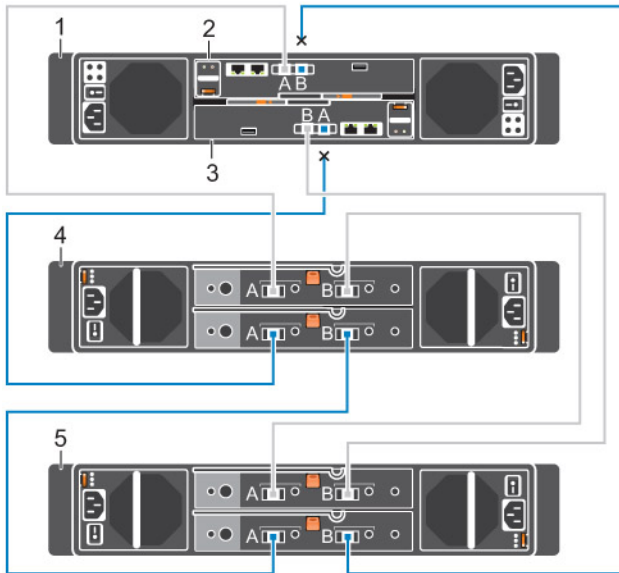

Figure 77. Connect B-Side Cables to the New Expansion Enclosure

- | | |
|-------------------|-------------------------|
| 1. Storage system | 2. Storage controller 1 |
|-------------------|-------------------------|

3. Storage controller 2
 4. Expansion enclosure 1
 5. New expansion enclosure (2)
4. Reconnect the A-side cables to the storage controllers:
- a. Reconnect expansion enclosure 1: bottom EMM, port A to storage controller 2: port A.
 - b. Connect the new expansion enclosure (2): bottom EMM, port B to storage controller 1: port B.

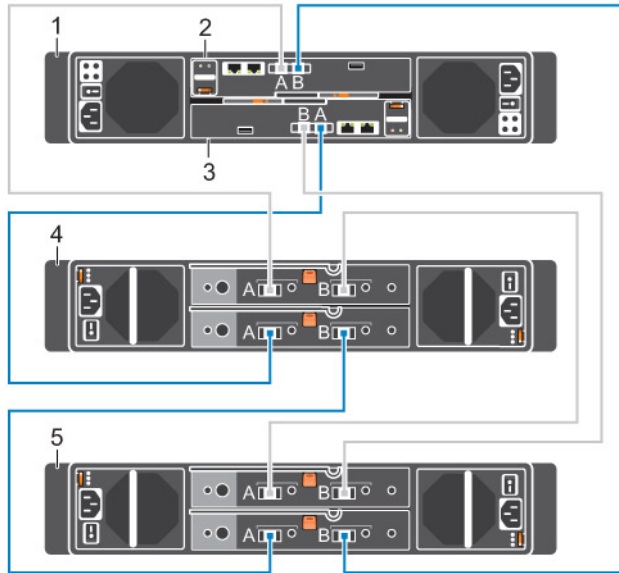

Figure 78. Reconnect B-Side Cables to the Storage Controllers

1. Storage system
2. Storage controller 1
3. Storage controller 2
4. Expansion enclosure 1
5. New expansion enclosure (2)

Label the Back-End Cables

Label the back-end cables that interconnect the storage controllers or label the back-end cables that connect the storage system to the expansion enclosures.

Prerequisites

Locate the pre-made cable labels provided with the expansion enclosures.

About this task

Apply cable labels to both ends of each SAS cable to indicate the chain number and side (A or B).

Steps

1. Starting with the top edge of the label, attach the label to the cable near the connector.

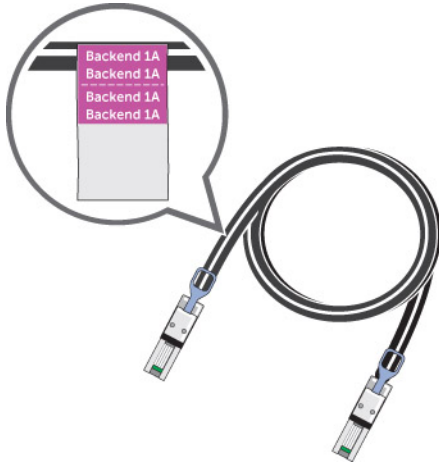

Figure 79. Attach Label to Cable

2. Wrap the label around the cable until it fully encircles the cable. The bottom of each label is clear so that it does not obscure the text.



Figure 80. Wrap Label Around Cable

3. Apply a matching label to the other end of the cable.

Removing an Expansion Enclosure from a Chain Currently in Service

To remove an expansion enclosure, disconnect the expansion enclosure from one side of the chain at a time.

About this task

During this process, one side of the chain is disconnected, and the Storage Center directs all IO to other the side of the chain, which remains connected.

⚠ CAUTION: Make sure that your data is backed up before removing an expansion enclosure.

Steps

1. Connect to the Storage Center using the Dell Storage Client.
2. Use the Dell Storage Client to release the disks in the expansion enclosure.
3. Select the expansion enclosure to remove and click **Remove Enclosure**. The **Remove Enclosure** wizard starts.
4. Confirm the details of your current install and click **Next** to validate the cabling.
5. Locate the expansion enclosure in the rack. Click **Next**.
6. Disconnect the A-side chain.
 - a. Disconnect the A-side cables that connect the expansion enclosure to the storage system. Click **Next**.
 - b. Reconnect the A side cables to exclude the expansion enclosure from the chain. Click **Next** to validate the cabling.
7. Disconnect the B-side chain.
 - a. Disconnect the B-side cables that connect the expansion enclosure to the storage system. Click **Next**.
 - b. Reconnect the B-side cables to exclude the expansion enclosure from the chain. Click **Next** to validate the cabling.
8. Click **Finish**.

Related Links

[Release the Disks in the Expansion Enclosure](#)

[Disconnect the A-Side Chain from the SC100/SC120 Expansion Enclosure](#)

[Disconnect the B-Side Chain from the SC100/SC120 Expansion Enclosure](#)

Release the Disks in the Expansion Enclosure

Use the Dell Storage Client to release the disks in an expansion enclosure before removing the expansion enclosure.

About this task

Releasing disks causes all of the data to move off the disks.



NOTE: Do not release disks unless the remaining disks have enough free space for the re-striped data.

Steps

1. Connect to the Storage Center using the Dell Storage Client.
2. Click the **Hardware** tab.
3. In the **Hardware** tab navigation pane, expand the enclosure to remove.
4. Select the **Disks** node.
5. Select all of the disks in the expansion enclosure.
6. Right-click on the selected disks and select **Release Disk**. The **Release Disk** dialog box appears.
7. Select **Perform RAID rebalance immediately**.
8. Click **OK**.

When all of the drives in the expansion enclosure are in the **Unassigned** disk folder, the expansion enclosure is safe to remove.

Disconnect the A-Side Chain from the SC100/SC120 Expansion Enclosure

Disconnect the A-side chain from the expansion enclosure that you want to remove.

About this task

CAUTION: To disconnect the A-side chain without a system outage, disconnect the A-side cable from storage controller 1 first. Disconnecting a different cable in the chain may disrupt IO to the expansion enclosure, resulting in a system outage.

Steps

1. Disconnect the A-side cable (shown in orange) between storage controller 1: port A and expansion enclosure 1: top EMM, port A.
2. In the Dell Storage Client, verify that the B-side ports on both storage controllers are **Up**. The B-side chain continues to carry IO while the A-side chain is disconnected.
3. Remove the A-side cable between expansion enclosure 1: top EMM, port B and expansion enclosure 2: top EMM, port A.

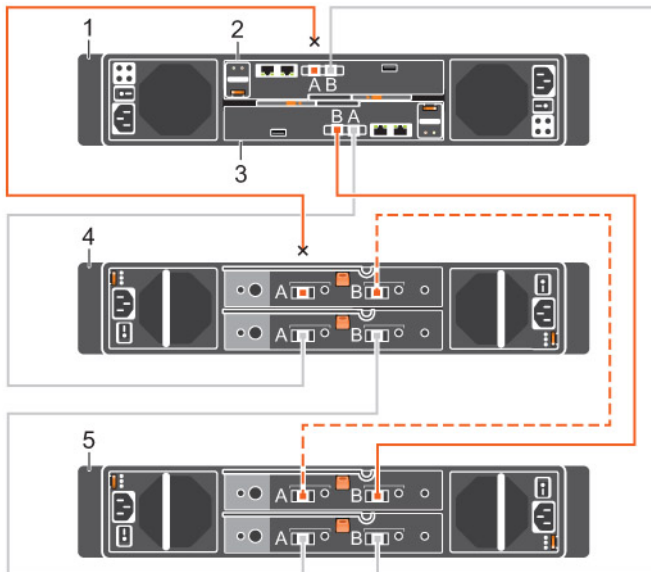

Figure 81. Disconnecting the SC100/SC120 Expansion Enclosure from the A-side Chain

1. Storage system
 2. Storage controller 1
 3. Storage controller 2
 4. Expansion enclosure 1
 5. Expansion enclosure 2
4. Reconnect the A-side cable to storage controller 1: port A.
 5. Connect the other end of the A-side cable to expansion enclosure 2: top EMM, port A.

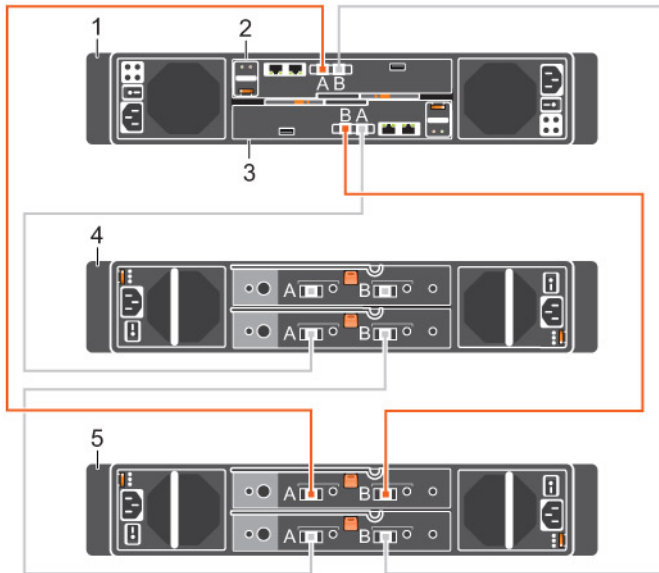

Figure 82. Reconnecting the A-side Chain

- | | |
|--------------------------|--------------------------|
| 1. Storage system | 2. Storage controller 1 |
| 3. Storage controller 2 | 4. Expansion enclosure 1 |
| 5. Expansion enclosure 2 | |

Disconnect the B-Side Chain from the SC100/SC120 Expansion Enclosure

Disconnect the B-side chain from the expansion enclosure that you want to remove.

About this task

CAUTION: To disconnect the B-side chain without a system outage, disconnect the B-side cable from storage controller 2 first. Disconnecting a different cable in the chain may disrupt IO to the expansion enclosure, resulting in a system outage.

Steps

1. Disconnect the B-side cable (shown in blue) between storage controller 2: port A and expansion enclosure 1: bottom EMM, port A.
2. In the Dell Storage Client, verify that the A-side ports on both storage controllers are **Up**. The A-side chain continues to carry IO while the B-side chain is disconnected.
3. Remove the B-side cable between expansion enclosure 1: bottom EMM, port B and expansion enclosure 2: bottom EMM, port A.

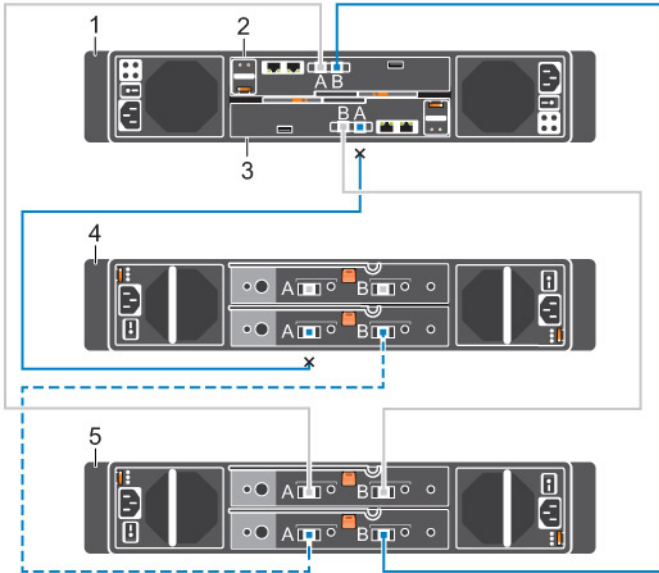

Figure 83. Disconnecting the SC100/SC120 Expansion Enclosure from the B-side Chain

- | | |
|--------------------------|--------------------------|
| 1. Storage system | 2. Storage controller 1 |
| 3. Storage controller 2 | 4. Expansion enclosure 1 |
| 5. Expansion enclosure 2 | |
4. Reconnect the B-side cable to storage controller 2: port A.
 5. Connect the other end of the B-side cable from to expansion enclosure 2: bottom EMM, port A.
- The expansion enclosure is now disconnected and can be removed.

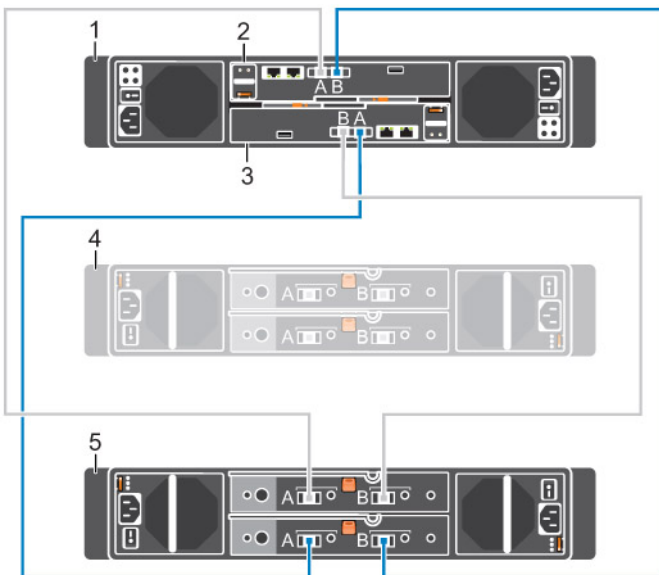

Figure 84. Expansion Enclosure Disconnected

- | | |
|-------------------|-------------------------|
| 1. Storage system | 2. Storage controller 1 |
|-------------------|-------------------------|

3. Storage controller 2
4. Disconnected expansion enclosure
5. Expansion enclosure 1

Troubleshooting Storage Center

This appendix contains troubleshooting steps for common Storage Center issues.

Troubleshooting Storage Controllers

Use these steps to troubleshoot storage controllers.

1. Check the status of the storage controller using the Dell Storage Client.
2. Check the pins and reseat the storage controller.
 - a. Remove the storage controller.
 - b. Verify that the pins on the storage system backplane and the storage controller are not bent.
 - c. Reinstall the storage controller.
3. Determine the status of the storage controller link status indicators. If the indicators are not green, check the cables.
 - a. Shut down the storage controller.
 - b. Reseat the cables on the storage controller.
 - c. Restart the storage controller.
 - d. Recheck the link status indicators. If the link status indicators are not green, replace the cables.

Troubleshooting Hard Drives

Use these steps to troubleshoot hard drives.

1. Check the status of the hard drive using the Dell Storage Client.
2. Determine the status of the hard drive indicators.
 - If the hard drive status indicator blinks amber on 2 seconds / off 1 second, the hard drive has failed.
 - If the hard drive status indicator is not lit, proceed to the next step.
3. Check the connectors and reseat the hard drive.
 - a. Remove the hard drive.
 - b. Check the hard drive and the backplane to ensure that the connectors are not damaged.
 - c. Reinstall the hard drive. Make sure the hard drive makes contact with the backplane.

Troubleshooting Expansion Enclosures

Use these steps to troubleshoot expansion enclosures.

1. Check the status of the expansion enclosure using the Dell Storage Client.
2. If an expansion enclosure and/or drives are missing in the Dell Storage Client, you may need to check for and install Storage Center updates to use the expansion enclosure and/or drives.
3. If an expansion enclosure firmware update fails, check the back-end cabling and ensure that redundant connections are used.

Free Manuals Download Website

<http://myh66.com>

<http://usermanuals.us>

<http://www.somanuals.com>

<http://www.4manuals.cc>

<http://www.manual-lib.com>

<http://www.404manual.com>

<http://www.luxmanual.com>

<http://aubethermostatmanual.com>

Golf course search by state

<http://golfingnear.com>

Email search by domain

<http://emailbydomain.com>

Auto manuals search

<http://auto.somanuals.com>

TV manuals search

<http://tv.somanuals.com>