

Dell™ Color Laser Printer 1320c User's Guide

[Dell Color Laser Printer 1320c User's Guide](#)

[Understanding Your Printer Software](#)

[Finding Information](#)

[Printing](#)

[About Your Printer](#)

[Setting Up for Shared Printing](#)

[Installing the Toner Cartridges and PHD \(Print Head Device\) Unit](#)

[Clearing Jams](#)

[Connecting Your Printer](#)

[Troubleshooting Guide](#)

[Dell Printer Configuration Web Tool](#)

[Installing Printer Drivers](#)

[Print Media Guidelines](#)

[Maintaining Your Printer](#)

[Loading Print Media](#)

[Printer Specifications](#)

[Operator Panel](#)

[Safety and Regulatory Information](#)

[Printer Settings](#)

[Appendix](#)

[Understanding Tool Box Menus](#)

Notes, Notices, and Cautions



NOTE: A **NOTE** indicates important information that helps you make better use of your printer.



NOTICE: A **NOTICE** indicates either potential damage to hardware or loss of data and tells you how to avoid the problem.



CAUTION: A **CAUTION** indicates a potential for property damage, personal injury, or death.

Information in this document is subject to change without notice.

© 2008 Dell Inc. All rights reserved.

Reproduction in any manner whatsoever without the written permission of Dell Inc. is strictly forbidden.

Dell, the DELL logo, Dell Precision, Dimension, Inspiron, Latitude, OptiPlex, PowerConnect, PowerEdge, PowerVault, and XPS are trademarks of Dell Inc.; Microsoft, Windows, Windows Server, and Windows Vista are either trademarks or registered trademarks of Microsoft Corporation in the United States and/or other countries; EMC is the registered trademark of EMC Corporation; ENERGY STAR is a registered trademark of the U.S. Environmental Protection Agency. As an ENERGY STAR Partner, Dell Inc. has determined that this product meets the ENERGY STAR guidelines for energy efficiency; Adobe and Photoshop are registered trademarks or trademarks of Adobe Systems Incorporated in the United States and/or other countries.

Other trademarks and trade names may be used in this document to refer to either the entities claiming the marks and names of their products. Dell Inc. disclaims any proprietary interest in trademarks and trade names other than its own.

UNITED STATES GOVERNMENT RESTRICTED RIGHTS

This software and documentation are provided with RESTRICTED RIGHTS. Use, duplication or disclosure by the Government is subject to restrictions as set forth in subparagraph (c)(1)(ii) of the Rights in Technical Data and Computer Software clause at DFARS 252.227-7013 and in applicable FAR provisions: Dell Inc., One Dell Way, Round Rock, Texas, 78682, USA.

This equipment has been tested and found to comply with the limits for a Class B digital device, pursuant to Part 15 of the FCC rules.

November 2008 Rev. A00

[back to contents page](#)

Dell™ Color Laser Printer 1320c User's Guide

Click the links on the left for information on the features, options, and operation of your printer. For information on other documentation included with your printer, see "[Finding Information](#)".

Front View

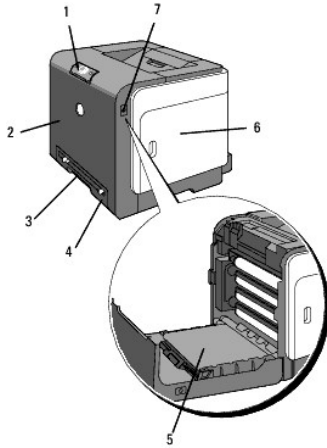

1	Operator panel	5	Belt unit
2	Front cover NOTE: You can open the front cover by pushing the button (right side).	6	Side cover (toner cartridges inside)
3	Single sheet feeder	7	Button (right side)
4	Tray 1		

Rear View

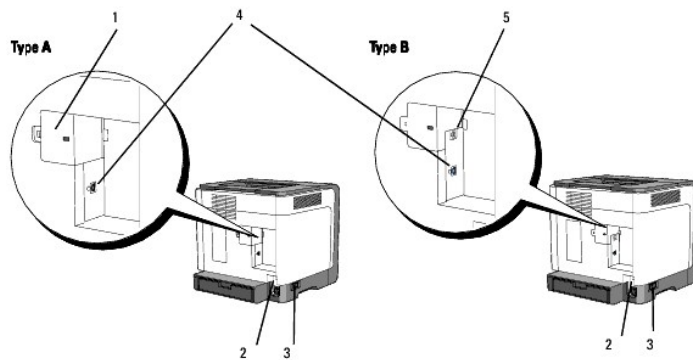

NOTE: You can use your network as standard, if your printer is type B as shown in the illustration.

1	Network cover	3	Power switch
2	Reset button	4	USB port

5	Ethernet port		
---	---------------	--	--

To order replacement toner cartridges or supplies from Dell:

1. Double-click the icon on your desktop.



2. Visit the Dell Printer Supplies website at www.dell.com/supplies, or order Dell printer supplies by phone.

For best service, have your Dell printer Service Tag available.

For help locating your Service Tag number, see "[Express Service Code and Service Tag number](#)."





[back to contents page](#)

[back to contents page](#)

Finding Information

 **NOTE:** The following are options you need to buy separately.

- n USB cable
- n Ethernet cable

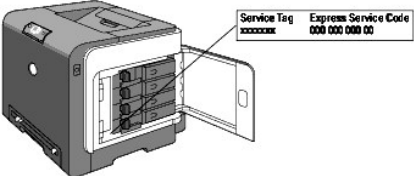
What are you looking for?	Find it here
Drivers for my printer My User's Guide	<p><i>Drivers and Utilities CD</i></p>  <p>The <i>Drivers and Utilities CD</i> contains documentation and drivers for your printer. You can use the CD to uninstall/reinstall drivers or access your documentation.</p> <p>Readme files may be included on your CD to provide last-minute updates about technical changes to your printer or advanced technical reference material for experienced users or technicians.</p>
Safety information How to use my printer Warranty information	<p><i>Owner's Manual</i></p>  <p>NOTE: The Owner's Manual may not be available in your country or region.</p>
Safety information Warranty information	<p><i>Product Information Guide</i></p>  <p>CAUTION: Read and follow all safety instructions in your <i>Product Information Guide</i> prior to setting up and operating your printer.</p>
How to set up my printer	<p><i>Setup diagram</i></p> 
Troubleshooting	<p>Troubleshooting Guide</p>
Express Service Code and Service Tag number	 <p>The Express Service Code and Service Tag numbers are located inside the side door of your printer.</p>
Latest drivers for my printer	See the Dell Support website at support.dell.com

Answers to technical service and support questions
Documentation for my printer

The Dell Support website, support.dell.com provides several online tools, including:
Solutions - Troubleshooting hints and tips, articles from technicians, and online courses
Upgrades - Upgrade information for components, such as printer driver
Customer Care - Contact information, order status, warranty, and repair information
Downloads - Drivers
Reference - Printer documentation and product specifications

You can access the Dell Support website at support.dell.com. Select your region on the support page, and fill in the requested details to access help tools and information.

[back to contents page](#)

[back to contents page](#)

About Your Printer

- [Operator Panel](#)
- [Protecting Your Printer](#)

The following illustrations show the standard Dell™ Color Laser Printer 1320c.

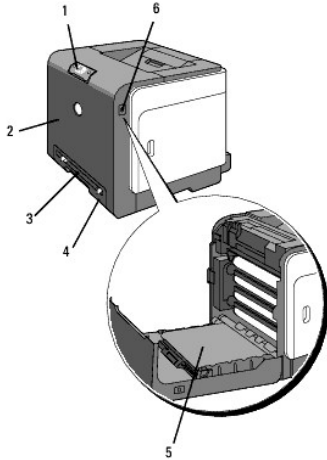

1	Operator panel	4	Tray 1
2	Front cover	5	Belt unit
3	Single sheet feeder	6	Button (right side)

Provide enough room to open the printer tray, covers, and option. It is also important to allow space around the printer for proper ventilation.

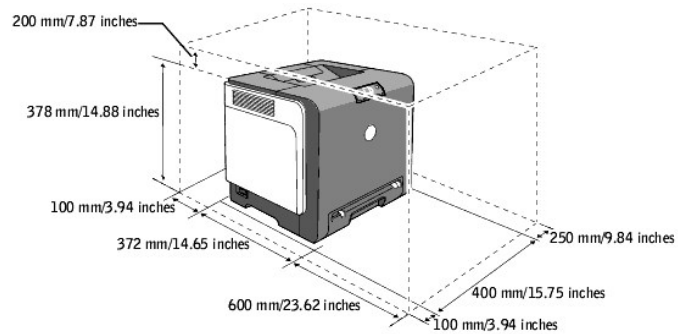

Operator Panel



For details on the operator panel, see "[Operator Panel](#)."

Protecting Your Printer

To protect your printer from theft, you can use the optional Kensington lock.

Attach the Kensington lock to the security slot of your printer.

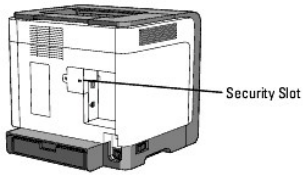

For details, see the operating instructions supplied with the Kensington lock.

[back to contents page](#)

[back to contents page](#)

Installing the Toner Cartridges and PHD (Print Head Device) Unit

• [Installing the Toner Cartridges](#)

• [Installing the PHD \(Print Head Device\) Unit](#)

- ⚠ **CAUTION:** Before performing any of the following procedures, read and follow the safety instructions in your *Product Information Guide*.
 - 👉 **NOTICE:** To protect the drums of the toner cartridges against bright light, close the front cover within three minutes. If the front cover remains open for more than three minutes, print quality may deteriorate.
 - 👉 **NOTICE:** Ensure that nothing touches or scratches the surface (black-colored film) of the belt unit. Scratches, dirt, or oil from your hands on the film of the belt unit may affect print quality.
-

Installing the Toner Cartridges

1. Open the side cover.

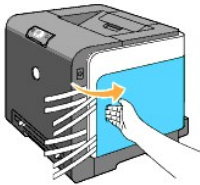

2. Completely pull out and remove the four ribbons.

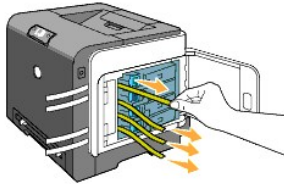

3. Press and slide the blue latches of four toner cartridges to the locked position.

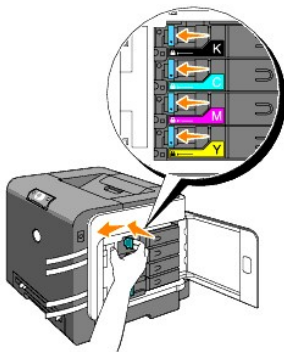

4. Close the side cover.



Installing the PHD (Print Head Device) Unit

1. Press the button (right side) and open the front cover.

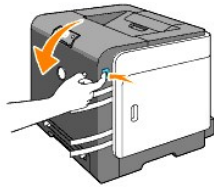

2. Turn the four PHD lock levers counterclockwise to unlock the unit.

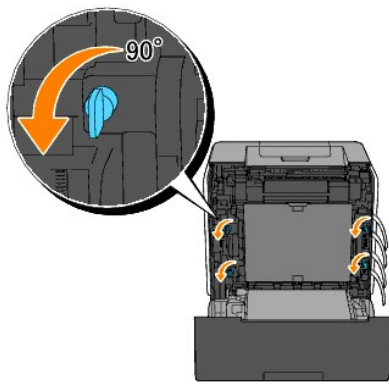

➔ **NOTICE:** Do not touch the belt unit.

3. Pull the PHD unit out of the printer.

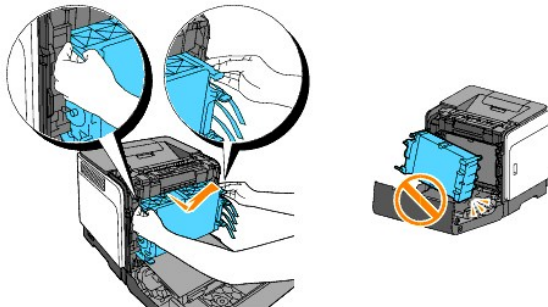

➔ **NOTICE:** Do not remove the protective sheet on the PHD unit.

4. Completely remove the four yellow ribbons from the PHD unit.

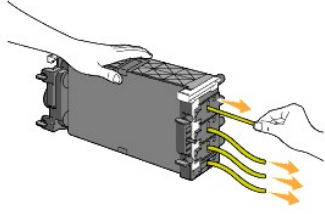

5. Use the small gray tabs to place the PHD unit back into the printer completely.

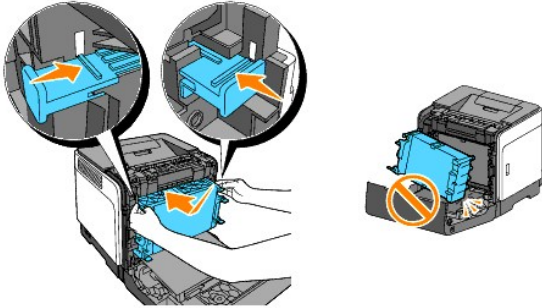

6. Turn the four PHD lock levers clockwise to lock the PHD, and then remove the protective sheet.

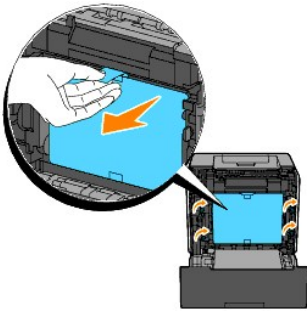

7. Close the front cover.



[back to contents page](#)

[back to contents page](#)

Connecting Your Printer

- [Choosing the Right Cable](#)
 - [Connecting the Printer Directly to a Computer](#)
 - [Turn On the Printer](#)
 - [Connecting the Printer to a Network](#)
 - [Using the Reset button](#)
-

Choosing the Right Cable



Your Dell™ Color Laser Printer 1320c interconnection cable must meet the following requirements:

Connection type	Connection specifications
USB	USB 2.0
Ethernet*	10 Base-T/100 Base-TX

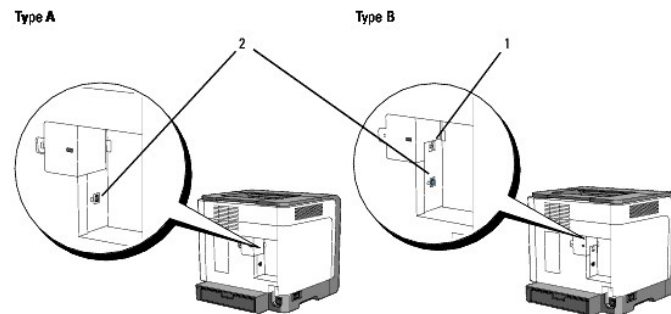
* If your printer is type A, an optional Network Adapter for Dell 1320c is required to connect the Ethernet cable.



NOTE: You can use your network as standard, if your printer is type B as shown in the illustration.

1	Ethernet port	
2	USB port	

Connecting the Printer Directly to a Computer

A local printer is a printer attached to your computer using a USB cable. If your printer is attached to a network instead of your computer, skip this section and go to "[Turn On the Printer.](#)"

Microsoft® Windows® 2000, Windows XP, Windows XP 64-bit Edition, Windows Server® 2003, Windows Server 2008, Windows Vista®, and Windows Vista 64-bit Edition support USB connections. See your computer operating system documentation to see if your system supports USB.

To attach the printer to a computer:

1. Ensure that the printer, computer, and any other attached devices are turned off and unplugged.
2. Connect the printer to the computer using a USB.

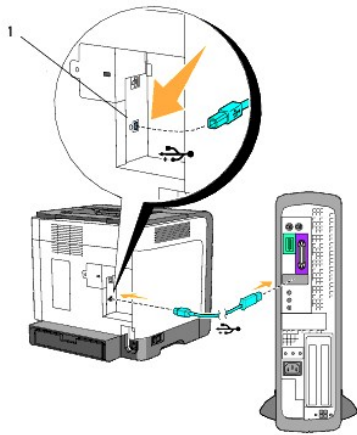

1 USB port

A USB port requires a USB cable. Ensure that you match the USB symbol on the cable to the USB symbol on the printer.

Plug the other end of the cable into a USB port on the back of the computer. For a USB cable, do not plug it into the USB keyboard.

Turn On the Printer

1. Connect the power cable to the printer and plug it into an electrical wall outlet.

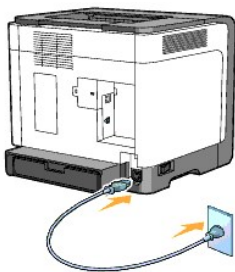

⚠ CAUTION: Do not use extension cords or power strips.

⚠ CAUTION: The printer should not be plugged into a UPS system.

2. Turn on the computer and the printer. When you use the USB cable, the USB driver is automatically installed.
-

Connecting the Printer to a Network

To attach the printer to a network:

NOTE: If your printer is type A, an optional Network Adapter for Dell 1320c is required to connect the Ethernet cable. In that case, follow the next 2 to 3 steps. Otherwise, proceed with step 4.

1. Ensure that the printer, computer, and any other attached devices are turned off and unplugged.
2. Remove the network cover.

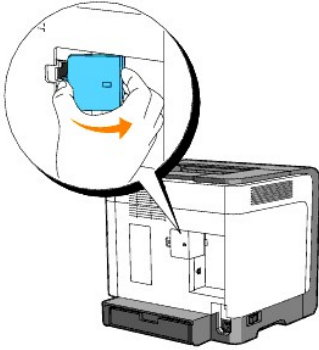

3. Insert the Network Adapter for Dell 1320c.

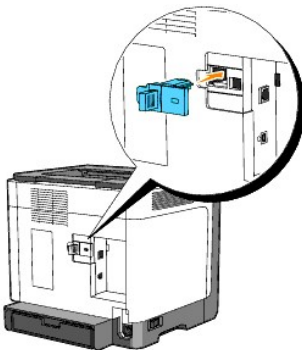

4. Connect the printer to the network using an Ethernet cable.

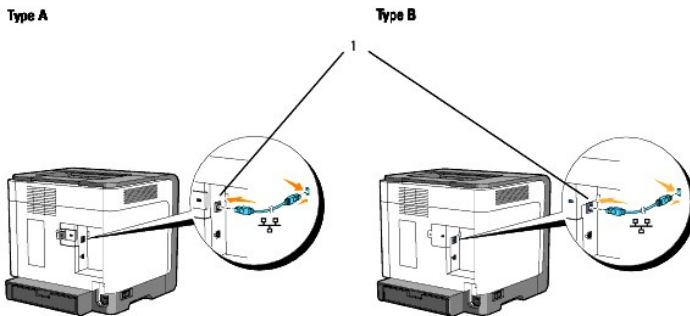

1 Ethernet port

To connect the printer to the network, plug one end of an Ethernet cable into the Ethernet port on the back of the printer, and the other end into a LAN drop or hub.

Turn On the Printer

1. Plug one end of the printer power cable into the socket at the back of the printer and the other end into a properly grounded outlet.

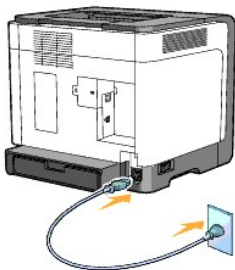

- ⚠ **CAUTION:** Do not use extension cords or power strips.
- ⚠ **CAUTION:** The printer should not be plugged into a UPS system.

2. Turn on the computer and the printer.

📌 **NOTE:** If your printer is type A, the LED of the Network Adapter for Dell 1320c lights.

Print and Check the Printer Settings Page

Print the Printer Settings page.

When the Ready/Data indicator lights (ready status), press and hold the Continue button on the printer's operator panel until the Ready/Data indicator blinks.

Advanced Functions

📌 **NOTE:** The following sections are considered advanced functions and should only be carried out by a system administrator. These sections assume you have already installed the Dell Color Laser Software on your PC.

1. Click **Start**→ **All Programs**→ **Dell Printers**→ **Additional Color Laser Software**→ **Status Monitor Console**.
The **Printer Selection** dialog box opens.
2. Click **Dell Color Laser 1320c** listed in Printer Name.
The **Dell Color Laser 1320c Launcher** window opens.
3. Click the **Tool Box** button.
The **Tool Box** opens.
You can also launch the Tool Box from the printer icon on the taskbar.
4. Click the **Printer Settings Report** tab.
5. Select **Reports** from the list at the left side of the page.
The Reports page is displayed.

Assign an IP Address

An IP address is a unique number that consists of four sections that are delimited by a period and can include up to three digits in each section, for example, 111.222.33.44.

Assigning an IP address already in use can cause network performance issues.

📌 **NOTE:** Assigning an IP address is considered as an advanced function and is normally done by a system administrator.

1. Click **Start**→ **All Programs**→ **Dell Printers**→ **Additional Color Laser Software**→ **Status Monitor Console**.
The **Printer Selection** dialog box opens.
2. Click **Dell Color Laser 1320c** listed in Printer Name.
The **Dell Color Laser 1320c Launcher** window opens.
3. Click the **Tool Box** button.
The **Tool Box** opens.
You can also launch the Tool Box from the printer icon on the taskbar.
4. Click the **Printer Maintenance** tab.

5. Select TCP/IP Settings from the list at the left side of the page. The **TCP/IP Settings** page is displayed.
6. Select the mode from IP Address Mode, and then enter the values in IP Address, Subnet Mask, and Gateway Address.
7. Press the **Apply New Settings** button to take effect.

You can also assign the IP address to the printer when installing the printer drivers with installer. When you use the **Network Installation** feature, you can set the IP address from 0.0.0.0 to the desired IP address on the printer selection window.

Verify the IP Settings

1. Print another Printer Settings page.
2. Look under the **TCP/IP** heading on the Printer Settings page to ensure that the IP address, netmask, and gateway are what you expected.

or

Ping the printer and verify that it responds. For example, at a command prompt on a network computer, type ping followed by the new printer IP address (for example, 192.168.0.11):

```
ping 192.168.0.11
```

If the printer is active on the network, you will receive a reply.

Using the Reset button

Your printer is supplied with an electric leakage detector, which prevents electric shock or fire due to electric leakage by automatically cutting circuits inside the printer.

When electric leakage is detected, the **Reset** button is tripped. In this case, press the **Reset** button to turn the printer back on. If the **Reset** button is tripped again after you press the **Reset** button, contact Dell.

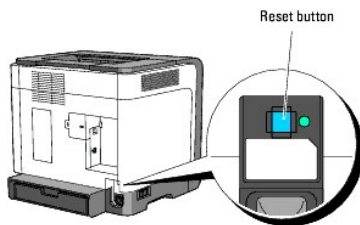

Check whether or not the electric leakage detector is functioning at least once a month by following the steps below:

1. Turn on the printer, and then press the **Test** button.
 1. If the **Reset** button is tripped and the printer is turned off, the electric leakage detector functions correctly. Press the **Reset** button to turn the printer back on.
 1. If the **Reset** button is not tripped, contact Dell. Do not continue to use the printer if the electric leakage detector is not functioning.

[back to contents page](#)

[back to contents page](#)

Dell Printer Configuration Web Tool

Using the Dell Printer Configuration Web Tool

NOTE: This web tool is not available unless the printer is connected using a network cable.

One of the features of the **Dell™ Printer Configuration Web Tool** is E-Mail Alert Setup, which sends an e-mail to you or the key operator when the printer needs supplies or intervention.

To fill out printer inventory reports requiring the asset tag number of all the printers in your area, use the **Printer Information** feature in the **Dell Printer Configuration Web Tool**. Just type the IP address of each printer on the network to display the asset tag number.

The screenshot shows a Microsoft Internet Explorer browser window displaying the Dell Printer Configuration Web Tool for a Dell Color Laser 1320c printer. The address bar shows the URL: <http://172.31.0.15/ews/index.htm>. The page features a left-hand navigation menu with the following items: Printer Status, Printer Jobs, Printer Settings, Print Server Settings, Copy Printer Settings, Print Volume, Printer Information, E-Mail Alert, Set Password, Online Help, Order Supplies at: www.dell.com/supplies, and Contact Dell Support at: support.dell.com. The main content area displays the printer's status, including the IP Address (172.31.0.15), Location, and Contact Person. Below this, there is a 'Printer Status' section with a 'Refresh' button. The status section shows the following cartridge levels: Cyan Cartridge Level ~ 100 %, Magenta Cartridge Level ~ 80 %, Yellow Cartridge Level ~ 100 %, and Black Cartridge Level ~ 100 %. At the bottom, there is a table for Paper Trays:

Paper Trays:	Status:	Capacity:	Size:
Single Sheet Feeder (Manual)	Add Paper	1 sheets	--
Tray 1	OK	250 sheets	--

The **Dell Printer Configuration Web Tool** feature also allows you to change the printer settings and keep track of printing trends. If you are a network administrator, you can easily copy the printer settings to one or all printers on the network using your Web browser.

To launch the **Dell Printer Configuration Web Tool**, type your network printer's IP address in your Web browser.

If you do not know the IP address of your printer, print a printer settings page, which lists the IP address:

1. Click **Start**→ **All Programs**→ **Dell Printers**→ **Additional Color Laser Software**→ **Status Monitor Console**. The **Printer Selection** dialog box opens.

2. Click **Dell Color Laser 1320c** listed in Printer Name.
The **Dell Color Laser 1320c Launcher** window opens.
3. Click the **Tool Box** button.
The **Tool Box** opens.
You can also launch the **Tool Box** from the printer icon on the taskbar.
4. Click the **Printer Maintenance** tab.
5. Select EWS (Embedded Web Server or Dell Printer Configuration Web Tool) from the list on the left side of the page.
The EWS page is displayed.
6. Press the **Print Server Settings** button.
The printer settings page is printed.

If the IP address shows 0.0.0.0 (the factory default), an IP address has not been assigned. To assign one for your printer, see "[Assign an IP Address.](#)"

Use the **Dell Printer Configuration Web Tool** for:

Printer Status

Use the **Printer Status** menu to get immediate feedback on printer supply status. When toner cartridge is running low, click the order supplies link on the first screen to order additional toner cartridges.

Printer Jobs

Use the **Printer Jobs** menu to contain information on **Job List** page and **Completed Jobs** page. These pages show the details of the status regarding each protocol or the print jobs.

Printer Settings

Use the **Printer Settings** menu to change printer settings and view the settings in the Tool Box remotely.

Print Server Settings

Using the **Print Server Settings** menu, you can change the type of printer interface and necessary conditions for communications.

Copy Printer Settings

Use the **Copy Printer Settings** menu to copy the printer's settings to another printer or printers on the network just by typing each printer's IP address.

 **NOTE:** You must log in as an administrator to use this feature.

Print Volume

Use the **Print Volume** option to check the histories of printing, such as paper usage and types of jobs being printed, and limit which users use the color mode and the maximum number of pages they can print.

Printer Information

Use the **Printer Information** menu to get the information on service calls, inventory reports, or the status of current memory and engine code levels.

E-Mail Alert

Use the **E-Mail Alert** menu to receive an e-mail when the printer needs supplies or intervention. Type your name or the key operator's name in the e-mail list box to be notified.

Set Password

Use the **Set Password** menu to lock the Dell Printer Configuration Web Tool with a password so that other users do not inadvertently change the printer settings you selected.

 **NOTE:** You must log in as an administrator to use this feature.

Online Help

Click **Online Help** to visit the Dell Support website, and see the *User's Guide* on that page to verify configured settings.

Order Supplies at:

www.dell.com/supplies

Contact Dell Support at:

support.dell.com

Using the Dell Printer Configuration Web Tool

Ensure that you activate JavaScript in your browser before using the **Dell Printer Configuration Web Tool**.

Environment Settings for Web Browsers

Dell recommends configuring the environment settings for your Web browsers, before using the Dell Printer Configuration Web Tool.

 **NOTE:** The Dell Printer Configuration Web Tool pages may be displayed unreadable if the pages were configured by the different language with your browser's.

For Internet Explorer® 6.0 or Internet Explorer 7.0:

Setting Up the Display Language

1. Select **Internet Options** from **Tools** on the menu bar.
2. Select **Languages** in the **General** tab.
3. Specify the display language in order of preference in the **Language in order of preference** list.

For example:

Italian (Italy) [it]
Spanish (Traditional Sort) [es]
German (Germany) [de]
French (France) [fr]
English [en] or English (United States) [en-us]

Setting the Printer's IP Address to Non-Proxy

1. Select **Internet Options** from the **Tools** menu.
2. Select **Proxy server** under **LAN Settings** in the **Connections** tab.
3. Do either of the following:
 - 1 Clear the **Use a proxy sever for your LAN** check box.
 - 1 Click **Advanced**, and then specify the printer's IP address in the **Do not use proxy server for addresses beginning with** field under **Exceptions**.

After setting the language and proxy, type <http://nnn.nnn.nnn.nnn/> (the printer's IP address) in the URL entry field of the browser to activate the **Dell Printer Configuration Web Tool**.

For Firefox 1.5 or Later:

Setting Up the Display Language

1. Select **Options** from the **Tools** menu.
2. Click **Advanced**.

3. Click **Edit Languages** in the **General** tab.
4. Specify the display language in order of preference in the **Languages in order of preference** list.

For example:

English [en] or English/United States [en-us]
 Italian [it]
 Spanish [es]
 German [de]
 French [fr]
 Dutch [nl]
 Norwegian [no]
 Swedish [sv]

Setting the Printer's IP Address to Non-Proxy

1. Select **Options** from the **Tools** menu.
2. Click **General** on the **Options** dialog box.
3. Click **Connection Settings**→ **Connection Settings**.
4. Do one of the following:
 1. Select the **Direct connection to the Internet** check box.
 1. Select the **Auto-detect proxy settings for this network** check box.
 1. Select the **Manual proxy configuration** check box, and then enter the printer's IP address in the **No Proxy for** edit box.
 1. Select the **Automatic proxy configuration URL** check box.

After setting the language and proxy, type <http://nnn.nnn.nnn.nnn/> (the printer's IP address) in the URL entry field of the browser to activate the **Dell Printer Configuration Web Tool**.

Page Display Format

The layout of the page is divided into three sections mentioned below:

Top Frame

The Top Frame is located at the top of all pages. When **Dell Printer Configuration Web Tool** is activated, the current status and specifications of the printer are displayed in the Top Frame on every page.

The following items are displayed in the Top Frame.

Dell Color Laser 1320c	Displays the printer product name.
IP Address	Displays the printer's IP address.
Location	Displays the printer's location. The location can be changed in Basic Information on the Print Server Settings page.
Contact Person	Displays the printer's administrator's name. The name can be changed in the Basic Information on the Print Server Settings page.
Printer Console	Displays the status of the printer settings and indicators and automatically refreshes at the set interval. The interval can be changed in the Basic Information on Print Server Settings page.
Help	Links to the Dell web page. See the <i>User's Guide</i> on the Dell Support website, support.dell.com for help on this product.
Printer Bitmap	Shows the printer bitmap. The Printer Status menu appears in the Right Frame by clicking the bitmap.

Left Frame

The Left Frame is located at the left side of all pages. The menu titles displayed in the Left Frame are linked to corresponding menus and pages. You can go to the corresponding page by clicking their characters.

The following menus are displayed in the Left Frame.

Printer Status	Links to the Printer Status menu.
-----------------------	--

Printer Jobs	Links to the Printer Jobs menu.
Printer Settings	Links to the Printer Settings Report menu.
Print Server Settings	Links to the Print Server Reports menu.
Copy Printer Settings	Links to the Copy Printer Settings menu.
Print Volume	Links to the Print Volume menu
Printer Information	Links to the Printer Status menu.
E-Mail Alert	Links to the Print Server Settings menu.
Set Password	Links to the Other Features menu.
Online Help	Links to the Dell Support website. See the <i>User's Guide</i> on that page.
Order Supplies at:	Links to the Dell web page.
Contact Dell Support at:	Links to the Dell support page web address: support.dell.com/

Right Frame

The Right Frame is located at the right side of all pages. The contents of the Right Frame correspond to the menu that you select in the Left Frame. For details on the items displayed in the Right Frame, see "[Details of Menu Items](#)."

Buttons on the Right Frame

Refresh Button	Receives the current printer configuration and updates the latest information in the Right Frame.
Apply New Settings Button	Submits new settings made on the Dell Printer Configuration Web Tool to the printer. The old printer settings will be replaced by the new settings.
Restart printer to apply new settings Button	Submits new settings made on the Dell Printer Configuration Web Tool to the printer and reboots the printer. The old printer settings will be replaced by the new settings.
Restore Settings Button	Restores the old settings from before changes made. New settings will not be submitted to the printer.

Changing the Settings of Menu Items

Some menus allow you to change the printer settings through the **Dell Printer Configuration Web Tool**. When you are accessing these menus, the authentication dialog appears on the screen. Type a user name and password for the printer's administrator by following the prompts displayed in the dialog box.

The default user name is **admin**, and the default password is left blank (NULL). You can change only the password in the **Set Password** page in the **Print Server Settings** menu. The user name cannot be changed. See "[Set Password](#)" for more information.

Details of Menu Items

Printer Status	Printer Status
	Printer Events
	Printer Information
Printer Jobs	Job List
	Completed Jobs
Printer Settings	Printer Settings Report
	Menu Settings
	Reports
	Printer Settings
	System Settings
	Printer Maintenance
	Paper Density
	Adjust BTR (Bias Transfer Roll)
Adjust Fuser	
	Auto Registration Adjustment
	Color Registration Adjustments

		Adjust Altitude
		Reset Defaults
		Non-Dell Toner
		Initialize PrintMeter
		Web Link Customization
Print Server Settings	Print Server Reports	Print Server Setup Page
		E-Mail Alert Setup Page
	Print Server Settings	Basic Information
		Port Settings
		TCP/IP
		E-Mail Alert
		SNMP (Simple Network Management Protocol)
	Other Features	Set Password
		Reset Print Server
Copy Printer Settings	Copy Printer Settings	
	Copy Printer Settings Report	
Print Volume	Print Volume	
	Dell ColorTrack	

Printer Status

Use the **Printer Status** menu to check the status of consumables, hardware, and specifications of the printer.

The following pages are displayed in the **Printer Status** menu.

Printer Status

Purpose:

To check the status of remaining consumables and trays.

Values:

Cyan Cartridge Level Magenta Cartridge Level Yellow Cartridge Level Black Cartridge Level		Displays the percentage of toner remaining in each toner cartridge. When a cartridge is empty, a message appears. The text <i>Print Cartridge</i> is linked to the Dell Printer Supplies website, www.dell.com/supplies .	
Paper Trays	Status	OK	Indicates that there is some paper in the tray but the quantity is unknown.
		Add Paper	Indicates that there is no paper in the tray.
	Capacity	Displays the maximum capacity of the paper tray.	
	Size	Not available for this printer.	
Output Tray	Status	OK	Indicates that the tray is available.
		Capacity	Displays the maximum capacity of the paper tray.
Cover	Status	Closed	Indicates that the cover is closed.
		Open	Indicates that the cover is open.
Printer Type		Displays the type of printing for the printer. Color Laser is displayed normally.	
Printing Speed		Displays the printing speed for the printer.	

Printer Events

Purpose:

When printer errors occur such as *running out of paper* or *running out of toner cartridge*, the details of all alerts or indications of errors are displayed in the **Printer Events** page.

Values:

Location	Displays the location where the printer error occurred.
Details	Displays the details of the printer fault.

Printer Information

Purpose:

To verify the printer details such as hardware configuration and software version. This page can also be displayed by clicking **Printer Information** in the Left Frame.

Values:

Dell Service Tag Number	Displays Dell's service tag number.	
Asset Tag Number	Displays the printer's asset tag number.	
Printer Serial Number	Displays the printer's serial number.	
Memory Capacity	Displays the memory capacity.	
Processor Speed	Displays the processing speed.	
Printer Revision Levels	Firmware Version	Displays the revision date (revision level).
	Network Firmware Version	Displays the revision date (revision level).

Printer Jobs

The **Printer Jobs** menu contains information on the **Job List** and **Completed Jobs** pages. These pages show the details of the status regarding each protocol or the print jobs.

Job List

Purpose:

To confirm the print jobs that are being processed. Click **Refresh** to update the screen.

Values:

ID	Displays the job id.
Job Name	Displays the file name of the job being printed.
Owner	Displays the job owner's name.
Host Name	Displays the name of the host computer.
Job Status	Displays the status of the job being printed.
Host I /F	Displays the status of the host interface.
Job Submitted Time	Displays the date the print job was submitted.

Completed Jobs

Purpose:

To check the completed print jobs. Up to the last 22 print jobs are displayed. Click **Refresh** to update the screen.

Values:

ID	Displays the job ID.
Job Name	Displays the file name of the completed print job.
Owner	Displays the job owner's name.
Host Name	Displays the name of the host computer.
Output Result	Displays the status of completed print jobs.
Impression Number	Displays the number of pages in the print job.
No. of Sheets	Displays the number of sheets in the print job.
Host I/F	Displays the status of the host interface.
Job Submitted Time	Displays the date the print job was submitted.

Printer Settings

Use the **Printer Settings** menu to display the printer settings report and to configure printer settings.

The following tabbed pages are displayed at the top of the Right Frame.

Printer Settings Report

The **Printer Settings Report** tab includes the **Menu Settings** and **Reports** pages.

Menu Settings

Purpose:

To display the current settings of the printer.

Values:

System Settings	Power Saver Timer Mode 1	Displays the amount of time before the printer enters the power saver timer mode 1 after it finishes a print job.
	Power Saver Timer Mode 2	Displays the amount of time before the printer enters the power saver timer mode 2 after it finishes a print job.
	Control Panel Tone	Displays whether the printer sounds the tone for the panel.
	Machine Ready Tone	Displays whether the printer sounds the tone when the machine becomes ready.
	Job Complete Tone	Displays whether the printer sounds the tone when a job is completed.
	Fault Tone	Displays whether the printer sounds the tone when an error occurs.
	Alert Tone	Displays whether the printer sounds an alarm when an error occurs.
	Out of Paper Alert Tone	Displays whether the printer sounds the tone when the paper runs out.

	Low Toner Alert Tone	Displays whether the printer sounds the tone when the toner is low.	
	Time-Out	Displays the amount of time the printer waits to receive additional bytes of data from the computer.	
	Device Language	Displays the language to be used for E-mail Alert.	
	Auto Log Print	Displays whether the printer outputs logs automatically.	
Paper Density	Plain	Light	Displays the paper density in Light for the plain paper.
		Normal*	Displays the paper density in Normal for the plain paper.
	Label	Light	Displays the paper density in Light for the label.
		Normal*	Displays the paper density in Normal for the label.
Adjust BTR	Plain	Displays the voltage settings of the transfer roller (-6-6) for plain paper. The default is 0.	
	Plain Thick	Displays the voltage settings of the transfer roller (-6-6) for thick plain paper. The default is 0.	
	Covers	Displays the voltage settings of the transfer roller (-6-6) for cover paper. The default is 0.	
	Covers Thick	Displays the voltage settings of the transfer roller (-6-6) for thick cover paper. The default is 0.	
	Label	Displays the voltage settings of the transfer roller (-6-6) for labels. The default is 0.	
	Coated	Displays the voltage settings of the transfer roller (-6-6) for coated paper. The default is 0.	
	Coated Thick	Displays the voltage settings of the transfer roller (-6-6) for thick coated paper. The default is 0.	
	Envelope	Displays the voltage settings of the transfer roller (-6-6) for envelopes. The default is 0.	
	Recycled	Displays the voltage settings of the transfer roller (-6-6) for recycled paper. The default is 0.	
	Coated JPN	Displays the voltage settings of the transfer roller (-6-6) for Japanese coated paper. The default is 0.	
	Postcard JPN	Displays the voltage settings of the transfer roller (-6-6) for Japanese postcards. The default is 0.	
Adjust Fuser	Plain	Displays the temperature settings of the fuser (-2-2) for plain paper. The default is 0.	
	Plain Thick	Displays the temperature settings of the fuser (-2-2) for thick plain paper. The default is 0.	
	Covers	Displays the temperature settings of the fuser (-2-2) for cover paper. The default is 0.	
	Covers Thick	Displays the temperature settings of the fuser (-2-2) for thick cover paper. The default is 0.	
	Label	Displays the temperature settings of the fuser (-2-2) for labels. The default is 0.	
	Coated	Displays the temperature settings of the fuser (-2-2) for coated paper. The default is 0.	
	Coated Thick	Displays the temperature settings of the fuser (-2-2) for thick coated paper. The default is 0.	
	Envelope	Displays the temperature settings of the fuser (-2-2) for envelopes. The default is 0.	
	Recycled	Displays the temperature settings of the fuser (-2-2) for recycled paper. The default is 0.	
	Coated JPN	Displays the temperature settings of the fuser (-2-2) for Japanese coated paper. The default is 0.	
	Postcard JPN	Displays the temperature settings of the fuser (-2-2) for Japanese postcards. The default is 0.	
Auto Registration Adjustment	Auto Registration Adjustment	Displays whether to adjust the registration automatically.	
Adjust Altitude	Adjust Altitude	Displays whether to adjust the height of the installation location of the printer.	
Non-Dell Toner	Non-Dell Toner	Displays whether to use a refilled toner cartridge.	
Web Link Customization	Select Reorder URL	Regular*	Displays the URL (accessories.us.dell.com/sna) that can be linked from Order Supplies at in the left frame.
		Premier	Displays the URL (premier.dell.com) that can be linked from Order Supplies at in the left frame.

Reports

Purpose:

To print various types of reports and lists.

Values:

Printer Settings	Click the Start button to print the printer settings page.
Device Settings	Click the Start button to print the device settings page.

Job History	Click the Start button to print the job history report.
Error History	Click the Start button to print the error history report.
Color Test Page	Click the Start button to print the color test page.

Printer Settings

The **Printer Settings** tab includes **System Settings** page.

System Settings

Purpose:

To configure the basic printer settings.

Values:

Power Saver Timer Mode 1	Displays the amount of time before the printer enters the power saver timer mode 1 after it finishes a print job.
Power Saver Timer Mode 2	Displays the amount of time before the printer enters the power saver timer mode 2 after it finishes a print job.
Control Panel Tone	Displays whether the printer sounds the tone for the panel.
Machine Ready Tone	Displays whether the printer sounds the tone when the machine becomes ready.
Job Complete Tone	Displays whether the printer sounds the tone when a job is completed.
Fault Tone	Displays whether the printer sounds the tone when an error occurs.
Alert Tone	Specifies whether the printer sounds an alarm when an error occurs.
Out of Paper Alert Tone	Displays whether the printer sounds the tone when the paper runs out.
Low Toner Alert Tone	Displays whether the printer sounds the tone when the toner is low.
Time-Out	Specifies the amount of time the printer waits to receive additional bytes of data from the computer. When this timeout expires, the print job is canceled.
Device Language	Determine the language to be used for E-mail Alert.
Auto Log Print	Specifies whether the printer outputs logs automatically.

Printer Maintenance

The **Printer Maintenance** tab includes **Paper Density**, **Adjust BTR**, **Adjust Fuser**, **Auto Registration Adjustment**, **Color Registration Adjustments**, **Adjust Altitude**, **Reset Defaults**, **Non-Dell Toner**, **Initialize PrintMeter**, and **Web Link Customization** pages.

Paper Density

Purpose:

To specify the paper density.

Values:

Plain	Light	Sets the paper density in Light for the plain paper.
	Normal	Sets the paper density in Normal for the plain paper.

Label	Light	Sets the paper density in Light for the label.
	Normal	Sets the paper density in Normal for the label.

Adjust BTR

Purpose:

To specify the reference voltage settings for the transfer roller.

Values:

Plain	Sets the reference voltage settings for the transfer roller for plain paper.
Plain Thick	Sets the reference voltage settings for the transfer roller for thick plain paper.
Covers	Sets the reference voltage settings for the transfer roller for cover paper.
Covers Thick	Sets the reference voltage settings for the transfer roller for thick cover paper.
Label	Sets the reference voltage settings for the transfer roller for labels.
Coated	Sets the reference voltage settings for the transfer roller for coated paper.
Coated Thick	Sets the reference voltage settings for the transfer roller for thick coated paper.
Envelope	Sets the reference voltage settings for the transfer roller for envelopes.
Recycled	Sets the reference voltage settings for the transfer roller for recycled paper.
Coated JPN	Sets the reference voltage settings for the transfer roller for Japanese coated paper.
Postcard JPN	Sets the reference voltage settings for the transfer roller for Japanese postcards.

Adjust Fuser

Purpose:

To specify the temperature settings value for the fuser.

Values:

Plain	Sets the temperature settings for the fuser for plain paper.
Plain Thick	Sets the temperature settings for the fuser for thick plain paper.
Covers	Sets the temperature settings for the fuser for cover paper.
Covers Thick	Sets the temperature settings for the fuser for thick cover paper.
Label	Sets the temperature settings for the fuser for labels.
Coated	Sets the temperature settings for the fuser for coated paper.
Coated Thick	Sets the temperature settings for the fuser for thick coated paper.
Envelope	Sets the temperature settings for the fuser for envelopes.
Recycled	Sets the temperature settings for the fuser for recycled paper.
Coated JPN	Sets the temperature settings for the fuser for Japanese coated paper.
Postcard JPN	Sets the temperature settings for the fuser for Japanese postcards.

Auto Registration Adjustment

Purpose:

Specifies whether to adjust the color registration automatically.

Values:

Auto Registration Adjustment	Specifies whether to adjust the color registration automatically.
-------------------------------------	---

Color Registration Adjustments

Purpose:

To print the color registration chart and to adjust the color registration by using the chart.

This function is required after the printer is set up or moved.

Values:

Auto Correct		Click Start to adjust color registration automatically.
Color Regi Chart		Click Start to print the color registration chart.
1 (Lateral) - Enter Number	Yellow	Specifies the values for lateral that are found in the color registration chart.
	Magenta	
	Cyan	
2 (Process) - Enter Number	Yellow	Specifies the values for process that are found in the color registration chart.
	Magenta	
	Cyan	

Adjust Altitude

Purpose:

To adjust the height of the installation location of the printer.

Values:

0 meter	Select the value close to the height of the installation location of the printer.
1000 meters	
2000 meters	
3000 meters	

Reset Defaults

Purpose:

To initialize the non-volatile memory (NVM). After executing this function and rebooting the printer, all the menu parameters are reset to their default values.

Values:

Reset Defaults and restart printer	Click Start to initialize the non-volatile memory (NVM) memory.
------------------------------------	--

Non-Dell Toner

Purpose:

Specifies whether to use the refilled toner cartridge or not. When this setting is on, you can use toner cartridges provided by other companies.

Values:

Non-Dell Toner	Overrides factory toner cartridge setting. Using non-Dell-brand toner cartridges may make some printer features unusable, reduce print quality and decrease the reliability of your printer. Dell recommends only new Dell-brand toner cartridges for your printer. Dell does not provide warranty coverage for problems caused by using accessories, parts, or components not supplied by Dell. Using "Copy Printer Settings" will not copy the settings to another printer.
-----------------------	---

Initialize PrintMeter

Purpose:

To initialize the data for the print meter. After executing this function to automatically restart the printer, the value of the meter resets to 0.

Values:

Initialize PrintMeter	Click Start to initialize the print meter.
-----------------------	---

Web Link Customization

Purpose:

To configure the link used for ordering supplies.

Values:

Select Reorder URL	Specifies the URL that Order Supplies at links to in the left frame.
Regular	accessories.us.dell.com/sna

Premier	premier.dell.com
---------	--

Print Server Settings

Use the **Print Server Settings** menu to set the type of printer interface and necessary conditions for communications.

The following tabbed pages are displayed in the top of the Right Frame.

Print Server Reports

The **Print Server Reports** tab includes **Print Server Setup Page**, and **E-Mail Alert Setup Page**.

Print Server Setup Page

Purpose:

To verify the current settings of TCP/IP (Transmission Control Protocol/Internet Protocol) protocol and printing ports. On this page, you can only verify the settings of items. If you want to change the settings, go to the pages in the **Print Server Settings** tab.

Values:

Ethernet	Ethernet Settings	Displays the current settings of Ethernet transmission rate and the duplex settings.
	Current Ethernet Settings	Displays the current Ethernet settings.
	MAC Address	Displays the printer's MAC (Media Access Control) address.
TCP/IP Settings	Host Name	Displays the host name.
	IP Address Mode	Displays the settings for the IP address.
	IP Address	Displays the printer's IP address.
	Subnet Mask	Displays the subnet mask.
	Gateway Address	Displays the gateway address.
DNS	DNS Mode	Select the check box to get the DNS (Domain Name System) server address automatically from the DHCP (Dynamic Host Configuration Protocol) server.
	Current DNS Server Address	Displays the DNS server address.
LPD (Line Printer Daemon)	Port Status	Displays the port status.
	Connection Time-Out	Displays the connection timeout period.
Port9100	Port Status	Displays the port status.
	Port Number	Displays the port number.
	Connection Time-Out	Displays the connection timeout period.
HTTP	Port Status	Displays the HTTP (Hyper Text Transfer Protocol) port status.
	Port Number	Displays the HTTP port number.
	Simultaneous Connections	Displays the number of connections received simultaneously by the client.
	Connection Time-Out	Displays the connection timeout period.
FTP	Port Status	Displays the port status.
	Connection Time-Out	Displays the connection timeout period.
SNMP Agent	Port Status	Displays the port status.
	Trap Notification (IP) 1-3	Displays the status of the Trap Notification (IP) feature and IP address.
	Authenticate Error Trap	Displays the status of the Authenticate Error Trap .

IP Filter	Access List	Displays the list of IP addresses that are permitted or denied access to the printer.
------------------	--------------------	---

E-Mail Alert Setup Page

Purpose:

To verify the current settings of SMTP/POP (Simple Mail Transfer Protocol/Post Office Protocol) used for the e-mail feature and E-Mail Alerts feature. In this page, you can only verify the settings of items. If you want to change the settings, go to the pages in the **Print Server Settings** tab.

Values:

E-Mail Server Settings	Port Status		Displays the port status.
	Primary SMTP Gateway		Displays the primary SMTP (Simple Mail Transfer Protocol) gateway.
	SMTP Port Number		Displays the SMTP port number.
	E-Mail Send Authentication		Displays the authentication method for outgoing e-mail.
	POP3 Server Address		Displays the POP3 (Post Office Protocol 3) server address.
	POP3 Port Number		Displays the POP3 port number.
	Reply Address		Displays the IP address of servers connected with SMTP protocol when data is incoming.
	SMTP Server Connection		Displays the status of the SMTP server connection.
E-Mail Alert Settings	E-Mail List 1		Displays the acceptable e-mail addresses for the E-Mail Alert feature specified in E-mail List 1.
	Select Alerts for List 1	Supplies Alerts	Displays the status, and whether to receive an E-Mail Alert for consumables.
		Paper Handling Alerts	Displays the status, and whether to receive an E-Mail Alert for paper handling.
		Service Call	Displays the status, and whether to receive an E-Mail Alert for Service Calls.
	E-Mail List 2		Displays the acceptable e-mail addresses for the E-Mail Alert feature specified in E-mail List 2.
	Select Alerts for List 2	Supplies Alerts	Displays the status, and whether to receive an E-Mail Alert for consumables.
		Paper Handling Alerts	Displays the status, and whether to receive an E-Mail Alert for paper handling.
Service Call		Displays the status, and whether to receive an E-Mail Alert for Service Calls.	

Print Server Settings

The **Print Server Settings** tab includes **Basic Information**, **Port Settings**, **TCP/IP**, **E-Mail Alert**, and **SNMP** pages.

Basic Information

Purpose:

To configure the printer's basic information.

Values:

System Settings	Printer Name	Specifies the name of the printer up to 31 alphanumeric characters.
	Location	Specifies the location of the printer up to 63 alphanumeric characters.
	Contact Person	Specifies the contact name, number, and other information of the printer administrator and service center up to 63 alphanumeric characters.

	Administrator E-Mail Address	Specifies the contact address of the printer administrator and service center up to 63 alphanumeric characters.	
	Asset Tag Number	Enter the asset tag number for the printer.	
EWS Settings	Auto Refresh	On	Refreshes the contents of the status display pages automatically.
		Off	Does not refresh the status display pages automatically.
	Auto Refresh Interval	Sets the time interval for refreshing the contents of the status display pages automatically from 15 to 600 seconds.	

 **NOTE:** The auto refresh feature is effective for the contents of the Top Frame, **Printer Status** page, **Job List** page, and **Completed Jobs** page.

Port Settings

Purpose:

To specify whether to enable or disable printing ports and management protocol features.

Values:

Ethernet	Ethernet Settings	Auto	Detects Ethernet transmission rate and the duplex settings automatically.
		10Base-T Half-Duplex	Selects 10Base-T Half-Duplex as the default value.
		10Base-T Full-Duplex	Selects 10Base-T Full-Duplex as the default value.
		100Base-TX Half-Duplex	Selects 100Base-TX Half-Duplex as the default value.
		100Base-TX Full-Duplex	Selects 100Base-TX Full-Duplex as the default value.
	Current Ethernet Settings		Displays the current settings of Ethernet.
	MAC Address		Displays the printer's MAC address.
Port Status	LPD		Select the check box to enable the LPD.
	Port9100		Select the check box to enable the Port9100.
	FTP		Select the check box to enable the FTP port.
	E-Mail Alert		Select the check box to enable the E-Mail Alert feature.
	SNMP Agent		Select the check box to enable the SNMP (Simple Network Management Protocol). You can also configure the transport protocol to be used. UDP can be selected as the transport protocol.

 **NOTE:** The settings in the **Port Settings** page will be valid only when the printer is rebooted. When you change or configure the settings, click the **Restart printer to apply new settings** button to apply new settings.

TCP/IP

Purpose:

To configure the IP address, subnet mask, and gateway address of the printer.

Values:

TCP/IP Settings	Host Name		Specifies the host name up to 47 alphanumeric characters. The default name will remain valid if no entry is made.
	IP Address Mode	AutoIP	Automatically sets the IP address.
		DHCP	Uses DHCP to set the IP address.
		BOOTP	Uses BOOTP (BOOTstrap Protocol) to set the IP address.

	RARP	Uses RARP (Reverse Address Resolution Protocol) to set the IP address.
	Manually Set	Uses the control panel or the Dell Printer Configuration Web Tool to set the IP address manually.
	IP Address	Sets the IP address allocated to the printer in the <i>nnn.nnn.nnn.nnn</i> format, where <i>nnn</i> is a variable between 0 and 255. Note that values 127 and 224-254 are not valid for the first three-digits.
	Subnet Mask	Sets the subnet mask in the <i>nnn.nnn.nnn.nnn</i> format. Each section of <i>nnn.nnn.nnn.nnn</i> is a value between 0 and 255. Note that 255.255.255.255 is invalid.
	Gateway Address	Sets the gateway address in the <i>nnn.nnn.nnn.nnn</i> format. Each section of <i>nnn.nnn.nnn.nnn</i> is a value between 0 and 254. Note that values 127 and 224-254 are not valid for the first three-digits.
DNS	DNS Mode	Select the check box to get the DNS server address automatically from the DHCP server.
	DNS Server Address	Sets the DNS server address.
	DNS Domain Name	Specifies the domain name of the domain name server. Up to 255 alphanumeric characters, periods, and hyphens can be used. If specifying more than one domain name, separate them using a comma or semicolon.
LPD	Connection Time-Out	Sets the connection timeout period from 1 to 1000 seconds.
	IP Filter	To set the IP Filter settings, click IP Filter . The IP Filter page is displayed.
Port9100	Port Number	Sets the port number from 9000 to 9999.
	Connection Time-Out	Sets the connection timeout period between 1 and 1000 seconds.
	IP Filter	To set the IP Filter settings, click IP Filter . The IP Filter page is displayed.
HTTP	Port Number	Sets the port number to 80 or from 8000 to 9999.
	Simultaneous Connections	Displays the maximum number of connections received simultaneously by the client.
	Connection Time-Out	Sets the connection timeout period from 1 to 255 seconds.
FTP	Password	Sets whether to enable or disable the password. And also specifies the password value up to 7 characters.
	Connection Time-Out	Sets the connection timeout period from 1 to 1000 seconds.

E-Mail Alert

Purpose:

To configure detailed settings for E-Mail Alert. This page can also be displayed by clicking **E-Mail Alert** in the Left Frame.

Values:

E-Mail Server Settings	Primary SMTP Gateway	Sets the primary SMTP gateway.	
	SMTP Port Number	Specifies the SMTP port number. This must be 25 or between 5000 and 65535.	
	E-Mail Send Authentication	Specifies the authentication method for outgoing e-mail.	
	SMTP Login User	Specifies the SMTP login user. Up to 63 alphanumeric characters, periods, hyphens, under bars, and at symbols (@) can be used. If specifying more than one address, separate them using commas.	
	SMTP Login Password	Specifies the SMTP account password up to 31 alphanumeric characters.	
	POP3 Server Address* 1	Specifies the POP3 server address in IP address format of "aaa.bbb.ccc.ddd" or as a DNS host name up to 63 characters.	
	POP3 Port Number* 1	Specifies the POP3 server port number. This must be 110 or between 5000 and 65535.	
	POP User Name* 1	Specifies the POP3 account user name. Up to 63 alphanumeric characters, periods, hyphens, under bars, and at symbols (@) can be used. If specifying more than one address, separate them using commas.	
	POP User Password* 1	Specifies the POP3 account password up to 31 alphanumeric characters.	
	Reply Address	Designates the reply e-mail address sent with each E-mail Alert.	
	SMTP Server Connection	Displays the status of the SMTP server connection.	
E-Mail Alert Settings	E-Mail List 1	Sets acceptable e-mail addresses for the E-Mail Alert feature up to 255 alphanumeric characters.	
	Select Alerts for List 1	Supplies Alerts	Select the check box to receive an E-Mail Alert for consumables.
		Paper Handling Alerts	Select the check box to receive an E-Mail Alert for paper handling.

	Service Call	Select the check box to receive an E-Mail Alert for Service Calls.
	E-Mail List 2	Sets acceptable e-mail addresses for the E-Mail Alert feature up to 255 alphanumeric characters.
	Select Alerts for List 2	
	Supplies Alerts	Select the check box to receive an E-Mail Alert for consumables.
	Paper Handling Alerts	Select the check box to receive an E-Mail Alert for paper handling.
	Service Call	Select the check box to receive an E-Mail Alert for Service Calls.
* ¹ Available when POP before SMTP for E-Mail Send Authentication is selected.		

SNMP

Purpose:

To configure the detailed settings of SNMP.

Values:

SNMP Agent	Community Name (Read only) ^{*1}	Specifies the community name to access (read only) the data up to 31 alphanumeric characters. The original setting will remain valid if no input is made. Characters entered for community name in previous settings will not be displayed on the screen. The default Read Community is public.
	Community Name (Read/Write) ^{*1}	Specifies the community name to access (read and write) the data up to 31 alphanumeric characters. The original setting will remain valid if no input is made. Characters entered for community name in previous settings will not be displayed on the screen. The default Read/Write Community is private.
	Community Name (Trap) ^{*1}	Specifies the community name used for trap up to 31 alphanumeric characters. The original settings will remain valid if no input is made. Characters entered for Community Name (Trap) in previous settings will not be displayed on the screen. The default Trap Community is " " (NULL).
	Trap Notification (IP) 1-3	Select the check boxes to notify trap occurrence. In this case, specify the IP address and IP socket in the <i>nnn.nnn.nnn.nnn:mmmmm</i> format. Each section of "nnn" is a variable value between 0 and 255. Note that values 127 and 224-254 are not valid for the first three-digits only. IP socket <i>mmmmm</i> is a variable value between 0 and 65535.
	Authenticate Error Trap	Select the check box to notify Authenticate Error Trap.
* ¹ The default value of each items can be changed by using Dell Printer Configuration Web Tool.		

IP Filter

Purpose:

To configure the detailed settings for the IP Filter used for LPD and Port9100.

Values:

Address	Sets the address in the address field. Enter a numeric value between 0 and 255 in each field of "aaa.bbb.ccc.ddd." However, 127 and 224-254 cannot be used to "aaa."	
Address Mask	Sets the Subnet Mask in the mask field. Enter a numeric value between 0 and 255 in each field.	
Active Mode	Reject	Rejects printing from specified network address.
	Permit	Permits printing from specified network address.
	Disabled	Disables the IP Filter feature for the specified IP address.

When you make the settings for the filter, enter the IP address of the IP Filter in the **Address** field and the Subnet Mask in the **Address Mask** field. Enter a numeric value between 0 and 255 in each field. "*" is appended to the current value.

Setup Procedure

You can set up to a maximum of five items and the first item takes priority. Enter the shortest address first before proceeding to the next longer address when setting multiple filters.

The following section explains how the **IP Filter** operates.

IP Filter Procedure

1. Enabling Printing From a Specified User

The following describes the procedure to enable printing only from the "192.168.100.10" IP address.

Procedures:

- a. Click the first column of **Access List** row **1**.
- b. Enter "192.168.100.10" in the **Address** field and "255.255.255.255" in the **Address Mask** field.
- c. Select **Permit**.
- d. Click **Apply New Settings**.

2. Disabling Printing From a Specified User

The following section describes the procedure to disable printing only from the "192.168.100.10" IP address.

Procedures:

- a. Click the first column of **Access List** row **1**.
- b. Enter "192.168.100.10" in the **Address** field and "255.255.255.255" in the **Address Mask** field.
- c. Select **Reject**.
- d. Click the first column of **Access List** row **2**.
- e. Enter "0.0.0.0" in the **Address** field and "0.0.0.0" in the **Address Mask** field.
- f. Select **Permit**.
- g. Click **Apply New Settings**.

3. Enabling and Disabling Printing from Network Addresses

You can enable printing from the "192.168" network address and disable printing from the "192.168.200" network address. However, the example below describes how to enable printing from the "192.168.200.10" IP address.

Procedures:

- a. Click the first column of the **Access List** row **1**.
- b. Enter "192.168.200.10" in the **Address** field and "255.255.255.255" in the **Address Mask** field.
- c. Select **Permit**.
- d. Click the first column of the **Access List** row **2**.
- e. Enter "192.168.200.0" in the **Address** field and "255.255.255.0" in the **Address Mask** field.
- f. Select **Reject**.
- g. Click the first column of the **Access List** row **3**.
- h. Enter "192.168.0.0" in the **Address** field and "255.255.0.0" in the **Address Mask** field.
- i. Select **Permit**.
- j. Click **Apply New Settings**.

Other Features

The **Other Features** tab includes **Set Password**, and **Reset Print Server** pages.

Set Password

Purpose:

To set or change the password that is required to access the printer setup parameters from the **Dell Printer Configuration Web Tool**.

Set the password of the Tool Box from **Set Password** in the **Printer Maintenance** tab. This page can also be displayed by clicking **Set Password** in the Left Frame.

 **NOTE:** To restore the password to default (NULL), initialize the non-volatile memory (NVM).

Values:

Administrator Password	Sets the password up to 10 alphanumeric characters. The password will appear as asterisks (*) in the field when it is entered.
Confirm Administrator Password	Enter the password again to confirm it.

Reset Print Server

Purpose:

To initialize NVRAM (non-volatile RAM) for the network feature and reboot the printer. You can also initialize the printer's NVRAM from **Reset Defaults** in the **Printer Settings** menu.

Values:

Initialize NIC NVRAM Memory and restart printer.	Click the Start button to initialize NVRAM. Network settings will revert to the factory default settings and reboot the network capability.
Restart Printer	Click the Start button to reboot the printer.

Copy Printer Settings

The **Copy Printer Settings** menu includes the **Copy Printer Settings** and **Copy Printer Settings Report** pages.

Copy Printer Settings

Purpose:

To copy the printer settings to one or more of the same model of the printer.

To copy the settings to another printer, specify the IP address and password of the printer to which the settings are copied in the **IP Address** text box and **Password** text box. Then, click the **Copy the settings to the Host in the above list** button. Copying the settings is complete. The connection time-out period is 60 seconds. After that, you can check whether settings were copied to this page. And you need to check the **Copy the settings to the Host in the above list and reboot the machine** menu of the **Dell Printer Configuration Web Tool** in the destination printer to verify if settings were actually copied or not.

If the settings can be copied but printer configuration is different, the settings of only the same items are copied. Printer settings are simultaneously copied to printers of up to 10 IP addresses.

Copy Printer Settings Report

Purpose:

To verify the histories of copying.

 **NOTE:** The history is cleared by turning off the printer.

Print Volume

The **Printer Volume** menu includes the **Print Volume** and **Dell ColorTrack** pages.

Print Volume

Purpose:

To verify the number of printed pages. This page can also be displayed by clicking **Print Volume** in the Left Frame.

Values:

Printer Page Count	Displays the total number of pages printed since the printer was shipped from the factory.
Paper Used	Displays the number of pages for each paper size.

Dell ColorTrack

Purpose:

To specify which users have access to color printing and to limit print volume per user.

Values:

Print User Limitation	Select the check box to restrict users from using the printer.
Permit printing without specifying user	Select the check box to use the printer without user limitations.
User Registration	Displayed when Print User Limitation is enabled. To register a user, click Edit User Registration to open the Edit Print User Registration page, and then specify User Registration No. and click Confirm/Change to open the Print User Settings page.

[back to contents page](#)

[back to contents page](#)

Print Media Guidelines

Print media is paper, labels, envelopes, and coated paper among others. Your printer provides high-quality printing on a variety of print media. Selecting the appropriate print media for your printer helps avoid printing troubles. This section describes selecting print media, caring for print media, and loading the print media in the tray 1.

- [Paper](#)
 - [Envelopes](#)
 - [Labels](#)
 - [Storing Print Media](#)
 - [Identifying Print Media Sources and Specifications](#)
-

Paper

For the best print quality in color, use 75 g/m² (20 lb) xerographic, grain long paper. For the best print quality in black and white, use 90 g/m² (24 lb) xerographic, grain long paper. Before buying large quantities of any print media, Dell recommends trying a sample first.

When loading paper, identify the recommended print side on the paper package, and load the paper accordingly. See "[Loading Print Media in Tray 1](#)" and "[Loading the Single Sheet Feeder](#)" for detailed loading instructions.

Paper Characteristics

The following paper characteristics affect print quality and reliability. Dell recommends that you follow these guidelines when evaluating new paper stock.

Weight

The tray automatically feeds paper weights from 60 to 216 g/m² (16 to 60 lb bond) grain long. The single sheet feeder automatically feeds paper weights from 60 to 216 g/m² (16 to 80 lb bond) grain long. Paper lighter than 60 g/m² (16 lb) may not feed properly, and could cause paper jams. For best performance, use 75 g/m² (20 lb bond) grain long paper.

Curl

Curl is the tendency of print media to curve at its edges. Excessive curl can cause paper feeding problems. Curl usually occurs after the paper passes through the printer, where it is exposed to high temperatures. Storing paper unwrapped, even in the paper tray, can contribute to paper curling prior to printing and cause feeding problems regardless of humidity. When printing on curled paper, straighten the paper and then insert it into the single sheet feeder.

Smoothness

The degree of paper smoothness directly affects print quality. If the paper is too rough, the toner does not fuse to the paper properly, resulting in poor print quality. If the paper is too smooth, it can cause paper feeding problems. Smoothness between 150 and 250 Sheffield points produces the best print quality.

Moisture Content

The amount of moisture in the paper affects both print quality and the ability of the printer to feed the paper properly. Leave the paper in its original packaging until you are ready to use it. This limits the exposure of the paper to moisture changes that can degrade its performance.

Grain Direction

Grain refers to the alignment of the paper fibers in a sheet of paper. Grain is either grain long, running the length of the paper, or grain short, running the width of the paper. For 60 to 135 g/m² (16 to 36 lb bond) paper, grain long fibers are recommended. For papers heavier than 135 g/m² (36 lb bond), grain short is preferred.

Fiber Content

Most high-quality xerographic paper is made from 100% chemically pulped wood. Paper containing fibers such as cotton possess characteristics that can result in degraded paper handling.

Recommended Paper

To ensure the best print quality and feed reliability, use 75 g/m² (20 lb) xerographic paper. Business papers designed for general business use also provide acceptable print quality. Only use paper able to withstand high temperatures without discoloring, bleeding, or releasing hazardous emissions. The laser printing process heats paper to high temperatures. Check with the manufacturer or vendor to determine whether the paper you have chosen is acceptable for laser printers.

Always print several samples before buying large quantities of any type of print media. When choosing any print media, you should consider the weight, fiber content, and color.

Unacceptable Paper

The following paper types are not recommended for use with the printer:

- 1 Chemically treated papers used to make copies without carbon paper, also known as carbonless papers, carbonless copy paper (CCP), or no carbon required (NCR) paper
- 1 Preprinted papers with chemicals that may contaminate the printer
- 1 Preprinted papers that can be affected by the temperature in the printer fuser
- 1 Preprinted papers that require a registration (the precise print location on the page) greater than ±0.09 inches, such as optical character recognition (OCR) forms

In some cases, you can adjust registration with your software program to successfully print on these forms.

- 1 Coated papers (erasable bond), synthetic papers, thermal papers
- 1 Rough-edged, rough or heavily textured surface papers, or curled papers
- 1 Recycled papers containing more than 25% post-consumer waste that do not meet DIN 19 309
- 1 Multiple-part forms or documents
- 1 Print quality may deteriorate (blank spaces or blotches may appear in the text) when printing on talc or acid paper.

Selecting Paper

Proper paper selection helps prevent jams and ensures trouble-free printing.

To help avoid jams or poor print quality:

- 1 Always use new, undamaged paper.
- 1 Before loading the paper, identify the recommended print side of the paper. This information is usually indicated on the paper package.
- 1 Do not use paper that you have cut or trimmed yourself.
- 1 Do not mix print media sizes, weights, or types in the same source. This may result in a paper jam.
- 1 Do not remove the tray while a job is printing.
- 1 Ensure that the paper is properly loaded in the tray.
- 1 Flex paper back and forth, and then fan them. Straighten the edges of the stack on a level surface.

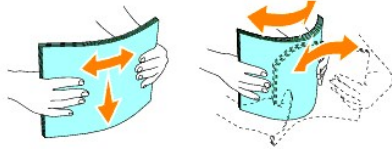

Selecting Preprinted Forms and Letterhead

When selecting preprinted forms and letterhead paper for the printer:

- 1 Use grain long papers for best results.
- 1 Use only forms and letterhead printed using an offset lithographic or engraved printing process.
- 1 Select papers that absorb ink, but do not bleed.
- 1 Avoid papers with rough or heavily textured surfaces.
- 1 Use papers printed with heat-resistant inks designed for use in xerographic copiers. The ink must withstand temperatures of 225°C (437°F) without melting or releasing hazardous emissions.
- 1 Use inks that are not affected by the resin in toner or the silicone in the fuser. Inks that are oxidation-set or oil-based should meet these requirements; latex inks might not. If you are in doubt, contact your paper supplier.

Printing on Letterhead

Check with the manufacturer or vendor to determine whether the pre-printed letterhead you have selected is acceptable for laser printers.

Page orientation is important when printing on letterhead. Use the following table for help when loading letterhead in the print media sources.

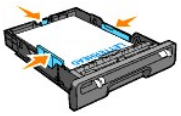
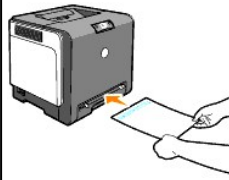
Print media source	Print side	Page orientation
Tray 1	Face up 	Letterhead enters the printer last
Single sheet feeder	Face down 	Letterhead enters the printer first

Selecting Pre-Punched Paper

Pre-punched paper brands can differ in the number and placement of holes and in manufacturing techniques. However, it may not be possible to print on the paper to depending on the placement of holes on the paper.

To select and use pre-punched paper:

- 1 Test paper from several manufacturers before ordering and using large quantities of pre-punched paper.

- 1 Paper should be punched at the paper manufacturer and not drilled into paper already packaged in a ream. Drilled paper can cause jams when multiple sheets feed through the printer. This may result in a paper jam.
 - 1 Pre-punched paper can include more paper dust than standard paper. Your printer may require more frequent cleaning and feed reliability may not be as good as standard paper.
 - 1 Weight guidelines for pre-punched paper are the same as non-punched paper.
-

Envelopes

Depending on the choice of envelopes, it is possible to expect variable levels of light wrinkling. Before buying large quantities of any print media, Dell recommends trying a sample first. See "[Loading Print Media in Tray 1](#)" or "[Loading the Single Sheet Feeder](#)" for instructions on loading an envelope.

When printing on envelopes:

- 1 Use only high-quality envelopes that are designed for use in laser printers.
 - 1 Set the print media source to the single sheet feeder or Tray 1. Set the paper type to **Envelope**, and select the correct size of envelope from the printer driver.
 - 1 For best performance, use envelopes made from 75 g/m² (20 lb bond) paper. You can use up to 105 g/m² (28 lb bond) weight for the envelope feeder as long as the cotton content is 25% or less. Envelopes with 100% cotton content must not exceed 90 g/m² (24 lb bond) weight.
 - 1 Use only new, undamaged envelopes.
 - 1 Use envelopes that can withstand temperatures of 205°C (401°F) without sealing, excessive curling, wrinkling, or releasing hazardous emissions. If you have any doubts about the envelopes you are considering, check with the envelope supplier.
 - 1 Adjust the guide to fit the width of the envelopes.
 - 1 To load envelope in the single sheet feeder, insert the envelopes with the flaps closed and the short-edge of the envelopes facing into the printer. The print side must be facing down.
 - 1 See "[Loading Print Media in Tray 1](#)" or "[Loading the Single Sheet Feeder](#)" for instructions on loading an envelope.
 - 1 Use one envelope size during a print job.
 - 1 Ensure the humidity is low because high humidity (more than 60%) and the high printing temperatures may seal the envelopes.
 - 1 For best performance, do not use envelopes that:
 - o Have excessive curl or twist
 - o Are stuck together or damaged in any way
 - o Contain windows, holes, perforations, cutouts, embossing
 - o Use metal clasps, string ties, or metal folding bars
 - o Have an interlocking design
 - o Have postage stamps attached
 - o Have any exposed adhesive when the flap is in the sealed or closed position
 - o Have nicked edges or bent corners
 - o Have rough, cockle, or laid finishes
-

Labels

Your printer can print on many labels designed for use with laser printers. Dell recommends feeding Labels from Tray 1. Label adhesives, face sheet (printable stock), and topcoats must be able to withstand temperatures of 205°C (401°F) and pressure of 25 pounds per square inch (psi). Before buying large quantities of any print media, Dell recommends trying a sample first.

When printing on labels:

- 1 Set the paper type to **Label** from the printer driver.
- 1 Do not load labels together with paper in the same tray. This may result in a jam.
- 1 Do not use label sheets with a slick backing material.
- 1 Do not print within 1 mm (0.04 inches) of the die cut.
- 1 Use full label sheets. Partial sheets may cause labels to peel off during printing, resulting in a jam. Partial sheets also contaminate your printer and your cartridge with adhesive, and could void your printer and cartridge warranties.
- 1 Use labels that can withstand temperatures of 205°C (401°F) without sealing, excessive curling, wrinkling, or releasing hazardous emissions.
- 1 Do not print within 1 mm (0.04 inches) of the edge of the label, of the perforations, or between die-cuts of the label.
- 1 Do not use label sheets that have adhesive to the edge of the sheet. Dell recommends zone coating of the adhesive at least 1 mm (0.04 inches) away from edges. Adhesive material contaminates your printer and could void your warranty.
- 1 If zone coating of the adhesive is not possible, a 3 mm (0.125 inches) strip should be removed on the leading and driver edge, and a non-oozing adhesive should be used.
- 1 Remove a 3 mm (0.125 inches) strip from the leading edge to prevent labels from peeling inside the printer.
- 1 Portrait orientation is preferred, especially when printing bar codes.
- 1 Do not use labels that have exposed adhesive.

Storing Print Media

For proper print media storage, the following guidelines help avoid media feeding problems and uneven print quality.

- 1 For best results, store print media in an environment where the temperature is approximately 21°C (70°F) and the relative humidity is 40%.
- 1 Store cartons of print media on a pallet or shelf, rather than directly on the floor.
- 1 If you store individual packages of print media out of the original carton, ensure that they rest on a flat surface so that the edges do not buckle or curl.
- 1 Do not place anything on top of the print media packages.

Identifying Print Media Sources and Specifications

The following tables provide information on standard and optional print media sources.

Print Media Sizes and Support

	Single sheet feeder	Tray 1
A4 (210x297 mm)	Y	Y
B5 (182x257 mm)	Y	Y
A5 (148x110 mm)	Y	Y
Youkei 2 (114x162mm)	Y	Y
Youkei 3 (98x148mm)	Y	Y
Youkei 4 (105x235mm)	Y	Y
Youkei 6 (98x190mm)	Y	Y
Youchoukei 3 (120x235mm)	Y	Y
Choukei 3 (120x235mm)	Y	Y
Choukei 4 (90x205mm)	Y	Y

Kakukei 3 (216x277mm)	Y	Y
C5 (162x229mm)	Y	Y
Monarch (3.875x7.5 in)	Y	Y
Envelope #10 (4.125x9.5 in)	Y	Y
DL(110x220mm)	Y	Y
Postcard JPN (100x148mm)	Y	Y
Postcard JPN (148x200mm)	Y	Y
Letter (8.5x11 in)	Y	Y
Legal (8.5x14 in)	Y	Y
Folio (8.5x13 in)	Y	Y
Executive (7.25x10.5 in)	Y	Y
Custom*	Y	Y
*Custom: 76.2 and 220.0 mm or between 3.00 and 8.66 inches 127.0 and 355.6 mm or between 5.00 and 14.00 inches.		

Print Media Supported

Media	Single sided printing		Duplex printing	
	Single sheet feeder	Tray 1	Single sheet feeder	Tray 1
Plain	Y*	Y*	Y*	Y*
Plain - Side 2	Y	Y	N	N
Plain Thick	Y	Y	Y	Y
Plain Thick - Side 2	Y	Y	N	N
Recycled	Y	Y	Y	Y
Recycled - Side 2	Y	Y	N	N
Label	Y	Y	N	N
Covers	Y	Y	Y	Y
Covers - Side 2	Y	Y	N	N
Covers Thick	Y	Y	Y	N
Covers Thick - Side 2	Y	N	N	N
Envelope	Y	Y	N	N
Postcard JPN	Y	Y	Y	Y
Postcard JPN - Side 2	Y	Y	N	N
Coated JPN	Y	N	Y	N
Coated JPN - Side 2	Y	N	N	N
Coated	Y	N	Y	N
Coated - Side 2	Y	N	N	N
Coated Thick	Y	N	N	N

* Values marked by an asterisk (*) are the factory default menu settings.

Setup Paper Type

Paper type	Weight (gsm)	Remarks
Plain Paper	60-90	-
Plain Thick Paper	80/90-105	-
Covers	106-163	-
Covers Thick	164-216	-

Coated	106-163 (Low Speed)	Inkjet printer paper cannot be used.
Coated Thick	164-216 (Low Speed)	Inkjet printer paper cannot be used.
Coated JPN	95-105 (Mid Speed)	-
Label	3R7408	Inkjet printer paper cannot be used.
Envelopes	-	-

[back to contents page](#)

[back to contents page](#)

Loading Print Media

Loading print media properly helps prevent jams and ensures trouble-free printing.

Before loading print media, identify the recommended print side of the print media. This information is usually on the print media package.

- [Tray 1](#)
 - [Loading Print Media in Tray 1](#)
 - [Single Sheet Feeder](#)
 - [Loading the Single Sheet Feeder](#)
 - [Using the Single Sheet Feeder](#)
 - [Using the Manual Duplex Function](#)
 - [Manual Duplex Printing from Tray 1](#)
 - [Manual Duplex Printing From the Single Sheet Feeder](#)
 - [Using the Output Tray](#)
 - [Using the Output Tray Extension](#)
-

Tray 1

Capacity

Tray 1 can hold:

- 1 250 sheets of the standard paper.

Print Media Dimensions

Tray 1 accepts print media within the following dimensions:

- 1 Width - 76.2 mm (3.00 inches) to 220.0 mm (8.66 inches)
 - 1 Length - 127 mm (5.00 inches) to 355.6 mm (14.00 inches)
-

Loading Print Media in Tray 1

- 📌 **NOTE:** To avoid paper jams, do not remove the tray while a printing is in progress.
- 📌 **NOTE:** Use only laser print media. Do not use ink jet paper in the printer.

1. Remove the paper tray from the printer.

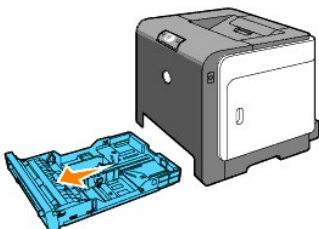

- Adjust the paper guides so they rest against the edges of the paper.

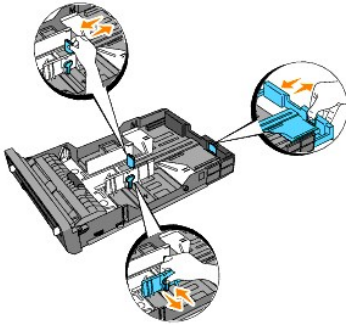

NOTE: When you feed paper from the tray loaded with Legal size paper, extend the rear side of the tray.

- Before loading the print media, flex the sheets back and forth, and then fan them. Straighten the edges of the stack on a level surface.

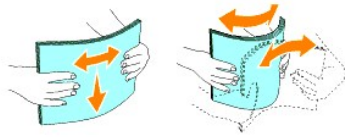

- Place the print media into the tray with the recommended print side face up.

NOTE: Do not exceed the maximum fill line in the tray. Overfilling the tray may cause paper jams.

- Adjust the width guides until they rest lightly against the edges of the stack of paper.

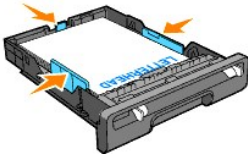

NOTE: When loading user-specified print media, adjust the width guides and slide the extendable part of the tray by down the length guide until it rests lightly against the edge of the stack of paper.

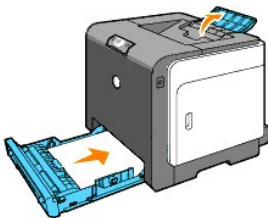

- After confirming that the guides are securely adjusted, insert the tray into the printer and extend the output tray on the top of the printer.



Loading Letterhead

The letterhead must be toward the top edge of the tray 1 with the print side facing up. However, the letterhead must be inserted top edge first with the print side facing down when loading paper into the single sheet feeder.

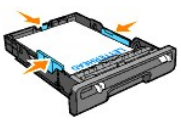
Print media source	Print side	Page orientation

Tray 1	Face up 	Letterhead enters the printer last
Single sheet feeder	Face down 	Letterhead enters the printer first

Loading the Envelope

To load an envelope in Tray 1, load envelopes with the flaps closed when the short-edges of the envelopes enter the printer, or with the flaps open when the long-edges of the envelopes enter the printer.

Single Sheet Feeder

Capacity

The single sheet feeder can hold:

- 1 Sheet of the standard paper.

Print Media Dimensions

The single sheet feeder accepts print media within the following dimensions:

- 1 Width - 76.2 mm (3.00 inches) to 220.0 mm (8.66 inches)
- 1 Length - 127 mm (5.00 inches) to 355.6 mm (14.00 inches)

Loading the Single Sheet Feeder

In addition to plain paper, the single sheet feeder can be used various other sizes and types of print media such as an envelope.

1. Adjust the paper guides to the print media's width.

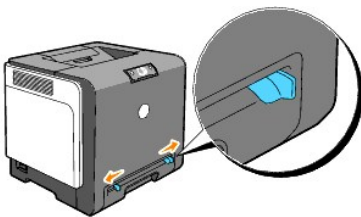

2. Hold both sides of the print media facing down close to the single sheet feeder, and push it 8-9 cm (4 inches) into the feeder until it automatically feeds.

 **NOTE:** Do not force the print media into the single sheet feeder.

Loading the Envelope

To load an envelope in the single sheet feeder, insert the envelope with the flap closed when the short edge of the envelope faces into the printer. Place the envelope with the print side facing down and slide the envelope into the entry slot.



 **NOTICE:** Never use the envelope with windows, coated linings, or self-stick adhesives. These lead to paper jams and can cause damage to the printer.

 **NOTE:** Ensure that you set the envelope with the flaps completely closed.

Using the Single Sheet Feeder

- 1 Insert an envelope with the flap side face down and with the stamp area on the top right side.
- 1 Load letterhead face-down, with the top of the sheet entering the printer first.
- 1 If you experience problems with paper feed, turn the paper around.

Using the Manual Duplex Function

Manual Duplex printing (or two-sided printing) allows you to print on both sides of a sheet of paper. For sizes that are acceptable for duplex printing, see ["Print Media Sizes and Support."](#)

Using Booklet Print

 **NOTE:** You cannot use booklet print with the single sheet feeder.

To use booklet print, you must select either **Flip on Short Edge** or **Flip on Long Edge** from the **Duplex** menu in the **Printing Preferences** dialog box and then select **Booklet Creation** in the **Booklet/Poster/Mixed Document** dialog box displayed by clicking the **Booklet/Poster/Mixed Document** button. From the **Duplex** menu, you can define the way two-sided print pages are bound, and how the printing on the back of the sheet (even-numbered pages) is oriented in relation to the printing on the front (odd-numbered pages).

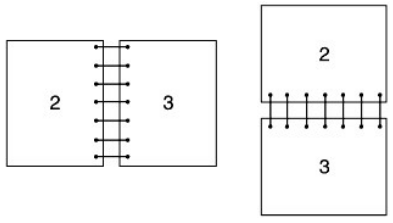
Flip on Long Edge	Assumes binding along the long edge of the page (left edge for portrait orientation and top edge for landscape orientation). The following illustration shows long-edge binding for portrait and landscape pages: 
Flip on Short Edge	Assumes binding along the short edge of the page (top edge for portrait orientation and left edge for landscape orientation). The following illustration shows short-edge binding for portrait and landscape pages:

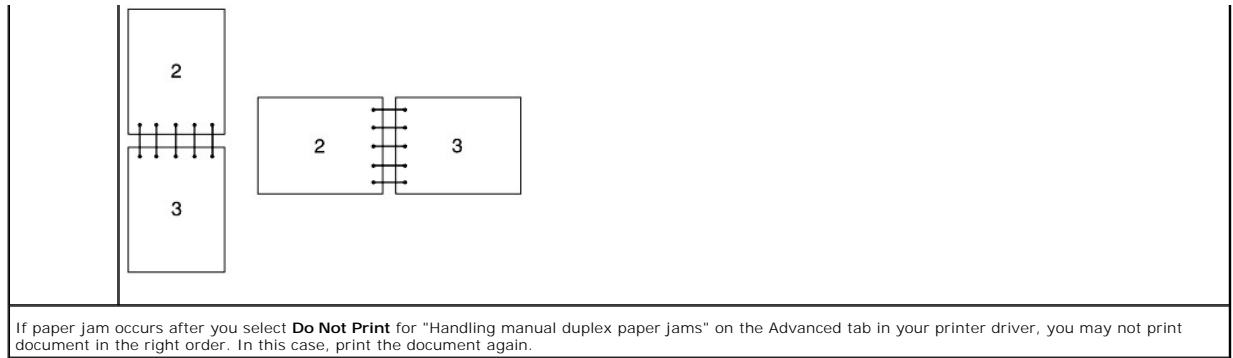

Manual Duplex Printing from Tray 1

Setting Method for Manual Duplex from Tray 1

When you start manual duplex printing, the instruction windows appears. Note that you cannot display this window again if you close the window. Do not close the window until duplex printing is complete.

1. First print the even pages. For a six page document, even pages are printed in the order page 6, page 4, then page 2. The **Continue** button blinks when the even pages finish printing.



2. Next stack the prints and set them as they are (with the blank side face up) into the paper tray. Pages are printed in the order page 1, page 3, then page 5.

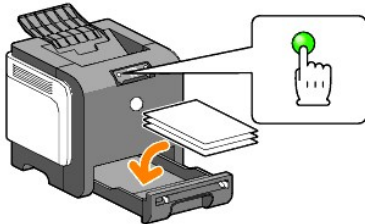

NOTE: Printing on both sides of the paper is not possible if the document consists of various sizes of papers.

Manual Duplex Printing From the Single Sheet Feeder

NOTE: When printing on curled paper, straighten the paper and then insert it into the single sheet feeder.

Setting Method for Manual Duplex from the Single Sheet Feeder

When you start manual duplex printing, the instruction windows appears. Note that you cannot display this window again if you close the window. Do not close the window until duplex printing is complete.

1. First print the even pages.
For a six page document, even pages are printed in the order page 2, page 4, then page 6.
The **Continue** button blinks when the even pages finish printing.



2. After the even pages have finished printing out, stack the prints and turn the stack over.

 **NOTE:** Warped or curled prints can cause paper jams. Straighten them before setting them.

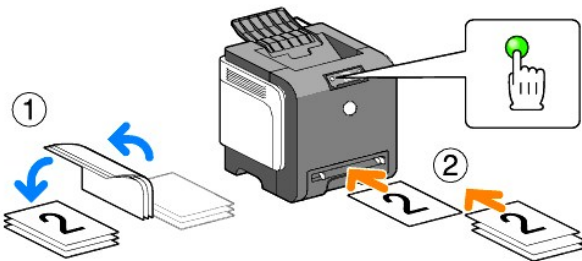

3. Next print the odd pages. One sheet at a time, set the very top print that was turned over as it is with the blank side face down, then press the Continue button. Print pages in the order page 1 (rear of page 2), page 3 (rear of page 4), then page 5 (rear of page 6).

Example: When duplex printing a four page document onto two sheets.

Set one page at a time in the manual feed tray in the order page 2 (rear) → page 4 (rear) → page 1 (front) → page 3 (front).

 **NOTE:** Printing on both sides of the paper is not possible if the document consists of various sizes of papers.

Using the Output Tray

The output tray holds up to:

- 1 150 sheets of plain paper

Using the Output Tray Extension

The output tray extension is designed to prevent print media from falling from the printer after the print job is complete.

Before printing a document, ensure that the output tray extension is fully extended.



[back to contents page](#)

[back to contents page](#)

Operator Panel

- [Using the Operator Panel](#)
 - [Understanding the Operator Panel Lights](#)
 - [Restoring the factory settings](#)
-

Using the Operator Panel



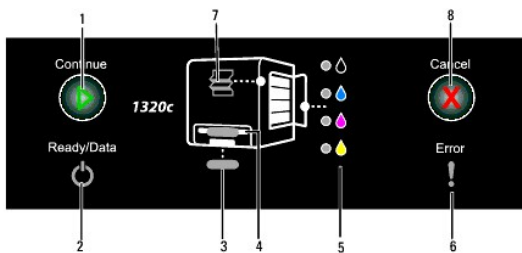





The printer operator panel has two buttons and several indicators that show the status of the printer.



1. Continue button/indicator
 - 1 Press this button to start single sheet feeder or duplex printing.
 - 1 Press and hold this button to print the Report page.
2. Ready/Data indicator
Indicates the printer status, such as receiving and printing data.
3. Tray 1 indicator
Indicates the status of the Tray 1.
4. Single sheet feeder indicator
Indicates the status of the shingle sheet feeder.
5. Toner indicators
Indicates the toner is low or empty.
6. Error indicator
Lights when an error occurred.
7. Jam/Front Cover Open indicator
Indicates that a paper jam occurred or the front cover is open.
8. Cancel button
Press this button to cancel a job.







For details on each indicator, see the table below.

Indicator	Status	Condition
Continue	Green on	Press the Continue button to start single sheet feeder printing.
	Green blinks	Press the Continue button to start duplex printing.
Ready/Data	Green on	The printer is ready.
	Green blinks	Processing or printing or Warming up.
	Orange on	The Power saver mode or Standby mode.
Error	Orange on	The PHD (Print Head Device), or belt unit, life is coming to an end. Clean the CTD sensor.
	Orange blinks	An error occurred.
	Orange blinks	The PHD, or belt unit life is over. Clean the CTD sensor.
Tray	Green on	Paper is set on the tray.
	Green blinks	Reload paper on the tray.

-								
-		-	-	-	-	-	-	Calibrating
-		-	-	-	-	-	-	Warming up
-		-	-	-	-	-	-	Waiting for incoming data
-		-	-	-	-		-	Initializing NVM
-		-	-	-	-	-	-	On Diagnosis when starting
-		-	-	-	-	-	-	In power saver mode

Paper Conditions

The following table shows the paper status.

1	2	3	4	5	6	7	Printer status
-	-		-	-	-	-	Paper is loaded in the Tray 1.
-	-	-		-	-	-	Paper is loaded in the single sheet feeder.
-	-	-	-		-	-	The toner is low in the specified toner cartridge.
-	-	-	-	*	-	-	Non Dell toner is used in the toner cartridge.
-	-	-	-	-		-	Life warning in the PHD unit
-	-	-	-	-		-	Life warning in the belt unit
-	-	-	-	-		-	Clean the CTD sensor.

* Orange on in all toner indicators.

The following conditions prompt you to load paper and press the Continue key. Click the links in the right column for more information on what it means and what you can do.

1	2	3	4	5	6	7	Action
			-	-	-	-	Load paper for side 2 in the Tray 1. See " Manual Duplex Printing from Tray 1. "
			-	-	-	-	Press the Continue key. See " Manual Duplex Printing from Tray 1. "
		-		-	-	-	Load paper for side 2 in the single sheet feeder. See " Manual Duplex Printing From the Single Sheet Feeder. "
		-		-	-	-	Press the Continue key. See " Manual Duplex Printing From the Single Sheet Feeder. "
-			-	-	-	-	Load paper in the Tray 1. See " Loading Print Media in Tray 1. "
-			-	-	-	-	Load paper in the Tray 1. See " Loading Print Media in Tray 1. "
-		-		-	-	-	Load paper in the single sheet feeder. See " Loading the Single Sheet Feeder. "
		-		-	-	-	Load paper in the single sheet feeder. See " Loading the Single Sheet Feeder. "

When an Error Occurred

The following table shows the location where an error occurred.

1	2	3	4	5	6	7	Printer status
-	-	-	-	-			Paper jam occurred. See " Clearing Jams. "
-	-	-	-	-			The front cover is open.
-	-		-	-			Paper jam occurred in the Tray 1. See " Clearing Paper Jams From the Tray 1. "
-	-	-		-			Paper jam occurred in the single sheet feeder. See " Clearing Paper Jams From the Single Sheet Feeder. "
-	-	-	-	-	-	-	The wrong size of paper size is loaded in the Tray 1. See " Identifying Print Media Sources and Specifications. "

		☀			☀						
-	-	-			☀	☀		-	-	The wrong size of paper is loaded in the single sheet feeder. See " Identifying Print Media Sources and Specifications ."	
-	-	-	-	-		☀		-	-	Operator call errors	
-	-	-	-		☀	☀		-	-	An error occurred in the specified toner cartridge. See " Replacing Toner Cartridges ."	
-	-	-	-		☀			-	-	The toner is empty in the specified toner cartridge. See " Replacing Toner Cartridges ."	
-	-	-	-	-		☀		-	-	The life of the PHD unit is over.	
-	-	-	-	-		☀		-	-	The life of the belt unit is over.	
-	-	-	-	-		☀		-	-	Clean the CTD sensor.	

Operator Call Errors

Press and hold the **Continue** button when an error occurs. You can obtain the detailed information from the operator call error.

1	2	3	4	5-K	5-C	5-M	5-Y	6	7	Error status
-	●	●	-	-	-	-	-	●	-	Memory overflow
-	●	-	●	-	-	-	-	●	-	PDL (Page Description Language) error
-	●	-	-	-	-	-	-	●	●	Invalid job environment
-	●	●	-	-	-	-	-	●	●	The side cover is open.
-	●	●	●	●	●	-	-	●	●	Dell ColorTrack - Invalid user
-	●	●	●	●	-	●	-	●	●	Dell ColorTrack - Disabled function
-	●	●	●	●	-	-	-	●	●	Dell ColorTrack - Reached limit

Toner Errors

1	2	3	4	5	6	7	Toner status
-	●	●	-	●	●	-	The specified toner is not installed.
-	●	-	●	●	●	-	The low toner in the specified toner cartridge.
-	●	-	-	●	●	●	The CRUM ID error in the specified toner cartridge.

Errors in the PHD Unit, Belt Unit, Fuser Unit, and CTD Sensor

1	2	3	4	5-K	5-C	5-M	5-Y	6	7	Error status
-	●	●	-	●	●	●	-	●	●	The PHD unit is removed.
-	●	●	-	-	●	●	●	●	●	The life of the PHD unit is over.
-	●	●	-	●	●	●	●	●	●	PHD CRUM ID error
-	●	●	-	●	-	●	●	●	●	The tapes are not removed from the PHD unit.
-	●	-	●	-	●	●	●	●	●	The belt unit life is over.
-	●	●	●	-	-	●	●	●	●	The CTD sensor is dirty.

Fatal Errors

The following table shows fatal errors. Contact your Dell supplier to notify the printer status associated with each error.

1	2	3	4	5-K	5-C	5-M	5-Y	6	7	Printer status
-	☀	☀	-	☀	-	-	-	☀	-	ROS failure
-	☀	☀	-	-	☀	-	-	☀	-	Fuser failure
-	-	-	-	-	-	-	-	-	-	NVRAM (IOT) error

-				-	-	-	-			- CTD (Conductivity Temperature Depth) sensor failure
-						-	-	-		- Fan motor failure
-							-	-		- Motor failure
-					-	-	-			- MCU (Machine Control Unit) error
-					-	-	-			- Environmental sensor failure
-						-	-	-		- Solenoid error in the K mode.
-							-	-		- PageC timeout error

ESS-Related Errors

1	2	3	4	5-K	5-C	5-M	5-Y	6	7	Error Status	
-		-				-	-	-			ESS Data Cache Error
-							-	-			ESS Instruction Error
-							-	-			ESS Illegal Exception
-					-			-			ASIC Failure
-								-			ESS On-Board RAM W/R Check Failure
-								-			ESS ROM Check Failure
-			-			-	-	-			ESS NVRAM1 W/R Check Failure
-			-	-			-	-			ESS NVRAM2 W/R Check Failure

-		-	-			-	-			ESS NVRAM SIZE and ID Check Failure
-		-					-			On-Board Network Communication Failure
-		-		-	-	-	-			On-Board Network MAC Address Checksum Error
-		-			-	-	-			On-Board Network Ethernet BIST Parity RAM R/W Error
-		-		-		-	-			On-Board Network Internal Loopback Error
-		-				-	-			On-Board Network Fatal Error
-		-		-	-					IOT-ESS Communication Failure
-		-			-					HW Key Error

Restoring the factory settings

You can restore the factory settings for your printer if you cannot use the printer with your computer.

NOTE: You can only initialize user-defined settings.

To restore the factory settings:

1. Ensure that the printer is turned off.
2. Open the side cover.
3. While holding down the Continue and Cancel buttons at the same time, turn on the printer.
4. After all the indicators are turned on, release the Continue and Cancel buttons.
5. After the Continue, Error, and Ready/Data indicators go out, close the side cover. The printer automatically:
 1. Initializes the non-volatile memory (NVM).
- CAUTION:** Never attempt to turn off the printer. The printer will cease to function.

 1. Restarts.
 1. Prints the Printer Settings and Device Settings pages.
6. Check if the factory settings are restored by referring to the Printer Settings and Device Settings pages.

[back to contents page](#)

[back to contents page](#)

Printer Settings

You can change most system settings from your software programs. If your printer is attached to the network, you can change settings from the **Dell Printer Configuration Web Tool**. To launch the **Dell Printer Configuration Web Tool**, type the printer IP address in your Web browser. To find your printer's IP address, see "[Printing a Printer Settings Page](#)".

Settings from the software program update the default system settings for the printer. Settings from the printer driver only apply to the job you are sending to the printer.

If you cannot change a setting from your software program, use the **Dell Printer Configuration Web Tool**. Changing a system setting from the Tool Box or from the **Dell Printer Configuration Web Tool** makes that setting the user default.

- [Printing a Printer Settings Page](#)
 - [Using the Tool Box to Change the Printer Settings](#)
 - [Using the Dell Printer Configuration Web Tool to Change System Settings](#)
 - [Resetting Defaults](#)
-

Printing a Printer Settings Page

You can verify the detailed system settings by printing a printer settings page.

1. Click **Start**→ **All Programs**→ **Dell Printers**→ **Additional Color Laser Software**→ **Status Monitor Console**.
The **Printer Selection** dialog box opens.
2. Click **Dell Color Laser 1320c** listed in Printer Name.
The **Dell Color Laser 1320c Launcher** window opens.
3. Click the **Tool Box** button.
The **Tool Box** opens.
You can also launch the Tool Box from the printer icon on the taskbar.
4. Click the **Printer Settings Report** tab.
5. Select **Reports** from the list at the left side of the page.
The Reports page is displayed.
6. Click the **Start** button for Printer Settings.
The Printer Settings page is printed.

You can also print the printer settings page by the following.

- 1 Press and hold the Continue button on the printer until the Ready/Data indicator blinks.

 **NOTE:** You cannot print a printer settings page by pressing and holding the **Continue** button if the password is specified in Set Password of the Tool Box (because the operator panel is locked).

Using the Tool Box to Change the Printer Settings

You can select menu items and corresponding values from the Tool Box.

Factory defaults may vary for different countries.

These settings are active until new ones are selected or the factory defaults are restored.

To select a new value as a setting:

1. Click **Start**→ **All Programs**→ **Dell Printers**→ **Additional Color Laser Software**→ **Status Monitor Console**.
The **Printer Selection** dialog box opens.
2. Click **Dell Color Laser 1320c** listed in Printer Name.
The **Dell Color Laser 1320c Launcher** window opens.
3. Click the **Tool Box** button.
The **Tool Box** opens.
You can also launch the Tool Box from the printer icon on the taskbar.
4. Click the **Printer Maintenance** tab.
5. Select the desired menu item.
Each menu item has a list of values for the menu item. A value can be:
 - 1 A phrase or word to describe a setting
 - 1 A numerical value that can be changed
 - 1 An On or Off setting
6. Select the desired value, and then click the associated button with each menu item.

Driver settings may override changes previously made and may require you to change the Tool Box defaults.

Using the Dell Printer Configuration Web Tool to Change System Settings

If your printer is connected to the network, you can change the device settings from your Web browser. If you are a network administrator, you can clone the system settings of one printer to one or all printers on the network.

Type your network printer IP address in your Web browser. Choose **Printer Settings** from the topics list, and then select the system settings you want to change.

To copy your system settings to another printer on the network, choose **Copy Printer Settings** from the topics list, and then type the other printer's IP address.

If you do not know your printer IP address, see the printer settings page. To print a printer settings page:

1. Click **Start**→ **All Programs**→ **Dell Printers**→ **Additional Color Laser Software**→ **Status Monitor Console**.
The **Printer Selection** dialog box opens.
 2. Click **Dell Color Laser 1320c** listed in Printer Name.
The **Dell Color Laser 1320c Launcher** window opens.
 3. Click the **Tool Box** button.
The Tool Box opens.
You can also launch the Tool Box from the printer icon on the taskbar.
 4. Click the **Printer Settings Report** tab.
 5. Select TCP/IP Settings from the list at the left side of the page.
-

Resetting Defaults

After executing this function and rebooting the printer, all the menu parameters, except the parameters for the network, are reset to their default values.

1. Click **Start**→ **All Programs**→ **Dell Printers**→ **Additional Color Laser Software**→ **Status Monitor Console**.
The **Printer Selection** dialog box opens.
2. Click **Dell Color Laser 1320c** listed in Printer Name.
The **Dell Color Laser 1320c Launcher** window opens.
3. Click the **Tool Box** button.
The Tool Box opens.
You can also launch the Tool Box from the printer icon on the taskbar.
4. Click the **Printer Maintenance** tab.
5. Select **Reset Defaults** from the list at the left side of the page.
The Reset Defaults page is displayed.
6. Click **Start** to initialize the non-volatile memory (NVM) memory.
The printer is turned off automatically to apply the settings.

[back to contents page](#)

[back to contents page](#)

Understanding Tool Box Menus

The Tool Box allows you to view or specify the printer settings. You can also diagnose the printer settings by using the Tool Box.

The Tool Box consists of the **Printer Settings Report**, **Printer Maintenance**, and **Diagnosis** tabs.

● [Printer Settings Report](#)

● [Printer Maintenance](#)

● [Diagnosis](#)

 **NOTE:** A **Password** dialog box appears the first time you try to change settings or click a button after starting up the Tool Box. Input the password you specified in **Set Password** in the **Printer Maintenance** tab. The default password is left blank. You can click **OK** without entering a password to go to the next step.

Printer Settings Report

The **Printer Settings Report** tab includes the **Printer Information**, **Menu Settings**, **Reports**, and **TCP/IP Settings** pages.

 **NOTE:** Values marked by an asterisk (*) are the factory default menu settings.

Printer Information

Purpose:

To verify the printer details such as hardware configuration and software version.

Values:

Dell Service Tag Number	Displays Dell's service tag number.
Printer Serial Number	Displays the printer's serial number.
Printer Type	Displays the type of printing for the printer. Color Laser is displayed normally.
Asset Tag Number	Displays the printer's asset tag number.
Memory Capacity	Displays the memory capacity.
Processor Speed	Displays the processing speed.
Firmware Version	Displays the version of the controller.
Network Firmware Version	Displays the NIC version.
MCU Firmware Version	Displays the version of the MCU firmware.
Printing Speed (Color)	Displays the speed for color printing.
Printing Speed (Monochrome)	Displays the speed for monochrome printing.

Menu Settings

Purpose:

To display the current settings of the printer.

Values:

System Settings	Power Saver Timer Mode 1	Displays the amount of time before the printer enters the Power Saver Timer Mode 1 (sleep mode) after a print job is complete.	
	Power Saver Timer Mode 2	Displays the amount of time before the printer enters the Power Saver Timer Mode 2 (deep sleep mode) when the times specified in Power Saver Timer Mode 1 and Power Saver Timer Mode 2 elapses after a print job is complete.	
	Control Panel Tone	Display whether the printer sounds the panel tone when you touch the panel.	
	Machine Ready Tone	Displays whether the printer sounds the tone when the printer is ready.	
	Job Complete Tone	Display whether the printer sounds the tone when printing is complete.	
	Fault Tone	Displays whether the printer sounds the tone when an error occurs.	
	Alert Tone	Displays whether the printer sounds an alarm.	
	Out of Paper Alert Tone	Displays whether the printer sounds the tone when the printer runs out of paper.	
	Low Toner Alert Tone	Displays whether the printer sounds the tone when the toner is low.	
	Time-Out	Displays the amount of time the printer waits to receive additional bytes of data from the computer.	
	Device Language	Displays the language to be used for E-mail Alert.	
	Auto Log Print	Displays whether the printer outputs logs automatically.	
	Paper Density	Plain	Displays the paper density for the plain paper.
Label		Displays the paper density for the label.	
Adjust BTR	Plain	Displays the voltage settings of the transfer roller (-6-6) for plain paper. The default is 0.	
	Plain Thick	Displays the voltage settings of the transfer roller (-6-6) for thick plain paper. The default is 0.	
	Covers	Displays the voltage settings of the transfer roller (-6-6) for cover paper. The default is 0.	
	Covers Thick	Displays the voltage settings of the transfer roller (-6-6) for thick cover paper. The default is 0.	
	Label	Displays the voltage settings of the transfer roller (-6-6) for labels. The default is 0.	
	Coated	Displays the voltage settings of the transfer roller (-6-6) for coated paper. The default is 0.	
	Coated Thick	Displays the voltage settings of the transfer roller (-6-6) for thick coated paper. The default is 0.	
	Envelope	Displays the voltage settings of the transfer roller (-6-6) for envelopes. The default is 0.	
	Recycled	Displays the voltage settings of the transfer roller (-6-6) for recycled paper. The default is 0.	
	Coated JPN	Displays the voltage settings of the transfer roller (-6-6) for Japanese coated paper. The default is 0.	
	Postcard JPN	Displays the voltage settings of the transfer roller (-6-6) for Japanese postcards. The default is 0.	
Adjust Fuser	Plain	Displays the temperature settings of the fuser (-2-2) for plain paper. The default is 0.	
	Plain Thick	Displays the temperature settings of the fuser (-2-2) for thick plain paper. The default is 0.	
	Covers	Displays the temperature settings of the fuser (-2-2) for cover paper. The default is 0.	
	Covers Thick	Displays the temperature settings of the fuser (-2-2) for thick cover paper. The default is 0.	
	Label	Displays the temperature settings of the fuser (-2-2) for labels. The default is 0.	
	Coated	Displays the temperature settings of the fuser (-2-2) for coated paper. The default is 0.	
	Coated Thick	Displays the temperature settings of the fuser (-2-2) for thick coated paper. The default is 0.	
	Envelope	Displays the temperature settings of the fuser (-2-2) for envelopes. The default is 0.	
	Recycled	Displays the temperature settings of the fuser (-2-2) for recycled paper. The default is 0.	
	Coated JPN	Displays the temperature settings of the fuser (-2-2) for Japanese coated paper. The default is 0.	
	Postcard JPN	Displays the temperature settings of the fuser (-2-2) for Japanese postcards. The default is 0.	
Auto Registration Adjustment	Auto Registration Adjustment	Displays whether to adjust the registration automatically.	
Adjust Altitude	Adjust Altitude	Displays whether to adjust the height of the installation location of the printer.	
Non-Dell Toner	Non-Dell Toner	Displays whether to use a refilled toner cartridge.	
Web Link Customization	Select Reorder URL	Regular*	Displays the URL (accessories.us.dell.com/sna).
		Premier	Displays the URL (premier.dell.com).

Reports

Purpose:

To print various types of reports and lists.

The reports are printed in the paper size specified in Printer Settings. The default is A4 or Letter.

Values:

Printer Settings	Click the Start (1) button to print the printer settings page.
Device Settings	Click the Start (2) button to print the detailed settings page.
Job History	Click the Start (3) button to print the job history report.
Error History	Click the Start (4) button to print the error history report.
Color Test Page	Click the Start (5) button to print the color test page.

TCP/IP Settings

Purpose:

To display the current settings of TCP/IP (Transmission Control Protocol/Internet Protocol) protocol.

Values:

IP Address Mode	Displays the settings for the IP address.
IP Address	Displays the printer's IP address.
Subnet Mask	Displays the subnet mask.
Gateway Address	Displays the gateway address.

Printer Maintenance

The **Printer Maintenance** tab includes the **System Settings**, **Paper Density**, **Adjust BTR**, **Adjust Fuser**, **Registration Adjustment**, **Adjust Altitude**, **Reset Defaults**, **Non-Dell Toner**, **Initialize PrintMeter**, **Web Link Customization**, **TCP/IP Settings**, **EWS**, and **Set Password** pages.

 **NOTE:** Values marked by an asterisk (*) are the factory default menu settings.

System Settings

Purpose:

To configure the basic printer settings.

Values:

Power Saver Timer Mode 1**1	1-30 min	Specifies the amount of time before the printer enters the Power Saver Timer Mode 1 (sleep mode) after a print job is complete.
	3 min*	

Power Saver Timer Mode 2 ^{*1}	5-60 min		Specifies the amount of time before the printer enters the Power Saver Timer Mode 2 (deep sleep mode) when the times specified in Power Saver Timer Mode 1 and Power Saver Timer Mode 2 elapses after a print job is complete.
	10 min*		
Alert Tone	Control Panel Tone	Off*	Does not sound an alert when you press a button on the panel.
		On	Sounds an alert when you press a button on the panel.
	Machine Ready Tone	Off*	Does not sound an alert when the printer is ready.
		On	Sounds an alert when the printer is ready.
	Job Complete Tone	Off*	Does not sound an alert when a job is completed.
		On	Sounds an alert when a job is completed.
	Fault Tone	Off*	Does not sound an alert when a job is terminated by some faults.
		On	Sounds an alert when a job is terminated by some faults.
	Alert Tone	Off*	Does not sound an alert when an error occurs.
		On	Sounds an alert when an error occurs.
	Out of Paper Alert Tone	Off*	Does not sound an alert when the printer runs out of paper.
		On	Sounds an alert when the printer runs out of paper.
Low Toner Alert Tone	Off*	Does not sound an alert when toner becomes low.	
	On	Sounds an alert when toner becomes low.	
Time-Out	0		Disables the job timeout.
	5-300 sec		Specifies the amount of time the printer waits to receive additional bytes of data from the computer. When this timeout expires, the print job is canceled.
	30 sec*		
Device Language	English*		Determines the language to be used for E-mail Alert.
	French		
	Italian		
	German		
	Spanish		
	Dutch		
	Danish		
	Norwegian		
	Swedish		
	Finnish		
	Polish		
	Portuguese		
	Japanese		
Turkish			
Auto Log Print	Off*		Does not automatically print the Job History report.
	On		Automatically print the Job History report when the number of Job History items reaches the maximum.
Apply New Settings			After you complete the settings, press the Apply New Settings button to apply the changes.
Restart printer to apply new settings			Press the Restart printer to apply the new settings button to apply the changes.
<p>* 1 Enter 3 to put the printer in the power saver timer mode five minutes after it finishes a job. This uses much less energy, but requires more warm-up time for the printer. Enter 3 if your printer shares an electrical circuit with room lighting and you notice lights flickering.</p> <p>Select a high value if your printer is in constant use. Under most circumstances, this keeps the printer ready to operate with minimum warm-up time. Select a value between 5 and 60 minutes for the power saver timer mode if you want a balance between energy consumption and a shorter warm-up period.</p> <p>The printer automatically returns to the standby mode from the power saver timer mode when it receives data from the computer. You can also return the printer to the standby mode by pressing any button on the operator panel.</p>			

Paper Density

Purpose:

To specify the paper density.

Values:

Plain	Normal*
	Light
Label	Normal*
	Light
Apply New Settings	After you complete the settings, press the Apply New Settings button to apply the changes.
Restart printer to apply new settings	Press the Restart printer to apply the new settings button to apply the changes.

Adjust BTR

 **NOTE:** The print quality changes depending on the setting values you select for this item.

Purpose:

To specify the reference voltage settings for the transfer roller.

Values:

Plain	-6-6	Sets the reference voltage settings for the transfer roller for plain paper.
	0*	
Plain Thick	-6-6	Sets the reference voltage settings for the transfer roller for thick plain paper.
	0*	
Covers	-6-6	Sets the reference voltage settings for the transfer roller for cover paper.
	0*	
Covers Thick	-6-6	Sets the reference voltage settings for the transfer roller for thick cover paper.
	0*	
Label	-6-6	Sets the reference voltage settings for the transfer roller for labels.
	0*	
Coated	-6-6	Sets the reference voltage settings for the transfer roller for coated paper.
	0*	
Coated Thick	-6-6	Sets the reference voltage settings for the transfer roller for thick coated paper.
	0*	
Envelope	-6-6	Sets the reference voltage settings for the transfer roller for envelopes.
	0*	
Recycled	-6-6	Sets the reference voltage settings for the transfer roller for recycled paper.
	0*	
Coated JPN	-6-6	Sets the reference voltage settings for the transfer roller for Japanese coated paper.
	0*	
Postcard JPN	-6-6	Sets the reference voltage settings for the transfer roller for Japanese postcards.
	0*	
Apply New Settings	After you complete the settings, press the Apply New Settings button to apply the changes.	
Restart printer to apply new settings	Press the Restart printer to apply the new settings button to apply the changes.	

Adjust Fuser

Purpose:

To specify the temperature settings value for the fuser.

Values:

Plain	-2-2	Sets the temperature settings for the fuser for plain paper.
	0*	
Plain Thick	-2-2	Sets the temperature settings for the fuser for thick plain paper.
	0*	
Covers	-2-2	Sets the temperature settings for the fuser for cover paper.
	0*	
Covers Thick	-2-2	Sets the temperature settings for the fuser for thick cover paper.
	0*	
Label	-2-2	Sets the temperature settings for the fuser for labels.
	0*	
Coated	-2-2	Sets the temperature settings for the fuser for coated paper.
	0*	
Coated Thick	-2-2	Sets the temperature settings for the fuser for thick coated paper.
	0*	
Envelope	-2-2	Sets the temperature settings for the fuser for envelopes.
	0*	
Recycled	-2-2	Sets the temperature settings for the fuser for recycled paper.
	0*	
Coated JPN	-2-2	Sets the temperature settings for the fuser for Japanese coated paper.
	0*	
Postcard JPN	-2-2	Sets the temperature settings for the fuser for Japanese postcards.
	0*	
Apply New Settings		After you complete the settings, press the Apply New Settings button to apply the changes.
Restart printer to apply new settings		Press the Restart printer to apply the new settings button to apply the changes.

Registration Adjustment

Purpose:

To print the color registration chart and to adjust the color registration by using the chart. This function is required after the printer is set up or moved.

Values:

Auto Registration Adjustment	Off	Does not adjust the registration automatically.	
	On*	Adjusts the registration automatically.	
Auto Correct		Click Start to adjust color registration automatically.	
Color Regi Chart		Click Start to print the color registration chart.	
Color Registration Adjustment 1 (Lateral)	Yellow	-9-9	Specifies the values for the lateral direction that are found in the color registration chart.
		0*	
	Magenta	-9-9	
		0*	
	Cyan	-9-9	
		0*	

		0*	
Color Registration Adjustment 2 (Process)	Yellow	-9-9	Specifies the values for the process direction that are found in the color registration chart.
		0*	
	Magenta	-9-9	
		0*	
	Cyan	-9-9	
0*			
Apply New Settings			After you complete the settings, press the Apply New Settings button to apply the changes.
Restart printer to apply new settings			Press the Restart printer to apply the new settings button to apply the changes.

Adjust Altitude

Purpose:

To adjust the height of the location to install the printer.

Values:

0 meter*	Selects the value close to the height of the location to install the printer.
1000 meters	
2000 meters	
3000 meters	
Apply New Settings	After you complete the settings, press the Apply New Settings button to apply the changes.
Restart printer to apply new settings	Press the Restart printer to apply the new settings button to apply the changes.

Reset Defaults

Purpose:

To initialize the non-volatile memory (NVM). After executing this function to automatically restart the printer, all the menu parameters are reset to their default values.

Values:

Reset Defaults and restart printer.	Click Start to initialize the non-volatile memory (NVM) memory.
-------------------------------------	--

Non-Dell Toner

When Non-Dell toner is used, the printer may be severely damaged and may not be covered by your warranty.

Purpose:

To specify whether to use the refilled toner cartridge or not. When this setting is on, you can use toner cartridges provided by other companies.

Values:

Non-Dell Toner	Off*	Disables the use of refilled toner cartridges.
	On	Enables the use of refilled toner cartridges.
Apply New Settings		After you complete the settings, press the Apply New Settings button to apply the changes.
Restart printer to apply new settings		Press the Restart printer to apply the new settings button to apply the changes.

Initialize PrintMeter

Purpose:

To initialize the data for the print meter. After executing this function to automatically restart the printer, the value of the meter resets to 0.

Values:

Initialize PrintMeter	Click Start to initialize the print meter.
-----------------------	---

Web Link Customization

Purpose:

To configure the link used for ordering supplies.

Values:

Select Reorder URL	Specifies the URL that Order Supplies at links to in the left frame of the Dell Printer Configuration Web Tool .
Regular*	accessories.us.dell.com/sna
Premier	premier.dell.com
Apply New Settings	
After you complete the settings, press the Apply New Settings button to apply the changes.	
Restart printer to apply new settings	
Press the Restart printer to apply the new settings button to apply the changes.	

TCP/IP Settings

Purpose:

To specify the TCP/IP settings for the network.

Values:

IP Address Mode	AutoIP*	Automatically sets the IP address.
	DHCP	Uses DHCP to set the IP address.
	BOOTP	Uses BOOTP to set the IP address.
	RARP	Uses RARP to set the IP address.
	Manually Set	Manually sets the IP address.
IP Address		Sets the IP address allocated to the printer.
Subnet Mask		Sets the subnet mask.
Gateway Address		Sets the gateway address.

Apply New Settings	After you complete the settings, press the Apply New Settings button to apply the changes.
Restart printer to apply new settings	Press the Restart printer to apply the new settings button to apply the changes.

EWS (Embedded Web Server or Dell Printer Configuration Web Tool)

Purpose:

To print the server settings for the **Dell Printer Configuration Web Tool**.

Print Server Settings		Click Display to display the server settings for the Dell Printer Configuration Web Tool .
Display of EWS	Off	Disable to display the server settings for the Dell Printer Configuration Web Tool.
	On*	Enable to display the server settings for the Dell Printer Configuration Web Tool.
Apply New Settings		After you complete the settings, press the Apply New Settings button to apply the changes.
Restart printer to apply new settings		Press the Restart printer to apply the new settings button to apply the changes.

Set Password

Purpose:

To set a password to limit access to the menus.

Values:

Setting of Panel Lock	Off*	Does not set a password to limit access to the menus.
	On	Set a password to limit access to the menus.
Password		Type a new password. This must be between 0001 and 9999.
Input password again		Type the new password again to confirm.
Apply New Settings		After you complete the settings, press the Apply New Settings button, and then enter the user name and password to apply the changes.
Restart printer to apply new settings		Press the Restart printer to apply the new settings button to apply the changes.

Diagnosis

The **Diagnosis** tab includes the **Chart Print**, **Machine Check**, **Paper Wrinkle Check Mode**, **Environment Sensor Info**, **Developer Stir Mode**, and **Refresh Mode** pages.

 **NOTE:** Values marked by an asterisk (*) are the factory default menu settings.

Chart Print

Purpose:

To print the chart file.

Values:

Pitch Configuration Chart	Prints the chart to confirm the pitch in A4 or Letter.
Ghost Configuration Chart	Prints the chart to confirm the ghost in A4 or Letter.
4 Colors Configuration Chart	Prints the chart to confirm the gray scale for four color printing in A4 or Letter.
MQ Chart	Prints the chart to confirm the binding in A4 or Letter.
Alignment Chart	Prints the chart to confirm the alignment in A4 or Letter.
PHD Refresh Configuration Chart	Prints the chart to confirm the light fatigue of the PHD (Print Head Device) unit in A4 or Letter.

Machine Check

Purpose:

To check the mechanical operations of the printer.

Values:

Machine Check	Main Motor Operation Check*	Checks the operation of the main motor.
	Fuser Motor Operation Check	Checks the operation of the fuser motor.
	Feed Roll Operation Check* ¹	Checks the operation of the separatro roller.
	REGI CLUTCH Operation Check	Checks the operation of REGI CLUTCH.
	Dispense Motor Check(Yellow)	Checks the operation of the dispense motor for each toner cartridge.
	Dispense Motor Check(Magenta)	
	Dispense Motor Check(Cyan)	
Dispense Motor Check(Black)		
Play of Sound	Plays the sound the selected motor makes when it runs normally.	
* ¹ When performing the feed roll operation check, remove the paper tray from the printer.		

Paper Wrinkle Check Mode

Purpose:

To determine whether or not paper is wrinkled in the fuser.

This function stops printing before the paper enters the fuser. After you remove the paper inside the printer, check the following:

- 1 If the paper is wrinkled, the wrinkle occurred in the part other than fuser.
- 1 If the paper is not wrinkled, the wrinkle occurred in the fuser.

Values:

Paper Size	Letter*	Specifies the size of paper.
	Legal	
	Envelope #10	
	8.5 x 13"	
	Executive	

	Monarch	
	A4	
	A5	
	B5	
	C5	
	DL	
	Postcard JPN	
	W-Postcard	
	Youkei 2 Env	
	Youkei 3 Env	
	Youkei 4 Env	
	Choukei 3 Env	
	Youchou 3 Env	
Paper Type	Plain*	Specifies the type of paper.
	Plain Thick	
	Covers	
	Covers Thick	
	Label	
	Coated	
	Coated Thick	
	Envelope	
	Recycled	
	Coated JPN	
	Postcard JPN	
Rear sides	Off*	Specifies to not use the back side of the paper.
	On	Specifies to use the back side of the paper. This is enabled if you specify Plain, Plain Thick, Covers, Covers Thick, Coated, Recycled, Coated JPN, or Postcard JPN for Paper Type.
Color Mode	Color*	Specifies to print in color.
	Black	Specifies to print in black and white.

Environment Sensor Info

Purpose:

To display the information on the environment sensor in the printer by pressing the **Get Environment Sensor Info** button.

Developer Stir Mode

Purpose:

To stir the toner inside the toner cartridge.

Values:

Developer Stir Mode	Click Start to stir the toner.
----------------------------	---------------------------------------

Refresh Mode

Purpose:

To clean the toner cartridges and PHD unit.

 **CAUTION:** Using the Refresh Mode consumes extra toner.

Values:

Toner Refresh Mode	Yellow	Click Start (1) to clean the yellow cartridge.
	Magenta	Click Start (2) to clean the magenta cartridge.
	Cyan	Click Start (3) to clean the cyan cartridge.
	Black	Click Start (4) to clean the black cartridge.
PHD Refresh Mode	PHD	Click Start (5) to clean the PHD unit.

[back to contents page](#)

[back to contents page](#)

Understanding Your Printer Software

● [Printer Settings Utility](#)

Use the *Drivers and Utilities* CD that shipped with your printer to install a combination of software programs, depending on your operating system.

Printing Status Window

The **Printing Status Window** alerts you when an error or warning occurs, for example, when a paper jam occurs or toner is running low.

The **Printing Status Window** always launches when printing. When an error occurs, the error message appears on the **Printing Status Window**.

You can also check toner level, quantity of paper remaining or the configuration of options for the local printer.

Status Monitor Console

Use the **Status Monitor Console** to manage multiple **Status Window**.

- 1 Select a printer from the list view (or **Printer Selection**) by clicking its name to open a **Status Window** or **Dell Printer Configuration Web Tool** for a particular printer.
- 1 The **Status Monitor Console** displays the **Status Window** for local connections, or the **Dell Printer Configuration Web Tool** for network connections.

Dell Supplies Management System™

You can launch the **Dell Supplies Management System** dialog box from the **Printing Status window**, the **All Programs** menu, or the desktop icon. You can also launch it from the **Status Window** when a toner error occurs.

You can order consumables by phone or from the web.

1. Click **Start**→ **All Programs**→ **Dell Printers**→ **Additional Color Laser Software**→ **Dell Supplies Management System**.
The **Dell Supplies Management System** window appears.
2. Select your printer from the **Select Printer Model** list.
3. If you are ordering from the Web:
 - a. When you cannot get information from the printer automatically by two-way communication, a window that prompts you to type the Service Tag number appears. Type your Dell printer Service Tag number in the field provided. Your Service Tag number is located inside the side cover of your printer.
 - b. Select a URL from the **Select Reorder URL** list.
 - c. Click **Visit Dell printer supplies ordering web site**.
4. If ordering by phone, call the number that appears under the **By Telephone** heading.

User Setup Disk Creating Tool

The **User Setup Disk Creating Tool** program located in the **MakeDisk** folder of the **Utilities** folder on the *Drivers and Utilities* CD and the printer drivers located on the *Drivers and Utilities* CD are used to create driver installation packages that contain custom driver settings. A driver installation package can contain a group of saved printer driver settings and other data for things such as:

- 1 Print orientation and Multiple Up (document settings)
- 1 Watermarks
- 1 Font references

If you want to install the printer driver with the same settings to multiple computers running the same operating system, create a setup disk in a floppy disk or in a server on the network. Using the setup disk that you have created will reduce the amount of work required when installing the printer driver.

1. Install in advance the Dell™ Color Laser Printer 1320c printer driver in the computer on which the setup disk is to be created.
1. The setup disk can only be used on the operating system on which the disk was created or computers running the same operating system. Create a separate setup disk for different types of operating systems.

Software Update

[The firmware and/or driver updates can be downloaded from the Dell Support website located at support.dell.com.](http://support.dell.com)

Printer Settings Utility

Using the **Dell Color Laser 1320c Launcher** window, you can open **Printing Status** Window, **Tool Box**, **Updater**, and **Troubleshooting**.

When you install the Dell software, the **Dell Color Laser 1320c Launcher** is automatically installed.

For information about installing the software, see "[Setting Up for Shared Printing.](#)"

To open the Dell Color Laser 1320c Launcher window:

1. Click **Start**→ **All Programs**→ **Dell Printers**→ **Additional Color Laser Software**→ **Status Monitor Console**.
The **Printer Selection** dialog box opens.
2. Click **Dell Color Laser 1320c** listed in Printer Name.
The **Dell Color Laser 1320c Launcher** window opens.

You can also launch the **Dell Color Laser 1320c Launcher** window from the printer icon on the taskbar.



3. The **Dell Color Laser 1320c Launcher** window provides four buttons: **Status Window**, **Tool Box**, **Updater**, and **Troubleshooting**.

To exit, click the X button at the top-right of the window.

For details, click the **Help** button of each application.

Status Window

The **Status Window** button opens the **Printing Status** Window. See "[Printing Status Window.](#)"

Tool Box

You can use the **Tool Box** to specify various settings for the printer. See "[Understanding Tool Box Menus](#)"

Updater

The **Updater** button updates the settings for the print driver.

Troubleshooting

The **Troubleshooting** button opens the Troubleshooting Guide, which allows you to recover printer problems by yourself.

[back to contents page](#)

[back to contents page](#)

Printing

This chapter covers tips for printing, how to print certain lists of information from your printer, and how to cancel a job.

- [Tips for Successful Printing](#)
 - [Sending a Job to Print](#)
 - [Canceling a Print Job](#)
 - [Printing a Report Page](#)
-

Tips for Successful Printing

Tips on Storing Print Media

Store your print media properly. For more information, see "[Storing Print Media](#)".

Avoiding Paper Jams

 **NOTE:** Dell recommends that you try a limited sample of any print media you are considering using with the printer before purchasing large quantities.

By selecting appropriate print media and loading it properly, you can avoid paper jams. See the following instructions on loading print media:

- 1 ["Loading Print Media in Tray 1"](#)
- 1 ["Loading the Single Sheet Feeder"](#)
- 1 ["Avoiding Jams"](#)

If you experience a jam, see "[Clearing Jams](#)" for instructions.

Sending a Job to Print

To support all of the printer features, use the printer driver. When you choose **Print** from a software program, a window representing the printer driver opens. Select the appropriate settings for the specific job you are sending to print. Print settings selected from the driver override the default menu settings selected from the Tool Box.

You may need to click **Preferences** from the initial Print box to see all of the available system settings you can change. If you are not familiar with a feature in the printer driver window, open the online Help for more information.

To print a job from a typical Windows® application:

1. Open the file you want to print.
 2. From the **File** menu, select **Print**.
 3. Verify that the correct printer is selected in the dialog box. Modify the system settings as appropriate (such as the pages you want to print or the number of copies).
 4. Click **Preferences** to adjust system settings not available from the first screen, and then click **OK**.
 5. Click **OK** or **Print** to send the job to the selected printer.
-

Canceling a Print Job

There are several methods for canceling a print job.

Canceling From the Printer Operator Panel

To cancel a print job after it has started printing:

1. Press **Cancel**.
Printing is canceled only for the current print job. All the following print jobs will continue to print.

Canceling a Job From the Computer Running Windows

Canceling a Job From the Taskbar

When you send a job to print, a small printer icon appears in the right corner of the taskbar.

1. Double-click the printer icon.
A list of print jobs appears in the printer window.
2. Select the job you want to cancel.
3. Press **Delete** on the keyboard.

Canceling a Job From the Desktop

1. Click **Start**→**Printers and Faxes**.

For Windows 2000: Click **Start**→**Settings**→**Printers**.

For Windows Server® 2003: Click **Start**→**Printers and Faxes**.

For Windows Vista®: Click **Start**→**Control Panel**→**Hardware and Sound**→**Printers**.

For Windows Server 2008: Click **Start**→**Control Panel**→**Printers**.

A list of available printers appears.
 2. Double-click the printer that you selected when you sent the job for print.

A list of print jobs appears in the printer window.
 3. Select the job you want to cancel.
 4. Press **Delete** on the keyboard.
-

Printing a Report Page

By using the **Reports** menu, you can print a variety of settings for your printer including system settings, device setting, and job history. The following describes an example of printing from the **Reports** menu.

Printing a Printer Settings Page

To verify the detailed system settings, print a printer settings page.

See "[Understanding Tool Box Menus](#)" to identify the display if you need help.

1. Click **Start**→**All Programs**→**Dell Printers**→**Additional Color Laser Software**→**Status Monitor Console**.
The **Printer Selection** dialog box opens.
2. Click **Dell Color Laser 1320c** listed in Printer Name.
The **Dell Color Laser 1320c Launcher** window opens.
3. Click the **Tool Box** button.
The **Tool Box** opens.
You can also launch the Tool Box from the printer icon on the taskbar.
4. Click the **Printer Settings Report** tab.
5. Select **Reports** from the list at the left side of the page.
The Reports page is displayed.
6. Click the **Start** button for Printer Settings.
The Printer Settings page is printed.

You can also print the printer settings page by the following.

- 1 Press and hold the Continue button on the printer until the Ready/Data indicator blinks.

 **NOTE:** You cannot print a printer settings page by pressing and holding the **Continue** button if the password is specified in Set Password of the Tool Box (because the operator panel is locked).

If any other message appears when you print this page, see the online Help for more information.

[back to contents page](#)

[back to contents page](#)

Setting Up for Shared Printing

• [Point and Print](#)

• [Peer-to-Peer](#)

You can share your new printer on the network using the *Drivers and Utilities* CD that shipped with your printer, or using Microsoft® point and print or peer-to-peer method. However, if you use one of the Microsoft methods, you will not have all the features, such as the status monitor and other printer utilities, that are installed with the *Drivers and Utilities* CD.

To share a locally-attached printer on the network, you need to share the printer, and then install the shared printer on network clients:

For Windows® XP, Windows XP 64-bit Edition, Windows Server® 2003, and Windows 2000:

1. Click **Start**→ **Settings**→ **Printers and Faxes (Printers for Windows 2000)**.
2. Right-click this printer icon and select **Properties**.
3. From the **Sharing** tab, check the **Share this printer (Share as for Windows 2000)** check box, and then type a name in the **Share name (Share as for Windows 2000)** text box.
4. Click **Additional Drivers** and select the operating systems of all network clients printing to this printer.
5. Click **OK**.
If you are missing files, you will be prompted to insert the server operating system CD.

For Windows Vista®:

1. Click **Start**→ **Control Panel**.
2. Select **Printer**.
3. Right-click this printer icon and select **Sharing**.
4. Click **Change sharing options** button.
5. The dialog box displaying "Windows needs your permission to continue" appears.
6. Click **Continue** button.
7. Check the **Share this printer** check box, and then type a name in the **Share name** text box.
8. Click **Additional Drivers** and select the operating systems of all network clients printing to this printer.
9. Click **OK**.

For Windows Server® 2008:

1. Click **Start**→ **Control Panel**→ **Printers**.
2. Right-click the printer icon and select **Sharing**.
3. Check the **Share this printer** check box, and then type a name in the **Share name** text box.
4. Click **Additional Drivers** and select the operating systems of all network clients printing to this printer.
5. Click **OK**.

To check that the printer is successfully shared:

1. Ensure that the printer object in the **Printers and Faxes (Printers for Windows 2000)** folder is shared. For example, in Windows 2000, a hand is shown underneath the printer icon.
1. Browse **My Network Places**. Find the host name of the server and look for the shared name you assigned to the printer.

Now that the printer is shared, you can install the printer on network clients using the point and print method or the peer-to-peer method.

Point and Print

This method is usually the best use of system resources. The server handles driver modifications and print job processing. This lets network clients return to their programs much faster.

If you use the point and print method, a subset of driver information is copied from the server to the client computer. This is just enough information to send a print job to the printer.

For Windows® XP, Windows XP 64-bit Edition, Windows Server® 2003, and Windows 2000:

1. On the Windows desktop of the client computer, double-click **My Network Places**.
2. Locate the host name of the server computer, and then double-click the host name.
3. Right-click the shared printer name, and then click **Connect**.
Wait for the driver information to copy from the server computer to the client computer, and for a new printer object to be added to the **Printers and Faxes (Printers for Windows 2000)** folder. The copy time varies, based on network traffic and other factors.
Close **My Network Places**.
4. Print a test page to verify print installation.
5. Click **Start**→**Settings**→**Printers and Faxes (Printers for Windows 2000)**.
6. Select the printer you just created.
7. Click **File**→**Properties**.
8. From the **General** tab, click **Print Test Page**.

When a test page prints successfully, printer installation is complete.

For Windows Vista® and Windows Server 2008:

1. On the Windows desktop of the client computer, click **Start**→**Network**.
2. Locate the host name of the server computer, and then double-click the host name.
3. Right-click the shared printer name, and then click **Connect**.
4. Click **Install driver**.
5. Click **Continue in User Account Control** dialog.
6. Wait for the driver information to copy from the server computer to the client computer, and for a new printer object to be added to the **Printers** folder. The time this takes varies, based on network traffic and other factors.
7. Print a test page to verify print installation.
8. Click **Start**→**Control Panel**.
9. Select **Printer**.
10. Right-click the printer you just created and select **Properties**.
11. From the **General** tab, click **Print Test Page**.

When a test page prints successfully, printer installation is complete.

Peer-to-Peer

If you use the peer-to-peer method, the printer driver is fully installed on each client computer. Network clients retain control of driver modifications. The client computer handles the print job processing.

For Windows® XP, Windows XP 64-bit Edition, Windows Server® 2003, and Windows 2000:

1. Click **Start**→**Settings**→**Printers and Faxes (Printers for Windows 2000)**.
2. Click **Add Printer** to launch the **Add Printer** wizard.
3. Click **Next**.
4. Select **A network printer, or a printer attached to another computer**, and then click **Next** (For Windows 2000, select the network printer from the Shared printers list). If the printer is not listed, type in the path of the printer in the text box.
For example: \\<server host name>\<shared printer name>
The server host name is the name of the server computer that identifies it to the network. The shared printer name is the name assigned during the server installation process.
5. Click **Browse for a printer**, and then click **Yes** (For Windows 2000, click **OK**).
If this is a new printer, you may be prompted to install a printer driver. If no system driver is available, then you will need to provide a path to available drivers.
6. Select whether you want this printer to be the default printer for the client, click **Next**, and then click **Finish** (For Windows 2000, click **Finish**).
7. Print a test page to verify printer installation:
 - a. Click **Start**→**Settings**→**Printers and Faxes (Printers for Windows 2000)**.

- b. Select the printer you just created.
- c. Click **File**→ **Properties**.
- d. From the **General** tab, click **Print Test Page**.
When a test page prints successfully, printer installation is complete.

For Window Vista® and Windows Server 2008:

1. Click **Start**→ **Control Panel**→ **Hardware and Sound**→ **Printers** (**Start**→ **Control Panel**→ **Printers** for Windows Server 2008).
2. Click **Add a Printer** to launch the **Add Printer** wizard.
3. Select **Add a network, wireless or Bluetooth printer**, and then click **Next**. If the printer is listed, select the printer and click **Next**, or select **The printer that I want isn't listed** and type in the path of the printer in the **Select a shared printer by name** text box and click **Next**.
For example: \\<server host name>\<shared printer name>
The server host name is the name of the server computer that identifies it to the network. The shared printer name is the name assigned during the server installation process.
4. If this is a new printer, you may be prompted to install a printer driver. If no system driver is available, then you will need to provide a path to available drivers.
5. Select whether you want this printer to be the default printer for the client, click **Next**.
6. If you want to verify printer installation then click **Print a test page**.
7. Click **Finish**.

[back to contents page](#)

[back to contents page](#)

Clearing Jams

Careful selection of appropriate print media and proper loading allow you to avoid most jams. See "[Print Media Guidelines](#)" for more information.

- [Avoiding Jams](#)
- [Identifying the Location of Paper Jams](#)
- [Clearing Paper Jams From the Single Sheet Feeder](#)
- [Clearing Paper Jams From the Tray 1](#)
- [Clearing Paper Jams From the Fuser](#)

 **NOTE:** Before buying large quantities of any print media, Dell recommends trying a sample first.

Avoiding Jams

- 1 Use only recommended print media. See "[Print Media Guidelines](#)" for more information.
 - 1 See "[Loading Print Media in Tray 1](#)" and "[Loading the Single Sheet Feeder](#)" to load printer media properly.
 - 1 Do not overload the print media sources. Ensure that the stack print media height does not exceed the maximum height indicated by the load line labels in the tray.
 - 1 Do not load wrinkled, creased, damp, or curled print media.
 - 1 Flex, fan, and straighten print media before you load it. If a jam occurs with print media, try feeding one sheet at a time through the single sheet feeder.
 - 1 Do not use print media that you have cut or trimmed yourself.
 - 1 Do not mix print media sizes, weights, or types in the same print media source.
 - 1 Ensure that the recommended print side is face up when you insert the print media. Also, the recommended print side should be face down when using the single sheet feeder.
 - 1 Keep print media stored in an acceptable environment. For more information, see "[Storing Print Media](#)."
 - 1 Do not remove the feeding tray during a print job.
 - 1 Push the tray in firmly after loading.
 - 1 Ensure that all cables that connect to the printer are correctly attached.
 - 1 Overtightening the guides may cause jams.
 - 1 Wipe the separator rollers in the tray or single sheet feeder with a cloth that is slightly dampened with water if jams caused by misfeeding paper occur frequently.
-

Identifying the Location of Paper Jams

The following illustration shows where paper jams may occur along the print media path.

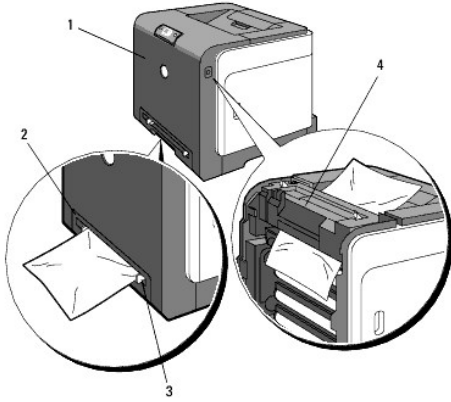

⚠ CAUTION: Do not attempt to clear any jams using tools or instruments. This may permanently damage the printer.

1	Front cover
2	Tray 1
3	Single sheet feeder
4	Fuser

Clearing Paper Jams From the Single Sheet Feeder

⌚ NOTICE: To protect the drums of the toner cartridges against bright light, close the front cover within three minutes. If the front cover remains open for more than three minutes, print quality may deteriorate.

🔧 NOTE: To resolve the error displayed on the operator panel, you must clear all print media from the print media path.

1. Pull the jammed paper out of the single sheet feeder. If no jammed paper can be found or it is hard to remove the paper, go to the next step to remove the jammed paper from the inside of the printer.

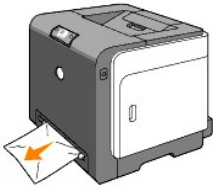

2. Remove the tray 1 from the printer, and then pull out the jammed paper remaining inside the printer. If no jammed paper can be found or it is hard to remove the paper, go to the next step to remove the jammed paper from the inside of the printer.

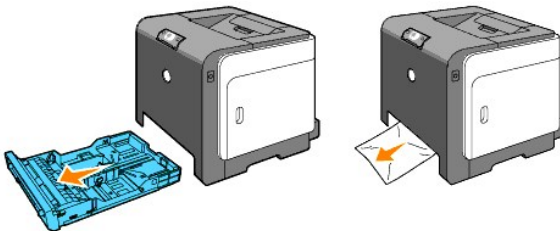

3. Open the front cover by pushing the button (right side) and remove the jammed paper. Then, confirm that there are no scraps of paper remaining inside the printer.

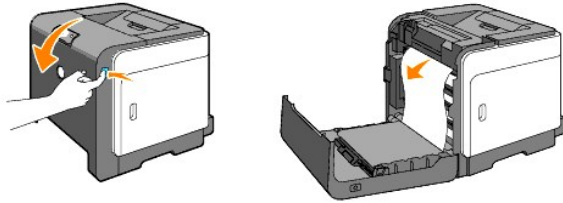

4. Close the front cover.
5. Insert the tray back into the printer, and push until it stops.

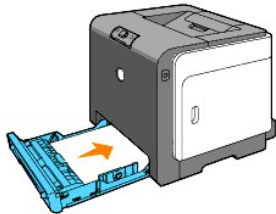

Clearing Paper Jams From the Tray 1

- 🔔 **NOTICE:** To protect the drums of the toner cartridges against bright light, close the front cover within three minutes. If the front cover remains open for more than three minutes, print quality may deteriorate.
- 🔧 **NOTE:** To resolve the error displayed on the operator panel, you must clear all print media from the print media path.

1. Pull the tray out of the printer carefully. Hold the tray with both hands, lift the front slightly, and remove it from the printer.

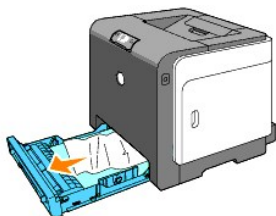

2. Remove all the jammed and/or creased paper from the tray.

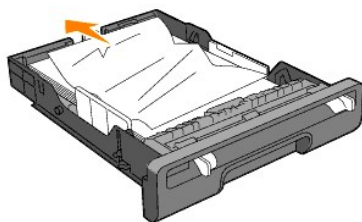

3. Pull the jammed paper out carefully to avoid tearing it. If it is still hard to remove the paper, go to the next step to remove the jammed paper from the inside of the printer.

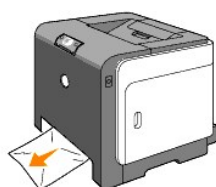

4. Open the front cover by pushing the button (right side) and remove the jammed paper. Then, confirm that there are no scraps of paper remaining inside the printer.

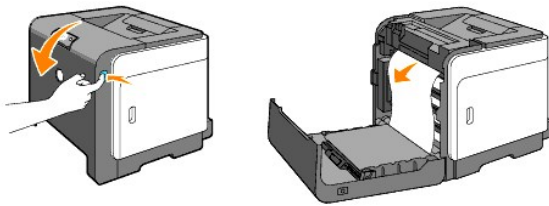

5. Close the front cover.



6. Insert the tray into the printer, and push until it stops.

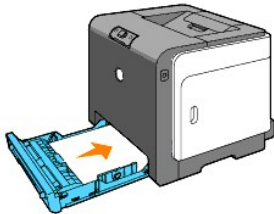

⚠ CAUTION: Do not use excessive force on the tray. Doing so could damage the tray or the inside of the printer.

Clearing Paper Jams From the Fuser

- ➡ **NOTICE:** Ensure nothing touches or scratches the surface (black-colored film) of the belt unit. Scratches, dirt, or oil from your hands on the film of the belt unit may reduce print quality.
- ➡ **NOTICE:** To protect the drums of the toner cartridges against bright light, close the front cover within three minutes. If the front cover remains open for more than three minutes, print quality may deteriorate.
- 🔧 **NOTE:** To resolve the error displayed on the operator panel, you must clear all print media from the print media path.

1. Turn off the printer and wait for 30 minutes.
2. Push the button (right side) and open the front cover.

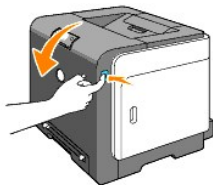

3. Lift the levers at both ends of the fuser, and remove the jammed paper. If any jammed paper cannot be found, go to the next step.

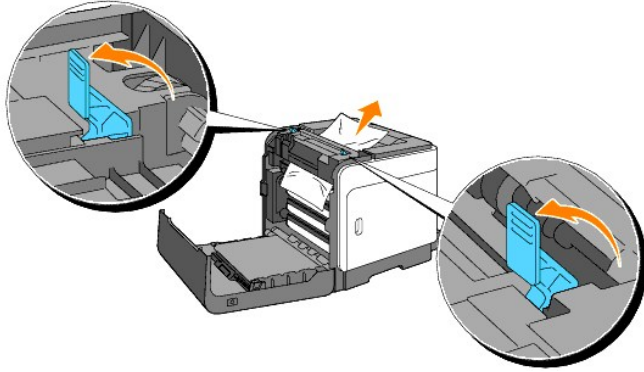

⚠ CAUTION: The fuser is hot. Do not touch it, doing so may cause burns.

4. Open the cover of the fuser and remove the jammed paper.
5. Close the cover of the fuser and press down the levers at both ends of the fuser.

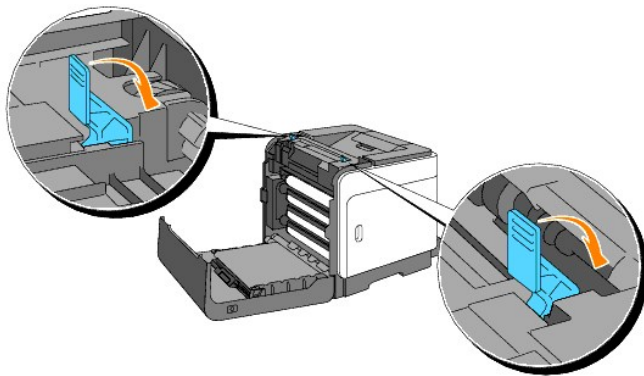

6. Confirm that there are no scraps of paper remaining inside the printer, and then close the front cover.



[back to contents page](#)

[back to contents page](#)

Troubleshooting Guide

- [Basic Printer Problems](#)
 - [Printing Problems](#)
 - [Print Quality Problems](#)
 - [Other Problems](#)
 - [Contacting Service](#)
-

Basic Printer Problems

Some printer problems can be easy to resolve. If a problem occurs with your printer, check each of the following:

- 1 The printer power cable is plugged into the printer and a properly grounded electrical outlet.
 - 1 The printer power is on.
 - 1 The electrical outlet is not turned off at any switch or breaker.
 - 1 Other electrical equipment plugged into the outlet are working.
 - 1 If you have checked all of the above and still have a problem, turn off the printer, wait for 10 seconds, and then turn on the printer. This often fixes the problem.
-

Printing Problems

Problem	Action
Job did not print or incorrect characters printed.	Ensure print media is loaded in the printer.
	Verify the printer is using the correct page description language (PDL).
	Verify that you are using the correct printer driver.
	Ensure you are using the correct Ethernet, or USB cable and that it is securely connected to the printer.
	Verify that the correct print media size is selected.
	If using a print spooler, verify that the spooler has not stalled.
	Check the printer interface from the Tool Box menu. Determine the host interface you are using. Print a Device Settings page to verify that the current interface settings are correct.
Print media misfeeds or multiple feeds occur.	Ensure the print media you are using meets the specifications for your printer. See " Print Media Supported " for more information.
	Flex print media before loading it in any of the sources.
	Ensure the print media is loaded correctly.
	Ensure the width and length guides on the print media sources are adjusted correctly.

	Ensure the Tray 1 is securely inserted.
	Do not overfill the print media sources.
	Do not force print media into the single sheet feeder when you load it; otherwise, it may skew or buckle.
	Remove any curled print media from sources.
	Load the recommended print side correctly for the type of print media you are using. See " Loading Print Media in Tray 1 " for more information.
	Turn the print media over or around and try printing again to see if feeding improves.
	Do not mix print media types.
	Do not mix reams of print media.
	Remove the top and bottom curled sheets of a ream before loading the print media.
	Load a print media source only when it is empty.
	Wipe the separator rollers in the tray or single sheet feeder with a cloth that slightly dampened with water.
The envelope is creased after printing.	When you print a Monarch, Youkei 2, or Youkei 3 envelope, use Tray 1 to load the envelope with the flap open when the long edge of the envelope faces in the printer.
Page breaks in unexpected places.	Increase the setting for Time-Out in the Printer Settings menu in the Dell Printer Configuration Web Tool .
Print media does not stack neatly in the output bin.	Turn the print media stack over in the tray.
Printer does not duplex pages.	Select Flip on Short Edge or Flip on Long Edge from the Duplex menu on the Print Setup tab in the printer driver.
Paper is curled in the Tray 1.	Load the paper into the single sheet feeder.

Print Quality Problems

Print is too light.



Is part or all of the print too light?

[All of the print is too light.](#)

[Part of the print is too light.](#)

All of the print is too light.

The toner cartridges may be low or need to be replaced. Confirm the amount of toner in each toner cartridge.

1. Press [Printer Status], and then click the Status tab in

the printer driver.

Ensure Non-Dell Toner is not selected in the Printer Maintenance tab in the Tool Box.

1. Click the **Tool Box** button.

Set Toner Saving Mode to Off in the printer driver.

1. Press [Printing Preferences], and then click the Advanced tab.

If you are printing on an uneven print surface, change the paper type setting in the printer driver. For example, change the plain paper to thick.

1. Press [Printing Preferences], and then click the Paper Tray tab.

Verify that the correct print media is being used.

1. See "[Print Media Sizes and Support](#)".

Ensure that eight yellow ribbons are correctly removed from the PHD (Print Head Device) unit.

1. See "[Replacing the PHD \(Print Head Device\) Unit](#)" and "[Installing the PHD Unit](#)".

Ensure that the developer motor starts.

1. Contact Dell.

Ensure that the dispense motor starts.

1. Contact Dell.

When you are printing many images with low density, do the Toner Refresh Mode.

1. Click the **Tool Box** button.
2. Press the Start button to check the density of colors.
3. If the print is too light, Select Refresh Mode from the list. Press the Start(1)-(4) buttons.

CAUTION: Using the Refresh Mode consumes extra toner.

4. After you complete the Refresh Mode, select Chart Print from the list. Press the Print with A4(3) or Print with Letter(C) button for 4 Colors Configuration Chart. "Printing" appears.
Is the problem recovered?

Yes. The task is complete.

No. The PHD unit is old or damaged. Replace the PHD unit.

Try the spare PHD unit, if possible.

1. Replace the PHD unit. See "[Replacing the PHD \(Print Head Device\) Unit](#)" and "[Installing the PHD Unit](#)".
2. After you replace the PHD unit, click the **Tool Box** button.
3. Press the Print with A4(3) or Print with Letter(C) button.
Is the problem recovered?

Yes. The PHD unit is old or damaged. Replace the PHD unit.

No. Contact Dell.

Contact Dell.

1. Contact Dell.

Part of the print is too light.

When you are printing many images with low density, do the Toner Refresh Mode.

1. Click the **Tool Box** button.
2. Press the Start button to check the density of colors.

<p>3. If the print is too light, Select Refresh Mode from the list. Press the Start(1)-(4) buttons.</p> <p>CAUTION: Using the Refresh Mode consumes extra toner.</p> <p>4. After you complete the Refresh Mode, select Chart Print from the list. Press the Print with A4(3) or Print with Letter(C) button for 4 Colors Configuration Chart. "Printing" appears.</p> <p>Is the problem recovered?</p>
<p>Yes. The task is complete.</p>
<p>No. The PHD unit is old or damaged. Replace the PHD unit.</p>
<p>Try the spare PHD unit, if possible.</p> <p>1. Replace the PHD unit. See "Replacing the PHD (Print Head Device) Unit" and "Installing the PHD Unit".</p> <p>2. After you replace the PHD unit, click the Tool Box button.</p> <p>3. Press the Print with A4(3) or Print with Letter(C) button.</p> <p>Is the problem recovered?</p>
<p>Yes. The PHD unit is old or damaged. Replace the PHD unit.</p>
<p>No. Contact Dell.</p>
<p>Contact Dell.</p>

Toner smears or print comes off page.

If you are printing on an uneven print surface, change the paper type setting in the printer driver. For example, change the plain paper to thick.



<p>1. Press [Printing Preferences], and then click the Paper Tray tab.</p> <p>Verify that the correct print media is being used.</p> <p>1. See "Print Media Sizes and Support."</p> <p>Try the spare PHD unit, if possible.</p> <p>1. Replace the PHD unit. See "Replacing the PHD (Print Head Device) Unit" and "Installing the PHD Unit".</p> <p>2. After you replace the PHD unit, print paper. "Printing" appears.</p> <p>Is the problem recovered?</p>
<p>Yes. The PHD unit is old or damaged. Replace the PHD unit.</p>
<p>No. Return to step 1.</p>
<p>Try the spare fuser, if possible.</p> <p>1. Replace the fuser. See "Removing the Used Fuser" and "Installing a New Fuser".</p> <p>2. After you replace the fuser, print paper. "Printing" appears.</p> <p>Is the problem recovered?</p> <p>Yes. The fuser is old or damaged. Replace the fuser.</p> <p>No. Contact Dell.</p>

Toner spots appear on the page/printing is blurred.

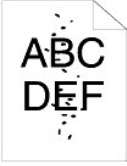

Check the toner cartridges is installed correctly.

1. See "[Installing the Toner Cartridges](#)."

Ensure the PHD unit is installed correctly.

1. See "[Replacing the PHD \(Print Head Device\) Unit](#)" and "[Installing the PHD Unit](#)".

Try the spare PHD unit, if possible.

1. Replace the PHD unit. See "[Replacing the PHD \(Print Head Device\) Unit](#)" and "[Installing the PHD Unit](#)."
2. After you replace the PHD unit, click the **Tool Box** button.
3. Press Print with A4(1) or Print with Letter(A). "Printing" appears.

Is the problem recovered?

Yes. The PHD unit is old or damaged. Replace the PHD unit.

No. Contact Dell.

Contact Dell.

Entire page is white.

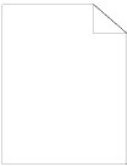

The toner cartridges may be low or need to be replaced. Confirm the amount of toner in each toner cartridge.

1. Press [Printer Status], and then click the Status tab in the printer driver.

Ensure Non-Dell Toner is not selected in the Printer Maintenance tab in the Tool Box.

1. Click the **Tool Box** button.

Set Toner Saving Mode to Off in the printer driver.

1. Press [Printing Preferences], and then click the Advanced tab.

If you are printing on an uneven print surface, change the paper type setting in the printer driver. For example, change the plain paper to thick.

1. Press [Printing Preferences], and then click the Paper Tray tab.

Verify that the correct print media is being used.

1. See "[Print Media Sizes and Support](#)".

Ensure that eight yellow ribbons are correctly removed from the PHD unit.

1. See "[Replacing the PHD \(Print Head Device\) Unit](#)" and "[Installing the PHD Unit](#)".

Ensure that the developer motor starts.

1. Contact Dell.

Ensure that the dispense motor starts.

1. Contact Dell.

Try the spare PHD unit, if possible.

1. Replace the PHD unit. See "[Replacing the PHD \(Print Head Device\) Unit](#)" and "[Installing the PHD Unit](#)".
2. After you replace the PHD unit, click the **Tool Box** button.
3. Press [Chart Print], and then press the Print with A4 (3) or Print with Letter(C) button.
Is the problem recovered?

Yes. The PHD unit is old or damaged. Replace the PHD unit.

No. Contact Dell.

Contact Dell.

Streaks appear on the page.

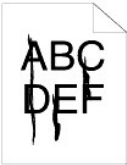

The toner cartridges may be low or need to be replaced.
Confirm the amount of toner in each toner cartridge.

1. Press [Printer Status], and then click the Status tab in the printer driver.

Ensure Non-Dell Toner is not selected in the Printer Maintenance tab in the Tool Box.

1. Click the **Tool Box** button.
2. Select Non-Dell Toner from the list.

Try the spare PHD unit, if possible.

1. Replace the PHD unit. See "[Replacing the PHD \(Print Head Device\) Unit](#)" and "[Installing the PHD Unit](#)".
2. After you replace the PHD unit, click the **Tool Box** button.
3. Press the Print with A4(1) or Print with Letter(A) button. "Printing" appears.
Is the problem recovered?

Yes. The PHD unit is old or damaged. Replace the PHD unit.

No. Contact Dell.

Contact Dell.

Part or all of the page prints in black.

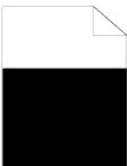

Ensure Color (Auto) is selected in Output Color on the

Print Setup tab in the printer driver.

1. Press [Printing Preferences], and then click the Print Setup tab.

Try the spare PHD unit, if possible.

1. Replace the PHD unit. See "[Replacing the PHD \(Print Head Device\) Unit](#)" and "[Installing the PHD Unit](#)".
2. After you replace the PHD unit, click the **Tool Box** button.
3. Press the Print with A4(3) or Print with Letter(C) button.

Is the problem recovered?

Yes. The PHD unit is old or damaged. Replace the PHD unit.

No. Contact Dell.

Contact Dell.

Pitched dots prints in color



Locate the cause of the problem by using the Pitch Configuration Chart.

1. Click the **Tool Box** button.
2. Press the Print with A4(1) or Print with Letter(A) button.
3. Do either of the following:

When the cause of the problem was located in the PHD unit:

1. Replace the PHD unit. See "[Replacing the PHD \(Print Head Device\) Unit](#)" and "[Installing the PHD Unit](#)".
2. After you replace the PHD unit, click the **Tool Box** button.
3. Press the Print with A4(1) or Print with Letter(A) button. "Printing" appears.
Is the problem recovered?

Yes. The PHD unit is old or damaged. Replace the PHD unit.

No. Contact Dell.

When the cause of the problem was located in the fuser:

1. Replace the fuser. See "[Removing the Used Fuser](#)" and "[Installing a New Fuser](#)".
2. After you replace the fuser, click the **Tool Box** button.
3. Press the Print with A4(1) or Print with Letter(A) button. "Printing" appears.
Is the problem recovered?

Yes. The fuser is old or damaged. Replace the fuser

No. Contact Dell.

When the cause of the problem was located in the printer:

1. Contact Dell.

Vertical blanks

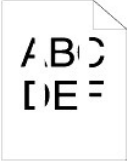

Ensure the light path is not covered.

1. Remove the PHD unit, and keep in the dark place. See "[Replacing the PHD \(Print Head Device\) Unit](#)".
2. Check the light path, and then remove the shielding.
3. Reinstall the PHD unit. See "[Installing the PHD Unit](#)".
4. Click the **Tool Box** button.
5. Press the Print with A4(1) or Print with Letter(A) button. "Printing" appears.
Is the problem recovered?

Yes. The task is complete.

No. Go to the next step.

Try the spare PHD unit, if possible.

1. Replace the PHD unit. See "[Replacing the PHD \(Print Head Device\) Unit](#)" and "[Installing the PHD Unit](#)".
2. After you replace the PHD unit, click the **Tool Box** button.
3. After you replace the PHD unit, press the Print with A4 (1) or Print with Letter(A) button. "Printing" appears.
Is the problem recovered?

Yes. The PHD unit is old or damaged. Replace the PHD unit.

No. Contact Dell.

Contact Dell.

Ghost

Locate the cause of the problem by using the Ghost Configuration Chart.

1. Click the **Tool Box** button.
2. Press the Print with A4(2), or Print with Letter(B) button.
Do either of the following:

When the ghost is printed in positive, try the spare PHD unit, if possible.

1. See "[Replacing the PHD \(Print Head Device\) Unit](#)" and "[Installing the PHD Unit](#)".
2. After you replace the PHD unit, press [Chart Print], and then press the Print with A4(2), or Print with Letter(B) button. "Printing" appears.
Is the problem recovered?

Yes. The PHD unit is old or damaged. Replace the PHD unit.

No. Contact Dell.

When the ghost is printed in negative, use the recommended paper.

Is the problem recovered?

Yes. The task is complete.

No. Do either of the following:

Try the spare PHD unit, if possible.

1. Replace the PHD unit. See "[Replacing the PHD \(Print Head Device\) Unit](#)" and "[Installing the PHD Unit](#)".
2. After you replace the PHD unit, click the **Tool Box** button, and then press the Print with A4(2), or Print with Letter(B) button. "Printing" appears.
Is the problem recovered?

Yes. The PHD unit is old or damaged. Replace the PHD unit.

No. Contact Dell.

Adjust the transfer bias.

1. Click the **Tool Box** button.
2. Adjust the setting for the paper type, and then press

- the Apply New Settings button.
- Click the **Tool Box** button.
 - Press the Print with A4(2) or Print with Letter (B) button.

Light fatigue



Check the pattern for light fatigue.

- Click the **Tool Box** button.
- Press the Print with A4(1) or Print with Letter(A) button. "Printing" appears. Is the pattern matched?

Yes. Do the PHD Refresh Mode.

- Click the **Tool Box** button.
- After you start the PHD Refresh Mode, click the **Tool Box** button, and then press the Print with A4(3), or Print with Letter(C) button. "Printing" appears. Is the problem recovered?

Yes. The task is complete.

No. Replace the PHD unit. See "[Replacing the PHD \(Print Head Device\) Unit](#)" and "[Installing the PHD Unit](#)".

No. Contact Dell.

Fog



Do the PHD Refresh Mode.

- Click the **Tool Box** button.
- After you complete the Refresh Mode, select Chart Print from the list. Press the Print with A4 (3) or Print with Letter (C) button. "Printing" appears. Is the problem recovered?

Yes. The task is complete.

No. Replace the PHD unit, if possible. See "[Replacing the PHD \(Print Head Device\) Unit](#)" and "[Installing the PHD Unit](#)".

After you complete the Refresh Mode, select Chart Print from the list. Press the Print with A4 (3) or Print with Letter (C) button. "Printing" appears.

Is the problem recovered?

Yes. The task is complete.

No. Contact Dell.

Bead-Carry-Out (BCO)



<p>Do Adjust Altitude if you install the printer in a high altitude location.</p> <ol style="list-style-type: none">1. Click the Tool Box button.2. Selects the value close to the height of the location to install the printer.
<p>Is the problem recovered?</p>
<p>Yes. The task is complete.</p>
<p>No. Replace the PHD unit, if possible. See "Replacing the PHD (Print Head Device) Unit" and "Installing the PHD Unit".</p>
<p>Is the problem recovered?</p>
<p>Yes. The PHD unit is old or damaged. Replace the PHD unit.</p>
<p>No. Contact Dell.</p>

Banding

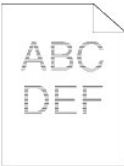

<p>Locate the cause of the problem by using the Pitch Configuration Chart.</p> <ol style="list-style-type: none">1. Click the Tool Box button.2. Press Print with A4(1), or Print with Letter(A).3. Do either of the following:
<p>The cause of the problem was located in the PHD unit.</p> <ol style="list-style-type: none">1. Replace the PHD unit. See "Replacing the PHD (Print Head Device) Unit" and "Installing the PHD Unit".2. After you replace the PHD unit, press Print with A4(1), or Print with Letter(A). "Printing" appears. Is the problem recovered?
<p>Yes. The task is complete.</p>
<p>No. Contact Dell.</p>
<p>The cause of the problem was located in the fuser.</p> <ol style="list-style-type: none">1. Replace the fuser. See "Removing the Used Fuser" and "Installing a New Fuser".2. After you replace the fuser, press Print with A4(1), or Print with Letter(A). "Printing" appears. Is the problem recovered?
<p>Yes. The task is complete.</p>
<p>No. Contact Dell.</p>
<p>The cause of the problem was located in the printer, or the cause was not determined.</p> <ol style="list-style-type: none">1. Contact Dell.

Auger mark



Is the error print match with the pattern for the auger mark?
Yes. Click the Tool Box button.
<ol style="list-style-type: none">1. Press the Start button.2. After you perform the Developer Stir Mode, click the Tool Box button, and then press Print with A4(1) or Print with Letter(A). "Printing" appears. Is the problem recovered?
Yes. The task is complete.
No. Replace the PHD unit. See " Replacing the PHD (Print Head Device) Unit " and " Installing the PHD Unit ".
No. Replace the PHD unit. See " Replacing the PHD (Print Head Device) Unit " and " Installing the PHD Unit ".
Contact Dell.

Abnormal noise

Locate the cause of the problem by removing the toner cartridges, fuser, and PHD unit.
<ol style="list-style-type: none">1. Remove the toner cartridges, fuser, and PHD unit. See "Removing the Used Toner Cartridge", "Removing the Used Fuser", and "Replacing the PHD (Print Head Device) Unit".2. Click the Tool Box button.3. Press the Start button after selecting Main Motor Operation Check, Fuser Motor Operation Check, and Dispense Motor Check to identify the abnormal noise. Check if the noise from the Play of Sound button is matched with the abnormal noise.
<ol style="list-style-type: none">1. Is the noise from Main Motor Operation Check matched?
Yes. Contact Dell.
No. Go to the next step.
<ol style="list-style-type: none">2. Is the noise from Fuser Motor Operation Check matched?
Yes. Contact Dell.
No. Go to the next step.
<ol style="list-style-type: none">3. Is the noise from Dispense Motor Check matched?
 NOTE: Do not check the operation of the dispense motor repeatedly.
Yes. Contact Dell.
No. Replace the fuser. See " Removing the Used Fuser " and " Installing a New Fuser ".
<ol style="list-style-type: none">4. Is the noise from Fuser Motor Operation Check matched?
Yes. Contact Dell.
No. Replace the PHD unit. See " Replacing the PHD (Print Head Device) Unit " and " Installing the PHD Unit ".

5. Is the noise from Main Motor Operation Check matched?
Yes. Contact Dell.

Jam/Alignment



The job prints, but the top and side margins are incorrect.
1. Ensure the margins are set correctly in your software program.



Color registration is out of alignment. Do either of the following:
1. Click the Tool Box button. 2. Press the Start button for Color Regi Chart.
Is the problem recovered?
Yes. The task is complete.
No. Try the spare PHD unit, if possible.
1. Replace the PHD unit. See " Replacing the PHD (Print Head Device) Unit " and " Installing the PHD Unit ". 2. After you replace the PHD unit, click the Tool Box button. 3. Press the Start button for Auto Correct. Is the color chart matched with the error paper?
Yes. The PHD unit is old or damaged. Replace the PHD unit. See " Replacing the PHD (Print Head Device) Unit " and " Installing the PHD Unit ".
No. Press the Start button for Color Regi Chart.
Is the color chart matched with the error paper?
Yes. The task is complete.
No. Check the offset value shown in the printed chart, and then specify each value for Color Registration Adjustment 1 (Lateral) and Color Registration Adjustment 2 (Process) and then press the Start button for Color Regi Chart.
Is the color chart matched with the error paper?
Yes. The task is complete.
No. Contact Dell.
Contact Dell.

Misfeed jam

<p>Are the width and length guides on the print media sources adjusted correctly?</p> <p>Yes.</p> <p>No. Use the correct print media.</p>
<p>Is the Tray 1 installed correctly?</p> <p>Yes. Check the paper type.</p>
<p>Thick</p> <p>Is thick paper 216 gsm or lower?</p>
<p>Yes. Flex print media before loading it.</p>
<p>No. Use paper at 216 gsm or lower.</p>
<p>Is the problem recovered?</p>
<p>Yes. The task is complete.</p>
<p>No. Flex print media before loading it.</p>
<p>Thin</p> <p>Is thin paper 60 gsm or more?</p>
<p>Yes. Flex print media before loading it.</p>
<p>No. Use paper at 60 gsm or more.</p>
<p>Is the problem recovered?</p>
<p>Yes. The task is complete.</p>
<p>No. Flex print media before loading it.</p>
<p>Coated</p> <p>Load one sheet of coated paper at one time.</p> <p>Is the problem recovered?</p>
<p>Yes. The task is complete.</p>
<p>No. Wipe the separator rollers in the tray with a cloth that slightly dampened with water.</p>
<p>Envelope</p> <p>Is the envelope inserted with the flap closed and the short-edge of the envelope facing down from the single sheet feeder?</p>
<p>Yes. The envelope is curled.</p>
<p>1. Straighten the curl.</p>
<p>Is the problem recovered?</p>
<p>Yes. The task is complete.</p>
<p>No. Flex print media before loading it.</p>
<p>No. Use the other envelope.</p>
<p>Is the problem recovered?</p>
<p>Yes. The task is complete.</p>
<p>No. Flex print media before loading it.</p>
<p>No. Face the short-edge of the envelope into the printer.</p>
<p>Transparency</p> <p>Transparency cannot be used.</p>
<p>Manual Duplex</p> <p>Is paper curled?</p>
<p>Yes. The paper is curled.</p>
<p>1. Straighten the curl.</p>
<p>Is the problem recovered?</p>
<p>Yes. The task is complete.</p>
<p>No. Flex print media before loading it.</p>
<p>No. Flex print media before loading it.</p>
<p>Others</p> <p>Is paper moistened?</p>
<p>Yes. Turn the paper upside down.</p>
<p>Is the problem recovered?</p>
<p>Yes. The task is complete.</p>

No. Use the dry paper.
Is the problem recovered?
Yes. The task is complete.
No. Flex print media before loading it.
Is the problem recovered?
Yes. The task is complete.
No. Wipe the separator rollers in the tray with a cloth that slightly dampened with water.
Is the problem recovered?
Yes. The task is complete.
No. Replace the toner cartridge.
Is the problem recovered?
Yes. The task is complete.
No. Contact Dell.

Regi jam

Ensure the PHD unit is installed correctly.
1. Replace the PHD unit. See " Replacing the PHD (Print Head Device) Unit " and " Installing the PHD Unit ".
Is the problem recovered?
Yes. The task is complete.
No. Contact Dell.

Exit Jam

Ensure the fuser is installed correctly.
1. Replace the fuser. See " Removing the Used Fuser " and " Installing a New Fuser ".
Is the problem recovered?
Yes. The task is complete.
No. Contact Dell.

Multi-feed jam

Is the toner cartridge installed correctly?
Yes. Check the paper type.
No. Replace the toner cartridge correctly. See " Removing the Used Toner Cartridge " and " Installing a New Toner Cartridge ".
Coated
Load one sheet of coated paper at one time.
Others
Is paper moisten?
Yes. Use the dry paper.
Is the problem recovered?
Yes. The task is complete.
No. Flex print media before loading it.
No. Flex print media before loading it.
Is the problem recovered?
Yes. The task is complete.
No. Wipe the separator rollers in the tray with a cloth that slightly dampened with water.

Is the problem recovered?
Yes. The task is complete.
No. Replace the separator roller. See " Replacing Separator Roller ".
Is the problem recovered?
Yes. The task is complete.
No. Replace the toner cartridge.

Creased/stained paper

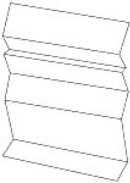

<p>Verify that the correct print media is being used.</p> <p>1. See "Print Media Sizes and Support".</p> <p>If you use paper that Dell does not recommend, use the standard paper.</p> <p>Is the problem recovered?</p> <p>Yes. Use the other type of paper because your printer does not support the paper you use.</p> <p>No. Go to the next step.</p> <p>1. See "Print Media Sizes and Support".</p> <p>If you use paper that Dell does not recommend, use the standard paper, and do the Paper Wrinkle Check Mode.</p> <p>1. Click the Tool Box button.</p> <p>2. Press the Start button.</p> <p>Is the paper wrinkled?</p> <p>Yes. Contact Dell.</p> <p>No. Replace the fuser.</p> <p>If you use an envelope that Dell does not recommend, use the standard envelope.</p> <p>Is the problem recovered?</p> <p>Yes. The task is complete.</p> <p>No. Check the crease. Is the crease found within 30 mm of the four edges of the envelope?</p> <p>Yes. This type of crease may be caused by the normal operation.</p> <p>No. Is the envelope 220 mm long or more?</p> <p>Yes. (The type of your envelope is C5, ChoKei3, COM-10, YoKei4, or YochoKei.) Does the envelope have the flap on the long edge or short edge?</p> <p>- Flap on the long edge (C5, or ChoKei3).</p> <p>Open the flap, and load the flap face down in Tray 1.</p> <p>Is the problem recovered?</p> <p>Yes. The task is complete.</p> <p>No. Use the other type of envelope.</p> <p>Is the problem recovered?</p> <p>Yes. The task is complete.</p> <p>No. Contact Dell.</p> <p>- Flap on the short edge (COM-10, YoKei4, or YochoKei).</p> <p>Use the other type of envelope.</p> <p>No. Open the flap, and load the flap face down in Tray 1.</p> <p>Is the problem recovered?</p> <p>Yes. The task is complete.</p> <p>No. Use the other type of envelope.</p> <p>Is the problem recovered?</p> <p>Yes. The task is complete.</p> <p>No. Contact Dell.</p>
--

Cannot print from Tray 1 because the Covers paper is curled.
Load the Covers paper into the single sheet feeder.

Other Problems

Problem	Action
Condensation has occurred inside the printer.	This usually occurs within several hours after you heat the room in winter. This also occurs when the printer is operating in a location where relative humidity reaches 85% or more. Adjust the humidity or relocate the printer to an appropriate environment.
"092-310 Printer error." or "092-910 Clean the CTD sensor." is displayed on the Status Monitor.	Clean the CTD sensor. See " Cleaning the CTD Sensor Inside the Printer. "

Contacting Service

When you call for printer service, be prepared to describe the problem you are experiencing or the error message on the display.

You need to know your printer model type and serial number. See the label on the back of the printer near the controller card for this information.

[back to contents page](#)

[back to contents page](#)

Maintaining Your Printer

Periodically, your printer requires you to complete certain tasks to maintain optimum print quality. If several people are using the printer, you may want to designate a key operator to maintain your printer. Refer printing problems and maintenance tasks to this key operator.

- [Determining the Status of Supplies](#)
- [Conserving Supplies](#)
- [Ordering Supplies](#)
- [Storing Print Media](#)
- [Storing Consumables](#)
- [Replacing Toner Cartridges](#)
- [Replacing the PHD \(Print Head Device\) Unit](#)
- [Replacing the Fuser](#)
- [Replacing Separator Roller](#)
- [Cleaning the CTD Sensor Inside the Printer](#)
- [Adjusting Color Registration](#)

Determining the Status of Supplies

If your printer is connected to the network, the **Dell™ Printer Configuration Web Tool** (EWS) can provide instant feedback on remaining toner levels. Type the printer IP address in your Web browser to view this information. To use the E-Mail Alert Setup feature that notifies you when the printer requires new supplies, type your name or the name of the key operator in the e-mail list box.

Conserving Supplies

You can change several settings in your printer driver to conserve toner cartridge and paper.

Supply	Setting	Function
Toner cartridge	Toner Saving Mode in the Advanced tab	This check box allows the users to select a print mode that uses less toner. When this feature is used, the image quality will be lower than when it is not used.
Print media	Multiple Up in the Print Setup tab	The printer prints two or more pages on one side of a sheet. Values for Multiple Up are 2 Up, 4 Up, 8 Up, 16 Up, or 32 Up. Combined with the duplex setting, Multiple Up allows you to print up to 64 pages on one sheet of paper. (32 images on the front and 32 on the back)

Ordering Supplies

You can order consumables from Dell on the Internet when using a networked printer. Type the IP address of your printer in your Web browser, launch the **Dell Printer Configuration Web Tool**, and click the **Order Supplies at:** to order toner for your printer.

You can also order toner cartridges by the following method.

1. Click **Start**→ **All Programs**→ **Dell Printers**→ **Additional Color Laser Software**→ **Dell Supplies Management System**.

The **Dell Supplies Management System** window appears.

2. Select your printer from the **Select Printer Model** list.
3. If ordering from the Web:
 - a. When you cannot get information from the printer automatically by two-way communication, a window that prompts you to type the Service Tag

number appears. Type your Dell printer Service Tag number in the field provided. Your Service Tag number is located inside the side cover of your printer.

- b. Select a URL from the **Select Reorder URL** list.
 - c. Click **Visit Dell printer supplies ordering web site**.
4. If ordering by phone, call the number that appears under the **By Telephone** heading.
-

Storing Print Media

To avoid potential paper feeding problems and uneven print quality, there are several things you can do.

- 1 To achieve the best possible print quality, store print media in an environment where the temperature is approximately 21°C (70°F) and the relative humidity is 40%.
 - 1 Store cartons of print media on a pallet or shelf, rather than directly on the floor.
 - 1 If you store individual packages of print media out of the original carton, ensure that they rest on a flat surface so the edges do not buckle or curl.
 - 1 Do not place anything on top of the print media packages.
-

Storing Consumables

Store consumables in their original packaging until you need to use them. Do not store consumables in:

- 1 Temperatures greater than 40°C (104°F).
 - 1 An environment with extreme changes in humidity or temperature.
 - 1 Direct sunlight.
 - 1 Dusty places.
 - 1 A car for a long period of time.
 - 1 An environment where corrosive gases are present.
 - 1 An environment with salty air.
-

Replacing Toner Cartridges

 **CAUTION:** Before performing any of the following procedures, read and follow the safety instructions in your *Product Information Guide*.

 **NOTICE:** To protect the drums of the toner cartridges against bright light, close the front cover within three minutes. If the front cover remains open for more than three minutes, print quality may deteriorate.

Dell toner cartridges are available only through Dell. You can order more cartridges online at <http://www.dell.com/supplies> or by phone. To order by phone, see "[Contacting Dell™](#)" on page 215.

Dell recommends that you use Dell toner cartridges for your printer. Dell does not provide warranty coverage for problems caused by using accessories, parts, or components not supplied by Dell.

 **CAUTION:** Never throw used toner cartridges into fire. The residual toner could explode resulting in burns and injuries.

 **CAUTION:** Do not shake the used toner cartridge to avoid spilling of toner.

Removing the Used Toner Cartridge

1. Open the side cover.



2. Push the latch(es) backwards to pop open the toner cartridge(s) that you want to replace.

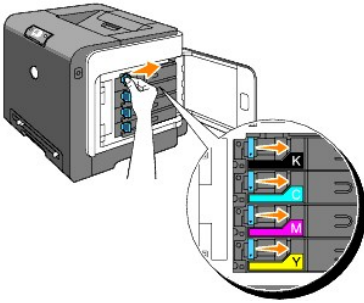

3. Pull the cartridge holder until it clicks, and then pull out the toner cartridge.



⚠ CAUTION: Do not shake the toner cartridge as it may spill some toner.

Installing a New Toner Cartridge

1. Ensure that the color of the new toner cartridge matches that on the handle before replacing it. Shake the toner cartridge five or six times to distribute the toner evenly.

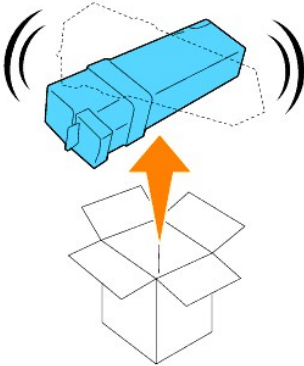

2. Insert the toner cartridge into the associated cartridge holder, and slide the latches of the toner cartridge.

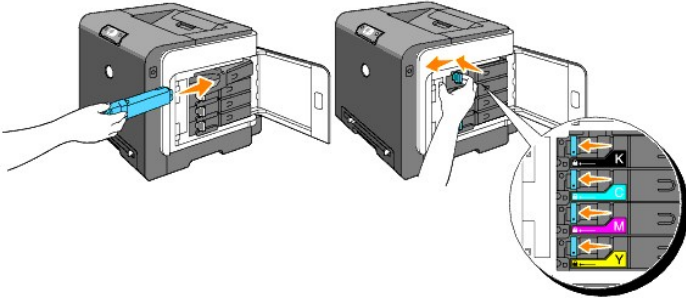

3. Close the side cover.



Replacing the PHD (Print Head Device) Unit

1. Ensure that the printer is turned off.
2. Press the button (right side) and open the front cover.

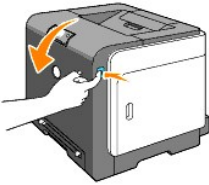

3. Turn the four PHD lock levers counterclockwise.

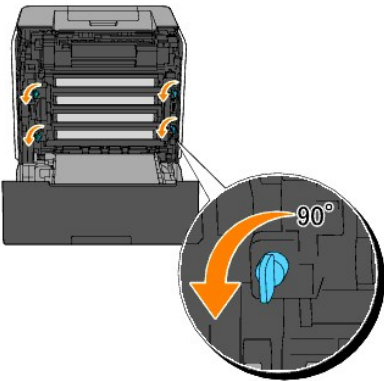

4. Pull the PHD unit out of the printer.

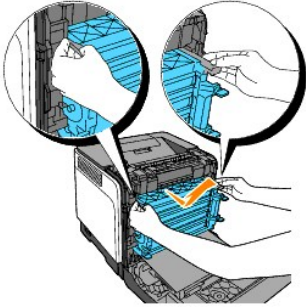

Installing the PHD Unit

1. Open the PHD packaging.

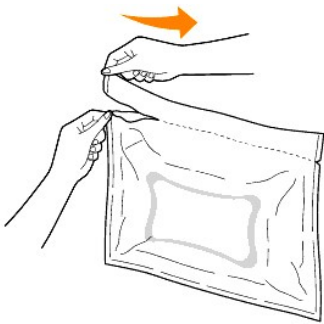

2. Pull out the PHD unit from the packaging.

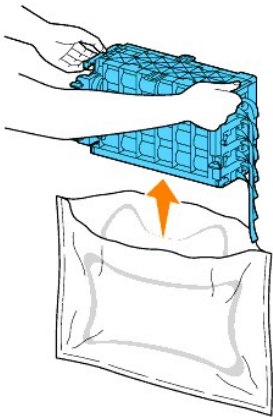

3. Completely remove the eight yellow ribbons from the PHD unit.

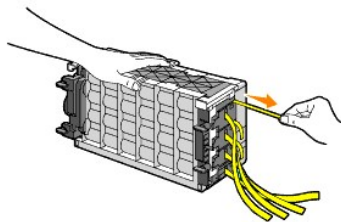

4. Remove the rear protective cover from the PHD unit.

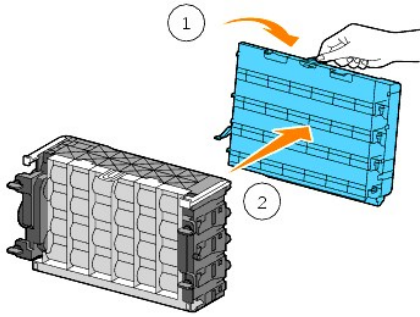

5. Insert the PHD unit until it is seated properly and turn the four PHD lock levers clockwise to lock the PHD unit.

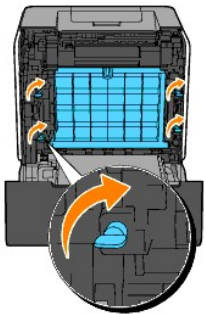

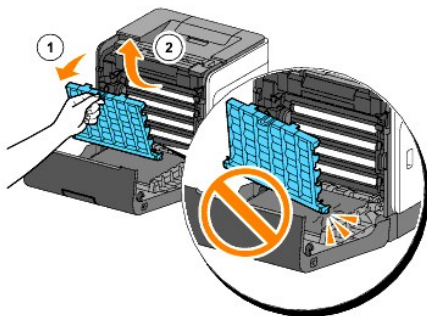

6. Carefully remove the front protective cover from the PHD unit.



7. Close the front cover.



Replacing the Fuser

-  **CAUTION:** A CAUTION indicates a potential for property damage, personal injury, or death.
-  **CAUTION:** To prevent electric shock, always turn off the printer and disconnect the power cable from the grounded outlet before performing maintenance.
-  **CAUTION:** Before performing any of the following procedures, read and follow the safety instructions in your *Product Information Guide*.

🕒 **NOTICE:** To protect the drums of the toner cartridges against bright light, close the front cover within three minutes. If the front cover remains open for more than three minutes, print quality may deteriorate.

🗑️ **NOTE:** Remove any print jobs from the output tray, and close the multipurpose feeder before opening the front cover.

Dell fuser is available only through Dell. To order by phone, see ["Contacting Dell™" on page 215](#).

Dell recommends Dell fuser for your printer. Dell does not provide warranty coverage for problems caused by using accessories, parts, or components not supplied by Dell.

Removing the Used Fuser

⚠️ **CAUTION:** To avoid burns, do not replace the fuser immediately after printing, as the fuser gets very hot during this process.

1. Turn off the printer and wait for 30 minutes for the fuser to cool down before removal.
2. Push the button (right side) and open the front cover.

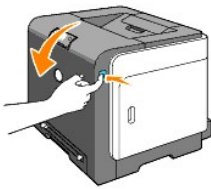

3. Press the button on the right side of the fuser.

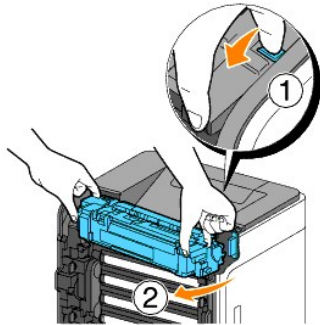

4. By holding both sides of the installed fuser, slightly fix the left side of the fuser and turn the right edge towards the front of the printer.

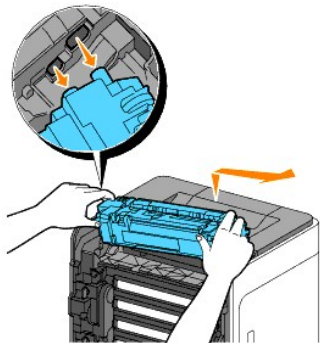

Installing a New Fuser

1. Unpack a new fuser and hold both sides of the fuser with both hands.
2. Insert the left edge of the fuser to the wholes inside of the printer.

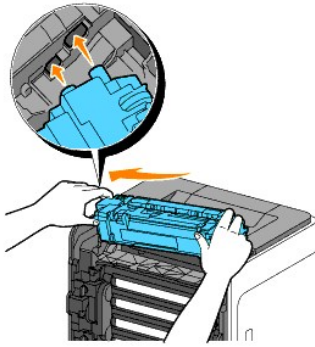

3. By turning the right side of the fuser towards the rear of printer, insert the right notch into the holder inside the printer.

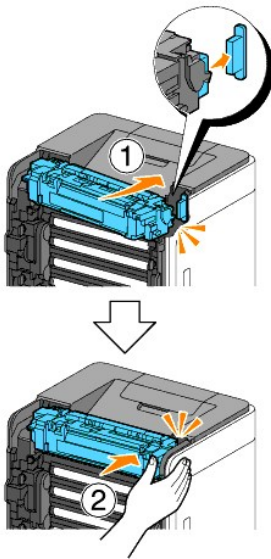

4. Close the front cover.



Replacing Separator Roller

Keeping the separator roller in the paper tray clean helps ensure the best possible copies. Dell recommends cleaning the separator at regular intervals.

- ⚠ CAUTION:** To prevent electric shock, always turn off the printer and disconnect the power cable from the grounded outlet before performing maintenance.
- ⚠ CAUTION:** Before performing any of the following procedures, read and follow the safety instructions in your *Product Information Guide*.

Dell separator rollers are available only through Dell. To order by phone, see ["Contacting Dell™" on page 215](#).

Dell recommends Dell separator rollers for your printer. Dell does not provide warranty coverage for problems caused by using accessories, parts, or components not supplied by Dell.

Removing the Used Separator Roller in the Tray 1

NOTE: Remove all paper or media from the tray before pulling the tray out of the printer.

1. Pull the Tray 1 out of the printer carefully. Hold the tray with both hands, lift the front slightly, and remove it from the printer.

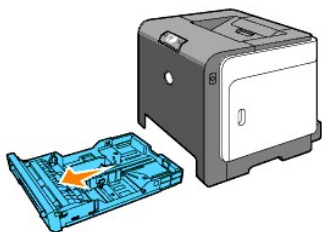

NOTE: Ensure that you remove all the paper from the Tray 1 before removing the separator roller.

NOTE: Carefully replace the Tray 1 so it does not fall down.

2. By holding the separator roller tabs with your fingers, pull the separator roller out of the groove in the axle.

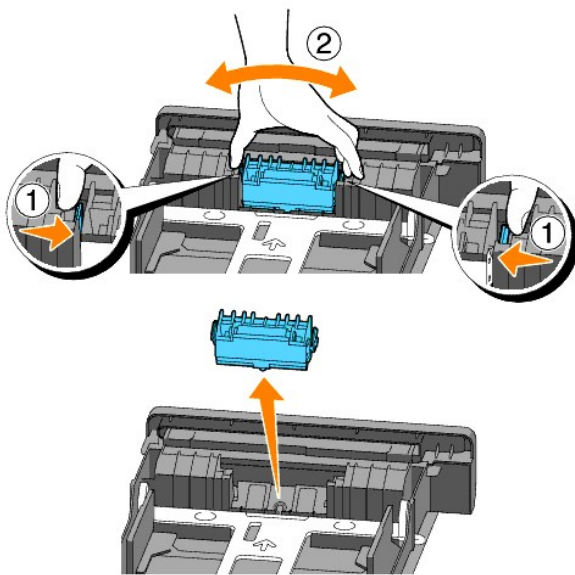

Installing the New Separator Roller in the Tray

1. Align the new separator roller to the groove on the axle.

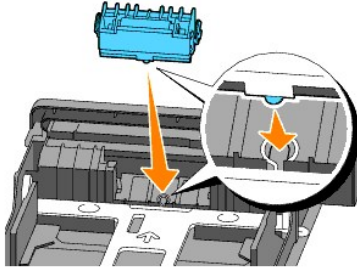

2. Insert the separator roller into the axle till it snaps fit so the protrusions fit completely into the slots and the roller hook reseats into the groove on the axle.

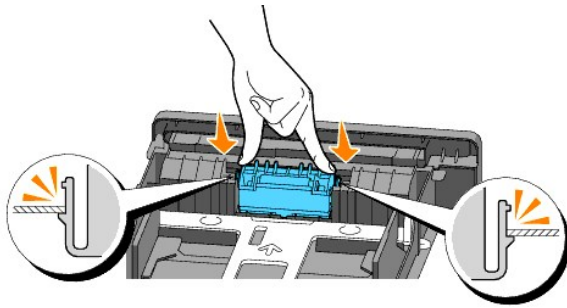

3. Load paper and place it in the printer.
Be sure to use the output tray extension before printing a Legal-size document.

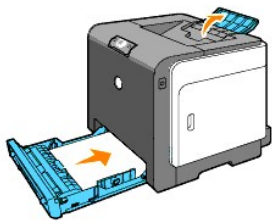

Cleaning the Separator Roller Inside the Printer

Clean the separator roller inside the printer if print media does not feed correctly.

1. Ensure that the printer is turned off.
2. Push the button (right side) and open the front cover.

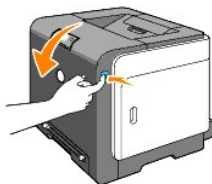

3. Turn the four PHD lock levers counterclockwise, and then pull the PHD unit out of the printer.

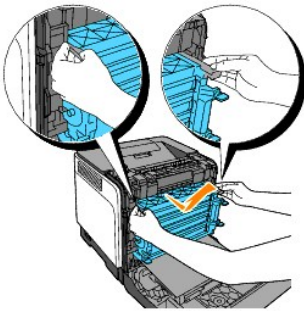
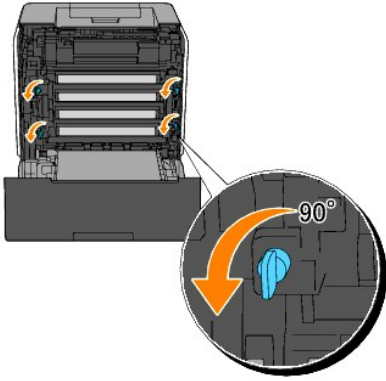

 **NOTE:** Keep the PHD unit in the dark place.

4. Clean the separator roller inside the printer with a clean dry cotton swab.

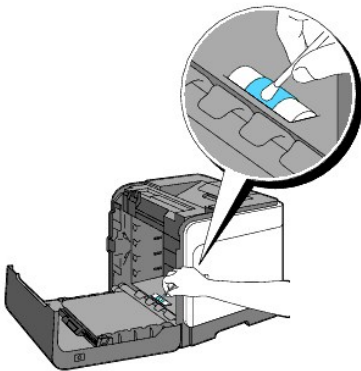

5. Insert the PHD unit until it stops and turn the four PHD lock levers clockwise to lock the PHD unit.

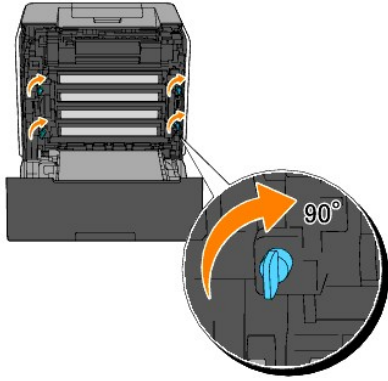

6. Close the front cover.

Cleaning the CTD Sensor Inside the Printer

Clean the CTD sensor only when an alert for the CTD sensor is shown on the Status Monitor or operator panel.

1. Ensure that the printer is turned off.
2. Push the button (right side) and open the front cover.

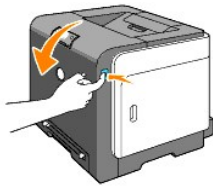

3. Clean the CTD sensor inside the printer with a clean dry cotton swab.

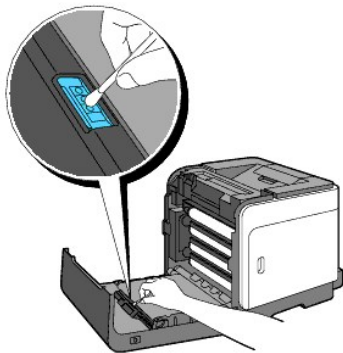

4. Close the front cover.

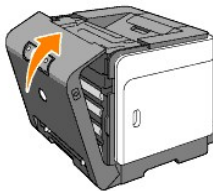

Adjusting Color Registration

To adjust the color registration when you first install the printer or after moving it to a new location, follow the procedure below.

Printing the Color Registration Chart

Use the Tool Box to print the color registration chart.

1. Click **Start**→ **All Programs**→ **Dell Printers**→ **Additional Color Laser Software**→ **Status Monitor Console**.
The Printer Selection dialog box opens.
2. Click **Dell Color Laser 1320c** listed in Printer Name.
The Dell Color Laser 1320c Launcher window opens.
3. Click the **Tool Box** button.
The Tool Box opens.
You can also launch the Tool Box from the printer icon on the taskbar.
4. Click the **Printer Maintenance** tab.
5. Select **Registration Adjustment** from the list at the left side of the page.
The Registration Adjustment page is displayed.
6. Click the **Start** button next to Color Regi Chart.
The Color Regi Chart page is printed.

Determining Values

From the lines to the right of the **Y** (Yellow), **M** (Magenta), and **C** (Cyan) pattern, find the values of the straightest lines.

 **NOTE:** You can also use the densest colors of the lattice pattern to find the straightest lines. The colors printed at the highest density are those next to the straightest lines. When 0 is the value nearest the straightest line, you do not need to adjust the color registration. When the value is not 0, follow the procedure outlined in "[Entering Values](#)".

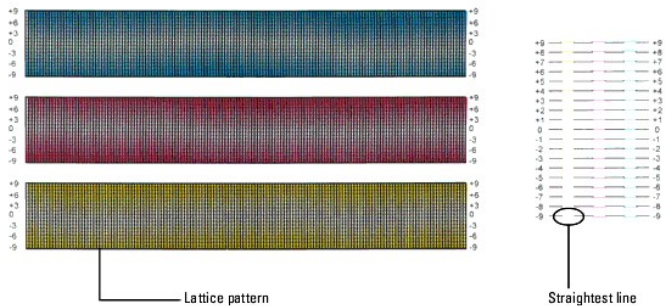

Entering Values

Using the Tool Box, enter the values that you found in the color registration chart to make adjustments.

1. Click **Start**→ **All Programs**→ **Dell Printers**→ **Additional Color Laser Software**→ **Status Monitor Console**.
The Printer Selection dialog box opens.
2. Click **Dell Color Laser 1320c** listed in Printer Name.
The Dell Color Laser 1320c Launcher window opens.
3. Click the **Tool Box** button.
The Tool Box opens.
You can also launch the Tool Box from the printer icon on the taskbar.
4. Click the **Printer Maintenance** tab.
5. Select **Registration Adjustment** from the list at the left side of the page.
The Registration Adjustment page is displayed.
6. Select the value with the straight line, and then click the **Apply New Settings** button.
7. Click the **Start** button next to Color Regi Chart.
The color registration chart is printed with the new values.
8. Adjust till all straight lines are at the value of 0. Show image of before and after adjustment will help.

 **CAUTION:** After printing the color registration chart, do not turn off the printer until the printer motor has stopped running.

 **NOTE:** If 0 is not next to the straightest lines, determine the values and adjust the printer again.

[back to contents page](#)

[back to contents page](#)

Printer Specifications

- [OS Compatibility](#)
 - [Power Supply](#)
 - [Dimensions](#)
 - [Memory](#)
 - [Page Description Language \(PDL\)/Emulation, Operating System, and Interface](#)
 - [Environmental](#)
 - [Cables](#)
-

OS Compatibility

Your Dell™ Color Laser Printer 1320c is compatible with Windows® (Windows XP, Windows XP 64-bit Edition, Windows Vista®, Windows Server® 2003, Windows Server 2008, and Windows 2000).

¹ Dell technical phone support only supports factory-installed operating systems (Microsoft) for the first 30 days for free. See <http://www1.us.dell.com/content/products/compare.aspx/laser?c=us&cs=555&l=en&s=biz> for more details. The customer will have to purchase technical support from the manufacturer of the operating system in order to get technical assistance beyond 30 days.

² If the customer has other operating systems and has purchased Gold Technical Support (for more information on Gold Technical Support, see <http://www1.us.dell.com/content/topics/global.aspx/services/en/gts?c=us&cs=555&l=en&s=biz>), the telephone support will be a "best effort" attempt to resolve the operating system issue. If the manufacturer needs to be contacted, the customer must pay an additional fee for that support. The only time that Dell pays for the third party support is when Dell is responsible for the issue. In the case of getting the printer installed and working, this is configuration and the customer would be responsible for paying.

Power Supply

Rated Voltage	220-240 VAC	100-127 VAC
Frequency	50/60 Hz	50/60 Hz
Current	5 A	10 A

Dimensions

Height: 378 mm (14.88 inches) Width: 400 mm (15.75 inches) Depth: 372 mm (14.65 inches) with the output tray closed (not including Tray 1 and cover cassette), 430 mm (16.9 inches) with the output tray extended

Weight (not including cartridge and PHD unit): 13.5 kg (30 lb)

Memory

Base memory	64 MB
-------------	-------

Page Description Language (PDL)/Emulation, Operating System, and Interface

PDL/Emulations	Windows only		
OSes	Microsoft Windows XP, Windows XP 64-bit Edition, Windows Server 2003, Windows Server 2008, Windows Vista, and Windows 2000		
Interfaces	Standard local:	USB	
	Standard network:	10Base-T/100Base-TX Ethernet	

MIB Compatibility

A Management Information Base (MIB) is a database containing information about network devices (such as adapters, bridges, routers, or computers). This information helps network administrators manage the network (analyze performance, traffic, errors, and so on). Dell Color Laser Printer 1320c complies with standard industry MIB specifications, allowing the printer to be recognized and managed by various printer and network management software systems, such as IBM Tivoli, Hewlett-Packard OpenView, CA Unicenter, Hewlett-Packard Web JetAdmin, and so on.

Environmental

Operation

Temperature	5-32°C
Relative humidity	15-85% RH (no condensation)

Print Quality Guarantee

Temperature	15-28°C
Relative humidity	20-70% RH (no condensation)

Storage

Temperature range	0-35°C (32-95 °F)
Storage humidity range	15-80% RH (no condensation)

Altitude

Operating	Up to 3,100 m (10,000 feet)
Storage	70.9275 Kpa

Cables

Your interconnection cable must meet the following requirements:

	Connection type	Connection specifications and symbols	
1	Ethernet	10 Base-T/100 Base-TX	
2	USB	USB2.0	

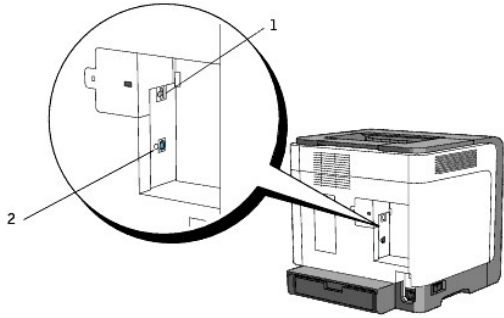

[back to contents page](#)

[back to contents page](#)

Safety and Regulatory Information

- [Safety Information](#)
 - [Regulatory Notices](#)
 - [FCC Notice \(U.S. Only\)](#)
 - [Noise Emissions Levels](#)
 - [Laser Notice](#)
 - [Energy Star](#)
 - [Perchlorate Material](#)
 - [MSDS Materials for Dell Printer](#)
-

Safety Information

 **CAUTION:** Read and follow all safety instructions in your *Product Information Guide* prior to setting up and operating your printer.

Regulatory Notices

Electromagnetic Interference (EMI) is any signal or emission, radiated in free space or conducted along power or signal leads, that endangers the functioning of a radio navigation or other safety service or seriously degrades, obstructs, or repeatedly interrupts a licensed radio communications service. Radio communications services include but are not limited to AM/FM commercial broadcast, television, cellular services, radar, air-traffic control, pager, and Personal Communication Services (PCS). These licensed services, along with unintentional radiators such as digital devices, including computer systems, contribute to the electromagnetic environment.

Electromagnetic Compatibility (EMC) is the ability of items of electronic equipment to function properly together in the electronic environment. While this computer has been designed and determined to be compliant with regulatory agency limits for EMI, there is no guarantee that interference will not occur in a particular installation. If this equipment does cause interference with radio communications services, which can be determined by turning the equipment off and on, you are encouraged to try to correct the interference by one or more of the following measures:

- 1 Reorient the receiving antenna.
- 1 Relocate the computer with respect to the receiver.
- 1 Move the computer away from the receiver.
- 1 Plug the computer into a different outlet so that the computer and the receiver are on different branch circuits.

If necessary, consult a Dell Support representative or an experienced radio/television technician for additional suggestions.

For additional regulatory information, see the product information guide or user's guide for your computer.

Dell™ products are designed, tested, and classified for their intended electromagnetic environment. These electromagnetic environment classifications generally refer to the following harmonized definitions:

- 1 Class A is typically for business or industrial environments. Class B products may also be utilized in a Class A environment.
- 1 Class B is typically for residential environments. Class A products should not be utilized in a Class B environment.

Information Technology Equipment (ITE), including peripherals, expansion cards, printers, input/output (I/O) devices, monitors, and so on, that are integrated into or connected to the computer should match the electromagnetic environment classification of the computer.

A Notice About Shielded Signal Cables: Use only shielded cables for connecting devices to any Dell device to reduce the possibility of interference with radio communications services. Using shielded cables ensures that you maintain the appropriate Electromagnetic Compatibility classification for the intended environment. For parallel printers, a cable is available from Dell. If you prefer, you can order a cable from Dell on the World Wide Web at www.dell.com.

Dell has determined that this product is a Class B harmonized product. The following sections provide country-specific EMC/EMI or product safety information.

FCC Notice (U.S. Only)

FCC Class B

This equipment generates, uses, and can radiate radio frequency energy and, if not installed and used in accordance with the manufacturer's instruction manual, may cause interference with radio and television reception. This equipment has been tested and found to comply with the limits for a Class B digital device pursuant to Part 15 of the FCC Rules.

This device complies with Part 15 of the FCC Rules. Operation is subject to the following two conditions:

1. This device may not cause harmful interference.
2. This device must accept any interference received, including interference that may cause undesired operation.



NOTICE: The FCC regulations provide that changes or modifications not expressly approved by Dell Inc. could void your authority to operate this equipment.

These limits are designed to provide reasonable protection against harmful interference in a residential installation. However, there is no guarantee that interference will not occur in a particular installation. If this equipment does cause harmful interference with radio or television reception, which can be determined by turning the equipment off and on, you are encouraged to try to correct the interference by one or more of the following measures:

- 1 Reorient the receiving antenna.
- 1 Relocate the system with respect to the receiver.
- 1 Move the system away from the receiver.
- 1 Plug the system into a different outlet so that the system and the receiver are on different branch circuits.

If necessary, consult a representative of Dell Inc. or an experienced radio/television technician for additional suggestions.

The following information is provided on the device or devices covered in this document in compliance with the FCC regulations:

- 1 **Product name:** Dell™ Color Laser Printer
- 1 **Model number:** 1320c
- 1 **Company name:**
Dell Inc.
Worldwide Regulatory Compliance & Environmental Affairs
One Dell Way
Round Rock, TX 78682 USA
512-338-4400



NOTE: For Further regulatory information, see your *Product Information Guide*.

CE Notice (European Union)

This product has been determined to be in compliance with 73/23/EEC (Low Voltage Directive), 89/336/EEC (EMC Directive), and amendments of the European Union.

European Union, Class B

This Dell device is classified for use in a typical Class B domestic environment.

A "Declaration of Conformity" in accordance with the preceding directives and standards has been made and is on file at Dell Inc. Products Europe BV, Limerick, Ireland.

Předpisy CE (Evropská unie)

Bylo ověřeno, že tento produkt vyhovuje směrnicím 73/23/EEC (nízkonapěťová směrnice), 89/336/EEC (směrnice EMC) a dodatkům Evropské unie.

Evropská unie, třída B

Toto zařízení společnosti Dell je klasifikováno pro použití v obvyklém prostředí domácnosti (třída B).

Bylo provedeno "Prohlášení o shodě" v souladu s předchozími nařízeními a standardy, které se nachází ve spisech společnosti Dell Inc. Products Europe BV, Limerick, Irsko.

CE-krav (Europæiske Union)

Dette produkt er fundet at være i overensstemmelse med 73/23/EEC (Lavspændingsdirektiv), 89/336/EEC (EMC direktiv) og rettelse fra den Europæiske Union.

Europæiske Union, Klasse B

Denne Dell-enhed er klassificeret til anvendelse i et typisk Klasse B hjemligt miljø.

En "Overensstemmelseserklæring", som er i henhold til foregående direktiver og standarder, er udført og arkiveret hos Dell Inc. Products Europe BV, Limerick, Irland.

CE-kennisgeving (Europese Unie)

Dit product voldoet aan de eisen van 73/23/EEC (laagspanningsrichtlijn), 89/336/EEC (EMC-richtlijn) en amendementen van de Europese Unie.

Europese Unie, klasse B

Dit Dell-apparaat is geclassificeerd voor gebruik in een typische klasse B woonomgeving.

Er is in overeenstemming met de bovenstaande richtlijnen en normen een "conformiteitsverklaring" opgesteld, welke zich in het archief bevindt bij Dell Inc. Producten Europa BV, Limerick, Ierland.

CE teade (Euroopa Liit)

Käesolev toode vastab määratluse järgi direktiividele 73/23/EMÜ (madalpinge direktiiv), 89/336/EMÜ (elektromagnetilise ühilduvuse direktiiv) ja Euroopa Liidu poolt neis tehtud muudatustele.

Euroopa Liit, klass B

Käesolev Dell'i seade on klassifitseeritud kasutamiseks tavapärase klassile B vastavas olmekeskkonnas.

Eespool loetletud direktiivide ja standardite kohaselt koostatud vastavusdeklaratsioon asub dokumendina ettevõtte Dell Inc. Products Europe BV kontoris Limerickis Iirimaa.

CE- ilmoitus (Euroopan unioni)

Tämä tuote täyttää direktiivin 73/23/ETY (pienjännitedirektiivi) ja direktiivin 89/336/ETY (sähkömagneettisesta yhteensopivuudesta annettu direktiivi), sellaisina kuin ne ovat muutettuina, vaatimukset.

Euroopan unioni, luokka B

Tämä Dell-laitte on luokiteltu käytettäväksi tyypillisessä luokan B asuinympäristössä.

Yllä mainittujen direktiivien ja normien mukainen yhdenmukaisuusilmoitus on tehty, ja sitä säilyttää Dell Inc. Products Europe BV, Limerick, Irlanti.

Règlementation CE (Union européenne)

Ce produit a été déclaré conforme aux directives 73/23/EEC (Directive sur la faible tension), 89/336/EEC (Directive EMC) et aux amendements de l'Union européenne.

Union européenne, classe B

Cet appareil Dell est classé pour une utilisation dans un environnement résidentiel (classe B).

Une «Déclaration de Conformité» relative aux normes et directives précédentes a été rédigée et est enregistrée à Dell Inc. Products Europe BV, Limerick, Irlande.

CE-Hinweis (Europäische Union)

Es ist befunden worden, dass dieses Produkt in Übereinstimmung mit 73/23/EEC (Niederspannungs-Richtlinie), 89/336/EEC (EMC-Richtlinie) und Ergänzungen der Europäischen Union steht.

Europäische Union, Klasse B

Dieses Gerät von Dell ist für die Verwendung in einer typisch häuslichen Umgebung der Klasse B vorgesehen.

Eine Konformitätserklärung in Übereinstimmung mit den oben angeführten Normen ist abgegeben worden und kann bei Dell Inc. Products Europe BV, Limerick, Irland, eingesehen werden.

Σήμα CE (Ευρωπαϊκή Ένωση)

Αυτό το προϊόν έχει κριθεί ότι συμμορφώνεται με την Οδηγία 73/23/EOK (χαμηλής τάσης), 89/336/EOK (ηλεκτρομαγνητικής συμβατότητας), και τροποποιήσεις τους.

Ευρωπαϊκή Ένωση, Κατηγορία Β

Αυτή η συσκευή Dell είναι κατάλληλη για χρήση σε σύνηθες οικιακό περιβάλλον κατηγορίας Β.

Μία "Απόλυση συμμόρφωσης" σύμφωνα με τις προηγούμενες οδηγίες και πρότυπα υπάρχει και είναι αρχειοθετημένη στην Dell Inc. Products Europe BV, Limerick, Ireland.

CE jelzés (Európai Unió)

A termék megfelel az Európai Unió 73/23/EEC számú, kiteszteltség berendezésekre vonatkozó irányelvnek, valamint a 89/336/EEC számú EMC irányelvnek és azok módosításainak.

Európai Unió, „B” osztály

Ez a Dell eszköz „B” osztályú besorolást kapott, tipikus lakóhelyi környezetben való használatra alkalmas.

A „Megfelelőségi nyilatkozat” a fenti direktívákkal és szabványokkal összhangban készült, és a Dell Inc. Products Europe BV cégnél található meg (Limerick, Írország).

Avviso CE (Unione Europea)

Questo prodotto è stato determinato essere conforme alle Direttive 73/23/CEE (Direttiva sulla bassa tensione), 89/336/CEE (Direttiva CEM) ed emendamenti dell'Unione Europea.

Unione Europea, Classe B

Il presente apparecchio Dell è classificato per l'uso in ambiente residenziale di Classe B.

Una "Dichiarazione di conformità" agli standard e alle direttive precedenti è stata emessa e registrata presso Dell Inc. Products Europe BV, Limerick, Irlanda.

CE paziņojums (Eiropas Savienība)

Ir noteikts, ka šis produkts atbilst Eiropas Savienības 73/23/EEK (direktīvai par zemsprieguma ierīcēm), 89/336/EEK (direktīvai par elektromagnētisko saderību) un to grozījumiem.

Eiropas Savienība, B klase

Ši Dell ierīce tiek klasificēta kā izmantojama ierastos B klases mājās apstākļos.

Saskaņā ar iepriekšminētajām direktīvām un standartiem ir izdota „Atbilstības deklarācija”, kas ir atrodama Dell Inc. Products Europe BV, Limerick, Īrija.

CE žyma (Europos Sąjunga)

Nustatyta, kad šis gaminytis atitinka direktyvas 73/23/EEC (žemos įtampos direktyvą), 89/336/EEC (EMC direktyvą) ir Europos Sąjungos oficialiųjų dokumentų pakeitimus.

Europos Sąjunga, B klasė

Šis „Dell” įrenginys klasifikuotas kaip tinkantis naudoti tipiškoje namų ūkio (B klasės) aplinkoje.

Aukščiau paminėtas direktyvas ir standartus atitinkanti „Atitikties deklaracija” yra saugoma bendrovės kartotekoje adresu „Dell Inc.” Products Europe BV, Limerick, Airija.

Avviż CE (Unjoni Ewropea)

Gie stabbilit li dan il-prodott hu konformi ma' 73/23/EEC (Direttiva tal-Vultagg Baxx), 89/336/EEC (Direttiva EMC), u emendi ta' l-Unjoni Ewropea.

Unjoni Ewropea, Klassi B

Dan it-tagħmir Dell hu kklassifikat għall-użu f'ambjent domestiku tipiku ta' Klassi B.

Saret "Dikjarazzjoni ta' Konformità" b'konformità mad-direttivi u ma' l-istandards insememmjin qabel. Din tinsab iffajljata għand Dell Inc. Products Europe BV, Limerick, Irlanda.

Wymogi CE (Unia Europejska)

Niniejszy produkt został uznany za zgodny z 73/23/EWG (Dyrektywą niskonapięciową), 89/336/EWG (Dyrektywą w sprawie kompatybilności elektromagnetycznej) oraz zmianami Unii Europejskiej.

Unia Europejska, klasa B

Niniejsze urządzenie firmy Dell zostało zakwalifikowane do klasy B, do użytku w typowych środowiskach domowych.

„Świadectwo zgodności” zostało sporządzone zgodnie z powyższymi dyrektywami oraz normami i znajduje się w aktach firmy Dell Inc. Products Europe BV, Limerick, Irlandia.

Aviso CE (União Europeia)

Foi determinado que este produto está em conformidade com Directiva 73/23/EEC (referente a equipamentos de baixa tensão), Directiva 89/336/EEC (directiva europeia sobre compatibilidade eletromagnética) e alterações da União Europeia.

União Europeia, Classe B

Este dispositivo Dell está classificado para utilização num ambiente doméstico típico Classe B.

Uma "Declaração de Conformidade" de acordo com as directivas e padrões precedentes foi elaborada e encontra-se arquivada na Dell Inc. Products Europe BV, Limerick, Irlanda.

CE Poznámka (Európska únia)

Tento výrobok vyhovuje požiadavkám smernice 73/23/EHS (smernica o nízkom napätí), 89/336/EHS (smernica o elektromagnetickej kompatibilitate) a neskorším zmenám a doplnkom Európskej únie.

Európska únia, Trieda B

Toto zariadenie Dell triedy B je určené pre domáce prostredie.

„Vyhlásenie o zhode” na základe predchádzajúcich noriem a predpisov je k dispozícii u spoločnosti Dell Inc. Products Europe BV, Limerick, Iréland.

Obvestilo CE (Evropska unija)

Ta izdelek je skladen z direktivama 73/23/EEC (direktiva o nizki napetosti) in 89/336/EEC (direktiva o elektromagnetni združljivosti) ter dopolnili Evropske unije.

Evropska unija, razred B

Ta Dellova naprava je razvrščena za uporabo v značilnem bivalnem okolju razreda B.

Podana je bila »Izjava o skladnosti«, skladna z zgoraj navedenimi direktivami in standardi, ki je na voljo pri Dell Inc. Products Europe BV, Limerick, Irsko.

Aviso CE (Comunidad Europea)

Este producto se ha fabricado de conformidad con la Directiva para bajo voltaje 73/23/EEC (Low Voltage Directive), la Directiva (EMC) para compatibilidad electromagnética 89/336/EEC (EMC Directive), y las enmiendas de la Unión Europea.

Unión Europea, Clase B

Este dispositivo Dell está clasificado para ser utilizado en un entorno doméstico convencional de Clase B.

Se ha realizado una "Declaración de conformidad" de acuerdo con las directivas y estándares anteriores y está archivada en Dell Inc. Products Europe BV, Limerick, Irlanda.

Meddelande om CE-märkning (Europeiska Unionen)

Denna produkt har fastställts att överensstämma med 73/23/EEC (lågspänningsdirektiv), 89/336/EEC (EMC-direktiv) och ändringar av den europeiska unionen.

Europeiska unionen, klass B

Den här Dell-enheten är klassificerad för användning i vanlig klass B-bostadsmiljö.

En "Försäkran om överensstämmelse" i enlighet med de föregående direktiven och standarderna har framställts och finns registrerad hos Dell Inc. Products Europe BV, Limerick, Irland.

AB Bildirimi (Avrupa Birliği)

Bu ürünün 73/23/EEC (Düşük Voltaj Direktifi), 89/336/EEC (EMC Direktifi) ve Avrupa Birliği düzenlemeleriyle uyumlu olduğu belirlenmiştir.

Avrupa Birliği, B Sınıfı

Bu Dell cihazı tipik B Sınıfı ev alanları kullanımı için sınıflandırılmıştır.

Daha önceki yönetmelik ve standartlara uygun olarak bir "Uygunluk Deklarasyonu" hazırlanmış ve Dell Inc. Products Europe BV, Limerick, İrlanda'da dosyalanmıştır.

CE Mark Notice

This equipment complies with the essential requirements of the European Union Directive 1999/5/EC.

Toto zařízení splňuje základní požadavky směrnice 1999/5/EC.

Dette udstyr opfylder de væsentlige krav i EU's direktiv 1999/5/EC om Radio- og teleterminaludstyr.

Deze apparatuur voldoet aan de noodzakelijke vereisten van EU-richtlijn betreffende radioapparatuur en telecommunicatie-eindapparatuur 1999/5/EC.

Käesolev seade vastab oluliste Euroopa Liidu Direktiivi 1999/5/EC nõudmistele.

Tämä laite vastaa EU:n radio- ja telepääteläitedirektiivin (EU R&TTE Directive 1999/5/EC) vaatimuksia.

Cet équipement est conforme aux principales caractéristiques définies dans la Directive européenne RITE 1999/5/CE.

Die Geräte erfüllen die grundlegenden Anforderungen der RITE-Richtlinie (1999/5/EC).

Ο εξοπλισμός αυτός πληροί τις βασικές απαιτήσεις της κοινοτικής οδηγίας EU R&TTE 1999/5/EC.

A készülék megfelel az Európai Unió 1999/5/EC direktívája alapvető követelményének.

Questa apparecchiatura è conforme ai requisiti essenziali della Direttiva Europea R&TTE 1999/5/CE.

Šti ierice atbilst nepieciešamajām Eiropas Savienības Direktīva prasībām 1999/5/EC.

Šis prietaisas atitinka būtiskus Eiropas Savienības direktīvas 1999/5/EC reikalavimus.

Dan it-taġmir jikkonforma mar-rekwiżiti essenzjali tad-Direttiva ta' l-Unjoni Ewropea 1999/5/KE.

Dette utstyret er i overensstemmelse med hovedkravene i R&TTE-direktivet (1999/5/EC) fra EU.

To urządzenie spełnia podstawowe wymagania dyrektywy Unii Europejskiej 1999/5/EC.

Este equipamento cumple os requisitos essenciais da Directiva 1999/5/CE do Parlamento Europeu e do Conselho (Directiva RITE).

Toto zariadenie spĺňa základné požiadavky Direktívy Európskej únie č. 1999/5/EC.

Ta oprema je skladna z bistvenimi zahtevami direktive EU 1999/5/EC.

Este equipo cumple los requisitos principales de la Directiva 1999/5/CE de la UE, "Equipos de Terminales de Radio y Telecomunicaciones".

Utrustningen uppfyller kraven för EU-direktivet 1999/5/EC om ansluten teleutrustning och ömsesidigt erkännande av utrustningens överensstämmelse (R&TTE).

Información para NOM (únicamente para México)

La información siguiente se proporciona en el dispositivo o dispositivos descritos en este documento, en cumplimiento con los requisitos de la Norma oficial mexicana (NOM):

Exportador:	Dell Inc. One Dell Way Round Rock, TX 78682
Importador:	Dell México S.A. de C.V. Paseo de la Reforma 2620 - 11° Piso Col. Lomas Altas 11950 México, D.F.
Enviar a:	Dell México S.A. de C.V. al Cuidado de Kuehne & Nagel de México S. de R.L. Avenida Soles No. 55 Col. Peñon de los Baños 15520 México, D.F.

Modelo	Suministro	Entrada	Frecuencia
Dell™ Color Laser Printer 1320c	10A	110-127 V	50/60 Hz

For additional regulatory information, see the Regulatory Compliance Homepage on www.dell.com at the following location:
www.dell.com/regulatory_compliance.

Noise Emissions Levels

The following measurements were made in accordance with ISO 7779 and reported in conformance with ISO 9296.

	Sound power level
Printing	6.4B, 51.6dB(A)
Idling	4B, 22.9dB(A)

Laser Notice

The printer is certified in the U.S. to conform to the requirements of 21CFR, Chapter 1, Subchapter J for Class I (1) laser products, and elsewhere is certified as a Class I laser product conforming to the requirements of IEC 60825-1.

Class I laser products are not considered to be hazardous. The printer contains internally a Class IIIb (3b) laser that is nominally a 5 milliwatt gallium arsenide laser operating in the wavelength region of 770-795 nanometers. The laser system and printer are designed so there is never any human access to laser radiation above a Class I level during normal operation, user maintenance, or prescribed service condition.

Energy Star

ENERGY STAR® Compliance

Any Dell™ product bearing the ENERGY STAR emblem on the product or on a start-up screen is certified to comply with Environmental Protection Agency (EPA) ENERGY STAR requirements as configured when shipped by Dell.

ENERGY STAR® Emblem



The EPA's ENERGY STAR program is a joint effort between the EPA and manufacturers to reduce air pollution by promoting energy-efficient products.

You can help reduce electricity usage and its side effects by turning off your product when it is not in use for extended periods of time, particularly at night and on weekends.

Perchlorate Material

Perchlorate Material - special handling may apply.

See www.dtsc.ca.gov/hazardouswaste/perchlorate.

MSDS Materials for Dell Printer

All MSDS materials for Dell Printers can be found at the following URL:
http://www1.us.dell.com/content/topics/global.aspx/corp/environment/en/prod_design?c=us&l=en&s=corp&-section=001

[back to contents page](#)

[back to contents page](#)

Appendix

- [Dell Technical Support Policy](#)
 - [Warranty and Return Policy](#)
 - [Recycling Information](#)
 - [Contacting Dell™](#)
-

Dell Technical Support Policy

Technician-assisted technical support requires the cooperation and participation of the customer in the troubleshooting process and provides for restoration of the operating system, software program and hardware drivers to the original default configuration as shipped from Dell, as well as the verification of appropriate functionality of the printer and all Dell-installed hardware. In addition to this technician assisted technical support, online technical support is available at Dell Support. Additional technical support options may be available for purchase.

Dell provides limited technical support for the printer and any Dell-installed software and peripherals. Support for third-party software and peripherals is provided by the original manufacturer, including those purchased and/or installed through Software & Peripherals (DellWare), ReadyWare, and Custom Factory Integration (CFI/DellPlus).

Online Services

You can access Dell Support at support.dell.com. Select your region on the **WELCOME TO DELL SUPPORT** page, and fill in the requested details to access help tools and information.

You can contact Dell electronically using the following addresses:

- 1 World Wide Web

www.dell.com/

www.dell.com/ap/ (Asian/Pacific countries only)

www.dell.com/jp (Japan only)

www.euro.dell.com (Europe only)

www.dell.com/la/ (Latin American and Caribbean countries)

www.dell.ca (Canada only)

- 1 Anonymous file transfer protocol (FTP)

ftp.dell.com/

Log in as user: `anonymous`, and use your e-mail address as your password.

- 1 Electronic Support Service

`mobile_support@us.dell.com`

`support@us.dell.com`

`la-techsupport@dell.com` (Latin America and Caribbean countries only)

`apsupport@dell.com` (Asian/Pacific countries only)

support.jp.dell.com (Japan only)

support.euro.dell.com (Europe only)

- 1 Electronic Quote Service

`apmarketing@dell.com` (Asian/Pacific countries only)

Warranty and Return Policy

Dell Computer Corporation ("Dell") manufactures its hardware products from parts and components that are new or equivalent to new in accordance with industry-standard practices. For information about the Dell warranty for your printer, see the *Product Information Guide*.

Recycling Information

Dell recommends that customers dispose of their used computer hardware, monitors, printers, and other peripherals in an environmentally sound manner. Potential methods include reuse of parts or whole products and recycling of products, components, and/or materials.

For specific information on Dell's worldwide recycling programs, see www.dell.com/recyclingworldwide.

Waste Electrical and Electronic Equipment (WEEE) Directive



In the European Union, this label indicates that this product should not be disposed of with household waste. It should be deposited at an appropriate facility to enable recovery and recycling. For information on how to recycle this product responsibly in your country, please visit: www.euro.dell.com/recycling.

Směrnice WEEE (Likvidace elektrických a elektronických produktů)

Tento štítek označuje v Evropské unii, že tento produkt nesmí být likvidován s domovním odpadem. Musí být předán specializované sběrně pro recyklaci a další využití. Informace o možnostech ekologické recyklace tohoto produktu ve vaší zemi najdete na webu: www.euro.dell.com/recycling.

Direktiv for bortskaffelse af elektrisk og elektronisk udstyr (WEEE)

I den Europæiske Union indikerer denne etiket, at dette produkt ikke bør kasseres sammen med husholdningsaffald. Det bør bortskaffes ved en egnet facilitet for at muliggøre genbrug. For information om hvordan dette produkt genbruges ansvarligt i dit land, bedes du gå til: www.euro.dell.com/recycling.

Richtlijn WEEE, Waste Electrical and Electronic Equipment (afdoen van elektrische en elektronische apparaten)

In de Europese Unie geeft dit label aan dit product niet via huishoudelijk afval mag worden afgedankt. Het moet gedeponceerd worden bij een daarvoor geschikte voorziening zodat recuperatie en recycling mogelijk zijn. Raadpleeg voor informatie over de milieuvriendelijke wijze van recycling van dit product in uw land: www.euro.dell.com/recycling.

Direktiiv elektri- ja elektroonikaseadmete jäätmete (WEEE) kohta

Euroopa Liidus osutab antud märgis sellele, et käesolevat toodet ei tohi kõrvaldada koos olmejäätmetega. See tuleks ladustada asjakohasesse hooldlasse, võimaldamaks taaskasutamist ja ringlussevõttu. Kui soovite lisateavet selle kohta, kuidas käesolevat toodet oma riigis vastutustundlikult ümber töödelda, külastage veebilehte: www.euro.dell.com/recycling.

Direktiivi sähkö- ja elektroniikkalaiteromusta (WEEE)

Euroopan unionissa tämä tarra tarkoittaa, että tuotetta ei tule hävittää kotitalousjätteen joukossa. Se tulee toimittaa asianmukaisessa paikassa uudelleenkäyttöä tai kierrätystä varten. Lisätietoja siitä, miten tuotteen kierrätys on järjestetty kotimaassasi, saat osoitteesta: www.euro.dell.com/recycling.

Directive sur la mise au rebut des appareils électriques et électroniques (WEEE)

En Union européenne, cette étiquette indique que ce produit ne doit pas être jeté avec les déchets ménagers. Il doit être mis au rebut dans un centre de dépôt spécialisé pour un recyclage approprié. Pour obtenir davantage d'informations sur le recyclage approprié de ce produit dans votre pays, veuillez vous rendre sur le site : www.euro.dell.com/recycling.

Richtlinie für Abfall von elektrischen und elektronischen Geräten (WEEE)

In der Europäischen Union wird mit diesem Etikett darauf hingewiesen, dass dieses Produkt nicht mit dem Hausmüll entsorgt werden sollte. Es sollte an einer entsprechenden Einrichtung abgegeben werden, um Wiedergewinnung und Recycling zu ermöglichen. Weitere Informationen über das verantwortungsbewusste Recyceln dieses Produkts erhalten Sie unter: www.euro.dell.com/recycling.

Οδηγία σχετικά με τα απόβλητα ειδών ηλεκτρικού και ηλεκτρονικού εξοπλισμού (AHHE)

Στην Ευρωπαϊκή Ένωση, αυτή η ετικέτα υποδεικνύει ότι αυτό το προϊόν δεν πρέπει να απορρίπτεται μαζί με τα οικιακά απορρίμματα. Θα πρέπει να αποκομίζεται σε κατάλληλο χώρο ώστε να είναι δυνατή η ανάκτηση και η ανακύκλωση. Για πληροφορίες σχετικά με την υπεύθυνη ανακύκλωση αυτού του προϊόντος στη χώρα σας, επισκεφθείτε τη διεύθυνση: www.euro.dell.com/recycling.

Az elektromos és elektronikus hulladékokra vonatkozó irányelv (WEEE)

Az Európai Unióban az ilyen címkével jelölt terméket tilos háztartási hulladékként kezelni. Az ilyen hulladékot a helyreállítathóság és az újrahasznosíthatóság érdekében a megfelelő elfogadóhelyre kell szállítani. Az ilyen termékeknek az Ön országára vonatkozó újrahasznosításával kapcsolatos információkért kérjük, látogasson el a következő webcímre: www.euro.dell.com/recycling.

Direttiva Rifiuti di apparecchiature elettriche ed elettroniche (RAEE)

Nell'Unione Europea, questa etichetta indica che questo prodotto non deve essere smaltito insieme ai rifiuti domestici. Deve essere depositato in un impianto adeguato che sia in grado di eseguire operazioni di recupero e riciclaggio. Per informazioni sulle procedure di riciclaggio responsabile di questo prodotto nel proprio Paese, visitare: www.euro.dell.com/recycling.

Direktīva par elektrisko un elektronisko iekārtu atkritumiem (EEIA)

Eiropas Savienībā šī uzlīme apzīmē to, ka šo produktu nedrīkst izmest kopā ar sadzīves atkritumiem. Ierīce jānodod atbilstošā punktā, lai to varētu pārstrādāt atbilstoši lietošanai. Lai iegūtu informāciju par šī produkta atveidošanu, lūdzam apmeklēt: www.euro.dell.com/recycling.

Direktyva dėl elektros ir elektroninės įrangos atliekų (WEEE)

Šis ženklas rodo, kad Europos Sąjungoje šio gaminio negalima išmesti kartu su buitiniomis atliekomis. Nebenaudojamą gaminį reikia atiduoti į tam skirtą punktą atnaujinti arba perdirbti. Informacijos apie šio gaminio tinkamą perdirbimą jūsų šalyje žr. interneto svetainėje: www.euro.dell.com/recycling.

Direttiva dwar Skart magħmul minn Tagħmir Elettroniku u Elettriku (WEEE)

Fl-Unjoni Ewropea, din it-tikketta tindika li dan il-prodott mi' għandux jintrama ma' l-iskart tad-dar. Dan għandu jintrama f'facilità adattata biex l-irkuprar u r-riċiklaġġ ikunu possibbli. Għal tagħrif dwar kif tista' tiriċikla dan il-prodott b'responsabbiltà f'pajjiżek, jekk jogħġbok zur: www.euro.dell.com/recycling.

Directiva sobre equipamentos eléctricos e electrónicos a serem descartados (WEEE)

Na União Europeia, esta etiqueta indica que esse produto não deve ser eliminado juntamente com o lixo normal. Deve ser depositado numa instalação apropriada para recolha e reciclagem. Para obter informações sobre como reciclar este produto de forma responsável no seu país, visite: www.euro.dell.com/recycling.

Dyrektywa w sprawie zużytego sprzętu elektrycznego i elektronicznego (WEEE)

W Unii Europejskiej etykieta ta oznacza, że tego produktu nie należy wyrzucać wraz z odpadami z gospodarstwa domowego. Należy go przekazać do odpowiedniego zakładu, gdzie zostanie poddany odzyskowi i recyklingowi. Informacje o sposobie odpowiedzialnego recyklingu tego produktu w swoim kraju można znaleźć pod adresem: www.euro.dell.com/recycling.

Smernica o odpadových elektrických a elektronických zariadeniach (WEEE)

V Európskej únii tento štítok znamená, že sa výrobok nesmie likvidovať ako komunálny odpad. Musí sa odovzdať na príslušnom mieste na obnovu alebo recykláciu. Informácie o možnostiach recyklácie výrobku vo vašej krajine nájdete na adrese: www.euro.dell.com/recycling.

Directiva sobre el deshecho de material eléctrico y electrónico (WEEE)

En la Unión Europea, esta etiqueta indica que la eliminación de este producto no se puede hacer junto con el deshecho doméstico. Se debe depositar en una instalación apropiada que facilite la recuperación y el reciclado. Para obtener más información sobre cómo reciclar este producto de manera responsable en su país, visite el sitio web: www.euro.dell.com/recycling.

Direktiva o odlaganju električne in elektronske opreme (WEEE)

V Evropski uniji ta znak označuje, da izdelek ni primeren za odlaganje skupaj z običajnimi gospodinjimi odpadki. Odložiti ga je treba na ustreznem mestu za odlaganje in reciklažo. Za informacije o recikliranju tega izdelka v vaši državi obiščite: www.euro.dell.com/recycling.

Direktiv för kassering av elektrisk och elektronisk utrustning (WEEE)

Inom EU betyder den här etiketten att produkten inte får slängas i hushållsavfallet. Den ska lämnas in på en återvinningstation. Information om hur produkten återvinns i ditt land finns på adressen www.euro.dell.com/recycling.

Atık Elektrikli ve Elektronik Cihazlar (WEEE) Yönetmeliği

Avrupa Birliği'nde bu etiket, ürünün ev elektrikli aletleri atıkları ile imha edilemeyeceğini gösterir. Kurtarmak ve geri dönüştürmünü sağlamak için uygun şartlarda saklanması gerekir. Bu ürünün geri dönüşüm sorumluluğu ile ilgili bilgi için, lütfen bu siteyi ziyaret edin: www.euro.dell.com/recycling.

Директива за изхвърляне на електрическо и електронно оборудване (WEEE)

В Европейския съюз този етикет означава, че този продукт не бива да се изхвърля заедно с домакинските отпадъци. Той трябва да бъде изхвърлен на подходящо място, за да се позволи възстановяването или рециклирането му. За информация относно отговорността за рециклиране на този продукт във вашата страна, моля посетете: www.euro.dell.com/recycling.

Directiva privind deșeurile provenite din echipamentele electrice și electronice (WEEE)

În Uniunea Europeană, această etichetă indică faptul că acest produs nu trebuie aruncat laolaltă cu gunoii menajeri. El trebuie depozitat într-un loc special amenajat pentru a permite recuperarea și reciclarea. Pentru informații privitoare la reciclarea în mod responsabil a acestui produs în țara dvs., vizitați: www.euro.dell.com/recycling.

Contacting Dell™

For customers in the United States, call 800-WWW-Dell (800-999-3355).



NOTE: If you do not have an active Internet connection, you can find contact information on your purchase invoice, packing slip, bill, or in your Dell™ catalog.

Dell™ provides several online and telephone-based support and service options. Availability varies by country and product, and some services may not be available in your area. To contact Dell™ for sales, technical support, or customer service issues:

1. Visit support.dell.com.
2. Verify your country or region in the **Choose A Country/Region** drop-down menu at the bottom of the page.
3. Click **Contact Us** on the left side of the page.
4. Select the appropriate service or support link based on your need.
5. Choose the method of contacting Dell™ that is convenient for you.

[back to contents page](#)

[back to contents page](#)

Installing Printer Drivers

- [Personal Printer Setup](#)
 - [Network Printer Setup](#)
 - [Troubleshooting Instructions](#)
-

Personal Printer Setup

1. Insert the *Drivers and Utilities* CD into your computer to start **Easy Setup Navigator**.

 **NOTE:** If the CD does not automatically launch, click **Start**→**Run**, and then type D:\setup_assist.exe (where D is the drive letter of your CD), and then click **OK**.

2. Press **Software Installation** to launch the installation software.
3. Select **Personal Installation**, and then click **Next**.
4. Click **Install**.
5. Follow the instructions that appear on the **Found New Hardware Wizard** dialog box to install the printer driver on your computer.
6. When the **Completing the Found New Hardware Wizard** dialog box appears, click **Finish**.
7. Select either **Typical Installation** or **Custom Installation** from the installation wizard, and then click **Install**. If you select **Custom Installation**, you can select the specific software you want to install.
8. Click **Finish** to exit the wizard when the **Congratulations!** screen appears. To print a test page, click **Print Test Page** to print a test page.

USB Printing

A local printer is a printer attached to your computer or a print server using a USB. If your printer is attached to a network and not your computer, see ["Network Printer Setup" on page 163](#).

Network Printer Setup

Printing and Checking the System Settings Page

Before installing the printer driver on your computer, print the System Settings page to check your printer's IP address.

1. Print the Printer Settings page.
 - a. Click **Start**→**All Programs**→**Dell Printers**→**Additional Color Laser Software**→**Status Monitor Console**. The **Printer Selection** dialog box opens.
 - b. Click **Dell Color Laser 1320c** listed in Printer Name. The **Dell Color Laser 1320c Launcher** window opens.
 - c. Click the **Tool Box** button. The **Tool Box** opens. You can also launch the **Tool Box** from the printer icon on the taskbar.
 - d. Click the **Printer Settings Report** tab.
 - e. Select **Reports** from the list at the left side of the page. The **Reports** page is displayed.
 - f. Click the **Start** button for **Printer Settings**. The printer settings page is printed.
2. Verify the IP address.
 - a. Click **Start**→**All Programs**→**Dell Printers**→**Additional Color Laser Software**→**Status Monitor Console**. The **Printer Selection** dialog box opens.
 - b. Click **Dell Color Laser 1320c** listed in Printer Name. The **Dell Color Laser 1320c Launcher** window opens.
 - c. Click the **Tool Box** button. The **Tool Box** opens. You can also launch the **Tool Box** from the printer icon on the taskbar.
 - d. Click the **Printer Settings Report** tab.

- e. Select **TCP/IP Settings** from the list at the left side of the page.

If the IP address is 0.0.0.0, wait for a few minutes to resolve the IP address automatically, and then display the **TCP/IP Settings** page again.

You can also print and check the printer settings from the **Report** page. To print the **Report** page, press and hold the **Continue** button on the operator panel.

Disable Microsoft® Windows® XP, Windows Vista®, Windows Server® 2003 (after SP1) , or Windows Server 2008 Firewall Before Printer Software Installation

 **NOTE:** This step may not be necessary if you have Windows XP Service Pack 2 installed.

If your printer is connected directly to a network and the Windows XP, Windows Vista, Windows Server 2003 (after SP1), or Windows Server 2008 firewall is enabled, you cannot view your networked printer(s) when you run the Dell™ printer installation software. To prevent this situation, disable the firewall before you install the Dell printer software. To disable or enable the firewall, perform the following steps.

 **NOTICE:** Dell recommends that you enable your Windows XP, Windows Vista, Windows Server 2003 (after SP1), or Windows Server 2008 firewall after you install the printer software. Enabling the Windows XP, Windows Vista, Windows Server 2003 (after SP1), or Windows Server 2008 firewall after you install the printer software does not limit the use of your network printer.

1. Click the **Start** button and click **Help and Support**.
2. In the **Search** box, type **firewall** and then press **Enter**.

In the list, click **Turn Windows Firewall on or off** and then follow the instructions on the screen.

Local Printer Setup

1. Insert the *Drivers and Utilities* CD into your computer to start **Easy Setup Navigator**.

 **NOTE:** If the CD does not automatically launch, click **Start**→**Run**, and then type **D:\setup_assist.exe** (where D is the drive letter of your CD), and then click **OK**.

2. Press **Software Installation** to launch the installation software.
3. Select **Network Installation**, and then click **Next**.
4. Select **Local Installation**, and then click **Next**.
5. Select the printer you want to install from the printer list, and then click **Next**. If the target printer is not displayed on the list, click **Refresh** to refresh the list or click **Add Printer** to add a printer to the list manually. You may specify the IP address and port name at this point. If you have installed this printer on the server computer, select the **I am setting up this printer on a server** check box.

 **NOTE:** When using AutoIP, 0.0.0.0 is displayed in the installer. Before you can continue, you must enter a valid IP address.

6. Specify the printer settings, and then click **Next**.
 - a. Enter the printer name.
 - b. If you want other users on the network to access this printer, select **Share this printer with other computers on the network**, and then enter a share name that users will easily identify.
 - c. If you want to set a printer as the default, select the **Set this printer as default** check box.
 - d. If you want to restrict color printing, select the appropriate **Dell ColorTrack** option. Enter the password when **Color-Password Enabled** is selected for **Dell ColorTrack**.
7. Select the software and documentation you want to install, and then click **Next**. You can specify folders in which to install the Dell software and documentation. To change the folders, click **Browse**.
8. Click **Finish** to exit the wizard when the **Congratulations!** screen appears. If necessary, click **Print Test Page** to print a test page.

Enable Network Discovery and File Sharing for all Public Networks

You can skip "Disable User Account Control" for this procedure.

 **NOTE:** This step is required when you use Windows Vista or Windows Server 2008 for the server computer.

1. Click **Start**→**Network**.
2. Click **Network discovery and file sharing are turned off. Network computers and devices are not visible. Click to change**.
3. Click **Turn on network discovery and file sharing**.
4. Click **Yes, turn on network discovery and file sharing for all public networks**.

Remote Printer Setup

Before Installation

Before you start remote installation, perform the following procedures.

Allow Print Spooler to Accept Client Connections

 **NOTE:** This step is required for Windows XP 64-bit Edition, Windows Vista, Windows Vista 64-bit Edition, Windows Server 2003, and Windows Server 2008.

1. Click **Start**→ **Run**.
For Windows Server 2003/Windows Server 2008: Click **Start**→ **Run**.
For Windows Vista: Click **Start**→ **All Programs**→ **Accessories**→ **Run**.
2. Type `gpedit.msc`, and then click **OK**.
3. Click **Continue**. (for Windows Vista only)
4. Click **Computer Configuration**→ **Administrative Templates**→ **Printers**.
5. Right-click **Allow Print Spooler to accept client connections** and select **Properties**.
6. From the **Setting** tab, select **Enabled**, and then click **OK**.
7. Restart the computer.

Share the Firewall File and Printer

 **NOTE:** This step is required for Windows XP 32-bit Edition, Windows XP 64-bit Edition, Windows Vista, and Windows Server 2008.

For Windows Vista:

1. Click **Start**→ **Control Panel**.
2. Select **Security**.
3. Click **Windows Firewall**.
4. Click **Change settings**.
5. Click **Continue**.
6. From the **Exceptions** tab, check the **File and Printer Sharing** check box, and then click **OK**.

For Windows XP:

1. Click **Start**→ **Control Panel**.
2. Select **Security Center**.
3. Click **Windows Firewall**.
4. From the **Exceptions** tab, check the **File and Printer Sharing** check box, and then click **OK**.

For Windows Server 2008:

1. Click **Start**→ **Control Panel**.
2. Double-click **Windows Firewall**.
3. Click **Change settings**.
4. From the **Exceptions** tab, check the **File and Printer Sharing** check box, and then click **OK**.

Start Remote Registry

 **NOTE:** This step is required for Windows Vista or Windows Server 2008.

For Windows Vista:

1. Click **Start**→ **Control Panel**.
2. Select **System and Maintenance**.
3. Click **Administrative Tools**.
4. Double-click **Services**.
5. Click **Continue**.
6. Right-click **Remote Registry** and select **Start**.
7. Right-click **Remote Registry** and select **Properties**.
8. Change **Startup type**: to **Automatic**, and then click **OK**.

For Windows Server 2008:

1. Click **Start**→ **Administrative Tools**.
2. Click **Services**.
3. Right-click **Remote Registry** and select **Start**.
4. Right-click **Remote Registry** and select **Properties**.
5. Change **Startup type**: to **Automatic**, and then click **OK**.

Disable User Account Control

 **NOTE:** This step is required for Windows Vista or Windows Server 2008.

For Windows Vista:

1. Click **Start**→ **Control Panel**.
2. Select **User Accounts and Family Safety**.
3. Click **User Accounts**.
4. Click **Turn User Account Control on or off**.
5. Click **Continue**.
6. Clear the **Use User Account Control (UAC) to help protect your computer** check box.
7. Restart the computer.

For Windows Server 2008:

1. Click **Start**→ **Control Panel**.
2. Double-click **User Accounts**.
3. Click **Turn User Account Control on or off**.
4. Clear the **Use User Account Control (UAC) to help protect your computer** check box.
5. Click **OK**.
6. Restart the computer.

Enable Network Discovery and File Sharing for all Public Networks

You can skip "Disable User Account Control" for this procedure.

 **NOTE:** This step is required when you use Windows Vista or Windows Server 2008 for the server computer.

1. Click **Start**→ **Network**.
2. Click **Network discovery and file sharing are turned off. Network computers and devices are not visible. Click to change**.
3. Click **Turn on network discovery and file sharing**.
4. Click **Yes, turn on network discovery and file sharing for all public networks**.

Disable Simple File Sharing

 **NOTE:** This step is required for Windows XP 32-bit Edition, and Windows XP 64-bit Edition.

1. Click **Start**→ **Control Panel**.
2. Select **Appearance and Themes**.
3. Select **Folder Options**.
4. From the **View** tab, clear the **Use simple file sharing(Recommended)** check box, and then click **OK**.
5. Click **Start**→ **Control Panel**.
6. Select **Performance and Maintenance**.
7. Select **Administrative Tools**.
8. Click **Local Security Policy**.
9. Click **Local Policies**→ **Security Options**.
10. Right-click **Network access: Sharing and security model for local accounts** and select **Properties**.
11. Ensure **Classic - local users authenticate as themselves** is selected.

Installing the Printer Driver

1. Insert the *Drivers and Utilities* CD into your computer to start **Easy Setup Navigator**.

 **NOTE:** If the CD does not automatically launch, click **Start**→**Run**, and then type D:\setup_assist.exe (where D is the drive letter of your CD), and then click **OK**.

2. Press **Software Installation** to launch the installation software.
3. Select **Network Installation**, and then click **Next**.
4. Select **Remote Installation**, and then click **Next**.

 **NOTE:** Installation on Windows XP Home Edition/Vista Home Basic/Vista Home Premium is not supported.

5. Enter the computer name, user ID, and password. Then, click **Add**.
6. Click **Next**.
7. Select the printer you want to install from the printer list, and then click **Next**. If the target printer is not displayed on the list, click **Refresh** to refresh the list or click **Add Printer** to add a printer to the list manually. You may specify the IP address and port name at this point.

 **NOTE:** When using AutoIP, 0.0.0.0 is displayed in the installer. Before you can continue, you must enter a valid IP address.

8. Specify the printer settings, and then click **Next**.
 - a. Enter the printer name.
 - b. If you want other users on the network to access this printer, select **Share this printer with other computers on the network**, and then enter a share name that users will easily identify.
 - c. If you want to set a printer as the default, select the **Set this printer as default** check box.
 - d. If you want to restrict color printing, select the appropriate **Dell ColorTrack** option. Enter the password when **Color-Password Enabled** is selected for **Dell ColorTrack**.
9. Select the software and documentation you want to install, and then click **Next**. You can specify folders in which to install the Dell software and documentation. To change the folders, click **Input**.
10. Click **Finish** to exit the wizard when the **Congratulations!** screen appears.

Use the Dell Printer Configuration Web Tool to monitor the status of your network printer without leaving your desk. You can view and/or change the printer configuration settings, monitor toner level, and when it is time to order replacement consumables, just click the Dell supplies link right from your Web browser.

 **NOTE:** The **Dell Printer Configuration Web Tool** is not available when the printer is locally attached to a computer or a print server.

To launch the Dell Printer Configuration Web Tool, type the network printer IP address in your Web browser, and the printer configuration appears on the screen.

You can set up the Dell Printer Configuration Web Tool to send you an email when the printer needs supplies or intervention.

To set up e-mail alerts:

1. Launch the Dell Printer Configuration Web Tool.
2. Click **E-Mail Alert** link.
3. Under **Setup E-Mail Lists and Alerts**, enter the **Primary SMTP Gateway**, the **Reply Address**, and enter your email address or the key operator's email address in the email list box.
4. Click **Apply New Settings**.

 **NOTE:** The SMTP server will display **Connection in Progress** until an error occurs.

Setup Security

1. Click **Start**→**All Programs**→**Dell Printers**→**Additional Color Laser Software**→**Status Monitor Console**. The **Printer Selection** dialog box opens.
2. Click **Dell Color Laser 1320c** listed in Printer Name. The **Dell Color Laser 1320c Launcher** window opens.
3. Click the **Tool Box** button. The **Tool Box** opens. You can also launch the **Tool Box** from the printer icon on the taskbar.
4. Click the **Printer Maintenance** tab.
5. Select **Set Password** from the list at the left side of the page. The **Set Password** page is displayed. To set or change the password to limit access to the **Tool Box** menus. Set the password of the Dell Printer Configuration Web Tool from **Set Password** in **Other Features**.

Values:

Setting of Panel Lock	Off*	Does not set a password to limit access to the menus.
	On	Set a password to limit access to the menus.
Password	Type a new password. This must be between 0001 and 9999.	
Input password again	Type the new password again to confirm.	
Apply New Settings	After you complete the settings, press the Apply New Settings button to apply the changes.	
Restart printer to apply new settings	Press the Restart the printer to apply the new settings button to apply the changes.	

 **NOTE:** This menu sets a password to lock the Tool Box menus. When changing the password for the Dell Printer Configuration Web Tool, click **Set Password** on the left frame and set the password.

Troubleshooting Instructions

Use the Customer Mode to locate the unit in the printer that causes a problem.

Checking the printer operations

1. Click **Start**→ **All Programs**→ **Dell Printers**→ **Additional Color Laser Software**→ **Status Monitor Console**.
The Printer Selection dialog box opens.
2. Click **Dell Color Laser 1320c** listed in Printer Name.
The Dell Color Laser 1320c Launcher window opens.
3. Click the **Tool Box** button.
The Tool Box opens.
You can also launch the Tool Box from the printer icon on the taskbar.
4. Click the **Diagnosis** tab.
5. Select Machine Check from the list at the left side of the page.
The **Machine Check** page is displayed.
6. Click the **Start** button after selecting the desired item.
The selected page is printed.

Clear NVRAM

You can restore the original factory default menu settings by initializing NVRAM.

1. Click **Start**→ **All Programs**→ **Dell Printers**→ **Additional Color Laser Software**→ **Status Monitor Console**.
The Printer Selection dialog box opens.
2. Click **Dell Color Laser 1320c** listed in Printer Name.
The Dell Color Laser 1320c Launcher window opens.
3. Click the **Tool Box** button.
The Tool Box opens.
You can also launch the Tool Box from the printer icon on the taskbar.
4. Click the **Printer Maintenance** tab.
5. Select **Reset Defaults** from the list at the left side of the page.
The Reset Defaults page is displayed.
6. Click **Start** to initialize the non-volatile memory (NVM) memory.
The printer is turned off automatically to apply the settings.

[back to contents page](#)

Free Manuals Download Website

<http://myh66.com>

<http://usermanuals.us>

<http://www.somanuals.com>

<http://www.4manuals.cc>

<http://www.manual-lib.com>

<http://www.404manual.com>

<http://www.luxmanual.com>

<http://aubethermostatmanual.com>

Golf course search by state

<http://golfingnear.com>

Email search by domain

<http://emailbydomain.com>

Auto manuals search

<http://auto.somanuals.com>

TV manuals search

<http://tv.somanuals.com>