

LCD Digital Camera

QV-4000

User's Guide

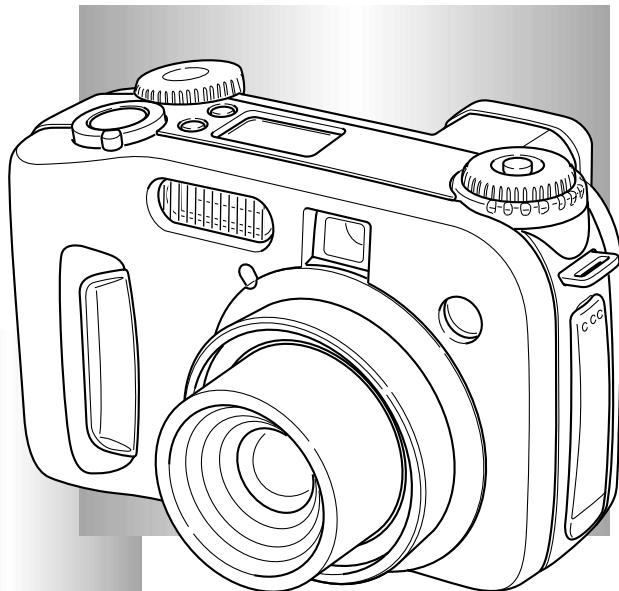

Congratulations upon your selection of the new CASIO Digital Camera. To get the most out of your new CASIO Digital Camera, make sure you read this manual carefully and keep it on hand for future reference.

CONTENTS

E-6 INTRODUCTION

| | |
|---------------------------------------|------|
| Quick Reference | E-6 |
| Getting Ready | E-6 |
| Recording an Image | E-7 |
| Viewing (Playing Back) an Image | E-8 |
| Deleting an Image | E-9 |
| Features | E-11 |
| Recording Features | E-13 |
| Precautions | E-14 |
| General Precautions | E-14 |
| Operating conditions | E-15 |
| Condensation | E-15 |
| Lens Precautions | E-16 |
| About the camera's backlight... .. | E-16 |

E-17 GETTING ACQUAINTED

| | |
|--------------------------------|------|
| General Guide | E-17 |
| Front | E-17 |
| Back | E-18 |
| Side | E-19 |
| Bottom | E-19 |
| Mode Dials | E-20 |
| Using the Control Button | E-21 |

| | |
|---|------|
| Monitor Screen Indicators | E-22 |
| REC mode | E-22 |
| PLAY mode | E-23 |
| Changing the Contents of the Monitor Screen | E-24 |
| Indicator display | E-24 |
| Operation Indicator Lamp | E-25 |
| Operation/card access lamp | E-25 |
| Flash Charge lamp | E-26 |
| AF Assist Light/Self-timer Lamp | E-26 |
| Using the Bundled Accessories | E-27 |
| Attaching the Neck Strap | E-27 |
| Adjusting the Length of the Neck Strap | E-27 |
| Using the Lens Cap | E-28 |
| Power Requirements | E-29 |
| Loading Batteries | E-29 |
| Battery Handling Precautions | E-32 |
| Low Battery Indicator | E-33 |
| Using AC Power | E-33 |
| Turning the Camera On and Off | E-35 |
| Power Save Settings | E-35 |
| Memory Cards | E-37 |
| Inserting a Memory Card into the Camera | E-37 |
| Removing a Memory Card from the Camera | E-38 |
| Formatting a Memory Card | E-39 |
| Memory Card Precautions | E-40 |
| IBM Microdrive Precautions | E-41 |
| Menu Screens | E-42 |

| | |
|---|------|
| Setting the Current Date and Time | E-43 |
| Setting the Date and Time | E-43 |
| Selecting the Date Format | E-44 |

E-45 BASIC IMAGE RECORDING

| | |
|--|------|
| Using the Full Auto Mode | E-45 |
| Recording Precautions | E-47 |
| Focusing | E-47 |
| About Auto Focus | E-48 |
| Image Recording when the Batteries are Low | E-48 |
| About the REC Mode Monitor Screen | E-49 |
| Using Optical Zoom | E-49 |
| Using the Viewfinder for Recording | E-51 |
| Using the Self-timer | E-52 |
| Camera Orientation Detection | E-53 |

E-54 OTHER RECORDING FUNCTIONS

| | |
|--|------|
| Recording a Single Image (1-Image) | E-54 |
| Previewing the Last Image Recorded | E-54 |
| Deleting the Last Image Recorded in the REC Mode | E-55 |

| | |
|---|------|
| Using the Flash | E-55 |
| Selecting the Flash Mode | E-55 |
| Flash Status Indicators | E-56 |
| Adjusting the Flash Intensity | E-57 |
| Changing the Sync Speed | E-57 |
| Selecting a Flash Sync Setting | E-58 |
| Precautions when Using Flash | E-60 |
| Selecting the Focus Mode | E-61 |
| Using Auto Focus (Multi-area Auto Focus) | E-62 |
| Using the Spot Auto Focus Mode | E-63 |
| Using the Manual Focus Mode | E-64 |
| Using the Infinity Mode | E-65 |
| Using the Macro Mode | E-65 |
| Using Focus Lock | E-66 |
| Expanding the Focus Area | E-67 |
| Camera Shake Indicator | E-67 |
| Selecting the Metering Mode | E-68 |
| Selecting White Balance | E-69 |
| Adjusting White Balance Manually | E-70 |
| Using AE Lock | E-71 |
| Exposure Compensation | E-72 |
| Using the Histogram | E-74 |
| Using Digital Zoom | E-75 |
| Instant Setup Using the Best Shot Mode | E-76 |
| Copying a Scene from the CD-ROM Best Shot Library | E-77 |
| Registering Your Own Best Shot Scenes | E-80 |
| Specifying the Location of Best Shot Mode Scenes | E-81 |

E-124 MANAGING IMAGES

| | |
|---|-------|
| Folders and Files | E-123 |
| Folders | E-123 |
| Files | E-124 |
| Protecting Images Against Deletion | E-125 |
| Protecting Selected Images | E-125 |
| Protecting and Unprotecting All Images in Selected Folders | E-126 |
| Protecting and Unprotecting All Images | E-127 |
| DPOF | E-127 |
| Making DPOF Settings for Particular Images | E-128 |
| Making DPOF Settings for Particular Folders | E-129 |
| Making DPOF Settings of All Images on the Memory Card | E-129 |
| PRINT Image Matching | E-130 |

E-131 OTHER SETTINGS

| | |
|--|-------|
| Changing the Menu Language | E-131 |
| Installing a Different Language Set | E-131 |
| Turning the Confirmation Beep On and Off | E-135 |

E-136 CONNECTING TO EXTERNAL EQUIPMENT

| | |
|--|-------|
| Connecting to a Television | E-136 |
| Selecting the Video Output Signal Mode | E-137 |
| Connecting to a Computer | E-138 |

| | |
|---|-------|
| Using a Memory Card to Transfer Image Data | E-140 |
| Memory Card Data | E-141 |
| DCF Protocol | E-141 |
| Memory Card File Structure | E-142 |
| Image Files Supported by the Camera | E-143 |
| Precautions when Using a Memory Card on a Computer | E-144 |
| Using the HTML Card Browser | E-145 |
| Specifying the Card Browser Type | E-145 |
| Viewing Card Browser File Contents | E-147 |
| Saving Card Browser Files | E-149 |

E-150 REFERENCE

| | |
|---|-------|
| Camera Menus | E-150 |
| REC mode | E-150 |
| PLAY mode | E-151 |
| Mode Settings | E-152 |
| Settings in Each Mode | E-152 |
| Drive Mode + Exposure Mode Combinations | E-153 |
| Full Auto Mode Settings | E-154 |
| Menu Settings | E-154 |
| Non-Menu Settings | E-154 |
| Troubleshooting | E-155 |
| Messages | E-158 |
| Specifications | E-160 |

INTRODUCTION

Quick Reference

Getting Ready

1

Load batteries.

(page E-29)

1



2



3



2

Insert the memory card.

(page E-37)

1

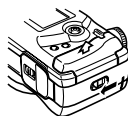

2

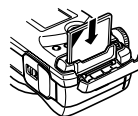
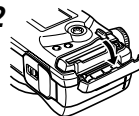

3



3

Set the current time and date.

(page E-43)

Recording an Image (page E-45)

1

Remove the lens cap from the lens.

2

Align the exposure mode dial with **A** (Full Auto Mode).

3

Align the drive mode dial with **□** (1-Image).

5

Point the camera at the subject, compose the image on the monitor screen, and press the shutter release button half way to focus the image.

4

Align the power/function switch with **⏻**.

6

After confirming that the Auto Focus operation is complete (the operation lamp lights green), press the shutter release button all the way down to record the image.

Use the Diopter Dial to adjust the view through the viewfinder to suit your particular eyesight. (page E-51)

Deleting an Image (page E-119)

4

Double check to make sure that you really want to delete the image you selected.

- You can exit the image delete operation by pressing AE-L .

1

Align the power/function switch with .

2

Rock the control button to the left or right to scroll through stored images and display the one you want to delete.

3

Press AE-L .

5

Rock the control button down to select “Yes” and then click the control button.

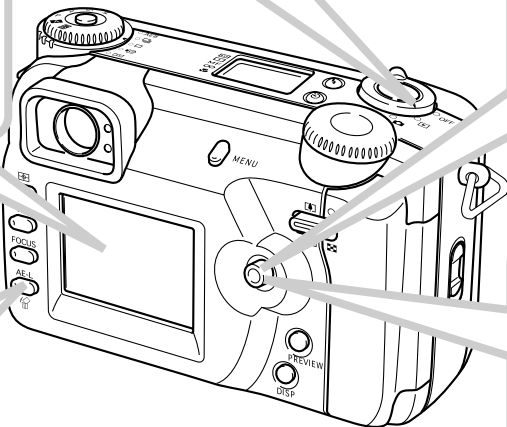

- CASIO COMPUTER CO., LTD. assumes no responsibility for any damage or loss resulting from the use of this manual.
- CASIO COMPUTER CO., LTD. assumes no responsibility for any loss or claims by third parties which may arise through the use of the QV-4000.
- CASIO COMPUTER CO., LTD. assumes no responsibility for any damage or loss caused by deletion of data as a result of malfunction, repairs, or battery replacement. Be sure to back up all important data on other media to protect against its loss.
- *Windows and Internet Explorer are registered trademarks of Microsoft Corporation.*
- *Macintosh is a registered trademark of Apple Computer, Inc.*
- *CompactFlash™ and the  logo are registered trademarks of SanDisk Corporation.*
- *The USB driver uses software by Phoenix Technologies Ltd.*
Compatibility Software Copyright © 1997
Phoenix Technologies Ltd., All Rights Reserved.
- *IBM is a registered trademark of International Business Machines Corporation.*
- *Other company, product and service names used herein may also be trademarks or service marks of others.*

Features

- High-resolution 4.13-megapixel CCD
Record images that capture everything from delicate skin tone nuances to all the fine detail of natural scenery.
 - Canon F2.0 wide-aperture lens
Provides high contrast and captures the most delicate of nuances.
 - World's first digital soft focus
Creates stunning effects for portraits and floral shots.
 - Real-time histogram
Quickly and easily obtains exactly the exposure you want, even under difficult lighting conditions.
 - Easy-to-understand control panel
Aperture, shutter speed, focus and other settings can be seen at a glance, even when the monitor screen is turned off.
 - Dual dial operation
A pair of dials helps to make drive mode and exposure mode settings quick and easy.
 - AF assist light
Improves auto focus accuracy when shooting under dim lighting.
 - Multi-area AF
Helps to prevent out-of-focus areas in an image.
- Focus area expansion
Makes it easier achieve the focus you want.
 - Image preview
Provides instant preview of an image you just recorded.
 - 1.8-inch TFT low-glare color LCD (HAST) monitor screen
 - 9.6X seamless digital zoom
3X digital zoom, 3.2X digital zoom
 - External flash connectability
 - Memory card image storage
Supports CompactFlash cards (CF TYPE I/II) and the IBM Microdrive.
 - Digital Print Order Format (DPOF)
Images can be printed easily in the sequence you want using a DPOF compatible printer. DPOF can also be used when specifying images and quantities for printing by professional print services.
 - PRINT Image Matching support
Images include PRINT Image Matching data (mode setting and other camera setup information). A printer that supports PRINT Image Matching reads this data and adjusts the printed image accordingly, so your images come out just the way you intended when you recorded them.

- DCF Data Storage
DCF (Design rule for Camera File system) data storage protocol provides image inter-compatibility with printers and other digital cameras.
- VIDEO OUT terminal
Connects to your TV for big-screen viewing of images.
- USB compatibility
Connects to your computer for quick and easy image exchange.
- Image management and manipulation software
The QV-4000 comes bundled with a CD-ROM that's packed with useful software: Photo Loader for transferring images to your computer, Photohands* for editing and printing images, and Panorama Editor* for stitching images into panoramas. Other bundled...
* Windows version only.

Recording Features

Best Shot Mode

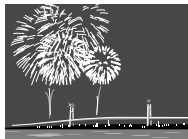

page E-76

Movie Mode

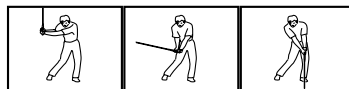

page E-93

Auto Exposure Bracketting (AEB)

Automatically records multiple images at different exposure settings.



page E-89

Panorama Mode

Stitches multiple images into a sweeping panorama.



page E-91

Five focus modes

Multi-area AF, Spot AF, Manual, Infinity, Macro

page E-62 to E-65

Three metering modes

Multi-pattern, Center-weighted, Spot

page E-68

Five exposure modes

Full auto, Program AE, aperture priority AE, shutter speed priority AE, manual exposure

page E-82 to E-87

Precautions

General Precautions

Be sure to observe the following important precautions whenever using the QV-4000.

All references in this manual to “this camera” and “the camera” refer to the CASIO QV-4000 Digital Camera.

- Never try to take pictures or use the built-in display while operating a motor vehicle or while walking. Doing so creates the danger of serious accident.
- Never try to open the case of the camera or attempt your own repairs. High-voltage internal components create the risk of electrical shock when exposed. Always leave maintenance and repair work up to authorized CASIO service providers.
- Never fire the flash in the direction of a person operating a motor vehicle. Doing so can interfere with the driver's vision and create the danger of accident.
- Never fire the flash while it is too close to the subject's eyes. Intense light from the flash can cause eye damage if it is fired too close to the eyes, especially with young children. When using the flash, the camera should be at least one meter from the eyes of the subject.
- Keep the camera away from water and other liquids, and never let it get wet. Moisture creates the danger of fire and electrical shock. Never use the camera outdoors in the rain or snow, at the seashore or beach, in the bathroom, etc.

- Should foreign matter or water ever get into the camera, immediately turn power off, unplug the AC adaptor from the power outlet, and contact your dealer or nearest CASIO service provider. Using the camera under these conditions creates the danger of fire and electrical shock.
- Should you ever notice smoke or a strange odor coming out of the camera, immediately turn power off and unplug the AC adaptor from the power outlet. Using the camera under these conditions creates the danger of fire and electrical shock. After making sure there is no more smoke coming from the camera, take it to your nearest CASIO service provider for repair. Never attempt your own maintenance.
- At least once a year, unplug the AC adaptor from the power outlet and clean the area around the prongs of the plug. Dust build up around the prongs can create the danger of fire.
- If the camera's case should ever become cracked due to dropping it or otherwise subjecting it to rough treatment, immediately turn power off, unplug the AC adaptor from the power outlet, and contact your nearest CASIO service provider.
- Never use the camera inside of an aircraft or in any other areas where its use is prohibited. Doing so can result in an accident.
- Physical damage and malfunction of this camera can cause the image data stored in its memory to be deleted. Be sure to always keep backup copies of data by transferring them to personal computer memory.

- Never open the battery compartment cover, disconnect the AC adaptor from the camera or unplug it from the wall socket while recording images. Doing so will not only make storage of the current image impossible, it can also corrupt other image data already stored in camera memory.

Operating conditions

- This camera is designed for use in temperatures ranging from 0°C to 40°C.
- Do not use or keep the camera in the following areas.
 - In areas subject to direct sunlight
 - In areas subject to high humidity or dust
 - Near air conditioners, heaters, or other areas subject to temperature extremes
 - Inside of a closed vehicle, especially one parked in the sun
 - In areas subject to strong vibration

Condensation

- When you bring the camera indoors on a cold day or otherwise expose it to a sudden change of temperature, condensation can form on the exterior of the camera or on internal components. Condensation can cause malfunction of the camera, so you should avoid exposing it to conditions that might cause condensation.
- To keep condensation from forming, place the camera into a plastic bag before moving it into a location that is much warmer or colder than your current location. Leave it in the plastic bag until the air inside the bag has a chance to reach the same temperature as the new location.

Lens Precautions

- Fingerprints, dust, or any other soiling of the lens can interfere with proper image recording. Never touch the lens with your fingers. You can remove dust particles from the lens surface by using a lens blower to blow them off. Next, wipe the surface of the lens with a soft lens cloth.
- The lens of this camera extends from its body when you turn on power and retracts when you turn off power. Take care not to subject the lens to undue force or impact, and never set the camera face down so the lens is in contact with a tabletop, etc. Be sure to remove the lens cap before turning on the camera.
- If you align the power/function switch with  while the lens cap is on the lens, the message “LENS CAP” appears on the display and camera power turns off automatically. If this happens, remove the lens cap and try again.
- Never remove the camera’s batteries or unplug its AC adaptor while the lens is extended. Doing so leaves the lens extended, and creates the risk of lens damage.

About the camera’s backlight...

- The camera is equipped with a fluorescent light source to provide the back lighting for its LCD.
- The normal service life of the backlight is approximately six years, when the camera is used for about two hours a day.
- Should the LCD image appear abnormally dark, take the camera to your dealer or an authorized CASIO service provider to have the light source replaced. Note that you will be charged for this replacement.
- Under very cold conditions, the backlight may require more time than normal to light, or reddish bands may appear in the displayed image. These conditions do not indicate malfunction, and normal operation should return at higher temperatures.

GETTING ACQUAINTED

This section contains important information you should know when trying to operate the camera.

General Guide

The following illustrations show the names of each component, button, and switch on the camera.

Front

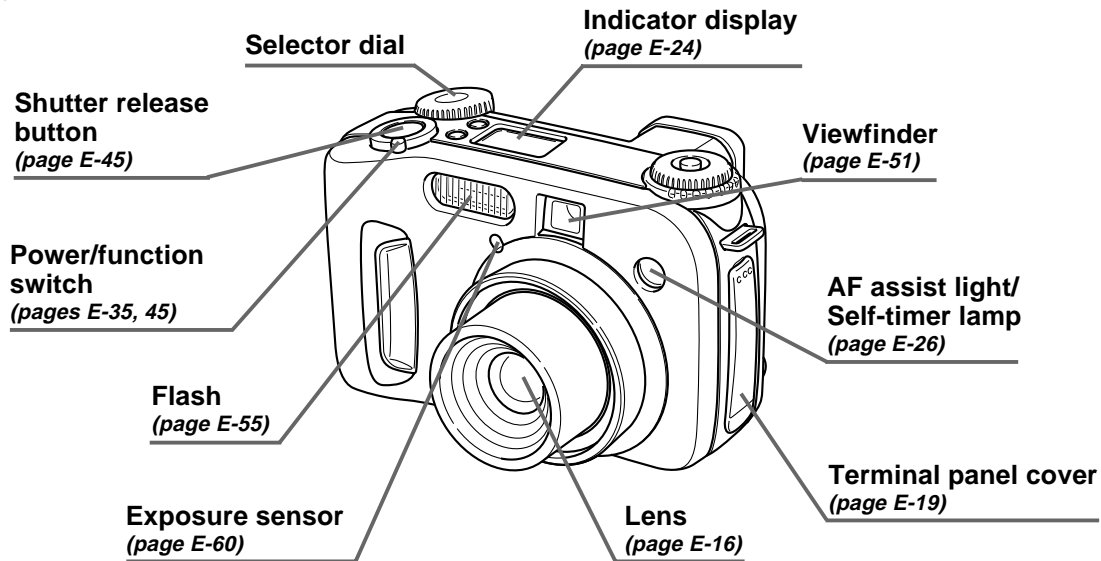

Back

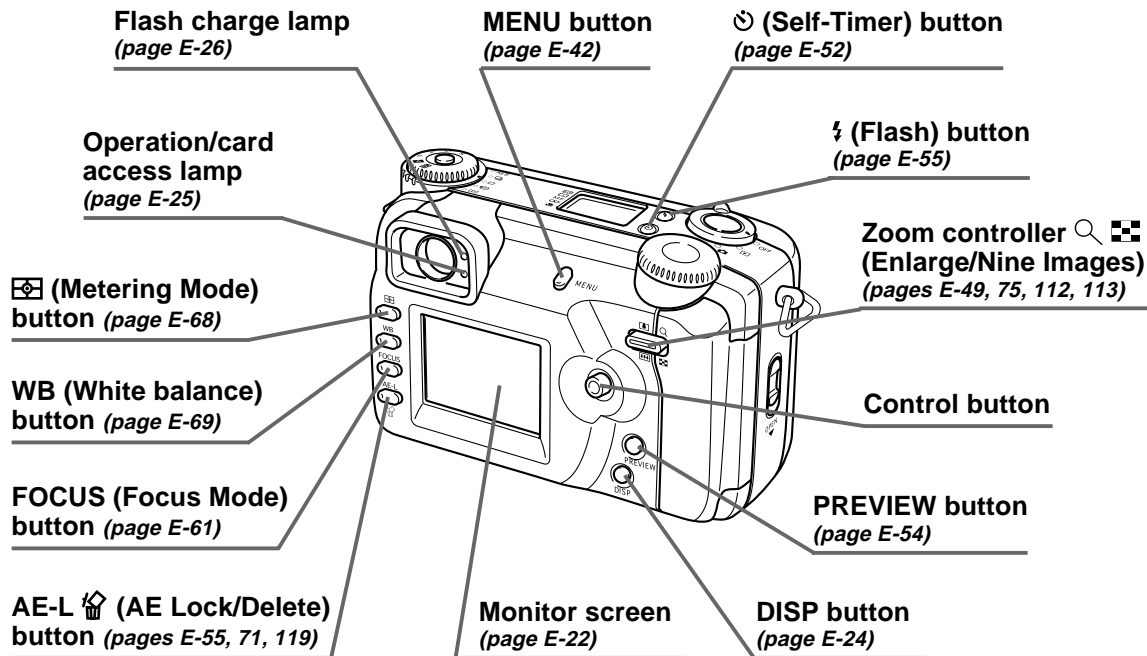

Side

DIGITAL terminal
(page E-103)

Diopter dial
(page E-51)

VIDEO OUT terminal
(page E-136)

USB port
(page E-138)

DC IN 6V terminal
(page E-33)

**External flash
sync terminal**
(page E-104)

**Memory card slot
cover** (pages E-37, 38)

**Card slot cover
lock** (pages E-37, 38)

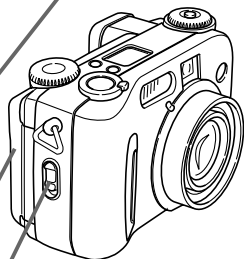
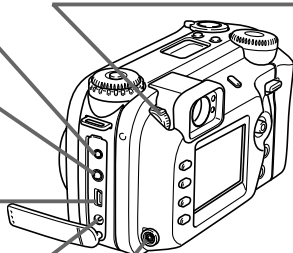

Bottom

**Tripod
screw hole**

**Battery compartment
cover lock** (page E-29)

**Battery compartment
cover** (page E-29)

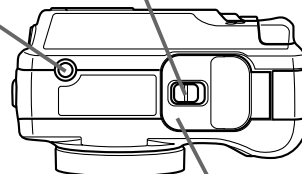



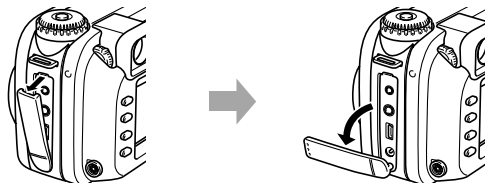

Open Terminal Panel Cover

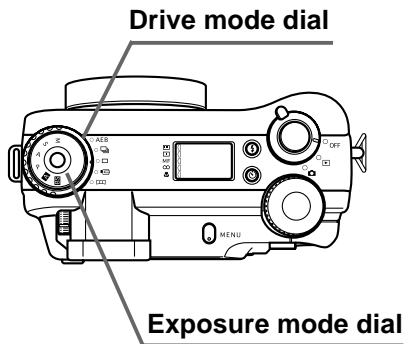

Mode Dials



■ Drive mode dial

| | | |
|---|--------------------------------|-----------|
| AEB | Auto Exposure Bracketing (AEB) | page E-89 |
|  | Continuous Shutter recording | page E-88 |
|  | 1-Image recording | page E-54 |
|  | Movie recording | page E-93 |
|  | Panorama recording | page E-91 |

■ Exposure mode dial

| | | |
|-----------|------------------------------------|-----------|
| M | M Mode (Manual Exposure) | page E-87 |
| S | S Mode (Shutter Speed Priority AE) | page E-85 |
| A | A Mode (Aperture Priority AE) | page E-84 |
| P | P Mode (Program AE) | page E-83 |
| A | Full Auto Mode | page E-82 |
| BS | Best Shot Mode | page E-76 |

Using the Control Button

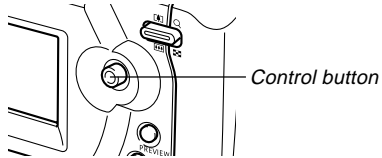

The control button is used to select menu items and execute function. The following are the terms used in this manual to describe control button operations.

| Term | Meaning |
|-------|--|
| Rock | Use your thumb to move the control button up, down, left, or right. |
| Click | Press the control button straight down until it clicks, something like a computer mouse. |

Monitor Screen Indicators

The following describes the different indicators and markings that appear on the camera's monitor screen.

REC mode

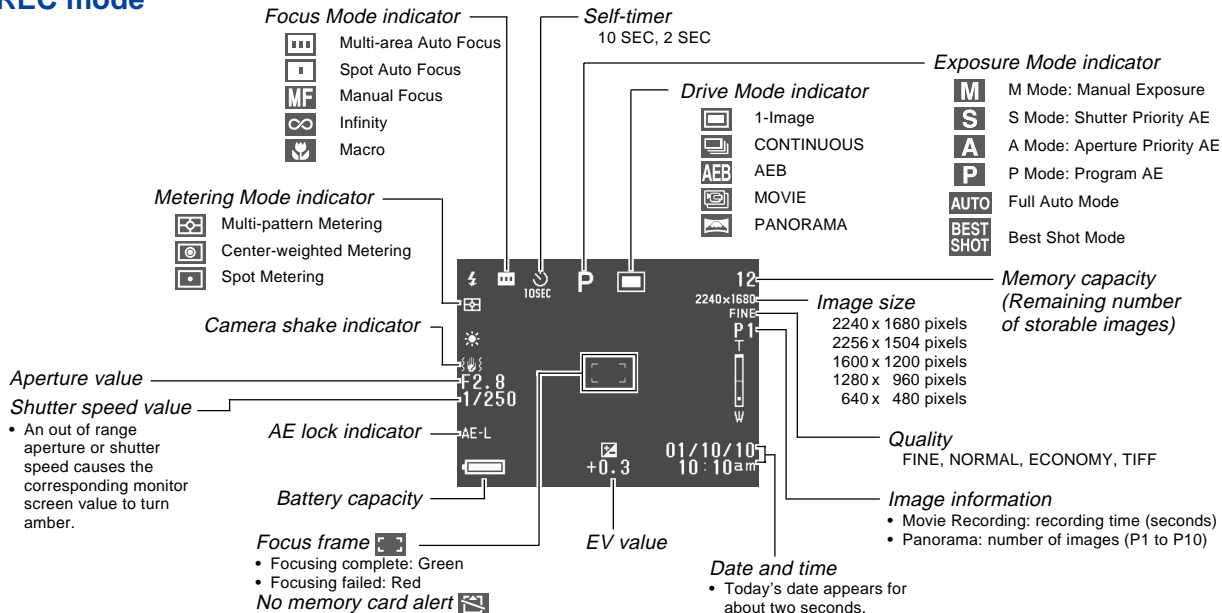

Flash Mode indicator

None Auto



Flash On



Flash Off



Red-eye reduction

- Flash indicator indicates that the flash will fire (when auto flash is selected).

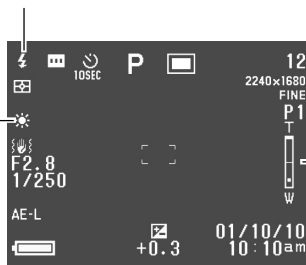
**White balance indicator**

Daylight

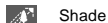

Shade

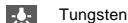

Tungsten



Fluorescent



Manual

Zoom bar

- Lower half indicates optical zoom.
- Upper half indicates digital zoom.

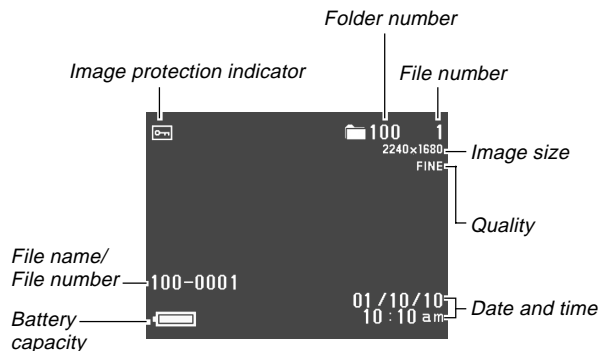
PLAY mode

Changing the Contents of the Monitor Screen

Use DISP to cycle through monitor screen information settings as shown below.

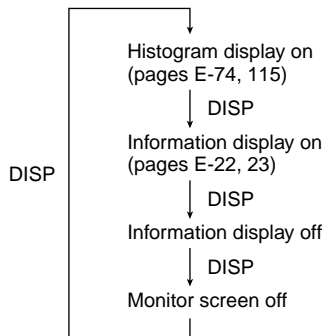

IMPORTANT!

- The histogram is not displayed in the movie REC or PLAY mode (pages E-93,110).

Indicator display

The indicator display located on the top of the camera also shows various camera status indicators during image recording. The indicator display comes in handy especially when the monitor screen is turned off.

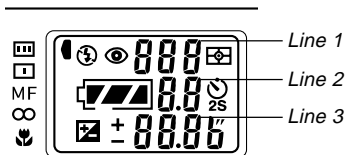

| | | | |
|---------------|--|---------------|------------------------------------|
| | Multi-area AF indicator | | Multi-pattern Metering indicator |
| | Spot AF indicator | | Center-weighted Metering indicator |
| MF | Manual focus indicator | | Spot Metering indicator |
| | Infinity indicator | | Battery capacity |
| | Macro mode indicator | Line 2 | Aperture value |
| | Flash off indicator | | Self-timer time settings |
| | Flash on indicator | | Exposure compensation |
| | Red eye reduction indicator | Line 3 | Shutter speed value/EV value |
| Line 1 | Remaining number of images/File number | | |

Operation Indicator Lamp

Operation/card access lamp

The operation/card access lamp shows the operational status of the camera as described below.

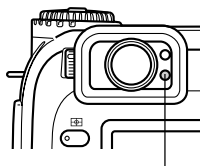

Operation/card access lamp

REC mode

| Lamp Color | Flashing |
|------------|--|
| Green | One of the following operations is in progress: start up, save (multiple), movie recording standby |

- The camera is ready to record when the lamp is off.

Partial press of the shutter release button

| Lamp Color | On |
|------------|-----------------------------|
| Green | Auto Focus complete |
| Red | Auto Focus operation failed |

PLAY mode

| Lamp Color | Flashing |
|------------|---|
| Green | One of the following operations is in progress: delete, format, battery alert, card browser generation. |
| Red | Memory card is defective. |

- The operation/card access lamp remains lit (green) while the monitor screen is turned off in the PLAY mode.

IMPORTANT!

- Never open the memory card cover while the operation/card access lamp is flashing.

Flash Charge lamp

The flash charge lamp also lights and flashes during a record operation as described below.

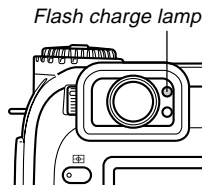

REC mode

| Lamp Color | Flashing |
|------------|--------------------|
| Amber | Flash is charging. |

Partial press of the shutter release button

| Lamp Color | On |
|------------|----------------|
| Amber | Ready to fire. |

IMPORTANT!

- When batteries go low, the operation/card access lamp and flash charge lamp flash amber for about one second. After that, the camera powers down automatically. If this happens, replace batteries as soon as possible.

AF Assist Light/Self-timer Lamp

The AF assist light operates automatically to assist the Auto Focus operation whenever you are shooting where lighting is dim. This lamp also flashes to indicate the countdown until the shutter releases during a self-timer operation.

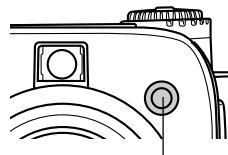

AF assist light/self-timer lamp

IMPORTANT!

- Auto Focus using the AF assist light/ self-timer lamp is possible when the distance from the camera to the subject is less than about 2.5 meters.
- When the AF assist light operates while Multi-area AF or Spot AF is specified as the focus mode, the camera automatically assumes that focus area is the center area for Spot AF. See pages E-62 and E-63 for more information.
- Do not look directly at the AF assist light/self-timer lamp or point it directly at the subject's eyes.

Using the Bundled Accessories

Attaching the Neck Strap

Attach the neck strap to the strap ring as shown in the illustration below.

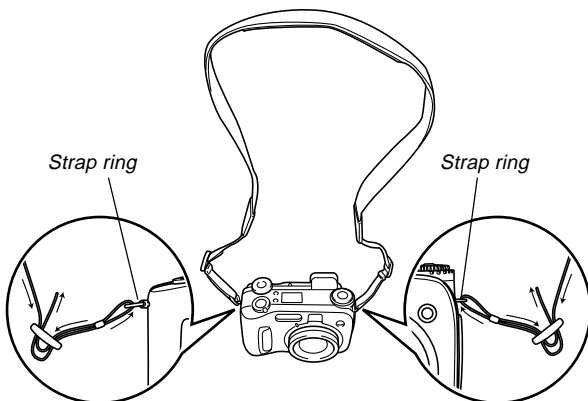

Adjusting the Length of the Neck Strap

Use the buckle to adjust the length of the neck strap.

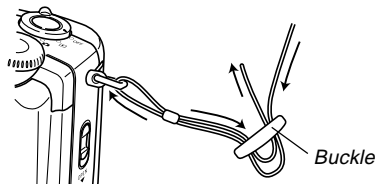

IMPORTANT!

- Be sure to keep the neck strap around your neck when using the camera to protect against accidentally dropping it.
- The supplied neck strap is intended for use with this camera only. Do not use it for any other application.
- Never swing the camera around by the neck strap.
- Allowing the camera to swing freely from your neck can result in damage to the camera due to its bumping against other objects. It also creates the danger of the camera becoming caught in a door or on other objects, resulting in personal injury.
- Keep the camera out of the reach of small children, especially when the neck strap is attached. The neck strap can accidentally wind around the neck of a child and create the risk of strangulation.

Using the Lens Cap

Always keep the lens cap on the lens whenever you are not using the camera. Always leave the lens cap on the lens when the camera is turned off and the lens is retracted.

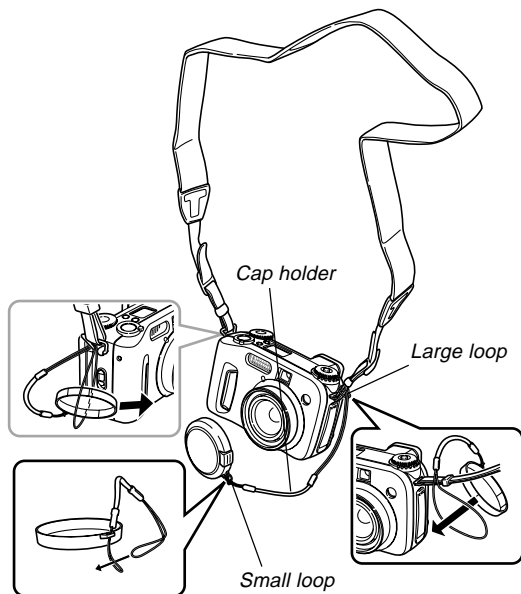

Attach the lens cap holder to the neck strap or the strap ring. This protects against accidental loss of the lens cap.

IMPORTANT!

- Never turn on camera power with the lens cap affixed to the lens.

Power Requirements

Your camera features a two-way power supply that lets you use either AA-size batteries or household AC current.

■ Batteries

- Four AA-size alkaline batteries: LR6
- Four AA-size lithium batteries: FR6
- Four AA-size nickel-metal hydride rechargeable batteries: NP-H3

■ Household Current

- AC Adaptor: AD-C620 (Option)
- AC Adaptor/Charger: BC-3HA (Option)

Loading Batteries

Make sure that camera power is turned off whenever loading or replacing batteries.

- 1. On the bottom of the camera, slide the battery compartment cover lock in the direction indicated by the arrow and open the battery compartment cover.**

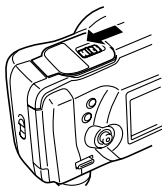

- 2. Load the batteries so their plus (+) and minus (-) ends are facing as shown in the illustration.**



- 3. Close and press down on the battery compartment cover as you slide the battery compartment cover lock in the direction indicated by the arrow to lock it.**



IMPORTANT!

- Never use manganese batteries. Use only the battery types specifically mentioned in this User's Guide.

● Battery Life Guidelines

The battery life guideline values given below indicate the amount of time at standard temperature (25°C) until power automatically turns off due to battery failure. They do not guarantee that batteries will provide the amount of service indicated. Low temperatures reduce battery life.

| Type of Operation | Continuous Playback | Continuous Recording |
|--------------------------------|---------------------|---------------------------|
| AA-size Alkaline Batteries LR6 | 170 minutes | 90 minutes (540 shots) |
| AA-size Lithium Batteries FR6 | 320 minutes | 180 minutes (1,130 shots) |
| AA-size Ni-MH Batteries NP-H3 | 180 minutes | 100 minutes (600 shots) |

- The above values are approximations only.
- The above guidelines are based on the following battery types:
Alkaline: MX1500 (AA) DURACELL ULTRA
Lithium: Energizer
* Battery life varies with brand.
- Values are based on continuous recording under the following conditions.
 - Flash turned off
 - One switch between telephoto and wide-angle with the zoom controller per image

- Recording one image per minute under the above conditions reduces battery life to about one sixth of that noted above.
- Battery life is greatly affected by how much you use flash, zoom and other functions, and how long you leave power turned on.

● Tips for Prolonging Battery Life

- Use ζ to turn off the flash when you are not using it (page E-55).
- You can also use the power save settings (page E-35) to protect against wasting battery power when you forget to turn off the camera.
- You can also conserve battery power by using DISP to turn off the monitor screen.

● Alkaline Battery Life

The actual life of alkaline batteries is affected by a variety of factors, including the battery manufacturer, the amount of time the batteries spend in storage before you use them, temperature while you are recording, and photographic conditions. As a rule, we recommend the use of lithium batteries or Ni-MH batteries, which have longer lives than alkaline batteries.

The following examples show how alkaline battery life changes under different shooting conditions.

Example 1: Intermittent use of the camera shortens battery life.

Conditions

- Temperature: 25°C
- Repeat of a cycle of recording of one shot per minute for 10 minutes, followed by one minute of playback, and nine minutes of power off (power on, full lens extension, half lens contraction, full lens extension, image recording, power off)
- Flash on

Approximate Battery Life: 35 minutes (32 shots)

Example 2: Low temperatures shorten battery life.

Conditions

- Temperature: 0°C
- Repeat of a cycle of recording of one shot per minute for 10 minutes, followed by one minute of playback, and nine minutes of power off (power on, full lens extension, half lens contraction, full lens extension, image recording, power off)
- Flash on

Approximate Battery Life: 8 minutes (8 shots)

● About rechargeable batteries

Use only the nickel-metal hydride batteries (NP-H3) that are specifically recommended for this camera. Proper camera operation is not guaranteed when other rechargeable batteries are used.

AC Adaptor/Charger : BC-3HA

Nickel-metal hydride batteries (4-battery set)/Quick Charger Set : BC-1HB4

Nickel-metal hydride batteries (4-battery set) : NP-H3P4

IMPORTANT!

- Be sure to keep all four batteries together as a set at all times, for both charging and powering the camera. Mixing batteries from different sets can shorten overall battery life and cause malfunction of the camera.
- Batteries cannot be charged while they are loaded in the camera.

Battery Handling Precautions

Incorrect use or handling of batteries can cause them to leak or burst and create the danger of serious damage to your camera. Be sure to note the following important precautions to avoid problems with batteries.









- Use only LR6 (AM-3) type alkaline or FR6 type lithium or Ni-MH (nickel-metal hydride) dry cell batteries with this camera. Never mix old batteries with new ones. Doing so can result in bursting or leaking of batteries, creating the danger of fire or personal injury.
- Always make sure that the plus (+) and minus (–) ends of the batteries are facing correctly, as noted by the markings on the camera itself. Improper loading of batteries can result in bursting or leaking of batteries, creating the danger of personal injury or soiling of objects nearby.

- Remove batteries from the camera if you do not plan to use it for more than two weeks.
- Never recharge non-rechargeable type batteries, never allow direct connection between two ends of a battery, and never try to take batteries apart.
- Do not expose batteries to direct heat or dispose of them by burning. Doing so can create the danger of explosion.
- Never mix batteries of different types.
- Dead batteries are susceptible to leakage, which can cause serious damage to your camera. Remove batteries from the camera as soon as you notice they are dead.
- The batteries that power the camera normally become warm as they discharge.

Low Battery Indicator

The following shows how the battery capacity indicator on the monitor screen and the indicator display changes as battery power is used. Replace all four batteries as soon as possible after they go dead. If you continue to use the camera while the battery level is , camera power will automatically turn off.

| | |
|-------------------|---|
| Battery Capacity | High ←————→ Low |
| Monitor Screen |  →  →  |
| Indicator Display |  →  →  |

Using AC Power

Use the adaptor as shown below to power the camera from a household power outlet.

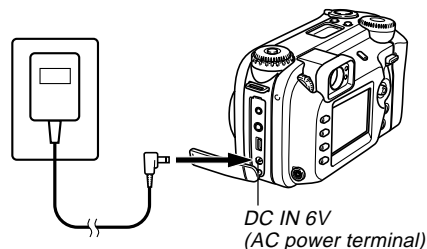

- AC Adaptor: AD-C620 (Option)
- AC Adaptor/Charger: BC-3HA (Option)
The BC-3HA functions both as an AC adaptor and as a charger unit for AA-size nickel metal hydride batteries. It comes complete with four rechargeable nickel metal hydride batteries. This AC adaptor/charger unit can be used with any household power outlet rated for 100V to 240V AC.

AC Adaptor precautions

- Never use an electrical outlet whose voltage is outside the rating marked on the AC adaptor. Doing so can create the danger of fire or electrical shock. Use only the optional AC adaptor specified for this camera.
- Do not allow the AC adaptor power cord to become cut or damaged, do not place heavy objects on it, and keep it away from heat. A damaged power cord creates the risk of fire and electrical shock.
- Never try to modify the AC adaptor power cord, or subject it to severe bending, twisting, or pulling. Doing so creates the risk of fire and electrical shock.
- Never touch the AC adaptor while your hands are wet. Doing so creates the risk of electrical shock.
- Do not overload extension cords or wall outlets. Doing so creates the danger of fire and electrical shock.
- Should the cord of the AC adaptor become damaged (exposed internal wiring), request a replacement from an authorized CASIO service provider. A damaged AC adaptor cord creates the danger of fire or electrical shock.





- Be sure to turn off power before connecting or disconnecting the adaptor.
- Always turn camera power off before disconnecting the AC adaptor, even if the camera has batteries installed. If you don't, the camera will turn off automatically when you disconnect the AC adaptor. You also run the risk of damaging the camera whenever you disconnect the AC adaptor without first turning power off.
- The AC adaptor may become warm to touch after extended periods of use. This is normal and is not cause for alarm.
- After using the camera, turn it off and unplug the adaptor from the AC outlet.
- The camera automatically switches over to AC adaptor powered operation whenever the AC adaptor is plugged into the camera.
- Always use the AC adaptor to power the camera whenever it is connected to a computer.





Turning the Camera On and Off

Rotate the power/function switch to turn camera power on and off.



-  : Turns on power and enters the REC mode.
-  : Turns on power and enters the PLAY mode.
- OFF : Turns off power.

IMPORTANT!

- Never align the power/function switch with  while the lens cap is on the lens.
- Never align the power/function switch with  while the lens is facing downwards towards the ground.
- To restore camera power after it has been turned off by auto power off, rotate the power/function switch to OFF and then back to  or .

Power Save Settings

The settings described below let you specify sleep and auto power off trigger times that help to conserve valuable battery power.

AUTO POWER OFF

Auto Power Off turns off camera power if no operation is performed for five minutes in the PLAY mode. In the REC mode, you can specify an Auto Power Off trigger time of two or five minutes.

SLEEP

The monitor screen enters a sleep state if no operation is performed for a specified amount of time in the REC mode. Pressing any button immediately wakes up the monitor and restores normal operation. You can specify 30 seconds, 1 minute, or 2 minutes before the sleep state is triggered, or you can turn off this setting entirely.

To configure power save settings

1. Align the power/function switch with .
2. Press MENU.
3. Rock the control button up or down to select “Power Save” and then rock the control button to the right.
4. Rock the control button up or down to select the item whose settings you want to change, and then rock the control button to the right.
 - To make auto power off settings, select “Auto Power Off”.
 - To make sleep settings, select “Sleep”.
5. On the screen that appears, rock the control button up or down to make the setting you want, and then click the control button to apply it.

Auto power off settings: “2 min” “5 min”
Sleep settings: “Off” “30 sec” “1 min” “2 min”
6. Press MENU to exit the setting procedure.

- In the PLAY mode, the Auto Power Off trigger time is fixed at five minutes.
- Sleep is disabled in the PLAY mode.
- Performing any button operation while the monitor is asleep immediately wakes it up and restores normal operation.
- The Auto Power Off setting is given priority if you have “2 min” set for both Sleep and Auto Power Off. This means that the camera turns off if you do not perform any operation for about two minutes in the REC mode.
- Auto Power Off is automatically disabled under any one of the following conditions.
 - While a slideshow is playing
 - When you are performing operations on a computer connected to the camera's USB port
 - While the AC adaptor is connected to the camera

Memory Cards

This camera supports use of a CompactFlash memory card (CF TYPE I/II) or IBM Microdrive for image storage. Note that all mentions of “memory” card in this manual refer both to a CompactFlash memory card and IBM Microdrive, unless specifically noted otherwise.

IMPORTANT!

- Make sure that the power of the camera is turned off before you insert or remove a memory card.
- When inserting a memory card into the camera, make sure its correct side is facing up and that you insert its terminal end into the camera. Trying to force a card into the camera can damage the card and the camera.

Inserting a Memory Card into the Camera

1. Slide the card slot cover lock in the direction indicated by the arrow and open the memory card slot cover.

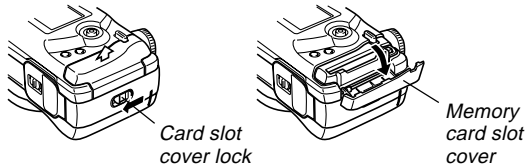

2. With the side of the memory card that has an arrow marked facing towards the memory card slot cover, slide the card into the camera as far as it will go.

- If the eject button is extended, press it in before sliding the memory card into the slot.

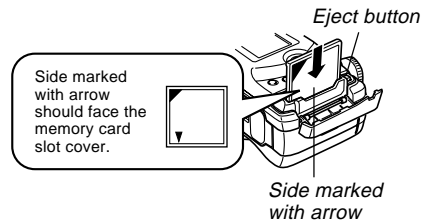

3. Close the memory card slot cover.



Removing a Memory Card from the Camera

1. Slide the card slot cover lock in the direction indicated by the arrow and open the memory card slot cover.

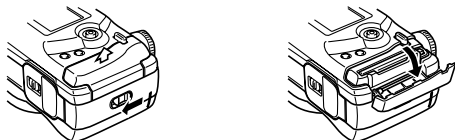

2. Press the eject button so it extends from the camera.

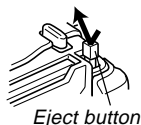

3. Press the eject button once again to eject the card.

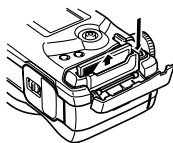

4. Remove the memory card.

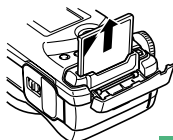

5. Close the memory card slot cover.



IMPORTANT!



- Insert only memory cards into the memory card slot. Inserting any other type of card can cause malfunction.
- Should water or any other foreign matter get into the memory card slot, immediately turn off power, unplug the AC adaptor, and contact your original retailer or nearest CASIO Service Provider.
- Never eject the memory card while the card slot is facing downwards. Doing so creates the danger of the memory card falling, which can corrupt data or damage the memory card.
- Never remove the memory card from the camera while the operation/card access lamp is flashing. Doing so can cause loss of recorded images or corruption of memory card data.

Formatting a Memory Card

You can format a memory card to delete all of the data stored on it.

IMPORTANT!

- Formatting a memory card deletes all images on the card, even if some or all of the images are protected (page E-125).
- Formatting a memory card deletes all Best Shot Mode scene files you have imported from the CD-ROM and stored on the card. After formatting the card, you have to import the Best Shot scene files you want to the memory card (page E-77).
- Data deleted by a memory card format operation cannot be recovered! Be sure to carefully check and confirm that you no longer need the data stored in a memory card before formatting it.

1. Align the power/function switch with  or .
2. Press MENU.
3. Select “Format” and then rock the control button to the right (page E-42).
4. In response to the confirmation message that appears, rock the control button up or down to select “Yes” to format or “No” to exit and then click the control button.

Yes : Formats the memory card.

No : Does not format the memory card.

Memory Card Precautions

- Images cannot be recorded with this camera unless a memory card is installed in it.
- Be sure to use only CASIO or SanDisk CompactFlash cards, or an IBM Microdrive. Proper operation is not guaranteed with other memory cards.
- Static electricity, electrical noise, and other electrical phenomena can cause corruption or even total loss of data stored on a memory card. Because of this, you should always make backup copies of important images on other media.
- Memory card problems can be corrected by reformatting the memory card. Reformatting a memory card deletes all images stored on the card, but you can use a computer to copy the images you want to keep to the computer's hard disk before reformatting your card. If you plan to be recording images where you do not have access to a computer, it is a good idea to take along an extra memory card or two just in case you experience an unexpected memory card problem.

- Formatting is recommended for any memory card that you suspect contains corrupted image data (due to a RECORD ERROR, strange image colors, malformed images) or for newly purchased memory cards.
- Before starting a format operation, switch to AC adaptor power or load a new set of recommended batteries into the camera.

IBM Microdrive Precautions

Compatibility of the camera with the IBM Microdrive has been confirmed by CASIO. However, you should note the following important points whenever using the IBM Microdrive.

- Be sure to carefully read all of the documentation that comes with the Microdrive before using it.
- Note that the Microdrive becomes hot during normal use. Take care when removing it from the camera.
- Take care to avoid strong pressure on the label side of the Microdrive when it is removed from the camera. Strong pressure can damage internal components and cause malfunction.
- Never turn off camera power or subject the camera to impact while the operation/card access lamp is flashing. Doing so can cause malfunction of the Microdrive.
- The Microdrive is a very high precision device. Dropping the camera can result in malfunction of the Microdrive, even though the camera is undamaged. Take extra care when handling the camera while the Microdrive is installed.
- The Microdrive has very large storage capacity. Because of this, certain operations can take a relatively long time to perform.
- The Microdrive may not operate properly in areas where barometric pressure is low. Because of this, you should avoid using it at high altitudes.

- A Microdrive consumes much more electrical power than a CompactFlash card. Depending on how a Microdrive is used, it can greatly reduce battery life. When using alkaline batteries, certain operating conditions and certain battery brands can result in batteries going dead right after you install new ones. Whenever using a Microdrive, we recommend that you use rechargeable nickel metal hydride batteries or lithium batteries to power the camera.
- When battery power is low, the amount of time required between shots may become longer. This longer interval is designed to protect the Microdrive.

In case of Microdrive malfunction....

- Contact your original Microdrive retailer or the contact point noted in the Microdrive documentation.
- CASIO does not provide any servicing or maintenance support for the Microdrive.
- Note that CASIO assumes no responsibility for any data loss you may suffer while using the Microdrive.
- This camera supports use of both a CompactFlash card and the Microdrive. Note, however, that ejecting a Microdrive from the camera is relatively more difficult than ejecting a CompactFlash card.

Menu Screens

Pressing MENU displays the menu screen. The contents of the menu screen depend on whether you are in the PLAY mode or REC mode. The following procedure shows operation in the REC mode as an example.

1. Align the power/function switch with .

- To perform a menu operation in the PLAY mode, align the power/function switch with .

2. Press MENU.



| If you want to do this: | Do this: |
|---|---------------------------------------|
| Select a menu item | Rock the control button up or down. |
| Display details of the selected menu item | Rock the control button to the right. |
| Execute the selected item | Click the control button. |
| Back step to the previous screen | Press MENU. |

3. Rock the control button up or down to select the menu item you want, and then rock the control button to the right.



- See the “Camera Menus” on page E-150 for more information about menu contents.

Setting the Current Date and Time



Use the following procedures to set the current date and time, and to select the date format.

When you record an image, the time and date the image was shot is registered in accordance with data from the camera's built-in clock. You can even use the time stamp function to "stamp" the date and time inside the image (page E-100).

IMPORTANT!

- The time and date settings are cleared if the camera is left for about 24 hours without battery and AC power being supplied. If this happens, restore power and make new time and date settings before using the camera again.
- A flashing time display indicates that the time and date (clock) settings have been cleared. Use the procedure on this page to make the correct time and date settings.
- If you do not set the camera's built-in clock to the current date and time, all images are recorded with the default date and time, which probably is not your correct current date and time. Be sure to correctly set the clock before you use the camera.

Setting the Date and Time

1. Align the power/function switch with  or .
2. Press MENU.
3. Select "Date" and then rock the control button to the right.
4. Select "Adjust" and then rock the control button to the right.
5. Select and change the digits on the screen to set the current date and time.

Purple selection boundary





| If you want to do this: | Do this: |
|--|---|
| Move the selection boundary | Rock the control button to the left or right. |
| Increase or decrease the value where the selection boundary is located | Rock the control button up or down. |

6. Click the control button to apply your settings.
7. Press MENU to exit the setting procedure.

Selecting the Date Format

You can use the following procedure to select one of the three different date formats.

1. Align the power/function switch with  or .
2. Press MENU.
3. Select “Date” and then rock the control button to the right.
4. Select “Date Style” and then rock the control button to the right.
5. Rock the control button up or down to select the setting you want to use, and then click the control button to apply it.

Example: October 23, 2001

Year/Month/Day: 01/10/23

Day/Month/Year: 23/10/01

Month/Day/Year: 10/23/01



6. Press MENU to exit the setting procedure.



BASIC IMAGE RECORDING

This section describes the basic procedure for recording an image using the Full Auto Mode. It also explains about basic camera settings.

Using the Full Auto Mode

The Full Auto Mode makes it easy even for complete novices to record good-looking digital images every time. The camera makes focus, shutter speed, aperture, flash and other settings automatically in accordance with subject brightness.

1. Before turning on the camera, remove its lens cap.
2. Align the exposure mode dial with **A** (Full Auto Mode).
3. Align the drive mode dial with  (1-Image).
4. Align the power/function switch with .

-  : Turns on power and enters the REC mode.
-  : Turns on power and enters the PLAY mode.
- OFF : Turns off power.



5. Compose the image as you view it on the monitor screen.

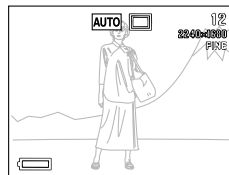

- If you prefer to use the optical viewfinder to compose the image, press DISP to turn off the monitor screen.

6. Press the shutter release button about half way and hold it there to perform auto focus.

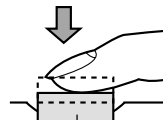

Shutter release button

- Pressing the shutter release button causes the focus frame to appear on the monitor screen (page E-62).
- Multi-area Auto Focus (page E-62) automatically focuses the image and displays shutter speed and aperture values.

- You can find out the status of the Auto Focus operation by checking the color of the focus frame and the status of the operation/card access lamp.

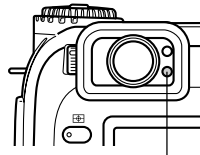

Operation/card access lamp

| If you see this: | It means this: |
|-----------------------------------|----------------------------|
| Focus frame: Green | The image is in focus. |
| Operation/card access lamp: Green | |
| Focus frame: Red | The image is not in focus. |
| Operation/card access lamp: Red | |

- Take care that you do not block the lens or the sensors with your fingers as you hold the camera.



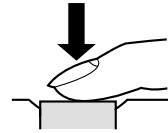

- After confirming that the image is in focus, press the shutter release button all the way down to record the image.



- Recorded images are temporarily stored in a buffer from which they are stored to the memory card. You can continue to shoot consecutive images as long as there is space available in the buffer.
- The number of images you can store in the camera depends on the storage medium and the image quality setting (page E-94) you are using.
- To avoid hand movement, press the shutter release button gently.

IMPORTANT!

- In any of the following cases, the message “One moment please...” appears on the display after you record each image as it is saved to the memory card.
 - When you are recording TIFF (uncompressed) images (page E-95)
 - When you are recording a movie or panorama (pages E-91, 93)
 - When you are recording using certain Best Shot scene setups (page E-76)
 - When the  low battery indicator is on the display while you are using a CompactFlash card (page E-33)
 - When the  low battery indicator is on the display while you are using an IBM Microdrive (page E-33).
- Recording images in the Full Auto Mode causes a number of camera settings to be made automatically in accordance with shooting conditions. See “Full Auto Mode Settings” on page E-154 for more information.

Recording Precautions

- Never remove the camera's batteries, disconnect the AC adaptor, or remove the memory card from the camera while it is saving images to its memory card. Doing so not only causes a loss of the image being saved, it can also corrupt images already stored on the memory card.
- Fluorescent lighting actually flickers at a frequency that cannot be detected by the human eye. When using the camera indoors under such lighting, you may experience some brightness or color problems with recorded images.

Focusing

The Full Auto Mode uses Multi-area AF, which measures three distances and automatically focuses on the subject nearest to the camera. Note that the focusing range is approximately 30 cm to ∞.

IMPORTANT!

- You cannot select a different focusing method when using the Full Auto Mode (Page E-61).

About Auto Focus

Auto Focus tends not to work well with the types of subjects listed below.

- Solid color walls or objects with little contrast
- Strongly backlit objects
- Polished metal or other brightly reflective objects
- Venetian blinds or other horizontally repeating patterns
- Multiple images that are varying distances from the camera
- Subjects in poorly lit areas
- Moving subjects

Auto Focus also may not work properly when the camera is unsteady or shaking.

■ Fixed Focusing Distances

- Depending on actual conditions, a green operation/card access lamp and focus frame do not necessarily guarantee that the image is in focus.

Image Recording when the Batteries are Low

To protect against unexpected loss of image data, each image is recorded directly to the memory card (without going into the buffer) whenever battery level is indicated as  or lower. The message “ **DISP** Press to cancel save” appears on the monitor screen during the save operation under this condition. As long as you do not press DISP, the save operation continues and takes a few seconds to complete. Pressing DISP while the “ **DISP** Press to cancel save” is on the monitor screen cancels the image save operation.





- If you have a Microdrive loaded in the camera, the above message appears whenever the battery level is indicated as  or lower.
- The message “ **DISP** Press to cancel save” also appears momentarily during save operations in the Panorama Mode, Movie Mode, and when you are using certain Best Shot scene setups. In this case, this message does not indicate that battery power is low.
- The message described above does not appear while the monitor screen is turned off.

About the REC Mode Monitor Screen

- The actual image is recorded and saved in accordance with the image quality setting currently selected on your camera. The image recorded on the memory card has much better resolution and detail than the REC mode monitor screen image.
- Certain levels of subject brightness can cause the response of the REC mode monitor screen to slow down, which causes some static noise in the monitor screen image.

Using Optical Zoom

Optical zoom enlarges the image by changing the focal distance of the lens. You can zoom an image by a zoom factor ranging from 1 (normal size) to 3 (three times normal size).

1. Align the power/function switch with .
2. Push the zoom controller upwards towards  (telephoto)  to zoom in on the subject, or downwards towards  (wide-angle)  to zoom out.

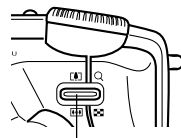

Zoom controller



 (telephoto)

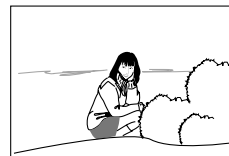

 (wide-angle)

NOTES

- Changing the optical zoom factor also affects the lens aperture value.
- The lens aperture value indicated on the camera is the aperture when optical zoom is 1X. Using a higher optical zoom setting results in a higher aperture value (smaller aperture).
- Use of a tripod is recommended for telephoto shots to avoid blurring of the image due to camera movement.

Using the Viewfinder for Recording

The illustrations below show what you see when you look through the viewfinder to compose an image for recording.

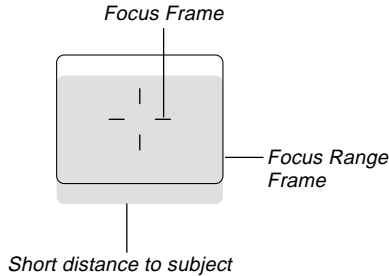

Note that the focus range frame is valid for subjects that are about three meters away. A different focus range is used for subjects that are closer or farther away. Because of this, you should change to the Manual Focus Mode (MF) or Macro Mode (👉) whenever the distance between the camera and the subject is 30cm or less (pages E-64, 65).

- The monitor screen turns on automatically whenever the camera is in the Manual Focus Mode or Macro Mode. Use the monitor screen to compose images in the Manual Focus Mode or Macro Mode.

- You can use the Diopter Dial to adjust the image in viewfinder screen to your eyesight.

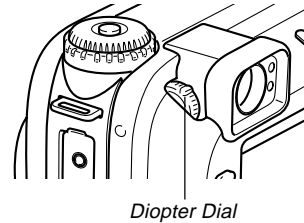



IMPORTANT!

- Focusing of the viewfinder image is disabled while the camera is turned off or in the PLAY mode.

Using the Self-timer

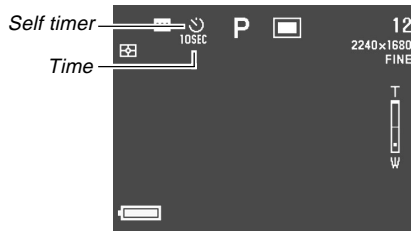
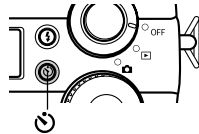

You can set the self-timer to either one of two starting times.

1. Align the power/function switch with .
2. Press  to select the self-timer time you want.



Self-timer Time Settings:

Each press of  cycles through the available self-timer settings described below.

| To do this: | Select this setting: |
|--|---|
| Turn the self-timer off | No display |
| Record 10 seconds after the shutter release button is pressed |  |
| Record two seconds after the shutter release button is pressed |  |

3. Press the shutter release button to start the self-timer countdown.

- The AF assist light/self-timer lamp flashes as the seconds are counted down. If you have the monitor screen turned on, the seconds are counted down on the screen.
- To stop a countdown part way through, press the shutter release button.

NOTES

- The hand-shake limiter is enabled when you use a slow shutter speed and the two-second self-timer at the same time.
- You cannot use the self-timer in combination with the Continuous Shutter Mode.

Camera Orientation Detection

The camera automatically detects whether it is oriented vertically or horizontally when you record an image, and stores the orientation along with the image data.

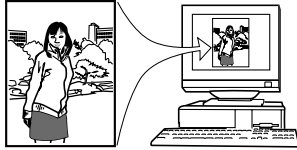

When you display the images on the camera's monitor screen, they are automatically oriented correctly as you recorded them. You can also configure the bundled Photo Loader application (page E-138) so it automatically positions each image using the orientation data stored with it.

IMPORTANT!

- Note that all images are displayed on the camera's monitor screen using standard horizontal orientation during fast scrolling of images, on the 9-image screen, and on all image selection menu screens.
- Note the following precautions to ensure that the sensor built into the camera can correctly detect the orientation of the camera.
 - Make sure you are holding the camera still when recording images. Camera movement can cause sensor errors.

- When recording portrait orientation images, position the camera so it is standing up as straight as possible, as shown in the illustration below. Holding the camera at an angle can cause sensor errors. As a general rule, do not allow the camera to be more than about 20 degrees off of vertical.

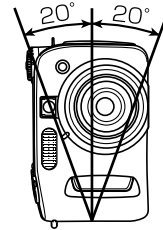

- Tilting the camera too far upwards or downwards can also cause sensor errors. As a general rule, do not allow the camera to point more than about 60 degrees up or down.

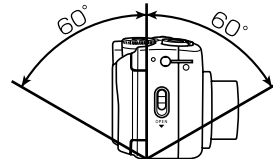

- The camera orientation sensor does not work with movie images.

Free Manuals Download Website

<http://myh66.com>

<http://usermanuals.us>

<http://www.somanuals.com>

<http://www.4manuals.cc>

<http://www.manual-lib.com>

<http://www.404manual.com>

<http://www.luxmanual.com>

<http://aubethermostatmanual.com>

Golf course search by state

<http://golfingnear.com>

Email search by domain

<http://emailbydomain.com>

Auto manuals search

<http://auto.somanuals.com>

TV manuals search

<http://tv.somanuals.com>