

## USER'S GUIDE

### Initial Setup



Preparing a Power Supply



Turning Power On or Off



Using a Pedal



Using Headphones

### Selecting a Tone and Playing



Selecting a Single Tone



Layering Two Tones



Splitting the Keyboard Between Two Tones



Registering and Restoring a Setup (Registration)

### Registering a Setup

### Changing the Pitch

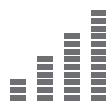

Fine Tuning a Pitch (Tuning)



Changing the Pitch in Octave Units (Octave Shift)



Changing the Scale Tuning (Temperament) of the Keyboard



Linking with a Smart Device (APP Function)

### Connecting with a Smart Device

### Using Effects



Using the Sound Mode Effects (Hall Simulator/Reverb and Surround)



Using a DSP



Using Chorus



Adjusting Acoustic Piano Sound Characteristics (Acoustic Simulator)

### Recording Performances in Real-Time



Using the MIDI Recorder to Record Performances



Using the Audio Recorder to Record Performances

### Using Auto Accompaniment and Auto Arpeggio Play



Using Auto Accompaniment



Using the Arpeggiator

• When the Digital Piano is being operated on battery power only, notes may sound distorted when performing or playing back a song at maximum volume. This is due to the difference between AC adaptor power and battery power, and does not indicate Digital Piano malfunction. If you notice distortion, switch to AC adaptor power or lower the volume level.

### **Included and Optional Accessories**

Use only accessories that are specified for use with this Digital Piano.

Use of unauthorized accessories creates the risk of fire, electric shock, and personal injury.



- You can get information about accessories that are sold separately for this product from the CASIO catalog available from your retailer, and from the CASIO website at the URL or QR code below.

<https://support.casio.com/global/en/emi/manual/PX-S3000/>



- Any reproduction of the contents of this manual, either in part or its entirety, is prohibited. Except for your own, personal use, any other use of the contents of this manual without the consent of CASIO is prohibited under copyright laws.
- IN NO EVENT SHALL CASIO BE LIABLE FOR ANY DAMAGES WHATSOEVER (INCLUDING, WITHOUT LIMITATION, DAMAGES FOR LOSS OF PROFITS, BUSINESS INTERRUPTION, LOSS OF INFORMATION) ARISING OUT OF THE USE OF OR INABILITY TO USE THIS MANUAL OR PRODUCT, EVEN IF CASIO HAS BEEN ADVISED OF THE POSSIBILITY OF SUCH DAMAGES.
- The contents of this manual are subject to change without notice.
- The actual appearance of the product may be different from that shown in the illustrations in this User's Guide.
- Company and product names used in this manual may be registered trademarks of others.

# Contents

<b>Overview and Setup</b>	<b>EN-3</b>
General Guide	EN-3
Preparing a Power Supply	EN-5
Turning Power On or Off	EN-6
Using a Pedal	EN-7
DAMPER PEDAL Jack	EN-7
PEDAL UNIT jack	EN-8
EXPRESSION/ASSIGNABLE Jack	EN-8
Using Headphones	EN-10
<b>Operations Common to All Modes</b>	<b>EN-11</b>
Touch Button Operations	EN-11
FUNCTION Mode Menu Operations	EN-13
Text Character Input	EN-13
<b>Digital Piano Operations</b>	<b>EN-14</b>
Listening to Demo Play	EN-14
Selecting a Tone	EN-14
Selecting a Single Tone	EN-14
Layering Two Tones	EN-15
Splitting the Keyboard Between Two Tones	EN-16
Configuring Layer and Split Settings	EN-17
Adjusting the Overall Volume Level of the Keyboard Performance Parts	EN-18
Changing Keyboard Response to Touch Pressure (Touch Response)	EN-18
Changing the Pitch	EN-19
Changing the Pitch in Semitone Steps (Transpose)	EN-19
Fine Tuning a Pitch (Tuning)	EN-20
Changing the Pitch in Octave Units (Octave Shift)	EN-20
Using the Sound Mode Effects (Hall Simulator/Reverb and Surround)	EN-21
Using a DSP	EN-23
Using Chorus	EN-25
Using Brilliance	EN-25
Adjusting Acoustic Piano Sound Characteristics (Acoustic Simulator)	EN-25
Using the Knobs	EN-26
Using the Pitch Bend Wheel	EN-27
Using the Arpeggiator	EN-27
Splitting the Keyboard for Duet Play	EN-28
Changing the Scale Tuning (Temperament) of the Keyboard	EN-30
Using Auto Accompaniment	EN-30
Selecting a Rhythm	EN-30
Playing Auto Accompaniment	EN-31
Auto Accompaniment Pattern Variations	EN-32
Triggering Auto Accompaniment Play with Accompaniment Keyboard Input (Synchro Start)	EN-33
Using the Keyboard to Control the Auto Accompaniment Pattern (Keyboard Controller Mode)	EN-34
Selecting a Chord Input Mode	EN-34
Using One-Touch Preset	EN-36
Using Auto Harmonize	EN-37
Changing the Auto Accompaniment and Song Tempo	EN-38

Using Music Preset	EN-38
Registering and Restoring a Setup (Registration)	EN-40
Registering and Recalling a Setup	EN-41
Using a Pedal to Cycle Through Multiple Setups (Sequential Pedal Recall)	EN-42
Using the MIDI Recorder to Record Performances	EN-43
Recording and Playing Back Keyboard Play	EN-45
Configuring Recording Settings (Pre-count, Metronome, Beat, Punch-in Measure)	EN-48
Deleting a MIDI Recorder Song	EN-49
Using the Audio Recorder to Record Performances	EN-49
Listening to Songs (MIDI Player)	EN-51
Configuring Function Settings (FUNCTION Mode)	EN-53
Using Operation Lock	EN-59
Configuring MIDI Settings	EN-59
Deleting All Data in Digital Piano Memory	EN-60

## **USB Flash Drive** **EN-60**

Supported USB Flash Drives	EN-60
USB Flash Drive and USB Flash Drive Port Handling Precautions	EN-61
Connecting a USB Flash Drive to and Detaching It from the Digital Piano	EN-61
Formatting a USB Flash Drive	EN-62
USB Flash Drive Operations	EN-62
Using a Computer to Copy General Song Data to a USB Flash Drive	EN-65
Storing Standard Audio Data (WAV Files) to a USB Flash Drive	EN-65

## **Linking with a Smart Device (APP Function)** **EN-65**

## **Troubleshooting** **EN-66**

Error Messages	EN-68
----------------	-------

## **Reference** **EN-69**

Product Specifications	EN-69
Fingering Guide	EN-71
Chord Example List	EN-73
Versatile Tone Map	EN-75
Knob Set List	EN-76
DSP Effect List	EN-77
Preset DSP List	EN-77
DSP Module List	EN-79
DSP Parameter List	EN-80

## **MIDI Implementation Chart**

# Overview and Setup

## General Guide

### ■ Front Panel

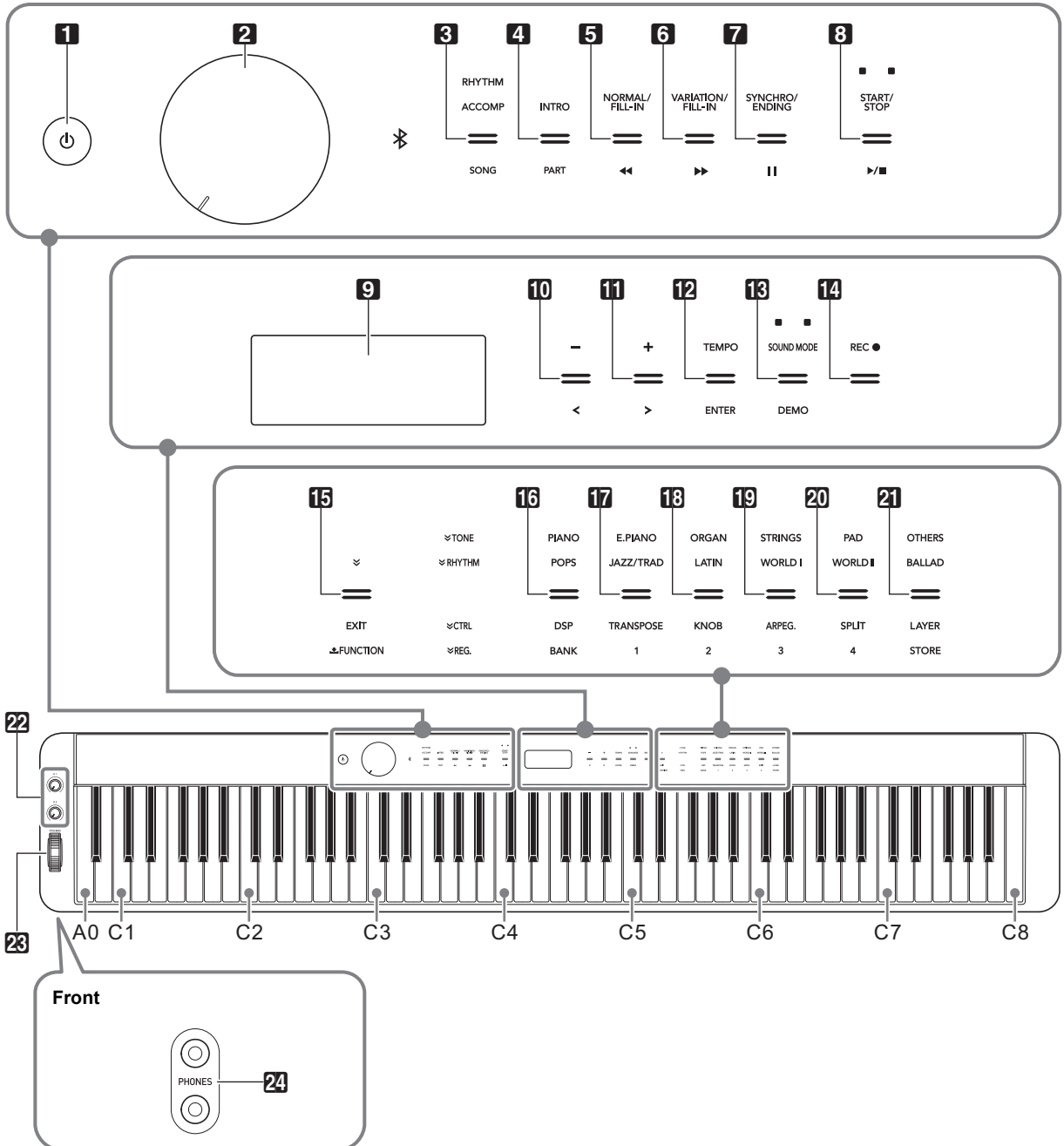

### Touch Buttons

Turning on Digital Piano power causes all of the touch buttons to light, except for the **1** (Power) button. The above illustration shows when all buttons and their text are lit. During actual operation, only the buttons that are currently enabled and the applicable text are lit or flashing.

- 1** ⏻ (Power) button
- 2** Volume knob
- 3** Mode selector button (**RHYTHM, ACCOMP, SONG**)
- 4** **INTRO, PART** button
- 5** **NORMAL/FILL-IN**, ◀◀ button
- 6** **VARIATION/FILL-IN**, ▶▶ button
- 7** **SYNCHRO/ENDING**, || button
- 8** **START/STOP**, ▶/■ button
- 9** Display
- 10** -, < button
- 11** +, > button
- 12** **TEMPO, ENTER** button
- 13** **SOUND MODE, DEMO** button
- 14** **REC** ● button

- 15** ∇, **EXIT**, ⏴ **FUNCTION** button
- 16 - 21** **TONE** category, **RHYTHM** category buttons
- 16** **DSP, BANK** button
- 17** **TRANSPOSE**, Area **1** button
- 18** **KNOB**, Area **2** button
- 19** **ARPEG.**, Area **3** button
- 20** **SPLIT**, Area **4** button
- 21** **LAYER, STORE** button
- 22** Knob (**K1**), Knob (**K2**)
- 23** **PITCH BEND** wheel
- 24** **PHONES** jacks

■ Back

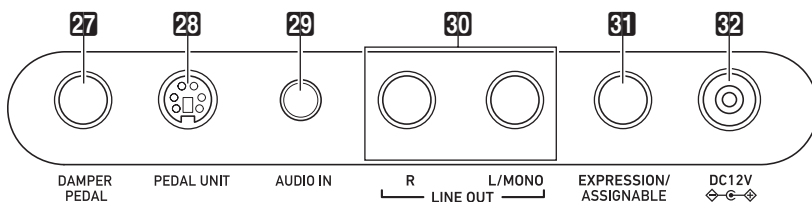
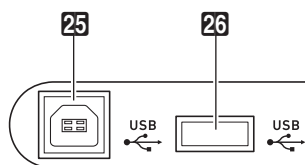

- 25** **USB** port
- 26** **USB** flash drive port
- 27** **DAMPER PEDAL** jack
- 28** **PEDAL UNIT** jack
- 29** **AUDIO IN** jack
- 30** **LINE OUT R, L/MONO** jacks
- 31** **EXPRESSION/ASSIGNABLE** jack
- 32** **DC 12V** terminal

■ Preparing the Music Stand

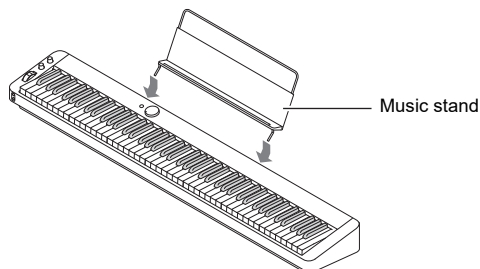

## Preparing a Power Supply

Your Digital Piano uses an AC adaptor for power.

### NOTE

- Though this Digital Piano supports battery operation, use of an AC adaptor is generally recommended.

### Using the AC Adaptor

Make sure that you use only the AC adaptor specified for this Digital Piano. Use of a different type of AC adaptor can cause malfunction.

**Specified AC Adaptor: AD-A12150LW**  
(JEITA Standard plug)

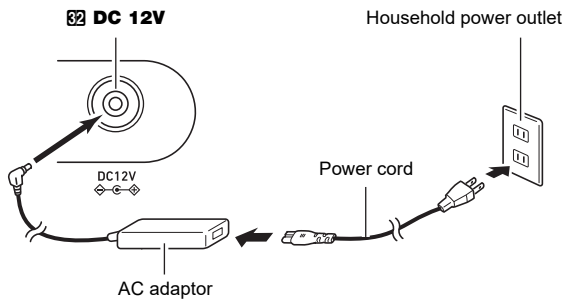

### IMPORTANT!

- Never connect the AC adaptor (JEITA Standard, with unified polarity plug) that comes with this Digital Piano to any other device besides this Digital Piano. Doing so creates the risk of malfunction.
- Be sure to turn off Digital Piano power before connecting or disconnecting the AC adaptor.
- The AC adaptor will become warm to the touch after very long use. This is normal and does not indicate malfunction.

### Using Batteries

### IMPORTANT!

- Be sure to turn off power before loading batteries.
- It is up to you to prepare six commercially available alkaline batteries.
- Note the following precautions while the Digital Piano is turned upside down to load batteries.
  - Take care to avoid injury due to pinching your fingers under the Digital Piano.
  - Do not allow the Digital Piano to tip over or otherwise be subjected to strong impact. Impact can damage the volume knob and keyboard keys.

1. Open the battery cover on the bottom of the Digital Piano.
2. Load six AA-size batteries into the battery compartment.  
Make sure the positive ⊕ and negative ⊖ ends of the batteries are facing as marked on the Digital Piano.
3. Insert the tabs of the battery cover into the holes on the side of the battery compartment, and close the cover.

### Low Battery Indication

The message "LOW BATTERY" appears on the display when battery power goes low. When this happens, replace the batteries.

### IMPORTANT!

- Using the Digital Piano while batteries are very low can cause it to turn off suddenly. This can cause data stored in Digital Piano memory to be corrupted or lost.

## Turning Power On or Off

1. Before turning on power, rotate the **2** volume knob as far as it will go in the direction shown in the illustration below.

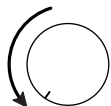

2. Press the **1** ⏻ (Power) button to turn on power.

The message “Welcome” will appear momentarily, followed by the tone name display. This indicates that the Digital Piano is ready for use.

- After pressing **1** ⏻ (Power) to turn on power, do not press any pedal until the Digital Piano is ready to play (the tone name display appears).
- Power may not turn on if you press the **1** ⏻ (Power) button too lightly. This does not indicate malfunction. If this happens, apply more pressure when you press the **1** ⏻ (Power) button.

3. Use the **2** volume knob to adjust volume.

4. To turn off power, hold down the **1** ⏻ (Power) button until “Bye” appears on the display.

### NOTE

- Pressing the **1** ⏻ (Power) button to turn off power actually puts the Digital Piano into a standby state. Minute amounts of current continue to flow within the Digital Piano in the standby state. If you do not plan to use the Digital Piano for a long time or if there is a lightning storm in your area, be sure to unplug the AC adaptor from the power outlet.
- Turning off power normally causes the tone number and other settings to return to their initial defaults. You can enable Auto Resume, which will save most settings when power is turned off.
- If Auto Resume is disabled, turning off power will initialize settings, except for those below.  
Tuning, LCD contrast, pairing information (Bluetooth connection logs), expression/assignable pedal type, expression/assignable pedal calibration, touch button sensitivity

### Power On Alert

After about six minutes of non-operation while the Digital Piano is being powered by its AC adaptor, the Power On Alert function will cause touch button lights to turn on and off sequentially to remind you that power is on.

Button lights will return to normal if you touch a button, play something on the keyboard, or perform some other operation. To turn off power, hold down the **1** ⏻ (Power) button until “Bye” appears on the display.

### NOTE

- Use FUNCTION parameter **107** (“Power On Alert”) to enable or disable Power On Alert. For information about FUNCTION parameters, see “Configuring Function Settings (FUNCTION Mode)” (page EN-53).
- If you are using batteries to power the Digital Piano, power will turn off automatically after about six minutes of non-use. See “Auto Power Off” (page EN-6).

### Adjusting Display Contrast

Use FUNCTION parameter **109** (“LCD Contrast”) to adjust display contrast. For information about FUNCTION parameters, see “Configuring Function Settings (FUNCTION Mode)” (page EN-53).

### Operation Lock

Operation lock can be used to prevent operational errors during performances by disabling button operations. For details, see “Using Operation Lock” (page EN-59).

### Returning to Initial Factory Defaults

You can use Factory Reset to return the Digital Piano’s stored data and settings to their initial factory defaults any time you want. For more information, see “To return all Digital Piano settings and data to their initial factory defaults (Factory Reset)” (page EN-60).

### Auto Power Off

This Digital Piano is designed to turn off automatically to avoid wasting power after no operation is performed for a preset amount of time. The Auto Power Off trigger time is about four hours when power is being supplied by the AC adaptor, or six minutes under battery power.

### NOTE

- You can disable Auto Power Off to ensure that power does not turn off automatically during a concert, etc. To disable Auto Power Off, select “Off” for FUNCTION parameter **106** (“Auto Power Off”). For information about FUNCTION parameters, see “Configuring Function Settings (FUNCTION Mode)” (page EN-53).

## Using a Pedal

Your Digital Piano has three jacks for connection of pedals.

Jack	Connectable Pedal
<b>27 DAMPER PEDAL</b>	Switch type pedal*1
<b>28 PEDAL UNIT</b>	Separately available SP-34 pedal unit (three pedals: damper, soft, and sostenuto).
<b>31 EXPRESSION/ASSIGNABLE</b>	Switch type pedal,*1 expression pedal*2

\*1 Included pedal (SP-3) or separately available CASIO sustain pedal.

\*2 See “[To specify the pedal type](#)” (page EN-9).

### NOTE

- Pedals connected to the **27 DAMPER PEDAL** jack, **31 EXPRESSION/ASSIGNABLE** jack, and **28 PEDAL UNIT** jack can be used simultaneously.
- You can also use a pedal to switch the Digital Piano registration setup. For details, see “[Using a Pedal to Cycle Through Multiple Setups \(Sequential Pedal Recall\)](#)” (page EN-42).

## DAMPER PEDAL Jack

Connect the supplied pedal (SP-3) to the **27 DAMPER PEDAL** jack.

Back

**27 DAMPER PEDAL** jack (Standard jack (6.3mm))

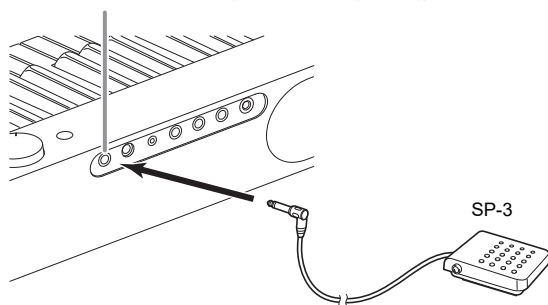

## ■ To change the function of the pedal connected to the DAMPER PEDAL jack

You can use FUNCTION parameter **36** (“Pedal Target”) to select one of the settings below.

This setting (displayed):	Does this:
Sustain	Sustains notes played while the pedal is depressed, even if the keyboard key is subsequently released. Organ and other tones that are sustained as long as keyboard key are depressed continue to sound as long as the pedal is depressed.
Sostenuto	Sustains only the notes of the keys that are depressed when the pedal is pressed until the pedal is released, even if the keyboard keys are released first.
Soft	Slightly lowers and softens notes played while the pedal is depressed.
Arpeggio Hold	When the arpeggiator (page EN-27) is enabled, applies arpeggio hold while the pedal is depressed.
Play/Stop	Performs the same operations as the <b>8 ▶/■</b> button.
Fill-in	Plays a fill-in when the pedal is depressed while an Auto Accompaniment is playing.

- For information about FUNCTION parameters, see “[Configuring Function Settings \(FUNCTION Mode\)](#)” (page EN-53).



## PEDAL UNIT jack

Use the **23** **PEDAL UNIT** jack to connect a separately available Pedal Unit (SP-34). You can then use the pedals for expression that is similar to that available on an acoustic piano.

### ■ SP-34 Pedal Functions

#### ● Damper Pedal

Pressing the damper pedal while playing will cause the notes you play to reverberate. The SP-34 pedal also supports half-pedal operation, so pressing the pedal part way applies only a partial damper effect.

#### ● Soft Pedal

Pressing this pedal suppresses notes played on the keyboard after the pedal was pressed, and makes them sound softer.

#### ● Sostenuto Pedal

Only the notes of the keys that are depressed when this pedal is pressed are sustained, even if the keyboard keys are released, until the pedal is released.

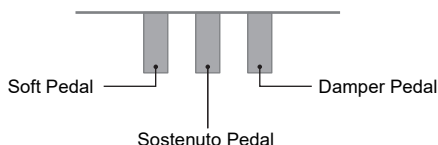

## EXPRESSION/ASSIGNABLE Jack

Use the **31** **EXPRESSION/ASSIGNABLE** jack to connect a commercially available expression pedal or a CASIO sustain pedal (included SP-3 or separately available pedal). Perform one of the operations below depending on the pedal that is being connected.

For this type of pedal:	Perform this operation:
Switch type pedal	<ol style="list-style-type: none"> <li>(1) Use the procedure under “<a href="#">To specify the pedal type</a>” (page <a href="#">EN-9</a>) to select “SW”.</li> <li>(2) Use the procedure under “<a href="#">To specify the pedal function</a>” (page <a href="#">EN-9</a>) to select a switch type pedal setting.</li> </ol>
Expression pedal	<ol style="list-style-type: none"> <li>(1) Use the procedure under “<a href="#">To specify the pedal type</a>” (page <a href="#">EN-9</a>) to select a polarity type that matches the pedal being connected.</li> <li>(2) Use the procedure under “<a href="#">To specify the pedal function</a>” (page <a href="#">EN-9</a>) to select an expression pedal setting.</li> <li>(3) Perform the procedure under “<a href="#">Expression Pedal Calibration</a>” (page <a href="#">EN-10</a>).</li> </ol>

### ■ Connectable Expression Pedals

- Maximum resistance value: 10kΩ±20% to 50kΩ±20%
- Use of a pedal whose operation has been confirmed (see below) is recommended.

#### Operation Confirmed Pedals (Polarity Type 2)



Roland EV-5 (Set minimum volume to 0.)

KURZWEIL CC-1

FATAR VP-25, VP-26

### ■ To specify the pedal type

You can use FUNCTION parameter 41 (“Pedal Type”) to select one of the settings below.

Select this setting (displayed setting name):	To connect this type of pedal:
SW	Switch type pedal (CASIO sustain pedal)
Exp.Type1	Polarity Type 1 (see the illustration below) expression pedal 
Exp.Type2	Polarity Type 2 (see the illustration below) expression pedal 

- Note that the expression pedal polarity type depends on the manufacturer. When connecting an expression pedal, select “Exp.Type1” or “Exp.Type2” in accordance with its polarity type.
- For information about FUNCTION parameters, see “Configuring Function Settings (FUNCTION Mode)” (page EN-53).

### ■ To specify the pedal function

You can use FUNCTION parameter 42 (“Pedal Target”) to select one of the settings below. The settings from “Expression” to “Layer Balance” are expression pedal settings, while the settings from “Sustain” to “Fill-in” are switch type (CASIO sustain) pedal settings.

Select this setting (displayed setting name):	To assign this function to the pedal:
Expression	Expression (MIDI Control Change 11) control
Master Volume	Overall Digital Piano volume level control
Tempo	Tempo control
Layer Balance	Upper1 part and Upper2 part volume level balance control
Sustain	Same as “Sustain” to “Fill-in” under “To change the function of the pedal connected to the DAMPER PEDAL jack” (page EN-7).
Sostenuto	
Soft	
Arpeggio Hold	
Play/Stop	
Fill-in	

- For information about FUNCTION parameters, see “Configuring Function Settings (FUNCTION Mode)” (page EN-53).

## ■ Expression Pedal Calibration

When connecting an expression pedal to the **[F1] EXPRESSION/ASSIGNABLE** jack for the first time, perform the calibration operation below.

1. Connect an expression pedal to the **[F1] EXPRESSION/ASSIGNABLE** jack.
2. Hold down the **[F3] ∇** button until “[FUNCTION]” appears on the display.  
This enters the FUNCTION Mode.
3. Use the **[F10] <** and **[F11] >** buttons to display “PEDAL/WHEEL” and then touch **[F12] ENTER**.
4. Use the **[F10] <** and **[F11] >** buttons to display “EXP/ASGN PEDAL” and then touch **[F12] ENTER**.
5. Use the **[F10] <** and **[F11] >** buttons to display “Exp Calibration” and then touch **[F12] ENTER**.  
This displays “Sure?”. If you want to cancel the operation at this point, touch **[F10] -** here.
6. Touch **[F11] +** to start adjustment.
7. While “Highest” is displayed, press the top of the pedal down as far as it will go and then touch **[F12] ENTER**.
8. While “Lowest” is displayed, press the bottom of the pedal down as far as it will go and then touch **[F12] ENTER**.  
The message “Complete” will appear when the operation is complete.
9. To exit the FUNCTION mode, hold down **[F15] EXIT** until “[FUNCTION]” disappears from the display.

## Using Headphones

Using headphones cuts off output from the built-in speakers, which means you can practice playing even late at night without disturbing others.

- Be sure to turn down the volume level before connecting headphones.

**[F24] PHONES** jacks (Stereo mini jack (3.5mm))

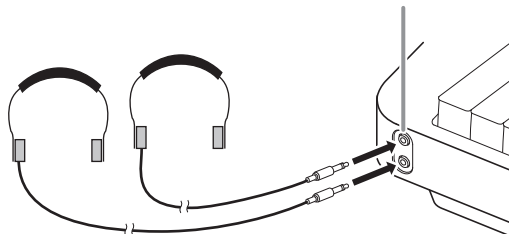

### NOTE

- Headphones do not come with the Digital Piano.
- Use commercially available headphones. See page [EN-1](#) for information about options.

### ! IMPORTANT!

- Do not listen to very high volume output over headphones for long period. Doing so creates the risk of hearing damage.
- If you are using headphones that require an adaptor plug, make sure you do not leave the adaptor plugged in when you unplug the headphones. If you do, nothing will sound from the speakers when you play.

### ■ To output from the speakers while headphones are connected

While FUNCTION parameter [104](#) (“Speaker Out”) is enabled (“On”), sound will be output from the speakers even if headphones are connected to the PHONES jack. For information about FUNCTION parameters, see “[Configuring Function Settings \(FUNCTION Mode\)](#)” (page [EN-53](#)).



### ■ Mode Selector Button

Your Digital Piano has three modes, which are described below.

**RHYTHM Mode:** This is the mode for most basic operations. In addition to normal keyboard play use this mode to perform most other Digital Piano operations.

**ACCOMP Mode:** This mode is for playing Auto Accompaniment with chords. See “Using Auto Accompaniment” (page EN-30).

**SONG Mode:** Use this mode to play back songs. See “Listening to Songs (MIDI Player)” (page EN-51).

Touch the **3** mode selector button to cycle between the three modes.

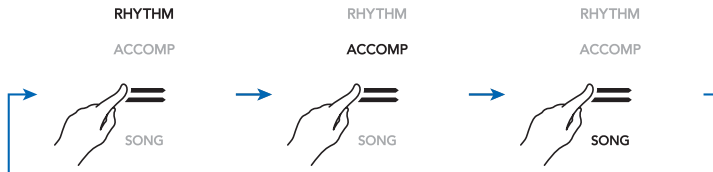

An indicator above or below the mode selector button will light to indicate the currently selected mode. Other mode names are not displayed.

### ■ ∨ Button

You can use the **15** ∨ button to cycle between four different function types for the six buttons (**16** to **21**) on the right side of the Digital Piano’s front panel.

Touch **15** ∨ to cycle between the different function types. An indicator to the right of the **15** ∨ button will light to indicate the currently selected function type.

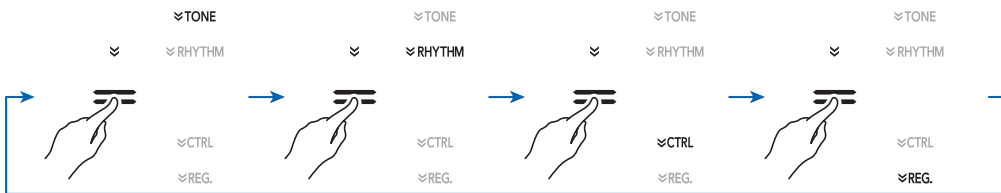

While this function name is lit:	Buttons <b>16</b> through <b>21</b> perform these operations:
TONE	Tone category selection (page EN-14)
RHYTHM	Rhythm category selection (page EN-30)
CTRL	DSP selection (page EN-23), transpose setting changes (page EN-19), knob set selection (page EN-26), arpeggiator (page EN-27) /auto harmonize (page EN-37) setting change, split and layer setting changes (page EN-17)
REG.	Registration operations (page EN-40)

**Example:** Buttons **16** to **21** are configured as shown below when “CTRL” is selected (lit).

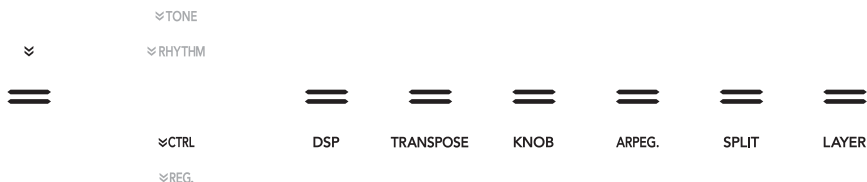

### ■ Touch Button Light Auto Off

To save power, you can configure a setting that will turn off all button lights, except for the **3** mode selector button, after a certain period of non-operation. Use FUNCTION parameter 102 ("Panel Light") to specify the amount of non-operation time (in seconds) until lights turn off, or you can specify that lights should remain lit (initial default). For information about FUNCTION parameters, see "Configuring Function Settings (FUNCTION Mode)" (page EN-53).

#### NOTE

- To turn the touch button lights back on, touch the **3** Mode selector button.
- Turning on the Digital Piano under battery power only (without AC adaptor power) will cause the Panel Light Setting to change automatically to 60 seconds to conserve power. You can change the Panel Light Setting if you want.
- Turning off the Digital Piano, connecting the AC adaptor, and turning power back on will automatically cause "Off" to be selected for the Panel Light Setting (if Auto Resume is disabled).

## FUNCTION Mode Menu Operations

You can use the FUNCTION Mode menu to perform a wide range of Digital Piano setting operations. The example below explains how the selection of setting menu items (parameters) is presented in this manual.

#### Example:

1. Hold down the **F5**  $\nabla$  button until "[FUNCTION]" appears on the display.

This enters the FUNCTION Mode.



2. Use the **F10** < and **F11** > buttons to select the following menu items in sequence:  
"KEYBOARD" → "Touch Response".



The actual operations performed in step 2 are those below.

- 2-1. Use the **F10** < and **F11** > buttons to display "KEYBOARD" and then touch **F12** ENTER.
- 2-2. Use the **F10** < and **F11** > buttons to display "Touch Response" and then touch **F12** ENTER.

For details about the FUNCTION Menu configuration and operations, see "Configuring Function Settings (FUNCTION Mode)" (page EN-53).

#### NOTE

- You can exit the FUNCTION Mode at any time by holding down **F5** EXIT until "[FUNCTION]" disappears from the display.

## Text Character Input

Use the procedure below when you need to change the name of data saved on a USB flash drive or to input other text.

### ■ To change a character

1. Use the **F10** < and **F11** > buttons to move the cursor to the position of the character you want to change, and then touch **F12** ENTER.  
This enters the character editing mode.
2. Use the **F10** - and **F11** + buttons, or **22** (K1) knob to change the currently selected character.
3. To apply your edit, touch **F12** ENTER.  
This exits the character editing mode.

## ■ To insert a character

1. Use the **[10] <** and **[11] >** buttons to move the cursor to the position where you want to insert a character.

2. Touch **[18] Area 2**.

This inserts "A" at the cursor position and enters the character editing mode.

- At this time you can change the "A" to a different character if you want. To do so, perform the procedure under "To change a character" from step 2.

## ■ To delete a character

1. Use the **[10] <** and **[11] >** buttons to move the cursor to the position of the character you want to delete.

2. Touch **[17] Area 1**.

## ■ To save edited text

1. Touch **[21] STORE**.

## ■ Supported Input Characters

Input of the characters shown in the table below is supported when saving a file to a USB flash drive.

	!	#	\$	%	&	'	(	)	+	,	-	.
0	1	2	3	4	5	6	7	8	9	;	=	@
A	B	C	D	E	F	G	H	I	J	K	L	M
N	O	P	Q	R	S	T	U	V	W	X	Y	Z
[	]	^	_	`	a	b	c	d	e	f	g	h
i	j	k	l	m	n	o	p	q	r	s	t	u
v	w	x	y	z	{	}	~					

- When saving a file to a USB flash drive, you will be able to use up to 231 characters for a file name.
- If you use this procedure to edit the file name of a file on a FAT32 formatted USB flash drive, you will not be able to input some of the characters shown above.

# Digital Piano Operations

## Listening to Demo Play

You can use the procedure below to play back the six built-in demo songs in sequence.

1. Hold down the **[15] √** button until "DEMO" under the **[18] DEMO** button starts to flash.

2. Touch **[18] DEMO**.

This causes the **[18] DEMO** button light and "DEMO" indicator to turn off, which indicates demo play standby. At this time, the display will show "1: Demo Song".

- You can also use the **[10] -** and **[11] +** buttons to switch between songs. This operation can be performed while playback is in progress.

3. To start demo play, touch **[8] ▶/■** or **[12] ENTER**.

- After this, you can pause and resume demo play by touching **[8] ▶/■** or **[12] ENTER**.

4. To exit demo play standby, touch **[15] EXIT**.

### NOTE

- If Auto Power Off (page EN-6) is enabled, power will turn off automatically at the applicable trigger time after a period of non-use, even if demo play is being performed.

## Selecting a Tone

Your Digital Piano comes with a large collection of tones. You can select a tone and play it on the keyboard.

### Selecting a Single Tone

#### ■ Tone Categories

The tones of your Digital Piano are divided among six categories, which you can access using TONE category buttons **[16]** through **[21]**. Each of the six categories is divided further into sub-categories, and touching the TONE category button for a particular category will cycle in sequence between its sub-categories.

For details about tone categories and sub-categories, and the names of tones included in each sub-category, refer to the separate "Built-in Music Data Lists".

## ■ To select a tone

1. Use the **[15] √** button to cycle through settings until the “**√TONE**” indicator to the right of the button is lit.

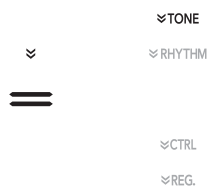

The currently selected tone category name and tone name will be shown on the display.

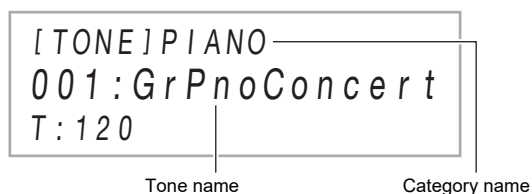

2. Use **TONE** category buttons **[16]** through **[21]** to select a tone category.

- Touching one of the TONE category buttons switches to the tone that was selected the last time that tone category was exited.
- Each touch of the TONE category button of the currently selected tone category will cycle to the next sub-category of that category.

3. Use the **[10] -** and **[11] +** buttons to select a tone.
  - To jump to the first tone in the current category, touch **[10] -** and **[11] +** at the same time.

## ■ Guitar Tones

The built-in guitar tones of this Digital Piano include strum noise and other sound effects that are applied in accordance with the pitch (note number) and/or intensity (velocity) of the notes being played.

## ■ Versatile Tones

The Digital Piano's built-in tones include "versatile tones" (three guitar tones, two bass tones, and two brass tones) that can be used for creating computer music. Versatile tones assign performance sounds that are characteristic of a particular musical instrument (such as a guitar glissando, fret noise, etc.) to each keyboard key (note) and velocity. For information about the sounds assigned for each versatile tone and velocity, see "[Versatile Tone Map](#)" (page EN-75).

## Layering Two Tones

Layering makes it possible to sound with two different tones at the same time. The tone that is layered onto another tone is the "Upper2 part tone", which in this manual is referred to as the "Upper2 tone". The tone upon which the Upper2 tone is layered is the "Upper1 part tone", which is referred to as the "Upper1 tone".

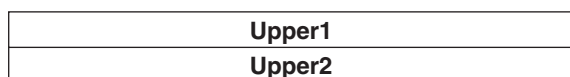

## ■ To layer two tones

1. Use the procedure under "[To select a tone](#)" (page EN-15) to select the Upper1 tone.
2. Use the **[15] √** button to cycle through settings until the “**√CTRL**” indicator to the right of the button is lit.

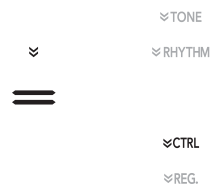

3. Touch **[21] LAYER** to enable the layer function, which is indicated by “**LY**” on the display.
4. Use the **[15] √** button to cycle through settings until the “**√TONE**” indicator to the right of the button is lit. Next, perform the operation under "[To select a tone](#)" (page EN-15) to select the Upper2 tone.

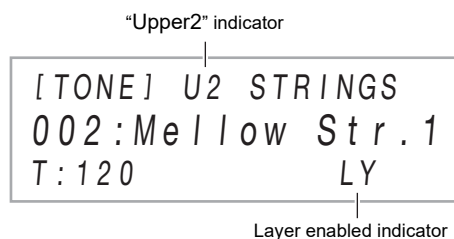

## NOTE

- You can adjust the volume of the Upper1 and Upper2 parts, and configure other part settings. For details, see "[Configuring Layer and Split Settings](#)" (page EN-17).



■ To unlayer the keyboard

1. Use the **[F5] V** button to cycle through settings until the “**V CTRL**” indicator to the right of the button is lit.
2. Touch **[21] LAYER** so the “**LY**” indicator disappears from the display.

**Splitting the Keyboard Between Two Tones**

You can use the lower range and upper range of the keyboard to sound two different tones. When the keyboard is split between a left side and a right side range, the tone assigned to the lower (left side) range is the “Lower part tone”, which is referred to as the “Lower tone” in this manual. The tone assigned to the upper (right side) range is called the “Upper1 tone” or “Upper2 tone” (when the keyboard is layered with the Upper2 tone).



Under initial default settings, the lowest note of the upper range (split point) is at F#3.

■ To split the keyboard between two different tones

1. Use the procedure under “[To select a tone](#)” (page EN-15) to select the upper range (Upper1) tone.
2. Use the **[F5] V** button to cycle through settings until the “**V CTRL**” indicator to the right of the button is lit.

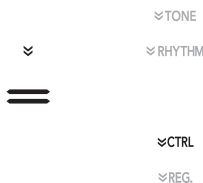

3. Touch **[20] SPLIT** to enable the split function, which is indicated by “**SP**” on the display.

4. Use the **[F5] V** button to cycle through settings until the “**V TONE**” indicator to the right of the button is lit. Next, perform the operation under “[To select a tone](#)” (page EN-15) to select the Lower tone.

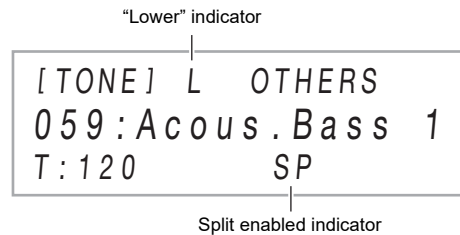

**NOTE**

- To use split and layer at the same time, perform the procedure above and then continue with steps 2 through 4 under “[To layer two tones](#)” (page EN-15).
- You can individually adjust the volumes of the Lower part, Upper1 part and Upper2 part, and configure other part settings. For details, see “[Configuring Layer and Split Settings](#)” (page EN-17).

■ To change the split point

1. Use the **[F5] V** button to cycle through settings until the “**V CTRL**” indicator to the right of the button is lit.
2. Hold down **[20] SPLIT** as you press the keyboard key you want to specify as the lowest note of the upper range (right) keyboard. This makes it the split point.

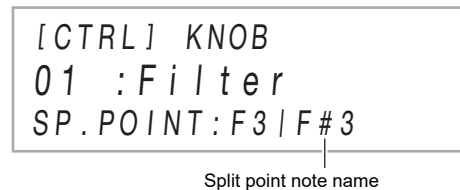

3. Release **[20] SPLIT**. This sets the split point.

## ■ To unsplit the keyboard

1. Use the **F5** **V** button to cycle through settings until the “**V**CTRL” indicator to the right of the button is lit.
2. Touch **F20** **SPLIT** so the “SP” indicator disappears from the display.

## Configuring Layer and Split Settings

You can individually configure volume level, octave shift, and tuning settings for the Upper1, Upper2, and Lower parts. You can also specify whether or not pedal and/or **F23** **PITCH BEND** wheel operations should affect each part.

### ■ To change the volume level, octave shift, and tuning settings of each part

Use FUNCTION parameters **14** (PART VOLUME), **18** (PART OCT SHIFT), and **22** (PART FINE TUNE) to configure each setting. For information about FUNCTION parameters, see “Configuring Function Settings (FUNCTION Mode)” (page EN-53).

Parameter Name (Displayed)	Use this setting (displayed):	To do this:
PART VOLUME → Upper1 Part, Upper2 Part, Lower Part	0 - 127	Adjust the volume level of each part.
PART OCT SHIFT → Upper1 Part, Upper2 Part, Lower Part	-2 - +2	Specify the octave shift amount of each part.
PART FINE TUNE → Upper1 Part, Upper2 Part, Lower Part	-99 - +99	Specify, in 1-cent steps, the pitch of each part.

### ■ To enable or disable pedal operations and pitch bend wheel operations for each part

Use FUNCTION parameters **35** (DAMPER PEDAL), **40** (EXP/ASGN PEDAL), **47** (PEDAL UNIT), and **51** (WHEEL) to configure each setting. For information about FUNCTION parameters, see “Configuring Function Settings (FUNCTION Mode)” (page EN-53).

Parameter Name (Displayed)	Use this setting (displayed):	To do this:
PEDAL UNIT → Upper1 Part, Upper2 Part, Lower Part	On, Off	Specify whether or not the three pedals connected to the <b>F23</b> <b>PEDAL UNIT</b> jack should be applied to each part.
DAMPER PEDAL → Upper1 Part, Upper2 Part, Lower Part	On, Off	Specify whether or not the pedal connected to the <b>F27</b> <b>DAMPER PEDAL</b> jack should be applied to each part.*1
EXP/ASGN PEDAL → Upper1 Part, Upper2 Part, Lower Part	On, Off	Specify whether or not the pedal connected to the <b>F31</b> <b>EXPRESSION/ASSIGNABLE</b> jack should be applied to each part.*2
WHEEL → Upper1 Part, Upper2 Part, Lower Part	On, Off	Specify whether or not the <b>F23</b> <b>PITCH BEND</b> wheel effect should be applied to each part.

\*1 The On/Off setting selected here is applied only while the “Sustain”, “Sostenuto”, or “Soft” setting in the table under “To change the function of the pedal connected to the DAMPER PEDAL jack” (page EN-7) is selected. In all other cases, the effect (or function) assigned to the pedal is applied, regardless of what is selected here.

\*2 The On/Off setting selected here is applied only while the “Expression”, “Sustain”, “Sostenuto”, or “Soft” setting in the table under “To specify the pedal type” (page EN-9) is selected. In all other cases, the effect (or function) assigned to the pedal is applied, regardless of what is selected here.

## Adjusting the Overall Volume Level of the Keyboard Performance Parts

The following types of sounds are output by your Digital Piano: keyboard performance,\* auto accompaniments, song playback, and sounds input from an external source. Each of these sounds can be controlled and adjusted individually.

\* Keyboard performance includes all parts: Upper1, Upper2, and Lower.

### ■ To adjust the volume of the keyboard

**1. Hold down the **[F5]** **∇** button until “[FUNCTION]” appears on the display.**

This enters the FUNCTION Mode.

**2. Use the **[F10]** **<** and **[F11]** **>** buttons to select the following menu items in sequence: “KEYBOARD” → “KeyboardVolume”.**



**3. Use the **[F10]** **-** and **[F11]** **+** buttons, or **[K22]** (**K1**) knob to change the setting.**

- You can set the volume within the range of 0 to 127.
- To return to the initial default setting, touch **[F10]** **-** and **[F11]** **+** at the same time.

**4. To exit the FUNCTION mode, hold down **[F5]** **EXIT** until “[FUNCTION]” disappears from the display.**

### **NOTE**

- To adjust volume levels other than the keyboard volume level, use the FUNCTION parameters below.
  - Auto Accompaniment volume: “Accomp Volume” (74)
  - MIDI song volume: “MIDI Volume” (84)
  - Audio song volume: “Audio Volume” (85)
  - External input\* volume: “Audio In Volume” (98)

For information about FUNCTION parameters, see “Configuring Function Settings (FUNCTION Mode)” (page EN-53).

\* Audio input from a Bluetooth connected smart device or an audio device connected to the Digital Piano’s **[K29]** **AUDIO IN** jack.

## Changing Keyboard Response to Touch Pressure (Touch Response)

Touch Response alters tone volume in accordance with keyboard pressure (speed). This provides you some of the same expressivity you get on an acoustic piano.

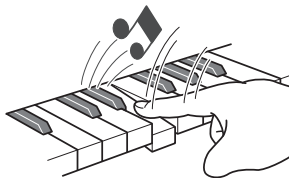

Pressing fast produces louder notes.

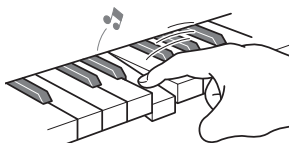

Pressing slowly produces softer notes.

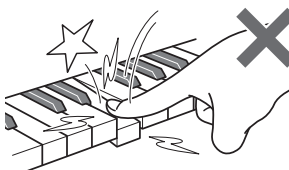

Do not try to use too much pressure.

## ■ To change touch response sensitivity

1. Hold down the **F5**  $\nabla$  button until “[FUNCTION]” appears on the display.

This enters the FUNCTION Mode.

2. Use the **F10**  $<$  and **F11**  $>$  buttons to select the following menu items in sequence: “KEYBOARD” → “Touch Response”.



3. Use the **F10**  $-$  and **F11**  $+$  buttons, or **F22** (K1) knob to change the setting.

This setting (displayed):		Does this:
Disabled (Off)		Disables Touch Response. Sound volume is fixed, regardless of key press speed.
Light	(Light2) ↑ (Light1)	Makes production of a louder sound easier, so touch feels lighter than “Normal”.
Normal	(Normal)	Specifies normal sensitivity.
Heavy	↓ (Heavy1) (Heavy2)	Makes production of a louder sound more difficult, so touch feels heavier than “Normal”.

4. To exit the FUNCTION mode, hold down **F5** **EXIT** until “[FUNCTION]” disappears from the display.

## Changing the Pitch

### Changing the Pitch in Semitone Steps (Transpose)

Transpose lets you raise or lower the overall pitch of the Digital Piano in semitone steps. You can use this feature to raise or lower the keyboard key and to play a piece in a key that is more comfortable for you, or to adjust to a key that better matches a vocalist, etc.

## ■ To change the transpose setting

1. Use the **F5**  $\nabla$  button to cycle through settings until the “ $\nabla$ CTRL” indicator to the right of the button is lit.

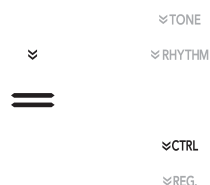

2. Touch **F17** **TRANSPOSE**.

The currently selected transpose setting value will be shown on the display.



3. Use the **F10**  $-$  and **F11**  $+$  buttons to change the setting.
  - You can change the pitch of the keyboard within the range of  $-12$  to  $+12$  semitones.
  - To return to the initial default setting, touch **F10**  $-$  and **F11**  $+$  at the same time.

## Fine Tuning a Pitch (Tuning)

Use the tuning feature when you need to adjust the pitch slightly to play along with another musical instrument.

- The tuning feature specifies the frequency of the A4 note. You can set a frequency within the range of 415.5 to 465.9 Hz. The initial default setting is 440.0 Hz.
- You can change the frequency in 0.1 Hz steps.

### ■ To change the tuning setting

1. Hold down the **[F5] √** button until “[FUNCTION]” appears on the display.

This enters the FUNCTION Mode.

2. Use the **[F10] <** and **[F11] >** buttons to select the following menu items in sequence: “SYSTEM” → “Master Tuning”.

3. Use the **[F10] -** and **[F11] +** buttons, or **[K22] (K1)** knob to change the setting.

- To return to the initial default setting, touch **[F10] -** and **[F11] +** at the same time.

4. To exit the FUNCTION mode, hold down **[F5] EXIT** until “[FUNCTION]” disappears from the display.

## Changing the Pitch in Octave Units (Octave Shift)

You can use the procedure below to raise or lower pitch in octave units. In the explanation here, we will assume that layer and split are not being used, and octave shift the keyboard tone (Upper1 part).

### NOTE

- When layer and/or split is being used, you can specify separate octave shift settings for each part (Upper1, Upper2, Lower). For details about the settings of each part, see “Configuring Layer and Split Settings” (page EN-17).

### ■ To octave shift the Upper1 part

1. Disable both layer and split if they are enabled.
  - See “To unlayer the keyboard” (page EN-16) and “To unsplit the keyboard” (page EN-17).

2. Hold down the **[F5] √** button until “[FUNCTION]” appears on the display.

This enters the FUNCTION Mode.

3. Use the **[F10] <** and **[F11] >** buttons to select the following menu items in sequence: “KEYBOARD” → “PART OCT SHIFT” → “Upper1 Part”.

This displays the Upper1 part octave shift setting screen.

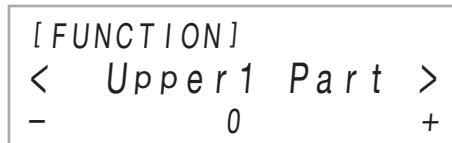

4. Use the **[F10] -** and **[F11] +** buttons, or **[K22] (K1)** knob to change the setting.

- You can shift the octave within the range of -2 to +2.
- To return to the initial default setting, touch **[F10] -** and **[F11] +** at the same time.

5. To exit the FUNCTION mode, hold down **[F5] EXIT** until “[FUNCTION]” disappears from the display.

## Using the Sound Mode Effects (Hall Simulator/Reverb and Surround)

You can use **[F3] SOUND MODE** to enable and disable the effects described below.

### ● Hall Simulator/Reverb

Hall Simulator and Reverb are both effects that change the reverberation of the sound.

<b>Hall Simulator</b>	The hall simulator effect simulates the rich clarity, unconstrained brilliance, and other distinctive acoustic characteristics of world-famous concert halls and structures.
<b>Reverb</b>	Reverb simulates ambient spaces, such as a room or hall.

### ● Surround

The Surround effect creates acoustics that make the sound from the speakers seem like it is coming from multiple directions (virtual surround). This effect is great when outputting audio from an external source\* through the Digital Piano's speakers.

\* Audio input from a Bluetooth connected smart device or an audio device connected to the Digital Piano's **[F29] AUDIO IN** jack.

### NOTE

- The initial power on default setting is Hall Simulator/reverb enabled and Surround disabled.
- The Surround effect is not applied to the output from the Digital Piano's **[F24] PHONES** jacks or **[F30] LINE OUT R, L/ MONO** jacks.

### ■ To enable or disable the Hall Simulator/Reverb and Surround effects

#### 1. Touch **[F3] SOUND MODE**.

- Each touch will cycle between the settings, and the current setting is indicated by the LED lights as shown below.

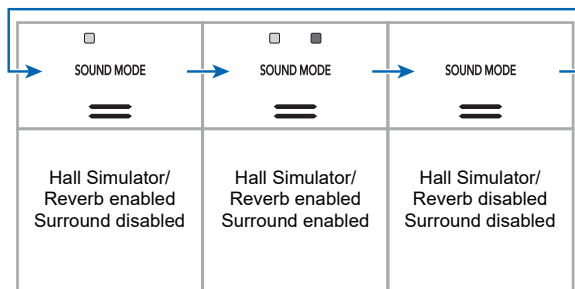

### ■ To specify the Hall Simulator/Reverb type

#### 1. Hold down **[F3] SOUND MODE** until “[SOUND MODE]” appears on the display, and then release the button.

```
[SOUND MODE]
< Hall/Rev.Type >
```

#### 2. After confirming that “Hall/Rev. Type” is displayed, touch **[F12] ENTER**.

The name of the currently selected Hall Simulator/Reverb type will be shown on the display.

#### 3. Use the **[F10] -** and **[F11] +** buttons to select the hall simulator/reverb type.

### ● Hall Simulator

Type (displayed)	Description
N.Y.Club	Manhattan music club
Opera Hall	Uniquely shaped Sydney Concert Hall
Berlin Hall	Berlin arena type classic concert hall
BritishStadium	Large outdoor stadium in the London suburbs

● **Reverb**

Type (displayed)	Description
Room 1	Simulates the reverberation of a room.
Room 2	
Room 3	
Large Room	
Hall 1	Simulates the reverberation of a small hall.
Hall 2	
Hall 3	
Stadium	Simulates the reverberation of a stadium.

- To return to the initial default setting (Hall 3), touch **F10** - and **F11** + at the same time.

4. After the setting is the way you want, touch **F15** **EXIT** as many times as required until “[SOUND MODE]” disappears from the display.

■ **To adjust the depth of the hall simulator/reverb effect**

1. Hold down **F8** **SOUND MODE** until “[SOUND MODE]” appears on the display, and then release the button.
2. Use the **F10** < and **F11** > buttons to display one of the setting items below and then touch **F12** **ENTER**.

With this menu item (displayed):	You can do this:
Hall/Rev. Depth	Adjust the depth of the Hall Simulator and Reverb effects applied to both the Digital Piano’s sound source and externally input audio (Bluetooth input or <b>F29</b> <b>AUDIO IN</b> jack input).
AudioInHallDepth	Adjust the depth of the Hall Simulator and Reverb effects applied to externally input audio (Bluetooth input or <b>F29</b> <b>AUDIO IN</b> jack input) only.

3. Use the **F10** - and **F11** + buttons to change the setting.
  - You can specify a value from 0 to 127. The larger the value, the greater the effect depth.
4. When the setting you want is selected, touch **F15** **EXIT**.
5. Repeat steps 2 through 4 as required.
6. After the setting is the way you want, touch **F15** **EXIT**.

■ **To specify the Surround type**

1. Hold down **F8** **SOUND MODE** until “[SOUND MODE]” appears on the display, and then release the button.
2. Use the **F10** < and **F11** > buttons to display “Surround Type” and then touch **F12** **ENTER**.  
The name of the currently selected surround type will be shown on the display.
3. Use the **F10** - and **F11** + buttons to select the surround type (Type 1 or Type 2).
4. After the setting is the way you want, touch **F15** **EXIT** as many times as required until “[SOUND MODE]” disappears from the display.

## Using a DSP

A DSP (Digital Signal Processor) is a type of effect that is connected between the sound source and output. Included are equalizer, tremolo, limiter, wah, etc. In addition to the default DSPs\*1 assigned to each of the tones, your Digital Piano also offers a selection of 100 preset DSPs\*2 from which to choose. You can also configure DSP parameter settings.

\*1 DSPs that are pre-assigned to each tone based on suitability. Some tones do not have a default DSP assigned.

\*2 DSP in addition to the default DSPs, which can be assigned to any tone.

### ■ To select a DSP

1. Use the procedure under **“To select a tone”** (page EN-15) to select a tone.
2. Use the **[F5] ∨** button to cycle through settings until the **“∨ CTRL”** indicator to the right of the button is lit.

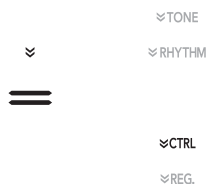

### 3. Touch **[F6] DSP**.

This displays the name of the DSP assigned to the tone you selected (Upper1 tone) in step 1 of this procedure.

- If the current DSP is the default, the word “Tone” will be shown on the display.

```
[CTRL] DSP
000: Tone
T: 120
```

### 4. Use the **[F10] -** and **[F11] +** buttons to select a DSP.

- For the names of all the selectable preset DSPs and their contents (DSP modules), see **“Preset DSP List”** (page EN-77). For information about DSP modules, see **“Configuring DSP Settings”** (page EN-23).
- To return to the initial default DSP, touch **[F10] -** and **[F11] +** at the same time.

### ■ Configuring DSP Settings

The steps below are the general procedure for configuring DSP settings.

- (1) Select the default DSP or preset DSP whose settings you want to configure.
- (2) Select one of the DSP modules in the DSP you selected.
- (3) Configure the settings of the parameters in the DSP module you selected.

#### ● Example: One DSP module: Preset DSP No.1 “Mono 1BandEQ”



#### ● Example: Four DSP modules: Preset DSP No.27 “Re-Amp 1”

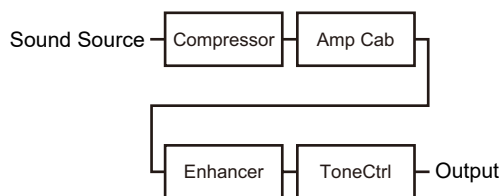

If the DSP whose settings you are configuring consists of four modules and you want to change all of their settings, repeat steps (2) and (3) four times, once for each module. For details on the full procedure, see **“To configure DSP settings”** (page EN-24).

### ! IMPORTANT!

- Note that any changes you make to DSP settings are cleared whenever you turn off Digital Piano power. If you want to retain DSP changes you make, use the registration function (page EN-40) to save the setup so you can recall it later.

### NOTE

- Even if layer and/or split is enabled, the display that appears in step 3 above shows the name of the DSP assigned to Upper1 tone.



■ To configure DSP settings

1. Use the procedure under “To select a DSP” (page EN-23) to select the DSP whose settings you want to configure.

2. Hold down **[F6] DSP** until “[DSP SETTING]” appears on the display.  
This enters the DSP setting mode and displays “DSP On/Off”.



- “DSP On/Off” specifies whether or not a DSP should be applied to a tone. After confirming that “On” is selected for this setting, proceed to step 3. “DSP On/Off” is always “On” if you selected a preset DSP in step 1 of this procedure.
- If you selected a default DSP (indicated by “Tone” on the display), the default setting here is “Off”, which means the DSP is not being applied. If this setting is “Off”, touch **[F6] EXIT** to return to step 1 and select a different tone and/or DSP. Or you can use the steps below to change the “DSP On/Off” setting to “On”. Selecting “On” here will make preset DSP 1 the target of any setting changes you configure.

- (1) After confirming that “DSP On/Off” is displayed, touch **[F2] ENTER**.
- (2) Use the **[F10] -** and **[F11] +** buttons to change the setting to “On”.
- (3) Touch **[F6] EXIT**.

3. Use the **[F10] <** and **[F11] >** buttons to select a DSP module and then touch **[F2] ENTER**.

This displays one of the parameters of the DSP module you selected.



4. Use the **[F10] <** and **[F11] >** buttons to display the parameter whose setting you want to change and then touch **[F2] ENTER**.

This enters the parameter editing mode.



5. Use the **[F10] -** and **[F11] +** buttons to change the parameter setting.

- To return to the initial default parameter setting, touch **[F10] -** and **[F11] +** at the same time.

6. When the setting is the value you want, touch **[F6] EXIT**.

7. Repeat steps 4 through 6 as required. When the settings are the way you want, touch **[F6] EXIT**.

This returns to the DSP module display in step 3 of this procedure.

8. Repeat steps 3 through 7 as required.

9. To exit the DSP setting mode, touch **[F6] EXIT**.

## Using Chorus

Chorus is a function that adds depth and breadth to notes. To select a chorus setting, use FUNCTION parameter 9 (“Chorus Type”) to select one of the settings below.

This setting (displayed):	Chorus Type:
Tone*	Tone
Chorus 1	Chorus 1
Chorus 2	Chorus 2
Chorus 3	Chorus 3
Chorus 4	Chorus 4
FB Chorus	Feedback Chorus
Deep Chorus	Deep Chorus
Flanger 1	Flanger 1
Flanger 2	Flanger 2
Flanger 3	Flanger 3
Flanger 4	Flanger 4
Short Delay 1	Short Delay 1
Short Delay 2	Short Delay 2

\* Specifies the initial setting of each tone.

For information about FUNCTION parameters, see “Configuring Function Settings (FUNCTION Mode)” (page EN-53).

## Using Brilliance

Brilliance can be used to make a sound brighter or mellower. You can use FUNCTION parameter 10 (“Brilliance”) to adjust brilliance within the range of -3 to +3. A setting of +1 or greater gives notes a brighter feel, while -1 or less makes notes sound more mellow. For information about FUNCTION parameters, see “Configuring Function Settings (FUNCTION Mode)” (page EN-53).

## Adjusting Acoustic Piano Sound Characteristics (Acoustic Simulator)

The tones of your Digital Piano have built-in elements that give them the reverberation characteristics of an acoustic piano. You can use the procedure below to adjust the characteristics of notes.

### ■ To adjust acoustic piano sound characteristics

1. Hold down the **[F5] ∇** button until “[FUNCTION]” appears on the display.  
This enters the FUNCTION Mode.
2. Use the **[F10] <** and **[F11] >** buttons to select the following menu items in sequence: “SOUND” → “ACOUSTIC SIMU.”.
3. Use the **[F10] <** and **[F11] >** buttons to display the setting item you want to configure and then touch **[F12] ENTER**.  
  - For more information about setting items and their settings, see the “List of Acoustic Piano Sound Setting Items” (page EN-26).
4. Use the **[F10] -** and **[F11] +** buttons to change the setting.
5. Touch **[F5] EXIT**.
6. Repeat steps 3 through 5 for each of the items whose setting you want to configure.
7. To exit the FUNCTION mode, hold down **[F5] EXIT** until “[FUNCTION]” disappears from the display.

■ List of Acoustic Piano Sound Setting Items

Setting (Display)	Available Options
<b>String Resonance (String Reso.)</b> Playing on an acoustic piano causes the strings that are harmonics of the played strings to resonate. You can select one of the string resonance settings in the column to the right.	Tone: Specifies the initial setting of each tone.  Off: Disables String Resonance.  1-4: The greater the value, the stronger the String Resonance.
<b>Damper Resonance (Damper Reso.)</b> Pressing the damper pedal on an acoustic piano opens all 88 of the strings, causing all of the strings that are harmonics of the strings that are played to resonate. You can select one of the damper resonance settings in the column to the right.	Tone: Specifies the initial setting of each tone.  Off: Disables Damper Resonance.  1-4: The greater the value, the stronger the Damper Resonance.
<b>Damper Noise (Damper Noise)</b> Damper noise is a slight metallic ringing sound that is generated as the damper of an acoustic piano separates from the wires pedal when the damper pedal is pressed. You can use the settings in the column to the right to adjust the volume of the damper noise.	Tone: Specifies the initial setting of each tone.  Off: Mutes Damper Noise.  1-4: The greater the value, the greater the noise volume.
<b>Key On Action Noise (Key On Noise)</b> When the keys of an acoustic piano are tapped with extremely light pressure, piano mechanism operation sound (noise) is produced without the hammers reaching the strings. You can use the settings in the column to the right to adjust the volume of the noise.	Tone: Specifies the initial setting of each tone.  Off: Mutes Key On Action Noise.  1-4: The greater the value, the greater the noise volume.
<b>Key Off Action Noise (Key Off Noise)</b> Releasing the keyboard keys of acoustic piano generates piano mechanism operation sound (noise). You can use the settings in the column to the right to adjust the volume of the noise.	Tone: Specifies the initial setting of each tone.  Off: Mutes Key Off Action Noise.  1-4: The greater the value, the greater the noise volume.

Using the Knobs

The digital piano has two knobs that you can use to change the tone, effect, and another parameter settings in real time.

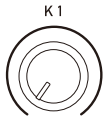

■ To select the functions (knob sets) assigned to the knobs

**NOTE**

- Regardless of the position of **22 (K1)** and **(K2)** knobs, parameter settings are unchanged immediately after you change to another knob set. Settings are not changed until you perform a knob operation after changing the knob set.

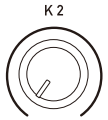

- Use the **15**  $\nabla$  button to cycle through settings until the “ $\nabla$ CTRL” indicator to the right of the button is lit.



- Touch **18** **KNOB**.

The name of the currently selected knob set will be shown on the display.



- For information about parameters assigned to the **22 (K1)** and **(K2)** knobs by each knob set, see “Knob Set List” (page EN-76).
- Use the **10** – and **11** + buttons to select a knob set.
    - To return to the initial default setting, touch **10** – and **11** + at the same time.

■ To initialize all parameter settings that can be configured with knob operations

**NOTE**

- The procedure below returns all parameter settings in the “Knob Set List” (page EN-76) to the Digital Piano’s initial defaults.

1. Use the **[F5] ∇** button to cycle through settings until the “∇CTRL” indicator to the right of the button is lit.
2. Hold down the **[F8] KNOB** button until “Sure?” appears on the display.
3. To initialize, touch **[F1] +**. To exit this operation without initializing, touch **[F10] -**.

## Using the Pitch Bend Wheel

You can use the pitch bend wheel to slide the pitch of notes smoothly upwards and downwards. This capability makes it possible to reproduce saxophone and electric guitar choking effects.

PITCH BEND

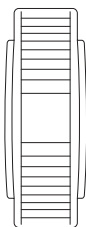

1. While playing a note on the keyboard, rotate the **[F23] PITCH BEND** wheel on the left of the keyboard upwards or downwards.

The amount the note bends depends on how much you rotate the pitch bend wheel.

- Do not touch the wheel as you turn on the keyboard.

**NOTE**

- You can use FUNCTION parameter 52 (“P Bend Range”) to specify the amount of pitch change at maximum rotation in either direction. For information about FUNCTION parameters, see “Configuring Function Settings (FUNCTION Mode)” (page EN-53).

## Using the Arpeggiator

With the arpeggiator, you can play various arpeggios and other phrases automatically by simply pressing keys on the keyboard. You can select from a number of different arpeggio options, including playing arpeggios from a chord, playing various phrases automatically, and more.

- A single button is used to control the arpeggiator and auto harmonize (page EN-37). Because of this, auto harmonize cannot be used while the arpeggiator is in use.

■ To enable the arpeggiator

**IMPORTANT!**

- If “AH” appears instead of “AR” when you touch the **[F19] ARPEG.** button in step 2 of the procedure below, you will need to change the function assigned to the **[F19] ARPEG.** button. Select “Arpeggiator” for FUNCTION parameter 78 (“Type Select”). For information about FUNCTION parameters, see “Configuring Function Settings (FUNCTION Mode)” (page EN-53).

1. Use the **[F5] ∇** button to cycle through settings until the “∇CTRL” indicator to the right of the button is lit.

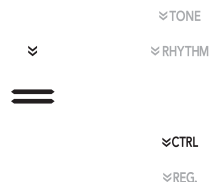

2. To enable the arpeggiator, touch **[F19] ARPEG.** This will cause “AR” to appear on the display.



- Playing a chord or single note on the keyboard will play back the currently selected arpeggio.

- To disable the arpeggiator, touch **[F9] ARPEG.** This will cause “AR” to disappear from the display.

**NOTE**

- Enabling FUNCTION parameter 79 (“Arpeggio Hold”) causes the arpeggio pattern to continue playing even after you release the keyboard keys of the chord.
- You can use FUNCTION parameter 80 (“Arpeggio Part”) to specify whether the arpeggiator sounds for both the Upper1 and Upper2 parts when the keyboard is layered with two tones (page EN-15), or for the Upper1 part only.
- For information about FUNCTION parameters, see “Configuring Function Settings (FUNCTION Mode)” (page EN-53).

■ To select an arpeggiator type

- Perform steps 1 and 2 of the procedure under “To enable the arpeggiator” (page EN-27) to enable the arpeggiator.
- Hold down the **[F9] ARPEG.** button until “ARPEG.” appears on the display.

This causes the currently selected arpeggiator type to appear in line two of the display.



- Use the **[F10] -** and **[F11] +** buttons to select an arpeggiator type.

- While the arpeggiator type is displayed, holding down the **[F9] ARPEG.** button until the tone name display appears will select the tone that is recommended for the displayed arpeggiator type.
- For details about arpeggiator types, refer to the separate “Built-in Music Data Lists”.

## Splitting the Keyboard for Duet Play

You can split the keyboard in the center for duet play so the left and right sides have the same ranges. The Duet Mode is the perfect way to conduct lessons, with the teacher playing on the left side as the student plays the same song on the right side.

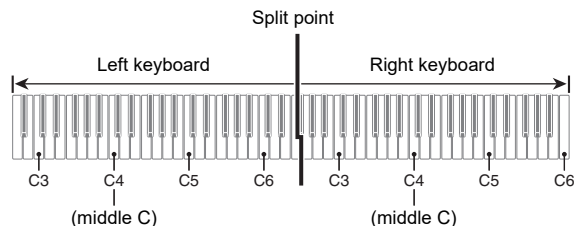

**NOTE**

- You can change the ranges of the left and right keyboards in octave units from their initial default settings. This comes in handy, for example, if the initial default range is not enough when one person is playing the left hand part and another person is playing the right hand part. For information about the setting operation, see “To change the octaves of the duet keyboards” (page EN-29).

■ Pedal Operation when Playing a Duet

- If you are using the separately available SP-34 Pedal Unit, the left outer pedal is the left keyboard damper pedal, while the right outer pedal is the right keyboard damper pedal. Only the damper pedal for the right keyboard supports half-pedal operations.

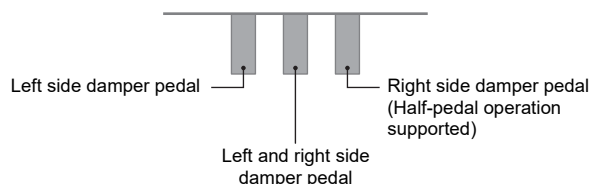

- To use the supplied SP-3 Pedal as a damper pedal that affects both the left keyboard and right keyboard, connect it to the **[F27] DAMPER PEDAL** jack. In the Duet Mode, this pedal functions as a damper pedal, regardless of the effect type assigned to it with the procedure under “To change the function of the pedal connected to the DAMPER PEDAL jack” (page EN-7). Half-pedal operation is not supported in this case.
- If you connect the supplied SP-3 pedal to the **[F31] EXPRESSION/ASSIGNABLE** jack, it can be used as a soft pedal for both the left and right keyboards.

## ■ To use the Duet Mode

1. Hold down the **[F5]** **∨** button until “[FUNCTION]” appears on the display.  
This enters the FUNCTION Mode.
2. Use the **[F10]** **<** and **[F11]** **>** buttons to select the following menu items in sequence: “KEYBOARD” → “DUET”.
3. After confirming that “Duet Mode” is displayed, touch **[F12]** **ENTER**.
4. Use the **[F10]** **-** and **[F11]** **+** buttons to change the Duet Mode setting.
  - To use the Duet Mode, select either “On” or “Pan” for this setting. To exit the Duet Mode and return to normal keyboard play, select “Off”.

This setting (displayed):	Does this:
Off	Exits the Duet Mode.
On	Enters the Duet Mode.
Pan	Outputs left-side keyboard notes from the left speaker and right-side keyboard notes from the right speaker while in the Duet Mode.

5. To exit the FUNCTION mode, hold down **[F5]** **EXIT** until “[FUNCTION]” disappears from the display.

### NOTE

- Some settings become fixed and cannot be changed while in the Duet Mode.
- The following effects cannot be used while “Pan” is selected for the Duet Mode setting: Hall Simulator/Reverb (page EN-21), Surround (page EN-21), Chorus (page EN-25), Acoustic Simulator (page EN-25).
- In the Duet Mode, the knob set (page EN-26) is automatically changed to 12 Kbd/Acmp Vol. This knob set is fixed, and cannot be changed.

## ■ To change the octaves of the duet keyboards

1. Perform steps 1 and 2 under “To use the Duet Mode” (page EN-29).
2. Use the **[F10]** **<** and **[F11]** **>** buttons to display “Upper Octave” (right-side keyboard) or “Lower Octave” (left-side keyboard) and then touch **[F12]** **ENTER**.
3. Use the **[F10]** **-** and **[F11]** **+** buttons to change the setting.
  - You can specify the right-side keyboard octave while “Upper Octave” is displayed, and the left-side keyboard octave while “Lower Octave” is displayed.
  - Increasing the setting value by one raises by one octave, while lowering the value by one lowers by one octave. The initial default for both settings is 0.
  - You can shift the octave of each keyboard within the range of -2 to +2 octaves.
4. Touch **[F5]** **EXIT**.
5. Repeat steps 2 through 4 of this procedure as required to specify settings for both keyboards.

### Example:

Specifying 0 for “Upper Octave” and 1 for “Lower Octave” results in the keyboard octaves shown below.

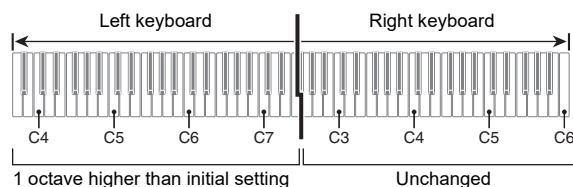

6. To exit the FUNCTION mode, hold down **[F5]** **EXIT** until “[FUNCTION]” disappears from the display.

## Changing the Scale Tuning (Temperament) of the Keyboard

You can change the scale of the keyboard from the standard equal temperament to another tuning that is more suitable for playing Indian music, Arabic music, classical music, etc. You can select from among the 17 preset scales described below.

### ■ To change the scale

1. Hold down the **[F5] ∇** button until “[FUNCTION]” appears on the display.

This enters the FUNCTION Mode.

2. Use the **[F10] <** and **[F11] >** buttons to select the following menu items in sequence: “KEYBOARD” → “SCALE TUNING” → “Scale Type”.

3. Use the **[F10] -** and **[F11] +** buttons, or **[K22] (K1)** knob to select a scale setting.

• You can select any one of the scales shown in the table below.

This setting (displayed):	Selects this scale:
Equal	Equal Temperament
Pure Major	Pure Major
Pure Minor	Pure Minor
Pythagorean	Pythagorean
Kirnberger 3	Kirnberger 3
Werckmeister	Werckmeister
Mean-Tone	Mean-Tone
Rast	Rast
Bayati	Bayati
Hijaz	Hijaz
Saba	Saba
Dashti	Dashti
Chahargah	Chahargah
Segah	Segah
Gurjari Todi	Gurjari Todi
Chandrakauns	Chandrakauns
Charukeshi	Charukeshi

4. If you want to change the base note of the scale, perform the steps below.

• You do not need to perform these steps if you want to use the default base note setting (C).

- (1) Touch **[F5] EXIT**.
- (2) Use the **[F10] <** and **[F11] >** buttons to display “Scale Base Note” and then touch **[F12] ENTER**.
- (3) Use the **[F10] -** and **[F11] +** buttons, or **[K22] (K1)** knob to select a base note setting.

5. To exit the FUNCTION mode, hold down **[F5] EXIT** until “[FUNCTION]” disappears from the display.

### ■ To use the current scale notes for Auto Accompaniments

Use FUNCTION parameter 29 to enable (“On”) or disable (“Off”) “Accomp Scale”. Enabling this setting will apply the scale and base note selected using the operation under “[To change the scale](#)” (page EN-30) to Auto Accompaniments. For information about FUNCTION parameters, see “[Configuring Function Settings \(FUNCTION Mode\)](#)” (page EN-53).

## Using Auto Accompaniment

With Auto Accompaniment, simply select an accompaniment pattern. Each time you play a chord with your left hand the appropriate accompaniment will play automatically. It's like having a personal backup group along with you wherever you go.

### Selecting a Rhythm

#### ■ Rhythms and Categories

The rhythms of your Digital Piano are divided among six categories, which you can access using RHYTHM category buttons **[F16]** through **[F21]**. Each of the six categories is divided further into sub-categories, and touching the RHYTHM category button for a particular category will cycle in sequence between its sub-categories.

For details about rhythm categories and sub-categories, and the names of rhythms included in each sub-category, refer to the separate “Built-in Music Data Lists”.

## ■ To select a rhythm

1. Use the **[15]** **∨** button to cycle through settings until the “**∨RHYTHM**” indicator to the right of the button is lit.

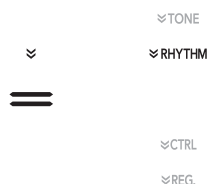

The names of the currently selected rhythm category and rhythm will be shown on the display.

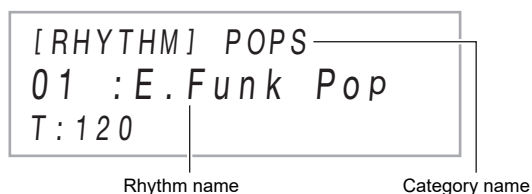

2. Use **RHYTHM** category buttons **[16]** through **[21]** to select a **RHYTHM** category.

- Touching one of the **RHYTHM** category buttons switches to the rhythm that was selected the last time that rhythm category was exited.
- Each touch of the **RHYTHM** category button of the currently selected rhythm category will cycle to the next sub-category of that category.

3. Use the **[10]** **-** and **[11]** **+** buttons to select a rhythm.

- To jump to the first rhythm in the current category, touch **[10]** **-** and **[11]** **+** at the same time.

## Playing Auto Accompaniment

The Auto Accompaniments of this Digital Piano consist of a "rhythm part" (drums and percussion) and a "chord part" (various musical instruments). When playing an Auto Accompaniment, you can sound the rhythm part only, or you can sound both parts at the same time.

### ■ To play the rhythm part only

#### NOTE

- The rhythm part is the foundation of each Auto Accompaniment. Your Digital Piano comes with a variety of built-in rhythms, including 8-beat and waltz. Use the procedure below to play the basic rhythm part.

1. Use the **[3]** mode selector button to cycle through settings until the “**RHYTHM**” (**RHYTHM Mode**) indicator is lit.



2. Use the procedure under “**To select a rhythm**” (page [EN-31](#)) to select the rhythm you want.

3. Touch **[8]** **START/STOP**.

This starts normal pattern (page [EN-32](#)) rhythm play.

- The yellow and red LEDs above the **[8]** **START/STOP** button will flash in time with the rhythm (yellow for beat 1, red for the remaining beats of each measure).

4. Play along with the rhythm.

5. To stop rhythm play, touch **[8]** **START/STOP** again.

#### NOTE

- In step 3 of the above procedure, you can also touch one of the buttons below to start rhythm pattern play.
  - **[4]** **INTRO** ... Starts play with an intro pattern.
  - **[5]** **NORMAL/FILL-IN** ... Starts normal pattern play.
  - **[6]** **VARIATION/FILL-IN** ... Starts play of a variation pattern.

For information about the different rhythm (Auto Accompaniment) patterns, see “[Auto Accompaniment Pattern Variations](#)” (page [EN-32](#)).



■ To play Auto Accompaniment with chords

**NOTE**

- Playing a chord with your left hand automatically adds bass and harmony accompaniment parts to the currently selected rhythm. It is just like having your own personal back up group on call.

1. Use the **3** mode selector button to cycle through settings until the “ACCOMP” (ACCOMP Mode) indicator is lit.



2. Start play of the rhythm part.

- For information about how to select a rhythm and start playing it, see steps 2 and 3 under “To play the rhythm part only” (page EN-31).

3. Use the accompaniment keyboard to play chords.

This will cause bass and harmony Auto Accompaniment parts to be added to the rhythm part.

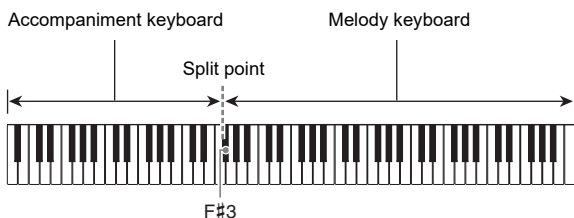

Example:

Pressing D-F#-A-C on the accompaniment keyboard  
 ↓  
 Accompaniment for the D-F#-A-C chord (D7) sounds.

- You can use the split point to change the size of the accompaniment keyboard range (page EN-16).

4. Play other chords with left hand as you play the melody with your right hand.

- You can use “CASIO Chord” or other simplified chord input modes to play chords. See “Selecting a Chord Input Mode” (page EN-34).

5. To stop Auto Accompaniment, touch **8** START/STOP.

**NOTE**

- With the above procedure, you finger chords to be played by the Auto Accompaniment. You also can use music presets to sound Auto Accompaniment using a chord progression based on the music genre you want to perform, without inputting chords. For details, see “Using Music Preset” (page EN-38).

■ Metronome Accompaniment Patterns

The accompaniment patterns below produce metronome sounds only, without a bass or chord part. This is true even if you finger a chord.

This rhythm number:	Selects this metronome sound:
BALLAD: 39	Sounds a click for all beats.
BALLAD: 40	Sounds a bell for all beats.
BALLAD: 41 to 48	Two beats to nine beats per measure. The first beat of each measure is a bell sound, while the remaining beats are clicks.

■ To change the Auto Accompaniment Tempo

See “Changing the Auto Accompaniment and Song Tempo” (page EN-38).

**Auto Accompaniment Pattern Variations**

Generally, the progress of a musical piece starts with an intro, transitions to verses that are interspersed with interludes and other changes, and then returns to the main theme before reaching an ending. The Digital Piano’s Auto Accompaniment function provides a selection of accompaniment patterns that are suited to the progress of a musical composition.

■ Normal and Variation

This is an accompaniment pattern that can be used in the verse or chorus of a piece. A variation repeats anywhere from one measure to multiple measures.

To play this accompaniment pattern:	Do this:
Normal	Touch <b>5</b> NORMAL/FILL-IN.
Variation	Touch <b>6</b> VARIATION/FILL-IN.

### ■ Fill-in

These accompaniment patterns are used to insert short one- or two-measure fill-ins into a piece. A fill-in pattern starts to play as soon as you touch one of the fill-in buttons (see below). Accompaniment play returns to the original normal or variation pattern from beat one after the one- or two-measure fill-in is complete.

To play this accompaniment pattern:	Do this:
Normal Fill-in	While a normal pattern is playing, touch <b>5 NORMAL/FILL-IN</b> .
Variation Fill-in	While a variation pattern is playing, touch <b>6 VARIATION/FILL-IN</b> .

### ■ Intro

This is an accompaniment pattern that can be used at the beginning of a song. Normal accompaniment pattern play will start after the measures of the intro accompaniment pattern is complete.

To play this accompaniment pattern:	Do this:
Intro	Touch <b>4 INTRO</b> .

### ■ Ending

This is an accompaniment pattern that can be used at the end of a piece. After a multiple-measure ending sounds, Auto Accompaniment ends.

To play this accompaniment pattern:	Do this:
Ending	While an Auto Accompaniment is playing, touch <b>7 SYNCHRO/ENDING</b> .

## Triggering Auto Accompaniment Play with Accompaniment Keyboard Input (Synchro Start)

Use the procedure below to configure the Digital Piano to start Auto Accompaniment play as soon as you press a keyboard key.

### ■ To trigger Auto Accompaniment play with chord keyboard input

#### 1. While Auto Accompaniment play is stopped, touch **7 SYNCHRO/ENDING**.

This enters synchro start standby, which is indicated by the LEDs above the **8 START/STOP** button flashing between yellow and red.

- If you want to start with an intro, touch **4 INTRO** here.
- If you want to start with a variation, touch **6 VARIATION/FILL-IN** here.

#### 2. Finger a chord on the accompaniment keyboard.

This starts Auto Accompaniment.

#### NOTE

- To exit synchro start standby, touch **7 SYNCHRO/ENDING**.

## Using the Keyboard to Control the Auto Accompaniment Pattern (Keyboard Controller Mode)

You can use the six leftmost white keyboard keys to start and stop accompaniment pattern play, to switch between patterns, etc.

### ■ To enter the keyboard controller mode

1. Hold down the **3** mode selector button until “KC” appears on the display.

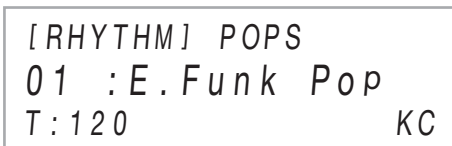

- This enters the Keyboard Controller Mode and assigns the button operations shown below to the leftmost white keyboard keys.

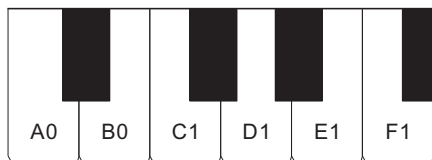

Keyboard Key	Button
A0	<b>3</b> Mode selector button*
B0	<b>4</b> <b>INTRO</b> button
C1	<b>5</b> <b>NORMAL/FILL-IN</b> button
D1	<b>6</b> <b>VARIATION/FILL-IN</b> button
E1	<b>7</b> <b>SYNCHRO/ENDING</b> button
F1	<b>8</b> <b>START/STOP</b> button

\* Toggles between the RHYTHM and ACCOMP modes only.

2. To exit the Keyboard Controller Mode, hold down the **3** mode selector button until “KC” disappears from the display.

### NOTE

- In the Keyboard Controller Mode, no note sounds when you press a keyboard key in the range of A0 to F1 (including the black keys).

## Selecting a Chord Input Mode

You can use FUNCTION parameter 75 (“Chord Mode”) to select one of the six chord input modes below.

This setting (displayed):	Selects this chord input mode:
CASIO Chord	CASIO CHORD
Fingered 1	FINGERED 1
Fingered 2	FINGERED 2
Fg On Bass	FINGERED ON BASS
Fg Assist	FINGERED ASSIST
Full Range	FULL RANGE CHORD

For information about FUNCTION parameters, see “Configuring Function Settings (FUNCTION Mode)” (page EN-53).

## ■ CASIO CHORD

With CASIO CHORD, you can use simplified fingerings to play the four types of chords described below.

Accompaniment keyboard



### Chord Type

#### Major Chords

Pressing a single accompaniment area key in the CASIO CHORD mode will play the major chord whose name is marked above the key. All of the accompaniment area keys that are marked with the same chord name play exactly the same chord.

*Example: C (C Major)*



#### Minor Chords

To play a minor chord, press the accompaniment area key that corresponds to the major chord, while also pressing one other accompaniment area key to the right.

*Example: Cm (C Minor)*



#### Seventh Chords

To play a seventh chord, press the accompaniment area key that corresponds to the major chord, while also pressing two other accompaniment area keys to the right.

*Example: C7 (C Seventh)*



#### Minor Seventh Chords

To play a minor seventh chord, press the accompaniment area key that corresponds to the major chord, while also pressing three other accompaniment area keys to the right.

*Example: Cm7 (C Minor Seventh)*



## ■ FINGERED

With these input modes, you play chords on the accompaniment keyboard using their normal chord fingerings. Some chord forms are abbreviated, and can be fingered with one or two keys.

See page EN-71 for information about chords that are supported and how they are fingered on the keyboard.

Accompaniment keyboard



### ● FINGERED 1

Play the component notes of the chord on the keyboard.

### ● FINGERED 2

Unlike FINGERED 1, 6th input is not possible. m7 or m7<sup>b5</sup> is input.

### ● FINGERED ON BASS

Unlike FINGERED 1, allows input of fraction chords with the lowest keyboard note as the base note.

## NOTE

- When playing a minor, seventh, or minor seventh chord, it makes no difference whether the additional keys you press are black or white.

● **FINGERED ASSIST**

Produces an effect that is different from FINGERED 1 when two or three keys are pressed. Pressing a root key and any key to the left of the root key plays a seventh chord, while a black key plays a minor chord. Pressing both a white and black key together plays a minor seventh chord.

- In addition to FINGERED 1, you can also use the methods below to play the three types of chords described below.

**Chord Type**

**Minor Chords**

To play a minor chord, press the accompaniment keyboard key that specifies the major chord, while also adding the closest black key to the left of the major chord key.

*Example: Cm (C Minor)*



**Seventh Chords**

To play a seventh chord, press the accompaniment keyboard key that specifies the major chord, while also adding the closest white key to the left of the major chord key.

*Example: C7 (C Seventh)*



**Minor Seventh Chords**

To play a minor seventh chord, press the accompaniment keyboard key that specifies the major chord, while also adding the closest white and black keys to the left of the major chord key.

*Example: Cm7 (C Minor Seventh)*

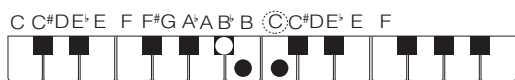

■ **FULL RANGE CHORD**

With this mode, you can use the full range of the keyboard to play chords and the melody.

See page EN-71 for information about chords that are supported.

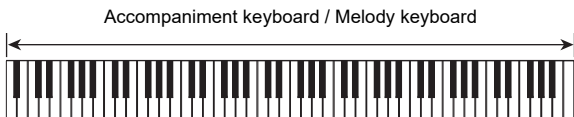

**Using One-Touch Preset**

With One-Touch Preset, the Digital Piano automatically configures optimal tone, tempo, and other settings in accordance with the rhythm pattern you select.

■ **To recall a one-touch preset**

1. Use the **[3]** mode selector button to cycle through setting until the “RHYTHM” or “ACCOMP” indicator is lit.

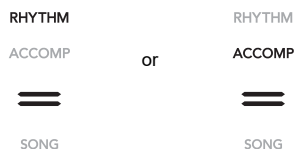

2. Use the procedure under “To select a rhythm” (page EN-31) to select the rhythm you want.
3. Hold down the **[2]** BALLAD button until the display changes from the rhythm name to the tone name.



This will automatically apply the One-Touch Preset settings in accordance with the rhythm pattern that is currently selected. At this time, the Digital Piano will go into Auto Accompaniment synchro start standby (page EN-33).

## Using Auto Harmonize

Auto Harmonize lets you add harmony to melody notes you play with your right hand for more melodic depth. You can select any one of 12 Auto Harmonize types.

- A single button is used to control auto harmonize and the arpeggiator (page EN-27). Because of this, the arpeggiator cannot be used while auto harmonize is in use.

### ■ To enable auto harmonize

#### ! IMPORTANT!

- If “AR” appears instead of “AH” when you touch the **[F9] ARPEG.** button in step 2 of the procedure below, you will need to change the function assigned to the **[F9] ARPEG.** button. Select “A.Harmonize” for FUNCTION parameter 78 (“Type Select”). For information about FUNCTION parameters, see “Configuring Function Settings (FUNCTION Mode)” (page EN-53).

1. Use the **[F5] ∇** button to cycle through settings until the “∇CTRL” indicator to the right of the button is lit.

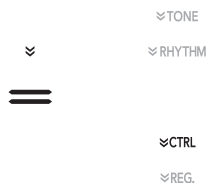

2. To enable auto harmonize, touch **[F9] ARPEG.** This will cause “AH” to appear on the display.

```
[CTRL] KNOB
01 :Filter
T:120 AH
```

- Fingering a chord on the accompaniment keyboard as you play the melody on the Melody keyboard (Upper part keyboard) will add chords to your melody play.

3. To disable auto harmonize, touch **[F9] ARPEG.** This will cause “AH” to disappear from the display.

### ■ To select the Auto Harmonize type

1. Perform steps 1 and 2 under “To enable auto harmonize” (page EN-37) to enable auto harmonize.
2. Hold down the **[F9] ARPEG.** button until “A.HARMO” appears on the display.

This causes the currently selected auto harmonize type to appear in line two of the display.

```
[CTRL] A. HARMO
01 :Duet 1
T:120 AH
```

3. Use **[F10] -** and **[F11] +** buttons to select an auto harmonize type.

Type (displayed)	Description
01: Duet 1	Adds close (separated by 2 to 4 degrees) 1-note harmony below the melody note.
02: Duet 2	Adds open (separated by more than 4 to 6 degrees) 1-note harmony below the melody note.
03: Country	Adds country style harmony.
04: Octave	Adds the note from the next lower octave.
05: 5th	Adds the fifth degree note.
06: 3-Way Open	Adds 2-note open harmony, for a total of three notes.
07: 3-Way Close	Adds 2-note close harmony, for a total of three notes.
08: Strings	Adds harmony that is optimal for strings.
09: 4-Way Open	Adds 3-note open harmony, for a total of four notes.
10: 4-Way Close	Adds 3-note close harmony, for a total of four notes.
11: Block	Adds block chord notes.
12: Big Band	Adds big band style harmony.

## Changing the Auto Accompaniment and Song Tempo

There are two ways to change the tempo (beats per minute) setting: using buttons to specify a tempo value, and tapping a beat with a keyboard key or a pedal.

### NOTE

- You can specify use of a letter (T) or an icon (♪) as the display indicator to the left of the tempo value. To specify the indicator type, use FUNCTION parameter 108 (“Tempo Indicator”). For information about FUNCTION parameters, see “Configuring Function Settings (FUNCTION Mode)” (page EN-53).

#### ■ To specify a tempo value

##### 1. Touch **[12] TEMPO**.

The current tempo value will be shown on the display.

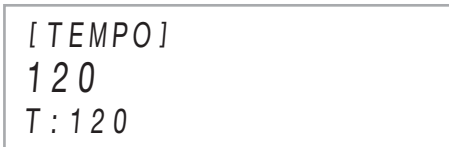

##### 2. Use the **[10] -** and **[11] +** buttons to adjust the tempo value.

- You can specify a tempo value in the range of 20 to 255.
- To return the currently selected song, rhythm pattern, or music preset to its recommended tempo setting, touch **[10] -** and **[11] +** at the same time.

##### 3. To exit the setting screen, touch **[12] TEMPO** or **[15] EXIT**.

#### ■ To use the keyboard key or a pedal to adjust the tempo

##### 1. Hold down the **[12] TEMPO** button.

This causes “TAP” to appear to the right of [TEMPO] on the display.

##### 2. Press a keyboard key or a pedal at least twice in succession.

- This will set a tempo that corresponds to the speed at which you pressed the keyboard key or pedal.

##### 3. Release **[12] TEMPO**.

- You can use the above steps to set an approximate tempo and then use the steps under “To specify a tempo value” to fine tune the setting.

### NOTE

- Note that an expression pedal cannot be used to set a tempo using the above procedure.

## Using Music Preset

Selecting a Music Preset instantly changes the Digital Piano to a preset setup (tone, rhythm, chord progression, etc.) for play of songs of various genres/categories. The press of a button sets up the Digital Piano so those songs sound exactly the way you thought they should. See the separate “Built-in Music Data Lists” for a complete list of the 310 Music Presets that are available.

#### ■ To perform using a music preset

##### 1. Use the **[3] mode selector button** to cycle through setting until the “RHYTHM” or “ACCOMP” indicator is lit.

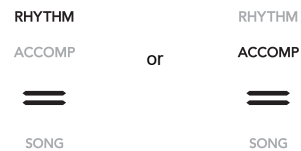

##### 2. Use the **[15] ∇** button to cycle through settings until the “∇RHYTHM” indicator to the right of the button is lit.

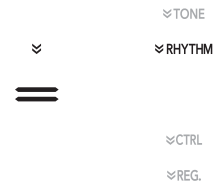

##### 3. Hold down the **[16] POPS** button until “[MUSIC PRESET]” appears on the display.

This enters the Music Preset Mode and causes the **[3] mode selector button** “ACCOMP” indicator to flash.



Music preset number

Music preset name

- The name and number of the currently selected music preset will be shown on the display.
- This enters synchro start standby, which is indicated by the flashing yellow and red LEDs above the **[3] START/STOP** button.

#### 4. Use the **[10] -** and **[11] +** buttons to select a music preset number.

This changes the displayed music preset name. At the same time, settings are recalled for the tone, rhythm, chord progression, and data that matches the genre or melody indicated by the name.

- You can also change tone, rhythm, DSP, and other settings as required. To do so, use the **[15] √** button to select the type of functions assigned to buttons **[16]** to **[21]**. Each touch of **[15] √** cycles to the next function type, and the current selection is indicated by the indicator that is lit to the right of the button: “√TONE”, “√RHYTHM”, or “√CTRL”.
- To return to the music preset selection screen (the screen in step 3 of this procedure) after touching **[15] √**, touch the **[3]** mode selector button.

#### ■ To change a music preset tempo

See “[Changing the Auto Accompaniment and Song Tempo](#)” (page [EN-38](#)).

#### ■ To change the key of a chord progression

You can use FUNCTION parameter **76** (“MP Key Shift”) to change the chord progression key. For information about FUNCTION parameters, see “[Configuring Function Settings \(FUNCTION Mode\)](#)” (page [EN-53](#)).

#### 5. Touch **[8] START/STOP**.

This starts Auto Accompaniment play in accordance with the preset chord progression.

- Instead of the button operations above, you can also start Auto Accompaniment play by playing something on the accompaniment keyboard. Note, however, that pressing an accompaniment keyboard key will start the preset chord progression. The accompaniment keyboard cannot be used to specify chords, in this case.

#### 6. Play along on the keyboard with the Auto Accompaniment.

#### 7. To stop Auto Accompaniment, touch **[8] START/STOP** or **[7] SYNCHRO/ENDING**.

#### 8. To exit the Music Preset Mode, display the music preset selection screen and then touch the **[3] mode selector button**

- At this time the tone and rhythm settings configured by the Music Preset Mode remain in effect.

#### NOTE

- The accompaniment pattern operations below can be used during a performance with a music preset. See “[Auto Accompaniment Pattern Variations](#)” (page [EN-32](#)) and “[Using the Keyboard to Control the Auto Accompaniment Pattern \(Keyboard Controller Mode\)](#)” (page [EN-34](#)). Note, however, that the function of keyboard key A0 is disabled in the Keyboard Controller Mode.
- The registration function (page [EN-40](#)) cannot be used in the Music Preset Mode.



## Registering and Restoring a Setup (Registration)

You can use the registration function to register the setup of the Digital Piano (tone, rhythm, and other settings). You can recall a registered setup as required to perform a particular song, etc.

### NOTE

- Registration operations can be performed in the RHYTHM Mode (page EN-12) or ACCOMP Mode (page EN-12).
- Registration operations cannot be performed in the SONG Mode (page EN-12), while demo play (page EN-14), music presets (page EN-38), or any setting operation (page EN-53) is in progress.

### Setup Storage Locations

Setup registrations are stored in memory locations that are divided into 24 banks. Each bank has four storage areas, which means you can register up to 96 setups (24 banks × 4 areas).

- Use the **16 BANK** button to specify a bank.
- Specify an area using the **17 Area 1** to **20 Area 4** buttons.

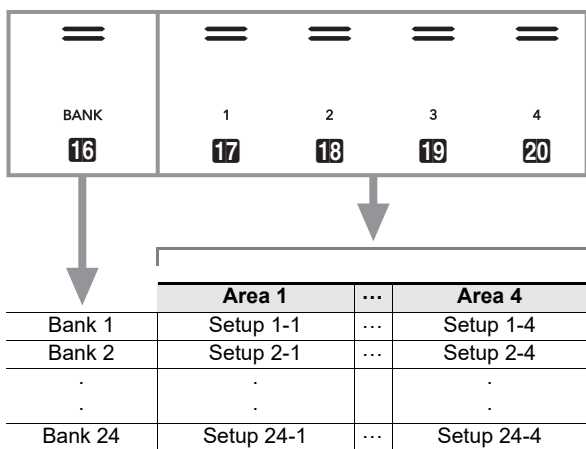

### Registration Memory Data

Setting Items	Freeze*1
Rhythm number, mode selection (ACCOMP Mode or RHYTHM Mode), synchro start standby, Auto Accompaniment settings (chord input mode, Auto Accompaniment volume)	Accompaniment
Tempo	Tempo
Tone numbers (Upper1, Upper2, Lower), Layer enable/disable, Split enable/disable, DSP (type, parameter), keyboard volume setting, part settings (volume, octave shift, fine tune), duet setting	Tone
Split point	Split Point
Auto harmonize/arpeggiator (enable/disable, type, other settings)	Arpeg./A.Harmo.
Transpose	Transpose
Scale settings (type, base note, Auto Accompaniment scale)	Scale Tuning
Touch Response settings	Touch Response
Chorus type, brilliance settings	Effect
Hall simulator/reverb (enable/disable, type, depth), surround (enable/disable, type)	Sound Mode
Damper pedal function, expression/assignable pedal function, pitch bend range, part settings (Pedal Unit, damper pedal, expression/assignable pedal, pitch bend wheel)	Pedal/Wheel
Knob settings*2	Knob

\*1 The "Freeze" column shows the names of parameters included in the "FREEZE" directory (FUNCTION parameter 57). For details, see "Freeze Function" (page EN-42).

\*2 Special setting item for **22 (K1)** and **(K2)** knob operations. For information about knob settings that can be registered in a setup, see "Knob Set List" (page EN-76).

### Saving to an External Device

Setups saved using registration can be saved to a USB flash drive in bank units. See "USB Flash Drive Operations" (page EN-62).

## Registering and Recalling a Setup

### ■ To register a setup

#### ! IMPORTANT!

- Specifying a bank and area that already has data stored to it in the procedure below causes the recorded data to be deleted. For information about banks and areas, see “Setup Storage Locations” (page EN-40).

- Use the **[3]** mode selector button to cycle through settings until the “RHYTHM” or “ACCOMP” indicator is lit.

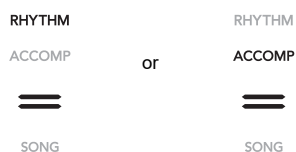

- Configure the Digital Piano with the setup you want to register.

- Use the **[15] ∇** button to cycle through settings until the “∇REG.” indicator to the right of the button is lit.

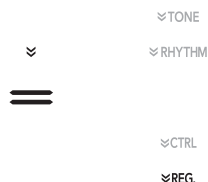

- Select bank you want to use as the registration destination.

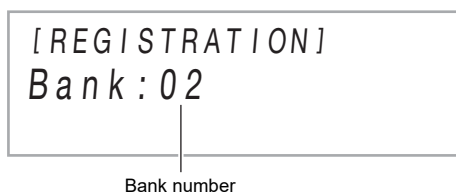

- Touch **[16] BANK** to cycle to the next bank number.
- Use the **[10] -** and **[11] +** buttons to select a bank number.

- Select the area where you want to store the setup.

While holding down **[21] STORE**, touch an area button from **[17] Area 1** to **[20] Area 4**.

This causes “Sure?” to appear on the display.

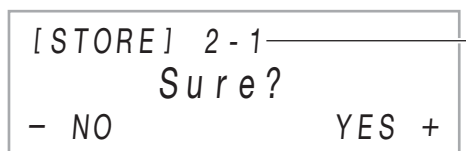

Bank number - Area number

- To exit setup registration at this time, touch **[10] -**.

- To register the setup, touch **[11] +**.

This completes the registration operation and displays “Complete”.

### ■ To recall a registered setup

- Use the **[3]** mode selector button to cycle through settings until the “RHYTHM” or “ACCOMP” indicator is lit.
- Use the **[15] ∇** button to cycle through settings until the “∇REG.” indicator to the right of the button is lit.
- Enable or disable the freeze function as required.

- The “FZ” indicator on the display indicates that the freeze function is enabled. There is no indicator when the function is disabled. To toggle the freeze function setting between enabled (“FZ” displayed) and disabled (“FZ” not displayed), hold down the **[16] BANK** button.

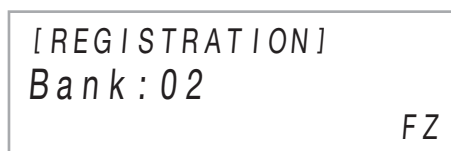

- For details about the freeze function, see “Freeze Function” (page EN-42).

- Use **[16] BANK**, or **[10] -** and **[11] +** to select the bank of the setup you want to recall.

- 5. Touch one of the buttons from **[17]** Area 1 through **[20]** Area 4 to select the area where the setup you want to recall is located.**

This recalls the setup.



- This causes the Digital Piano’s settings to change in accordance with the setup you recalled.

**■ Freeze Function**

Recalling a registered setup normally overwrites all of the settings shown under “Registration Memory Data” (page EN-40). You can also use the freeze function to specify particular settings that should not be overwritten when a setup registration is recalled.

For FUNCTION parameter numbers 58 to 69 (parameters included in 57 “FREEZE”) select either “On” (maintain current setting) or “Off” (overwrite current setting) to specify what should happen when a setup is recalled.

- For information about what settings are maintained when “On” is selected for a FUNCTION parameter number, see “Registration Memory Data” (page EN-40).
- For information about FUNCTION parameters, see “Configuring Function Settings (FUNCTION Mode)” (page EN-53).

**Using a Pedal to Cycle Through Multiple Setups (Sequential Pedal Recall)**

You can configure Digital Piano settings so each press of a pedal scrolls through and selects setups you registered with the registration function.

**■ To specify the pedal for recalling setups**

- 1. Hold down the **[15]**  $\nabla$  button until “[FUNCTION]” appears on the display.**

This enters the FUNCTION Mode.

- 2. Use the **[10]** < and **[11]** > buttons to select the following menu items in sequence: “REGISTRATION” → “SEQ PED RECALL”.**

- 3. Use the **[10]** < and **[11]** > buttons to select a pedal jack and then touch **[12]** ENTER.**

To select this pedal jack:	Display this:
<b>[27]</b> DAMPER PEDAL jack	Damper Pedal
<b>[31]</b> EXPRESSION/ASSIGNABLE jack	Exp/Asgn Pedal

- 4. Use the **[10]** – and **[11]** + buttons to change the pedal jack setting.**

To do this:	Display this:
Enable pedal recall so setups scroll forward	Inc
Enable pedal recall so setups scroll back	Dec
Disable pedal recall	Off

- For information about pedal operations that can be performed while each setting is selected, see “To play using the sequential pedal recall function” (page EN-43).
- Specifying “Inc” or “Dec” for a jack will cause the pedal connected to it to function as a registration setup recall pedal only. Any functions assigned to the jack by “Damper Target” (page EN-7) or “Exp/Asgn Target” (page EN-9) will be disabled for that jack.

- 5. To exit the FUNCTION mode, hold down **[15]** EXIT until “[FUNCTION]” disappears from the display.**

## ■ To play using the sequential pedal recall function

1. Connect the included pedal or a separately available CASIO sustain pedal to the jack for which you specified “Inc” or “Dec” in step 4 of the procedure under “To specify the pedal for recalling setups” (page EN-42).

2. At the point when you want to recall the registration setup, press the pedal.

When “Inc” is specified:

- Each short-press and release of the pedal cycles forward through registration setup bank numbers and area numbers (1-1, 1-2, 1-3, 1-4, 2-1, 2-2...).
- Each long-press and release of the pedal cycles back through registration setups (2-2, 2-1, 1-4, 1-3...).

When “Dec” is specified:

- Each short-press and release of the pedal cycles back through registration setup bank numbers and area numbers (24-4, 24-3, 24-2, 24-1, 23-4, 23-3...).
- Each long-press and release of the pedal cycles forward through registration setups (23-3, 23-4, 24-1, 24-2...).

## ■ To disable the sequential pedal recall function

Perform the procedure under “To specify the pedal for recalling setups” (page EN-42). In step 4 of the procedure, display the “Off” setting.

## Using the MIDI Recorder to Record Performances

The MIDI recorder records Digital Piano keyboard play as MIDI data. Recorded data is stored as SONG Mode (page EN-12) song numbers 11 through 15.

- You can have up to five recorded songs in memory.
- Three-track multi-track recording is supported for each song.
- A maximum of approximately 30,000 notes (total for three tracks) can be recorded for each song.

### ! IMPORTANT!

- **CASIO COMPUTER CO., LTD. takes no responsibility for any damages, lost profits, or claims by third parties arising from the deletion of recorded data due to malfunction, repair, or for any other reason.**

## ■ How the Digital Piano records your performances (MIDI Recorder)

Your Digital Piano has two recorders: a MIDI recorder and an audio recorder. Instead of audio (audio data), the MIDI recorder described in this section records keyboard performance information (keyboard key press and release, touch pressure, etc.) as MIDI data.\* The size of MIDI data is much smaller when compared with audio data, making it easier to edit later on a computer, etc.

\* MIDI

MIDI is short for “Musical Instrument Digital Interface”. It is a universal standard that makes it possible for musical instruments, computers, and other devices to exchange performance information (keyboard key press/release, touch pressure, etc.) regardless of manufacturer. Performance data in this case is called “MIDI data”.

## ■ Recorder Tracks and Recorded Data

The MIDI recorder of the Digital Piano is a three-track multi-track recorder.

Recorder track types are a system track and two solo tracks, and the data that can be recorded depends on the track type.

- **System Track:** The system track can be used to record keyboard play using Auto Accompaniment. Layer, split, and other keyboard settings can also be recorded.
- **Solo Track 1, Solo Track 2:** A solo track can be used to record keyboard play using a single tone (Upper1).

These tracks can be overdubbed as shown below.

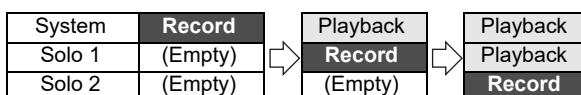

### ■ Recorded Data for Each Track

The symbols below are used in the “System” column to indicate items that can be recorded to the system track, and in the “Solo” column to indicate items that can be recorded to solo tracks 1 and 2.

✓ : Recorded

× : Not recorded

Operation or Setting	System	Solo
Tempo	✓	×
Beat	✓	×
Rhythm Number	✓	×
Rhythm Controller Operations	✓	×
Accompaniment Volume	✓	×
Accompaniment Keyboard Operations	✓	×
Scale Settings	✓	×
Accomp Scale On/Off	✓	×
Duet Settings	✓	×
Keyboard Volume	✓	×
Hall Simulator/Reverb		
On/Off	✓	×
Type	✓	×
Depth	✓	×
Surround Settings	✓	×
Chorus Type	✓	×
Brilliance	✓	×
Acoustic Simulator Settings	✓	×
Keyboard Operations		
Upper1	✓	✓
Upper2	✓	×
Lower	✓	×
Auto Harmonize	✓	×
Arpeggiator	✓	✓
Tone Number		
Upper1	✓	✓
Upper2	✓	×
Lower	✓	×
DSP	✓	✓
Pedal Operation*1	✓	✓
Octave Shift	✓	✓*2
Part Volume	✓	✓*2
Fine Tuning	✓	✓*2
Pitch Bend Wheel Operations	✓	✓
Pitch Bend Range	✓	✓

Operation or Setting	System	Solo
Knob operations		
Cut Off Frequency	✓	✓
Resonance	✓	✓
Brilliance	✓	×
Reverb Send	✓	✓
Chorus Send	✓	✓
Attack Time	✓	✓
Release Time	✓	✓
Vibrato Rate	✓	✓
Vibrato Depth	✓	✓
Delay Vibrato Time	✓	✓
Portamento Time	✓	✓
Modulation Depth	✓	✓
Layer Volume Balance	✓	✓*2
Upper2 Fine Tune	✓	×
Upper1 Pan	✓	✓
Upper2 Pan	✓	×
Lower Volume	✓	×
Lower Pan	✓	×
Keyboard Chorus Send	✓	✓*2
Keyboard Reverb Send	✓	✓*2
Keyboard Volume	✓	×
Accompaniment Volume	✓	×
Song Volume	×	×
DSP Parameter 1	✓	✓
DSP Parameter 2	✓	✓

\*1 Damper, soft, sostenuto, expression

\*2 Upper1 part only

### ■ Saving to an External Device

After you create a recording with the Digital Piano, you can save the resulting data to a USB flash drive. See “[USB Flash Drive Operations](#)” (page EN-62).

## Recording and Playing Back Keyboard Play

### IMPORTANT!

- When the remaining recordable note count is 100 or lower during recording, the **[14] REC** button will flash. When the remaining recordable note count becomes zero, recording will stop automatically and the **[14] REC** button light will stop flashing and turn off.
- Should power fail during recording, all of the data in the track you are recording will be deleted.

### Getting Ready to Use the MIDI Recorder

Your Digital Piano has two recorders: a MIDI recorder and an audio recorder. Depending on the type of data you want to record or play back, you first need to select the MIDI Mode or Audio Mode.

- The MIDI recorder can be used while the Digital piano is in the MIDI Mode. If the Digital Piano is in the Audio Mode, perform the procedure below (Step 1) to switch to the MIDI Mode.
- Note that the Digital Piano is in the MIDI Mode under initial default settings, so the operation below (Step 1) is not necessary if you have not changed the setting.

#### 1. Perform the steps below to put the Digital Piano into the MIDI Mode.

- (1) Hold down the **[15] √** button until “[FUNCTION]” appears on the display.  
This enters the FUNCTION Mode.
- (2) Use the **[10] <** and **[11] >** buttons to select the following menu items in sequence: “SONG” → “Song Type”.
- (3) Use the **[10] -** and **[11] +** buttons to change the setting to “MIDI”.
- (4) To exit the FUNCTION mode, hold down **[15] EXIT** until “[FUNCTION]” disappears from the display.

#### 2. If required, perform the procedure under “To configure recording settings” (page EN-48).

- You can configure the settings below. This operation is not necessary if you plan to use initial default settings. Beats (Default: 4), Metronome (Default: Mute), Pre-count (Default: Mute)

### Operations that Start Recording

While the MIDI recorder or audio recorder (page EN-49) is in record standby, any one of the operations below will start recording.

- Playing something on the keyboard
- Pressing a pedal
- Operating the **[23] PITCH BEND** wheel, **[22] (K1)** knob, or **(K2)** knob
- Touching **[8] START/STOP**, **[5] NORMAL/FILL-IN**, **[3] VARIATION/FILL-IN**, or **[4] INTRO**
- Recalling a Registration Memory setup (page EN-41)

### To record to the system track

#### NOTE

- Before performing the procedure below, read the section titled “Getting Ready to Use the MIDI Recorder” (page EN-45).
- The procedure below records to the system track of the lowest numbered MIDI recorder area (song numbers 11 to 15) that does not yet have anything recorded.

#### 1. Configure the tone, rhythm, effects, tempo, and other settings you want to use during recording.

- For setting items that can be recorded at the beginning of a recording, see the “System” column in the table under “Recorded Data for Each Track” (page EN-44).

#### 2. Touch **[14] REC**.

This enters record standby, indicated by **[14] REC** flashing red.

- To cancel recording, touch **[14] REC** again.
- If the MIDI recorder already has the maximum allowable number of songs recorded, the message “Data Full” will appear on the display, and the Digital Piano will exit record standby. If this happens, use the procedure under “To delete a MIDI recorder song” (page EN-49) to delete song data you no longer need to make room.

#### 3. To start recording, play something on the keyboard or touch **[8] START/STOP**.\*

This causes **[14] REC** to stop flashing and remain lit red, which indicates that recording is in progress.

- \* Recording can also be started using other operations. For details, see “Operations that Start Recording” (page EN-45).

#### 4. To stop recording, touch **[14] REC**.

- This will automatically enter the SONG Mode, with what you just recorded selected for playback.

#### 5. To play back the song you just recorded, touch **[8] ▶/■**.

■ To select a track number before recording

1. Use the **[3]** mode selector button to cycle through settings until the “SONG” (SONG Mode) indicator is lit.
2. Use the **[10] -** and **[11] +** buttons to select a song number.
  - Song numbers 11 through 15 are MIDI recorder areas. If necessary, you can touch **[8] ▶/■** to check whether or not the selected area already has something recorded to it.
  - To record to the song number you select here, perform the procedure under “To record to the system track” (page EN-45). If the system track of the selected song number already has recorded data, it will be overwritten by the new recording.

■ To overdub record a solo track over a recorded system track

**NOTE**

- If you are performing the procedure below immediately following the procedure under “To record to the system track” (page EN-45), you do not need to enter the SONG Mode or select a song. Therefore, you should skip steps 1 and 2 below.

1. Use the **[3]** mode selector button to cycle through settings until the “SONG” (SONG Mode) indicator is lit.
2. Use the **[10] -** and **[11] +** buttons to select the song number of a MIDI recorder song that was recorded to the system track.
  - Song numbers 11 through 15 are for songs recorded with the MIDI recorder. If necessary, you can touch **[8] ▶/■** to play back the song and check its contents.
3. Configure tone and other settings you want to use for recording.
  - For setting items that can be recorded at the beginning of a recording, see the “Solo” column in the table under “Recorded Data for Each Track” (page EN-44).
4. Touch **[14] REC●**.  
This enters record standby, indicated by **[14] REC●** flashing red.
5. Hold down the **[14] REC●** button until “[MIDI REC SETTING]” appears on the display.

6. After confirming that “Rec Track” is displayed, touch **[12] ENTER**.



7. Use the **[10] -** and **[11] +** buttons to select a track.
  - The display will show “Solo 1” or “Solo 2” depending on the solo track you select.
8. To start recording, play something on the keyboard or touch **[3] START/STOP**.\*  
This simultaneously starts playback of the system track and recording to the solo track you selected in step 7 above.  
This causes **[14] REC●** to stop flashing and remain lit red, which indicates that recording is in progress.  
\* Recording can also be started using other operations.  
For details, see “Operations that Start Recording” (page EN-45).
9. To stop recording, touch **[14] REC●**.
10. To play back the song you just recorded, touch **[8] ▶/■**.
  - This will play back the contents of both the system track and the solo track.
  - If you want to overdub record the other solo track, perform steps 3 through 10 again, selecting the remaining (unrecorded) solo track in step 7.

## ■ To re-record part of a recorded track (punch-in recording)

### NOTE

- You can use punch-in recording to re-record a particular section in a specific track in a MIDI recorder song.
- If you want, you can specify the start measure for playback during punch-in recording. If you do not specify a start measure, playback will start from the first measure of the song. For more information, see “[Configuring Recording Settings \(Pre-count, Metronome, Beat, Punch-in Measure\)](#)” (page EN-48).

### 1. Specify the song number of the MIDI recorder song that contains the track you want to re-record.

- (1) Use the **[3]** mode selector button to cycle through settings until the “SONG” (SONG Mode) indicator is lit.
- (2) Use the **[10] -** and **[11] +** buttons to select a song number.
  - Song numbers 11 through 15 are for songs recorded with the MIDI recorder. If necessary, you can touch **[3] ▶/■** to play back the song and check its contents.

### 2. Touch **[14] REC●**.

This enters record standby, indicated by **[14] REC●** flashing red.

### 3. Hold down the **[14] REC●** button until “[MIDI REC SETTING]” appears on the display.

### 4. Select the track you want to re-record.

- (1) After confirming that “Rec Track” is displayed, touch **[12] ENTER**.
- (2) Use the **[10] -** and **[11] +** buttons to select a track.

To select this track:	Display this:
System Track	System
Solo Track 1	Solo 1
Solo Track 2	Solo 2

- (3) Touch **[15] EXIT**.

### 5. Select punch-in recording as the track recording type.

- (1) Use the **[10] <** and **[11] >** buttons to display “Rec Type” and then touch **[12] ENTER**.
- (2) Use the **[10] -** and **[11] +** buttons to select “Punch In”.

### 6. Touch **[3] START/STOP**.

This starts song playback.

- To stop punch-in recording, touch **[3] START/STOP** again.

### 7. When playback reaches the point from which you want to re-record, start playing on the keyboard.

This starts recording and causes the red **[14] REC●** light to change from flashing to lit.

- You can also start recording by touching **[14] REC●**. In this case, rests are inserted at the beginning of the song until you start playing something on the keyboard.

### 8. To stop recording, touch **[14] REC●**.

- The above procedure re-records the track you select in step 4, from the point you started recording in step 7 until you stop recording in step 8.



## Configuring Recording Settings (Pre-count, Metronome, Beat, Punch-in Measure)

The settings shown below are available for recording.

Displayed Setting	Description and Options
Precount	<p>Specifies whether or not to sound a pre-count to signal the start of recording.                      Off: Pre-count does not sound.                      Recording starts as soon as you touch <b>[8] START/STOP</b> or when you play something on the keyboard.</p> <p>1 Measure / 2 Measure:                      A one-measure or two-measure pre-count sounds when you touch <b>[8] START/STOP</b> or play something on the keyboard while in record standby. If you start recording by touching <b>[8] START/STOP</b>, recording will start after the pre-count, along with playback of the rhythm pattern. If you start by playing something on the keyboard, recording will start after the pre-count, without playing the rhythm pattern.</p>
Metronome	<p>Specifies whether or not the metronome should sound during recording.                      On: Metronome sounds during recording.                      Off: Metronome does not sound during recording.</p>
Beat	<p>Specifies the metronome beat during recording.</p> <p>0: 1 beat. While the metronome is sounding during recording, all beats are a click sound.</p> <p>1: 1 beat. While the metronome is sounding during recording, all beats are a bell sound.</p> <p>2 to 9: 2 beats to 9 beats. Specifies the number of beats per measure. While the metronome is sounding during recording, the first beat of each measure is a bell sound while all remaining beats in the measure are a click sound.</p>

Displayed Setting	Description and Options
PunchInMeasure	<p>Specifies from which measure playback should start when performing punch-in recording (page EN-47). For example, if you want to re-record from measure 28, you could start playback from measure 24. That way you would need to listen to only four measures of recording before starting the punch-in operation. You can specify a measure number in the range of 001 (beginning of the song) to 999 (the maximum number of measures allowed in a song).</p>

### ■ To configure recording settings

1. Touch **[14] REC●**.  
 This enters record standby, indicated by **[14] REC●** flashing red.
2. Hold down the **[14] REC●** button until “[MIDI REC SETTING]” appears on the display.
3. Use the **[10] <** and **[11] >** buttons to display the item (“Precount”, “Metronome”, “Beat”, “PunchInMeasure”) whose setting you want to change and then touch **[12] ENTER**.
4. Use the **[10] -** and **[11] +** buttons to change the setting.
5. Touch **[15] EXIT**.
  - For multiple settings, repeat steps 3 through 5 above for each item you want to configure.
6. After the setting is the way you want, touch **[14] REC●**.

## Deleting a MIDI Recorder Song

Use the procedures in this section to delete a single song in its entirety, or a particular track of a song.

### ■ To delete a MIDI recorder song

1. Use the **[3]** mode selector button to cycle through settings until the “SONG” (SONG Mode) indicator is lit.
2. Use the **[10] -** and **[11] +** buttons to select the song number of the MIDI recorder song you want to delete.
  - Song numbers 11 through 15 are for songs recorded with the MIDI recorder. If necessary, you can touch **[8] ▶/■** to play back the song and check its contents.
3. Hold down the **[14] REC●** button until “Song Clear” appears on the display.
4. Touch **[12] ENTER**.  
This causes “Sure?” to appear on the display.
5. To delete the song, touch **[11] +**. To exit this operation without deleting anything, touch **[10] -**.

### ■ To delete a particular MIDI recorder track

1. Perform steps 1 through 3 under “To delete a MIDI recorder song” (page EN-49).
2. Use the **[10] <** and **[11] >** buttons to display “Track Clear” and then touch **[12] ENTER**.
3. Use the **[10] <** and **[11] >** buttons to display the track you want to delete.

To delete this track:	Display this:
System Track	System
Solo Track 1	Solo 1
Solo Track 2	Solo 2

4. Touch **[12] ENTER**.  
This displays “Sure?”
5. To delete the track, touch **[11] +**. To exit this operation without deleting anything, touch **[10] -**.

## Using the Audio Recorder to Record Performances

The audio recorder records Digital Piano keyboard play as audio data. Recordings are stored as WAV files (linear PCM, 16bit, 44.1kHz, stereo) to the USB flash drive in the Digital Piano’s USB flash drive port.

### ! IMPORTANT!

- Never remove the USB flash drive while Audio Recorder recording or playback is in progress. Doing so can corrupt the data on the USB flash drive and damage the USB flash drive port.
- For precautions when handling a USB flash drive, see “USB Flash Drive” (page EN-60).
- For information about the USB flash drive formats supported by your Digital Piano, see “Supported USB Flash Drives” (page EN-60).

### ■ To prepare to use the audio recorder

1. Perform the steps below to put the Digital Piano into the Audio Mode.\*
  - (1) Hold down the **[15] √** button until “[FUNCTION]” appears on the display.  
This enters the FUNCTION Mode.
  - (2) Use the **[10] <** and **[11] >** buttons to select the following menu items in sequence: “SONG” → “Song Type”.
  - (3) Use the **[10] -** and **[11] +** buttons to change the setting to “Audio”.
  - (4) To exit the FUNCTION mode, hold down **[15] EXIT** until “[FUNCTION]” disappears from the display.
2. Insert the USB flash drive into the Digital Piano’s **[26]** USB flash drive port.

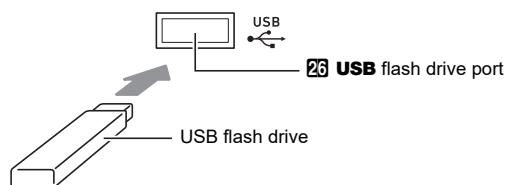

- Carefully push the USB flash drive in as far as it will go. Do not use undue force when inserting the USB flash drive.
- When the Digital Piano detects the USB flash drive, the message “MOUNTING” will appear on the display. Do not perform any operation while this message is displayed. Wait until it disappears.

\* Your Digital Piano has two recorders: a MIDI recorder and an audio recorder. Depending on the type of data you want to record or play back, you first need to select the MIDI Mode or Audio Mode.

■ To record a keyboard performance onto a USB flash drive

1. Perform the procedure under “To prepare to use the audio recorder” (page EN-49).
2. Touch **14 REC**.  
This enters record standby, indicated by **14 REC** flashing red.  
The Digital Piano will enter the RHYTHM Mode at this time if it is in the SONG Mode.
  - To cancel recording, touch **14 REC** again.
3. To start recording, play something on the keyboard or touch **3 START/STOP**.\*  
This causes **14 REC** to stop flashing and remain lit red, which indicates that recording is in progress.
  - \* Recording can also be started using other operations. For details, see “Operations that Start Recording” (page EN-45).

**NOTE**

- The maximum allowable recording time with the audio recorder is approximately 25 minutes, after which recording will stop automatically. **14 REC** will start to flash to let you know when you are running out of recording time, so end your recording as soon as possible after flashing starts.

4. To stop recording, touch **14 REC**.
  - This will store the recording as a WAV file to the USB flash drive. Files are automatically assigned names in sequence from “TAKE01.WAV” through “TAKE99.WAV”.
  - The Digital Piano will automatically switch to the SONG Mode with the file it just stored selected for playback.
5. To play back the song you just recorded, touch **8 ▶/■**.

■ To select and playback a file recorded with the audio recorder

1. Perform the procedure under “To prepare to use the audio recorder” (page EN-49).
2. Use the **3** mode selector button to cycle through settings until the “SONG” (SONG Mode) indicator is lit.
 

RHYTHM

ACCOMP

==

SONG
3. Use the **10 -** and **11 +** buttons to select the file you want to play.
4. To start playback, touch **3 ▶/■**.
  - Playback stops automatically when the end of the file is reached. To stop playback part way through, touch **3 ▶/■**.

■ To delete a file recorded with the audio recorder

1. Perform the procedure under “To prepare to use the audio recorder” (page EN-49).
2. Use the **3** mode selector button to cycle through settings until the “SONG” (SONG Mode) indicator is lit.
3. Use the **10 -** and **11 +** buttons to select the file you want to delete.
4. Hold down **14 REC** until “Sure?” appears on the display.
5. To delete the file, touch **11 +**. To exit this operation without deleting anything, touch **10 -**.

## Listening to Songs (MIDI Player)

Your Digital Piano has a MIDI player that can play back the MIDI file types described below.

### ■ Playable songs

Song Type	Description
User songs	You can add up to 10 songs to Digital Piano memory as user songs (Song Number 1 through 10). To add user song data (up to 320 KB per song of data that is playable by this Digital Piano), store it on a USB drive or smart device and then transfer the song data to Digital Piano memory. For details, see “ <a href="#">USB Flash Drive Operations</a> ” (page EN-62) and “ <a href="#">Linking with a Smart Device (APP Function)</a> ” (page EN-65).
MIDI recorder songs	Songs recorded with the Digital Piano’s MIDI recorder. See “ <a href="#">Using the MIDI Recorder to Record Performances</a> ” (page EN-43).
USB memory songs	Standard MIDI files (SMF format 0/1) or CASIO MIDI files (CMF format) stored on a USB flash drive. For information about how to store song data, see “ <a href="#">Using a Computer to Copy General Song Data to a USB Flash Drive</a> ” (page EN-65).

### ■ To select and play back a song

#### 1. If you want to play a song stored on a USB flash drive, insert the drive into the Digital Piano’s USB flash drive port.

- After mounting of the USB flash drive is complete, the Digital Piano will start to read a list of songs on the drive, which is indicated by the message “WAIT” on the display. Wait until the read operation is complete.
- For precautions when handling a USB flash drive, see “[USB Flash Drive](#)” (page EN-60).

#### 2. Use the mode selector button to cycle through settings until the “SONG” (SONG Mode) indicator is lit.

RHYTHM

ACCOMP



SONG







#### 3. Use the – and + buttons to select a song number.

Song Number	Song Type
1 to 10	User songs
11 to 15	MIDI recorder songs
16 to 999	USB memory songs

- Selecting some songs will initially cause “LOADING” to be displayed. This indicates that data is being loaded.

#### 4. To start playback of the selected song, touch ▶/■.

- The yellow and red LEDs above the  ▶/■ button will flash in time with the beat (yellow for beat 1, red for the remaining beats of each measure).
- The operations below can be performed while playback is in progress.

To do this:	Perform this operation:
Stop playback	Touch  ▶/■.
Pause playback	Touch    .
Change playback tempo (speed).	See “ <a href="#">Changing the Auto Accompaniment and Song Tempo</a> ” (page EN-38).
Skip forward one measure.	Touch  ▶▶.
Fast forward	Hold down  ▶▶▶.
Skip back one measure.	Touch  ◀◀.
Fast backward	Hold down  ◀◀◀.

- Playback ends automatically when the end of the song is reached.

■ **To play a song with one of hand parts muted (for practice of the muted part)**

**NOTE**

- This procedure can be used for a user song or a song on a USB flash drive.

1. Perform steps 1 and 2 under “**To select and play back a song**” (page EN-51).
2. If you want, you could use the procedure under “**Changing the Auto Accompaniment and Song Tempo**” (page EN-38) to specify the tempo.
3. Use the **4 PART** button to select the part you want to mute.
  - Each touch of **4 PART** cycles through the playback part settings. The currently selected playback part(s) is indicated by the “L” and “R” indicators that appear in the bottom of the display.

This indicator	Means this:
LR	Both the left- and right-hand parts play.
L	Just the left-hand part plays, with the right-hand part muted.
R	Just the right-hand part plays, with the left-hand part muted.
	Both the left- and right-hand parts muted.

4. To start playback, touch **8 ▶/■**.
  - Play the muted part along with the playback.
  - You can also change the tempo setting during playback.
  - Playback will stop automatically when the end of the song is reached. To stop playback of a song part way through, touch **8 ▶/■**.

**NOTE**

- When playing back a standard MIDI file (SMF format) stored on a USB flash drive, channel 3 will be assigned to the left-hand part while channel 4 will be assigned to the right-hand part.

■ **To import song settings as keyboard performance settings**

**NOTE**

- The procedure below can be used to import the settings below, which are recorded at the beginning of a selected song, as keyboard performance settings. Tempo, hall simulator/reverb settings (On/Off, type, depth), surround settings (MIDI recorder songs only), chorus type, brilliance setting (MIDI recorder songs only), scale setting (MIDI recorder songs only)

1. Perform steps 1 and 2 under “**To select and play back a song**” (page EN-51).
2. Hold down the **3** mode selector button until “**COMPLETE**” appears on the display.
  - This imports the settings of the selected song as keyboard performance settings.

■ **To delete a user song**

1. Use the **3** mode selector button to cycle through settings until the “**SONG**” (SONG Mode) indicator is lit.
2. Use the **10 -** and **11 +** buttons to select the song number (1 to 10) of the user song you want to delete.
  - If necessary, you can touch **8 ▶/■** to play back the song and check its contents.
3. Hold down the **14 REC●** button until “**Sure?**” appears on the display.
4. To delete the song, touch **11 +**. To exit this operation without deleting anything, touch **10 -**.

## Configuring Function Settings (FUNCTION Mode)

The FUNCTION Mode makes it possible to configure function settings using a menu format. There are two types of menu items: directories and parameters.

**Directory** : A directory is a group of multiple parameters.

**Parameter**: A parameter is an actual configurable setting. After you select the “Touch Response” parameter, for example, you can change its setting as desired.

The table below shows a representative example of some menu items provided in the FUNCTION Mode. Items marked “(DIR)” in the table are directories, while all of the other items are parameters.

Parameter Name or Directory Name	Display	Settings
Sound (DIR)	SOUND	–
Acoustic Simulator (DIR)	ACOUSTIC SIMU.	–
String Resonance	String Reso.	Tone, Off, 1 - 4
Damper Resonance	Damper Reso.	Tone, Off, 1 - 4
Damper Noise	Damper Noise	Tone, Off, 1 - 4
Key On Action Noise	Key On Noise	Tone, Off, 1 - 4
Key Off Action Noise	Key Off Noise	Tone, Off, 1 - 4
Effect (DIR)	EFFECT	–
Chorus Type	Chorus Type	Tone, 1 - 12
:	:	:

For a list of all the directories and parameters included in the FUNCTION Mode, See “[FUNCTION Mode Menu Items](#)” (page [EN-55](#)).

### ■ To change FUNCTION parameter settings

1. Referring to “[FUNCTION Mode Menu Items](#)” (page [EN-55](#)), check the parameters whose settings you want to change and their top directories.
2. Hold down the **[F5]** button until “[FUNCTION]” appears on the display.

This enters the FUNCTION Mode and displays its top menu.

- The FUNCTION Mode top menu screen shows “[FUNCTION]” in the top line, and the name of the currently selected directory in line 2. Directory names are all-caps.



Directory name

**3. Display the name of the parameter whose setting you want to change.**

• For example, to display the “Chorus Type” parameter, you need to navigate through multiple directories in the following sequence: “SOUND” (directory) → “EFFECT” (directory) → “Chorus Type” (parameter). Perform the procedure below.

- (1) Use the **F10 <** and **F11 >** buttons to display “SOUND” and then touch **F12 ENTER**.
  - This enters the “SOUND” directory.
- (2) Use the **F10 <** and **F11 >** buttons to display “EFFECT” and then touch **F12 ENTER**.
  - This enters the “EFFECT” directory.
- (3) Use the **F10 <** and **F11 >** buttons to display “Chorus Type”.
  - To exit the current directory and return to the level above it, touch **F15 EXIT**.

**4. After displaying the parameter name, touch **F12 ENTER**.**

This displays the parameter setting editing screen, with the parameter’s current setting shown in line 3.

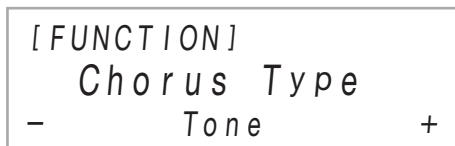

**5. Use the **F10 -** and **F11 +** buttons, or **K22 (K1)** knob to change the setting.**

• To return to the initial default setting, touch **F10 -** and **F11 +** at the same time.

**6. After the setting is the way you want, exit the parameter editing screen by touching **F15 EXIT**.**

**7. To exit the FUNCTION Mode, hold down **F15 EXIT** until “[FUNCTION]” disappears from the display.**

**NOTE**

• The above steps are the basic procedure of the FUNCTION Mode. Some items included in the FUNCTION Mode require operations that are different from those above. Refer to the information below.

For information about this item:	Go here:
Operation Lock	<a href="#">“Using Operation Lock”</a> (page EN-59)
Setting Reset	<a href="#">“To return all Digital Piano settings to their initial factory defaults (Setting Reset)”</a> (page EN-60)
Factory Reset	<a href="#">“To return all Digital Piano settings and data to their initial factory defaults (Factory Reset)”</a> (page EN-60)

## ■ FUNCTION Mode Menu Items

- For information about general procedures for changing the settings in the list below, see “To change FUNCTION parameter settings” (page EN-53).
- A function whose name has “(DIR)” at the end is a directory, which contains multiple sub-directories and parameters.

No.	Parameter Name or Directory Name	Display	Settings
1	Sound (DIR)	SOUND	–
2	Acoustic Simulator (DIR)	ACOUSTIC SIMU.	–
3	String Resonance	String Reso.	Tone, Off, 1 - 4
4	Damper Resonance	Damper Reso.	Tone, Off, 1 - 4
5	Damper Noise	Damper Noise	Tone, Off, 1 - 4
6	Key On Action Noise	Key On Noise	Tone, Off, 1 - 4
7	Key Off Action Noise	Key Off Noise	Tone, Off, 1 - 4
8	Effect (DIR)	EFFECT	–
9	Chorus Type	Chorus Type	See page EN-25
10	Brilliance	Brilliance	–3 - +3
11	Keyboard (DIR)	KEYBOARD	–
12	Touch Response	Touch Response	See page EN-19
13	Keyboard Volume	KeyboardVolume	0 - 127
14	Part Volume (DIR)	PART VOLUME	–
15	Upper1 Part	Upper1 Part	0 - 127
16	Upper2 Part	Upper2 Part	0 - 127
17	Lower Part	Lower Part	0 - 127
18	Part Octave Shift (DIR)	PART OCT SHIFT	–
19	Upper1 Part	Upper1 Part	–2, –1, 0, +1, +2
20	Upper2 Part	Upper2 Part	–2, –1, 0, +1, +2
21	Lower Part	Lower Part	–2, –1, 0, +1, +2
22	Part Fine Tuning (DIR)	PART FINE TUNE	–
23	Upper1 Part	Upper1 Part	–99 - 0 - +99
24	Upper2 Part	Upper2 Part	–99 - 0 - +99
25	Lower Part	Lower Part	–99 - 0 - +99
26	Scale Tuning (DIR)	SCALE TUNING	–
27	Scale Type	Scale Type	See page EN-30
28	Scale Base Note	Scale Base Note	C - B
29	Accompaniment Scale	Accomp Scale	On, Off
30	Duet (DIR)	DUET	–
31	Duet Mode	Duet Mode	Off, On, Pan
32	Right-Side Keyboard Octave	Upper Octave	–2 - +2
33	Left-Side Keyboard Octave	Lower Octave	–2 - +2



No.	Parameter Name or Directory Name	Display	Settings
34	Pedal/Wheel (DIR)	PEDAL/WHEEL	–
35	Damper pedal (DIR)	DAMPER PEDAL	–
36	Pedal Target	Pedal Target	See page <a href="#">EN-7</a>
37	Upper1 Part	Upper1 Part	On, Off
38	Upper2 Part	Upper2 Part	On, Off
39	Lower Part	Lower Part	On, Off
40	Expression/assignable pedal (DIR)	EXP/ASGN PEDAL	–
41	Pedal Type	Pedal Type	See page <a href="#">EN-9</a>
42	Pedal Target	Pedal Target	See page <a href="#">EN-9</a>
43	Upper1 Part	Upper1 Part	On, Off
44	Upper2 Part	Upper2 Part	On, Off
45	Lower Part	Lower Part	On, Off
46	Expression Pedal Calibration	Exp Calibration	See page <a href="#">EN-10</a>
47	Pedal Unit (DIR)	PEDAL UNIT	–
48	Upper1 Part	Upper1 Part	On, Off
49	Upper2 Part	Upper2 Part	On, Off
50	Lower Part	Lower Part	On, Off
51	Pitch Bend Wheel (DIR)	WHEEL	–
52	Pitch Bend Range	P Bend Range	0 - 24
53	Upper1 Part	Upper1 Part	On, Off
54	Upper2 Part	Upper2 Part	On, Off
55	Lower Part	Lower Part	On, Off
56	Registration (DIR)	REGISTRATION	–
57	Freeze Target (DIR)	FREEZE	–
58	Pedal/Wheel	Pedal/Wheel	On, Off
59	Knob	Knob	On, Off
60	Scale Tuning	Scale Tuning	On, Off
61	Touch Response	Touch Response	On, Off
62	Sound Mode	Sound Mode	On, Off
63	Effect	Effect	On, Off
64	Transpose	Transpose	On, Off
65	Split Point	Split Point	On, Off
66	Arpeggiator/Auto Harmonize	Arpeg./A.Harmo.	On, Off
67	Tempo	Tempo	On, Off
68	Auto Accompaniment	Accompaniment	On, Off
69	Tone	Tone	On, Off
70	Sequential Pedal Recall (DIR)	SEQ PED RECALL	–
71	Damper Pedal	Damper Pedal	Inc, Dec, Off
72	Expression/assignable Pedal	Exp/Asgn Pedal	Inc, Dec, Off

No.	Parameter Name or Directory Name	Display	Settings
73	Auto Accompaniment (DIR)	ACCOMPANIMENT	–
74	Accomp Volume	Accomp Volume	0 - 127
75	Chord Mode	Chord Mode	See page <a href="#">EN-34</a>
76	Music Preset Key Shift	MP Key Shift	–5 - 0 - +6
77	Arpeggiator/Auto Harmonize (DIR)	ARPEG./A.HARMO.	–
78	Type Select	Type Select	A.Harmonize, Arpeggiator
79	Arpeggio Hold	Arpeggio Hold	On, Off
80	Arpeggio Part	Arpeggio Part	Upper1&2, Upper1
81	Song (DIR)	SONG	–
82	Song Type	Song Type	MIDI, Audio
83	MIDI Song Metronome	MIDI Metronome	On, Off
84	MIDI Song Volume	MIDI Volume	0 - 127
85	Audio Song Volume	Audio Volume	0 - 127
86	Audio Song Center Cancel	Audio C Cancel	On, Off
87	Media (DIR)	MEDIA	See page <a href="#">EN-62</a>
88	MIDI (DIR)	MIDI	–
89	Keyboard Channel	Keyboard Chan	1 - 16
90	Local Control	Local Control	On, Off
91	Hi-Reso Velocity MIDI Out	Hi-Reso MIDI Out	On, Off
92	Accomp MIDI Out	Accomp MIDI Out	On, Off
93	Audio Input (DIR)	AUDIO IN	–
94	Bluetooth (DIR)	BLUETOOTH	–
95	Bluetooth Audio	Bluetooth Audio	On, Off
96	Pairing	Pairing	*1
97	Clear pairing information (Bluetooth connection logs)	Pairing Reset	*1
98	Audio Input Volume (Bluetooth / AUDIO IN jack)	Audio In Volume	0 - 127
99	Audio-In Center Cancel (Bluetooth / AUDIO IN jack)	Center Cancel	On, Off

No.	Parameter Name or Directory Name	Display	Settings
100	System (DIR)	SYSTEM	–
101	Tuning	Master Tuning	415.5 - 465.9
102	Panel Light Setting	Panel Light	Off, 5, 30, 60, 120 (Seconds)
103	Operation Lock	Operation Lock	On, Off
104	Speaker Out	Speaker Out	On, Off
105	Auto Resume	Auto Resume	On, Off
106	Auto Power Off	Auto Power Off	On, Off
107	Power On Alert	Power On Alert	On, Off
108	Tempo Indicator	Tempo Indicator	Letter, Icon*2
109	LCD Contrast	LCD Contrast	1 - 17
110	Touch Button Sensitivity	Touch Btn Sense	-1 - 0 - +1
111	Setting Reset	Setting Reset	See page <a href="#">EN-60</a>
112	Factory Reset	Factory Reset	See page <a href="#">EN-60</a>
113	Version Information	Version	–

\*1 Refer to the separate “Bluetooth, Audio Device, and Computer Connection Guide”.

\*2 Specify whether to use the letter T (Letter) or the icon ♩ (Icon) as the on-screen tempo indicator. The note icon displayed when “Icon” is selected does not indicate any note value.

## Using Operation Lock

Operation Lock disables button operations, except for the **F1** (Power) button and the button operations required to unlock operations.

### ■ To lock operations

1. Hold down the **F5**  $\nabla$  button until “[FUNCTION]” appears on the display.  
This enters the FUNCTION Mode.
2. Use the **F10**  $<$  and **F11**  $>$  buttons to select the following menu items in sequence: “SYSTEM” → “Operation Lock”.
3. Use the **F10**  $-$  and **F11**  $+$  buttons to change the displayed setting from “Off” to “On”.
4. To exit the FUNCTION mode, hold down **F5** **EXIT** until “[FUNCTION]” disappears from the display.

### ■ To unlock operations

1. Hold down the **F5**  $\nabla$  button until “[FUNCTION]” appears on the display.  
This enters the FUNCTION Mode.  
The display appears as shown below when an operation is locked.



2. Use the **F10**  $-$  and **F11**  $+$  buttons to change the displayed setting from “On” to “Off”.
3. To exit the FUNCTION mode, hold down **F5** **EXIT** until “[FUNCTION]” disappears from the display.

## Configuring MIDI Settings

Use the FUNCTION parameters below to change the Digital Piano's MIDI settings. For information about FUNCTION parameters, see “Configuring Function Settings (FUNCTION Mode)” (page EN-53).

Setting	FUNCTION Parameter
<b>Keyboard Channel</b> This setting specifies a channel from 1 through 16 as the MIDI channel that can be used for sending data to an external device.	Keyboard Chan (number <a href="#">89</a> )
<b>Local Control</b> When this setting is turned off, performance information (MIDI data) is sent from the Digital Piano, but no Digital Piano sound is output. This setting is for when you only want to send MIDI data to an external device.	Local Control (number <a href="#">90</a> )
<b>Hi-Reso Velocity MIDI Out</b> This setting enables/disables high-resolution MIDI output of touch pressure (velocity) when keyboard keys are pressed.	Hi-Reso MIDI Out (number <a href="#">91</a> )
<b>Accomp MIDI Out</b> Enabling this setting outputs Auto Accompaniment information as MIDI data.	Accomp MIDI Out (number <a href="#">92</a> )

## Deleting All Data in Digital Piano Memory

You can use the procedure below to delete all data, and reset settings and other system contents to return them to their initial factory defaults.

### ■ To return all Digital Piano settings and data to their initial factory defaults (Factory Reset)

#### IMPORTANT!

- This procedure also deletes user songs, MIDI recorder song data, and registration data. Saving important data to a USB flash drive (page EN-63) is recommended before performing this procedure.

1. Hold down the **[F5] ∇** button until “[FUNCTION]” appears on the display.
2. Use the **[F10] <** and **[F11] >** buttons to display “SYSTEM” and then touch **[F12] ENTER**.
3. Use the **[F10] <** and **[F11] >** buttons to display “Factory Reset” and then touch **[F12] ENTER**.  
This displays “Sure?”
4. To return the Digital Piano to its factory default settings, touch **[F11] +**. To cancel this operation without changing settings, touch **[F10] -**.

### ■ To return all Digital Piano settings to their initial factory defaults (Setting Reset)

You can use the FUNCTION Mode to return all Digital Piano settings to their initial factory defaults.

In step 3 of the procedure under “To return all Digital Piano settings and data to their initial factory defaults (Factory Reset)” (page EN-60), select “Setting Reset” in place of “Factory Reset” and then touch **[F12] ENTER**.

## USB Flash Drive

Your Digital Piano supports the use of a commercially available USB flash drive to perform the operations below.

### Playing Back Song Data from a USB Flash Drive

Standard song data (MIDI files) that has been stored on a USB flash drive with a computer can be played on your Digital Piano.

- For information about how to store song data on a USB flash drive, see “Using a Computer to Copy General Song Data to a USB Flash Drive” (page EN-65).
- For information about the song data playback operation, see “Listening to Songs (MIDI Player)” (page EN-51).

### Recording a Performance to a USB Flash Drive

See “Using the Audio Recorder to Record Performances” (page EN-49) for information about how to record audio data produced by performances on your Digital Piano to a USB flash drive.

### Saving and Importing Data

Data recorded with your Digital Piano (MIDI recorder songs, registration setups, etc.) can be stored on a USB flash drive. Data that has been stored with the Digital Piano, as well as other data that is supported by the Digital Piano (user songs, etc.) can be imported from a USB flash drive. For details, see “USB Flash Drive Operations” (page EN-62).

## Supported USB Flash Drives

Capacity: 32GB or less recommended

#### IMPORTANT!

- Operation of the above type of USB flash drive has been confirmed, but this does not guarantee operation.
- Use a FAT (FAT32 or exFAT) format USB flash drive.
- You may not be able to use a USB flash drive that is recognized as multiple drives on your computer.
- A USB flash drive that is recognized as a CD-ROM on your computer is not supported.
- A USB flash drive with an anti-virus function and/or security functions is not supported.

## USB Flash Drive and USB Flash Drive Port Handling Precautions

### IMPORTANT!

- Be sure to observe the precautions provided in the documentation that comes with the USB flash drive.
- Avoid using a USB flash drive under the conditions below. Such conditions can corrupt data stored on the USB flash drive.
  - Areas subjected to high temperature, high humidity, or corrosive gas
  - Areas subjected to strong electrostatic charge and digital noise
- Never remove the USB flash drive while data is being written to or loaded from it. Doing so can corrupt the data on the USB flash drive and damage the USB flash drive port.
- Never insert anything besides a USB flash drive into the USB flash drive port. Doing so creates the risk of malfunction.
- A USB flash drive can become warm after very long use. This is normal and does not indicate malfunction.
- Static electricity conducted to the USB flash drive port from your hand or from a USB flash drive can cause malfunction of the Digital Piano. If this happens, turn the Digital Piano off and then back on again.

### Copyrights

You are allowed to use recordings for your own personal use. Any reproduction of an audio or music format file, without the permission of its copyright holder, is strictly prohibited under copyright laws and international treaties. Also, making such files available on the Internet or distributing them to third parties, regardless of whether such activities are conducted with or without compensation, is strictly prohibited under copyright laws and international treaties. CASIO COMPUTER CO., LTD. shall not be held in any way liable for any use of this Digital Piano that is illegal under copyright laws.

## Connecting a USB Flash Drive to and Detaching It from the Digital Piano

### IMPORTANT!

- Never plug any other device besides a USB flash drive into the USB flash drive port.
- When you perform a USB flash drive operation or turn on the Digital Piano while a USB flash drive is plugged in, the Digital Piano initially needs to perform a “mounting” sequence to prepare for data exchange with the USB flash drive. Digital Piano operations may be momentarily disabled while a mounting sequence is being performed. The message “MOUNTING” is displayed while the USB flash drive is being mounted. It may take up to 10 or 20 seconds or even longer for a USB flash drive to be mounted. Do not attempt to perform any operation on the Digital Piano while a mounting sequence is in progress. A USB flash drive needs to be mounted each time it is connected to the Digital Piano.

### NOTE

- Mounting a USB flash drive on the Digital Piano will create a folder named MUSICDAT in the drive's root directory if a MUSICDAT folder does not already exist there. Use this folder when exchanging data between the Digital Piano and USB flash drive.

### ■ To connect a USB flash drive

1. As shown in the illustration below, insert the USB flash drive into the Digital Piano's **26** USB flash drive port.

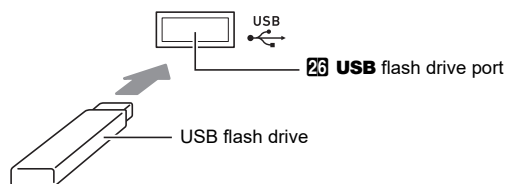

- Carefully push the USB flash drive in as far as it will go. Do not use undue force when inserting the USB flash drive.

### ■ To disconnect a USB flash drive

1. After checking to make sure that the message “MOUNTING” or “Wait” is not on the display (indicating a read or write operation being performed), pull the USB flash drive straight out of the USB flash drive port.

## Formatting a USB Flash Drive

### IMPORTANT!

- Be sure to format a USB flash drive on the Digital Piano before using it for the first time.
- Formatting a USB flash drive deletes all data currently stored on it. Before formatting a USB flash drive, make sure it does not have any valuable data stored on it.
- The format operation performed by this Digital Piano is a “quick format”. If you want to completely delete all of the data in USB flash drive, format it on your computer or some other device.
- In the case of an exFAT format USB flash drive, the number of importable files may be limited if long file names are used.

#### ■ To format a USB flash drive

1. Insert the USB flash drive to be formatted into the Digital Piano’s USB flash drive port.
2. Hold down the **[F5]** button until “[FUNCTION]” appears on the display.
3. Use the **[F10]** < and **[F11]** > buttons to display “[MEDIA]” and then touch **[F12]** ENTER.  
This enters the MEDIA Mode.
4. Use the **[F10]** < and **[F11]** > buttons to display “Format” and then touch **[F12]** ENTER.  
This displays “Sure?”
5. To execute the format, touch **[F11]** +.
  - To cancel the operation, touch **[F10]** –.
  - Touching **[F11]** + starts formatting and displays the message “Wait” (operation in progress). Do not perform any operation while this message is displayed. “Complete” is displayed after the operation is complete.
6. To exit the MEDIA mode, hold down **[F5]** EXIT until “[MEDIA]” disappears from the display.

## USB Flash Drive Operations

The section provides information about the operations below.

- Saving Digital Piano Data to a USB Flash Drive
- Importing Data (Files) from a USB Flash Drive to Digital Piano Memory
- Renaming Digital Piano Importable Data (Files) on a USB Flash Drive
- Deleting Digital Piano Importable Data (Files) on a USB Flash Drive

### ■ Data Types

Data types supported by your Digital Piano are those shown in the table below. The text in the “Displayed Type Name” column is displayed for the data type on the Digital Piano’s LCD.

#### ● Digital Piano → USB flash drive

The data below can be stored to a USB flash drive from Digital Piano memory.

Data Type	Displayed Type Name	File Name Extension
MIDI recorder song	Record Song	MRF, MID
Registration (Bank unit)	Reg Mem Bank	RBK
All user data in Digital Piano memory*	All	DAL

\* MIDI recorder song, Registration, User Song

#### ● USB Flash Drive → Digital Piano

The data below can be imported to Digital Piano memory from a USB flash drive.\* This data can also be renamed and deleted using Digital Piano operations.

Data Type	Displayed Type Name	File Name Extension
User Song	User Song	CMF, MID (SMF format 0/1)
MIDI recorder song	Record Song	MRF
Registration (Bank unit)	Reg Mem Bank	RBK
All the above data	All	DAL
Audio data*	Audio	WAV

\* Though audio data can be renamed and deleted, it cannot be imported into Digital Piano memory.

### IMPORTANT!

- Even if a file name has one of the extensions shown in the table below, you may not be able to import it into Digital Piano memory if the data was created with a non-compatible device, etc.

## ■ To save Digital Piano data to a USB flash drive

1. Insert the USB flash drive into the Digital Piano's USB flash drive port.
2. Hold down the **F5**  $\nabla$  button until "[FUNCTION]" appears on the display.
3. Use the **F10**  $<$  and **F11**  $>$  buttons to display "[MEDIA]" and then touch **F12** **ENTER**.  
This enters the MEDIA Mode.
4. Use the **F10**  $<$  and **F11**  $>$  buttons to display "Save" and then touch **F12** **ENTER**.
5. Use the **F10**  $<$  and **F11**  $>$  buttons to display a sub-menu item of options that correspond to the type of data being saved.
  - See the "Displayed Type Name" column in the table under "Digital Piano  $\rightarrow$  USB flash drive" (page EN-62).
6. Touch **F12** **ENTER**.
  - If "All" is selected in step 5, step 7 is not required. Proceed to step 8.
7. Use the **F10**  $-$  and **F11**  $+$  buttons to select the data to be saved, and then touch **F12** **ENTER**.  
This will display a default file name based on the type of data you selected.
  - If you selected "Record Song" in step 5 of this procedure, you must specify the file type here. Use the **F10**  $<$  and **F11**  $>$  buttons to display "MRF" (Digital Piano format) or "MID" (SMF format) and then touch **F12** **ENTER**.
8. Rename the file, if you want.
  - For information about text editing, see "Text Character Input" (page EN-13).
  - To exit text editing and return to step 7, touch **F15** **EXIT** while the **F10**  $<$  and **F11**  $>$  buttons are displayed (for cursor movement). If you previously made changes to the file name, the message "Cancel?" will appear. Touch **F11**  $+$  to exit editing.
9. To apply the new file name, touch **F21** **STORE**.  
This displays "Sure?"
  - The message "Replace?" will appear if there is already data with the same name in the MUSICDAT folder on the USB flash drive. If this happens, touching **F11**  $+$  in step 10 below will overwrite the existing data with the new data.
10. Touch **F11**  $+$  to save.
  - To cancel the operation, touch **F10**  $-$ .
  - Touching **F11**  $+$  displays "Wait" (operation in progress). Do not perform any operation while this message is displayed. "Complete" is displayed after the operation is complete.
11. To exit the MEDIA mode, hold down **F15** **EXIT** until "[MEDIA]" disappears from the display.

## ■ To load data from a USB flash drive to Digital Piano memory

1. Perform steps 1, 2, and 3 under "To save Digital Piano data to a USB flash drive" (page EN-63).
2. Use the **F10**  $<$  and **F11**  $>$  buttons to display "Load" and then touch **F12** **ENTER**.
3. Use the **F10**  $<$  and **F11**  $>$  buttons to display a sub-menu item of options that correspond to the type of data being imported.
  - See the "Displayed Type Name" column in the table under "USB Flash Drive  $\rightarrow$  Digital Piano" (page EN-62).
4. Touch **F12** **ENTER**.  
This displays a file name of data that can be imported.
5. Use the **F10**  $-$  and **F11**  $+$  buttons to select the data you want to import into Digital Piano memory.
  - If "All" is selected in step 3, steps 6 and 7 below are not required. Proceed to step 8.
6. Touch **F12** **ENTER**.
7. Use the **F10**  $-$  and **F11**  $+$  buttons to specify the number of the user area where imported data should be stored.
8. Touch **F12** **ENTER**.  
This causes "Sure?" or "Replace?" to appear on the display.
  - If "Replace?" appears, touching **F11**  $+$  in step 9 below will overwrite the existing user area data with the imported data.
9. Touch **F11**  $+$  to import.
  - To cancel the operation, touch **F10**  $-$ .
  - Touching **F11**  $+$  displays "Wait" (operation in progress). Do not perform any operation while this message is displayed. "Complete" is displayed after the operation is complete.
10. To exit the MEDIA mode, hold down **F15** **EXIT** until "[MEDIA]" disappears from the display.



### ■ To delete USB flash drive data

1. Perform steps 1, 2, and 3 under **“To save Digital Piano data to a USB flash drive”** (page EN-63).
2. Use the **[10] <** and **[11] >** buttons to display **“Delete”** and then touch **[12] ENTER**.
3. Use the **[10] <** and **[11] >** buttons to display a sub-menu item that correspond to the type of data being deleted, and then touch **[12] ENTER**.
  - See the “Displayed Type Name” column in the table under **“USB Flash Drive → Digital Piano”** (page EN-62).
4. Use the **[10] –** and **[11] +** buttons to select the data to be deleted, and then touch **[12] ENTER**. This displays **“Sure?”**
5. To delete the data, touch **[11] +**.
  - To cancel the operation, touch **[10] –**.
  - Touching **[11] +** displays **“Wait”** (operation in progress). Do not perform any operation while this message is displayed. **“Complete”** is displayed after the operation is complete.
6. To exit the MEDIA mode, hold down **[15] EXIT** until **“[MEDIA]”** disappears from the display.

### ■ To rename USB flash drive data

1. Perform steps 1, 2, and 3 under **“To save Digital Piano data to a USB flash drive”** (page EN-63).
2. Use the **[10] <** and **[11] >** buttons to display **“Rename”** and then touch **[12] ENTER**.
3. Use the **[10] <** and **[11] >** buttons to display a sub-menu item that correspond to the type of data being renamed, and then touch **[12] ENTER**.
  - See the “Displayed Type Name” column in the table under **“USB Flash Drive → Digital Piano”** (page EN-62).
4. Use the **[10] –** and **[11] +** buttons to select the data to be renamed, and then touch **[12] ENTER**.
5. Rename the file.
  - For information about text editing, see **“Text Character Input”** (page EN-13).
  - To exit text editing and return to step 4, touch **[15] EXIT** while the **[10] <** and **[11] >** buttons are displayed (for cursor movement). If you previously made changes to the file name, the message **“Cancel?”** will appear. Touch **[11] +** to exit editing.
6. To apply the new file name, touch **[21] STORE**. This displays **“Sure?”**
  - The message **“Replace?”** will appear if there is already data with the same name on the USB flash drive. If this happens, touching **[11] +** in step 7 below will overwrite the existing data with the new data.
7. To change the name, touch **[11] +**.
  - To cancel the operation, touch **[10] –**.
  - Touching **[11] +** displays **“Wait”** (operation in progress). Do not perform any operation while this message is displayed. **“Complete”** is displayed after the operation is complete.
8. To exit the MEDIA mode, hold down **[15] EXIT** until **“[MEDIA]”** disappears from the display.

## Using a Computer to Copy General Song Data to a USB Flash Drive

You can use the same operations as those for built-in songs to play back files of the formats below, which are stored in the MUSICDAT folder.

- Standard MIDI files (SMF format 0/1) or CASIO MIDI files (CMF format)

- 1. Connect the USB flash drive to your computer.**
- 2. Create a folder named MUSICDAT in the root directory of the USB flash drive.**
  - This step is not required if there is already a MUSICDAT folder in the USB flash drive's root directory.
- 3. Copy song data you want to play back on the Digital Piano to the MUSICDAT folder.**
  - For information about the song data playback operation, see "Listening to Songs (MIDI Player)" (page EN-51).

## Storing Standard Audio Data (WAV Files) to a USB Flash Drive

Performing a record operation with the Digital Piano's audio recorder creates a folder named MUSICDAT on the USB flash drive. WAV files are stored in the MUSICDAT folder, automatically assigning them names from TAKE01.WAV to TAKE99.WAV. You also can connect a USB flash drive to a computer and change the names of audio data (WAV) files to the format "TAKEXX\*.WAV", and move them to the MUSICDAT folder. Then you will be able to play them back on the Digital Piano.

\* XX = 01 to 99

Supported WAV format (Linear PCM, 16bit, 44.1 kHz, stereo)

## Linking with a Smart Device (APP Function)

You can use the APP Function to connect the Digital Piano with a phone, tablet or other smart device and perform the operations described below.

- Control the Digital Piano from a smart device (Piano Remote Controller)
- Transfer music data from a smart device

### ! IMPORTANT!

- Put the mobile device you will connect with into its **Airplane Mode** or otherwise disable device communications.
- When connecting a smart device to the Digital Piano, do not connect both a USB cable and an audio cable at the same time.

### ■ To download the smart device app

Download the Chordana Play for Piano app from the CASIO website and install it on the smart device.

<https://support.casio.com/global/en/emi/manual/PX-S3000/>



### ■ To link to a smart device

After installing the Chordana Play for Piano app on a smart device, use a commercially available USB cable to connect the smart device's USB port with the Digital Piano's USB port. After connecting the smart device to the Digital Piano, use the smart device app to perform operations. For details about operations, refer to the user documentation of the app.

# Troubleshooting

## ● Nothing happens when I touch a touch button.

### Cause:

- Wearing glove or touching with a fingernail or stylus.
- Incorrect touch button sensitivity setting.

### Action:

- When operating a touch button, touch it firmly with a bare finger.
- Perform the steps below to increase touch button sensitivity.
  - Turn off the Digital Piano.
  - While holding down the C8 keyboard key (the one on the far right), press the **1** **⏻** (Power) button.
    - Keep the C8 keyboard key depressed until the “Welcome” message appears on the display. You do not need to keep the **1** **⏻** (Power) button depressed.

## ● No sound is produced when I press a keyboard key.

### Cause:

- The **2** volume knob setting is too low.
- Headphones or an adaptor plug is plugged into one of the **24** **PHONES** jacks.
- MIDI Local control is turned off.
- The Digital Piano is in the Keyboard Controller Mode, so keys A0 through F1 are functioning as a “controller keys”.

### Action:

- Rotate the **2** volume knob.
- Disconnect whatever is connected to the **24** **PHONES** jacks.
- Turn on the Local control setting (page EN-59).
- Exit the Keyboard Controller Mode.

## ● The Digital Piano emits a loud sound and suddenly turns off.

### Action:

Replace the batteries with new ones or switch over to AC adaptor power (page EN-5).

## ● The pitch of the Digital Piano is off.

### Cause:

- The current transpose setting of the keyboard is something other than the default setting.
- The Digital Piano’s tuning setting is something other than “440.0Hz”.
- Octave shift is enabled.
- The current scale setting is something other than “Equal Temperament”.

### Action:

- Return transpose (page EN-19) to its initial default setting.
- Change the tuning setting to “440.0Hz” (page EN-20).
- Change the octave shift setting to 0 (page EN-20).
- Change the scale setting to “Equal Temperament”.

## ● Nothing happens when I press a pedal.

### Cause:

- The pedal cord is not connected correctly to the **27** **DAMPER PEDAL** jack, **23** **PEDAL UNIT** jack, or **31** **EXPRESSION/ASSIGNABLE** jack, or the plug is not plugged in completely.
- The wrong pedal type or function is assigned to the jack where the pedal is connected.

### Action:

- Confirm that the pedal cord is connected correctly, and that the plug is inserted as far as it will go.
- Configure settings correctly. See “**DAMPER PEDAL Jack**” (page EN-7) and “**EXPRESSION/ASSIGNABLE Jack**” (page EN-8).

## ● Nothing happens when I start an Auto Accompaniment.

### Cause:

- With rhythms 29 to 38 in the BALLAD category, nothing will sound if you do not play a chord on the keyboard.
- The Auto Accompaniment volume level is set to 0.
- Some error occurred.

### Action:

- Try playing a chord on the keyboard (page EN-32).
- Check the Auto Accompaniment volume level (page EN-18) and adjust it, if necessary.
- Try turning the Digital Piano off and then back on again (page EN-6), which will initialize its settings.

## ● Tones and/or effects sound strange. Note intensity does not change even though I alter key pressure. Turning power off and then back on again does not eliminate the problem.

### Cause:

Auto Resume is enabled.

### Action:

Disable Auto Resume (FUNCTION parameter 105). Next, turn the Digital Piano off and then back on again.

## ● I cannot transfer data after connecting the Digital Piano to a computer.

### Action:

- Check to make sure that the USB cable is connected to the Digital Piano and computer, and that the correct device is selected with your computer’s music software.
- Turn off the Digital Piano and then exit the music software on your computer. Next, turn the Digital Piano back on and then restart the music software on your computer.

● **A tone's quality and volume sounds slightly different depending where it is played on the keyboard.**

---

**Cause:**

This is an unavoidable result of the digital sampling process,\* and does not indicate malfunction.

\* Multiple digital samples are taken for the low range, middle range, and high range of the original musical instrument. Because of this, there may be very slight differences in tonal quality and volume between sample ranges.

---

● **Touching a button causes the note that is sounding cuts out momentarily or a slight change in how effects are applied.**

---

**Cause:**

This happens when the sounds of multiple parts are sounding at the same time while using layer, using the Duet Mode, playing back a built-in song, recording, etc. Pressing a button when one of these conditions exists will cause the effect setting that is built into the tone to change automatically, which causes notes to cut out momentarily or causes a slight change in how effects are being applied.

---

● **Abnormal sounds are produced only when I play on the left-side keyboard.**

---

**Cause:**

The Digital Piano is in the ACCOMP Mode, so the left-side keyboard functions as an accompaniment keyboard.

---

**Action:**

Use the mode selector button to enter the RHYTHM Mode.

---

## Error Messages

Display	Cause	Action
Limit	<ul style="list-style-type: none"> <li>You are attempting to record more than 999 measures with the MIDI recorder.</li> <li>You are attempting to record more than approximately 25 minutes with the audio recorder.</li> </ul>	<ul style="list-style-type: none"> <li>Keep MIDI recorder recordings up to 999 measures long.</li> <li>Keep audio recorder recordings within approximately 25 minutes.</li> </ul>
Memory Full	You are attempting a recording that exceeds the allowable per-song limit.	Keep song recordings with the allowable per-song limit.
Data Full	You are attempting to record more than 5 multi-track songs.	Delete some of the songs in memory.
No Media	The USB flash drive is not plugged correctly into the USB flash drive port.	Correctly plug the USB flash drive into the USB flash drive port.
	The USB flash drive was removed while some operation was in progress.	Do not remove the USB flash drive while any operation is in progress.
	The USB flash drive is write-protected.	Write-enable the USB flash drive.
	The USB flash drive is protected by anti-virus software.	Use a USB flash drive that is not protected by anti-virus software.
No File	There is no loadable or playable file in the MUSICDAT folder.	Move the file you want to load into the MUSICDAT folder or the file you want to play into the MUSICDAT folder (page <a href="#">EN-65</a> ).
Read Only	A read-only file with the same name you are trying to use is already stored on USB flash drive.	<ul style="list-style-type: none"> <li>Change the name and then save the new data.</li> <li>Remove the read-only attribute from the existing USB flash drive file and overwrite it with the new data.</li> <li>Use a different USB flash drive.</li> </ul>
Media Full	There is not enough space available on the USB flash drive.	Delete some of the files on the USB flash drive to make room for new data or use a different USB flash drive.
Too Many Files	You are attempting to start a record operation with the audio recorder when there are already 99 audio recorder songs in the MUSICDAT folder. This error occurs whenever there is a file named TAKE99.WAV (page <a href="#">EN-50</a> ) in the MUSICDAT folder on the USB flash drive.	Use a computer to move files named TAKE01.WAV through TAKE99.WAV from the MUSICDAT folder to another folder or drive.
Not SMF 0/1	You are attempting to play back SMF Format 2 song data.	Playback of SMF Format 0 or Format 1 only is supported.
Large Size	The SMF file on the USB flash drive cannot be played because it is too big.	Playback of SMF files up to approximately 320 KB in size is supported.
Wrong Data	The USB flash drive data is corrupted.	–
Version	The USB flash drive file version is not supported by the Digital Piano.	Use a file whose version is supported by the Digital Piano.
Format	The USB flash drive format is not compatible with this Digital Piano.	<ul style="list-style-type: none"> <li>Use a computer or other device to change the USB flash drive format to something that is compatible with the Digital Piano (page <a href="#">EN-62</a>).</li> <li>Use a different USB flash drive.</li> </ul>
	USB flash drive memory is corrupted.	Use a different USB flash drive.

# Reference

## Product Specifications

<b>Model</b>	PX-S3000BK
<b>Keyboard</b>	88-key piano keyboard
Duet	Adjustable tone range (-2 to +2 octaves)
Transpose	-12 to 0 to +12 semitones
Octave shift	-2 to 0 to +2 octaves
<b>Sound Source</b>	
Number of Tones	700, Layer, Split
Maximum polyphony	192 notes
Touch Response	5 sensitivity levels, Off
Tuning	415.5Hz to 440.0Hz to 465.9Hz (0.1Hz units)
Temperament	Equal temperament plus 16 other types
<b>Acoustic Simulator</b>	Hammer response, Key off response, String resonance, Damper resonance, Damper noise, Key on action noise, Key off action noise
<b>Sound Mode</b>	Hall simulator (4 types), Reverb (8 types), Surround (2 types)
<b>Other Effects</b>	Chorus (12 types), DSP (built in to some tones + 100 presets, editable), Brilliance (-3 to 0 to 3)
<b>Demo Song</b>	6
<b>Playback Function (SONG Mode)</b>	
In the MIDI Mode	Downloaded (user) song playback <ul style="list-style-type: none"> <li>• Storage of up to 10 songs in built-in flash memory</li> <li>• Up to approximately 320KB per song (Based on 1KB = 1024 bytes, 1MB = 1024<sup>2</sup> bytes)</li> </ul> MIDI recorder song playback USB flash drive song data (SMF) playback Part mute: L, R, L+R
In the Audio Mode	Audio recorder recording and playback Center cancel
Song Volume	Adjustable (for both MIDI Mode, Audio Mode)
<b>MIDI Recorder</b>	Real-time recording and playback as MIDI data
Number of Songs	5
Number of Tracks	3
Capacity	Approximately 30,000 notes per song (total of three tracks)
Data storage	Built-in flash memory
<b>Audio Recorder</b>	Real-time recording and playback as audio data
Number of songs	99 (files)
File format	WAV (linear PCM, 16bit, 44.1kHz, stereo)
Maximum recording time	Approximately 25 minutes per file
Recording medium	USB Flash Drive
<b>Auto Accompaniment</b>	
Built-in Rhythms	200
One Touch Preset	200
Auto Harmonize	12 types
Auto Accompaniment Volume Level	Adjustable
<b>Music Preset</b>	310
<b>Arpeggiator</b>	100 types
<b>Metronome</b>	Provided as rhythm type
Beat bell	Off, 1 to 9 (beats)
Tempo Range	20 to 255
Metronome Volume Level	Adjustable (as Auto Accompaniment volume level)
<b>Registration Function</b>	96 sets maximum (4 sets, 24 banks)

Reference

<b>Pedals</b>	
DAMPER PEDAL jack	For connection of the included pedal (SP-3) or a separately available CASIO sustain pedal, selectable function (sustain (off, on), sostenuto (off, on), soft (off, on), arpeggio hold (off, on), play/stop, fill-in)
PEDAL UNIT jack	For connection of a separately available pedal unit (SP-34), simultaneous use of three pedals (Sustain (off, half, on), sostenuto (off, on), soft (off, on))
EXPRESSION/ASSIGNABLE jack	For connection of a separately available expression pedal, the included pedal (SP-3), or a separately available CASIO sustain pedal, selectable function (expression, master volume, tempo, layer balance, sustain (off, on), sostenuto (off, on), soft (off, on), arpeggio hold (off, on), play/stop, fill-in)
<b>Other Functions</b>	
Auto Resume, Operation Lock	
<b>Bluetooth Connection</b>	
Bluetooth Version	5.0
Supported Profile	A2DP
Supported Codecs	SBC
Wireless Output	Bluetooth Class 2
Transmission Frequency Range	2402 to 2480 MHz
Maximum Wireless Output	4 dBm
<b>MIDI</b>	
16-channel multi-timbre receive	
<b>Pitch Bend Wheel</b>	
Pitch bend range: 0 to 24 semitones	
<b>Knobs</b>	
2 Knob sets (knob function presets): 14	
<b>Inputs/Outputs</b>	
PHONES jacks	Stereo mini jacks (3.5mm) × 2
Power	12V DC
AUDIO IN jack	Stereo mini jack (3.5mm) Input impedance: 10kΩ Input voltage: 200mV
LINE OUT R, L/MONO jacks	Standard jacks (6.3mm) × 2 Output impedance: 2.3kΩ Output voltage: 1.3V (RMS) MAX
USB port	Type B
USB flash drive port	Type A
DAMPER PEDAL jack	Standard jack (6.3mm)
EXPRESSION/ASSIGNABLE jack	Standard jack (6.3mm)
PEDAL UNIT jack	Proprietary jack
<b>Acoustics</b>	
Amp output	8W + 8W
Speakers	16cm × 8cm (oval) × 2
<b>Power Supply</b>	
Batteries	2-way 6 AA-size alkaline batteries Continuous Operation: Approximately 2 hours Playback of built-in demo tunes on alkaline batteries Actual continuous operation time may be shorter due to battery type and performance type.
AC Adaptor	AD-A12150LW
Auto Power Off	Approximately four hours (under AC adaptor power) or six minutes (under battery power) after last operation, can be disabled.
<b>Power Consumption</b>	
12V $\overline{\text{---}}$ 15W	
<b>Dimensions</b>	
132.2 (W) × 23.2 (D) × 10.2 (H) cm (52 1/16 × 9 1/8 × 4 inch)	
<b>Weight</b>	
Approximately 11.4kg (25.1 lbs) (without batteries)	

• Specifications and designs are subject to change without notice.

## Fingering Guide

### ■ FINGERED 1, FINGERED 2 Chords

<b>C</b>	
<b>Cm</b>	
<b>Cdim</b>	
<b>Caug</b> *3	
<b>Cb5</b>	
<b>Csus4</b> *3	
<b>Csus2</b> *3	
<b>C7</b>	
<b>Cm7</b> *3	
<b>CM7</b>	
<b>CmM7</b>	
<b>Cdim7</b> *3	
<b>CdimM7</b>	
<b>C7b5</b> *3	
<b>Cm7b5</b> *3	
<b>CM7b5</b>	
<b>Caug7</b>	
<b>CaugM7</b>	
<b>C7sus4</b>	
<b>C6</b> *1 *3	
<b>Cm6</b> *2 *3	

<b>Cadd9</b>	
<b>Cmadd9</b>	
<b>C69</b> *3	
<b>Cm69</b> *3	
<b>C7(b9)</b>	
<b>C7(9)</b>	
<b>C7(#9)</b>	
<b>C7(#11)</b>	
<b>C7(b13)</b>	
<b>C7(13)</b>	
<b>Cm7(9)</b>	
<b>Cm7(11)</b> *3	
<b>CM7(9)</b>	
<b>CmM7(9)</b>	
<b>C5</b> *5	
<b>C8</b> *6	

\*1 With FINGERED 2, interpreted as Am7.

\*2 With FINGERED 2, interpreted as Am7<sup>5</sup>.

\*3 Inverted form not supported in some cases.

\*4 These fingerings are special fingerings for Digital Piano chord input, and so they are not suitable for normal keyboard play.

\*5 Chord consisting of root and 5th only.

\*6 Not a standard chord, but used when you want Auto Accompaniment with the root note only, or the root with an octave added.



## ■ FINGERED ON BASS, FULL RANGE CHORD

In addition to the chords that can be fingered with FINGERED 1 and FINGERED 2, the chords below also are recognized.

$\frac{C\#}{C}$	$\cdot$	$\frac{D}{C}$	$\cdot$	$\frac{F}{C}$	$\cdot$	$\frac{F\#}{C}$	$\cdot$	$\frac{G}{C}$	$\cdot$	$\frac{A^b}{C}$	$\cdot$	$\frac{A}{C}$	$\cdot$	$\frac{B^b}{C}$	$\cdot$	$\frac{C\#m}{C}$	$\cdot$	$\frac{Dm}{C}$	$\cdot$	$\frac{Fm}{C}$	
$\frac{F\#m}{C}$	$\cdot$	$\frac{Gm}{C}$	$\cdot$	$\frac{A^bm}{C}$	$\cdot$	$\frac{Am}{C}$	$\cdot$	$\frac{B^bm}{C}$	$\cdot$	$\frac{Bm}{C}$	$\cdot$	$\frac{C\#dim}{C}$	$\cdot$	$\frac{Ddim}{C}$							
$\frac{Fdim}{C}$	$\cdot$	$\frac{F\#dim}{C}$	$\cdot$	$\frac{Gdim}{C}$	$\cdot$	$\frac{A^bdim}{C}$	$\cdot$	$\frac{Adim}{C}$	$\cdot$	$\frac{Bdim}{C}$	$\cdot$	$\frac{F7}{C}$	$\cdot$	$\frac{A^b7}{C}$							
$\frac{Fm7}{C}$	$\cdot$	$\frac{FM7}{C}$	$\cdot$	$\frac{A^bM7}{C}$	$\cdot$	$\frac{F\#m7^{b5}}{C}$	$\cdot$	$\frac{Gm7}{C}$	$\cdot$	$\frac{G7}{C}$	$\cdot$	$\frac{A^badd9}{C}$									

### NOTE

- With FINGERED ON BASS, the lowest note fingered is interpreted as the base note. Inverted forms are not supported.
- With FULL RANGE CHORD, when the lowest note fingered is a certain distance from the neighboring note, the chord is interpreted as a fraction chord.
- Unlike FINGERED 1, 2, and FINGERED ON BASS, FULL RANGE CHORD requires pressing of at least three keys to form a chord.

## Chord Example List

*1 *2	C	C <sup>#</sup> /(D <sup>b</sup> )	D	(D <sup>#</sup> )/E <sup>b</sup>	E	F
M						
m						
dim						
aug						
sus4						
sus2						
7						
m7						
M7						
m7 <sup>b</sup> 5						
7 <sup>b</sup> 5						
7sus4						
add9						
madd9						
mM7						
dim7						
69						
6						
m6						

• You can use the split point to change the size of the accompaniment keyboard range (page EN-16). \*1 Root \*2 Chord Type

*1 *2	F#/(G <sup>b</sup> )	G	(G#)/A <sup>b</sup>	A	(A#)/B <sup>b</sup>	B
M						
m						
dim						
aug						
sus4						
sus2						
7						
m7						
M7						
m7 <sup>b5</sup>						
7 <sup>b5</sup>						
7sus4						
add9						
madd9						
mM7						
dim7						
69						
6						
m6						

• You can use the split point to change the size of the accompaniment keyboard range (page EN-16). \*1 Root \*2 Chord Type

## Versatile Tone Map

### OTHERS: 056 VERSATILE NYLON GUITAR

Key	Velocity	Sound
C-1 - B6	1-30	Normal mp
	31-60	Normal mf
	61-75	Ghost Note
	76-90	Mute
	91-105	Hammering
	106-120	Glissando
	121-127	Open Harmonics
C7	1-127	Strum 1
C#7	1-127	Strum 2
D7	1-127	Strum 3
Eb7	1-127	Strum 4
E7	1-127	Strum 5
F7	1-127	Strum 6
F#7	1-127	Strum 7
G7	1-127	Strum 8
Ab7	1-127	Strum 9
A7	1-127	Strum 10
Bb7	1-127	Strum 11
B7	1-127	Strings Slap 1
C8	1-127	Strings Slap 2
C#8	1-127	Strings Slap 3
D8	1-127	Strings Slap 4
Eb8	1-127	Strings Slap 5
E8	1-127	Body 1
F8	1-127	Body 2
F#8	1-127	Body 3
G8	1-127	Body 4
Ab8	1-127	Body 5
A8	1-127	Body 6
Bb8	1-127	Body 7
B8	1-127	Body 8
C9	1-127	Fret Noise 1
C#9	1-127	Fret Noise 2
D9	1-127	Fret Noise 3
Eb9	1-127	Fret Noise 4
E9	1-127	Fret Noise 5
F9	1-127	Head String1
F#9	1-127	Head String2
G9	1-127	Head String3

### OTHERS: 057 VERSATILE STEEL GUITAR

Key	Velocity	Sound
C-1 - B6	1-30	Normal mp
	31-60	Normal mf
	61-75	Ghost Note
	76-90	Mute
	91-105	Hammering
	106-120	Glissando
	121-127	Open Harmonics
C7	1-127	Strum 1
C#7	1-127	Strum 2
D7	1-127	Strum 3
Eb7	1-127	Strum 4
E7	1-127	Strum 5
F7	1-127	Strum 6
F#7	1-127	Strum 7
G7	1-127	Strum 8
Ab7	1-127	Strum 9

A7	1-127	Strings Slap 1
Bb7	1-127	Strings Slap 2
B7	1-127	Strings Slap 3
C8	1-127	Strings Slap 4
C#8	1-127	Strings Slap 5
D8	1-127	Strings Slap 6
Eb8	1-127	Strings Slap 7
E8	1-127	Body 1
F8	1-127	Body 2
F#8	1-127	Body 3
G8	1-127	Body 4
Ab8	1-127	Body 5
A8	1-127	Body 6
Bb8	1-127	Body 7
B8	1-127	Body 8
C9	1-127	Fret Noise 1
C#9	1-127	Fret Noise 2
D9	1-127	Fret Noise 3
Eb9	1-127	Fret Noise 4
E9	1-127	Fret Noise 5
F9	1-127	Head String1
F#9	1-127	Head String2
G9	1-127	Head String3

### OTHERS: 058 VERSATILE SINGLE COIL E.GUITAR

Key	Velocity	Sound
C-1 - B6	1-30	Normal mp
	31-60	Normal mf
	61-75	Ghost Note
	76-90	Mute
	91-105	Hammering
	106-120	Glissando
	121-127	Open Harmonics
C7	1-127	Strum 1
C#7	1-127	Strum 2
D7	1-127	Strum 3
Eb7	1-127	Strum 4
E7	1-127	Strum 5
F7	1-127	Strum 6
F#7	1-127	Strum 7
G7	1-127	Strum 8
Ab7	1-127	Strum 9
A7	1-127	Strum 10
Bb7	1-127	Strum 11
B7	1-127	Strum 12
C8	1-127	Strum 13
C#8	1-127	Strum 14
D8	1-127	Low Ghost Note 1
Eb8	1-127	Low Ghost Note 2
E8	1-127	Low Ghost Note 3
F8	1-127	Low Ghost Note 4
F#8	1-127	Low Ghost Note 5
G8	1-127	Low Ghost Note 6
Ab8	1-127	Low Ghost Note 7
A8	1-127	Low Ghost Note 8
Bb8	1-127	Low Ghost Note 9
B8	1-127	Low Ghost Note 10
C9	1-127	Fret Noise 1
C#9	1-127	Fret Noise 2

D9	1-127	Fret Noise 3
Eb9	1-127	Fret Noise 4
E9	1-127	Fret Noise 5
F9	1-127	Fret Noise 6
F#9	1-127	Fret Noise 7
G9	1-127	Fret Noise 8

### OTHERS: 107 VERSATILE ELECTRIC BASS 1

Key	Velocity	Sound
C-1 - B6	1-60	Normal mf
	61-80	Normal ff
	81-120	Ghost Note
	121-127	Slap
C7	1-127	Gliss 1
C#7	1-127	Gliss 2
D7	1-127	Gliss 3
Eb7	1-127	Gliss 4
E7	1-127	Gliss 5
F7	1-127	Gliss 6
F#7	1-127	Gliss 7
G7	1-127	Fret Noise 1
Ab7	1-127	Fret Noise 2

### OTHERS: 108 VERSATILE ELECTRIC BASS 2

Key	Velocity	Sound
C-1 - B6	1-60	Normal mf
	61-80	Normal ff
	81-120	Ghost Note
	121-127	Slap
C7	1-127	Gliss 1
C#7	1-127	Gliss 2
D7	1-127	Gliss 3
Eb7	1-127	Gliss 4
E7	1-127	Gliss 5
F7	1-127	Gliss 6
F#7	1-127	Gliss 7
G7	1-127	Fret Noise 1
Ab7	1-127	Fret Noise 2

### OTHERS: 144 VERSATILE BRASS 1

Key	Velocity	Sound
C-1 - G9	1-20	Normal mf
	21-40	Normal f
	41-60	Normal ff
	61-80	Attack
	81-90	Schoop
	91-100	Shake
	101-110	Falls Fast mf
	111-120	Falls Fast f
	121-127	Gliss up

### OTHERS: 145 VERSATILE BRASS 2

Key	Velocity	Sound
C-1 - G9	1-30	Normal f
	31-60	Normal ff
	61-75	Attack
	76-90	Schoop
	91-105	Shake
	106-120	Falls Fast f
	121-127	Gliss up

## Knob Set List

No.	Knob Set (displayed)	(K1) knob		(K2) knob		Applicable Part
		Parameter	Freeze* <sup>1</sup>	Parameter	Freeze* <sup>1</sup>	
1	Filter	Cut Off Frequency	Knob	Resonance	Knob	Upper1
2	Brilliance/Rev	Brilliance	Effect	Reverb Send	Knob	Upper1
3	Up1 Cho/Rev	Chorus Send	Effect	Reverb Send	Sound Mode	Upper1
4	Amp Envelope	Attack Time	Knob	Release Time	Knob	Upper1
5	Vibrato	Vibrato Rate	Knob	Vibrato Depth	Knob	Upper1
6	Delay Vibrato	Delay Vibrato Time	Knob	Vibrato Depth	Knob	Upper1
7	Porta./Mod.	Portamento Time	Knob	Modulation Depth	Knob	Upper1
8	Layer Modify	Layer Volume Balance	Tone	Upper2 Fine Tune	Knob	Upper1, Upper2
9	Layer Panning	Upper1 Pan	Knob	Upper2 Pan	Knob	Upper1, Upper2
10	Lower Modify	Lower Volume	Tone	Lower Pan	Knob	Lower
11	Kbd Cho/Rev	Keyboard Chorus Send	Effect	Keyboard Reverb Send	Sound Mode	Upper1, Upper2, Lower
12	Kbd/Acmp Vol.	Keyboard Volume	Tone	Accompaniment Volume	Accompaniment	Upper1, Upper2, Lower
13	Kbd/Song Vol.	Keyboard Volume	Tone	Song Volume	–	Upper1, Upper2, Lower
14	DSP Param.* <sup>2</sup>	DSP Parameter 1	Tone	DSP Parameter 2	Tone	Upper1

\*1 Names of parameters included in the 57 “FREEZE” directory (“Freeze Function”, page EN-42). If you do not want settings made with the knobs to be replaced when a registration function setup is recalled, select “On” as the settings of the FUNCTION parameters in this column (Knob: 59, Effect: 63, Tone: 69, Accompaniment: 68).

For information about FUNCTION parameters, see “Configuring Function Settings (FUNCTION Mode)” (page EN-53).

\*2 The parameters affected by this knob set are two parameters that are automatically selected as being the most applicable to the currently selected DSP (“Using a DSP”, page EN-23). DSP Parameter 1 and DSP Parameter 2 are fixed according to the selected DSP. For example, when preset DSP “15. Auto Pan” is selected, DSP Parameter 1 is LFO Waveform, and DSP Parameter 2 is LFO Rate.

## DSP Effect List

### Preset DSP List

No.	DSP Name (Display)	Module 1	Module 2	Module 3	Module 4
1	Mono 1BandEQ	Mono 1-Band EQ			
2	Mono 2BandEQ	Mono 2-Band EQ			
3	Mono 3BandEQ	Mono 3-Band EQ			
4	Stereo1BndEQ	Stereo 1-Band EQ			
5	Stereo2BndEQ	Stereo 2-Band EQ			
6	Stereo3BndEQ	Stereo 3-Band EQ			
7	Tone Control	Tone Control			
8	Compressor	Compressor			
9	Limiter	Limiter			
10	Enhancer	Enhancer			
11	Phaser	Phaser			
12	Chorus	Chorus			
13	Flanger	Flanger			
14	Tremolo	Tremolo			
15	Auto Pan	Auto Pan			
16	Rotary	Rotary			
17	Drive Rotary	Drive Rotary			
18	LFO Wah	LFO Wah			
19	Auto Wah	Auto Wah			
20	Modeling Wah	Modeling Wah			
21	Pitch	Pitch Shifter			
22	Ring Mod	Ring Modulator			
23	Piano Effect	Piano Effect			
24	Distortion	Distortion			
25	Drive	Drive	Tone Control		
26	Amp Cab	Amp Cab			
27	Re-Amp 1	Compressor	Amp Cab	Enhancer	Tone Control
28	Re-Amp 2	Compressor	Limiter	Amp Cab	Delay
29	Re-Amp 3	Compressor	Limiter	Amp Cab	Mono 2-Band EQ
30	Re-Amp 4	Compressor	Limiter	Amp Cab	Delay
31	Re-Amp 5	Distortion	Delay		
32	Drive Amp 1	Mono 3-Band EQ	Drive	Tone Control	Amp Cab
33	Drive Amp 2	Drive	Tone Control	Amp Cab	Tremolo
34	Drive Amp 3	Drive	Tone Control	Amp Cab	AutoPan
35	Drive Amp 4	Drive	Tone Control	Amp Cab	Phaser
36	Drive Amp 5	Drive	Tone Control	Amp Cab	Flanger
37	Drive Amp 6	Drive	Tone Control	Amp Cab	Pitch Shifter
38	OctaveDrvAmp	Pitch Shifter	Drive	Tone Control	Amp Cab
39	PhaseDrvAmp	Phaser	Drive	Tone Control	Amp Cab
40	DelayDrvAmp	Drive	Tone Control	Amp Cab	Delay
41	Comp Amp 1	Compressor	Drive	Mono 1-Band EQ	Amp Cab
42	Comp Amp 2	Drive	Compressor	Mono 1-Band EQ	Amp Cab
43	Deley OD Amp	Drive	Enhancer	Amp Cab	Delay
44	Wah Drv Amp	Modeling Wah	Drive	Amp Cab	
45	DelayWahAmp	LFO Wah	Drive	Amp Cab	Delay
46	Auto Wah Amp	Auto Wah	Drive	Amp Cab	Delay
47	DriveAmpMod1	Drive	Amp Cab	Phaser	Flanger
48	DriveAmpMod2	LFO Wah	Drive	Amp Cab	Tremolo
49	S/H DriveAmp	LFO Wah	Drive	Amp Cab	Auto Pan
50	PhaseDrvAmp2	Drive	Amp Cab	Phaser	Delay
51	FlngrDelyAmp	Drive	Amp Cab	Flanger	Delay

No.	DSP Name (Display)	Module 1	Module 2	Module 3	Module 4
52	PitchModAmp	Drive	Amp Cab	Pitch Shifter	Delay
53	Drive Rotary	Drive	Rotary		
54	DrvRotaryEQ	Drive Rotary	Stereo 3-Band EQ		
55	DrvRotaryPan	Drive Rotary	Auto Pan		
56	PhaserAmpPan	Drive	Amp Cab	Phaser	Auto Pan
57	FlangrAmpPan	Drive	Amp Cab	Flanger	Auto Pan
58	ReflectAmpPan	Drive	Amp Cab	Reflection	Auto Pan
59	DualDriveAmp	Drive	Drive	Mono 2-Band EQ	Amp Cab
60	DualDrvAmpDI	Drive	Drive	Amp Cab	Delay
61	BassAmpAmbi	Tone Control	Compressor	Amp Cab	Delay
62	Comp Ambi 1	Tone Control	Compressor	Enhancer	Reflection
63	Comp Ambi 2	Tone Control	Compressor	Amp Cab	Delay
64	Comp Ambi 3	Drive	Compressor	Amp Cab	Delay
65	Comp Ambi 4	Drive	Compressor	Amp Cab	Delay
66	EnhanceAmbi1	Drive	Enhancer	Amp Cab	Delay
67	EnhanceAmbi2	Drive	Reflection	Amp Cab	Delay
68	Comp Mod 1	Tone Control	Compressor	Tremolo	Tone Control
69	Comp Mod 2	Tone Control	Compressor	Phaser	Reflection
70	Comp Mod 3	Tone Control	Compressor	Flanger	Phaser
71	Comp Mod 4	Compressor	Tremolo	Flanger	Delay
72	Comp Mod 5	Compressor	Tremolo	Phaser	Delay
73	EQ Mod 1	Tone Control	Tone Control	Phaser	Amp Cab
74	EQ Mod 2	Tone Control	Flanger	Tone Control	Delay
75	EQ Mod 3	Tone Control	Chorus	Tone Control	Delay
76	EQ Mod 4	Tone Control	Tremolo	Chorus	Delay
77	Double Phase	Amp Cab	Phaser	Phaser	Enhancer
78	DoubleFlang1	Amp Cab	Flanger	Flanger	Tone Control
79	DoubleFlang2	Amp Cab	Flanger	Flanger	Phaser
80	Tremolo Spin	Tremolo	Drive Rotary	Tone Control	
81	AmbientEnh 1	Enhancer	Reflection	Delay	Tone Control
82	AmbientEnh 2	Tone Control	Enhancer	Reflection	Delay
83	AmbientEnh 3	Tone Control	Drive	Amp Cab	Delay
84	AmbientEnh 4	Piano Effect	Delay	Tone Control	
85	AmbientEnh 5	Enhancer	Delay	Tone Control	
86	AmbientEnh 6	Drive	Delay	Tone Control	
87	Pitch Delay	Delay	Pitch Shifter	Phaser	Auto Pan
88	ReflectDelay	Reflection	Enhancer	Auto Pan	Delay
89	Drive Delay	Drive	Delay	Tone Control	
90	Pitch Mod 1	Tone Control	Phaser	Delay	Pitch Shifter
91	Pitch Mod 2	Pitch Shifter	Delay	Phaser	Tone Control
92	Double Enhan	Amp Cab	Enhancer	Enhancer	
93	Drive Enhan	Drive	Enhancer	Enhancer	
94	Reflection 1	Reflection	Delay	Tone Control	
95	Reflection 2	Delay	Reflection	Enhancer	Tone Control
96	Mod Tremolo	Phaser	Chorus	Flanger	Tremolo
97	Wah Phase	LFO Wah	Phaser	Delay	Tone Control
98	Wah Flanger	Flanger	Flanger	LFO Wah	Tone Control
99	Lo Cut EQ	Tone Control	Tone Control	Tone Control	
100	Hi Cut EQ	Tone Control	Tone Control	Tone Control	

## DSP Module List

Module Number	Module Name	Display	Description
①	Mono 1-Band EQ	Mono 1EQ	This is a single-band monaural equalizer.
②	Mono 2-Band EQ	Mono 2EQ	This is a dual-band monaural equalizer.
③	Mono 3-Band EQ	Mono 3EQ	This is a three-band monaural equalizer.
④	Stereo 1-Band EQ	Streo1EQ	This is a single-band stereo equalizer.
⑤	Stereo 2-Band EQ	Streo2EQ	This is a dual-band stereo equalizer.
⑥	Stereo 3-Band EQ	Streo3EQ	This is a three-band stereo equalizer.
⑦	Tone Control	ToneCtrl	Provides monaural tone control for adjusting low-range, mid-range, and high-range frequencies.
⑧	Tremolo	Tremolo	Shifts the volume of the input signal using an LFO.
⑨	Auto Pan	Auto Pan	Shifts the continual left-right panning of the input signal using an LFO.
⑩	Compressor	Compress	Compresses the input signal, which can have the effect of suppressing level variation.
⑪	Limiter	Limiter	Limits the input signal level so it does not rise above a preset level.
⑫	Enhancer	Enhancer	Enhances the profiles of the low range and high range of the input signal.
⑬	Phaser	Phaser	Produces a distinctive pulsating, broad sound by using an LFO to change the phase of the input signal and then mixes it with the original input signal.
⑭	Chorus	Chorus	Gives notes depth and breadth.
⑮	Flanger	Flanger	Applies wildly pulsating and metallic reverberation to notes. Selects the LFO waveform.
⑯	Rotary	Rotary	This effect is a rotary speaker simulator.
⑰	Drive Rotary	DriveRot	This is a rotary speaker simulator that makes overdrive possible.
⑱	Pitch Shifter	Pitch	This effect transforms the pitch of the input signal.
⑲	Ring Modulator	Ring Mod	Multiplies the input signal with an internal oscillator signal to create a metallic sound.
⑳	Reflection	Reflect	Simulates the initial reflection of reverberation. Applies acoustic ambiance and presence to notes.
㉑	Delay	Delay	Delays the input signal and feeds it back to create a repeating effect.
㉒	Piano Effect	Piano	This effect is suited to acoustic piano play.
㉓	LFO Wah	LFO Wah	This is a “wah” effect that can automatically affect the frequency using an LFO.
㉔	Auto Wah	Auto Wah	This is a “wah” effect that can automatically shift the frequency in accordance with the level of the input signal.
㉕	Modeling Wah	ModelWah	Simulates various types of wah pedals. This effect can automatically shift the frequency in accordance with the level of the input signal.
㉖	Distortion	Distort	Distortion, wah, and amp simulator combined into a single effect.
㉗	Drive	Drive	Simulates the drive of a musical instrument amplifier.
㉘	Amp Cab	Amp Cab	Simulates the amp and speaker cabinet without drive and distortion.



## DSP Parameter List

Module Name		Description	Settings
Display	Parameter Data		
① Mono 1-Band EQ		This is a single-band monaural equalizer.	
EQ Freq	EQ Frequency	Adjusts the center frequency of Equalizer.	*1
EQ Gain	EQ Gain	Adjusts the gain of Equalizer.	-12 to 00 to 12
In Level	Input Level	Adjusts the input level.	000 to 127
WetLevel	Wet Level	Adjusts the level of the effect sound.	000 to 127
DryLevel	Dry Level	Adjusts the level of the direct sound.	000 to 127
② Mono 2-Band EQ		This is a dual-band monaural equalizer.	
EQ1 Freq	EQ1 Frequency	Adjusts the center frequency of Equalizer 1.	*1
EQ1 Gain	EQ1 Gain	Adjusts the gain of Equalizer 1.	-12 to 00 to 12
EQ2 Freq	EQ2 Frequency	Adjusts the center frequency of Equalizer 2.	*1
EQ2 Gain	EQ2 Gain	Adjusts the gain of Equalizer 2.	-12 to 00 to 12
In Level	Input Level	Adjusts the input level.	000 to 127
WetLevel	Wet Level	Adjusts the level of the effect sound.	000 to 127
DryLevel	Dry Level	Adjusts the level of the direct sound.	000 to 127
③ Mono 3-Band EQ		This is a three-band monaural equalizer.	
EQ1 Freq	EQ1 Frequency	Adjusts the center frequency of Equalizer 1.	*1
EQ1 Gain	EQ1 Gain	Adjusts the gain of Equalizer 1.	-12 to 00 to 12
EQ2 Freq	EQ2 Frequency	Adjusts the center frequency of Equalizer 2.	*1
EQ2 Gain	EQ2 Gain	Adjusts the gain of Equalizer 2.	-12 to 00 to 12
EQ3 Freq	EQ3 Frequency	Adjusts the center frequency of Equalizer 3.	*1
EQ3 Gain	EQ3 Gain	Adjusts the gain of Equalizer 3.	-12 to 00 to 12
In Level	Input Level	Adjusts the input level.	000 to 127
WetLevel	Wet Level	Adjusts the level of the effect sound.	000 to 127
DryLevel	Dry Level	Adjusts the level of the direct sound.	000 to 127
④ Stereo 1-Band EQ		This is a single-band stereo equalizer.	
EQ Freq	EQ Frequency	Adjusts the center frequency of Equalizer.	*1
EQ Gain	EQ Gain	Adjusts the gain of Equalizer.	-12 to 00 to 12
In Level	Input Level	Adjusts the input level.	000 to 127
WetLevel	Wet Level	Adjusts the level of the effect sound.	000 to 127
DryLevel	Dry Level	Adjusts the level of the direct sound.	000 to 127

Module Name		Description	Settings
Display	Parameter Data		
⑤ Stereo 2-Band EQ		This is a dual-band stereo equalizer.	
EQ1 Freq	EQ1 Frequency	Adjusts the center frequency of Equalizer 1.	*1
EQ1 Gain	EQ1 Gain	Adjusts the gain of Equalizer 1.	-12 to 00 to 12
EQ2 Freq	EQ2 Frequency	Adjusts the center frequency of Equalizer 2.	*1
EQ2 Gain	EQ2 Gain	Adjusts the gain of Equalizer 2.	-12 to 00 to 12
In Level	Input Level	Adjusts the input level.	000 to 127
WetLevel	Wet Level	Adjusts the level of the effect sound.	000 to 127
DryLevel	Dry Level	Adjusts the level of the direct sound.	000 to 127
⑥ Stereo 3-Band EQ		This is a three-band stereo equalizer.	
EQ1 Freq	EQ1 Frequency	Adjusts the center frequency of Equalizer 1.	*1
EQ1 Gain	EQ1 Gain	Adjusts the gain of Equalizer 1.	-12 to 00 to 12
EQ2 Freq	EQ2 Frequency	Adjusts the center frequency of Equalizer 2.	*1
EQ2 Gain	EQ2 Gain	Adjusts the gain of Equalizer 2.	-12 to 00 to 12
EQ3 Freq	EQ3 Frequency	Adjusts the center frequency of Equalizer 3.	*1
EQ3 Gain	EQ3 Gain	Adjusts the gain of Equalizer 3.	-12 to 00 to 12
In Level	Input Level	Adjusts the input level.	000 to 127
WetLevel	Wet Level	Adjusts the level of the effect sound.	000 to 127
DryLevel	Dry Level	Adjusts the level of the direct sound.	000 to 127
⑦ Tone Control		Provides monaural tone control for adjusting low-range, mid-range, and high-range frequencies.	
Low Freq	Low Frequency	Adjusts the cutoff frequency of Low-range.	*2
Low Gain	Low Gain	Adjusts the Low-range gain.	-12 to 00 to 12
Mid Freq	Mid Frequency	Adjusts the center frequency of Mid-range.	*1
Mid Gain	Mid Gain	Adjusts the Mid-range gain.	-12 to 00 to 12
HighFreq	High Frequency	Adjusts the cutoff frequency of High-range.	*3
HighGain	High Gain	Adjusts the High-range gain.	-12 to 00 to 12
In Level	Input Level	Adjusts the input level.	000 to 127
WetLevel	Wet Level	Adjusts the level of the effect sound.	000 to 127
DryLevel	Dry Level	Adjusts the level of the direct sound.	000 to 127

Module Name		Description	Settings
Display	Parameter Data		
⑧ Tremolo		Shifts the volume of the input signal using an LFO.	
Rate	LFO Rate	Adjusts the LFO rate.	000 to 127
Depth	LFO Depth	Adjusts the LFO depth.	000 to 127
Waveform	LFO Waveform	Selects the LFO waveform.	Sine, Triangle, Trapzoid
WetLevel	Wet Level	Adjusts the level of the effect sound.	000 to 127
DryLevel	Dry Level	Adjusts the level of the direct sound.	000 to 127
⑨ Auto Pan		Shifts the continual left-right panning of the input signal using an LFO.	
Rate	LFO Rate	Adjusts the LFO rate.	000 to 127
Depth	LFO Depth	Adjusts the LFO depth.	000 to 127
Waveform	LFO Waveform	Selects the LFO waveform.	Sine, Triangle, Trapzoid
Manual	Manual	Adjusts the pan (stereo position). -64 is full left, 0 is center, and +63 is full right.	-64 to 00 to 63
WetLevel	Wet Level	Adjusts the level of the effect sound.	000 to 127
DryLevel	Dry Level	Adjusts the level of the direct sound.	000 to 127
⑩ Compressor		Compresses the input signal, which can have the effect of suppressing level variation.	
Attack	Attack	Adjusts the time until compression goes into effect. A smaller value causes prompt compressor operation, which suppresses the attack of the input signal. A larger values delays compressor operation, which causes the attack of the input signal to be output as-is.	000 to 127
Release	Release	Adjusts the time until compression is released after the input signal drops below a prescribed level. When an attack feeling is desired (no compression at the onset of the sound), set this parameter to as low a value as possible. To have compression applied at all times, set a high value.	000 to 127
Ratio	Ratio	Adjusts the compression ratio of the audio signal.	1:1, 2:1, 4:1, 8:1, 16:1, 32:1, Inf:1
WetLevel	Wet Level	Adjusts the level of the effect sound. Output volume changes in accordance with the Ratio setting and the characteristics of the input tone.	000 to 127
DryLevel	Dry Level	Adjusts the level of the direct sound.	000 to 127

Module Name		Description	Settings
Display	Parameter Data		
⑪ Limiter		Limits the input signal level so it does not rise above a preset level.	
Limit	Limit	Adjusts the volume level of the limit at which limiting is applied.	000 to 127
Attack	Attack	Adjusts the time until the compression effect starts. A smaller value causes prompt limiter operation, which suppresses the attack of the input signal. A larger values delays limiter operation, which causes the attack of the input signal to be output as-is.	000 to 127
Release	Release	Adjusts the time until compression is released after the input signal drops below a prescribed level.	000 to 127
WetLevel	Wet Level	Adjusts the level of the effect sound. Output volume changes in accordance with the Limit setting and the characteristics of the input tone. Use this parameter to correct for such changes.	000 to 127
DryLevel	Dry Level	Adjusts the level of the direct sound.	000 to 127
⑫ Enhancer		Enhances the profiles of the low range and high range of the input signal.	
Low Freq	Low Frequency	Adjusts the low range enhancer frequency.	000 to 127
Low Gain	Low Gain	Adjusts the low range enhancer gain.	000 to 127
HighFreq	High Frequency	Adjusts the high range enhancer frequency.	000 to 127
HighGain	High Gain	Adjusts the high range enhancer gain.	000 to 127
In Level	Input Level	Adjusts the input level.	000 to 127
WetLevel	Wet Level	Adjusts the level of the effect sound.	000 to 127
DryLevel	Dry Level	Adjusts the level of the direct sound.	000 to 127
⑬ Phaser		Produces a distinctive pulsating, broad sound by using an LFO to change the phase of the input signal and then mixes it with the original input signal.	
Resonanc	Resonance	Adjusts the strength of feedback.	000 to 127
Manual	Manual	Adjusts the reference phaser shift amount.	-64 to 00 to 63
Rate	LFO Rate	Adjusts the LFO rate.	000 to 127
Depth	LFO Depth	Adjusts the LFO depth.	000 to 127
Waveform	LFO Waveform	Selects the LFO waveform.	Sine, Triangle, Random
In Level	Input Level	Adjusts the input level.	000 to 127
WetLevel	Wet Level	Adjusts the level of the effect sound.	000 to 127
DryLevel	Dry Level	Adjusts the level of the direct sound.	000 to 127

Module Name		Description	Settings
Display	Parameter Data		
⑭ Chorus		Gives notes depth and breadth.	
Rate	LFO Rate	Adjusts the LFO rate.	000 to 127
Depth	LFO Depth	Adjusts the LFO depth.	000 to 127
Waveform	LFO Waveform	Selects the LFO waveform.	Sine, Triangle
Feedback	Feedback	Adjusts the strength of feedback.	-64 to 00 to 63
WetLevel	Wet Level	Adjusts the level of the effect sound.	000 to 127
Polarity	Polarity	Inverts the LFO of one channel.	Negative, Positive
In Level	Input Level	Adjusts the input level.	000 to 127
DryLevel	Dry Level	Adjusts the level of the direct sound.	000 to 127
⑮ Flanger		Applies wildly pulsating and metallic reverberation to notes. Selects the LFO waveform.	
Rate	LFO Rate	Adjusts the LFO rate.	000 to 127
Depth	LFO Depth	Adjusts the LFO depth.	000 to 127
Waveform	LFO Waveform	Selects the LFO waveform.	Sine, Triangle, Random
Feedback	Feedback	Adjusts the strength of feedback.	-64 to 00 to 63
WetLevel	Wet Level	Adjusts the level of the effect sound.	000 to 127
In Level	Input Level	Adjusts the input level.	000 to 127
DryLevel	Dry Level	Adjusts the level of the direct sound.	000 to 127
⑯ Rotary		This effect is a rotary speaker simulator.	
Type	Type	Selects the rotary speaker type.	0 to 3
Speed	Speed	Switches the speed mode between fast and slow.	Slow, Fast
Brake	Brake	Stops speaker rotation.	Rotate, Stop
FallAcel	Fall Accel	Adjusts acceleration when the speed mode is switched from fast to slow.	000 to 127
RiseAcel	Rise Accel	Adjusts acceleration when the speed mode is switched from slow to fast.	000 to 127
SlowRate	Slow Rate	Adjusts the speaker rotation speed in the slow speed mode.	000 to 127
FastRate	Fast Rate	Adjusts the speaker rotation speed in the fast speed mode.	000 to 127
Vib/Cho	Vibrato/Chorus	Selects the vibrato and the chorus type.	Off, Vibrato1, Chorus 1, Vibrato2, Chorus 2, Vibrato3, Chorus 3
WetLevel	Wet Level	Adjusts the level of the effect sound.	000 to 127
DryLevel	Dry Level	Adjusts the level of the direct sound.	000 to 127

Module Name		Description	Settings
Display	Parameter Data		
⑰ Drive Rotary		This is a rotary speaker simulator that makes overdrive possible.	
Type	Type	Selects the rotary speaker type.	0 to 3
OD Gain	Overdrive Gain	Adjusts overdrive gain.	000 to 127
OD Level	Overdrive Level	Adjusts the overdrive output level.	000 to 127
Speed	Speed	Switches the speed mode between fast and slow.	Slow, Fast
Brake	Brake	Stops speaker rotation.	Rotate, Stop
FallAcel	Fall Accel	Adjusts acceleration when the speed mode is switched from fast to slow.	000 to 127
RiseAcel	Rise Accel	Adjusts acceleration when the speed mode is switched from slow to fast.	000 to 127
SlowRate	Slow Rate	Adjusts the speaker rotation speed in the slow speed mode.	000 to 127
FastRate	Fast Rate	Adjusts the speaker rotation speed in the fast speed mode.	000 to 127
Vib/Cho	Vibrato/Chorus	Selects the vibrato and the chorus type.	Off, Vibrato1, Chorus 1, Vibrato2, Chorus 2, Vibrato3, Chorus 3
WetLevel	Wet Level	Adjusts the level of the effect sound.	000 to 127
DryLevel	Dry Level	Adjusts the level of the direct sound.	000 to 127
⑱ Pitch Shifter		This effect transforms the pitch of the input signal.	
Pitch	Pitch	Adjusts the pitch shift amount in quarter tone steps.	-24 to 00 to 24
HighDamp	High Damp	Adjusts the high-range damp. A smaller number increases damping.	000 to 127
Feedback	Feedback	Adjusts the feedback amount.	000 to 127
In Level	Input Level	Adjusts the input level.	000 to 127
WetLevel	Wet Level	Adjusts the level of the effect sound.	000 to 127
DryLevel	Dry Level	Adjusts the level of the direct sound.	000 to 127
Fine	Fine	Adjusts the pitch shift amount. -50 is a quarter note decrease, while +50 is a quarter note increase.	-50 to 00 to 50
⑲ Ring Modulator		Multiplies the input signal with an internal oscillator signal to create a metallic sound.	
OSC Freq	OSC Frequency	Sets the reference frequency of the internal oscillator.	000 to 127
Rate	LFO Rate	Adjusts the LFO rate.	000 to 127
Depth	LFO Depth	Adjusts the LFO depth.	000 to 127
Tone	Tone	Adjusts the timbre of the ring modulator input sound.	000 to 127
WetLevel	Wet Level	Adjusts the level of the effect sound.	000 to 127
DryLevel	Dry Level	Adjusts the level of the direct sound.	000 to 127

Module Name		Description	Settings
Display	Parameter Data		
⑳ Reflection		Simulates the initial reflection of reverberation. Applies acoustic presence to notes.	
WetLevel	Wet Level	Adjusts the level of the effect sound.	000 to 127
Feedback	Feedback	Adjusts the repeat of the reflected sound.	000 to 127
Tone	Tone	Adjusts the tone of the reflected sound.	000 to 127
In Level	Input Level	Adjusts the input level.	000 to 127
DryLevel	Dry Level	Adjusts the level of the direct sound.	000 to 127
㉑ Delay		Delays the input signal and feeds it back to create a repeating effect.	
Time	Delay Time	Adjusts the total delay time in 1 ms units.	0001 to 1099
TmRatioL	Delay Ratio L	Adjusts the ratio of the left channel relative to the total delay time.	000 to 127
TmRatioR	Delay Ratio R	Adjusts the ratio of the right channel relative to the total delay time.	000 to 127
Level L	Delay Level L	Adjusts the level of the left channel.	000 to 127
Level R	Delay Level R	Adjusts the level of the right channel.	000 to 127
FdbkType	Feedback Type	Selects the feedback type. Stereo: Stereo feedback Cross: Cross feedback	Stereo, Cross
Fdbk Lvl	Feedback	Adjusts the feedback amount.	000 to 127
Hi Damp	High Damp	Adjusts the high-range damp. A smaller number increases damping.	000 to 127
TmpoSync	Delay Tempo Sync	Specifies how the actual total delay time is synced with tempo. Off: Uses Delay Time value. 1/4 to 1: Uses value in accordance with number of beats.	Off, 1/4, 1/3, 3/8, 1/2, 2/3, 3/4, 1
In Level	Input Level	Adjusts the input level.	000 to 127
DryLevel	Dry Level	Adjusts the level of the direct sound.	000 to 127
WetLevel	Wet Level	Adjusts the level of the effect sound.	000 to 127
㉒ Piano Effect		This effect is suited to acoustic piano play.	
Lid Type	Lid Type	Adjusts how sound resonates in accordance with the opening state of a piano lid.	Closed, SemiOpen, FullOpen
RefLevel	Reflection Level	Adjusts the level of the initial reflection.	000 to 127
In Level	Input Level	Adjusts the input level.	000 to 127
WetLevel	Wet Level	Adjusts the level of the effect sound.	000 to 127
DryLevel	Dry Level	Adjusts the level of the direct sound.	000 to 127

Module Name		Description	Settings
Display	Parameter Data		
②③ LFO Wah		This is a “wah” effect that can automatically affect the frequency using an LFO.	
In Level	Input Level	Adjusts the input level. The input signal can become distorted when the level of the sound being input, the number of chords, or the Resonance value is large. Adjust this parameter to eliminate such distortion.	000 to 127
Resonanc	Resonance	Adjusts the strength of feedback.	000 to 127
Manual	Manual	Adjusts the wah filter reference frequency.	000 to 127
Rate	LFO Rate	Adjusts the LFO rate.	000 to 127
Depth	LFO Depth	Adjusts the LFO depth.	000 to 127
Waveform	LFO Waveform	Selects the LFO waveform.	Sine, Triangle, Random
WetLevel	Wet Level	Adjusts the level of the effect sound.	000 to 127
DryLevel	Dry Level	Adjusts the level of the direct sound.	000 to 127
②④ Auto Wah		This is a “wah” effect that can automatically shift the frequency in accordance with the level of the input signal.	
In Level	Input Level	Adjusts the input level. The input signal can become distorted when the level of the sound being input, the number of chords, or the Resonance value is large. Adjust this parameter to eliminate such distortion.	000 to 127
Resonanc	Resonance	Adjusts the strength of feedback.	000 to 127
Manual	Manual	Adjusts the wah filter reference frequency.	000 to 127
Depth	Depth	Adjusts the depth of the wah in accordance with the level of the input signal. Setting a positive value causes the wah filter to open in direct proportion with the size of the input signal, producing a bright sound. Setting a negative value causes the wah filter to close in direct proportion with the size of the input signal, producing a dark sound.	-64 to 00 to 63
WetLevel	Wet Level	Adjusts the level of the effect sound.	000 to 127
DryLevel	Dry Level	Adjusts the level of the direct sound.	000 to 127



Module Name		Description	Settings																																								
Display	Parameter Data																																										
②5 Modeling Wah		Simulates various types of wah pedals. This effect can automatically shift the frequency in accordance with the level of the input signal.																																									
OutLevel	Level	Adjusts the wah level.	000 to 127																																								
Type	Type	Selects the wah type. <table border="1" data-bbox="463 369 1067 426"> <tr> <td>1</td> <td>CAE</td> <td>3</td> <td>IBZ</td> <td>5</td> <td>FAT</td> <td>7</td> <td>7STR</td> </tr> <tr> <td>2</td> <td>CRY</td> <td>4</td> <td>VO</td> <td>6</td> <td>LIGHT</td> <td>8</td> <td>RESO</td> </tr> </table>	1	CAE	3	IBZ	5	FAT	7	7STR	2	CRY	4	VO	6	LIGHT	8	RESO	1 to 8																								
1	CAE	3	IBZ	5	FAT	7	7STR																																				
2	CRY	4	VO	6	LIGHT	8	RESO																																				
Manual	Manual	Adjusts the wah filter reference frequency.	000 to 127																																								
Depth	Depth	Adjusts the depth of the wah in accordance with the level of the input signal. Setting a positive value causes the wah filter to open in direct proportion with the size of the input signal, producing a bright sound. Setting a negative value causes the wah filter to close in direct proportion with the size of the input signal, producing a dark sound.	-64 to 00 to 63																																								
WetLevel	Wet Level	Adjusts the level of the effect sound.	000 to 127																																								
DryLevel	Dry Level	Adjusts the level of the direct sound.	000 to 127																																								
②6 Distortion		Distortion, wah, and amp simulator combined into a single effect.																																									
DistGain	Dist Gain	Adjusts the distortion input signal gain.	000 to 127																																								
Dist Lvl	Dist Level	Adjusts the distortion output level.	000 to 127																																								
Dist Low	Dist Low	Adjusts the distortion low-range gain.	000 to 127																																								
DistHigh	Dist High	Adjusts the distortion high-range gain.	000 to 127																																								
Wah Type	Wah Type	Specifies the wah type. <table border="1" data-bbox="463 952 916 1010"> <tr> <td>1</td> <td>LPF</td> <td>3</td> <td>V-Wah</td> <td>5</td> <td>L-Wah</td> </tr> <tr> <td>2</td> <td>C-Wah</td> <td>4</td> <td>F-Wah</td> <td>6</td> <td>H-Wah</td> </tr> </table>	1	LPF	3	V-Wah	5	L-Wah	2	C-Wah	4	F-Wah	6	H-Wah	1 to 6																												
1	LPF	3	V-Wah	5	L-Wah																																						
2	C-Wah	4	F-Wah	6	H-Wah																																						
WahDepth	Wah Depth	Adjusts the depth of the wah in accordance with the level of the input signal.	-64 to 00 to 63																																								
Wah Manu	Wah Manual	Adjusts the wah filter reference frequency.	000 to 127																																								
Routing	Routing	Specifies the distortion and wah connection.	Dist, Wah, Wah-Dist, Dist-Wah																																								
Amp	Amp	Specifies the amp type. <table border="1" data-bbox="463 1232 1067 1373"> <tr> <td>0</td> <td>Bypass</td> <td>5</td> <td>FD-DXR V</td> <td>10</td> <td>FD-TWR V2</td> <td>15</td> <td>FD-BMAN</td> </tr> <tr> <td>1</td> <td>FD-PRNST</td> <td>6</td> <td>VX-AC3</td> <td>11</td> <td>SL-SLO</td> <td>16</td> <td>BASS-STK</td> </tr> <tr> <td>2</td> <td>FD-TWR V1</td> <td>7</td> <td>ML-DC3</td> <td>12</td> <td>MB-RCTF</td> <td></td> <td></td> </tr> <tr> <td>3</td> <td>RL-J12</td> <td>8</td> <td>MB-MK1</td> <td>13</td> <td>PV-51-SK</td> <td></td> <td></td> </tr> <tr> <td>4</td> <td>FD-TWD</td> <td>9</td> <td>MS-STK</td> <td>14</td> <td>BASS-CMB</td> <td></td> <td></td> </tr> </table>	0	Bypass	5	FD-DXR V	10	FD-TWR V2	15	FD-BMAN	1	FD-PRNST	6	VX-AC3	11	SL-SLO	16	BASS-STK	2	FD-TWR V1	7	ML-DC3	12	MB-RCTF			3	RL-J12	8	MB-MK1	13	PV-51-SK			4	FD-TWD	9	MS-STK	14	BASS-CMB			0 to 16
0	Bypass	5	FD-DXR V	10	FD-TWR V2	15	FD-BMAN																																				
1	FD-PRNST	6	VX-AC3	11	SL-SLO	16	BASS-STK																																				
2	FD-TWR V1	7	ML-DC3	12	MB-RCTF																																						
3	RL-J12	8	MB-MK1	13	PV-51-SK																																						
4	FD-TWD	9	MS-STK	14	BASS-CMB																																						
WetLevel	Wet Level	Adjusts the level of the effect sound.	000 to 127																																								
DryLevel	Dry Level	Adjusts the level of the direct sound.	000 to 127																																								

Module Name		Description	Settings
Display	Parameter Data		
②7 Drive		Simulates the drive of a musical instrument amplifier.	
Type	Drive Type	Selects the drive type.*4	1 to 20
Gain	Gain	Adjusts the driver input signal gain.	000 to 127
OutLevel	Level	Adjusts the drive output level.	000 to 127
WetLevel	Wet Level	Adjusts the level of the effect sound.	000 to 127
DryLevel	Dry Level	Adjusts the level of the direct sound.	000 to 127
②8 Amp Cab		Simulates the amp and speaker cabinet without drive and distortion.	
Type	Type	Selects the amp cabinet type.*5	1 to 92
Vari	Variation	Selects a variation that changes the setup of the currently selected amp. The number of variations*5 depends on the amp type.	1 to 4
WetLevel	Wet Level	Adjusts the level of the effect sound.	000 to 127
DryLevel	Dry Level	Adjusts the level of the direct sound.	000 to 127

\*1 100Hz, 125Hz, 160Hz, 200Hz, 250Hz, 315Hz, 400Hz, 500Hz, 630Hz, 800Hz, 1.0kHz, 1.3kHz, 1.6kHz, 2.0kHz, 2.5kHz, 3.2kHz, 4.0kHz, 5.0kHz, 6.3kHz, 8.0kHz

\*2 50Hz, 63Hz, 80Hz, 100Hz, 125Hz, 160Hz, 200Hz, 250Hz, 315Hz, 400Hz, 500Hz, 630Hz, 800Hz

\*3 2.0kHz, 2.5kHz, 3.2kHz, 4.0kHz, 5.0kHz, 6.0kHz, 8.0kHz, 10kHz, 13kHz, 16kHz

\*4

Settings	Drive Type	Display	Description
1 to 4	Clean1 to 4	Clean1 to 4	Simulates a clean sound with little distortion.
5 to 8	Crunch1 to 4	Crunch1 to 4	Simulates a crisp crunch sound with little distortion.
9 to 12	Overdrive1 to 4	Overdrv1 to 4	Simulates an overdrive sound with mellow distortion.
13 to 16	Distortion1 to 4	Distort1 to 4	Simulates a hard, straight distortion sound.
17 to 20	Metal1 to 4	Metal1 to 4	Simulates an extreme and weighty distortion sound that is suitable for heavy metal music.

Reference

\*5 (V: Number of variations)

Settings	V	Display
1	1	FD-PRNST
2	1	FD-TWRV1
3	1	RL-J12
4	1	FD-TWD
5	1	FD-DXRV
6	1	VX-AC3
7	1	ML-DC3
8	1	MB-MK1
9	1	MS-STK
10	1	FD-TWRV2
11	1	SL-SLO
12	1	MB-RCTF
13	1	PV-51-SK
14	1	BASS-CMB
15	1	FD-BMAN
16	1	BASS-STK
17	3	65-MQ
18	3	AD-MP+CA
19	2	BC-HC30
20	3	BN-SHV
21	3	BN-ECS
22	3	BN-UBR
23	3	CV-LG3
24	2	DR-MZ38

Settings	V	Display
25	2	DZ-V4
26	2	DZ-HA
27	4	EG-TWK
28	3	EG-VEN
29	2	EN-G15
30	1	EN-INV
31	1	EN-BM
32	2	EN-53+DI
33	4	EV-51III
34	3	FD-CHMP
35	3	FD-TWN
36	3	FD-TWRV3
37	2	FU-OD
38	2	GB-LANC
39	3	HK-TM18
40	3	HK-SBL
41	2	KH-STDT
42	3	KR-RV
43	4	LY-IRST
44	3	MB-MK3
45	3	MB-F3+DI
46	1	MB-D5
47	4	MB-DRCT
48	1	MB-TX+.5

Settings	V	Display
49	4	MB-TX+DI
50	4	MS-VS80
51	4	MS-J800
52	2	MS-J2401
53	3	MS-J2000
54	2	MS-J2+MB
55	3	MS-PLX
56	2	MS-J1+DI
57	4	MT-CFT
58	4	OR-O15
59	2	PN-P7
60	3	PR-SE3
61	4	PV-51II
62	4	PV-65MH
63	3	RA-NBK
64	2	RL-J20
65	2	RL-J120
66	2	RV-30
67	4	SA-PS1
68	2	SL-X8
69	2	SL-X9
70	3	SP-1624
71	3	SP-1695
72	3	SU-BGR3

Settings	V	Display
73	2	VH-SP6
74	3	VX-A15
75	2	VX-A15TB
76	3	VX-A30
77	3	VX-A30TB
78	4	YM-DG8
79	2	AC-360
80	2	AP-SV4DI
81	2	EB-C450
82	2	FD-BMNTw
83	2	FD-BMNSv
84	2	FD-BMNBk
85	2	FD-STBAS
86	3	GK-150
87	3	MK-T501
88	3	SW-PB20
89	3	SW-SM50
90	1	RL-CBKB
91	1	LY-3C-AC
92	4	AC-SIM

## MIDI Implementation Chart

Function	Transmitted	Recognized	Remarks
<b>Basic Channel</b> Default Changed	1 - 16 1 - 16	1 - 16 1 - 16	
<b>Mode</b> Default Messages Altered	Mode 3 X * * * * * * * * * *	Mode 3 X * * * * * * * * * *	
<b>Note Number</b> True Voice	0 - 127 * * * * * * * * * *	0 - 127 0 - 127 *1	
<b>Velocity</b> Note ON Note OFF	0 9nH v = 1 - 127 0 8nH v = 0 - 127	0 9nH v = 1 - 127 0 8nH v = 0 - 127, 9nH v = 0	
<b>After Touch</b> Key's Ch's	X X	X O	
<b>Pitch Bender</b>	O	O	
<b>Control Change</b> 0 1 5 6, 38 7 10 11 64 65 66 67 71 72 73	O *2*3 O *2*3 O *4 O *4 X *6 O *2*3 O *3 O *2*3 O *3 O *3 O *2*3 O *2*3 O *2*3	O O O *4 O O O O O O O O O O O	Bank select Modulation Portamento time Portamento Destiny LSB, MSB Volume Pan Expression Hold 1 Portamento switch Sostenuto Soft pedal Filter resonance Release time Attack time

74 76 77 78 84 89 91 93 94 100, 101		O *2*3 O *2*3 O *2*3 O *2*3 X *5 O *2 O *2 X *6 O *2*4	Filter cutoff Vibrato rate Vibrato depth Vibrato delay Portamento control High resolution velocity prefix Filter cutoff level Chorus send level Delay send level RPN LSB, MSB	O O O O O O O O O *4
<b>Program Change</b>	: True #	O * * * * *		O 0 - 127
<b>System Exclusive</b>		O *4		O *4
<b>System Common</b>	: Song Pos : Song Sel : Tune	X X X		X X X
<b>System Real Time</b>	: Clock : Commands	X X		X X
<b>Aux Messages</b>	: All Sound Off : Reset All Controller : Local ON/OFF : All Notes OFF : Active Sense : System Reset	X *6 X *6 X X O X		O O X O O X
<b>Notes</b>		*1: Depends on tone. *2: Output in accordance with knob set setting. *3: Output in accordance with pedal effect setting. *4: For details about RPN and system exclusive messages, see MIDI Implementation at <a href="https://world.casio.com/">https://world.casio.com/</a> . *5: Note ON only *6: Output along with certain operations.		

Mode 1 : OMNI ON, POLY  
 Mode 3 : OMNI OFF, POLY

Mode 2 : OMNI ON, MONO  
 Mode 4 : OMNI OFF, MONO

O : Yes  
 X : No

**CASIO®**

**CASIO COMPUTER CO., LTD.**  
6-2, Hon-machi 1-chome  
Shibuya-ku, Tokyo 151-8543, Japan

PXS3000-E-3B

MA1911-B

© 2019 CASIO COMPUTER CO., LTD.

## Free Manuals Download Website

<http://myh66.com>

<http://usermanuals.us>

<http://www.somanuals.com>

<http://www.4manuals.cc>

<http://www.manual-lib.com>

<http://www.404manual.com>

<http://www.luxmanual.com>

<http://aubethermostatmanual.com>

Golf course search by state

<http://golfingnear.com>

Email search by domain

<http://emailbydomain.com>

Auto manuals search

<http://auto.somanuals.com>

TV manuals search

<http://tv.somanuals.com>