



CASIO^E

Handheld Terminal **DT-X10** Series

User's Guide

Be sure to read "Safety Precautions" inside this guide before trying to use your Handheld Terminal. After reading this guide, keep it in a safe place for future reference.

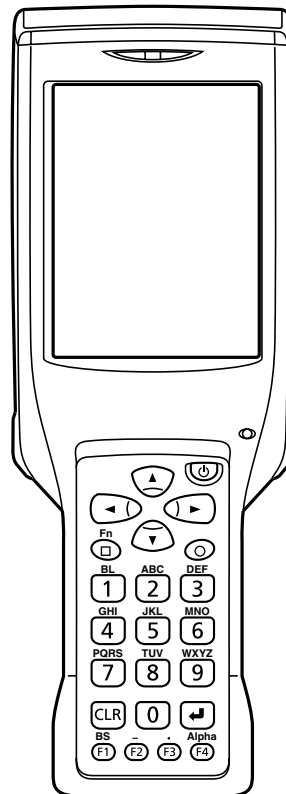

PN410369-005



- This Product includes Extended Systems Inc.'s XTNDConnect Blue SDK for Windows® CE operating system or its derivative work, which use is governed by a license granted by Extended Systems Inc.

Bluetooth

- BLUETOOTH is a trademark owned by Bluetooth SIG, Inc. and licensed to CASIO COMPUTER CO., LTD.
- Microsoft and Windows are either registered trademarks or trademarks of Microsoft Corporation in the United States and/or other countries.
- Compact Flash is a trademark of SanDisk Corporation in the United States.
- Datalight is a registered trademark of Datalight, Inc.
- FlashFX™ is a trademark of Datalight, Inc.

Copyright 1993-2000 Datalight, Inc., All Rights Reserved.

U.S. Patent Office 5,860,082

- Other company names and product names used in this guide are trademarks or registered trademarks of their respective owners.





Safety Precautions

Congratulations upon your selection of this CASIO product. Be sure to read the following Safety Precautions before trying to use it for the first time.

Markings and Symbols

The following are the meanings of the markings and symbols used in these Safety Precautions.

 **Danger** This symbol indicates information that, if ignored or applied incorrectly, creates the danger of death or serious personal injury.

 **Warning** This symbol indicates information that, if ignored or applied incorrectly, creates the possibility of death or serious personal injury.

 **Caution** This symbol indicates information that, if ignored or applied incorrectly, creates the possibility of personal injury or property damage.



• A diagonal line indicates something you should not do. The symbol shown here indicates you should not try to take the unit apart.



• A black circle indicates something you should do. The symbol shown here indicates you should unplug the unit from the wall outlet.

Precautions During Use

Warning

Disassembly and Modification



• Never try to disassemble or modify the Handheld Terminal and its options in any way. High voltage inside creates the danger of electric shock.

Abnormal Conditions



• Should the Handheld Terminal and its options become hot or start to emit smoke or a strange odor, immediately turn off the power, and contact your original vendor or an authorized CASIO service provider. Continued use creates the danger of fire and electric shock.



Warning

Foreign Objects

-  • Should any foreign matter get into the Handheld Terminal and its options, immediately turn off the power and contact your original vendor or an authorized CASIO service provider. Continued use creates the danger of fire and electric shock.

Dropping and Damage

-  • Should you drop the Handheld Terminal and its options and damage them, immediately turn off the power and contact your original vendor or an authorized CASIO service provider. Continued use creates the danger of fire and electric shock.

Moisture

-  • Though your Handheld Terminal is water splash-resistant, its Bridge Satellite Cradle and other optional peripherals are not. Keep loose metal objects and containers filled with liquids away from your Handheld Terminal and the optional peripherals.
Also, never connect or disconnect peripherals to the Handheld Terminal while they are wet. Water getting into the Handheld Terminal or its peripherals creates the danger of fire and electric shock.

Laser Light

-  • This product scans bar codes using laser light. Never look directly into the laser light or shine the laser light into the eyes.

Warning

Interference with the Operation of Other Equipment (Using Wireless Data Communication)

-  • Keep your Handheld Terminal at least 22 centimeters ($8\frac{5}{8}$ ") away from anyone wearing a pacemaker. Radio waves emitted by the Handheld Terminal can affect the operation of a pacemaker.



Caution

Foreign Objects

-  • Take care to ensure that metals or combustible objects are not inserted into the openings of the Handheld Terminal and its options. Such the objects inside of the Handheld Terminal and its options create the danger of fire and electric shock.

Location

-  • Do not locate the Handheld Terminal and its options on a surface that is unstable or uneven. Doing so creates the danger of the Handheld Terminal falling, which can cause personal injury.
- Do not locate the Handheld Terminal and its options in an area subject to large amounts of humidity or dust. Doing so creates the danger of fire and electric shock.
- Do not leave the Handheld Terminal and its options for a long period in a car parked in direct sunlight.

Heavy Objects

-  • Never place heavy objects on top of the Handheld Terminal and its options. Doing so creates the danger of loss of balance and the objects falling, which can cause personal injury.



LCD Screen

-  • Never apply strong pressure to the screen or subject it to strong impact. Doing so can crack the screen or LCD panel glass, which can cause the danger of personal injury.
- Should the LCD panel glass break, never touch the liquid inside. Doing so can cause skin inflammation.
 - Should liquid from the LCD panel accidentally get into your mouth, immediately wash your mouth with water and then consult a physician.
 - Should liquid from the LCD panel accidentally get into your eyes or onto your skin, immediately rinse for at least 15 minutes with clean tap water and then consult a physician.





Optional Lithium-ion Battery Pack

Danger



-  • Never allow the battery pack to become wet. Water can create the danger of battery pack heat emission, explosion, and fire.
- Never use or leave the battery pack next to open flame, near a stove, or any other area exposed to high heat. Doing so creates the danger of battery pack heat emission, explosion, and fire.
- Never use the battery pack with any device other than the Handheld Terminal. Doing so can create the danger of battery pack heat emission, explosion, and fire.
- Note that the battery pack's positive (+) and negative (-) polarities must be oriented correctly when it is loaded into battery charger or the Handheld Terminal. Connecting the battery pack with its polarities reversed creates the danger of battery pack fluid leakage, heat emission, explosion, and fire.
- Never dispose of the battery pack by incinerating it or otherwise expose it to heat. Doing so creates the danger of battery pack heat emission, explosion, and fire.
- Never allow the positive (+) and negative (-) terminals of the battery pack to become connected (shorted) by metal. Doing so creates the danger of battery pack heat emission, explosion, and fire.
- Never transport or store the battery pack together with a necklace, hair pins or other metal objects. Doing so can short battery pack terminals, creating the danger of battery pack heat emission, explosion, and fire. Be sure to place the battery pack in its case whenever transporting or storing it.
- Never throw the battery pack or otherwise subject it to strong impact. Doing so creates the danger of battery pack heat emission, explosion, and fire.
- Never pierce the battery pack with nails, hit it with a hammer, or step on it. Doing so can create the danger of battery pack heat emission, explosion, and fire.
- Never try to take apart the battery pack or modify it in any way. Doing so creates the danger of battery pack heat emission, explosion, and fire.
-  • Use only the specified battery charger to charge the battery pack. Use of other type of battery charger creates the danger of battery pack heat emission, explosion, and fire.



Warning

-  • Never place the battery pack in a microwave oven or any other high-voltage device. Doing so creates the danger of battery pack heat emission, explosion, and fire.
- Should the battery pack emit a strange odor or heat, change color or shape, or exhibit any other abnormal behavior, immediately stop using it. Continued use creates the danger of battery pack heat emission, explosion, and fire.
-  • If the amount of time period the battery pack can serve becomes considerably short, stop using it. It may indicate the possibility of a malfunction in the battery pack. Continued charging the battery pack creates the danger of heat emission, explosion, and fire.
- If the battery pack does not achieve full charge after the normal charging time has passed, stop charging it. Continued charging creates the danger of battery pack heat emission, explosion, and fire.
- Should the battery pack start to leak or emit a strange odor, immediately move it away from any nearby flame. Leaking battery fluid is combustible, and exposure to flame creates the danger of explosion and fire.
- Should fluid from the battery pack accidentally get into your eyes, do not rub them. Immediately rinse your eyes with clean tap water and then consult a physician immediately.

Caution



-  • Never use or leave the battery pack in an area exposed to direct sunlight, in a car parked in direct sunlight, or any other very hot area. Doing so creates the danger of heat emission and fire, as well as deterioration of battery pack performance and shortening of its service life.
- Do not use the battery pack in areas where static electricity is being generated. Doing so creates the danger of battery pack heat emission, explosion, and fire.
-  • Danger of explosion if the battery pack is incorrectly replaced. Replace only with same or equivalent type recommended by CASIO. Dispose of used batteries according to the CASIO instruction.
- Should fluid from the battery pack accidentally get onto clothing or your skin, immediately rinse it off with clean tap water. Prolonged contact with battery pack fluid can cause skin irritation.
- Keep the battery pack out of the reach of small children. Do not let small children remove the battery pack from battery charger or the Handheld Terminal while it is powered on.

E-5





AC Power Supply

Warning

-  • Do not use the Handheld Terminal at a voltage other than the specified voltage. Also, do not connect the Handheld Terminal to a multi-plug power strip. Doing so creates the danger of fire and electric shock.
- Avoid conditions that can cause damage or breaks in the power cord. Do not place heavy objects on the power cord and keep it away from sources of heat. Any of these conditions can damage the power cord, creating the danger of fire and electric shock.
- Never modify, sharply bend, twist, or pull on the power cord. Doing so creates the danger of fire and electric shock.
-  • When using the battery charger and Bridge Satellite Cradle, be sure to use the respective AC adaptors (sold separately). Use of other AC adaptor model creates the danger of fire and electric shock.
- Should the power cord become severely damaged (to the point that wires are exposed or broken), contact your original vendor or an authorized CASIO service provider about repair or replacement. Use of a damaged electrical cord creates the danger of fire and electric shock.

Caution

-  • Keep the power cord away from stoves and other sources of extreme heat. Heat can melt the covering of the power cord and create the danger of fire and electric shock.
-  • Never pull on the power cord when unplugging it. Doing so can damage the cord and create the danger of fire and electric shock. (Always hold the plug when unplugging it from the wall outlet.)
- Never touch the plug while your hands are wet. Doing so can create the danger of electric shock.
-  • Be sure to unplug the power cord from the wall outlet before moving the battery charger and Bridge Satellite Cradle. Failure to do so can result in damage to the power cord caused by pulling it, which creates the danger of fire and electric shock.
- Be sure to unplug the power cord from the wall outlet before cleaning the battery charger and Bridge Satellite Cradle.
- Be sure to turn the power off and unplug the power cord after use.
- Unplug the power cord from the wall outlet whenever leaving the battery charger and Bridge Satellite Cradle unattended for a long period.

E-6



AC Adaptor

Caution



- The housing of the AC adaptor can become warm during normal use.



- Take normal precautions against electric shock.



- At least once a year, unplug the AC adaptor from the wall outlet and clean any dust that builds up between the prongs of the plug.

Dust built up between the prongs can lead to the danger of fire.

Backup Copies of All Important Data

Caution



- Note that CASIO Computer Co., Ltd. shall not be held liable to you or any third party for any damages or loss caused by deletion or corruption of data due to use of the Handheld Terminal, malfunction or repair of the Handheld Terminal or its peripherals, or due to the batteries going dead.
- The Handheld Terminal employs electronic memory to store data, which means that memory contents can be corrupted or deleted if power is interrupted due to the batteries going dead or incorrect battery replacement procedures. Data cannot be recovered once it is lost or corrupted. Be sure to make backup copies of all important data. One way to do this is to use the separately sold Bridge Satellite Cradle to transfer data to a computer.



Operating Precautions

Your Handheld Terminal and its options are precision digital instruments. Improper operation or rough handling can cause problems with data storage and other problems. Note and observe the following precautions to ensure proper operation.

- **Do not continue operating the Handheld Terminal when battery power is low.**
Doing so can cause data to be lost. When the battery goes low, charge it as soon as possible.
- **Do not leave dead batteries in the Handheld Terminal for a long period.**
Dead batteries can leak, leading to malfunction and damage to the Handheld Terminal.
- **Use the Handheld Terminal and its options only within the specified temperature range.**

Use outside of the specified temperature range creates the risk of malfunction.

- **Avoid using the Handheld Terminal and its options in areas subject to the following conditions.**

The following conditions create the risk of damage to the Handheld Terminal.

- Large amounts of static electricity
- Extreme heat or extreme cold
- High humidity
- Sudden temperature extremes
- Large amounts of dust

- **Use only the special stylus that comes with the Handheld Terminal to operate its touch screen and reset button.**
- **Do not use any tool other than the special stylus to operate the touch screen. Other tools can scratch the touch screen and lead to malfunction.**
- **Never use thinner, benzene, cosmetic cleaning fluids, or other volatile agents to clean the Handheld Terminal.**

To clean the Handheld Terminal, wipe it with a dry cloth, or a cloth moistened in a weak solution of water and a mild neutral detergent. Wring all excess moisture from the cloth before wiping.



Important

- The contents of this guide are subject to change without notice.
- Note that CASIO COMPUTER CO., LTD. shall not be held liable to you or any third parties for any losses or damages arising from the use of this guide.
- This guide does not include any information about programming and download procedures. See the applicable separate documentation for information about the procedures.

Warranty and After Service

- Should this product ever malfunction, contact your original retailer providing information about the product name, the date you purchased it, and details about the problem.



This mark applies in EU countries only.



GUIDELINES LAID DOWN BY FCC RULES FOR USE OF THIS UNIT IN THE U.S.A. (not applicable to other areas).

NOTICE

This equipment has been tested and found to comply with the limits for a Class B digital device, pursuant to Part 15 of the FCC Rules. These limits are designed to provide reasonable protection against harmful interference in a residential installation. This equipment generates, uses and can radiate radio frequency energy and, if not installed and used in accordance with the instructions, may cause harmful interference to radio communications. However, there is no guarantee that interference will not occur in a particular installation. If this equipment does cause harmful interference to radio or television reception, which can be determined by turning the equipment off and on, the user is encouraged to try to correct the interference by one or more of the following measures:

- Reorient or relocate the receiving antenna.
- Increase the separation between the equipment and receiver.
- Connect the equipment into an outlet on a circuit different from that to which the receiver is connected.
- Consult the dealer or an experienced radio/TV technician for help.

FCC WARNING

Changes or modifications not expressly approved by the party responsible for compliance could void the user's authority to operate the equipment.
Proper connectors must be used for connection to host computer and/or peripherals in order to meet FCC emission limits.

Peripherals and Cables

- Battery Pack (DT-5023BAT)
- Large-capacity Battery Pack (DT-5025LBAT)
- AC Adaptor (AD-S42120A)
- Communication Card Cover (DT-892TCV)
- Communication Card Cover (Large size) (DT-893LTCV)
- CF Card Extension Unit (DT-894CFU)
- Cables (DT887AXA, DT888RSC, DT-380USB, SB-201)

Declaration of Conformity

Model Numbers: DT-X10M30U, DT-X10M30URC2, DT-160IOE, DT-167CHGE, DT-169CHGE, DT-5022CHG
 Trade Name: CASIO
 Responsible party: CASIO, INC.
 Address: 570 Mt. Pleasant Avenue, Dover, New Jersey 07801
 Telephone number: 973-361-5400

This device complies with Part 15 of the FCC Rules. Operation is subject to the following two conditions:
 (1) This device may not cause harmful interference, and (2) this device must accept any interference received, including interference that may cause undesired operation.

The equipment generates and radiates radio-frequency energy. SAR (Specific Absorption Rate) for this device was measured in accordance with FCC OET Bulletin 65, Supplement C and guidelines established in IEEE C95.1-1991.

We, the undersigned,

Company	CASIO Europe GmbH
Address, City	Bornbarch 10, D-22848 Norderstedt
Country	Germany
Phone number	+49(0)40-528-65-0
Fax number	+49(0)40-528-65-424

certify and declare under our sole responsibility that the following equipments:

E-10





Product description / Intended use	
EU/EFTA member states intended for use	EU: Austria, Belgium, Denmark, Finland, France, Germany, Greece, Ireland, Italy, Luxembourg, The Netherlands, Portugal, Spain, Sweden, United Kingdom, Czech Republic, Hungary, Poland, Slovenia, Slovakia, Estonia, Latvia, Lithuania, Cyprus, Malta EFTA: Switzerland, Iceland, Lichtenstein, Norway
Member states with restrictive use	NONE
Manufacturer	CASIO COMPUTER CO., LTD.
Brand	CASIO
Type	DT-X10M30E, DT-X10M30U, DT-X10M30RC2 DT-X10M10E, DT-X10M10RC2

are tested and found to conform with the essential requirements for protection of health and the safety of the user and any other persons and Electromagnetic Compatibility, as included in following standards:

Standard	Issue date
EN60950	1992
A1,	1993
A2,	1993
A3,	1995
A4,	1997
A11,	1997
EN301 489-1,	2001-09
EN301 489-17	2000

and are tested and found to conform with the essential radio test suites so that they effectively use the frequency spectrum allocated to terrestrial/space radio communication and orbital resources so to as to avoid harmful interference, as included in following standards:

Standard	Issue date
EN300-328-1	2000-07
EN300-328-2	2001-12

and therefore comply with the essential requirements and provisions of the **Directive 1999/5/EC** of the European Parliament and of the council of March 9, 1999 on Radio equipment and Telecommunications Terminal Equipment and the mutual recognition of their conformity and with the provisions of Annex III (Conformity Assessment procedure referred to in article 10).

The technical documentation as required by the Conformity Assessment procedure is kept at the following address:

Company	CASIO Europe GmbH
Address, City	Bornbarch 10, D-22848 Norderstedt
Country	Germany
Phone number	+49(0)40-528-65-0
Fax number	+49(0)40-528-65-424

<p>Products are for distribution within all member states of the EU.</p> <p>France limited to 2446.5-2483.5 Mhz Indoor use.</p> <p>Belgium limited to 2400-2483.5 Mhz Indoor, 2460-2483.5 Mhz Outdoor use.</p> <p>The Netherlands limited to 2400-2483.5 Mhz Indoor use with no license, 2451-2471.0 Mhz Outdoor use with license.</p>	
--	--



Contents

- Safety Precautions E-1**
- Operating Precautions E-8**
- Important E-9**
- Before Getting Started E-14**
- Handheld Terminal System Configuration E-16**
 - Options E-16
- General Guide E-19**
- Replacing the Battery E-21**
 - Replacing the Battery Pack E-21
- Attaching the Wrist Strap E-24**
- Configuring Handheld Terminal Settings E-25**
 - Calibrating Touch Screen Alignment E-25
 - Adjusting Display Contrast E-26
 - Adjusting Display Brightness E-26
 - Display Auto Dimmer E-26
- Using the C-MOS Imager (C-MOS Imager models only) E-27**
 - About the Class 1 LED Label E-28
- Using the Laser Scanner (Laser Scanner models only) E-29**
 - Warning Label E-30
 - Bar Code Scanning Position E-30
- Performing Data Communication E-31**
 - IR Data Communication E-31
 - Bluetooth® Communication E-32
- Resetting the Handheld Terminal E-33**
 - Performing a Full Reset (Initialization) E-34
- DT-X10 Specifications E-35**





Using the Bridge Satellite Cradle (DT-160IOE)	E-37
General Guide	E-37
Option	E-37
Connecting the AC Adaptor and Connecting to Computer	E-39
Configuring DIP Switch Settings	E-41
Using Wall Mount Unit	E-42
Connecting Multiple Bridge Satellite Cradles (DT-160IOE)	E-44
Bridge Satellite Cradle (DT-160IOE) Specifications	E-45
Using the Cradle-type Battery Charger	E-46
General Guide	E-46
Option	E-46
Connecting the AC Adaptor for Cradle-type Battery Charger	E-48
Using Wall Mount Unit	E-49
Cradle-type Battery Charger (DT-169CHGE) Specifications	E-49
Using the Dual Battery Charger	E-50
General Guide	E-50
Option	E-50
Charging a Battery Pack	E-52
Connecting Multiple Dual Battery Chargers	E-53
Dual Battery Charger (DT-5022CHG) Specifications	E-54
Using PC Card (DT-X10M30E / M30U / M10E)	E-55
Affixing a PC Card Remover	E-55
To load a PC card	E-55
Using CF Card Extension Unit	E-57
Bundled Item	E-57
Attaching the CF Card Extension Unit	E-57
Loading a CF Card	E-58
CF Card Extension Unit (DT-894CFU) Specifications	E-58
Using Rechargeable Battery Pack	E-59
Battery Pack Specifications	E-59
Large-capacity Battery Pack Specifications	E-59



Before Getting Started

Be sure to perform the following steps before trying to use the Handheld Terminal for the first time.

1. When unpacking, make sure that everything is included.

Open the box and make sure that all the items shown here are included.

Handheld Terminal



Stylus

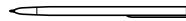

**Large-capacity battery pack
Cover**

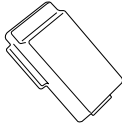

Wrist Strap

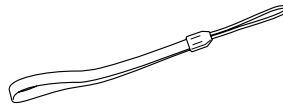

PC Card Remover (2 pcs)

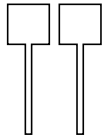

User's Guide (this manual)

2. Charge the battery pack.

Charge the separately available battery pack (DT-5023BAT or DT-5025LBAT). You can use the Dual Battery Charger, or the Cradle-type Battery Charger, or the Bridge Satellite Cradle to charge a battery pack.

For information using these options for charging, see pages 37, 46, and 50.

3. Load the battery pack into the Handheld Terminal.

- ① Slide the two battery pack lock switches at the right and left sides to the “FREE” position, and then remove the battery pack cover.

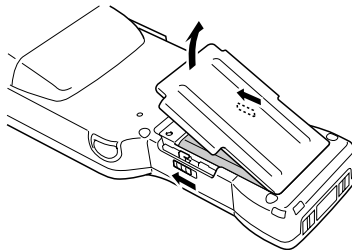



- ② Load a battery pack (DT-5023BAT) or a large-capacity battery pack (DT-5025LBAT). Take care that the battery pack is oriented correctly when you load it.

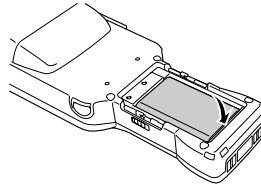

- ③ Replace the rechargeable battery pack cover as shown in the diagram and then return the rechargeable battery pack cover switches (two places) to the "LOCK" positions. When loading a large-capacity rechargeable battery pack, mount the large-capacity rechargeable battery pack cover.

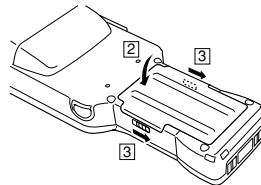
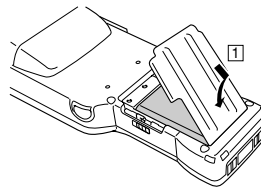

4. Hold down the power key for about one second to turn on the Handheld Terminal. Start up the application you want to run.

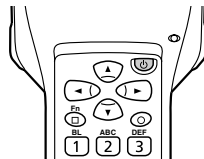

Using the stylus

Tap: Lightly tap with the stylus once on the touch screen.

Tap and Hold: Hold the tip of the stylus on the touch screen without moving it.

Drag: Hold the tip of the stylus on the touch screen as you drag from one location to another. This operation is the same as writing with a pencil on a piece of paper.



Handheld Terminal System Configuration

DT-X10 Series



Laser Scanner models

- DT-X10M10E
- DT-X10M10RC2

C-MOS Imager models

- DT-X10M30E
- DT-X10M30U*
- DT-X10M30RC2
- DT-X10M30URC2

* This model is available in the USA and Canada

Options

Bridge Satellite Cradle

DT-160IOE

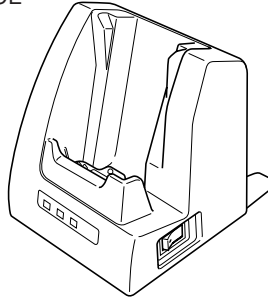

Required AC Adaptor (AD-S42120A)

Cradle-type Battery Charger

DT-169CHGE

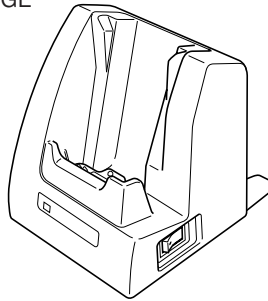

Required AC Adaptor (AD-S42120A)

Wall Mount Unit

DT-891WH

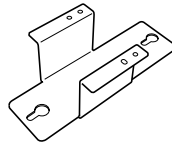

Required Screws



Required Screws



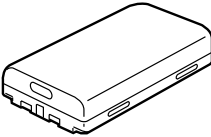
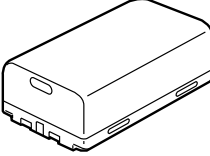

Battery Pack

<p>DT-5023BAT (Battery Pack)</p> 	<p>DT-5025LBAT (Large-capacity Battery Pack)</p> 
--	---

Dual Battery Charger
DT-5022CHG

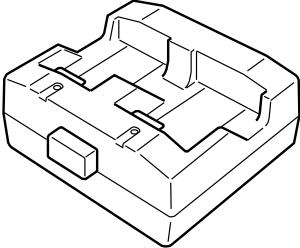

Required AC Adaptor
(MPC-577ADP)



CF Card Extension Unit

DT-894CFU

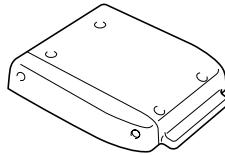

Bundled Items
Large Card Cover
4 screws

Cables

DT-887AXA
DT-888RSC
DT-380USB

Bridge Satellite Cradle Cable/RS-232C Dsub-9Pin (Female)
Bridge Daisy Chain Cable
USB Cable

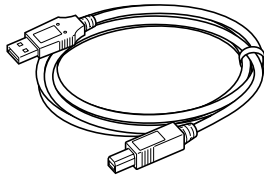

SB-201

PC Connection Cable (USB)

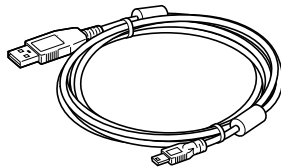

Communication Card Cover

DT-892TCV
DT-893LTCV

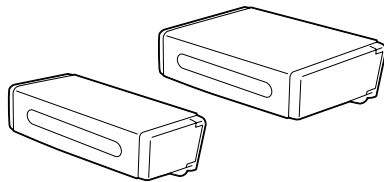

E-18



General Guide

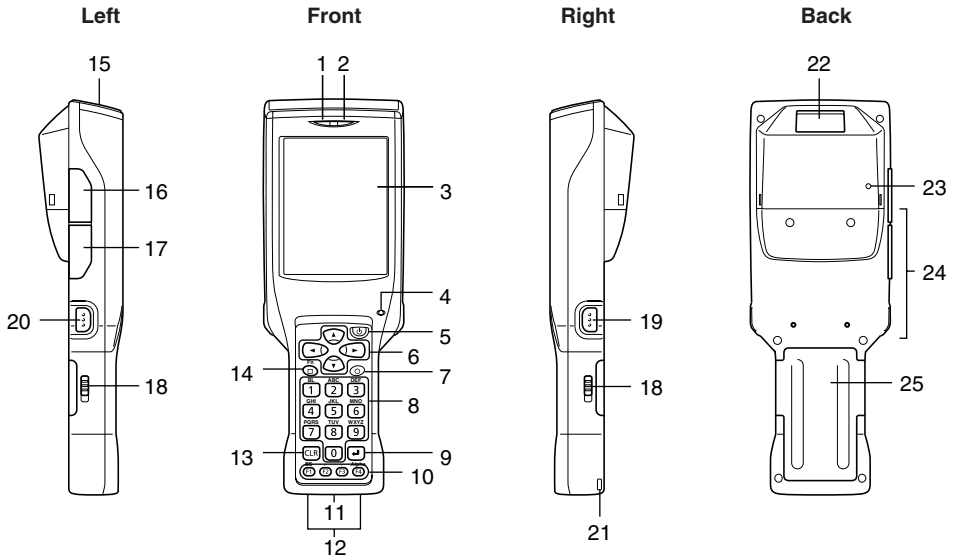

1	Indicator 1	Indicates the result of a barcode or other read operation. Red: Read error Green: Read successful
2	Indicator 2	This lamp indicates the charge status of the battery pack. Red: Charging Green: Charging complete
3	LCD Panel/Touch Screen	Shows text, operation indicators, etc. Also, operations can be performed and text can be input using the supplied stylus.
4	Buzzer	Sounds a buzzer.
5	Power Key	Hold down for about one second to turn the power on or off.
6	Cursor Keys	These keys operate much like a computer's cursor keys. They can be used to select items, scroll screen contents, etc.
7	Programmable Key	This key can be assigned with any function available.
8	Numeric Keys	Use these keys to input numbers and letters.
9	Execute Key	Press to register an input value and advance to the next step.
10	Function Keys	These keys can be assigned any function other than barcode reading. The following are the initial default settings. F1: Deletes one character to the left. F2: Inputs a hyphen (-). F3: Inputs a period (.). F4: Toggles to switch between numbers and alphabets.

E-19



11	IR Port	This port is used for IR data communication with another Handheld Terminal or the Bridge Satellite Cradle.
12	Power Contacts	Contact point for supplying power from the Bridge Satellite Cradle and Cradle-type Battery Charger.
13	CLR Key	Press to clear all key inputs.
14	Fn Key	Press this key and then a function key or number key to configure settings or to run previously registered applications.
15	PC Card Slot	For insertion of a separately available PC card.
16	USB Port	For connection to a computer or other device using a USB cable.
17	Headset Jack	For connection of a commercially available headset (Ø2.5mm).
18	Battery Pack Cover Lock Switches	Slide these switches to lock and release the battery pack cover.
19	R Trigger Key	Press to perform a code read operation. This is also pressed to perform a full reset.
20	L Trigger Key	Press to perform a code read operation. This is also pressed to cancel a full reset.
21	Wrist Strap Hole	Connect the wrist strap here.
22	C-MOS Imager (C-MOS Imager models only)	Reads barcodes and 2-dimensional codes.
	Reader Port (Laser Scanner models only)	Emits a laser that reads bar codes.
23	Reset Switch	Press to reset the Handheld Terminal.
24	CF Card Slot Unit Terminal	For connection of a separately available CF Card Extension Unit.
25	Battery Pack Cover	Covers the compartment that holds the battery pack.

E-20



Replacing the Battery

Your Handheld Terminal uses two types of battery: a battery pack and a memory backup battery.

The battery pack is used to power normal operations and to store data, while the memory backup battery provides the power required to maintain memory contents when the battery pack power is unable to supply power for some reason.

The operating power is supplied by a battery pack. You can choose between a battery pack (DT-5023BAT) and a large-capacity battery pack (DT-5025LBAT).

When using the CF Card Extension Unit (DT-894CF) or a PC card (such as a data communication card), it is recommended that you use the large-capacity battery pack (DT-5025LBAT) instead of the standard battery pack (DT-5023BAT).

The backup battery is installed inside of the Handheld Terminal.

This guide uses the following terms to refer to the batteries.

Battery Pack: Rechargeable battery pack (DT-5023BAT or DT-5025LBAT) for normal operations and data storage

Backup Battery: Built-in battery for memory backup

When the battery pack power goes low, immediately charge it or replace it with a charged battery pack.

You can use the Dual Battery Charger, the Cradle-type Battery Charger, or the Bridge Satellite Cradle to charge a battery pack. See the sections of this guide that cover the Dual Battery Charger, the Cradle-type Battery Charger, and the Bridge Satellite Cradle for information about how to use them for charging.

Replacing the Battery Pack

Important!

Always keep backup copies of all important data!

- **The main battery powers normal operation and also provides power required to maintain memory contents, while the backup battery provides backup power to maintain memory contents. Because of this, you should not remove the main battery while the backup battery is dead. Removing the battery pack while the backup battery is dead causes data in the memory to be corrupted or lost. Note that once data is lost it cannot be recovered. Always keep separate backup copies of all important data.**
- **The charge of a battery pack when you purchase it may be depleted due to testing at the factory or natural discharge during shipment and storage. Be sure to charge the battery pack before you use it.**
- **The life of a battery pack is limited, and charging a battery pack causes it to gradually lose its ability to maintain the charge. If your battery pack seems to require charging very frequently, it probably means it is time to purchase a new one.**
- **A fully charged backup battery can maintain memory (RAM) contents for about 10 minutes, even when the main battery is removed.**
- **The backup battery achieves a full charge in about four days when the battery pack is loaded.**

E-21



To replace the battery pack

1. Make sure that the Handheld Terminal is turned off.
If the power is on, press the power key to turn it off.
2. Turn over the Handheld Terminal.
3. Slide the two battery pack lock switches on both sides of the Handheld Terminal to the “FREE” position, and then remove the battery pack cover.

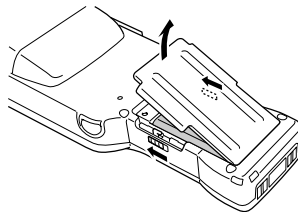

4. Remove the battery pack as shown in the illustration.

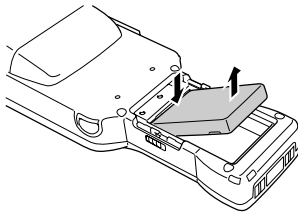

5. Taking care to ensure it is oriented correctly, load a new battery pack into the Handheld Terminal.

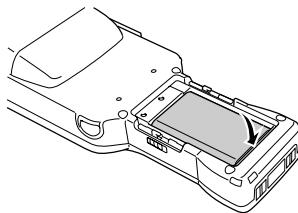



6. Replace the rechargeable battery pack cover as shown in the diagram and then return the rechargeable battery pack cover switches (two places) to the "LOCK" positions.

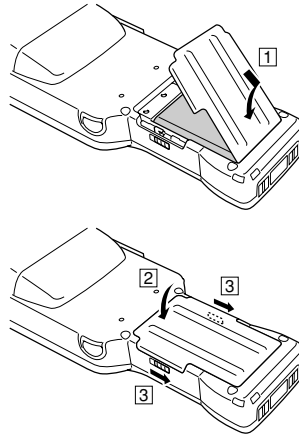

Loading the large-capacity battery pack into the Handheld Terminal

After loading the large-capacity battery pack, you need to use the special large-capacity battery pack cover in place of the standard battery cover. Attachment and removal of the large-capacity battery pack cover are the same as those for the standard battery pack cover.

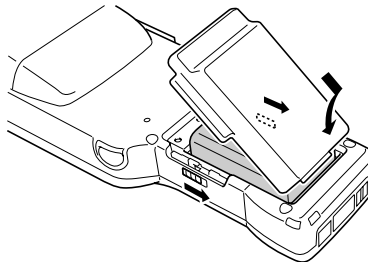

Important!

- When replacing the battery pack, make sure you do not leave the Handheld Terminal without a battery pack for more than about 10 minutes. Doing so can cause data in the memory to be deleted.
- When replacing the battery, be sure you carefully follow the proper procedure as explained in this guide.
- Never try to use other type of battery than the one that is specified for this product.

E-23



Attaching the Wrist Strap

Be sure to attach the wrist strap and use it to protect against dropping the Handheld Terminal when carrying it around.

To attach the wrist strap

1. Pass the thin cord of the wrist strap through the wrist strap hole on the back of the Handheld Terminal.

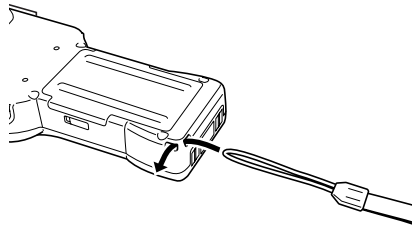

2. Pass the other end of the strap (the part where you insert your wrist) through the loop formed by the thin cord.

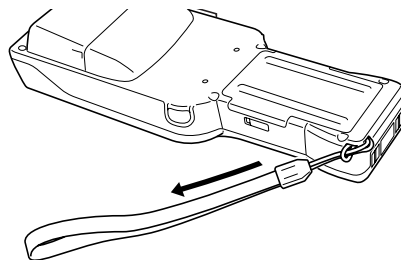
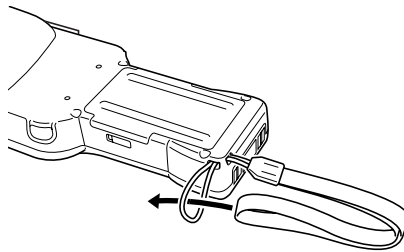

Important!

Do not swing the Handheld Terminal around holding the wrist strap.



Configuring Handheld Terminal Settings

Calibrating Touch Screen Alignment

Whenever you feel that touch screen response is poor or that the operations being executed do not match the location you are tapping on the touch screen, perform either of the following operations to calibrate the alignment of the touch screen.

- Press the “Fn” key and then press the “4” key after confirming that “F” is displayed in the lower right corner of the screen.
- * The following screen can also be displayed by consecutively tapping “Stylus” on the control panel.

Carefully press and briefly hold stylus on the center of the target. Repeat as the target moves around the screen. Press the Fn key and then the CLR key to cancel.



- Press the stylus against the center of the target mark (+ mark) as indicated on the screen. The screen shown below appears after you press stylus against the target at five different locations.

New settings have been measured. Press the Execute key to accept the new settings. Press the Fn key and then the CLR key to keep the old settings.

- Press the Execute key or tap anywhere on the touch screen.



Adjusting Display Contrast

Perform the following steps to adjust display contrast to make display colors more vivid and easier to see.

- Press the “Fn” key and then press the “2” key or “3” key after confirming that “F” is displayed in the lower right corner of the screen. Pressing the “2” key adjusts for more contrast, while pressing the “3” key adjusts for less contrast.
- * In order to continue to make adjustments, press the “2” key or “3” key after again first pressing the “Fn” key.
- * Contrast settings can also be made by consecutively tapping “Brightness” on the control panel.

Adjusting Display Brightness

You can use the following procedure to adjust screen brightness to make it easier to read under different lighting conditions.

- Press the “Fn” key and then press the “5” key or “6” key after confirming that “F” is displayed in the lower right corner of the screen. Pressing the “5” key adjusts brightness for a darker display, while pressing the “6” key adjusts brightness for a brighter display.
- * In order to continue to make adjustments, press the “5” key or “6” key after again first pressing the “Fn” key.
- * Brightness settings can also be made by consecutively tapping “Brightness” on the control panel.

Important!

- **If you use your Handheld Terminal in a location where it is hot, it automatically dims the screen to protect against damage.**

Display Auto Dimmer

The display auto dimmer automatically lowers display brightness if you do not perform any operation for a specific amount of time. This helps to conserve battery power. You can use the following procedure to specify the amount of that should be allowed to pass before auto dimming is performed.

- Select “Control Panel” on the “Settings” menu after tapping the “Start” button in the lower left corner of the screen. Next, consecutively tap the “Brightness” icon and then tap “Backlight” to set the displayed parameters.



Using the C-MOS Imager (C-MOS Imager models only)

1. Turn on the Handheld Terminal, position its C-MOS Imager reader port near the barcode or 2-dimensional code, and then press the Trigger Key (R or L).

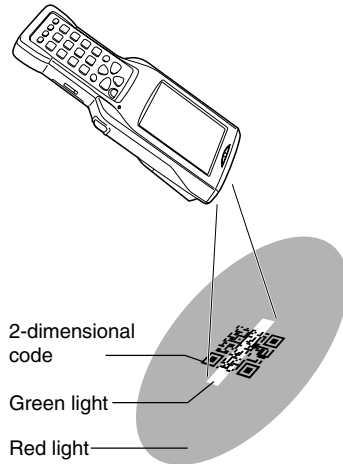

2. The Handheld Terminal LED emits light and reads the code. Indicator 1 (read operation indicator lamp) lights in green when the reading is successful.

Barcode and 2-dimensional code Reading Guide

When you press the Trigger key (R or L), LEDs in the Handheld Terminal emit green and red lights. Align the green light with the center of the barcode or 2-dimensional code you are trying to read. Take particular care aligning the light when there are other barcodes nearby.

When reading a large code, adjust the position of the Handheld Terminal so that the entire code is enclosed within the red light.

Important!

- If you have problem not properly reading a code, change the angle and/or the distance between the label and the Handheld Terminal and try reading the code again.
- A code can be read from a distance of 65mm to 600mm ($2\frac{5}{8}$ " to $1'11\frac{3}{8}$ "), and a 2-dimensional code can be read from a distance of 60mm to 285mm ($2\frac{3}{8}$ " to $11\frac{1}{4}$ "). The actual reading distance depends on the code type and code resolution.
- For smaller codes, move the Handheld Terminal closer to the code.
- To read a large code, move the Handheld Terminal further away from the code.
- Note that a special reader application is required to read barcodes and 2-dimensional codes.
- The DT-X10M30E/M30U/M30RC2/M30URC2 supports reading of 2-dimensional codes.
- Fingerprints, dust, dirt, or other foreign matter on the C-MOS Imager reader port can cause abnormal reading. Should the code reader port become dirty, wipe it clean with a soft, dry cloth.
- DT-X10M30U is available in the USA and Canada, and the rest of the C-MOS Imager model are not.

E-27



About the Class 1 LED Label



- This label identifies the Handheld Terminal as a Class 1 LED product under IEC60825-1: 1997.

Using the Laser Scanner (Laser Scanner models only)

1. After turning on the power, position the laser scanner close to a bar code and then press the trigger key.



2. The laser emits light and scans the bar code. If scanning is completed normally, Indicator 1 displays a green light and a buzzer sounds. If the bar code was not scanned properly, Indicator 1 indicates a red light.

Important!

- If you are unable to scan a bar code, try changing the angle at which the scanner is held or distance from the scanner to the bar code, and then try scanning again.
- This Handheld Terminal is capable of scanning bar codes at a distance of about 40-300 mm ($1\frac{5}{8}$ "- $11\frac{7}{8}$ "). Furthermore, the distance at which scanning is possible may vary according to the type of bar code.
- The laser scanner models are not available in the USA and Canada.



Warning Label



- This label is a warning label for Class 2 laser products that comply with IEC60825-1:1993+A1:1997.
- Although Class 2 laser light is only emitted momentarily, never look directly into the beam light.
- CAUTION
Use of controls or adjustments or performance of procedures other than those specified herein may result in hazardous radiation exposure.
- The laser light emitted by this laser scanner has a maximum output of less than 1 mW and a wavelength of 650 nm.

Bar Code Scanning Position

Position the laser scanner close to the bar code when scanning small bar codes.
Position the laser scanner at a distance from the bar code so that the bars enter the light when scanning large bar codes.

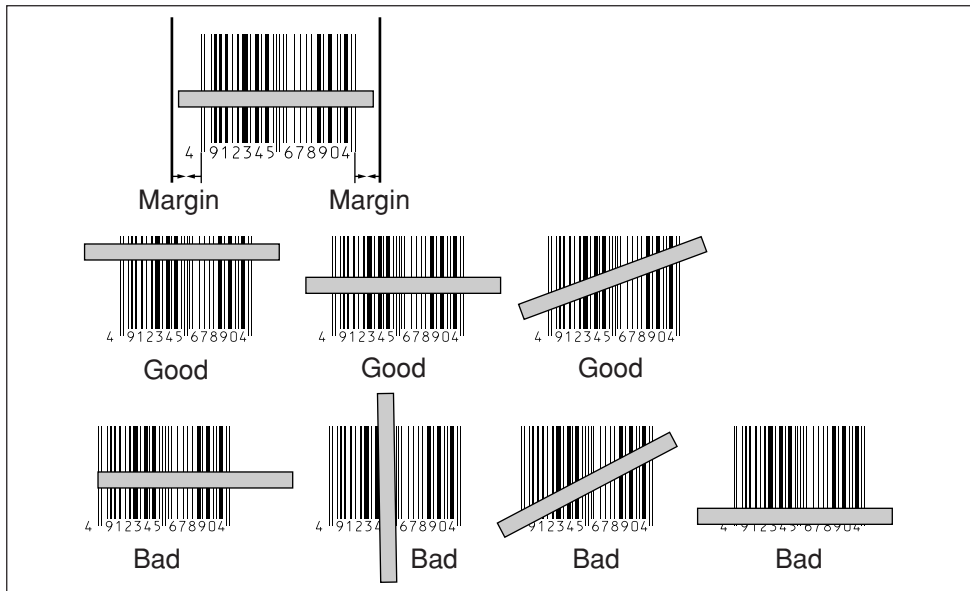

Warning!

■ Never look directly into the laser light.



- This product scans using laser light. Never look directly into the laser light or shine the laser light into the eyes.

E-30





Performing Data Communication

IR Data Communication

IR data communication can be used to transfer data between two Handheld Terminals. When performing IR data communication, orient the IR ports of both Handheld Terminals so they are pointing directly at each other. The ports can be in direct contact with each other, or they can be separated by up to 1 meter (3'3½") (up to 25cm (9⅞") for 4Mbps data communication).

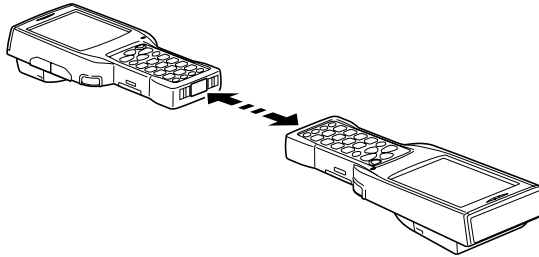

Important!

- A high-sensitivity communication element is used during IR data communication.
- In order to ensure successful communication, avoid using cellular phones or other devices that emit radio wave in the area where you are performing IR data communication.
- If you need to use such a device, move away from the communicating Handheld Terminals. In case of a cellular phone, keep it at least 30cm (11⅞") away.



Bluetooth® Communication

Bluetooth® protocol can also be used to transfer data between two Handheld Terminals. With Bluetooth® the two Handheld Terminals should be located within about three meters (9'10³/₈") from each other, as long as there is nothing blocking the path between them.

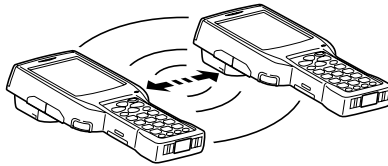

Important!

Observe the following precautions to help ensure that data communication is successful.

- Make sure the Bluetooth® devices are located within three meters (9'10³/₈") of each other. Surroundings (obstacles) may require a shorter distance between the two devices.
- Make sure there is at least two meters (6' 7") between this device and other devices (electrical appliances, audio-visual equipment, OA equipment, and digital cordless telephones, facsimile machines, etc.). (Take special care with microwave ovens. Allow at least three meters (9' 10³/₈") between communicating devices and a microwave oven.) When approaching such a device when its power is turned on, proper data communication may prove impossible while this may also cause interference with TV and radio reception (images produced by certain UHF and broadcast satellite channels may become blurry).
- Normal data communication may not be possible in an area near a broadcast transmitter or wireless transmitter. If this happens, move to a different location. Normal data communication may not be possible in areas exposed to strong radio waves.

- **Wireless LAN Interference**

Because Bluetooth® and Wireless LAN use the same frequency band (2.4GHz), radio interference can occur if there is a Wireless LAN device nearby. This can result in lower data communication speeds, or even make it impossible to establish a connection. If this happens, try the following countermeasures.

- Move at least 10 meters (32'10³/₄") away from the Wireless LAN device.
- If you cannot keep the distance at least 10 meters (32'10³/₄") or more between the Handheld Terminal and a Wireless LAN device, turn off the power of either the Handheld terminal or the Wireless LAN device.
- Set the Wireless LAN mode of the Handheld Terminal to off.

E-32

Resetting the Handheld Terminal

Resetting the Handheld Terminal is the same as restarting a computer. Performing a reset causes all unsaved inputs and edits to be lost, but data that is already stored in the memory as well as all settings should be unaffected.

Use reset to restore normal operation whenever the Handheld Terminal operates abnormally due to misoperation or some other reason.

Use the stylus to press the reset switch on the back of the Handheld Terminal. This starts the reset operation.

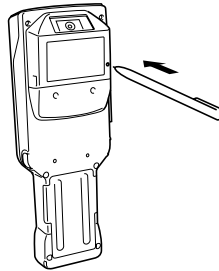

If reset does not find a memory problem

The Handheld Terminal restarts, and normal operation is restored.

If reset finds a memory problem

A message like the one shown below appears on the display when the reset operation discovers a memory problem.

Memory Corruption Warning
A problem with memory contents has been found. Press [R trigger key] to continue with the reset procedure which restores normal system operation.
Note that if the system determines that user memory cannot be repaired it will delete all user data currently in memory.
See the User's Guide for details about initializing memory.

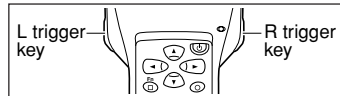

When this message appears, press the R Trigger key to continue with the reset operation. Note, however, that reset may not be successful depending on the condition of the memory. In this case, perform the full reset operation described on the next page.



Performing a Full Reset (Initialization)

Performing a full reset initializes memory. This means that all data stored in the memory (RAM) is deleted and all the settings are returned to their initial factory defaults.

Perform a full reset whenever any one of the following conditions exists.

- When you want to delete all memory contents and return the settings to their initial factory defaults.
- When you are no longer able to use the Handheld Terminal because you forgot your password.
- When the Handheld Terminal does not operate normally due to a memory problem.
- When the message “A problem with memory contents has been found. ...” appears.

To perform a full reset

Important!

Performing a full reset deletes all data currently stored in the memory (RAM). If possible, backup data of the Handheld Terminal to a computer, Flash Memory, a memory card, or some other medium before performing a full reset.

1. While the Handheld Terminal is turned on, hold down the power key and push down the reset button for about one second, until the message shown below appears on the display.

Memory All Clear Warning
Proceeding with this operation initializes memory.
Press [R trigger key] to proceed
or [L trigger key] to cancel.



- To cancel the full reset operation, press the L Trigger key instead of the R Trigger key.
2. Press the R Trigger key. This causes the message shown below to appear.

Memory All Clear Warning
Proceeding with this operation deletes all
data stored in memory.
Press [R trigger key] to proceed
or [L trigger key] to cancel.



- To cancel the full reset operation, press the L Trigger key instead of the R Trigger key.
3. Press the R Trigger key again.
- Full reset is performed, all data in the memory (RAM) are erased and the start-up screen is displayed.

DT-X10 Specifications

Model:	DT-X10M30E, DT-X10M30U, DT-X10M30RC2, DT-X10M30URC2, DT-X10M10E, DT-X10M10RC2
CPU:	Intel® PXA255 Application Processor (300MHz max.)
Memory:	32MB RAM; 32MB Flash ROM (FlashFX built in)
OS:	Microsoft® Windows® CE.NET operating system, English Version
Display:	3.5-inch, 240 × 320-dot 2-Way TFT color LCD
C MOS Imager (DT-X10M30E/M30U/M30RC2/M30URC2):	
Symbologies Supported	
Barcode:	EAN (JAN), UPC, Codabar (NW-7), CODE 39, CODE 93, CODE128 (EAN128, ISBT), CODE11, Interleaved 2 of 5 (ITF), RSS, MSI/Pressy, IATA
2-dimensional code:	Data Matrix, Maxi Code, QR Code, PDF417, Micro PDF, CODE 49, Aztec, Aztec Mesa, Composite, Codablock, Postal Codes* *Postnet, BPO4 State Code (British Post Office), Canadian 4 State Code, Australian 4 State Code, Japanese Post, Planet, Dutch Post
OCR:	OCR A/B OCR US Money
Laser scanner (DT-X10M10E, DT-X10M10RC2):	
Symbologies Supported	EAN (JAN), UPC, Codabar (NW-7), CODE 39, CODE 128 (EAN128), Interleaved 2 of 5 (ITF), MSI/Pressy, IATA
C MOS Imager Reading distance:	
Barcode:	Within approximately 65mm to 600mm (2 ⁵ / ₈ " to 1'11 ⁵ / ₈ "")
2-dimensional code:	Within approximately 60mm to 285mm (2 ³ / ₈ " to 11 ¹ / ₄ "")
Laser scanner scanning distance:	Within approximately 40 to 300mm (1 ⁵ / ₈ "-11 ⁷ / ₈ "")
Serial Port:	Interface: USB slave (Mini B 5 Pin) Transfer Rate: 12Mbps (max.)
IR Port:	Interface: IrDA Ver. 1.1 Standard Synchronization: Asynchronous, frame synchronization Transfer Rate: Up to 4Mbps (max.)
Card Slot (DT-X10M30E/M30U/M10E):	PC Card Type I/Type II (3.3V/5.0V)
Bluetooth® : (All MODELS)	
Protocol:	Bluetooth® Specification Ver.1.1
Range:	Approximately 3 m (9'10 ³ / ₈ "")(depends on radio wave conditions and environment)
Output:	3dBm max. (PowerClass2)
Wireless LAN (DT-X10M30RC2/M30URC2/M10RC2):	
Type:	IEEE 802.11b
Modulation:	Direct Sequence Spread Spectrum
Radio Frequency:	2400 to 2483.5MHz
Data Rate:	11Mbps maximum
Range:	Indoors: 50m (164'5 ⁵ / ₈ ""), Outdoors: 150m (164'5 ⁵ / ₈ "") (Actual range depends on local surroundings.)
Channels:	11 (DT-X10M30URC2); 13 (DT-X10M30RC2/M10RC2)

E-35



Simultaneous Channels: 3
 Other Functions: Multiple access points roaming

Earphone Jack:
 Ø2.5mm (1/8") (3-pole)
 Supports headset.

Power Requirements:
 Power Supply: DT-5023BAT Battery Pack
 DT-5025LBAT Large-capacity Battery Pack
 Memory Backup: Rechargeable Lithium Battery (Built-in)
 Power Consumption: 2.5A DC, 3.7/5V

Battery Life:
 Main Battery: DT-X10M30E/M30U/M10E
 Approximately 8 hours (DT-5023BAT)*
 Approximately 18 hours (DT-5025LBAT)*
 DT-X10M30RC2/M30URC2/M10RC2
 Approximately 8 hours (DT-5023BAT)*
 Approximately 18 hours (DT-5025LBAT)*
 Approximately 4 hours (DT-5023BAT)**
 Approximately 10 hours (DT-5025LBAT)**

*In the case of Standby (20): Operation (1):
 Scanning (1)
 **In the case of Standby (6.5): Scanning (1.5):
 Wireless (2)

Memory backup: Data Protection (RAM): 10 minutes (when no power is being supplied by the installed battery pack)
 Clock: 2 weeks (when no power is supplied by the battery pack)

Operating Temperature:
 DT-X10M30E/M30U/M30RC2/M30URC2 :
 -20°C to 50°C (-4°F to 122°F)
 DT-X10M10E/M10RC2 : -10°C to 50°C (14°F to 122°F)

Operating Humidity:
 10% to 80% RH (non-condensation)

Drop Durability: 1.2 m (3'11³/₈"")

Dust and Water Resistance:
 IEC529 Standard, IP64 Level
 *When all connectors and covers are closed.

Dimensions: Approximately 77(W) × 220(D) × 47(H) mm (3"W × 8⁵/₈"D × 1⁷/₈"H)

Weight: Approximately 350g (12.3oz) (DT-X10M30E/M30U)
 Approximately 400g (14.1oz) (DT-X10M30RC2/M30URC2)
 Approximately 360g (12.7oz) (DT-X10M10E)
 Approximately 410g (14.4oz) (DT-X10M10RC2)



Using the Bridge Satellite Cradle (DT-160IOE)

The optionally available Bridge Satellite Cradle (DT-160IOE) makes it possible to transfer system data and file data between the Handheld Terminal and a computer over an RS-232C connection or USB connection. You can also use the Bridge Satellite Cradle to charge the battery pack installed on the Handheld Terminal. An optionally available wall mount unit (DT-891WH) lets you mount the Bridge Satellite Cradle on a wall.

General Guide

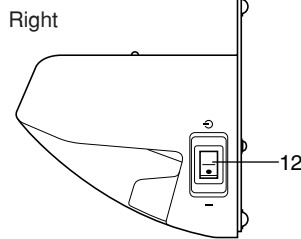
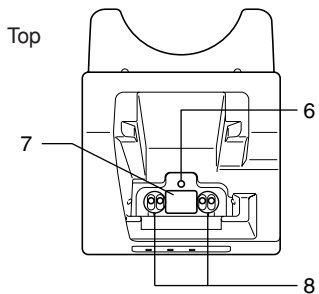
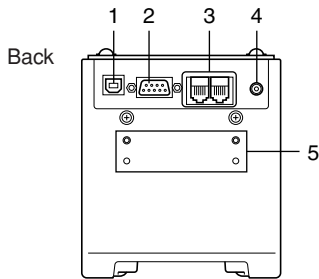

Bottom

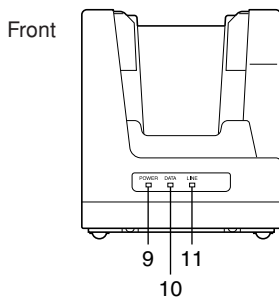
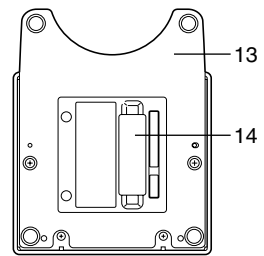

Option

Required AC Adaptor
(AD-S42120A)

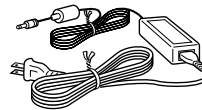

E-37



1	USB Port	This port accepts connection of a USB cable for connection to a computer for transfer of system data and file data. Use of the USB port requires installation of a special driver on the PC.
2	RS-232C Port	This port accepts connection of an RS-232C cable for connection to a computer for transfer of system data and file data. Use of the RS-232C port requires installation of a special driver on the PC.
3	RS-422C Port	This port is used when connecting to another Bridge Satellite Cradle.
4	AC Adaptor Jack	Connect the AC adaptor here.
5	Wall Mount Unit Fastening Plate	The holes in this plate accept screws that secure the wall mount unit in place.
6	Terminal Detect Switch	This switch detects when the Handheld Terminal is not seated correctly on the Bridge Satellite Cradle.
7	IR Port	This port transfers data with the Handheld Terminal IR port non-contact data communication.
8	Power Contacts	Power is supplied to the Handheld Terminal via these contacts.
9	Power Indicator Lamp	This lamp indicates the Power Status and the mounting status of the Handheld Terminal. Off: Power off Green: Power on, Handheld Terminal mounted correctly Red: Power on, Handheld Terminal not mounted
10	Communication Indicator Lamp	This lamp shows when the Handheld Terminal is performing data communication. Off: No data communication being performed Green flashing: Data communication in progress Red: Problem with a connection between two Bridge Satellite Cradles
11	System Status Indicator Lamp	This lamp indicates whether the system is operating normally. Regardless of whether or not a Handheld Terminal is mounted this lamp indicates the system status and whether or not a communication operation with the system can be performed. Off: System is not operating. Green: System is operating.
12	Power Switch	Turns the power on and off.
13	Desktop Unit	This is the base when using the Bridge Satellite Cradle in a desktop configuration. Remove the desktop unit in the case of a wall-mount configuration.
14	DIP Switches	Use these switches to configure the Bridge Satellite Cradle as required.

E-38



Connecting the AC Adaptor and Connecting to Computer

Use the AC adaptor available as option for the Bridge Satellite Cradle to supply the power to it. Always make sure that the power is being supplied to the Bridge Satellite Cradle by the AC adaptor before performing any type of data communication operation with the Handheld Terminal. The Handheld Terminal draws the power via the Bridge Satellite Cradle during data communication.

1. After making sure that the Bridge Satellite Cradle power switch is turned off, plug the AC adaptor into the AC adaptor jack on the back.

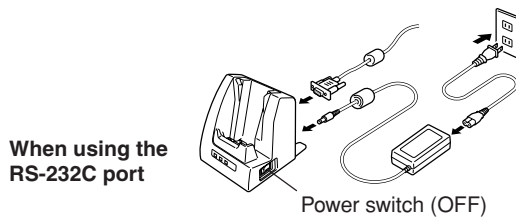

2. Next, plug the AC adaptor into a power outlet.

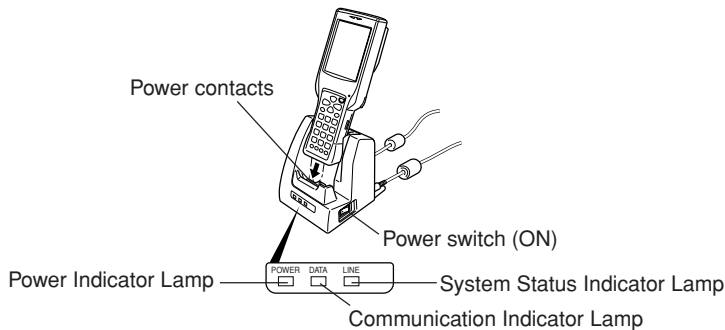

3. After making sure that the Bridge Satellite Cradle and your computer are both turned off, remove the cap from the Bridge Satellite Cradle connection ports, and then perform one of the following steps to connect to your computer.

Be sure to keep the Bridge Satellite Cradle connection ports covered whenever you are not using them.

RS-232C Connection

- Connect an RS-232C cable (DT-887AXA) to the RS-232C port of the Bridge Satellite Cradle. Connect the other end to your computer's RS-232C port.

USB Connection

- Connect a USB cable (DT-380USB) to the USB port of the Bridge Satellite Cradle. Connect the other end to your computer's USB port.





-
4. Turn on the power. This causes the Bridge Satellite Cradle power indicator lamp to light in red.
 5. Making sure that their two IR ports come into contact with each other, place the Handheld Terminal onto the Bridge Satellite Cradle. This causes the Bridge Satellite Cradle power indicator lamp to light in green.
 - If the system is operating normally and data communication is enabled, the system status indicator lamp lights in green.
 - The communication indicator lamp flashes in green when data communication starts.

When charging is initiated, indicator 2 on the DT-X10 lights up in red. When charging has been completed, indicator 2 on the DT-X10 changes color from red to green.

Important!

- **A high-sensitivity communication element is used during IR data communication.**

In order to ensure successful communication, avoid using cellular phones or other devices that emit radio wave in the area where you are performing IR data communication.

If you need to use such a device, move away from the communicating Handheld Terminals. In case of a cellular phone, keep it at least 30cm (11 $\frac{3}{8}$ ") away.

- **Take care to avoid allowing the Bridge Satellite Cradle power contacts to become connected to each other, which creates a short.**

Shorting the power contacts can damage the Bridge Satellite Cradle.



Configuring DIP Switch Settings

Dismounting the bottom cover of the Bridge Satellite Cradle exposes the DIP switches. You can change the ON/OFF settings of the DIP switches to set the configuration. Please, set after first switching OFF the power.

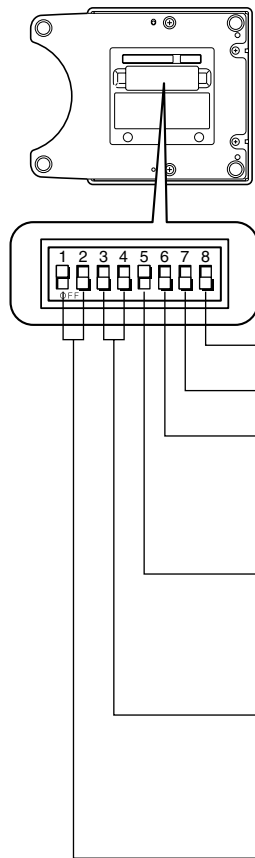

Not used (Always off)

Not used (Always off)

Host Computer Interface

Setting	6
RS-232C	OFF
USB	ON *

Daisy Chain

Setting	5
Intermediate Unit	OFF
Daisy Chain Disabled/Termination	ON *

Connection Type

Setting	3	4
Host Computer	OFF	OFF *
Daisy Chain	ON	OFF

Bridge Satellite Cradle Data Rate

Setting	1	2
115,200bps	ON	OFF *

*Initial factory default setting

Important!

Note that other DIP settings are used for testing and inspection purposes. Because of this, you should never use any DIP settings other than those described above.



Using Wall Mount Unit

The following procedure explains how to use the optional wall mount unit (DT-891WH) to configure the Bridge Satellite Cradle for a wall-mounted configuration.

1. Remove the screws on the bottom of the Bridge Satellite Cradle, and remove the desktop unit.

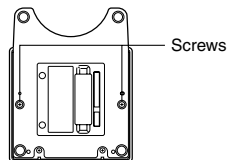

2. Affix the wall mount unit to the bottom of the Bridge Satellite Cradle, and secure it in place with the wall mount unit screws.

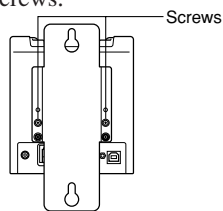

3. Drive one of the provided screws into the wall at the location where the upper hole of the wall mount unit to be when you mount the unit on the wall.

Do not drive the screw into the wall all the way. Keep a space of about 2mm ($\frac{1}{8}$ ") between the head of the screw and the wall surface.

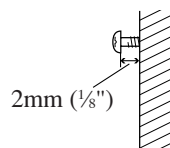

4. Hook the upper wall mount unit hole onto the upper screw.

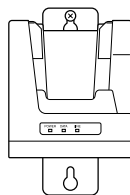

E-42



5. Drive the other screw into the wall at the location where the lower hole is located.

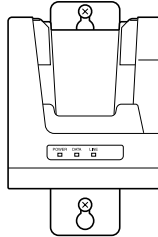

6. Drive the upper screw and lower screw into the wall the rest of the way.

To remove the Bridge Satellite Cradle from the wall

1. Loosen the upper screw and lower screw.
2. Raise the Bridge Satellite Cradle and remove it from the screws.

Important!

- While the Bridge Satellite Cradle is mounted on a wall, be sure to check the wall screws periodically for looseness. Tighten them as required.
- Note use of the RS-232C cable is not supported by the wall-mounted configuration. Connect using a USB cable or daisy chain cable.



Connecting Multiple Bridge Satellite Cradles (DT-160IOE)

Use the modular cable for the connections.

You can daisy chain multiple Bridge Satellite Cradles by connecting the C-OUT port of the first unit that is the nearest to the host computer to the C-IN port of the next unit that is sitting to the first unit with DT-888RSC cable (Daisy chain connection cable) as shown in the figure below.

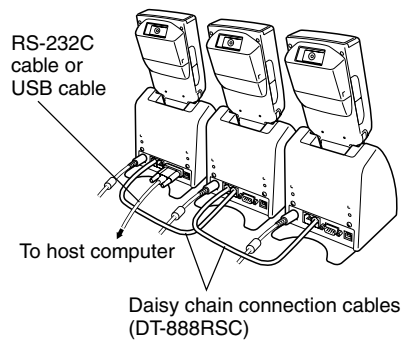

Important!

You can use optional daisy chain connection cables (DT-888RSC) to link up to eight Bridge Satellite Cradles.



Bridge Satellite Cradle (DT-160IOE) Specifications

1. IR Data Communication

Interface:	IR interface
Protocol:	IrDA Ver. 1.1 Standard
Synchronization:	Asynchronous, frame synchronization
Transfer Rate:	9,600, 115,200, 4Mbps (4Mbps is possible during a USB connection with the host computer only.)

2. USB

Protocol:	USB Ver1.1 Standard
Transfer Rate:	12Mbps (max.)

3. RS-232C

Protocol:	Full duplex
Synchronization:	Asynchronous
Transfer Rate:	115,200bps

4. RS-422

Protocol:	Full duplex
Synchronization:	Asynchronous
Transfer Rate:	115,200bps

5. Charging

Charging System:	Fixed-voltage (with current limiter)
Charge Time:	Approximately 2.5 hours (standard battery pack) Approximately 5.0 hours (large-capacity battery pack)

6. Power Supply

Power Requirement:	AC adaptor (AD-S42120A)
Power Consumption:	DC12V approximately 1600mA
Output Handheld Terminal:	DC5V 2500mA (max.)

7. AC Adaptor

Model:	AD-S42120A
Input:	100V to 240V AC 50/60Hz
Output:	12V DC 3500mA

8. Dimensions and Weight

Dimensions:	Desktop: Approximately 110(W) × 139(D) × 129(H) mm (4 ³ / ₈ "W × 5 ¹ / ₂ "D × 5 ¹ / ₈ "H) Wall Mount: Approximately 110(W) × 148(D) × 153(H) mm (4 ³ / ₈ "W × 5 ⁷ / ₈ "D × 6"H)
Weight:	Desktop: Approximately 490g (17.3oz) Wall Mount: Approximately 650g (22.9oz)

8. Operating Environment

Temperature:	0°C to 40°C (32°F to 104°F)
Humidity:	30% to 80% RH (non-condensation)



Using the Cradle-type Battery Charger

The optionally available Cradle-type Battery Charger (DT-169CHGE) lets you charge the Handheld Terminal's battery simply by placing the Handheld Terminal onto the charger.

An optional wall mount unit lets you mount the Cradle-type Battery Charger on a wall.

General Guide

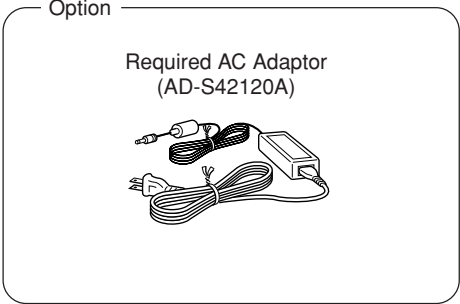
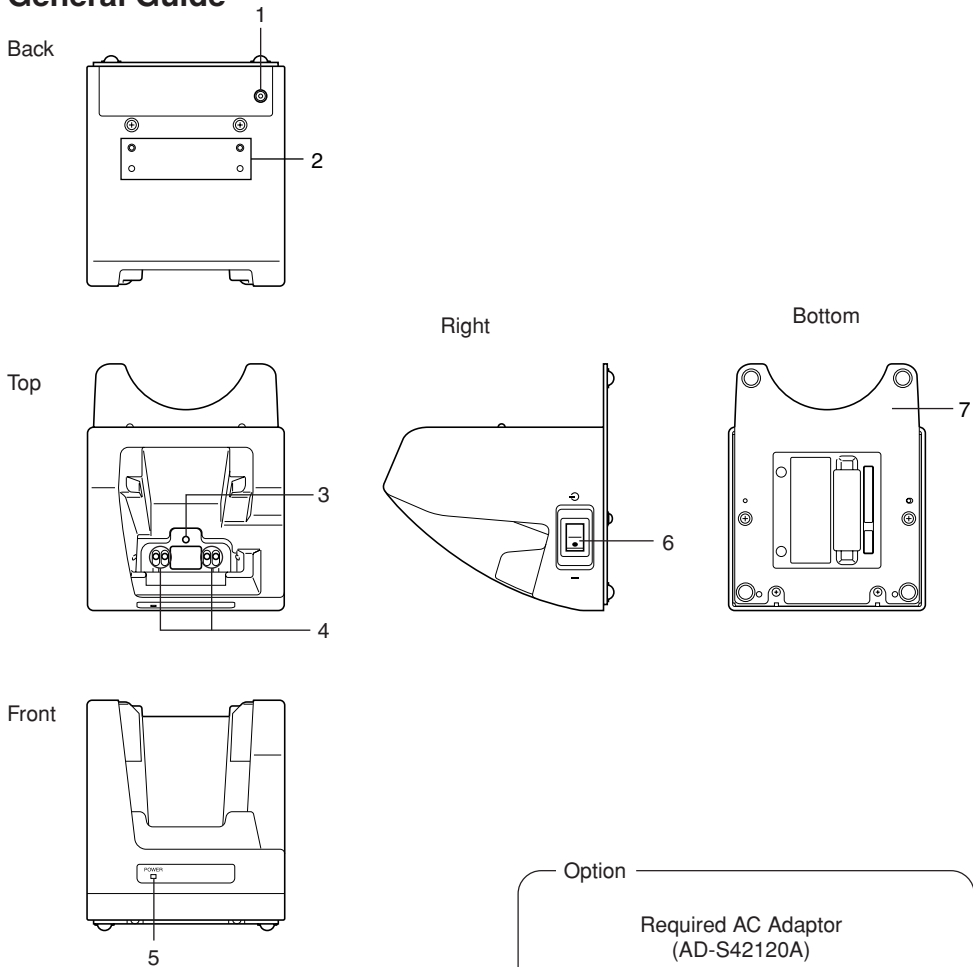



1	AC Adaptor Jack	Connect the AC adaptor here.
2	Wall Mount Unit Fastening Plate	The holes in this plate accept screws that secure the wall mount unit in place.
3	Terminal Detect Switch	This switch detects when the Handheld Terminal is not seated correctly on the Cradle.
4	Power Contacts	Power is supplied to the Handheld Terminal via these contacts.
5	Power Indicator Lamp	This lamp indicates the power status and the mounting status of the Handheld Terminal. Off: Power off Red: Power on, Handheld Terminal not mounted Green: Power on, Handheld Terminal mounted correctly
6	Power Switch	Turns the power on and off.
7	Desktop Unit	This is the base when using the Cradle in a desktop configuration. Remove the desktop unit in the case of a wall-mount configuration.

E-47



Connecting the AC Adaptor for Cradle-type Battery Charger

Use the special AC adaptor for the Cradle-type Battery Charger to connect to a wall outlet.

1. After making sure that the Cradle-type Battery Charger power switch is turned off, plug the AC adaptor into the AC adaptor jack on the back of the charger.

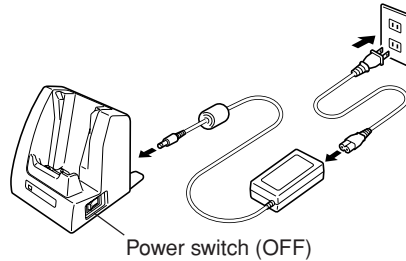

2. Next, plug the AC adaptor into a power outlet.
3. Turn on the power. This causes the Cradle-type Battery Charger power indicator lamp to light in red.

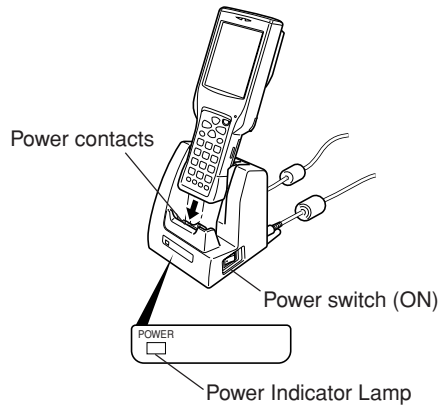

4. Making sure that their power contacts come into contact with each other, place the Handheld Terminal onto the Cradle-type Battery Charger. This causes the Cradle-type Battery Charger power indicator lamp to light in green.

When charging is initiated, indicator 2 on the DT-X10 lights up in red. When charging has been completed, indicator 2 on the DT-X10 changes color from red to green.

Important !

Take care to avoid allowing the Cradle-type Battery Charger power contacts to become connected to each other, which creates a short.

Shorting the power contacts can damage the Cradle-type Battery Charger.

E-48



Using Wall Mount Unit

To wall mount the Cradle-type Battery Charger, use the same procedure as that described for the Bridge Satellite Cradle (DT-160IOE) on page 42.

Cradle-type Battery Charger (DT-169CHGE) Specifications

1. Charging

Charging System:	Fixed-voltage (with current limiter)
Charge Time:	Approximately 2.5 hours (standard battery pack) Approximately 5.0 hours (large-capacity battery pack)

2. Power Supply

Power Requirement:	AC adaptor (AD-S42120A)
Power Consumption:	12V DC, approximately 1,400mA
Output Handheld Terminal:	5V DC 2500mA (max.)

3. AC Adaptor

Model:	AD-S42120A
Input:	100V to 240V AC 50/60Hz
Output:	12V DC 3500mA

4. Dimensions and Weight

Dimensions:	Desktop: Approximately 110(W) X 139(D) X 129(H) mm (4 ³ / ₈ "W x 5 ¹ / ₂ "D x 5 ¹ / ₈ "H)
	Wall Mount: Approximately 110(W) x 148(D) x 153(H) mm (4 ³ / ₈ "W x 5 ⁷ / ₈ "D x 6"H)

Weight:	Desktop: Approximately 470g (16.6oz)
	Wall Mount: Approximately 630g (22.2oz)

5. Operating Environment

Temperature:	0°C to 40°C (32°F to 104°F)
Humidity:	30% to 80% RH (non-condensation)



Using the Dual Battery Charger

The optionally available Dual Battery Charger (DT-5022CHG) allows for serial charging of two rechargeable battery packs.

General Guide

Top

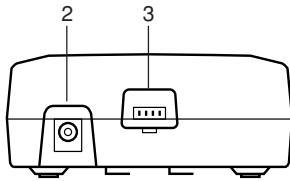

Front

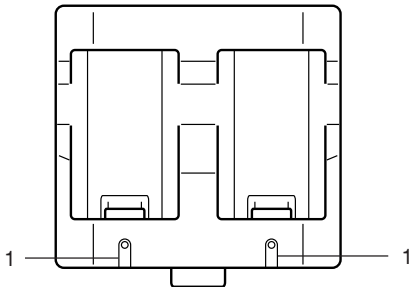

Back

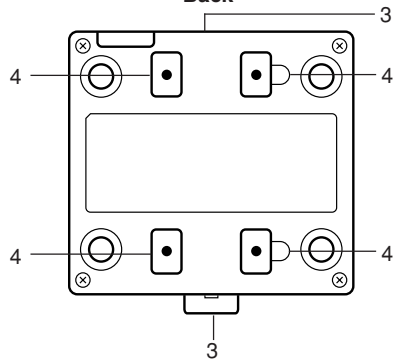

Bundled Items

Connection Bracket
2 screws

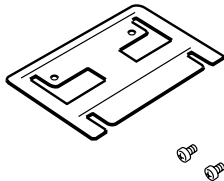

E-50

Option

AC Adaptor

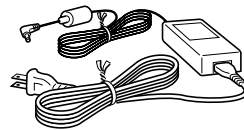

MPC-577ADP



1	Charge Indicator Lamp	This lamp indicates the charge status of the battery pack(s). Off: Not charging Red: Charging Red Flashing: Battery pack problem Green: Charging complete
2	AC Adaptor Jack	Connect the AC adaptor here.
3	Dual Battery Charger Connection Port	Use this port to connect multiple Dual Battery Chargers to each other.
4	Connection Bracket Attachment Holes	The connection bracket attaches here when you connect multiple Dual Battery Chargers to each other.

Important!

Each Dual Battery Charger comes with one connection bracket. Since only one connection bracket is required when you connect two Dual Battery Chargers, you will always have one left over. Simply keep the other connection bracket on hand as an extra, in case you ever need it.

E-51



Charging a Battery Pack

1. Plug the optional AC adaptor into the AC adaptor jack of the Dual Battery Charger.

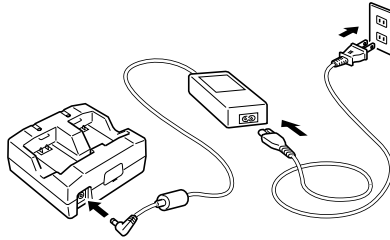

2. Plug the other end of the AC adaptor into a wall outlet.
3. Taking care that the battery pack is oriented correctly, insert it into the Dual Battery Charger.

This causes the Charge Indicator Lamp to light in red, indicating that charging has started.

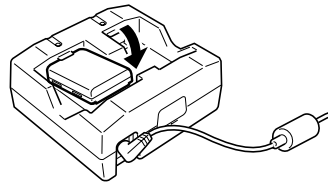

Charge Indicator Lamp

Off:	Not charging
Red:	Charging
Red Flashing:	Battery pack problem
Green:	Charging complete



Connecting Multiple Dual Battery Chargers

You can connect up to three Dual Battery Chargers. Doing so makes it possible to supply power to all the Dual Battery Chargers using the AC adaptor.

1. As shown in the illustrations below, remove the connector covers of the Dual Battery Chargers you want to connect to each other.

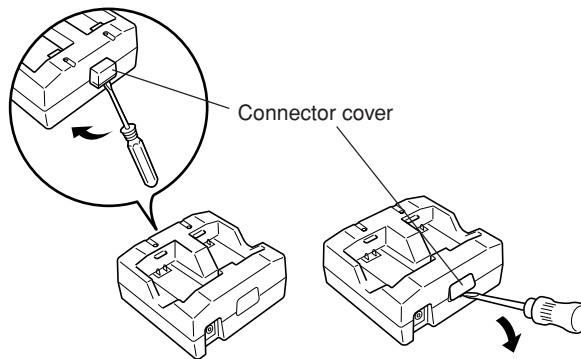

2. Connect the two Dual Battery Chargers as shown below.

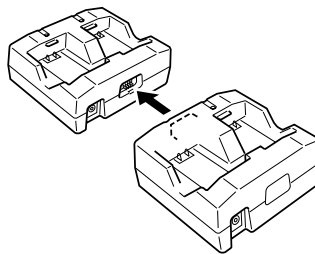

3. Turn over the connected Dual Battery Chargers and attach a connection bracket, securing it in place with screws.

You can repeat the above steps to connect up to three Dual Battery Chargers.

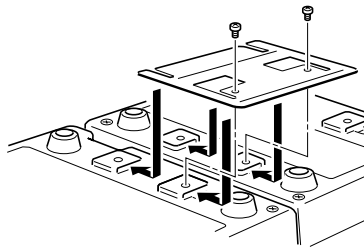

E-53



Dual Battery Charger (DT-5022CHG) Specifications

- 1. Model:**
DT-5022CHG
- 2. Charging:**
Charging System: Fixed-voltage (with current limiter)
Charge Time: Approximately 2.5 hours for one battery pack
Approximately 5.0 hours for one large-capacity battery pack
Charging Two Battery Packs
Approximately 5.0 hours for two battery packs (DT-5023BAT×2)
Approximately 10 hours for two large-capacity battery packs (DT-5025LBAT×2)
- 3. Power Supply:**
Power Requirement: AC adaptor MPC-577ADP
Consumption Current: Approximately 650mA
- 4. Operating Environment:**
Temperature: 0°C to 40°C (32°F to 104°F)
Humidity: 30% to 80% RH (non-condensation)
- 5. Dimensions and Weight:**
Dimensions: Approximately 110(W) × 100(D) × 49(H) mm (4³/₈"W × 4"D × 1⁷/₈"H)
Weight: Approximately 154g (5.4oz)



Using PC Card (DT-X10M30E / M30U / M10E)

Your Handheld Terminal supports use of PC cards (PCMCIA card, compact flash card with a CF card adaptor). Use the following procedure to load and remove PC cards.

Affixing a PC Card Remover

Once loaded, the PC card may be difficult to remove from the PC card slot. Affixing a PC card remover (a piece of tape) to the PC card before you load it makes it easier to pull the card out of the slot later.

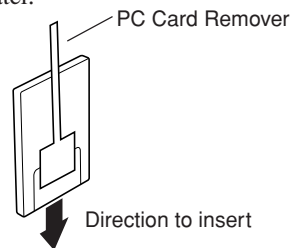

Important!

When you use a compact flash card, always affix the PC card remover to the PC card adaptor, not on the compact flash card itself whenever loading into the Handheld Terminal. If you affix the tape to the compact flash card instead of the adaptor, pulling the remover may end up pulling out the compact flash card only, and make it impossible to remove the adaptor.

To load a PC card

1. Carefully lift up either end of the rubber PC card slot cover, and remove the four screws that secure it in place.

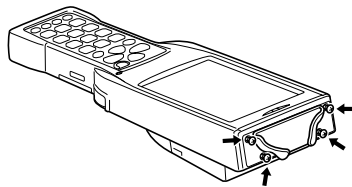

Important!

Be gentle when lifting up the ends of the PC card slot cover rubber to expose the screws. Pulling on the rubber or other rough handling can cause the rubber to break.

- Installing a large-size PC card such as communication card may cause the PC card slot cover rubber not to be put back. If you face to such the accident use either the communication card cover (DT-892TCV) or the large-size communication card cover (DT-893LTCV) both optional to protect the slot and the installed PC card itself.

E-55



2. Remove the PC card slot cover.

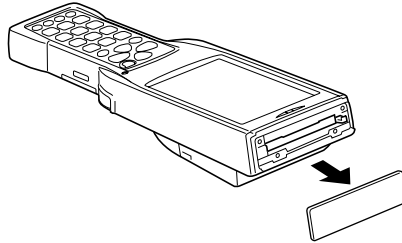

3. Slide a PC card with a remover tape affixed into the Handheld Terminal.

Make sure that the top surface of the card is facing in the same direction as the Handheld Terminal display. You will not be able to insert the card all the way into the slot if it is not oriented correctly.

Be sure to fold the tab part of the remover tape affixed to the card so it is not damaged when you replace the card compartment cover.

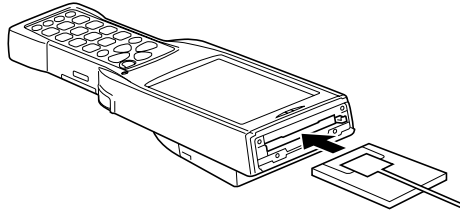

4. Replace the PC card compartment cover, and secure it in place with its screws.

Important!

If you cannot eject a PC card from the slot for some reason, carefully use a flat blade screwdriver to pull out the lever located at the right of the card, as shown in the illustration. While pulling out on the tab, pull the card from the slot. Never try to pull on the tab with your fingernail. Doing so can cause your fingernail to break.

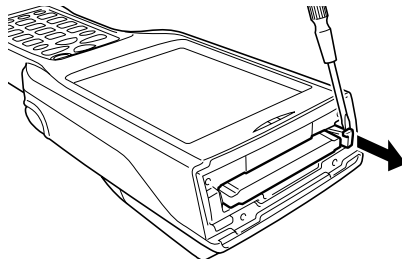

E-56





Using CF Card Extension Unit

The CF Card Extension Unit (DT-894CFU) supports use of Compact flash (CF) Type I cards and Type II cards (3.3/5.0V).

DT-894CFU

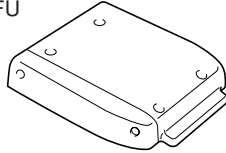

Bundled Item

Protector

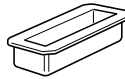

Attach to the connector part.

4 screws

Large Card Cover

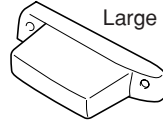

Use this cover when you have a data communication card or other large card installed in the card slot.

Use the procedure below to load and remove CF cards.

Important!

- Installing some cards will make it impossible to close the card slot cover. When that happens, you can either use the Large Card Cover or you can use the Handheld Terminal and CF card without a card slot cover. Keep the card slot cover in a safe place where you will not lose it. Note that the Handheld Terminal is not water resistant while its card slot cover is removed. Exercise special care when using the Handheld Terminal without its card slot cover attached.
- When using a CF storage card, be sure to close the card slot cover.

Attaching the CF Card Extension Unit

Attach the CF Card Extension Unit to the back of the Handheld Terminal. The CF Card Extension Unit connector is located under a protective cover.

1. Loosen two screws and detach the protector from the connector.

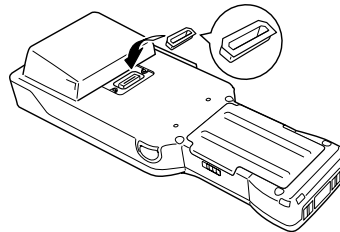
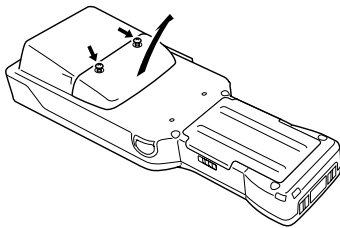

2. Attach the CF Extension Card Unit after peeling off the seals (2) on the back, and then firmly secure it by fastening all the way down on the back of the Handheld Terminal with the screws ①, ②, ③ and ④ provided. Although screws ③ and ④ may be particularly difficult to insert, make sure they are inserted all the way in.

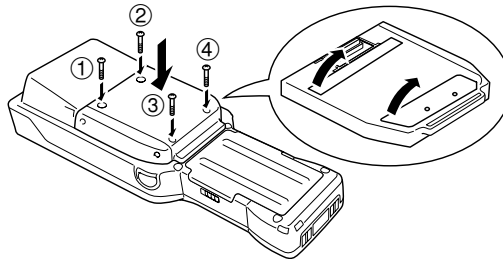

E-57





Loading a CF Card

1. Wipe the surfaces of the card so it is free of any dirt, dust, or oil.
2. Remove the screws that secure CF Extension Unit in place, and then remove the card slot cover.

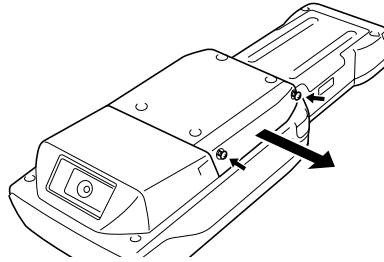

3. Making sure that the top surface of the card is facing in the same direction as the Handheld Terminal display, slide the card into the slot.
You will not be able to insert the card all the way into the slot if it is not oriented correctly.

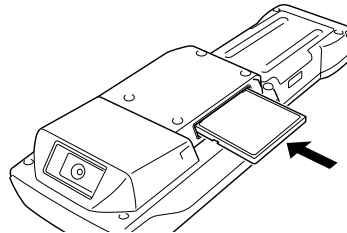

4. Replace the CF card compartment cover, and secure it in place with its screws.
When removing a card, hook your finger on the rim of the card and pull.

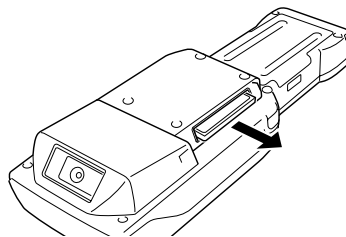

CF Card Extension Unit (DT-894CFU) Specifications

Card Slot:	Compact Flash Card Type I/Type II (3.3V)
Dimensions:	Using Standard Card Cover: Approximately 70(W) × 78(D) × 13(H) mm (2 ³ / ₄ "W × 3 ¹ / ₈ "D × 1/2"H) Using Large Card Cover: Approximately 85(W) × 78(D) × 13(H) mm (3 ³ / ₈ "W × 3 ¹ / ₈ "D × 1/2"H)
Weight:	Using Standard Card Cover: Approximately 40g (1.4oz) Using Large Card Cover: Approximately 45g (1.6oz)

E-58



Using Rechargeable Battery Pack

Your Handheld Terminal supports use of two battery pack types of different capacity. You can select the one that best suits your needs in terms of operating time, the type of options you need to use, etc.

When using the large-capacity battery pack, you need to use the special large-capacity battery pack cover that comes with the battery pack (DT-5025LBAT).

Important!

- **Store a battery pack in its special soft case whenever you are not using it.**
- **If the battery pack has been left over unused for a long period of time, the capacity remained decreases due to spontaneous discharge or chemical decomposition by the battery pack itself. If the battery pack fails to hold its operating duration after it has been fully charged, replace it with a new one. The battery pack may reach the end of its service life.**

Battery Pack Specifications



Model:	DT-5023BAT
Rated Capacitance:	1550mAh
Rated Voltage:	3.7V
Dimensions:	Approximately 37(W) × 57(D) × 13(H) mm (1½"W × 2¼"D × ½"H)
Weight:	Approximately 45g (1.6oz)
Bundled Item:	Soft case



Large-capacity Battery Pack Specifications

Model:	DT-5025LBAT
Rated Capacitance:	3400mAh
Rated Voltage:	3.7V
Dimensions:	Approximately 37(W) × 57(D) × 24(H) mm (1½"W × 2¼"D × 1"H)
Weight:	Approximately 87g (3.1oz)
Bundled Item:	Soft case



CASIO®

CASIO COMPUTER CO., LTD.

6-2, Hon-machi 1-chome
Shibuya-ku, Tokyo 151-8543, Japan

Printed on recycled paper.

PN410369-005
MO0504-F Printed in Japan

Free Manuals Download Website

<http://myh66.com>

<http://usermanuals.us>

<http://www.somanuals.com>

<http://www.4manuals.cc>

<http://www.manual-lib.com>

<http://www.404manual.com>

<http://www.luxmanual.com>

<http://aubethermostatmanual.com>

Golf course search by state

<http://golfingnear.com>

Email search by domain

<http://emailbydomain.com>

Auto manuals search

<http://auto.somanuals.com>

TV manuals search

<http://tv.somanuals.com>