

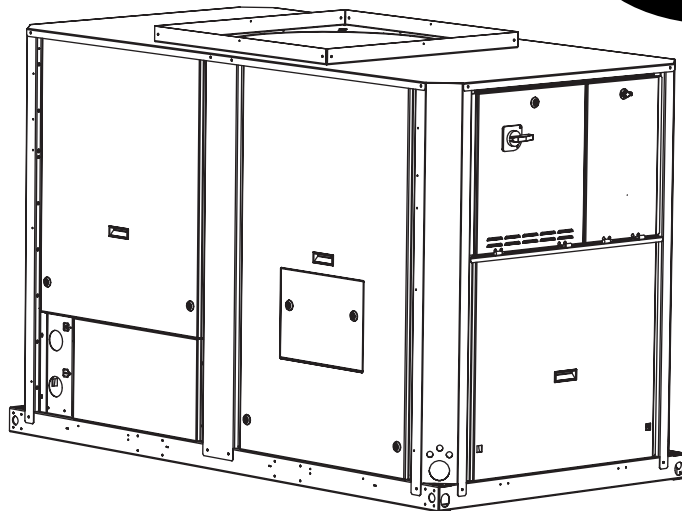

30RA/RH "B"
30RY/RYH "B"
PRO-DIALOG Control

PRO-DIALOG

AQUASNAP

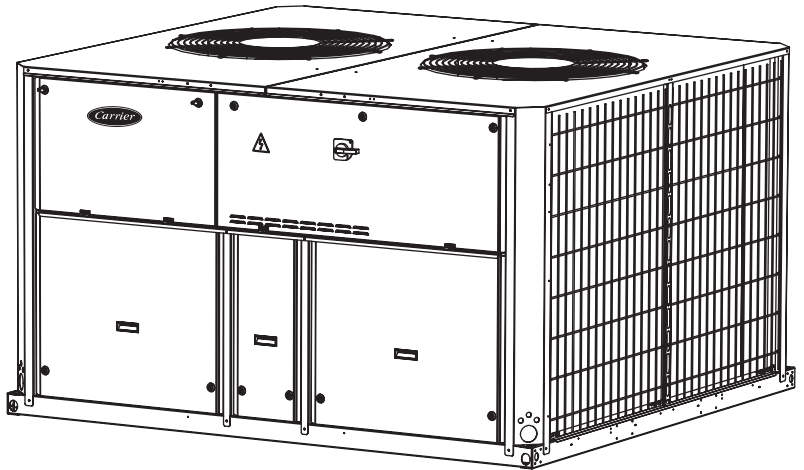
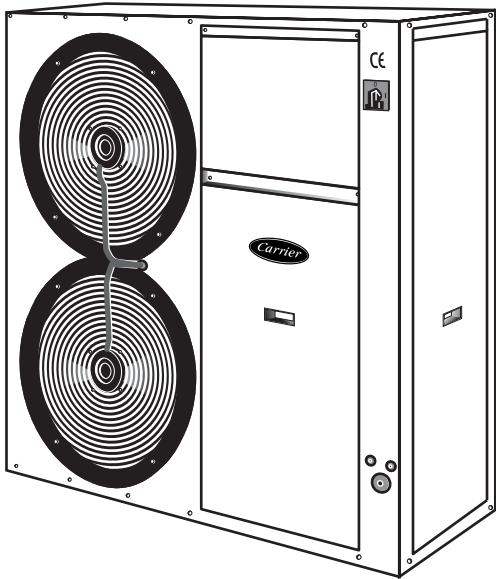

Operation and maintenance instructions



Quality Management System Approval





TABLE OF CONTENTS

1 - SAFETY CONSIDERATIONS	4
1.1 - General	4
1.2 - Avoid electrocution	4
2 - GENERAL DESCRIPTION	4
2.1 - General	4
2.2 - Abbreviations used	4
3 - HARDWARE DESCRIPTION	5
3.1 - General	5
3.2 - Electrical supply to boards	5
3.3 - Light emitting diodes on boards	5
3.4 - The sensors	5
3.5 - The output controls	5
3.6 - Connections at the user's terminal block	6
3.6.1 - General description	6
3.6.2 - Volt-free contact on/off/cooling/heating without multiplexing	8
3.6.3 - Volt-free contact on/off/cooling/heating with multiplexing	8
3.6.4 - Demand limit or setpoint volt-free contact for single-circuit units	8
3.6.5 - Demand limit volt-free contact for dual-circuit units	8
3.6.6 - Water setpoint selection volt-free contact with multiplexing for dual-circuit units	8
4 - SETTING UP PRO-DIALOG CONTROL	9
4.1 - Local interface general features	9
4.2 - Unit start/stop control	10
4.2.1 - Description	10
4.2.2 - Stopping the unit in local mode	10
4.2.3 - Starting unit and selecting an operating type	10
4.3 - Menus	11
4.3.1 - Selecting a menu	11
4.3.2 - Selecting a menu item	11
4.3.3 - Modifying the value of a parameter/access to a sub-menu	11
4.3.4 - Expand display	12
4.3.5 - Description of the Information menu	15
4.3.6 - Description of the Temperatures menu	17
4.3.7 - Description of the Pressures menu	17
4.3.8 - Description of the Setpoints menu	17
4.3.9 - Description of the Inputs menu	18
4.3.10 - Description of the Outputs/Tests menu	19
4.3.11 - Description of the configuration menu	22
4.3.12 - Description of the Alarms menu	28
4.3.13 - Description of the Alarms History menu	28
4.3.14 - Runtime menu description	28

5 - PRO-DIALOG CONTROL OPERATION	29
5.1 - Start/stop control	29
5.2 - Heating/cooling operation	30
5.2.1 - General	30
5.2.2 - Heating/cooling selection	30
5.3 - Evaporator water pump control	31
5.4 - Control interlock contact	31
5.5 - Evaporator heater control	31
5.6 - Control point	31
5.6.1 - Active setpoint	31
5.6.2 - Reset	33
5.7 - Demand limit	33
5.8 - Night mode	33
5.9 - Capacity control	33
5.10 - Head pressure control	33
5.11 - Defrost function	34
5.12 - Additional electric heater stage control	34
5.13 - Control of a boiler	34
5.14 - Master/slave assembly	34
5.15 - Controlling Pro-Dialog units with a System Manager	34
6 - DIAGNOSTICS - TROUBLESHOOTING	35
6.1 - General	35
6.2 - Displaying alarms	35
6.3 - Resetting alarms	35
6.4 - Alarm codes	35

GENERAL LEGEND

Each of the following drawings is replaced in the whole document by the corresponding explanation:

-  Start/stop button
-  Return key
-  Down arrow
-  Up arrow
- Δ DELTA T. Example: temperature difference between entering and leaving heat exchanger temperatures
-  - C - means character is flashing

The cover graphics are solely for illustration and forms no part of any offer for sale or any sale contract. The manufacturer reserves the right to change the design at any time without notice.

1 - SAFETY CONSIDERATIONS

1.1 - General

Installation, start-up and servicing of equipment can be hazardous if certain factors particular to the installation are not considered: operating pressures, presence of electrical components and voltages and the installation site (elevated plinths and built-up up structures). Only properly qualified installation engineers and highly qualified installers and technicians, fully trained for the product, are authorised to install and start-up the equipment safely. During all servicing operations all instructions and recommendations which appear in the installation and service instructions for the product, as well as on tags and labels fixed to the equipment and components and accompanying parts supplied separately, must be read, understood and followed.

- Apply all standard safety codes and practices.
- Wear safety glasses and gloves.
- Use the proper tools to move heavy objects. Move units carefully and set them down gently.

1.2 - Avoid electrocution

Only personnel qualified in accordance with IEC (International Electrotechnical Commission) recommendations may be permitted access to electrical components. It is particularly recommended that all sources of electricity to the unit be shut off before any work is begun. Shut off the main power supply at the main circuit breaker or isolator.

IMPORTANT: *This equipment uses and emits electromagnetic signals. Tests have shown that the equipment conforms to all applicable codes with respect to electromagnetic compatibility.*

RISK OF ELECTROCUTION: *Even when the main circuit breaker or isolator is switched off, certain circuits may still be energised, since they may be connected to a separate power source.*

RISK OF BURNS: *Electrical currents cause components to get hot either temporarily or permanently. Handle power cable, electrical cables and conduits, terminal box covers and motor frames with great care.*

Fan start-up:

ATTENTION: *In accordance with the operating conditions the fans can be cleaned periodically. A fan can start at any time, even if the unit has been shut down.*

2 - GENERAL DESCRIPTION

2.1 - General

Pro-Dialog is a system for controlling single or dual-circuit 30RA/RV air-cooled liquid chillers or air-to-water 30RH/RVH heat pumps. Pro-Dialog controls compressor start-up needed to maintain the desired heat exchanger entering or leaving water temperature. In cooling mode it controls the operation of the fans to maintain the correct condensing pressure in each circuit. For heat pump units it controls and optimises the defrost cycles of each circuit in order to minimize the heating capacity reduction. Safety devices are constantly monitored by Pro-Dialog to ensure their safe operation. Pro-Dialog also gives access to a Quick Test program covering all inputs and outputs.

All PRO-DIALOG controls can work in accordance with three independent modes:

- Local mode: the machine is controlled by commands from the user interface.
- Remote mode: the machine is controlled by remote contacts (voltage-free contacts).
- CCN mode: the machine is controlled by commands from the Carrier Comfort Network (CCN). In this case, a data communication cable is used to connect the unit to the CCN communication bus.

The operating mode must be chosen with the Start/Stop button described in section 4.2.1. When the PRO-DIALOG system operates autonomously (Local or Remote mode) it retains all of its own control capabilities but does not offer any of the features of the CCN network.

2.2 - Abbreviations used

In this manual, the refrigeration circuits are called circuit A and circuit B. The compressors in circuit A are labelled A1, A2 and A3. Those in circuit B are B1, B2 and B3.

The following abbreviations are used frequently:

CCN : Carrier Comfort Network

CCn : Operating type: CCN

LED : Light Emitting Diode

LOFF : Operating type: Local Off

L-On : Operating type: Local On mode

L-Sc : Operating type: Local On following a time schedule

MASt : Operating type: master unit (master/slave assembly)

rEM : Operating type: by remote contacts

SCT : Saturated Condensing Temperature

SIO : Sensor Bus (internal communication bus linking the basic board to the slave boards)

SST : Saturated Suction Temperature

TXV : Thermal Expansion Valve

3 - HARDWARE DESCRIPTION

3.1 - General

Figure 1

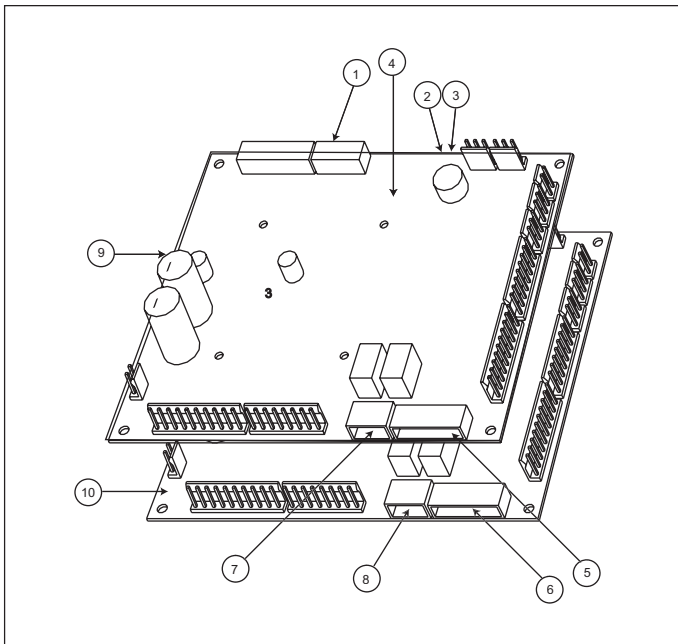

Legend

- 1 CCN connector
- 2 Red LED, status of the board
- 3 Green LED, communication bus SIO
- 4 Orange LED, communication bus CCN
- 5 Remote master board customer control connection contacts
- 6 Remote slave board customer control connection contacts
- 7 Master board customer connection relay outputs
- 8 Slave board customer connection relay outputs
- 9 Master NRCP basic board
- 10 Slave NRCP basic board

The control system consists of an NRCP-BASE board for single-circuit units and two NRCP-BASE boards (a master and a slave board) for dual-circuit units. Heat pump units equipped with optional additional heater stages use an additional board, type PD-AUX. All boards communicate via an internal SIO bus. The NRCP-BASE boards continuously manage the information received from the various pressure and temperature probes. The NRCP-BASE master board incorporates the program that controls the unit.

The user interface consists of two display blocks with up to 26 LEDs and 16 buttons (according to unit type). It is connected to the main basic board and gives access to a full array of control parameters.

3.2 - Electrical supply to boards

All boards, except the PD-RCPM board, are supplied from a common 24 V a.c. supply referred to earth.

CAUTION: Maintain the correct polarity when connecting the power supply to the boards, otherwise the boards may be damaged.

In the event of a power supply interrupt, the unit restarts automatically without the need for an external command. However, any faults active when the supply is interrupted are saved and may in certain cases prevent a circuit or unit from restarting.

3.3 - Light emitting diodes on boards

All boards continuously check and indicate the proper operation of their electronic circuits. A light emitting diode (LED) lights on each board when it is operating properly.

- The red LED flashing for a 2 second period on the NRCP-BASE board indicates correct operation. A different rate indicates a board or a software failure.
- On dual-circuit units or units equipped with optional board, the green LED flashes continuously on all boards to show that the board is communicating correctly over its internal bus. If the LED is not flashing, this indicates a SIO bus wiring problem.
- The orange LED of the master board flashes during any communication via the CCN bus.

3.4 - The sensors

Pressure sensors

Two types of electronic sensors are used to measure the suction and discharge pressure in each circuit.

Thermistors

The evaporator water sensors are installed in the entering and leaving side. The outdoor temperature sensor is mounted below the control box. An optional water system temperature sensor can be used for master/slave assembly control (in the case of leaving water control).

In heat pump units a sensor placed on an air heat exchanger pipe ensures defrost operation.

3.5 - The controls

Evaporator pumps

The controller can regulate one or two evaporator pumps and takes care of automatic change-over between pumps.

Evaporator heater

It protects the evaporator (and the pipe heater for units without pump) against freezing if the unit is off.

Boiler

This relay output authorises start/stop of a boiler.

Condensate defrost heater

This heater is used for heat pump units and is located at the bottom of the air heat exchanger of each circuit. It prevents ice build-up, if defrost cycles are initiated at low outdoor temperatures.

3.6 - Connections at the user's terminal block

3.6.1 - General description

The contacts below are available at the user's terminal block on the NRCP-BASE board (see figure 1). Some of them can only be used if the unit operates in remote operating type (rEM). The following table summarises the connections at the user's terminal block.

SINGLE-CIRCUIT UNITS					
Description	Connector/channel	Terminal	Board	Remarks	Remarks
Alarm relay output	J3 / CH24	30 - 31	NRCP-BASE	Indicates alarms	Volt-free contact 24 V a.c. 48 V d.c. max, 20 V a.c. or V d.c., 3 A max, 80 mA min, external power supply. Connector: 4 pin WAGO 734-104 pitch 3.5. One per board needed.
Boiler relay output	J3 / CH25	37 - 38	NRCP-BASE	Boiler start/stop control output. See section 5.13.	
Contact 1: start/stop/heat/cool	J4 / CH8	32 - 33	NRCP-BASE	The contacts are used for unit start/stop and heat/cool control. They are only taken into account if the unit is under remote operation control (rEM). See the description of these contacts in sections 3.6.2 and 3.6.3.	24 V a.c., 20 mA Connector: 8 pin WAGO 734-168, pitch 3.5
Contact 2: start/stop/heat/cool	J4 / CH9	63 - 64	NRCP-BASE		
Contact 3: demand limit selection or setpoint selection	J4 / CH10	73 - 74	NRCP-BASE	Depending on the configuration, this dry contact can be used for remote setpoint selection or demand limit selection (see sections 4.3.11.3 and 3.6.4). - The remote setpoint selection contact is only taken into account if the unit is in remote control operating type. - The remote demand limit selection contact is active whatever the operating type of the unit.	
User safety loop input	J4 / CH11a	34 - 35	NRCP-BASE	This contact is mounted in series with the water flow control contact. It can be used for any customer safety loop that requires that the unit is stopped, if it is open. If it is unused this contact must be bridged.	
Connection to CCN	J12	1 - 2 - 3	NRCP-BASE	An RS-485 bus is used for connection to the CCN. - Pin 1: signal + - Pin 2: ground - Pin 3: signal -	Connector: 3 pin WAGO 231-303, pitch 5.08

DUAL-CIRCUIT UNITS					
Description	Connector/channel	Terminal	Board	Remarks	Remarks
Alarm relay output circuit A	J3 / CH24	30A - 31A	Master NRCP-BASE	Indicates alarms/alerts for circuit A*	Volt-free contact 24 V a.c. 48 V d.c. max, 20 V a.c. or V d.c., 3 A max, 80 mA min, external power supply.
Alarm relay output circuit B	J3 / CH24	30B - 31B	Slave NRCP-BASE	Indicates alarms/alerts for circuit B*	
Boiler relay output	J3 / CH25	37 - 38	Master NRCP-BASE	Boiler start/stop control output. See section 5.13.	Connector: 4 pin WAGO 734-104 pitch 3.5. One per board needed.
Contact 1: start/stop/heat/cool	J4 / CH8	32 - 33	Master NRCP-BASE	The contacts are used for unit start/stop and heat/cool control. They are only taken into account if the unit is under remote operation control (rEM). See the description of these contacts in sections 3.6.2 and 3.6.3.	24 V a.c., 20 mA Connector: 8 pin WAGO 734-168, pitch 3.5
Contact 2: start/stop/heat/cool	J4 / CH9	63 - 64	Master NRCP-BASE		
Contact 3: demand limit selection	J4 / CH10	73 - 74	Master NRCP-BASE	These dry contacts are used for demand limit selection. See description of these contacts in section 3.6.5.	
Contact 4: demand limit selection	J4 / CH10	75 - 76	Slave NRCP-BASE	The remote demand limit selection contact is active whatever the operating type of the unit.	
Contact 5: setpoint selection	J4 / CH8	65 - 66	Slave NRCP-BASE	These dry contacts are used for setpoint selection. They are only taken into account if the unit is in remote control operating type (rEM).	
Control contact 6: setpoint selection	J4 / CH9	67 - 68	Slave NRCP-BASE	See the description of these contacts in sections 3.6.6.	
User safety loop input	J4 / CH11a	34 - 35	Master NRCP-BASE	This contact is mounted in series with the water flow control contact. It can be used for any customer safety loop that requires that the unit is stopped, if it is open. If it is unused this contact must be bridged.	
Connection to CCN	J12	1 - 2 - 3	Master NRCP-BASE	An RS-485 bus is used for connection to the CCN. - Pin 1: signal + - Pin 2: ground - Pin 3: signal -	

* The operation of these relays can vary depending on the user configuration. See section 'Description of the User 2 configuration sub-menu'.

3.6.2 - Volt-free contact on/off/cooling/heating without multiplexing

If the automatic heating/cooling changeover function is not selected (see sections 4.3.11.3, 5.1 and 5.2) the operation of contacts 1 and 2 is as follows:

	OFF	ON cooling	ON heating
Contact 1	Open	Closed	Closed
Contact 2	-	Open	Closed

Contact status not significant

3.6.3 - Volt-free contact on/off/cooling/heating with multiplexing

If the automatic heating/cooling changeover function is selected (see sections 4.3.11.3, 5.1 and 5.2) the operation of contacts 1 and 2 is multiplexed:

	OFF	ON cooling	ON heating	ON auto
Contact 1	Open	Closed	Closed	Open
Contact 2	Open	Open	Closed	Closed

NOTE: The automatic changeover function (ON auto) selects the cooling or heating mode based on the outdoor temperature (see section 5.2).

3.6.4 - Demand limit or setpoint volt-free contact for single-circuit units

On single-circuit units contact 3 determines the selection of demand limit or setpoint, based on the configuration (see User Configuration 1 menu).

	Demand limit selection		Setpoint selection	
	100% (no limit)	Limit 1	Setpoint 1	Setpoint 2
Contact 3	Open	Closed	Open	Closed

3.6.5 - Demand limit volt-free contact for dual-circuit units

On dual-circuit units the operation of the demand limit selection contacts is multiplexed. The demand limit setpoints are adjustable in the setpoint menu (see section 4.3.8).

	100% (no limit)	Limit 1	Limit 2	Limit 3
Contact 3	Open	Closed	Open	Closed
Contact 4	Open	Open	Closed	Closed

3.6.6 - Water setpoint selection volt-free contact with multiplexing for dual-circuit units

On dual-circuit units the operation of the cold water or hot water setpoint selection contacts is multiplexed. The set-points are adjustable in the setpoint menu (see section 4.3.8). Auto means that the active setpoint is determined by the setpoint schedule (see section 5.6.1).

Cooling mode				
	Setpoint 1	Setpoint 2	Setpoint 3	Auto
Contact 5	Open	Open	Closed	Closed
Contact 6	Open	Closed	Open	Closed
Heating mode				
	Setpoint 1	Setpoint 2	Setpoint 3	Auto
Contact 5	Open	Open	Closed	Closed
Contact 6	Open	Closed	Open	Closed

4 - SETTING UP PRO-DIALOG CONTROL

4.1 - Local interface general features

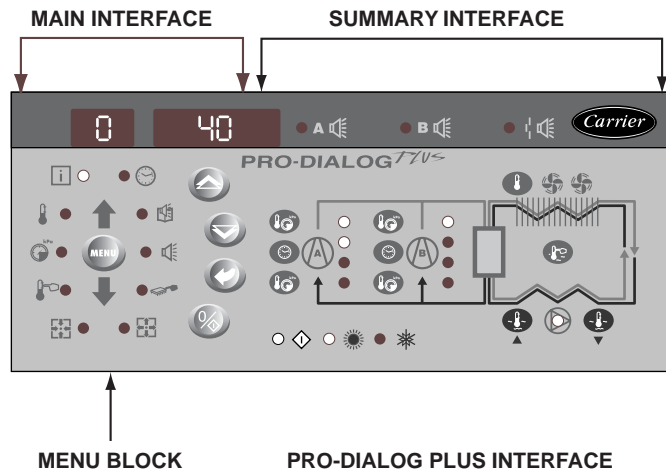

PRO-DIALOG JUNIOR INTERFACE

The local interface enables a number of operating parameters to be displayed and modified.

The interface consists of two distinct parts: the main interface (left-hand section) and the summary interface (right-hand section).

Main interface

It gives access to all PRO-DIALOG data and operating functions. It consists of:

- A two-digit display showing the number of the item selected.
- A four-digit display showing the contents of the item selected.
- LEDs and buttons for unit start/stop, menu selection, menu item selection and value adjustment.

PRO-DIALOG Junior interface: On some units the local user interface consists only of a simplified main interface (left-hand section) that is identical to the main interface described below, but does not include the menu block diodes.

MAIN INTERFACE









BUTTON	NAME	DESCRIPTION
	Menu	Permits the selection of a main menu. Each main menu is represented by an icon. The icon is lit if active.
	Up arrow	Permits scrolling through the menu items (in the two-digit display). If the modification mode is active this button authorises increase of the value of any parameter.
	Down arrow	Permits scrolling through the menu items (in the two-digit display). If the modification mode is active this button authorises decrease of the value of any parameter.
	Enter	Gives access to the modification mode, validates a modification or displays expanded item description.
	Start/stop	Authorises start or stop of the chiller in local mode or modification of its operating type.

MAIN INTERFACE MENU LED'S





LED*	NAME	DESCRIPTION	INTERFACE DISPLAY
	INFORMATION menu	Displays the general operating parameters for the unit.	Information
	TEMPERATURES menu	Displays the unit operating temperatures.	Temperatures
	PRESSURES menu	Displays the unit operating pressures.	Pressures
	SETPOINTS menu	Displays the unit setpoints and enables them to be modified.	Setpoints
	INPUTS menu	Displays the status of the unit digital and analogue inputs.	Inputs
	OUTPUTS/TESTS menu	Displays the status of the unit outputs and enables them to be tested.	Outputs
	CONFIGURATIONS menu	Displays the unit configuration and enables it to be modified.	Configuration
	ALARMS menu	Displays active alarms.	Alarms
	ALARMS HISTORY menu	Displays the history of the alarms.	History
	RUNTIMES menu	Displays the operating times and number of starts for the unit and the compressors.	Runtimes

* Not available on the PRO-DIALOG Junior interface.

The summary interface (right hand section) includes a mimic diagram of the unit, together with push-buttons and LEDs. It gives quick access to the main operating parameters of the unit.

SUMMARY INTERFACE LEDs*	
LED	INDICATION WHEN LIT
	Green LED: The unit is authorised to start or is already running
	Red LED: - Lit: circuit A or unit shut down by alarm - Flashing: circuit A or unit running with alarm present
	Red LED: - Lit: circuit B or unit shut down by alarm - Flashing: circuit B or unit running with alarm present
	Red LED: Water flow switch default or user safety lock open.
	Green LED: The evaporator pump is running.
	Yellow LEDs: From top to bottom - start/stop status of compressor A1, A2 and A3 or B1, B2 and B3. Flashing LED indicates that the circuit is in the protection or defrost mode (A or B).
	Green LED: The unit operates in heating mode.
	Green LED: The unit operates in cooling mode.

* Not available on the PRO-DIALOG Junior interface.

SUMMARY INTERFACE PUSH BUTTONS*	
BUTTON	DISPLAY
	Blue button: evaporator leaving or entering water temperature in °C Gray button: outdoor air temperature in °C
	Control point (setpoint + reset) in °C
	Press 1: circuit A/B discharge pressure in kPa Press 2: circuit A/B saturated condensing temperature in °C
	Press 1: circuit A/B suction pressure in kPa Press 2: circuit A/B saturated suction temperature in °C
	Press 1: compressor A1/B1 operating hours in h/10 or h/100 Press 2: compressor A2/B2 operating hours in h/10 or h/100 Press 3: compressor A3/B3 operating hours in h/10 or h/100

* Not available on the PRO-DIALOG Junior interface.

4.2 - Unit start/stop control

4.2.1 - Description

The unit start/stop can be controlled by one of the following methods:

- Locally on the actual unit (Local control type)
- By remote control with the aid of user contacts (remote control type)
- By CCN control with the aid of the CCN (CCN control type)

The main interface includes a Start/Stop button which can be used to stop or start the unit in the local operating type or to select the remote or CCN operating type.

The available operating types are described in the following table.

The following operating types can be selected using the Start/Stop button:

OPERATING TYPES	
4 DIGIT DISPLAY	DESCRIPTION
LOFF	Local Off. The unit is halted in local mode.
L-On	Local On. The unit is in local control mode and is authorised to start.
L-Sc*	Local On - timer control. The unit is in local control mode. It is authorised to start if the period is occupied. If the timer program for unit operation is unoccupied, the unit remains shut down until the period becomes occupied.
CCN*	CCN. The unit is controlled by CCN commands.
rEM*	Remote. The unit is controlled by remote control contacts.
MAST*	Master Unit. The unit runs as a master in a two unit lead/lag arrangement. This is displayed if the unit is configured for master/slave control.

Legend

* Displayed if the configuration requires it. Section 5.1 gives a more detailed description of the commands to start/stop the unit, analysed by operating type.

4.2.2 - Stopping the unit in local mode



The unit can be stopped in local mode at any time by pressing the Start/Stop button.

TO STOP THE UNIT			
BUTTON	ACTION	2-DIGIT DISPLAY	4-DIGIT DISPLAY
	Press the Start/Stop button for less than 4 seconds (one short press is enough).	C	LOFF
	If the button is released, the unit stops without the need for further action.	t	LOFF

4.2.3 - Starting unit and selecting an operating type

The unit can be started in local mode, or unit operating type can be changed at any time using the Start/Stop button. In the example that follows, the unit is stopped (LOFF) and the user wants to start the unit in local mode.

START UP WITH THE PREVIOUSLY USED OPERATING TYPE WHEN THE UNIT IS STOPPED IN LOCAL MODE (LOFF)

BUTTON	ACTION	2-DIGIT DISPLAY	4-DIGIT DISPLAY
	The unit is in local stop mode. The previously used operating type is local on (L-ON)		LOFF
	Press the Start/Stop button for 4 seconds (one short press-down is sufficient). L-ON illuminates immediately. "C" flashes in the 2-digit display to show that the controller is awaiting confirmation.		L-On
	Press the Enter button to confirm the operating type. "t" is displayed in the 2-digit display to indicate the operating type selected. If the Enter button is not pressed soon enough, the controller will cancel the change and remain in the stop mode.	t	L-On

CHANGING THE OPERATING TYPE

BUTTON	ACTION	2-DIGIT DISPLAY	4-DIGIT DISPLAY
	Continually press the operating type selection button for more than 4 seconds.	C	LOFF
	Hold down the Start/Stop button. The available operating types are displayed one by one until the button is released.		L-On L-Sc ↑ rEM ↓
	Release the Start/Stop button if the operating type you want is displayed (in this example L-On). "C" flashes in the 2-digit display to show that the controller is awaiting confirmation.		L-On
	Press the Enter button to confirm the operating type selected (in this example: L-On). "t" is displayed in the 2-digit display to indicate the operating type selected. If the Enter button is not pressed soon enough, the controller will cancel the change and continue to use the previous operating type.	t	L-On

4.3 - Menus

4.3.1 - Selecting a menu

The MENU button authorises you to select a menu from the 10 main menus that are available. Each time you press this button one of the 10 LEDs lights up in turn alongside each of the icons representing a main menu. The active menu is the one against which the LED is lit. If a menu is empty then its LED is not lit. To scroll quickly through the menus, hold the MENU button down.

4.3.2 - Selecting a menu item

The up and down Arrow buttons let you scroll through the menu items. Menu item numbers are displayed in the two-digit display. The item number increases or decreases every time you press the up or down Arrow button. The menu items that are not in use or incompatible with the configuration are not displayed. The value or status associated with the active item is displayed in the four-digit display. To scroll quickly through the items, hold the up or down Arrow button down.

The following example shows how to access item 3 in the Pressures menu.

SELECTING A MENU ITEM

OPERATION	PRESS BUTTON	MENU LED	ITEM NUMBER 2-DIGIT DISPLAY
Press the MENU button until the LED marked PRESSURE lights.			0
Note: On the PRO-DIALOG Junior interface the menu LEDs are not available. Instead, each time the menu button is pressed, the name of the active menu is displayed in the 4-digit display. In this example, press the MENU button until PRESSURE is displayed in the 4-digit display.			
Press one of the Arrow buttons until the two-digit display shows 3 (item number 3).			1
			2
			3

4.3.3 - Modifying the value of a parameter/access to a sub-menu

Press the Enter button for more than 2 seconds to enter the modification mode or to select a sub-menu. This lets you correct the value of an item or select a sub-menu with the aid of the up and down Arrow buttons (if you are authorised to overwrite the item concerned). When modification mode is activated, the LED for the main menu to which the item belongs as well as the 2-digit display flash in the menu block. Once the required value is obtained, press the Enter button again to validate the change or to access the sub-menu. The LED for the menu to which the item and the 2-digit display belong then stops flashing, indicating that modification mode no longer applies.



















In modification mode, the value to be modified increases or decreases in steps of 0.1 every time you press the Arrow buttons. Holding one of these buttons down increases the rate of increase or decrease.

NOTE: The access to a sub-menu may require entering a password. This is automatically requested. See section 4.3.11.2.

The following example shows how to modify the value of item 1 in the Setpoint menu.

4.3.4 - Expand display

Pressing the Enter button causes a 23 character text expansion to be scrolled across the four-digit display. All user menus provide an expansion of the current displayed parameters. If the expansion is complete the four-digit display reverts to item value. This function can be inhibited through the User Configuration menu.

MODIFYING THE VALUE OF A PARAMETER				
OPERATION	PRESS BUTTON	MENU LED	ITEM NUMBER 2-DIGIT DISPLAY	ITEM VALUE 4-DIGIT DISPLAY
Hold on the MENU button until the LED for SETPOINT lights.			0	
PRO-DIALOG Junior interface: Press the menu button, until SETPOINTS is displayed in the 4-digit display			0	SEtPoint
Press one of the Arrow buttons until the two-digit display shows 1 (item number 1- cooling setpoint 2).			1	
The value for setpoint 2 is displayed in the four-digit display (6.0°C in this example).			1	6.0
Press the Enter button for more than 2 seconds to enable the value associated with item 1 to be modified. The Setpoint menu LED and the two-digit display flash indicating that modification mode is active.			1	6.0
Keep pressing the Down Arrow button until the value 5.7 is displayed in the four-digit display. The Setpoint menu LED and the two-digit display keep flashing.			1	5.9
			1	5.8
			1	5.7
Press the Enter button again to validate the change. The new setpoint is 5.7°C. The Setpoint menu LED and the two-digit display stop flashing, indicating that modification mode no longer applies.			1	5.7

MENU STRUCTURE

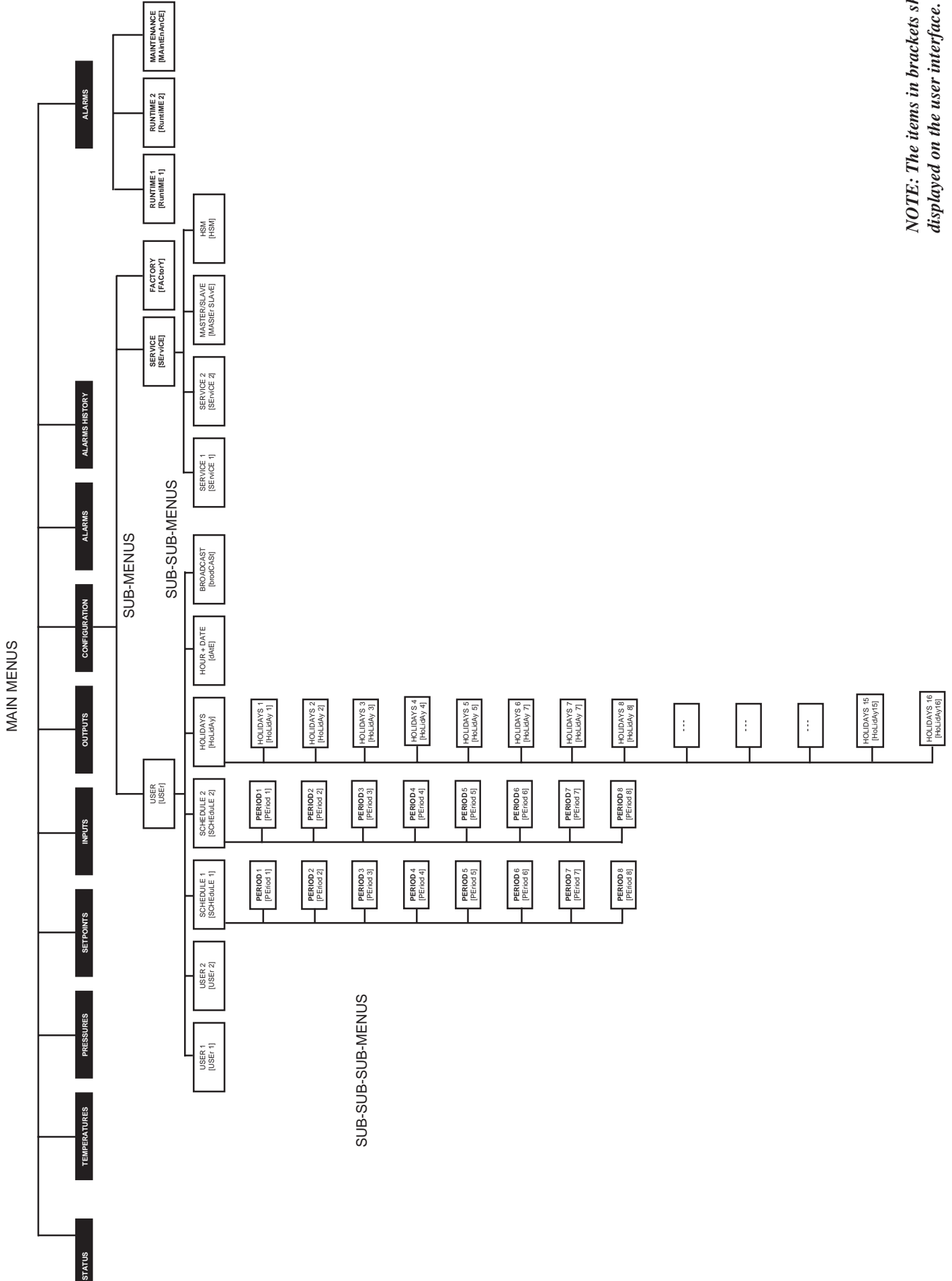

NOTE: The items in brackets show what is displayed on the user interface.

Menu tree structure

ITEM	STATUS	TEMP	PRESSURES	SETPOINTS	INPUTS	OUTPUTS	CONFIG	ALARMS	ALARMS HIST	RUNTIMES
0	Default display	Evaporator water entering temp.	Discharge pressure circuit A	Cooling setpoint 1	Contact 1: on/off/ heating/cooling	Compressor status circuit A	SUB-MENU: User Configuration (USER)	Number of active alarms/resets**	Historic alarm code 1**	SUB-MENU: Runtimes 1
1	Mode	Evaporator water leaving temp.	Suction pressure circuit A	Cooling setpoint 2	Contact 2: on/off/ heating/cooling	Compressor status circuit B*	SUB-MENU: Service Configuration (SERVICE)	Active alarm code 1**	Historic alarm code 2**	SUB-MENU: Runtimes 2
2	Chiller occupied mode*	Outdoor temperature	Discharge pressure circuit B*	Heating setpoint 1*	Contact 3: demand limit/setpoint selection	Two-speed fan status circuit A	SUB-MENU: Factory Configuration (FACTORY)	Active alarm code 2**	Historic alarm code 3**	SUB-MENU: Maintenance
3	Minutes left	Saturated discharge temperature circuit A	Suction pressure circuit B*	Heating setpoint 2*	Contact 4: demand limit selection*	Two-speed fan status circuit B*	-	Active alarm code 3**	Historic alarm code 4**	-
4	Cooling/heating selection*	Saturated suction temp. circuit A	-	Heating setpoint 3*	Contact 5: setpoint selection*	Single-speed fan status, ckt A + B*	-	Active alarm code 4**	Historic alarm code 5**	-
5	Cooling/heating status*	Saturated discharge temperature circuit B*	-	Auto changeover threshold (heating mode)*	Contact 6: setpoint selection*	Water pump 1 status*	-	Active alarm code 5**	Historic alarm code 6**	-
6	Unit capacity in %	Saturated suction temp. circuit B*	-	Auto changeover threshold (cooling mode)*	Safety loop status	Water pump 2 status*	-	-	Historic alarm code 7**	-
7	Capacity circuit A in %*	Defrost temperature, circuit A*	-	Setpoint demand limitation 1*	Water pump operation contact status*	Water heat exchanger + air heat exchanger heater status, circuit A	-	-	Historic alarm code 8**	-
8	Capacity circuit B in %*	Defrost temperature, circuit B*	-	Setpoint demand limitation 2*	Fault contact, compressor, circuit A*	-	-	-	Historic alarm code 9**	-
9	Heater stages in %*	System water temperature*	-	Setpoint demand limitation 3*	Fault contact, compressor, circuit B*	Alarm circuits A and B status	-	-	Historic alarm code 10**	-
10	Present demand limit in %	-	-	Ramp loading*	-	Boiler status*	-	-	-	-
11	Present lag limit in %*	-	-	Cooling - zero reset threshold*	-	Speed, fan A in %*	-	-	-	-
12	Setpoint in local control*	-	-	Cooling - full reset threshold*	-	Speed, fan B in %	-	-	-	-
13	Setpoint occupied mode*	-	-	Cooling - full reset value*	-	Reversing valve, circuit A*	-	-	-	-
14	Active setpoint	-	-	Heating - zero reset threshold*	-	Reversing valve, circuit B*	-	-	-	-
15	Control point	-	-	Heating - full reset threshold*	-	Status, heater stages*	-	-	-	-
16	Controlled water temperature	-	-	Heating - full reset value*	-	Local interface test	-	-	-	-

Legend
 * Displayed if the configuration requires it
 ** Displayed if the alarm exists
 - Not in use

4.3.5 - Description of the Information menu

INFORMATION MENU (3)

ITEM	FORMAT	UNITS	DESCRIPTION
0			Automatic display mode. It cycles through the following displays:
	±nn.n	°C	1: Controlled water temperature: temperature of the water that the unit tries to maintain at the control point.
			2: Unit operating type
	LOFF	-	Local Off
	L-On	-	Local On
	L-Sc	-	Local On - based on unit clock. Displayed if the CCN/clock board is installed.
	CCn	-	CCN Control. Displayed if the CCN/clock board is installed.
	rEM	-	Remote Control
	MASt	-	Master unit
			3: Unit status
	OFF	-	Off: Unit is stopped and not authorised to start.
	rEADY	-	Ready: Unit is authorised to start
	dELAY	-	Delay: Unit is in delay at start-up. This delay is active after the unit has been switched on. The delay can be configured in the User Configuration menu.
	StOPPIng	-	Stopping: Unit is currently stopping.
	rUnning	-	On: Unit is running or authorised to start.
	triPout	-	Fault shutdown.
	OvErridE	-	Limit: The operating conditions do not allow total unit operation.
	dEFROSt	-	Defrost: One circuit is in defrost mode.
			4. Unit occupied/unoccupied status
	OCCUPIEd	-	Occupied: Unit in occupied mode
	UNOCCUPIEd	-	Unoccupied: Unit in unoccupied mode
			5. Heating/cooling operating mode
	COOL	-	Cooling: Unit operates in cooling mode
	HEAT	-	Heating: Unit operates in heating mode
	StAndbY	-	Standby: Unit is in auto cooling/heating changeover mode, and is in standby
	Both	-	Both: The unit operates in cooling (compressors) and heating (boiler). Only with HSM operation.
			6: Alarm mode
	ALARm	-	Alarm: Unit is totally stopped because of failure.
	ALERt	-	Alert: Unit is in failure but not completely stopped.
			7: Master/Slave status
	MAStEr	-	Master: The master/slave control is active and the unit is the master
	SLAVe	-	Slave: The master/slave control is active and the unit is the slave
1 [1]	nn		Active mode codes. Each active mode is displayed in turn. This Item is masked when nil. Pressing the enter button when a mode code is displayed causes a character text expansion to be scrolled across the four-digit display. See the description in the following table
2 [2]		-	This item indicates the current unit occupied/unoccupied mode. Displayed if the CCN/clock board is installed.
	occu		Occupied
	unoc		Unoccupied
	Forc		The value is displayed in turn with 'Forc' when the unit is in CCN control and if this variable if forced through CCN.
3	nn.n	minutes	Start-up delay. This item indicates the minutes left before the unit can be started. This delay at start-up is always active after the unit has been switched on. The delay can be configured in the User Configuration 1 menu.
4 [2]		-	Heating/cooling on selection: This item is accessible in read/write, if the unit is in local control mode. It is only displayed, if the unit is in LOFF, L-On or L-Sc operating type. Displayed for heat pumps or if the unit controls a boiler.
	HEAt	-	Heating mode selection
	COOL	-	Cooling mode selection
	Auto	-	Automatic heating/cooling mode changeover selection. Only displayed if the auto changeover function is selected (User Configuration 1 menu).
5 [2]			Heating/cooling mode. This item indicates whether the unit is in cooling or heating. Displayed if the unit controls a boiler.
	HEAt	-	Heating
	COOL	-	Cooling
	StbY	-	Standby: Unit is in auto cooling/heating changeover mode, and is in standby.
	both	-	Both: The unit operates in cooling (compressors) and heating (boiler). Only with HSM operation.
	Forc	-	The value is displayed in turn with 'Forc' when the unit is in CCN control and if this variable if forced through CCN.
6	nnn	%	Total active capacity of unit. It is the percentage of compressor capacity used by the unit.
7	nnn	%	Total active capacity of circuit A. It is the percentage of compressor capacity used by on circuit A..
8 [2]	nnn	%	Total active capacity of circuit B. It is the percentage of compressor capacity used by on circuit B. Dual-circuit units only.
9 [2]	nnn	%	Active electric heating stages. Only displayed for heat pumps and if the unit controls additional electric heating stages.
10	nnn		Present demand limit. This is the authorised operating capacity of the unit. See section 5.7.
	Forc	%	The value is displayed in turn with 'Forc' when the unit is in CCN control and if this variable if forced through CCN.
11 [2]	nnn	%	Present lag chiller demand limit. Displayed when the master/slave control is selected.
12 [2]		-	Setpoint select in local mode. This point is read/write accessible. Displayed only when the unit is LOFF, L-On or L-Sc operating type.
	SP-1		SP-1 = cooling/heating setpoint 1
	SP-2		SP-2 = cooling/heating setpoint 2
	SP-3		SP-3 = heating setpoint 3
	AUtO		AUTO = active setpoint depends on schedule 2 (setpoint selection schedule). See section 5.6.1 & 4.3.11.6.
13 [2]		-	Setpoint occupied mode. Displayed if the CCN/clock board is installed.
	occu		Occupied: cooling setpoint 1 is active
	unoc		Unoccupied: cooling setpoint 2 is active
	Forc		The value shall be displayed in turn with 'Forc' when the unit is in CCN control and if this variable if forced through CCN.

INFORMATION MENU (3) continued

ITEM	FORMAT	UNITS	DESCRIPTION
14	±nn.n	°C	Active setpoint. This is the current cooling/heating setpoint: it refers to cooling setpoint 1 or cooling/heating setpoint 2. See section 5.6.1.
15	±nn.n Forc	°C	Control point. This is the setpoint used by the controller to adjust the temperature of the leaving or entering water (according to configuration). Control point = active setpoint + reset. See section 5.6 The value is displayed in turn with 'Forc' when the unit is in CCN control and if this variable is forced through CCN.
16	±nn.n	°C	Controlled water temperature. Water temperature that the unit tries to maintain at the control point.

1 This item is masked when nil.

2 This item is displayed in certain unit configurations only.

3 Access to this menu is read-only except for item 10 that can be forced when the unit is in Local operating type.

DESCRIPTION OF OPERATING MODES (ITEM 1 OF THE INFORMATION MENU)

MODE #	MODE NAME	DESCRIPTION
1	Delay at start-up active	The delay at start-up operates after the unit has been switched on. If the delay has not expired, the mode is active. The delay is configured in the User Configuration 1 menu.
2	2nd cooling/heating setpoint active	The second cooling/heating setpoint is active. See section 5.6.1
3	3rd heating setpoint active	The third heating setpoint is active. See section 5.6.1
4	Setpoint reset active	In this mode, the unit uses the reset function to adjust the leaving water temperature setpoint. See section 5.6.
5	Auto heating/cooling changeover active	If the unit is in auto mode, the heating/cooling changeover is automatic, based on the outdoor temperature. See section 5.2.
6	Demand limit active	In this mode, the demand at which the unit is authorised to operate is limited. See section 5.7.
7	Ramp loading active	Ramp loading is active. In this mode, the rate of water temperature drop or rise (heating mode) in °C/min is limited to a preset value in order to prevent compressor overloading. Ramp function must be configured (see User Configuration 1 menu). Ramp values can be modified (see Setpoint menu).
8	Water or air heat exchanger heater active	The water or air heat exchanger heater is active. See section 5.5.
9	Evaporator pump reversal in effect	The unit is fitted with two evaporator water pumps and reversal between pumps is in effect. See section 5.3.
10	Evaporator pump periodic start	The unit is stopped and the pump is started each day at 14.00 p.m. for two seconds. This function needs to be configured in the User Configuration 1 menu. See section 5.3 & 4.3.11.3.
11	Night condensing mode	The night mode is active. Fan runs at low speed (if permitted by operating conditions) and unit capacity can be limited. See section 5.8 & 4.3.11.3.
12, 13	Low suction temperature protection	12 = circuit A & 13 = circuit B. Protection for evaporator low suction temperature circuit is active. In this mode, circuit capacity is not authorised to rise and the circuit can be unloaded.
14, 15	High pressure protection	14 = circuit A & 15 = circuit B. The unit is in cooling or heating mode. The circuit is in high pressure protection mode because the HP protection threshold has been exceeded. Circuit has been unloaded and the circuit capacity is not authorised to rise.
16, 17	Defrost	16 = circuit A & 17 = circuit B. The unit is in heating mode, and the defrost sequence is active on the relevant circuit.
18	Low water entering temperature protection in heating mode	The unit is in heating mode and compressor start is not authorised, as the entering water temperature is below 10°C.
19, 20	Hot gas protection in heating mode	19 = circuit A & 20 = circuit B. The unit is in heating protection mode and hot gas discharge protection is active. In this mode, the circuit capacity cannot increase, and the circuit may be unloaded or go into defrost mode.
21, 22	Low suction temperature protection in heating mode	21 = circuit A & 22 = circuit B. The unit is in heating mode and low suction temperature protection is active. In this mode, circuit capacity is not authorised to rise and the circuit can be unloaded or go into defrost mode.
23	Boiler active	The unit controls a boiler and this is operating. See section 5.13.
24	Electric heating stages active	The unit controls additional electric heating stages, and these are operating. See section 5.12.
25	Unit in SM control	Unit is in control of a System Manager (FSM, CSM III or HSM).
26	Master/slave link active	Unit is connected to a secondary unit by a master slave link and the master/slave modes are active.
27	Low outside temperature protection	The unit is in heating mode, and compressor start-up is not permitted, when the outside air temperature is lower than the value configured in item 12 of the User 1 configuration menu. See the relevant section.

4.3.6 - Description of the Temperatures menu

TEMPERATURES MENU [2]			
ITEM	FORMAT	UNITS	COMMENTS
0	±nn.n	°C	Water heat exchanger entering water temperature
1	±nn.n	°C	Water heat exchanger leaving water temperature
2	±nn.n	°C	Outdoor temperature
3	±nn.n	°C	Saturated discharge temperature, circuit A
4	±nn.n	°C	Saturated suction temperature, circuit A
5 [1]	±nn.n	°C	Saturated discharge temperature, circuit B
6 [1]	±nn.n	°C	Saturated suction temperature, circuit B
7 [1]	±nn.n	°C	Defrost temperature, circuit A
8 [1]	±nn.n	°C	Defrost temperature, circuit B
9 [1]	±nn.n	°C	Chilled water system temperature. Used for master/slave control.

- 1 This item is displayed in certain unit configurations only
- 2 Access to this menu is read-only.

4.3.8 - Description of the Setpoints menu

SETPOINTS MENU [2]				
ITEM	FORMAT	UNITS	RANGE	COMMENTS
0	±nn.n	°C	See table below	This item lets you display and modify Cooling setpoint 1*
1	±nn.n	°C	See table below	This item lets you display and modify Cooling setpoint 2*
2	nnn	°C	See table below	This item lets you display and modify Heating setpoint 1* , only displayed for heat pumps.
3 [1]	nnn	°C	See table below	This item lets you display and modify Heating setpoint 2* , only displayed for heat pumps.
4 [1]	nn.n	°C	See table below	This item lets you display and modify Heating setpoint 3* , only displayed for heat pumps.
5 [1]	±nn.n	°C	3.8 to 50	Automatic changeover threshold, cooling mode. This item lets you display and modify the outdoor temperature threshold at which the unit changes over in cooling mode. See section 5.2. Displayed only if the auto cooling/heating changeover function is selected.
6 [1]	±nn.n	°C	0 to 46	Automatic changeover threshold, heating mode. This item lets you display and modify the outdoor temperature threshold at which the unit changes over in heating mode. Displayed only if the auto cooling/heating changeover function is selected and if the unit is a heat pump. The heating threshold must be 3.8°C below the cooling threshold, otherwise the new setpoint will be rejected.
7	nnn	%	0 to 100	Demand limit 1 setpoint. Limitation by volt-free contact. This item is used to define the maximum capacity that the unit is authorised to use, if the demand limit contact(s) activate limit 1. Contact control depends on the unit type and configuration. See sections 3.6.4 and 3.6.5.
8 [1]	nnn	%	0 to 100	Demand limit 2 setpoint. Limitation by volt-free contact. This item is used to define the maximum capacity that the unit is authorised to use, if the demand limit contact(s) activate limit 2. Contact control depends on the unit type and configuration. Displayed and used only for dual-circuit units. See section 3.6.5 for the contact control description.
9 [1]	nnn	%	0 to 100	Demand limit 3 setpoint. Limitation by volt-free contact. This item is used to define the maximum capacity that the unit is authorised to use, if the demand limit contact(s) activate limit 3. Displayed and used only for dual-circuit units. See section 3.6.5 for the contact control description.
10	±nn.n	°C/min	0.1 to 1.1	Cooling or heating ramp loading rate. This parameter is only accessible if the ramp function is validated in the User Configuration 1 menu. This item refers to the rates of temperature drop in °C in the evaporator. When capacity loading is effectively limited by the ramp, mode 7 is active.
11 [1]	±nn.n	°C	See table below	Zero reset threshold, cooling mode**
12 [1]	±nn.n	°C	See table below	Full reset threshold, cooling mode**
13 [1]	±nn.n	°C	See table below	Full reset value, cooling mode**
14 [1]	±nn.n	°C	See table below	Zero reset threshold, heating mode**
15 [1]	±nn.n	°C	See table below	Full reset threshold, heating mode**
16 [1]	±nn.n	°C	-16 to 16	Full reset value, heating mode**

- 1 This item is displayed in certain unit configurations only.
- 2 All points contained in this table can be modified.

* Those setpoints can be used for entering or leaving water temperature control. By default the unit controls the evaporator entering fluid temperature. Leaving fluid temperature control requires a parameter modification in the Service Configuration menu.

** These parameters are only accessible when reset based on OAT or delta T has been selected in the User Configuration 1 menu. See section 4.3.11.3 & 5.6.2.

4.3.7 - Description of the Pressures menu

PRESSURES MENU [2]			
ITEM	FORMAT	UNITS	COMMENTS
0	nnnn	kPa	Discharge pressure, circuit A. Relative pressure.
1	nnn	kPa	Suction pressure, circuit A. Relative pressure.
2 [1]	nnnn	kPa	Discharge pressure, circuit B. Relative pressure.
3 [1]	nnn	kPa	Suction pressure, circuit B. Relative pressure.

- 1 This item is displayed in certain unit configurations only.
- 2 Access to this menu is read-only

LEAVING WATER TEMPERATURE CONTROL

SETPOINT - °C	R-22/R-407C
Minimum cooling value	
Water	5.0
Medium brine	0.0
Brine	-10.0
Maximum cooling value	20.0
Feedback setpoint, cooling	6.0
Minimum heating value	20.6
Maximum heating value	56.1
Feedback setpoint heating	48.0

RESET THRESHOLDS IN COOLING OR HEATING MODE

Reset threshold	Zero	Full
Reset based on outdoor air temperature	-10 to 51 °C	-10 to 51 °C
Reset based on Delta T	0 to 11.1 °C	0 to 11.1 °C

ENTERING WATER TEMPERATURE CONTROL

SETPOINT - °C	R-22/R-407C
Minimum cooling value	
Water	10.0
Medium brine	6.1
Brine	-3.9
Maximum cooling value	26.1
Feedback setpoint, cooling	12.0
Minimum heating value	14.4
Maximum heating value	50.0
Feedback setpoint heating	42.0

4.3.9 - Description of the Inputs menu**INPUTS MENU [2]**

ITEM	FORMAT	UNITS	COMMENTS
0	oPEn/CLoS	-	Remote contact 1 status. If the auto cooling/heating changeover function is not selected (User Configuration 1), this contact is used to start and stop the unit. If the auto cooling/heating changeover function is selected, this contact is multiplexed with contact 2 to permit starting and stopping the unit and the selection of heating/cooling/auto. This contact is only valid, if the unit is in the remote operating control (rEM) mode. See section 3.6 for the description of the connections of this contact.
1 [1]	oPEn/CLoS	-	Remote contact 2 status. If the auto cooling/heating changeover function is not selected (User Configuration 1), this contact is used to select the heating or cooling mode. If the auto cooling/heating changeover function is selected, this contact is multiplexed with contact 1 to permit starting and stopping the unit and the selection of heating/cooling/auto. This contact is only valid, if the unit is in the remote operating control (rEM) mode. See section 3.6 for the description of the connections of this contact.
2	oPEn/CLoS	-	Remote contact 3 status. The operation of this contact depends on the unit type. Single-circuit unit: this contact can be used either to limit unit demand or to select a setpoint, as described in User Configuration. If this contact is used for selecting a setpoint it is only active if the unit is in the remote operating control mode. If the contact is used to limit the demand of the unit, it is active in all operating types. Open contact: unit capacity is not limited or unit control is based on setpoint 1. Closed contact: unit capacity is limited at limit setpoint 1 or unit control is based on setpoint 2. See section 4.3.11.3 for the configuration of contact 3 - section 5.6.1 for the description of the setpoint selection - section 5.7 for the description of the demand limit function and 3.6 for the description of the connection of contact 3 for single-circuit units. Dual-circuit units: this contact is multiplexed with contact 4 to permit the selection of a demand limit point. This contact is active in all operating types. See section 3.6.5 for the description of this contact and section 5.7 for the description of the demand limit function.
3	oPEn/CLoS	-	Remote contact 4 status. This contact is only used for dual-circuit units: this contact is multiplexed with contact 3 to permit selection of a demand limit value. This contact is active in all operating types. See section 3.6.5 for the description of this contact and section 5.7 for the description of the demand limit function.
4 [1]	oPEn/CLoS	-	Remote contact 5 status. This contact is only used for dual-circuit units: this contact is multiplexed with contact 6 to permit selection of a setpoint. This contact is only active in the remote operating control mode. See section 3.6.6 for the description of this contact and section 5.6.1 for the description of the setpoint selection function.
5 [1]	oPEn/CLoS	-	Remote contact 6 status. This contact is only used for dual-circuit units: this contact is multiplexed with contact 5 to permit selection of a setpoint. This contact is only active in the remote operating control mode. See section 3.6.6 for the description of this contact and section 5.6.1 for the description of the setpoint selection function.
6 [1]	oPEn/CLoS	-	Interlock status. When this contact opens the unit stops or is prevented from starting and an alarm is created. This contact is used to control the water flow. In addition, a customer safety device can be connected in series with this contact (see section 3.6).
7	oPEn/CLoS	-	Water pump run contact status. When this contact opens while an evaporator pump has received a command to be on then a pump failure alarm is tripped.
8 [1]	b ₁ b ₂ b ₃	-	Compressor feedback contacts, circuit A b ₁ = feedback A1 b ₂ = feedback A2 b ₃ = feedback A3
9 [1]	b ₁ b ₂ b ₃	-	Compressor feedback contacts, circuit B b ₁ = feedback B1 b ₂ = feedback B2 b ₃ = feedback B3

1 This item is displayed in certain unit configurations only

2 Access to this menu is read-only.

4.3.10 - Description of the Outputs/Tests menu

4.3.10.1 - General

This menu displays the status of the controller outputs. Moreover, when the machine is fully stopped (LOFF) the outputs can be activated for manual or automatic tests (the access to the tests is password controlled).

4.3.10.2 - Menu description

OUTPUTS STATUS & TESTS MENU [2] [3]			
ITEM	FORMAT	UNITS	DESCRIPTION
0	b ₁ b ₂ b ₃ tEst FAIL Good	-	Circuit A compressors , command status b ₁ = compressor A1 b ₂ = compressor A2 b ₃ = compressor A3 In test mode , the Arrow buttons display 001, 010 and 100 in succession, so as to force the status of the compressor outputs in turn. During the test phase, power to the compressor is switched on for 10 seconds only. It is then not possible to restart the compressor for a further 30 seconds. When the test is completed the following is displayed: - Fail: displayed if the test has failed because the compressor was not started or run in reverse rotation. - Good: displayed if test was successful
1 [1]	b ₁ b ₂ b ₃ tEst FAIL Good	-	Circuit B compressor, dual-circuit units only b ₁ = compressor B1 b ₂ = compressor B2 b ₃ = compressor B3 In test mode... as above
2	StoP LOW HIGH tEst	-	Two-speed fan status, circuit A Stop = fan is stopped Low = fan is in low speed High = fan is in high speed
3 [1]	StoP LOW HIGH tEst	-	Two-speed fan status, circuit B Stop = fan is stopped Low = fan is in low speed High = fan is in high speed
4 [1]	b ₁ b ₂	-	Single-speed fan status b ₁ = fan A2 b ₂ = fan B2 Only for dual-circuit units
5 [1]	On OFF tEst FAIL Good Forc	-	Evaporator water pump #1 command status. Not displayed if the unit does not control a pump. On: pump is running Stop: pump is stopped Forc: this item is displayed only when the unit is stopped locally (LOFF). selecting this item authorises turning on the pump with no delay and for an unlimited length of time. The pump will remain on until any button of the user interface is pressed: it is then immediately stopped. If the unit is in CCN control, then the pump status is displayed in turn with "Forc" if the pump status is forced through CCN. During the test phase , power to the pump is switched on for 10 seconds only. When the test is completed the following is displayed: - Fail: displayed if the test has failed because the pump was not started - Good: displayed if the test was successful
6 [1]	On OFF tEst FAIL Good Forc	-	Evaporator water pump #2 command status. Not displayed if the unit does not control a secondary pump. On: pump is running Stop: pump is stopped Forc: this item is displayed only when the unit is stopped locally (LOFF). selecting this item authorises turning on the pump with no delay and for an unlimited length of time. The pump will remain on until any button of the user interface is pressed: it is then immediately stopped. If the unit is in CCN control, then the pump status is displayed in turn with "Forc" if the pump status is forced through CCN. During the test phase , ...as above
7	On OFF tEst	-	Water or air heat exchanger heater command status See sections 5.5 and 5.11
8	b ₁ b ₂ tEst	-	Alarm output command status b ₁ = alarm circuit A b ₂ = alarm circuit B In test mode , the Arrow buttons display 01 and 10 in succession, so as to force each alarm output status in turn.
9 [1]	On OFF tEst	-	Boiler command status. Displayed if the unit controls a boiler. See section 5.13.
10 [1]	nnn tEst	%	Variable fan speed, circuit A. Displayed if the unit controls a variable-speed fan.
11 [1]	nnn tEst	%	Variable fan speed, circuit B. Dual-circuits only and if the unit controls a variable-speed fan.
12 [1]	b ₁ b ₂ tEst	-	4-way reversing cycle valve status. In test mode, the arrow keys successively display 01 and 10, in order to authorise the test for each valve in turn. b ₁ = valve circuit A b ₂ = valve circuit B This item is only displayed for heat pump units.

OUTPUTS STATUS & TESTS MENU [2] [3] continued

ITEM	FORMAT	UNITS	DESCRIPTION
13 [1]	b ₁ b ₂ b ₃ b ₄ tES _t		Additional heating stage status. b ₁ = stage 1 b ₂ = stage 2 b ₃ = stage 3 b ₄ = stage 4 In test mode the arrow keys successively display 0001, 0010, 0100 and 1000 to force the status of each electric heating stage in turn. This item is only displayed for heat pump units controlling additional electric heater stages. See section 5.12.
14 [1]	YES no tES _t	- - %	Used for local interface test only. Lights or flashes all LEDs and blocks, so as to check that they are working properly.
15	Auto tES _t	-	Automatic test. Selecting this item activates the automatic test function.

- 1 This item is displayed in certain unit configurations only.
 - 2 Testing authorised only if the unit is in Local Off and all compressors are off.
 - 3 Password needed only for testing.
- "Test" Displayed in turn with the item value during tests.

4.3.10.3 - Manual tests

This function allows the user to test the outputs individually, if the machine is completely shut down (LOFF). To carry out a manual test use the arrow keys to access the output to be tested and press the Enter key (longer than 2 seconds) to activate the modification mode. The password is automatically requested, if it has not previously been verified. The Outputs/Test LED on the user interface begins to flash. Enter the desired test value and again press Enter to start the test. 'TEST' is displayed on the 4-digit display alternately with the value tested. The Outputs/Test LED stops flashing. Press the Enter key or an arrow key to stop the test.

4.3.10.4 - Automatic tests

The automatic test function verifies the integrity of the analogue entries and activates the outputs in sequence. For each test 't XX' is displayed on the user interface. 'xx' indicates the number of the test in progress. When a test has been completed, the following test is automatically activated.

A message may appear, asking the operator for a validation with the Enter key, if the control cannot automatically verify a sensor value or an output status. If the value read or the output status is incorrect, the operator must press a different key (not the Enter key) to cancel the automatic test procedure.

If a test fails, an error message and an error code are displayed. The automatic test procedure is interrupted.

When all tests have been completed, an end-of-test message appears.

The table below describes the messages shown on the user interface during the automatic test sequence.

TEXT	DESCRIPTION
Thermistor test failed [XX]	Test number XX of the thermistor has failed
Pressure test failed [XX]	Test number XX of the pressure sensor has failed
Output test failed [XX]	Output test number XX has failed
Input test failed [XX]	Input test number XX has failed
Press enter if test [XX] correct	Request for the operator to validate test XX
OAT [value] press enter if test [XX] correct	Request for the operator to validate the outdoor air temperature value displayed. Test number XX
Auto test completed	Automatic test completed

The table below describes the different sequences of the automatic test.

TEST NUMBER	DESCRIPTION	CONFIRMATION
0	Outdoor temperature sensor test	yes
1	Pressure sensor test - circuit A	no
2	Pressure sensor test - circuit B (dual-circuit units only)	no
3	Defrost sensor test - circuit A (heat pumps only)	no
4	Defrost sensor test - circuit B (dual-circuit heat pumps only)	no
5, 6	Water flow switch test and primary pump test	no
7, 8, 9	Entering and leaving water temperature sensor test	no
10, 11	Water system temperature sensor test (for master/slave units equipped with this sensor only)	no
12, 13, 14	Water flow switch test and secondary pump test (for units equipped with a secondary pump only)	no
15, 16, 17	Test compressor A1, A2 (if applicable), A3 (if applicable)	no
18	4-way reversing valve test, circuit A (heat pumps only)	no
19, 20, 21	Test compressor B1 (if applicable), B2 (if applicable), B3 (if applicable)	no
22	4-way reversing valve test, circuit B (dual-circuit heat pumps only)	no
23	Low-speed test, fan A1 (units not equipped with Varifan)	yes
24	High-speed test, fan A1 (units not equipped with Varifan)	yes
25	Low-speed test, fan A2 (dual-circuit units not equipped with Varifan)	yes
26	High-speed test, fan A2 (dual-circuit units not equipped with Varifan)	yes
27	Fixed-speed test, fan A2 (for circuits equipped with a second fan)	yes
28	Fixed-speed test, fan B2 (for circuits equipped with a second fan)	yes
29	Water and air heat exchanger heater test	yes
30	Not used	
31	Boiler output activation (if unit controls a boiler)	yes
32	Additional electric heating stage 1 activation (if unit controls electric heating stages)	yes
33	Additional electric heating stage 2 activation (if unit controls electric heating stages)	yes
34	Additional electric heating stage 3 activation (if unit controls electric heating stages)	yes
35	Additional electric heating stage 4 activation (if unit controls electric heating stages)	yes
36	Alarm output A activation	yes
37	Alarm output B activation	yes
38	Automatic test completed	-

The table below describes the faults that can be displayed during the automatic test.

TEST FAULT	DESCRIPTION
1	Outdoor air thermistor outside range
2	Outdoor air value read not validated by operator
3	Low pressure transducer, circuit A, outside range
4	High pressure transducer, circuit A, outside range
5	Low pressure transducer, circuit B, outside range
6	High pressure transducer, circuit B, outside range
7	Defrost thermistor, circuit A, outside range
8	Defrost thermistor, circuit B, outside range
9	Water flow switch not open
10	Primary pump not started or water flow switch not closed
11, 12, 13; 14, 15 16, 17, 18, 19, 20	Water entering temperature sensor outside range Water leaving temperature sensor outside range
21	Temperature difference between entering and leaving water sensors too high
22, 23; 24, 25, 26	Water system leaving temperature sensor outside range
27	Temperature difference between the system entering and leaving water sensors too high
28	Water flow switch not closed or primary pump not stopped
29	Secondary pump not started or water flow switch not closed
30	Water flow switch not closed or secondary pump not stopped
31	Command fault; compressor A1
32	Command fault; compressor A2
33	Command fault; compressor A3
34	Command fault, 4-way reversing valve, circuit A
35	Command fault; compressor B1
36	Command fault; compressor B2
37	Command fault; compressor B3
38	Command fault, 4-way reversing valve, circuit B
39	Low-speed test, fan A1 not validated by the operator
40	High-speed test, fan A1 not validated by the operator
41	Low-speed test, fan B1 not validated by the operator
42	High-speed test, fan B1 not validated by the operator
43	Test fan A2 not validated by the operator
44	Test fan B2 not validated by the operator
45	Water heat exchanger heater and air heat exchanger condensate heater test, circuit A not validated by the operator
46	Air heat exchanger condensate heater, circuit B, not validated by the operator
47	Boiler activation test not validated by the operator
48	Electric heating stage 1 activation test not validated by the operator
49	Electric heating stage 2 activation test not validated by the operator
50	Electric heating stage 3 activation test not validated by the operator
51	Electric heating stage 4 activation test not validated by the operator
52	Alarm relay output activation test, circuit A not validated by the operator
53	Alarm relay output activation test, circuit B not validated by the operator

4.3.11- Description of the configuration menu

4.3.11.1- General

This menu can be used to display and modify all configurations: Factory, Service and User. Only the User Configuration can be modified by the end-user. The Factory, Service and master/slave configurations are not described in this document. A configuration can only be modified if the unit is fully stopped (LOFF).

The menus User 1 [USER 1] and User 2 [USER 2] are password-protected. The other menus are directly accessible, except if item 11 of the User 2 menu (password for all configurations) has been validated.

4.3.11.2 - Password

A password must be entered in order to access the test function or to modify a configuration. It is automatically requested, if necessary: 'EntEr PASS' is displayed on the 4-digit display and the configuration menu LED flashes, indicating that the modification mode is active. Press the arrow keys until the value '11' is displayed on the 4-digit display. Press Enter to validate this. The configuration menu LED stops flashing. If the password is correct, 'Good' is displayed. If the password is incorrect, 'PASS incorrEct' is displayed. The User password has a default value of 11.

This value can be modified through the Service configuration. The password can be entered if the unit is fully stopped, otherwise 'ACCES dEniEd' (access denied) will be displayed on the 4-digit display. The controller automatically deactivates the password after 5 minutes without activity (i.e. no buttons pressed) or after powering up.

SUB-MENU USER CONFIGURATION

ITEM	USER 1 [USER1]	USER 2 [USER2]	DATE [dAtE]*	SCHEDULE 1 [SchEdUle 1MEnu]*	SCHEDULE 2 [SchEdUle 2 MEnu]*	HOLIDAYS [HOLidAy MEnu]*	BROADCAST [BrodCAsT]*
0	Return to previous menu	Return to previous menu	Return to previous menu	Return to previous menu	Return to previous menu	Return to previous menu	Return to previous menu
1	-	Periodic pump start-up	Hour*	SUB-MENU: Period 1 [PERlod 1]	SUB-MENU: Period 1 [PERlod 1]	SUB-MENU: Holidays 1 [HOLidAy 1]	Broadcast acknowledge selection
2	Ramp selection*	Night mode - start hour	Day of the week*	SUB-MENU: Period 2 [PERlod 2]	SUB-MENU: Period 2 [PERlod 2]	SUB-MENU: Holidays 2 [HOLidAy 2]	Broadcast activation
3	Start-up delay*	Night mode - end hour	Day and month*	SUB-MENU: Period 3 [PERlod 3]	SUB-MENU: Period 3 [PERlod 3]	SUB-MENU: Holidays 3 [HOLidAy 3]	Outdoor temperature broadcast bus
4	Water pump selection	Night mode demand limit	Year*	SUB-MENU: Period 4 [PERlod 4]	SUB-MENU: Period 4 [PERlod 4]	SUB-MENU: Holidays 4 [HOLidAy 4]	Outdoor temperature broadcast element
5	Water pump changover delay*	Night mode min. demand	-	SUB-MENU: Period 5 [PERlod 5]	SUB-MENU: Period 5 [PERlod 5]	SUB-MENU: Holidays 5 [HOLidAy 5]	Start month daylight saving time
6	Pump shutdown in standby mode	Alarm relay selection	-	SUB-MENU: Period 6 [PERlod 6]	SUB-MENU: Period 6 [PERlod 6]	SUB-MENU: Holidays 6 [HOLidAy 6]	Start day daylight saving time
7	Control contact 3 selection*	Number clock 1	-	SUB-MENU: Period 7 [PERlod 7]	SUB-MENU: Period 7 [PERlod 7]	SUB-MENU: Holidays 7 [HOLidAy 7]	Start hour daylight saving time
8	Setpoint reset selection, cooling mode	Number clock 2	-	SUB-MENU: Period 8 [PERlod 8]	SUB-MENU: Period 8 [PERlod 8]	SUB-MENU: Holidays 8 [HOLidAy 8]	Minutes to add
8	Setpoint reset selection, heating mode*	CCN element number	-	-	-	SUB-MENU: Holidays 9 [HOLidAy 9]	End month daylight saving time
10	Boiler selection	CCN bus number	-	-	-	SUB-MENU: Holidays 10 [HOLidAy 10]	End day daylight saving time
11	Boiler operation threshold*	Password for all user configurations	-	-	-	SUB-MENU: Holidays 11 [HOLidAy 11]	End hour daylight saving time
12	Operating threshold, heating mode*	-	-	-	-	SUB-MENU: Holidays 12 [HOLidAy 12]	Minutes to subtract
13	Electric heating stage operation threshold*	Software version number	-	-	-	SUB-MENU: Holidays 13 [HOLidAy 13]	-
14	Electric heating safety stage threshold*	-	-	-	-	SUB-MENU: Holidays 14 [HOLidAy 14]	-
15	Electric heating stage operation schedule*	-	-	-	-	SUB-MENU: Holidays 14 [HOLidAy 14]	-
16	Quick start-up, electric heater stages in defrost mode*	-	-	-	-	SUB-MENU: Holidays 16 [HOLidAy 16]	-
17	Automatic heating/cooling changover selection	-	-	-	-	-	-
18	Extended display selection	-	-	-	-	-	-

* only displayed if configuration requires.

NOTE: The items in brackets show what is displayed on the user interface.

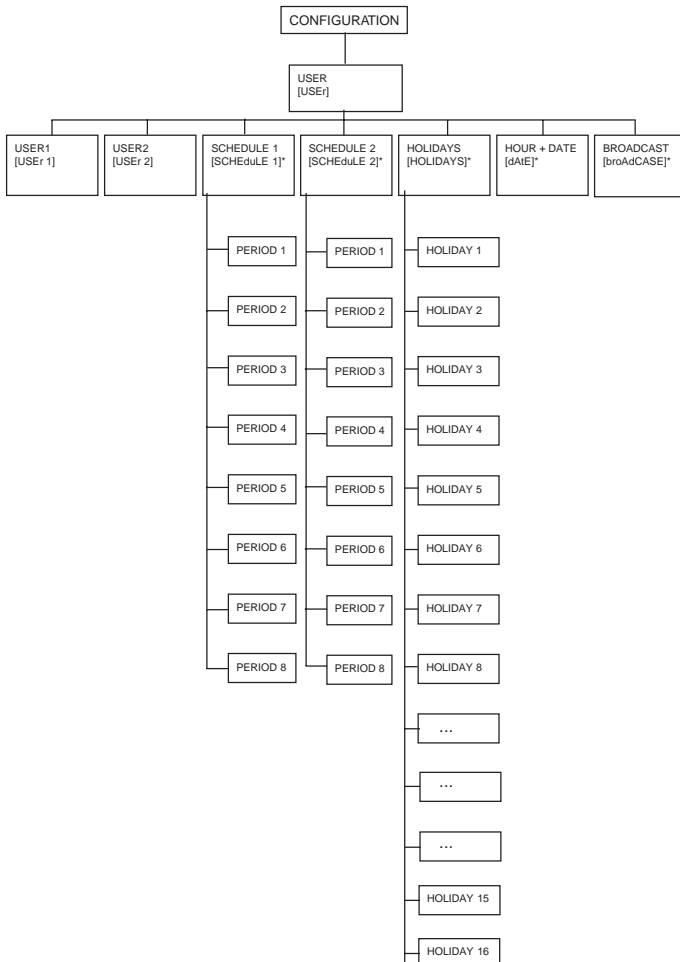

SUB-MENU PERIOD CONFIGURATION*

Item	PERIOD 1 to 8 [PERiod X MEnu]*
0	Return to previous menu
1	Start of occupied period
2	End of occupied period
3	Selection Monday
4	Selection Tuesday
5	Selection Wednesday
6	Selection Thursday
7	Selection Friday
8	Selection Saturday
9	Selection Sunday
10	Selection holidays

SUB-MENU HOLIDAY CONFIGURATION*

Item	HOLIDAYS 1 to 16 [HoLidAy X MEnu]*
0	Return to previous menu
1	Start month holidays
3	Start day holidays
4	Number of days, holidays

* only displayed if configuration requires.

NOTE: The items in brackets show what is displayed on the user interface.

4.3.11.3 - Description of the User 1 Configuration sub-menu

USER 1 CONFIGURATION SUB-MENU [2]

ITEM	FORMAT	UNITS	DEFAULT	COMMENTS
0	USER MEnu	-	-	When selected this item authorises return to the previous menu.
2 [1]	YES/no	-	no	Ramp loading select. For units with more than one compressor only. Yes = ramp enabled No = ramp disabled This configuration enables the ramp to be activated for heating or cooling (depending on configuration): the maximum rate (in °C/min) of temperature drop or rise for the heat exchanger water (leaving or entering, upon configuration). Ramp setting value can be configured in the Setpoint menu.
3	1 to 15	min	1	Delay at start-up. This value is reinitialised after power-up or when both circuits are halted by local, remote or CCN command. No compressor will be started up until this pause has expired. However, the evaporator pump command will be activated immediately. The safety lockout loop will not be checked until the pause has expired.
4	0/1/2/3/4	-	0	Pump sequence select 0 = no pump 1 = one pump only 2 = two pumps with auto rotation 3 = pump #1 manual select 4 = pump #2 manual select If the auto sequence is selected, the pump change-over occurs when the rotation delay is elapsed. If the manual sequence is selected then, the selected pump is used in priority. Change-over occurs if one pump fails.
5 [1]	24 to 3000	hours	48	Pump changeover delay. Displayed if auto pump sequence is selected. This parameter is used for pump auto-rotation: the control tries to limit the pump run time difference to the pump changeover delay value. Change-over between pumps occurs when this difference becomes greater than the configured pump changeover delay.
6 [1]	«YES/no»	-	no	Pump shutdown in standby mode Displayed if the unit controls a water pump. If this parameter is validated, the pump will be shut down when the standby mode is active (in automatic heating/cooling changeover). It automatically restarts in heating or cooling mode.
7 [1]	0/1	-	0	Contact 3 select (for single-circuit units) 0 = input is used for demand limit command control 1 = input is used for dual setpoint command control Determines whether contact 3 is used for remote demand limit or dual setpoint control. For single-circuit units only.
8	0/1/2	-	0	Cooling setpoint reset select. See section 5.6.2. 0 = reset not selected 1 = reset based on outdoor temperature 2 = reset based on return water temperature
9 [1]	0/1/2	-	0	Heating setpoint reset select. See section 5.6.2 0 = reset not selected 1 = reset based on outdoor temperature 2 = reset based on return water temperature
10	«YES/no»	-	no	Boiler control select Yes = boiler controlled by the unit No = boiler not controlled
11 [1]	-15 to 0	°C	-10	Boiler threshold. Outdoor air temperature limit; if the temperature is lower, the heat pump is stopped or only the boiler is used for hot water production. Only for heat pumps controlling an additional boiler.
12 [1]	-20 to 0	°C	-15	Operating threshold, heating mode. Outside air temperature threshold below which the heat pump shuts down. The unit switches the electric heaters on and off (if these exist). For heat pumps only.
13 [1]	-5 to 21	°C	5	Electric heating stage threshold. Maximum outdoor air temperature threshold for the use of electric heating stages. Only for heat pumps, equipped with optional additional electric heating stages.
14 [1]	«YES/no»	-	no	Electric heating safety stage. In this configuration the last electric heating stage is only activated in the safety mode (in case of a unit fault that prevents unit operation in heat pump mode). The other electric heating stages operate normally. See section 5.12.
15 [1]	0 to 60	minutes		Electric heating stage operation schedule. Permits configuration of a start-up delay after unit start-up during which the electric heater stages are not allowed to start.
16 [1]	«YES/no»	-	no	Quick start-up, electric heater stages in defrost mode. If a circuit switches to defrost mode, the electric heater stages are allowed to start up immediately. For heat pumps only.
17 [1]	«YES/no»	-	no	Automatic cooling/heating changeover select. Permits activation of the automatic changeover function. Caution: This function requires a special operation for control contacts 1 and 2, if the machine is under remote control (see section 3.6.3).
18	«YES/no»	-	yes	Extended menu select Yes = menu description available No = menu description not available This item authorises activating or inhibiting the menu item expanded display.

1 This item shall be masked when not used.

2 Access to menu is read/write.

4.3.11.4 - Description of the User 2 Configuration sub-menu

USER 1 CONFIGURATION SUB-MENU				
ITEM	FORMAT	UNITS	DEFAULT	COMMENTS
0	USEr 2 Menu			When selected this item authorises return to the previous menu.
1	«YES/no»	-	no	Periodic pump quick-start of the water pump(s) Yes = the pump is started periodically when the unit is manually stopped. No = periodic pump start is disabled When the unit is manually stopped (e.g. during the winter season) the pump is started each day at 14.00 hours for 2 seconds. If two pumps are available, pump #1 is started on odd days and pump #2 on even days.
2	n ₁ n ₂ n ₃ n ₄ 00:00 to 23:59	-	00:00	Night control mode - start time* Authorises entering the time of day at which the night control mode starts. During this period the fan runs at low speed (to reduce fan noise) if permitted by operating conditions, and unit capacity is limited to the maximum night values.
3 [1]	n ₁ n ₂ n ₃ n ₄ 00:00 to 23:59	-	00:00	Night control mode - end time* Authorises entering the time of day at which the night control mode ends.
4	«YES/no»	-	no	Night mode demand limit value. This item permits demand limitation in the night control mode. In this case, if the unit fans cannot be kept at low speed due to the operating conditions, the unit capacity is reduced to prevent fan operation at high speed.
5	0 to 100	%	0	Night mode demand limit. The unit capacity is never reduced below this capacity in night control mode.
6	0/1/2	-	0	Alarm relay selection 0 = alarms/alerts, one alarm/alert output per circuit. 1 = alarms only, one alarm output per circuit. 2 = mixed mode, one alarm relay and one alert relay, dual-circuit units only.
7	0 or 65 to 99	-	0	Schedule 1 clock number (for unit on/off schedule, see section 4.3.11.6). 0 = schedule in local operating mode 65 to 99 = schedule in CCN operating mode
8	0 or 65 to 99	-	0	Schedule 2 clock number (schedule for setpoint selection, see section 4.3.11.6). 0 = schedule in local operating mode 65 to 99 = schedule in CCN operating mode
9	1 to 239	-	1	CCN element address. No two network elements can have the same element number and bus number at the same time.
10	0 to 239	-	0	CCN bus number. No two network elements can have the same element number and bus number at the same time.
11	«YES/no»	-	no	Password for all User Configurations Yes = password required for all User Configurations (Date, Time Schedule, Broadcast) No = password require for User menu only When this item is validated, the User Password will be required for all configurations accessible by the User.
12	nn.n	-	-	Software version number This item shows the number of the software version used by this controller. Access is read only.

* n₁n₂: hours (00 to 23). The first time the Enter button is continuously pressed, the first two characters in the 4-digit display flash so that hours can be adjusted.
n₃n₄: minutes (00 to 59). Continuous pressing of the Enter key again causes the last two characters to flash so that minutes can be adjusted.

4.3.11.5 - Description of Date and Time configuration sub-menu

DATE & TIME CONFIGURATION SUB-MENU		
ITEM	FORMAT	COMMENTS
0	dAtE MEnu	When selected this item authorises return to the previous menu.
1	n ₁ n ₂ n ₃ n ₄ 00:00 to 23:59	Current time setting. n ₁ n ₂ : hours (00 to 23). The first time the Enter button is continuously pressed, the first two characters in the 4-digit display flash so that hours can be adjusted. n ₃ n ₄ : minutes (00 to 59). Continuous pressing of the Enter key again causes the last two characters to flash and minutes can be adjusted.
2	«Mon» «tue» «Wed» «thu» «Fri» «Sat» «Sun»	Current day of week setting. Monday Tuesday Wednesday Thursday Friday Saturday Sunday
3	n ₁ n ₂ n ₃ n ₄ 01:01 to 31:12	Current day and month setting. n ₁ n ₂ : day (01 to 31). The first time the Enter button is continuously pressed, the first two characters in the 4-digit display flash so that day can be adjusted. n ₃ n ₄ : month (01 to 12). Continuous pressing of the Enter key again causes the last two characters to flash so that month can be adjusted.
4	nnnn	Current year setting.

4.3.11.6 - Description of the Time Schedules sub-menus

The control provides two timer programs: schedule 1 and schedule 2 that can be activated if the unit is equipped with an optional CCN/clock board (if the CCN/clock board is not installed, the two schedules are permanently in occupied mode).

The first timer program (schedule #1) provides a means to automatically switch the unit from an occupied mode to an unoccupied mode: the unit is started during occupied periods.

The second timer program (schedule #2) provides a means to automatically switch the active setpoint from an occupied setpoint to an unoccupied setpoint: cooling setpoint 1 is used during occupied periods, cooling or heating setpoint 2 during unoccupied periods. Heating setpoint 3 is activated during holiday periods. For additional information on set-point activation see section 5.6.1.

Each schedule consists of eight time periods set by the operator. These time periods can be flagged to be in effect or not in effect on each day of the week plus a holiday period (see section 4.3.11.7 on public holidays). The day begins at 00.00 hours and ends at 24.00 hours.

Program is in unoccupied mode unless a schedule time period is in effect. If two periods overlap and are both active on the same day, the occupied mode takes priority over the unoccupied period.

Each of the eight periods can be displayed and changed with the aid of a sub-sub-menu. The table below shows how to access the period configuration. Method is the same for the time schedule #1 or the time schedule #2.

PERIOD X CONFIGURATION SUB-MENUS (X = 1 TO 8)

ITEM #	FORMAT	COMMENTS
0	Period X Menu	Indicates the period (X) you are going to configure. When selected this item authorises a return to the main menu.
1	n ₁ n ₂ n ₃ n ₄ 00:00 to 24:00	Occupied period - Start time*. Authorises entering the time of day at which the occupied period starts.
2	n ₁ n ₂ n ₃ n ₄ 00:00 to 24:00	Occupied period - End time*. Authorises entering the time of day at which the occupied period ends.
3	Mo- 0 or Mo- 1	1 = the period is in effect on Monday . 0 = period not in effect on Monday
4	tu- 0 or tu- 1	1 = the period is in effect on Tuesday . 0 = period not in effect on Tuesday.
5	UE-0 or UE- 1	1 = the period is in effect on Wednesday . 0 = period not in effect on Wednesday.
6	tH- 0 or tH- 1	1 = the period is in effect on Thursday . 0 = period not in effect on Thursday.
7	Fr-0 or Fr- 1	1 = the period is in effect on Friday . 0 = period not in effect on Friday.
8	SA- 0 or SA- 1	1 = the period is in effect on Saturday . 0 = period not in effect on Saturday.
9	Su- 0 or Su- 1	1 = the period is in effect on Sunday . 0 = period not in effect on Sunday.
10	Ho- 0 or Ho- 1	1 = the period is in effect on public holidays . 0 = period not in effect on public holidays.

* n₁n₂: hours (00 to 24). The first time the Enter button is continuously pressed, the first two characters in the 4-digit display flash so that hours can be adjusted.
n₃n₄: minutes (00 to 59). Continuous pressing of the Enter key again causes the last two characters to flash so that minutes can be adjusted.

4.3.11.7 - Description of the Holidays sub-menus

This function is used to define 16 public holiday periods. Each period is defined with the aid of three parameters: the month, starting day and duration of the public holiday period. During these public holidays the controller will be in occupied or unoccupied mode, depending on the programmed periods validated for public holidays (see section 4.3.11.6).

Each of these public holiday periods can be displayed and changed with the aid of a sub-menu.

ATTENTION: The broadcast function must be activated to utilise the holiday schedule, even if the unit is running in stand-alone mode (not connected to CCN). See section 4.3.11.8.

Typical timer program:

Time	MON	TUE	WES	THU	FRI	SAT	SUN	HOL
0	P1							
1	P1							
2	P1							
3								
4								
5								
6								
7	P2	P2	P3	P4	P4	P5		
8	P2	P2	P3	P4	P4	P5		
9	P2	P2	P3	P4	P4	P5		
10	P2	P2	P3	P4	P4	P5		
11	P2	P2	P3	P4	P4	P5		
12	P2	P2	P3	P4	P4			
13	P2	P2	P3	P4	P4			
14	P2	P2	P3	P4	P4			
15	P2	P2	P3	P4	P4			
16	P2	P2	P3	P4	P4			
17	P2	P2	P3					
18			P3					
19			P3					
20			P3					P6
21								
22								
23								
24								

MON : Monday
TUE : Tuesday
WED : Wednesday
THU : Thursday
FRI : Friday
SAT : Saturday
SUN : Sunday
HOL : Public holidays

 Occupied
 Unoccupied

	Starts at	Ends at	Active on
P1: period 1,	0h00,	3h00,	Monday
P2: period 2,	7h00,	18h00,	Monday and Tuesday
P3: period 3,	7h00,	21h00,	Wednesday
P4: period 4,	7h00,	17h00,	Thursday and Friday
P5: period 5,	7h00,	12h00,	Saturday
P6: period 6,	20h00,	21h00,	Public holidays
P7: period 7,	<i>Not used in this example</i>		
P8: period 8,	<i>Not used in this example</i>		

HOLIDAY PERIOD X CONFIGURATION SUB-MENUS (X = 1 TO 16)

ITEM #	FORMAT	COMMENTS
0	HoLidAy X Sub-menu	When selected this item authorises a return to the configuration menu.
1	0 to 12	Start month of public holiday period 0 = period not in use 1 = January, 2 = February, etc.
2	0 to 31	Start day of public holiday period. 0 period not in use.
3	0 to 99 days	Duration of the public holiday period in days.

Typical programming for public holidays:

A public holiday period lasting 1 day on 20th May, for instance, is configured as follows: start month = 5, start day = 20, duration = 1

A public holiday period lasting 2 day on 25th May, for instance, is configured as follows: start month = 5, start day = 25, duration = 2

4.3.11.8 - Description of the Broadcast sub-menu

The controller provides a broadcast configuration menu which you can use to configure the unit to be the CCN's broadcaster, responsible for transmitting the time, outdoor temperature, and holiday flags to all system elements.

This menu also authorises setting the date of the daylight saving time. There should be **only one** broadcaster in a CCN, so this table should not be configured if any other system element is acting as broadcaster.

ATTENTION: If the unit operates in standalone mode (not CCN connected) this menu can also must be used if the holi-day function is used or to correct for daylight saving time.

BROADCAST CONFIGURATION SUB-MENU

ITEM #	FORMAT	COMMENTS
0	broAdCAST MEnu	When selected this item authorises a return to the main menu.
1	YES/no	Determines whether or not the unit is a broadcast acknowledger when the unit is connected on a CCN network. There must be only one broadcast acknowledger in a CCN. Warning: if the unit operates in standalone mode (not CCN connected) this choice must be set to Yes if the holiday function is used (see section 4.3.11.6) or if you want to configure the daylight saving time function.
2	YES/no	This item authorises enabling or disabling the Broadcast function . When it is set to Yes, the control will make a periodic broadcast on the CCN. When it is set to No, the control is not the broadcaster and there is no need to configure the other choice in this table. There must be only one broadcaster in a CCN and this item should not be configured if any other system element is acting as broadcaster. Warning: if the unit operates in standalone (not CCN connected) this choice must be set to Yes if the holiday function is used (see section 4.3.11.6) or if you want to configure the daylight saving time function.
3	nnn 0 to 239	OAT Broadcaster bus number: it is the bus number of the system that has the outside air temperature sensor connected to it. Used for CCN network function only.
4	nnn 0 to 239	OAT Broadcaster element number: it is the element number of the system element that has the outside air temperature sensor connected to it. Used for CCN network function only.
5	nn 1 to 12	Daylight saving start month. In this mode you enter the month in which the broadcaster will adjust its time for the start of daylight saving time.
6	nn 1 to 31	Daylight saving start day. In this mode you enter the day on which the broadcaster will adjust its time for the start of daylight saving time.
7	n ₁ n ₂ n ₃ n ₄ 00:00 to 24:00	Authorises entering the hours and minutes for saving start. In this mode you enter the time of day when the broadcaster will adjust its time for the start of daylight saving time. n ₁ n ₂ : hours (00 to 24). The first time the Enter button is continuously pressed, the first two characters in the 4-digit display flash so that hours can be adjusted. n ₃ n ₄ : minutes (00 to 59). Continuous pressing of the Enter key again causes the last two characters to flash so that minutes can be adjusted.
8	nnnn 1 to 1440 minutes	Daylight saving start minutes to add: number of minutes by which the broadcaster will adjust its time for the start of daylight saving time.
9	nn 1 to 12	Daylight saving stop month. In this mode you enter the month in which the broadcaster will adjust its time for the end of daylight saving time.
10	nn 1 to 31	Daylight saving stop day. In this mode you enter the day on which the broadcaster will adjust its time for the end of daylight saving time.
11	n ₁ n ₂ n ₃ n ₄ 00:00 to 24:00	Authorises entering the hours and minutes for saving stop. In this mode you enter the time of day when the broadcaster will adjust its time for the end of daylight saving time. n ₁ n ₂ : hours (00 to 24). The first time the Enter button is continuously pressed, the first two characters in the 4-digit display flash so that hours can be adjusted. n ₃ n ₄ : minutes (00 to 59). Continuous pressing of the Enter key again causes the last two characters to flash so that minutes can be adjusted.
12	nnnn 1 to 1440 minutes	Daylight saving start minutes to subtract: number of minutes by which the broadcaster will adjust its time for the end of daylight saving time.

4.3.12 - Description of the Alarms menu

This menu is used to display and reset up to 5 active alarms. It also permits alarm reset. If no alarm is active this menu is not accessible. See section 6 for a complete description of the alarm codes and alarm reset.

ALARMS MENU		
ITEM #	FORMAT	COMMENTS
0 [1]	X ALArM rESEt ALArM	X alarms are active Reset of alarms is requested To reset all active alarms, continuously press the Enter key. 'rESEt ALArM' is then displayed. Press the select key again: all alarms are reset.
1 [1]	1 to 55	Current alarm code 1*
2 [1]	1 to 55	Current alarm code 2*
3 [1]	1 to 55	Current alarm code 3*
4 [1]	1 to 55	Current alarm code 4*
5 [1]	1 to 55	Current alarm code 5*

1 This item is masked when nil

* Pressing the Enter key when alarm code is displayed causes the following message to be scrolled:
 "time of alarm" "date of alarm" "full CCN alarm message"
 - "time of alarm": xxhmm
 - "date": dd-mm
 - "full CCN alarm message": up to 64 characters

4.3.13 - Description of the Alarms History menu

ALARMS HISTORY MENU		
ITEM #	FORMAT	COMMENTS
1 [1]	1 to 55	Alarm history code 1*
2 [1]	1 to 55	Alarm history code 2*
3 [1]	1 to 55	Alarm history code 3*
4 [1]	1 to 55	Alarm history code 4*
5 [1]	1 to 55	Alarm history code 5*
6 [1]	1 to 55	Alarm history code 6*
7 [1]	1 to 55	Alarm history code 7*
8 [1]	1 to 55	Alarm history code 8*
9 [1]	1 to 55	Alarm history code 9*
10 [1]	1 to 55	Alarm history code 10*

1 This item is masked when nil

* Pressing the Enter key when alarm code is displayed causes the following message to be scrolled:
 "time of alarm" "date of alarm" "full CCN alarm message"
 - "time of alarm": xxhmm
 - "date": dd-mm
 - "full CCN alarm message": up to 64 characters

4.3.14 - Runtime menu description

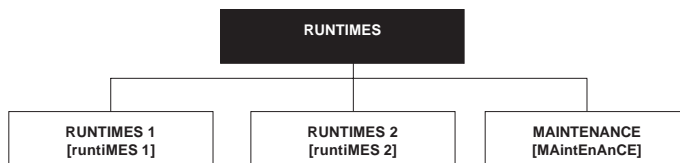

NOTE: The items in brackets show what is displayed on the user interface.

4.3.14.1 - Description of the Runtimes 1 menu

RUNTIMES MENU [2]			
ITEM #	FORMAT	UNITS	COMMENTS
0	-	-	When selected this item authorises return to the previous menu
1	nnnn M 10 M100	hrs/10 or 100	Unit operating hours*
2 [1]	nnnn M 10 M100	hrs/10 or 100	Unit operating hour in cooling mode
3 [1]	nnnn M 10 M100	hrs/10 or 100	Unit operating hours in heating mode
4	nnnn M 10 M100	hrs/10 or 100	Compressor A1 operating hours*
5 [1]	nnnn M 10 M100	hrs/10 or 100	Compressor A2 operating hours*
6 [1]	nnnn M 10 M100	hrs/10 or 100	Compressor A3 operating hours*
7 [1]	nnnn M 10 M100	hrs/10 or 100	Compressor B1 operating hours*
8 [1]	nnnn M 10 M100	hrs/10 or 100	Compressor B2 operating hours*
9 [1]	nnnn M 10 M100	hrs/10 or 100	Compressor B3 operating hours*
10	nnnn M 10 M100	-/10 or 100	Machine starts*
11	nnnn M 10 M100	-/10 or 100	Compressor A1 starts*
12 [1]	nnnn M 10 M100	-/10 or 100	Compressor A2 starts*
13 [1]	nnnn M 10 M100	-/10 or 100	Compressor A3 starts*
14 [1]	nnnn M 10 M100	-/10 or 100	Compressor B1 starts*
15 [1]	nnnn M 10 M100	-/10 or 100	Compressor B2 starts*
16 [1]	nnnn M 10 M100	-/10 or 100	Compressor B3 starts*
17 [1]	nn	hrs/10 or 100	Pump #1 operating hours*
18 [1]	nn	hrs/10 or 100	Pump #2 operating hours*

1 This item is masked when not used

NOTES

* Certain values are divided by 10 or by 100, so that number of hours or start-ups of less than 10 are displayed as 0.

When the value is divided by 10 or by 100 it is displayed in turn with "M 10" or "M100".

4.3.14.2 - Description of Runtimes 2 menu

ITEM #	FORMAT	UNITS	DESCRIPTION
0	-	-	When selected this item authorises return to the previous menu
1	nn	-	Compressor starts for compressor with most starts during the last hour
2	nn	-	24 hours average number of starts/hour, compressor
3	nn	minutes	Minimum compressor operating time during last hour
4	nn	minutes	24 hours average minimum operating time above
5 [1]	nnnn M 10 M100	hrs/10 or 100	Boiler operating hours
6 [1]	nnnn M 10	hrs/10 or 100	Electric heating stage operating hours
7 [1]	nnnn M 10 M100	-/10 or 100	No. of defrost cycles, circuit A
8 [1]	nnnn M 10 M100	-/10 or 100	No. of defrost cycles, circuit B

4.3.14.3 - Maintenance menu description

To be active, the maintenance function must be preset in the Service configuration

ITEM #	FORMAT	DESCRIPTION
0	MAintEnAnCE MEnu	When selected this item authorises return to the previous menu.
1 [1]		Accessible with the Service password.
2 [1]		For future use
3 [1]		For future use
4 [1]	ALert	Water loop rate to low
5 [1]	nnn/ALert	Next primary pump maintenance operation in nnn days. 'ALert' is displayed, when the delay before maintenance has elapsed.
6 [1]	nnn/ALert	Next secondary pump maintenance operation in nnn days. 'ALert' is displayed, when the delay before maintenance has elapsed.
7 [1]	nnn/ALert	Next water filter maintenance operation in nnn days. 'ALert' is displayed, when the delay before maintenance has elapsed.

1 This item is masked when not used.

5 - PRO-DIALOG CONTROL OPERATION

5.1 - Start/stop control

The table below summarises the unit control type and stop or go status with regard to the following parameters.

- **Operating type:** this is selected using the start/stop button on the front of the user interface.
- **Remote start/stop contacts:** these contacts are used when the unit is in remote operating type (rEM). See sections 3.6.2 and 3.6.3.
- **CHIL_S_S:** this network command relates to the chiller start/stop when the unit is in CCN control (CCn). Variable forced to disable: the unit is halted. Variable forced to Enable: the unit runs in accordance with schedule 1.
- **Start/Stop schedule:** occupied or unoccupied status of the unit as determined by the chiller start/stop program (Schedule #1). Used when the unit is equipped with an optional CCN/clock board, otherwise the chiller occupied mode is forced to occupied all the time.
- **Master control type.** This parameter is used when the unit is the master unit in a two chiller lead/lag arrangement. The master control type determines whether the unit is to be controlled locally, remotely or through CCN (this parameter is a Service configuration).
- **CCN emergency shutdown:** if this CCN command is activated, it shuts the unit down whatever the active operating type.
- **General alarm:** the unit is totally stopped due to failure.

ACTIVE OPERATING TYPE							STATUS OF PARAMETERS					CONTROL TYPE	UNIT MODE
LOFF	L-C	L-SC	rEM	CCN	MASt	CHIL_S_S	REMOTE START/STOP CONTACT	MASTER CONTROL TYPE	START/STOP SCHEDULE MODE	CCN EMERGENCY SHUTDOWN	GENERAL ALARM		
-	-	-	-	-	-	-	-	-	-	Enable	-	-	Off
-	-	-	-	-	-	-	-	-	-	-	Yes	-	Off
Active						-	-	-	-		-	Local	Off
		Active				-	-	-	Unoccupied		-	Local	Off
			Active			-	Off	-	-		-	Remote	Off
			Active			-	-	-	Unoccupied		-	Remote	Off
				Active		Disable	-	-	-		-	CCN	Off
				Active		-	-	-	Unoccupied		-	CCN	Off
					Active	-	-	Local	Unoccupied		-	Local	Off
					Active	-	Off	Remote	-		-	Remote	Off
					Active	-	-	Remote	Unoccupied		-	Remote	Off
					Active	Disable	-	CCN	-		-	CCN	Off
					Active	-	-	CCN	Unoccupied		-	CCN	Off
	Active					-	-	-	-	Disable	No	Local	On
		Active				-	-	-	Occupied	Disable	No	Local	On
			Active			-	On cooling	-	Occupied	Disable	No	Remote	On
			Active			-	On heating	-	Occupied	Disable	No	Remote	On
			Active			-	On auto	-	Occupied	Disable	No	Remote	On
				Active		Enable	-	-	Occupied	Disable	No	CCN	On
					Active	-	-	Local	Occupied	Disable	No	Local	On
					Active	-	On cooling	Remote	Occupied	Disable	No	Remote	On
					Active	-	On heating	Remote	Occupied	Disable	No	Remote	On
					Active	-	On auto	Remote	Occupied	Disable	No	Remote	On
					Active	Enable	-	CCN	Occupied	Disable	No	CCN	On

5.2 - Heating/cooling/standby operation

5.2.1 - General

The heating/cooling/standby selection applies to all units. But only 30RA/Ry (liquid chillers) units, controlling a boiler and 30RH/RyH (heat pumps) units can change over to heating mode. Heating/cooling control can be automatic or manual.

In automatic mode the outdoor temperature determines the heating/cooling/standby changeover based on the two threshold values configured by the user (see Setpoint menu for cooling and heating mode changeover thresholds). If the unit is in standby it does not cool or heat, and no compressor can be activated. The diagram below summarises the operating principle in automatic mode.

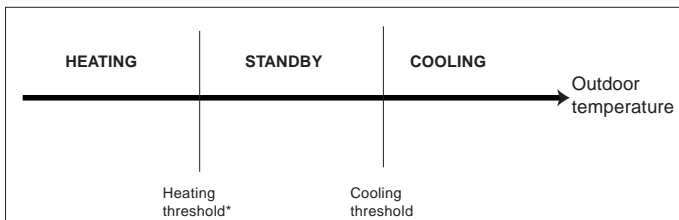

* This threshold does not apply to cooling only units that do not control a boiler.

5.2.2 - Heating/cooling/auto selection

The table below summarises the unit heating/cooling operation, based on the following parameters:

- **Control type:** indicates whether the unit operates in local, remote or CCN mode. See section 5.1.
- **Unit on/off status:** indicates whether the unit is shut down (not authorised to start) or in operation (or authorised to start).
- **Heating/cooling/auto selection in local mode:** operating mode selected via the user interface. See Information menu.
- **Remote heating/cooling contacts:** these contacts are only active if the unit is under remote control. See sections 3.6.2 and 3.6.3.
- **HC_SEL:** this network command permits heating/cooling/auto control, if the unit is in CCN operating mode.
- **Outdoor temperature:** determines the operation, if the unit is in automatic heating/cooling/standby changeover mode.

PARAMETER STATUS

ON/OFF STATUS	CONTROL TYPE	HEATING/COOLING SELECTION IN LOCAL MODE	REMOTE HEATING/COOLING CONTACTS	HC_SEL	OUTDOOR TEMPERATURE	OPERATING MODE
Off	-	-	-	-	-	Cooling
On	Local	Cooling	-	-	-	Cooling
On	Local	Heating	-	-	-	Heating
On	Local	Auto	-	-	> Cooling threshold	Cooling
On	Local	Auto	-	-	< Heating threshold	Heating*
On	Local	Auto	-	-	Between cooling and heating thresholds	Standby
On	Remote	-	Cooling mode	-	-	Cooling
On	Remote	-	Heating mode	-	-	Heating
On	Remote	-	Auto mode	-	> Cooling threshold	Cooling
On	Remote	-	Auto mode	-	< Heating threshold	Heating*
On	Remote	-	Auto mode	-	Between cooling and heating thresholds	Standby
On	CCN	-	-	Cooling	-	Cooling
On	CCN	-	-	Heating	-	Heating
On	CCN	-	-	Auto	> Cooling threshold	Cooling
On	CCN	-	-	Auto	< Heating threshold	Heating*
On	CCN	-	-	Auto	Between cooling and heating thresholds	Standby

* Does not apply to cooling only units that do not control a boiler.

5.3 - Evaporator water pump control

The unit can control one or two evaporator water pumps. The evaporator water pump is turned on when this option is configured (see User configuration) and when the unit is in one of the on modes described above or in delay mode. Since the minimum value for the delay at start-up is 1 minute (configurable between 1 and 15 minutes), the pump will run for at least one minute before the first compressor starts. The pump is kept running for 20 seconds after the unit goes to stop mode. The pump keeps working when the unit switches from heating to cooling mode or vice-versa. It is turned off if the unit is shut down due to an alarm unless the fault is a frost protection error. The pump can be started in particular operating conditions when the evaporator heater is active (see section 5.5). See section 5.14 for the particular evaporator pump control for the follower unit (master/slave assembly).

If two pumps are controlled and the reversing function has been selected (see User 1 configuration), the control tries to limit the pump run time delta to the configured pump change-over delay. If this delay has elapsed, the pump reversing function is activated, when the unit is running. During the reversing function both pumps run together for two seconds.

If a pump has failed and a secondary pump is available, the unit is stopped and started again with this pump.

The control provides a means to automatically start the pump each day at 14.00 hours for 2 seconds when the unit is off. If the unit is fitted with two pumps, the first pump is started on odd days and the second pump is started on even days. Starting the pump periodically for few seconds increases the life-time of the pump bearings and the tightness of the pump seal.

5.4 - Control interlock contact

This contact checks the status of a loop (water flow switch and customer safety loop, see section 3.6). It prevents the unit from starting if it is open when the delay at start-up has expired. This open contact leads to an alarm shut-down, if the unit is running.

5.5 - Evaporator antifreeze protection

The heater for the evaporator and water pump cycling (for units with a pump) can be energised to protect the evaporator, if it can be damaged by freezing, when the unit is shut down for a long time at low outdoor temperature.

NOTE: Evaporator heater control parameters can be modified, using the Service configuration.

5.6 - Control point

The control point represents the water temperature that the unit must produce. The inlet water is controlled by default, but the outlet water can also be controlled (requires a Service configuration modification).

Control point = active setpoint + reset

5.6.1 - Active setpoint

Two setpoints can be selected as active in cooling mode and three in heating mode. Usually, the second cooling setpoint is used for unoccupied periods or for ice storage (brine unit). The second setpoint in heating mode is used for unoccupied periods, and the third heating setpoint is used for holiday periods or public holidays. Depending on the current operations, the active setpoint can be selected by choosing the item in the Information menu, with the user's volt-free contacts, with network commands or with the setpoint timer program (schedule 2).

The following table summarises the possible selections depending on the control types (local, remote or CCN) and the following parameters:

- **Setpoint select in local control:** item #12 of the Information menu permits selection of the active setpoint, if the unit is in local operating type.
- **Heating/cooling operating mode**
- **Control contacts:** status of control contacts 5 and 6 (dual-circuit units only). These contacts are only active if the unit is in remote control operating type. See section 3.6.6.
- **Control contact 3:** status of control contact 3 (single-circuit units only). See section 3.6.4.
- **Control contact 3 selection:** this selection, only used for single-circuit units, indicates if contact 3 is used for dual setpoint control or for demand limit control (see User Configuration menu).
- **Schedule 2 status:** schedule for setpoint selection. See section 4.3.11.6.

LOCAL OPERATING MODE			
PARAMETER STATUS			
HEATING/COOLING OPERATING MODE	LOCAL SETPOINT SELECTION	SCHEDULE 2 STATUS	ACTIVE SETPOINT
Cooling	sp 1	-	Cooling setpoint 1
Cooling	sp 2	-	Cooling setpoint 2
Cooling	Auto	Occupied	Cooling setpoint 1
Cooling	Auto	Unoccupied	Cooling setpoint 2
Heating	sp 1	-	Heating setpoint 1
Heating	sp 2	-	Heating setpoint 2
Heating	sp 3	-	Heating setpoint 3
Heating	Auto	Occupied	Heating setpoint 1
Heating	Auto	Unoccupied	Heating setpoint 2
Heating	Auto	Holiday	Heating setpoint 3

REMOTE OPERATING MODE - DUAL-CIRCUIT UNITS			
PARAMETER STATUS			
HEATING/COOLING OPERATING MODE	CONTROL CONTACTS	SCHEDULE 2 STATUS	ACTIVE SETPOINT
Cooling	sp 1	-	Cooling setpoint 1
Cooling	sp 2	-	Cooling setpoint 2
Cooling	sp 3	-	Cooling setpoint 2
Cooling	Auto	Occupied	Cooling setpoint 1
Cooling	Auto	Unoccupied	Cooling setpoint 2
Heating	sp 1	-	Heating setpoint 1
Heating	sp 2	-	Heating setpoint 2
Heating	sp 3	-	Heating setpoint 3
Heating	Auto	Occupied	Heating setpoint 1
Heating	Auto	Unoccupied	Heating setpoint 2
Heating	Auto	Holiday	Heating setpoint 3

CCN OPERATING MODE		
PARAMETER STATUS		
HEATING/COOLING OPERATING MODE	SCHEDULE 2 STATUS	ACTIVE SETPOINT
Cooling	Occupied	Cooling setpoint 1
Cooling	Unoccupied	Cooling setpoint 2
Heating	Occupied	Heating setpoint 1
Heating	Unoccupied	Heating setpoint 2
Heating	Holiday	Heating setpoint 3

REMOTE OPERATING MODE - SINGLE-CIRCUIT UNITS				
PARAMETER STATUS				
HEATING/COOLING OPERATING MODE	CONTROL CONTACT 3 SELECTION	CONTROL CONTACT 3	SCHEDULE 2 STATUS	ACTIVE SETPOINT
Cooling	Setpoint	Setpoint 1	-	Cooling setpoint 1
Cooling	Setpoint	Setpoint 2	-	Cooling setpoint 2
Cooling	Demand limit	-	Occupied	Cooling setpoint 1
Cooling	Demand limit	-	Unoccupied	Cooling setpoint 2
Heating	Setpoint	Setpoint 1	-	Heating setpoint 1
Heating	Setpoint	Setpoint 2	-	Heating setpoint 2
Heating	Demand limit	-	Occupied	Heating setpoint 1
Heating	Demand limit	-	Unoccupied	Heating setpoint 2
Heating	Demand limit	-	Holiday	Heating setpoint 3

5.6.2 - Reset

Reset means that the active setpoint is modified so that less machine capacity is required (in cooling mode, the setpoint is increased, in heating mode it is decreased). This modification is in general a reaction to a drop in the load. For the Pro-Dialog control system, the source of the reset can be configured in the User 1 configuration: it can be provided either by the outdoor temperature (that gives a measure of the load trends for the building) or by the return water temperature (delta T that gives an average building load). In response to a drop in the outdoor temperature or to a drop in delta T, the cooling setpoint is normally reset upwards in order to optimise unit performance:

In both cases the reset parameters, i.e. slope, source and maximum value, are configurable in the Setpoints menu (see section 4.3.8). Reset is a linear function based on three parameters.

- A reference at which reset is zero (outdoor temperature or delta T - no reset value).
- A reference at which reset is maximum (outdoor temperature or delta T - full reset value).
- The maximum reset value.

Reset example in cooling mode

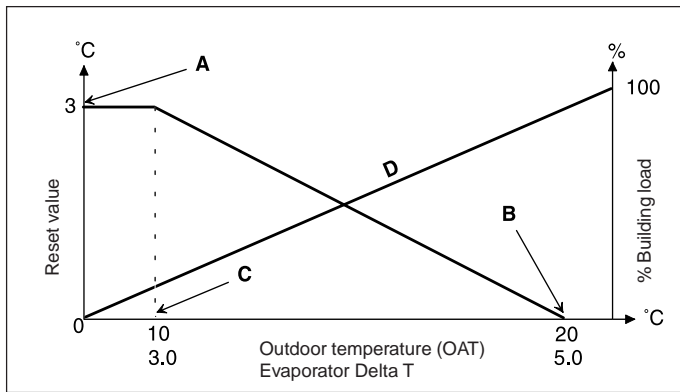

- Legend**
- A Maximum reset value
 - B OAT or delta T for no reset
 - C OAT or delta T for full reset
 - D Building Load

5.7 - Demand limit

Generally, demand limit is used by an energy management system to restrict the unit electricity consumption. The PRO-DIALOG control system enables the capacity of the unit to be limited by means of user-controlled volt-free contacts. Single-circuit units only have one contact (control contact 3), available in the User Configuration function for demand limiting or setpoint selection. Dual-circuit units have two volt-free contacts that permit several limit levels. The capacity of the unit cannot exceed the demand limit setpoint activated by the position of the contacts (see section 3.6.4 and 3.6.5 for the contact description). The demand limit setpoints are adjustable via the setpoint menu.

The demand limit is active in all operating types: Local, Remote or CCN. However in CCN operating type, demand limit can be controlled directly with the aid of CCN commands.

A limitation value of 100% means that the unit may call upon the full array of its capacity stages.

5.8 - Night mode

The night period is defined (see User configuration) by a start time and an end time that are the same for each day of the week. During the night period, the fan runs at low speed, if permitted by the current operating conditions. In addition, the user can reduce the unit capacity (but a minimum capacity value can be configured).

5.9 - Capacity control

This function adjusts the number of active compressors to keep the heat exchanger water temperature at its setpoint. The precision with which this is achieved depends on the capacity of the water loop, the flow rate, the load, and the number of stages available on the unit. The control system continuously takes account of the temperature error with respect to the setpoint, as well as the rate of change in this error and the difference between entering and leaving water temperatures, in order to determine the optimum moment at which to add or withdraw a capacity stage. If the same compressor undergoes too many starts (per hour) or runs below one minute each time it is started this automatically brings about reduction of compressor starts, which makes leaving water temperature control less precise. In addition, the high pressure, low pressure or defrost unloading functions can also affect the temperature control accuracy. Compressors are started and stopped in a sequence designed to equalise the number of start-ups (value weighted by their operating time).

NOTE: Circuits with 3 compressors (reversible heat pump units) only provide 2 capacity stages (2 compressors are started/stopped together).

5.10 - Head pressure control

Condensing pressure control is automatically ensured by a two-speed fan and can also be ensured by an additional fan on each circuit (no adjustment).

Fan start-up:

ATTENTION: In accordance with the operating conditions the fans can be cleaned periodically. A fan can start at any time, even if the unit has been shut down.

5.11 - Defrost function

Defrost is activated, when the unit is in heating mode, in order to reduce frost build-up on the air heat exchanger. The defrost cycle can only be applied to one circuit at a time. During the defrost cycle the fans of that circuit are stopped, and the four-way refrigerant valve is reversed, forcing the circuit to cooling mode. The fan can temporarily be restarted during the defrost cycle. The defrost cycle is fully automatic and does not require any setting. A condensate heater prevents ice formation at the bottom of the heat exchangers, if the defrost cycles are taking place at low outdoor temperature.

5.12 - Additional electric heater stage control

The heat pump units can control up to four additional electric heating stages.

The electric heating stages are activated to complement the heating capacity when the following conditions are satisfied:

- The unit uses 100% of the available heating capacity, or the unit is limited in its operation by a protection mode (low suction temperature, hot gas or defrost sequence in progress protection), and in all cases cannot satisfy the heating load.
- The outdoor temperature is below a configured threshold (see User 1 configuration).
- The unit demand limit is not active.

The user may configure the last available electric heating stages as a safety stage. In this case, the safety stage is only activated in addition to the other stages if there is a machine fault, preventing the use of the heating capacity. The other electric heating stages will continue to operate as described above.

5.13 - Control of a boiler

NOTE: The control of the electric heating stages or of a boiler is not authorised for slave units.

The unit can control the start-up of a boiler, if it is in heating mode. When the boiler is operating, the unit water pump is stopped.

A heat pump unit and a boiler cannot operate together. In this case the boiler output is activated in the following conditions:

- The unit is in heating mode, but a fault prevents the use of the heat pump capacity.
- The unit is in heating mode, but works at a very low outdoor temperature, making the heat pump capacity insufficient. The outdoor air temperature threshold for use of the boiler is fixed at -10°C , but this value can be adjusted in the User 1 menu.

5.14 - Master/slave assembly

Two PRO-DIALOG units can be linked to produce a master/slave assembly. The two machines are interconnected over the CCN bus. All parameters required for the master/slave function must be configured through the Service configuration menu. Master/slave operation requires the connection of a temperature probe at the common manifold on each machine, if the heat exchanger leaving water temperature is controlled.

The master/slave assembly can operate with constant or variable flow. In the case of variable flow each machine must control its own water pump and automatically shut down the pump, if the cooling capacity is zero. For constant flow operation the pumps for each unit are continuously operating, if the system is operating. The master unit can control a common pump that will be activated, when the system is started. In this case the slave unit pump is not used.

All control commands to the master/slave assembly (start/stop, setpoint, heating/cooling operation, load shedding, etc.) are handled by the unit which is configured as the master, and must therefore only be applied to the master unit. They will be transmitted automatically to the slave unit. The master unit can be controlled locally, remotely or by CCN commands. Therefore to start up the assembly, simply validate the Master operating type (MASt) on the master unit. If the Master has been configured for remote control then use the remote volt-free contacts for unit start/stop. The slave unit must stay in CCN operating type continuously. To stop the master/slave assembly, select Local Off (LOFF) on the master unit or use the remote volt-free contacts if the unit has been configured for remote control.

One of the functions of the master unit (depending on its configuration) may be the designation, whether the master or slave is to be the lead machine or the follower. The roles of lead machine and follower will be reversed when the difference in running hours between the two units exceeds a configurable value, ensuring that the running times of the two units are automatically equalised. The changeover between lead machine and follower may take place when the assembly is started up, or even whilst running. The running time balancing function is not active if it has not been configured: in this case the lead machine is always the master unit.

The lead machine will always be started first. When the lead machine is at its full available capacity, start-up delay (configurable) is initialised on the follower. When this delay has expired, and if the error on the control point is greater than 1.7°C , the follower unit is authorised to start and the pump is activated. The follower will automatically use the master unit active setpoint. The lead machine will be held at its full available capacity for as long as the active capacity on the follower is not zero. When the follower unit receives a command to stop, its evaporator water pump is turned off with 20 seconds delay.

In the event of a communication fault between the two units, each shall return to an autonomous operating mode until the fault is cleared. If the master unit is halted due to an alarm, the slave unit is authorised to start without prior conditions.

5.15 - Controlling Pro-Dialog units with a System Manager

Up to eight PRO-DIALOG units (or System Manager compatible units) can be controlled by one control module of the FSM, CSM III or HSM type which can handle multitasking of control functions such as starting units in sequence.

6 - DIAGNOSTICS - TROUBLESHOOTING

6.1 - General

The PRO-DIALOG control system has many fault tracing aid functions. The local interface and its various menus give access to all unit operating conditions. The test function makes it possible to run a quick test of all devices on the unit. If an operating fault is detected, an alarm is activated and an alarm code is stored in the Alarm menu.

6.2 - Displaying alarms

The alarm LEDs on the summary interface (see section 4.1) give a quick display of the status of each circuit and the unit as a whole.

- A flashing LED shows that the circuit is operating but there is an alarm.
- A steady LED shows that the circuit has been shut down due to a fault.

The Alarm menu on the main interface displays up to 5 fault codes that are active on the unit.

6.3 - Resetting alarms

When the cause of the alarm has been corrected the alarm can be reset, depending on the type, either automatically on return to normal, or manually when action has been taken on the unit. Alarms can be reset even if the unit is running.

6.4 - Alarm codes









The following list gives a complete description of each alarm code and its possible cause.

ALARM CODE DESCRIPTIONS					
ALARM CODE	ALARM NAME	ALARM DESCRIPTION	ACTION TAKEN BY THE CONTROL	RESET TYPE	PROBABLE CAUSE
1	Compressor A1 failure	Motor safety input has opened due to compressor overtemperature protection.	Compressor is shut down	Manual	Compressor overheat
2	Compressor A2 failure	As above	As above	As above	As above
3	Compressor A3 failure	As above	As above	As above	As above
5	Compressor B1 failure	As above	As above	As above	As above
6	Compressor B2 failure	As above	As above	As above	As above
7	Compressor B3 failure	As above	As above	As above	As above
9	Heat exchanger leaving fluid thermistor failure	Thermistor outside range	Unit shut down	Automatic, if temp. measured by sensor returns to permitted range of values	Faulty thermistor, wiring error or disconnection
10	Heat exchanger entering fluid thermistor failure	As above	As above	As above	As above
11	CHWS fluid thermistor failure (master/slave)	As above	As above	As above	As above
12	Defrost sensor fault, circuit A	As above	Circuit shut down, if unit is in heating mode	As above	As above
13	Defrost sensor fault, circuit B	As above	As above	As above	As above
14	OAT sensor failure	As above	As above	As above	As above
15	Discharge pressure transducer failure, Circuit A	Voltage delivered by the sensor is incorrect	Circuit A shut down	Automatic if the voltage delivered by the sensor returns to normal	Defective transducer, wiring fault
16	Discharge pressure transducer failure, Circuit B	Value read by the sensor is outside range	Circuit B shut down	As above	As above
17	Suction pressure transducer failure, Circuit A	Voltage delivered by the sensor is incorrect	Circuit A shut down	As above	As above
18	Suction pressure transducer failure, Circuit B	Value read by the sensor is outside range	Circuit B shut down	As above	As above
21	CCN/clock board failure	The clock board is no longer detected	Unit shut down	Automatic if board is detected again	Defective CCN/clock board
22	Loss of communication with slave board	Communication has been lost with the slave board (circuit B control)	Circuit B shut down	Automatic if communication is re-established	Bus wiring fault, wrong software in slave board or defective slave board
23	Loss of communication with compressor slave board	Communication has been lost with the compressor A3 + B3 control board	Compressors A3 + B3 shut down	As above	As above
24	Loss of communication with PD-4 x DO slave board	Communication has been lost with the electric heating stage control board	Electric heating stages shut down	As above	As above

This means that an alarm can be reset without stopping the machine. In the event of a power supply interrupt, the unit restarts automatically without the need for an external command. However, any faults active when the supply is interrupted are saved and may in certain cases prevent a circuit or a unit from restarting.

A manual reset must be run from the main interface using the following procedure:

RESET OF ACTIVE ALARMS

OPERATION	ITEM NUMBER	ITEM VALUE	PRESS MENU
	2-DIGIT DISPLAY	4-DIGIT DISPLAY	BUTTON LED
Hold down the MENU button until the LED for alarms lights. The 4-digit display shows the number of active alarms (2 in this example).	0	0	 
Press the Enter button until "rESEt ALARm" is shown in the 4-digit display.	0	2 ALArM	 
Press the Enter button again to validate the reset. "Good" is displayed for 2 seconds then, "2 ALArM" and then, "no ALArM".	0	rESEt ALArM	 
		Good then, 2 AL then, no ALArM	 

ALARM CODE DESCRIPTIONS (continued)					
ALARM CODE	ALARM NAME	ALARM DESCRIPTION	ACTION TAKEN BY THE CONTROL	RESET TYPE	PROBABLE CAUSE
30	Low refrigerant pressure failure, circuit A	Circuit running and the suction pressure below threshold	Circuit shut down	Automatic when pressure returns to normal and if the same fault has not occurred the same day (machine equipped with CCN/clock board, If not, manual)	Shortage of refrigerant, filter blocked or faulty pressure sensor
31	Low refrigerant pressure failure, circuit B	As above	As above	As above	As above
32	High pressure failure, circuit A	Circuit running and the discharge pressure exceeds the high pressure trip point	Circuit shut down	Manual, the high pressure switch must be reset manually with the push-button located on or in the pressure switch	Fan circuit fault, high condenser entering air temperature
33	High pressure failure, circuit B	As above	As above	As above	As above
34	Reverse compressor rotation, circuit A	One circuit compressor runs in reverse rotation	As above	As above	Incorrect compressor wiring
35	Reverse compressor rotation, circuit B	As above	As above	As above	As above
36	Water heat exchanger frost protection	The heat exchanger entering or leaving water sensor is below the frost trip point	Unit shut down	Automatic if the same alarm has not tripped the same day (machine equipped with CCN/clock board, If not, manual)	Low water flow or defective thermistor
37	Repeated low evaporator suction temperature unloading, circuit A	More than 6 successive circuit capacity unloads because of low suction temperature override.	Circuit shut down	Manual	Faulty pressure sensor, clogged filter or low refrigerant charge
38	Repeated low evaporator suction temperature unloading, circuit B	As above	As above	As above	As above
39	Repeated high pressure unloading, circuit A	More than 6 successive circuit capacity unloads because of high pressure override.	None	Automatic	Faulty transducer, high condenser entering air temperature, high entering water temperature, condenser fouled fan flow rate too low.
40	Repeated high pressure unloading, circuit B	As above	As above	As above	As above
41	Repeated high discharge temperature unloading in heating mode, circuit A	More than 8 successive circuit capacity unloads because of high discharge temperature	As above	As above	Pressure sensor faulty or heat exchanger fouled
42	Repeated high discharge temperature unloading in heating mode, circuit B	As above	As above	As above	As above
43	Repeated low suction temperature unloading in heating mode, circuit A	More than 8 successive circuit capacity unloads because of low suction temperature	As above	As above	Pressure sensor faulty, filter obstructed, shortage of refrigerant, heat exchanger fouled or fan faulty.
44	Repeated low suction temperature unloading in heating mode, circuit B	As above	As above	As above	As above
45	Low heat exchanger entering water temperature in heating mode	Heat exchanger temperature is too low (less than 10°C), preventing unit start-up	Unit shut down	As above	As above
46	Safety interlock open	Safety interlock not closed before end of the start-up delay or opens during operation	Unit prevented to start or shut down	Manual	Evaporator pump control or water flow switch failure
47	Pump #1 fault	Evap. water pump run contact opens while the pump has received a command to be on	Unit shut down	Manual	Pump overheat, incorrect pump connection
48	Pump #2 fault	As above	Unit shut down	Manual	As above
49	CCN emergency stop	CCN command received to shutdown the unit	Unit shut down	Manual	Network command
50	Loss of communication with System Manager	The unit is controlled by a System Manager and communication with this module is lost for more than 2 minutes	Unit returns to autonomous operating mode	Automatic when communication is re-established	Defective CCN bus wiring or system module failure
51	Communication failure with the master or the slave unit	The master/slave link is broken due to a loss of communication between the two units for more than 2 minutes	As above	As above	As above
52	Initial factory configuration required	All factory parameters are zero	Unit prevented to start	Automatic	No factory configuration
53	Illegal factory configuration	Wrong factory configuration	As above	Automatic	Factory configuration error
54	Master/slave configuration error	Wrong master/slave configuration	Master/slave control disabled	Automatic	Master or slave configuration error
55-2	Maintenance alerts	A maintenance alert is active	None	Manual	
55-4	Water loop flow rate too low				
55-5	Maintenance delay, pump 1, elapsed				
55-6	Maintenance delay, pump 2, elapsed				
55-7	Maintenance delay, water filter, elapsed				



Environmental Management System Approval



Order No. 13444-76, 06.2005. Supersedes order No.: 13429-76, 06.2004.
 Manufacturer reserves the right to change any product specification without notice.

Manufactured by: Carrier s.a., Montluel, France.
 Printed in the Netherlands on chlorine-free paper.

Free Manuals Download Website

<http://myh66.com>

<http://usermanuals.us>

<http://www.somanuals.com>

<http://www.4manuals.cc>

<http://www.manual-lib.com>

<http://www.404manual.com>

<http://www.luxmanual.com>

<http://aubethermostatmanual.com>

Golf course search by state

<http://golfingnear.com>

Email search by domain

<http://emailbydomain.com>

Auto manuals search

<http://auto.somanuals.com>

TV manuals search

<http://tv.somanuals.com>