

Advanced User's Guide

MFC-9130CW
MFC-9330CDW
MFC-9340CDW

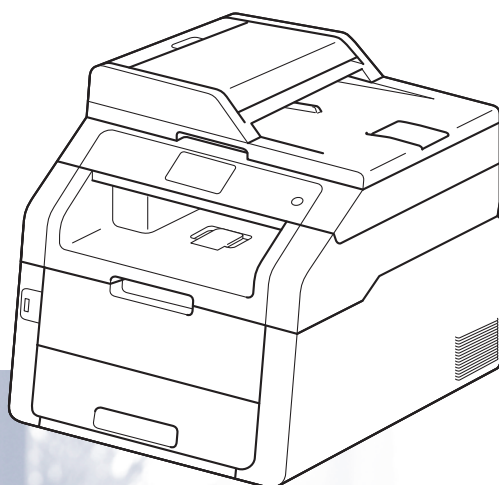

Not all models are available in all countries.

User's Guides and where do I find them?

Which Guide?	What's in it?	Where is it?
Product Safety Guide	Read this Guide first. Read the Safety Instructions before you set up your machine. See this Guide for trademarks and legal limitations.	Printed / In the Box
Quick Setup Guide	Follow the instructions for setting up your machine and installing the drivers and software for the operating system and connection type you are using.	Printed / In the Box
Basic User's Guide	Learn the basic Fax, Copy, Scan and Direct Print operations and how to replace consumables. See troubleshooting tips.	Printed / In the Box
Advanced User's Guide	Learn more advanced operations: Fax, Copy, security features, printing reports and performing routine maintenance.	For USA: PDF file / Brother Solutions Center ¹ For Other Countries: PDF file / CD-ROM / In the Box
Software User's Guide	Follow these instructions for Printing, Scanning, Network Scanning, Remote Setup, PC-Fax, and using the Brother ControlCenter utility.	For USA: HTML file / Brother Solutions Center ¹ For Other Countries: HTML file / CD-ROM / In the Box
Network User's Guide	This Guide provides useful information about wired and wireless network settings and security settings using the Brother machine. You can also find supported protocol information for your machine and detailed troubleshooting tips.	For USA: PDF file / Brother Solutions Center ¹ For Other Countries: PDF file / CD-ROM / In the Box
Wi-Fi Direct™ Guide	This Guide provides information about how to configure and use your Brother machine for wireless printing directly from a mobile device supporting the Wi-Fi Direct™ standard.	PDF file / Brother Solutions Center ¹
Google Cloud Print Guide	This Guide provides information about how to configure your Brother machine to a Google account and use Google Cloud Print services for printing over the Internet.	PDF file / Brother Solutions Center ¹
Mobile Print/Scan Guide for Brother iPrint&Scan	This Guide provides useful information about printing from your mobile device and scanning from your Brother machine to your mobile device when connected on a Wi-Fi network.	PDF file / Brother Solutions Center ¹

Which Guide?	What's in it?	Where is it?
Web Connect Guide	This Guide provides information about how to configure and use your Brother machine to scan, load and view images and files on certain Web sites that provide these services.	PDF file / Brother Solutions Center ¹
AirPrint Guide	This Guide provides information for using AirPrint to print from OS X v10.7.x, 10.8.x and your iPhone, iPod touch, iPad, or other iOS device to your Brother machine without installing a printer driver.	PDF file / Brother Solutions Center ¹

¹ Visit us at <http://solutions.brother.com/>.

Table of Contents

1	General Setup	1
	Memory storage.....	1
	Volume settings	1
	Ring volume.....	1
	Beeper volume	2
	Speaker volume.....	2
	Automatic Daylight Saving Time.....	3
	Ecology features	3
	Toner Save	3
	Sleep Time	4
	Deep Sleep mode	4
	Touchscreen	5
	Setting the backlight brightness.....	5
	Setting the Dim Timer for the backlight	5
	Dial Prefix	6
	Setting up the prefix number	6
	Changing the prefix number	6
2	Security features	7
	Secure Function Lock 2.0.....	7
	Before you begin to use Secure Function Lock 2.0.....	8
	Setting and changing the Administrator Password.....	8
	Setting up restricted users.....	9
	Setting up and changing the Public user mode	9
	Turning Secure Function Lock on/off.....	10
	Switching Users.....	11
	Setting Lock	12
	Setting up the administrator password	12
	Changing the Setting Lock administrator password	13
	Turning Setting Lock on/off.....	13
	Restricting dialing	14
	Dial pad restriction.....	14
	Address Book restriction.....	14
	Shortcuts restriction.....	14

3	Sending a fax	15
	Additional sending options.....	15
	Sending faxes using multiple settings	15
	Changing a 2-sided fax layout (MFC-9340CDW)	16
	Contrast	17
	Changing Fax Resolution	17
	Additional sending operations.....	18
	Sending a fax manually	18
	Sending a fax at the end of a conversation	18
	Dual access	19
	Broadcasting.....	19
	Real Time Transmission.....	21
	Overseas Mode	21
	Delayed Fax	22
	Delayed batch transmission	22
	Checking and canceling waiting jobs.....	23
	Setting your changes as the new default.....	23
	Restoring all fax settings to the factory settings	24
	Saving fax options as a Shortcut	24
	Electronic cover page	25
	Destination Display.....	27
	Polling.....	28
	Polled transmit.....	28
4	Receiving a fax	29
	Memory Receive Options	29
	Fax Forwarding.....	29
	Paging	30
	Fax Storage	31
	Changing Memory Receive Options.....	31
	Turning off Remote Fax Options	32
	Remote retrieval	33
	Setting a Remote Access Code.....	33
	Using your Remote Access Code.....	33
	Remote fax commands.....	34
	Retrieving fax messages	35
	Changing the Fax Forwarding number	35
	Additional receiving operations.....	36
	Printing a reduced incoming fax	36
	2-sided printing for Fax mode (MFC-9330CDW and MFC-9340CDW)	36
	Setting the Fax Receive Stamp	37
	Receiving a fax at the end of a conversation.....	37
	Setting the Print Density	38
	Printing a fax from the memory	38
	Receiving faxes into memory when the paper tray is empty	39
	Polling.....	40
	Polling receive	40

5	Dialing and storing numbers	42
	Telephone line services	42
	Tone or Pulse (Canada only)	42
	For Fax/Tel mode only	42
	Special line considerations	42
	Additional dialing operations	44
	Dialing access codes and credit card numbers	44
	Additional ways to store numbers	45
	Storing Address Book numbers from Outgoing Calls	45
	Setting up Groups for Broadcasting	45
6	Printing reports	48
	Fax reports	48
	Transmission Verification Report	48
	Fax Journal (Activity Report)	48
	Reports	49
	How to print a report	50
7	Making copies	51
	Copy settings	51
	Stop copying	51
	Improving copy quality	51
	Enlarging or reducing copies	52
	2-sided Copying (MFC-9330CDW and MFC-9340CDW)	53
	Adjusting Density and Contrast	55
	Sorting copies	56
	Making N in 1 copies (page layout)	56
	2 in 1 ID Copy	58
	Adjusting the Color Saturation	59
	Making 2-sided N in 1 copies (MFC-9340CDW)	59
	Removing Background Color	60
	Saving copy options as a Shortcut	61
	Saving paper	61

A	Routine maintenance	62
	Cleaning and checking the machine.....	62
	Cleaning the outside of the machine	63
	Cleaning the LED heads.....	64
	Cleaning the scanner.....	65
	Cleaning the corona wires	67
	Cleaning the drum unit	70
	Cleaning the paper pick-up rollers.....	76
	Calibration	77
	Auto Registration	78
	Frequency (Color Correction)	78
	Printing the test print.....	79
	Checking the Page Counters.....	79
	Checking the remaining life of toner cartridges	80
	Checking the remaining life of parts	80
	Replacing periodic maintenance parts.....	81
	Packing and shipping the machine	82
B	Glossary	84
C	Index	88



NOTE

Most of the illustrations in this User's Guide show the MFC-9340CDW.



Memory storage

Your menu settings are stored permanently, and in the event of a power failure will *not* be lost. Temporary settings (for example, Contrast and Overseas Mode) *will* be lost. Also, during a power failure the machine will retain the date and time and programmed fax timer jobs (for example, Delayed Fax) for approximately 60 hours. Other fax jobs in the machine's memory will not be lost.

Volume settings



Ring volume

You can choose from a range of ring volume levels, from **High** to **Off**.

- 1 Press .
- 2 Press **All Settings**.
- 3 Swipe up or down, or press **▲** or **▼** to display **General Setup**.
- 4 Press **General Setup**.
- 5 Swipe up or down, or press **▲** or **▼** to display **Volume**.
- 6 Press **Volume**.
- 7 Press **Ring**.
- 8 Press **Off**, **Low**, **Med** or **High**.
- 9 Press .



Beeper volume

When the beeper is on, the machine will make a sound when you press the Touchscreen or Touchpanel, make a mistake, or after you send or receive a fax. You can choose from a range of sound levels, from High to Off.

- 1 Press .
- 2 Press All Settings.
- 3 Swipe up or down, or press ▲ or ▼ to display General Setup.
- 4 Press General Setup.
- 5 Swipe up or down, or press ▲ or ▼ to display Volume.
- 6 Press Volume.
- 7 Press Beep.
- 8 Press Off, Low, Med or High.
- 9 Press .



Speaker volume

You can choose from a range of speaker volume levels, from High to Off.

- 1 Press .
- 2 Press All Settings.
- 3 Swipe up or down, or press ▲ or ▼ to display General Setup.
- 4 Press General Setup.
- 5 Swipe up or down, or press ▲ or ▼ to display Volume.
- 6 Press Volume.
- 7 Press Speaker.
- 8 Press Off, Low, Med or High.
- 9 Press .

Automatic Daylight Saving Time



You can set the machine to change automatically for Daylight Saving Time. It will set itself forward one hour in the spring, and back one hour in the fall.

- 1 Press .
- 2 Press  (Date & Time).
- 3 Swipe up or down, or press ▲ or ▼ to display Auto Daylight.
- 4 Press Auto Daylight.
- 5 Press On or Off.
- 6 Press .

Ecology features

Toner Save

You can save toner using this feature. When you set Toner Save to On, print appears lighter. The factory setting is Off.

- 1 Press .
- 2 Press All Settings.
- 3 Swipe up or down, or press ▲ or ▼ to display General Setup.
- 4 Press General Setup.
- 5 Swipe up or down, or press ▲ or ▼ to display Ecology.
- 6 Press Ecology.
- 7 Press Toner Save.
- 8 Press On or Off.
- 9 Press .

NOTE



We do not recommend Toner Save for printing Photo or Gray Scale images.

Sleep Time

The Sleep Time setting can reduce power consumption. When the machine is in Sleep mode (Power Save mode) it acts as though it is turned off. The machine will wake up and start printing when it receives a print job.

You can choose how long the machine must be idle before it goes into Sleep mode. The timer will restart if any operation is carried out on the machine, such as receiving a fax or a print job. The factory setting is three minutes.

When the machine goes into Sleep mode, the Touchscreen backlight turns off.

- 1 Press .
- 2 Press All Settings.
- 3 Swipe up or down, or press ▲ or ▼ to display General Setup.
- 4 Press General Setup.
- 5 Swipe up or down, or press ▲ or ▼ to display Ecology.
- 6 Press Ecology.
- 7 Press Sleep Time.
- 8 Using the keyboard on the Touchscreen, enter the length of time (0-50 minutes) the machine will remain idle before entering Sleep mode. Press OK.
- 9 Press .

Deep Sleep mode



If the machine is in Sleep mode and does not receive any jobs for a certain length of time, the machine will go into Deep Sleep mode automatically. Deep Sleep mode uses less power than Sleep mode. The machine will wake up when it receives a job or if you press the Touchscreen.

When the machine is in Deep Sleep mode, the Touchscreen backlight turns off and  blinks.

Touchscreen



Setting the backlight brightness

You can adjust the brightness of the Touchscreen LCD backlight. If you are having difficulty reading the Touchscreen, try changing the brightness setting.

- 1 Press .
- 2 Press All Settings.
- 3 Swipe up or down, or press ▲ or ▼ to display General Setup.
- 4 Press General Setup.
- 5 Swipe up or down, or press ▲ or ▼ to display LCD Settings.
- 6 Press LCD Settings.
- 7 Press Backlight.
- 8 Press Light, Med Or Dark.
- 9 Press .

Setting the Dim Timer for the backlight

You can set how long the Touchscreen LCD backlight stays on after you go back to your Home screen.

- 1 Press .
- 2 Press All Settings.
- 3 Swipe up or down, or press ▲ or ▼ to display General Setup.
- 4 Press General Setup.
- 5 Swipe up or down, or press ▲ or ▼ to display LCD Settings.
- 6 Press LCD Settings.
- 7 Press Dim Timer.
- 8 Press Off, 10Secs, 20Secs or 30Secs.
- 9 Press .

Dial Prefix

The Dial Prefix setting will automatically dial a predefined number before every fax number you dial. For example: If your telephone system requires a 9 to dial an outside number, use this setting to automatically dial 9 for every fax you send.

Setting up the prefix number



- 1 Press .
- 2 Press All Settings.
- 3 Swipe up or down, or press ▲ or ▼ to display Initial Setup.
- 4 Press Initial Setup.
- 5 Swipe up or down, or press ▲ or ▼ to display Dial Prefix.
- 6 Press Dial Prefix.
- 7 Press On (or Off).
- 8 Press Dial Prefix.
- 9 Enter the prefix number (up to 5 digits) using the keyboard on the Touchscreen. Press OK.

NOTE

- You can use the numbers and symbols 0 to 9, #, and *. (You cannot use ! with any other numbers or symbols.)
- If your telephone system requires a time break recall (hookflash), press ! on the Touchscreen.
- (Canada only) If pulse dialing mode is on, # and * are not available to use.

- 10 Press .

Changing the prefix number

- 1 Press .
- 2 Press All Settings.
- 3 Swipe up or down, or press ▲ or ▼ to display Initial Setup.
- 4 Press Initial Setup.
- 5 Swipe up or down, or press ▲ or ▼ to display Dial Prefix.
- 6 Press Dial Prefix.
- 7 Press On (or Off).
You can turn off the prefix number by pressing Off. The prefix number will remain off until you press On.
- 8 Press Dial Prefix.
- 9 Do one of the following using the keyboard on the Touchscreen.
 - To change the prefix number, press ◀ or ▶ to position the cursor under the digit to be deleted and press the Back Space button . Then press the correct digit.
Repeat until the prefix number is correct, and then press OK.
 - To exit without making a change, press OK.

NOTE

- You can use the numbers and symbols 0 to 9, #, and *. (You cannot use ! with any other numbers or symbols.)
- If your telephone system requires a time break recall (hookflash), press ! on the Touchscreen.
- (Canada only) If pulse dialing mode is on, # and * are not available to use.

- 10 Press .

Secure Function Lock 2.0

Secure Function Lock lets you restrict Public access to the following machine functions:

- **Fax Tx** (Fax Sending)
- **Fax Rx** (Fax Receiving)
- **Copy**
- **Scan**¹
- **USB Direct Print**³
- **Print**²
- **Web Connect (Upload)**
- **Web Connect (Download)**
- **Color Print**^{2 4}
- **Page Limit**⁴

¹ Scan includes scan jobs via Brother iPrint&Scan.

² Print and Color Print include print jobs via AirPrint, Google Cloud Print and Brother iPrint&Scan.

³ For MFC-9330CDW and MFC-9340CDW

⁴ Available for **Print**, **USB Direct Print**, **Copy** and **Web Connect (Download)**.

This feature also prevents users from changing the default settings of the machine by limiting access to the Menu settings.

Before using the security features you must first enter an administrator password.

The administrator can set up restrictions for individual users along with a user password.

Make a careful note of your password. If you forget it, you will have to reset the password stored in the machine. For information about how to reset the password call Brother Customer Service.

NOTE

- Secure Function Lock can be set manually from the Touchscreen, or by using Web Based Management or BRAdmin Professional 3 (Windows® only). We recommend using Web Based Management or BRAdmin Professional 3 (Windows® only) to configure this feature (see Network User's Guide).
- Only administrators can set limitations and make changes for each user.
- Polling Receive is enabled only when both Fax Tx and Fax Rx are enabled.

Before you begin to use Secure Function Lock 2.0

You can configure the Secure Function Lock 2.0 settings using a web browser. Before configuration, the following preparations are needed.

- 1 Start your web browser.
- 2 Type “http://machine’s IP address/” into your browser’s address bar (where “machine’s IP address” is the IP address of the Brother machine).
 - For example:
http://192.168.1.2/

NOTE

You can find the machine’s IP address in the Network Configuration List (see *Network User’s Guide: Printing the Network Configuration Report*).

- 3 Type a password in the **Login** box. (This is a password to log on to the machine’s web page, not the administrator password for Secure Function Lock.) Click .



NOTE

If you are using a web browser to configure the machine’s settings for the first time, set a password.

- 1 Click **Please configure the password.**
- 2 Type a password (up to 32 characters).
- 3 Retype the password in the **Confirm New Password** field.
- 4 Click **Submit.**

Setting and changing the Administrator Password

You can configure these settings using a web browser. To set up the web page, see *Before you begin to use Secure Function Lock 2.0* on page 8. Then set up the administrator.

Setting the administrator password

The administrator password is used to set up users and to turn Secure Function Lock on or off (see *Setting up restricted users* on page 9 and *Turning Secure Function Lock on/off* on page 10).

- 1 Click **Administrator.**
- 2 Click **Secure Function Lock.**
- 3 Type a four-digit number for the password in the **New Password** field.



- 4 Retype the password in the **Retype Password** field.
- 5 Click **Submit.**

Changing the administrator password

- 1 Click **Administrator.**
- 2 Click **Secure Function Lock.**
- 3 Type a four-digit number for the password in the **New Password** field.
- 4 Retype the password in the **Retype Password** field.
- 5 Click **Submit.**

Setting up restricted users

You can set up users with restrictions and a password. You can set up to 25 restricted users.

You can configure these settings using a web browser. To set up the web page, see *Before you begin to use Secure Function Lock 2.0* on page 8. Then follow these steps:

- 1 Click **Administrator**.
- 2 Click **Secure Function Lock**.
- 3 Type an alphanumeric Group name or User name (up to 15 characters) in the **ID Number/Name** field and then type a four-digit password in the **PIN** field.

The screenshot shows the 'Secure Function Lock' web interface. At the top, there are tabs for 'Copy', 'Print', 'Scan', 'Administrator', and 'Network'. The 'Administrator' tab is selected. Below the tabs, there is a 'Function Lock' section with a radio button for 'Off' and a checked radio button for 'On'. Underneath, there is an 'Administrator Password' section with fields for 'New Password' and 'Retype Password'. The main part of the interface is a table for configuring user restrictions. The table has columns for 'ID Number/Name', 'PIN', 'Print', 'USB Direct Print', 'Copy', 'Print Option' (with sub-columns for 'Color Print', 'Page Limit', and 'Max.'), 'Fax TX', 'Fax RX', and 'Scan'. The 'Public Mode' row is highlighted, and the 'Print' column has a checked checkbox. The 'Page Limit' and 'Max.' columns have input fields with the number '5' entered.

- 4 Clear the functions that you want to restrict in the **Print** check box and **Others** check box. To configure the maximum page count, select the **On** check box in **Page Limit**, and then type the number in the **Max.** field.
- 5 Click **Submit**.

Setting up and changing the Public user mode

Public user mode restricts the functions that are available for all users who do not have a password.

When you set up restrictions for Public users, you must do it through Web Based Management or BRAdmin Professional 3 (Windows® only) (see Network User's Guide).

- 1 Click **Administrator**.
- 2 Click **Secure Function Lock**.
- 3 Clear the functions that you want to restrict in the **Print** check box and **Others** check box. To configure the maximum page count, select the **On** check box in **Page Limit**, and then type the number in the **Max.** field.

This screenshot is identical to the one above, showing the 'Secure Function Lock' web interface with the 'Administrator' tab selected and the 'Public Mode' row highlighted in the configuration table.

- 4 Click **Submit**.

Turning Secure Function Lock on/off

NOTE

Make a careful note of the administrator password. If you enter the wrong password, the Touchscreen will show **Wrong Password**. Enter the correct password. If you forget it, call Brother Customer Service.

Turning Secure Function Lock on



- 1 Press .
- 2 Press **All Settings**.
- 3 Swipe up or down, or press ▲ or ▼ to display **General Setup**.
- 4 Press **General Setup**.
- 5 Swipe up or down, or press ▲ or ▼ to display **Security**.
- 6 Press **Security**.
- 7 Press **Function Lock**.
- 8 Press **Lock Off⇒On**.
- 9 Enter the registered four-digit administrator password using the keyboard on the Touchscreen. Press **OK**.

NOTE

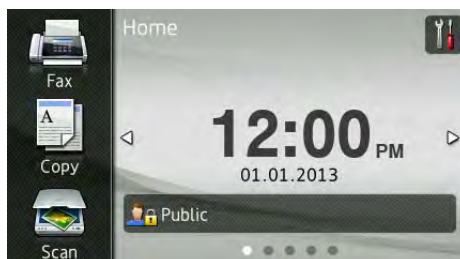
The Secure Function Lock icon is displayed beneath the time and date.



Turning Secure Function Lock off

- 1 Press  **Public** or .
- 2 Press **Lock On⇒Off**.
- 3 Enter the registered four-digit administrator password using the keyboard on the Touchscreen. Press **OK**.





(Where xxxxx is the user's name.)

Switching Users

This setting allows you to switch between registered restricted users or Public mode when Secure Function Lock is turned on.

Changing to the restricted user mode

- 1 Press  or .

(Where xxxxx is the user's name.)
- 2 Press `Change User`.
- 3 Swipe up or down, or press ▲ or ▼ to display your user name.
- 4 Press your user name.
- 5 Enter your four-digit user password using the keyboard on the Touchscreen. Press `OK`.

NOTE

- If the current ID is restricted for the function you want, `Access Denied` will appear on the Touchscreen.
- If your ID has page limit restrictions and has already reached the maximum number of pages, the Touchscreen will show `Limit Exceeded` or `Access Denied` when you try to print. Call your administrator to check your Secure Function Lock Settings.

Changing to the Public mode

- 1 Press .

(Where xxxxx is the user's name.)
- 2 Press `Go to Public`.

NOTE

- After a restricted user has finished using the machine, it will return to Public mode after one minute.
- If the function you want is restricted for all users, `Access Denied` will appear on the Touchscreen and `Change User` screen will appear. You cannot access the function. Call your administrator to check your Secure Function Lock Settings.
- If your ID has Color Print restrictions to `Disable`, the Touchscreen will show `No Permission` when you try to print colored data.

Setting Lock



Setting Lock lets you set a password to stop other people from accidentally changing your machine settings.

Make a careful note of your password. If you forget it, you will have to reset the passwords stored in the machine. Call your administrator or Brother Customer Service.



While Setting Lock is On, you cannot access the machine settings.

Machine settings cannot be changed through the **Remote Setup** utility while Setting Lock is On.

Setting up the administrator password

- 1 Press .
- 2 Press All Settings.
- 3 Swipe up or down, or press ▲ or ▼ to display General Setup.
- 4 Press General Setup.
- 5 Swipe up or down, or press ▲ or ▼ to display Security.
- 6 Press Security.
- 7 Press Setting Lock.
- 8 Enter a four-digit number for the new password using the keyboard on the Touchscreen.
Press OK.
- 9 Re-enter the new password when the Touchscreen shows Verify:.
Press OK.
- 10 Press .

Changing the Setting Lock administrator password

- 1 Press .
- 2 Press All Settings.
- 3 Swipe up or down, or press ▲ or ▼ to display General Setup.
- 4 Press General Setup.
- 5 Swipe up or down, or press ▲ or ▼ to display Security.
- 6 Press Security.
- 7 Press Setting Lock.
- 8 Press Set Password.
- 9 Enter the old four-digit password using the keyboard on the Touchscreen. Press OK.
- 10 Enter a four-digit number for the new password using the keyboard on the Touchscreen. Press OK.
- 11 Re-enter the new password when the Touchscreen shows Verify:. Press OK.
- 12 Press .

Turning Setting Lock on/off

If you enter the wrong password, the Touchscreen will show Wrong Password. Enter the correct password.

Turning Setting Lock on

- 1 Press .
- 2 Press All Settings.
- 3 Swipe up or down, or press ▲ or ▼ to display General Setup.
- 4 Press General Setup.
- 5 Swipe up or down, or press ▲ or ▼ to display Security.
- 6 Press Security.
- 7 Press Setting Lock.
- 8 Press Lock Off⇒On.
- 9 Enter the registered four-digit administrator password using the keyboard on the Touchscreen. Press OK.

Turning Setting Lock off

- 1 Press  on the Touchscreen.
- 2 Enter the registered four-digit administrator password using the keyboard on the Touchscreen. Press OK.

Restricting dialing



This feature is to prevent users from sending a fax or call to a wrong number by mistake. You can set the machine to restrict dialing when you use the dial pad, Address Book and Shortcuts.

If you choose *Off*, the machine does not restrict the dialing method.



If you choose *Enter # Twice*, the machine will prompt you to re-enter the number, and then if you re-enter the same number correctly, the machine will start dialing. If you re-enter the wrong number, the Touchscreen will show an error message.

If you choose *On*, the machine will restrict all fax sending and outbound calls for that dialing method.



Dial pad restriction

- 1 Press .
- 2 Press *All Settings*.
- 3 Swipe up or down, or press ▲ or ▼ to display *Fax*.
- 4 Press *Fax*.
- 5 Swipe up or down, or press ▲ or ▼ to display *Dial Restriction*.
- 6 Press *Dial Restriction*.
- 7 Press *Dial pad*.
- 8 Press *Enter # Twice, On or Off*.
- 9 Press .

Address Book restriction

- 1 Press .
- 2 Press *All Settings*.
- 3 Swipe up or down, or press ▲ or ▼ to display *Fax*.
- 4 Press *Fax*.
- 5 Swipe up or down, or press ▲ or ▼ to display *Dial Restriction*.
- 6 Press *Dial Restriction*.
- 7 Press *Address Book*.
- 8 Press *Enter # Twice, On or Off*.
- 9 Press .

Shortcuts restriction

- 1 Press .
- 2 Press *All Settings*.
- 3 Swipe up or down, or press ▲ or ▼ to display *Fax*.
- 4 Press *Fax*.
- 5 Swipe up or down, or press ▲ or ▼ to display *Dial Restriction*.
- 6 Press *Dial Restriction*.
- 7 Press *Shortcuts*.
- 8 Press *Enter # Twice, On or Off*.
- 9 Press .



Additional sending options

Sending faxes using multiple settings

Before you send a fax, you can change any combination of these settings:

- 2-sided Fax¹
- Contrast
- Fax Resolution
- Real Time TX
- Overseas Mode
- Delayed Fax
- Batch TX
- Coveragepage Message
- Coveragepage Setup
- Broadcasting

¹ For MFC-9340CDW

- 1 Do one of the following:
 - When Fax Preview is set to Off, press  (Fax).
 - When Fax Preview is set to On, press  (Fax) and Sending Fax(es).

The Touchscreen shows:

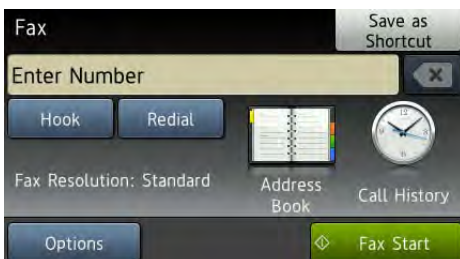



- 2 Press **Options**.
- 3 Swipe up or down, or press **▲** or **▼** to display the setting you want, and then press the setting.
- 4 Press the option you want.
- 5 Do one of the following:
 - Repeat steps 3 and 4 to change more settings.
 - If you are finished choosing settings, press **OK**. Go to the next step for sending your fax.

NOTE

- Most settings are temporary and the machine returns to its default settings after you send a fax.
- You can save some of the settings you use most often by setting them as the default settings. These settings will stay until you change them again (see *Setting your changes as the new default* on page 23).
- You can also save some of the settings you use most often by setting them as a Shortcut (see *Saving fax options as a Shortcut* on page 24).

Changing a 2-sided fax layout (MFC-9340CDW)

You must choose the 2-sided scanning format before you send a 2-sided fax. The format you choose will depend on the layout of your 2-sided document.

- 1 Load your document in the ADF.
- 2 Do one of the following:
 - When Fax Preview is set to Off, press  (Fax).
 - When Fax Preview is set to On, press  (Fax) and Sending Fax(es).
- 3 Press Options.
- 4 Swipe up or down, or press ▲ or ▼ to display 2-sided Fax.
- 5 Press 2-sided Fax.
- 6 Do one of the following:
 - If your document is flipped on the Short edge, press 2-sided Scan: Short Edge.

- If your document is flipped on the Long edge, press 2-sided Scan: Long Edge.

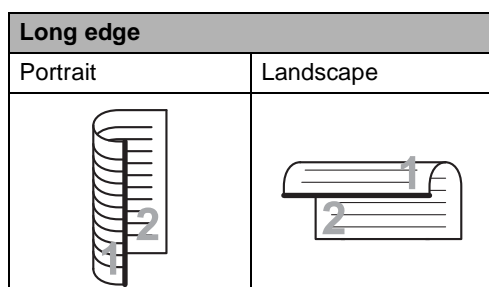
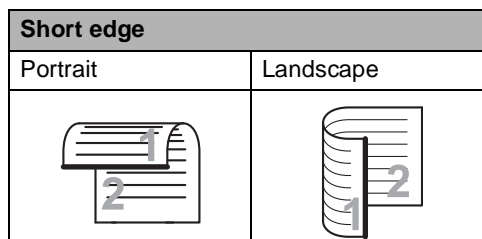



Contrast

For most documents the default setting of **Auto** will give the best results. **Auto** automatically chooses the appropriate contrast for your document.

If your document is very light or very dark, changing the contrast may improve the quality of the fax.

Select **Dark** to make the faxed document lighter.

Select **Light** to make the faxed document darker.



- 1 Do one of the following:
 - When Fax Preview is set to **Off**, press  (**Fax**).
 - When Fax Preview is set to **On**, press  (**Fax**) and **Sending Fax(es)**.
- 2 Press **Options**.
- 3 Swipe up or down, or press **▲** or **▼** to display **Contrast**.
- 4 Press **Contrast**.
- 5 Press **Auto**, **Light** or **Dark**.

NOTE

Even if you choose **Light** or **Dark**, the machine will send the fax using the **Auto** setting if you choose **Photo** as the Fax Resolution.

Changing Fax Resolution

The quality of a fax can be improved by changing the Fax Resolution. Resolution can be changed for the next fax.

- 1 Do one of the following:
 - When Fax Preview is set to **Off**, press  (**Fax**).
 - When Fax Preview is set to **On**, press  (**Fax**) and **Sending Fax(es)**.
- 2 Press **Options**.
- 3 Swipe up or down, or press **▲** or **▼** to display **Fax Resolution**.
- 4 Press **Fax Resolution**.
- 5 Press **Standard**, **Fine**, **S.Fine** or **Photo**.

NOTE

You can choose four different resolution settings.



Black & white	
Standard	Appropriate for most typed documents.
Fine	Good for small print and transmits a little slower than Standard resolution.
S.Fine	Good for small print or artwork and transmits slower than Fine resolution.
Photo	Use when the document has varying shades of grey or is a photograph. This has the slowest transmission time.

Additional sending operations

Sending a fax manually

Manual transmission

Manual transmission lets you hear the dialing, ringing and fax-receiving tones while sending a fax.

- 1 Load your document.
- 2 Do one of the following:
 - When Fax Preview is set to *Off*, press  (Fax).
 - When Fax Preview is set to *On*, press  (Fax) and *Sending Fax(es)*.
- 3 Press *Hook* and listen for a dial tone.
- 4 Dial the fax number.
- 5 When you hear the fax tones, press *Fax Start*.
 - If you are using the scanner glass, press *Send*.

Sending a fax at the end of a conversation

At the end of a conversation you can send a fax to the other party before you both hang up.



- 1 Ask the other party to wait for fax tones (beeps) and then to press the *Start* or *Send* key before hanging up.
- 2 Load your document.
- 3 Press *Fax Start*.
 - If you are using the scanner glass, press *Send*.
- 4 Replace the handset of an external telephone.

Dual access

You can dial a number and start scanning the fax into memory—even when the machine is sending from memory, receiving faxes or printing computer data. The Touchscreen will show the new job number.

The number of pages you can scan into the memory will vary depending on the data that is printed on them.

NOTE

If you get an *Out of Memory* message while scanning the first page of a fax, press  to cancel scanning. If you get an *Out of Memory* message while scanning a subsequent page, you can press *Send Now* to send the pages scanned so far, or press  to cancel the operation.

Broadcasting

Broadcasting lets you send the same fax message to more than one fax number. You can include Groups, Address Book numbers and up to 50 manually dialed numbers in the same broadcast.



You can broadcast up to 250 different numbers.

Before you begin the broadcast

Address Book numbers must be stored in the machine's memory before they can be used in a broadcast (see *Basic User's Guide: Storing Address Book numbers*).

Group numbers must also be stored in the machine's memory before they can be used in a broadcast. Group numbers include many stored Address Book numbers for easier dialing (see *Setting up Groups for Broadcasting* on page 45).

How to broadcast a fax

- 1 Load your document.
- 2 Do one of the following:
 - When Fax Preview is set to *Off*, press  (Fax).
 - When Fax Preview is set to *On*, press  (Fax) and *Sending Fax(es)*.
- 3 Press *Options*.
- 4 Swipe up or down, or press ▲ or ▼ to display *Broadcasting*.
- 5 Press *Broadcasting*.

- 6 Press **Add Number**.

NOTE

If you downloaded Internet Fax:

If you want to broadcast using an E-mail address, press , enter the E-mail address (see Basic User's Guide: *Entering Text*), and press **OK**.

- 7 You can add numbers to the broadcast in the following ways:

- Press **Add Number** and enter a number using the keyboard on the Touchscreen (see Basic User's Guide: *How to dial*). Press **OK**.
- Press **Add from Address book**. Swipe up or down, or press **▲** or **▼** to display the number you want to add to the broadcast. Select the check boxes of the numbers you want to add to the broadcast. After you select all the numbers you want, press **OK**.
- Press **Search in Address book**. Press the first letter of the name and press **OK**. Press the name, and then press the number you want to add.

- 8 After you enter all the fax numbers by repeating steps 6 and 7, press **OK**.



- 9 Press **Fax Start**. After the broadcast is finished, the machine will print a broadcast report to let you know the results.

NOTE

- If you did not use up any of the numbers for Groups, you can broadcast faxes to as many as 250 different numbers.
- The machine's available memory will vary depending on the types of jobs in the memory and the numbers used for broadcasting. If you broadcast to the maximum number available, you will not be able to use dual access and delayed fax.
- If the **Out of Memory** message appears, press  to stop the job. If more than one page has been scanned, press **Send Now** to send the portion that is in the machine's memory.

Canceling a Broadcast in progress

While broadcasting you can cancel the fax currently being sent or the whole broadcast job.

- 1 Press .
- 2 Do one of the following:
 - To cancel the entire broadcast, press **Entire Broadcast**. Go to step 3.
 - To cancel the current job, press the button that displays the number or name being dialed. Go to step 4.
 - To exit without canceling, press .
- 3 When the Touchscreen asks if you want to cancel the entire broadcast, do one of the following:
 - Press **Yes** to confirm.
 - To exit without canceling, press **No**.
- 4 Do one of the following:
 - To cancel the current job, press **Yes**.
 - To exit without canceling, press **No**.



Real Time Transmission

When you are sending a fax, the machine will scan the document into the memory before sending it. As soon as the telephone line is free, the machine will start dialing and sending.

Sometimes, you may want to send an important document immediately without waiting for memory transmission. You can turn on **Real Time TX**.

NOTE



- If the memory is full and you are sending a fax from the ADF, the machine will send the document in real time (even if **Real Time TX** is set to **Off**). If the memory is full, faxes from the scanner glass cannot be sent until you clear some of the memory.
- In **Real Time Transmission**, the automatic redial feature does not work when using the scanner glass.

- 1 Load your document.
- 2 Do one of the following:
 - When **Fax Preview** is set to **Off**, press  (**Fax**).
 - When **Fax Preview** is set to **On**, press  (**Fax**) and **Sending Fax(es)**.
- 3 Press **Options**.
- 4 Swipe up or down, or press **▲** or **▼** to display **Real Time TX**.
- 5 Press **Real Time TX**.
- 6 Press **On** (or **Off**).
- 7 Press **OK**.
- 8 Enter the fax number.
- 9 Press **Fax Start**.

Overseas Mode



If you are having difficulty sending a fax overseas due to a bad connection, then turning on **Overseas Mode** may help.

This is a temporary setting, and will only be active for your next fax.

- 1 Load your document.
- 2 Do one of the following:
 - When **Fax Preview** is set to **Off**, press  (**Fax**).
 - When **Fax Preview** is set to **On**, press  (**Fax**) and **Sending Fax(es)**.
- 3 Press **Options**.
- 4 Swipe up or down, or press **▲** or **▼** to display **Overseas Mode**.
- 5 Press **Overseas Mode**.
- 6 Press **On**.
- 7 Press **OK**.
- 8 Enter the fax number.
- 9 Press **Fax Start**.

Delayed Fax

You can store up to 50 faxes in the memory to be sent within a twenty-four hour period.

- 1 Load your document.
- 2 Do one of the following:
 - When Fax Preview is set to Off, press  (Fax).
 - When Fax Preview is set to On, press  (Fax) and Sending Fax(es).
- 3 Press Options.
- 4 Swipe up or down, or press ▲ or ▼ to display Delayed Fax.
- 5 Press Delayed Fax.
- 6 Press Delayed Fax.
- 7 Press On.
- 8 Press Set Time.
- 9 To enter the time you want the fax to be sent, do one of the following:
 - If you set 12h Clock as the format in the Clock Type setting, enter the time (in 12-hour format) using the keyboard on the Touchscreen, and then press AM or PM.
Press OK.
 - If you set 24h Clock in the Clock Type setting, enter the time (in 24-hour format) using the keyboard on the Touchscreen.
Press OK.
(For example, enter 19:45 for 7:45 PM.)



NOTE

The number of pages you can scan into the memory depends on the amount of data printed on each page.

Delayed batch transmission



Before sending the delayed faxes, your machine will help you economize by sorting all the faxes in the memory by destination and scheduled time.

All delayed faxes that are scheduled to be sent at the same time to the same fax number will be sent as one fax to save transmission time.

- 1 Press .
- 2 Press All Settings.
- 3 Swipe up or down, or press ▲ or ▼ to display Fax.
- 4 Press Fax.
- 5 Swipe up or down, or press ▲ or ▼ to display Setup Send.
- 6 Press Setup Send.
- 7 Press Batch TX.
- 8 Press On (or Off).
- 9 Press .



Checking and canceling waiting jobs

Check which jobs are still waiting in the memory to be sent. If there are no jobs, the Touchscreen will show **No Jobs Waiting**. You can cancel a fax job that is stored and waiting in the memory.

- 1 Press .
- 2 Press **All Settings**.
- 3 Swipe up or down, or press ▲ or ▼ to display **Fax**.
- 4 Press **Fax**.
- 5 Swipe up or down, or press ▲ or ▼ to display **Remaining Jobs**.
- 6 Press **Remaining Jobs**. Jobs that are waiting will appear on the Touchscreen.
- 7 Swipe up or down, or press ▲ or ▼ to scroll through the waiting jobs and press the job you want to cancel.
- 8 Press **Cancel**.
- 9 Do one of the following:
 - To cancel, press **Yes**. If you want to cancel another job repeat step 7.
 - To exit without canceling, press **No**.
- 10 When you have finished canceling jobs, press .

Setting your changes as the new default



You can save the fax settings for **Fax Resolution**, **Contrast**, **Glass Scan Size**, **Real Time TX** and **Coverpage Setup** you use most often by setting them as the default. These settings will stay until you change them again.

- 1 Do one of the following:
 - When **Fax Preview** is set to **Off**, press  (**Fax**).
 - When **Fax Preview** is set to **On**, press  (**Fax**) and **Sending Fax(es)**.
- 2 Press **Options**.
- 3 Swipe up or down, or press ▲ or ▼ to choose the setting you want to change, and then press the new option.

Repeat this step for each setting you want to change.
- 4 After changing the last setting, swipe up or down, or press ▲ or ▼ to display **Set New Default**.
- 5 Press **Set New Default**.
- 6 The Touchscreen asks you to confirm the change to the new default settings. Press **Yes** to confirm.
- 7 Press .



Restoring all fax settings to the factory settings

You can restore all the fax settings you have changed to the factory settings. These settings will stay until you change them again.

- 1 Do one of the following:
 - When Fax Preview is set to Off, press  (Fax).
 - When Fax Preview is set to On, press  (Fax) and Sending Fax(es).
- 2 Press Options.
- 3 After changing the last setting, swipe up or down, or press ▲ or ▼ to display Factory Reset.
- 4 Press Factory Reset.
- 5 The Touchscreen asks you to confirm to change back to the factory settings. Press Yes to confirm.
- 6 Press .

Saving fax options as a Shortcut

You can store all the new fax options you use frequently by saving them as a Shortcut.

- 1 Do one of the following:
 - When Fax Preview is set to Off, press  (Fax).
 - When Fax Preview is set to On, press  (Fax) and Sending Fax(es).
- 2 Enter the fax number.
- 3 Press Options.
- 4 Swipe up or down, or press ▲ or ▼ to display Fax Resolution, 2-sided Fax¹, Contrast, Real Time TX, Overseas Mode or Glass Scan Size, and then press the setting you want to change. Then press the new option you want. Repeat this step for each setting you want to change.
- 5 When you have finished choosing new options, press OK.
- 6 Press Save as Shortcut.
- 7 Confirm the displayed list of options you chose for the Shortcut, and then press OK.
- 8 Enter a name for the Shortcut using the keyboard on the Touchscreen. (To help you enter letters, see Basic User's Guide: *Entering Text*.) Press OK.
- 9 Press OK to confirm.

¹ For MFC-9340CDW

Electronic cover page

This feature will *not* work unless you have programmed your Station ID (see Quick Setup Guide).

You can automatically send a cover page with every fax. Your cover page includes your Station ID, a comment, and the name stored in the Address Book.

You can choose one of the following preset comments:

1. Comment Off
2. Please Call
3. Urgent
4. Confidential



Instead of using one of the preset comments, you can enter two personal messages of your own, up to 27 characters long (see Basic User's Guide: *Entering Text*).

(See *Composing your own comments* on page 25.)

5. (User Defined)
6. (User Defined)



Composing your own comments

You can set up two comments of your own.

- 1 Press .
- 2 Press All Settings.
- 3 Swipe up or down, or press ▲ or ▼ to display Fax.
- 4 Press Fax.
- 5 Swipe up or down, or press ▲ or ▼ to display Setup Send.
- 6 Press Setup Send.
- 7 Press Coverpage Setting.
- 8 Press Coverpage Message.
- 9 Press 5. or 6. to store your own comment.
- 10 Enter your own comment using the keyboard on the Touchscreen. Press OK.
Press  to choose numbers, letters or special characters (see Basic User's Guide: *Entering Text*).
- 11 Press .

Send a cover page for the next fax

If you want to send a cover page for the next fax, you can add the cover page.

- 1 Do one of the following:
 - When Fax Preview is set to Off, press  (Fax).
 - When Fax Preview is set to On, press  (Fax) and Sending Fax(es).
- 2 Press Options.
- 3 Swipe up or down, or press ▲ or ▼ to display Coverage Setup.
- 4 Press Coveragepage Setup.
- 5 Press Coveragepage Setup.
- 6 Press On.
- 7 Press Coveragepage Message.
- 8 Swipe up or down, or press ▲ or ▼ to choose the comment you want to use, and then press the comment.
Press .
- 9 Press OK.
- 10 Enter the fax number.
- 11 Press Fax Start.



Using a printed cover page

If you want a printed cover page you can write on, print the sample page and attach it to your fax.

- 1 Press .
- 2 Press All Settings.
- 3 Swipe up or down, or press ▲ or ▼ to display Fax.
- 4 Press Fax.
- 5 Swipe up or down, or press ▲ or ▼ to display Setup Send.
- 6 Press Setup Send.
- 7 Press Coveragepage Setting.
- 8 Press Print Sample.
- 9 Press OK.

Destination Display

When you send a fax, the machine displays the information from the Address Book or the number you dialed. You can set the machine to hide the destination information on the Touchscreen.

- 1 Press .
- 2 Press All Settings.
- 3 Swipe up or down, or press ▲ or ▼ to display Fax.
- 4 Press Fax.
- 5 Swipe up or down, or press ▲ or ▼ to display Setup Send.
- 6 Press Setup Send.
- 7 Press Destination.
- 8 Press Hidden (or Display).
- 9 Press .

Polling



Polling lets you set up your machine so other people can receive faxes from you, but they pay for the call. It also lets you call somebody else's fax machine and receive a fax from it, so you pay for the call. The polling feature needs to be set up on both machines for this to work. Not all fax machines support polling.

Polled transmit

Polled transmit lets you set up your machine to wait with a document so another fax machine can call and retrieve it.

The document will be stored and can be retrieved by any other fax machine until you delete it from the memory.

Setup for polled transmit

- 1 Load your document.
- 2 Do one of the following:
 - When Fax Preview is set to Off, press  (Fax).
 - When Fax Preview is set to On, press  (Fax) and Sending Fax(es).
- 3 Press Options.
- 4 Swipe up or down, or press ▲ or ▼ to display Polled TX.
- 5 Press Polled TX.
- 6 Press On (or Off).
- 7 Press Fax Start. If you are using the ADF, go to step 10.

- 8 If you are using the scanner glass, the Touchscreen will prompt you to choose one of the following options:
 - Press Yes to scan another page. Go to step 9.
 - Press No if you are finished scanning pages. Go to step 10.
- 9 Place the next page on the scanner glass and press OK. Repeat steps 8 and 9 for each additional page.
- 10 Your machine will automatically send the fax when it is polled. Afterwards POLLED REPORT will be printed.

NOTE

To delete the fax from memory, press



, All Settings, Fax, Remaining Jobs (see *Checking and canceling waiting jobs* on page 23).

Memory Receive Options

Memory Receive lets you receive faxes while you are away from the machine.

You can use *only one* Memory Receive option at a time:

- Fax Forwarding
- Paging
- Fax Storage
- PC-Fax Receive

(See Basic User's Guide: *PC-Fax Receive*.)

- Off

Fax Forwarding

The Fax Forwarding feature lets you automatically forward your received faxes to another machine. If you choose `Backup Print:On`, the machine will also print the fax.

- 1 Press .
- 2 Press `All Settings`.
- 3 Swipe up or down, or press ▲ or ▼ to display `Fax`.
- 4 Press `Fax`.
- 5 Swipe up or down, or press ▲ or ▼ to display `Setup Receive`.
- 6 Press `Setup Receive`.
- 7 Swipe up or down, or press ▲ or ▼ to display `Memory Receive`.
- 8 Press `Memory Receive`.

- 9 Swipe up or down, or press ▲ or ▼ to display `Fax Forward`.
- 10 Press `Fax Forward`.
- 11 Do one of the following:
 - Press `Manual` to enter the forwarding fax number (up to 20 characters) using the keyboard on the Touchscreen (see Basic User's Guide: *Entering Text*). Press `OK`.
 - Press `Address Book`.
Swipe up or down, or press ▲ or ▼ to display to scroll until you find the fax number you want your faxes to be forwarded to.
Press the fax number or E-mail address you want.

NOTE

- You can enter an E-mail address by pressing  on the Touchscreen.
- If you choose a Group number from the Address Book, the faxes will be forwarded to multiple fax numbers.

- 12 If `Fax Preview` is set to `Off`, press `Backup Print:On` or `Backup Print:Off`.

IMPORTANT

- If you choose `Backup Print:On`, the machine will also print received faxes at your machine so you will have a copy.
- When `Fax Preview` is set to `On`, the backup print feature does not work.

- 13 Press .

Paging

When Paging is chosen, the machine dials the cell phone or pager number you programmed. This activates your cell phone or pager so you will know there is a fax message in the machine's memory.

If you turn on Paging, a backup copy will automatically be printed at the machine.

- 1 Press .
- 2 Press All Settings.
- 3 Swipe up or down, or press ▲ or ▼ to display Fax.
- 4 Press Fax.
- 5 Swipe up or down, or press ▲ or ▼ to display Setup Receive.
- 6 Press Setup Receive.
- 7 Swipe up or down, or press ▲ or ▼ to display Memory Receive.
- 8 Press Memory Receive.
- 9 Swipe up or down, or press ▲ or ▼ to display Paging.
- 10 Press Paging.
- 11 Enter your cell phone or pager number followed by ## (up to 20 digits) using the keyboard on the Touchscreen.
Press OK.
Do not include the area code if it is the same as that of your machine.
For example, press **18005551234##**.

- 12 Do one of the following:
 - If you are programming a cell phone number, press OK.
 - If your pager needs a PIN, enter the PIN, press #, press Pause, enter your fax number followed by ##. Press OK. (For example, press:
1 2 3 4 5 # Pause 1 8 0 0 5 5 5 6 7
8 9 # #)
 - If you do not need a PIN, press OK.

- 13 Press .



NOTE

You cannot change a pager number, cell phone number or PIN remotely.

Fax Storage

The Fax Storage feature lets you store your received faxes in the machine's memory. You can retrieve stored fax messages from a fax machine at another location using the remote retrieval commands (see *Retrieving fax messages* on page 35).

Your machine will print a backup copy of each stored fax.

- 1 Press .
- 2 Press All Settings.
- 3 Swipe up or down, or press ▲ or ▼ to display Fax.
- 4 Press Fax.
- 5 Swipe up or down, or press ▲ or ▼ to display Setup Receive.
- 6 Press Setup Receive.
- 7 Swipe up or down, or press ▲ or ▼ to display Memory Receive.
- 8 Press Memory Receive.
- 9 Swipe up or down, or press ▲ or ▼ to display Fax Storage.
- 10 Press Fax Storage.
- 11 Press .

Changing Memory Receive Options

If received faxes are in your machine's memory when you change the Memory Receive operations, the Touchscreen will ask you one of the following questions:

If received faxes have already been printed

- Erase all faxes?
 - If you press Yes, faxes in the memory will be erased before the setting changes.
 - If you press No, faxes in the memory will not be erased and the setting will be unchanged.

If unprinted faxes are in the memory

- Print all faxes?
 - If you press Yes, faxes in the memory will be printed before the setting changes. If a backup copy has already been printed, it will not be printed again.
 - If you press No, faxes in the memory will not be printed and the setting will be unchanged.

If received faxes are left in the machine's memory when you change to PC Fax Receive from another option (Fax Forward, Paging Or Fax Storage), press USB or the name of the computer if you are on a network.

Press OK.

The Touchscreen will ask you this question:

- Send Fax to PC?
 - If you press **Yes**, faxes in the memory will be sent to your computer before the setting changes. You will be asked if you want to turn on Backup Print. (For more information, see *Basic User's Guide: PC-Fax Receive*.)
 - If you press **No**, faxes in the memory will not be erased or transferred to your computer and the setting will be unchanged.

IMPORTANT

If you choose Backup Print On, the machine will also print received faxes at your machine so you will have a copy. This is a safety feature in case there is a power failure before the fax is forwarded or a problem at the receiving machine.

Turning off Remote Fax Options

- 1 Press .
- 2 Press All Settings.
- 3 Swipe up or down, or press ▲ or ▼ to display Fax.
- 4 Press Fax.
- 5 Swipe up or down, or press ▲ or ▼ to display Setup Receive.
- 6 Press Setup Receive.
- 7 Swipe up or down, or press ▲ or ▼ to display Memory Receive.
- 8 Press Memory Receive.
- 9 Swipe up or down, or press ▲ or ▼ to display Off.
- 10 Press Off.

NOTE

The Touchscreen will give you more options if there are received faxes still in your machine's memory (see *Changing Memory Receive Options* on page 31).

- 11 Press .

Remote retrieval

You can call your machine from any touch-tone telephone or fax machine and then use the remote access code and remote commands to retrieve fax messages.

Setting a Remote Access Code

The Remote Access Code lets you access the remote retrieval features when you are away from your machine. Before you can use the remote access and retrieval features, you must set up your own code. The factory default code is the inactive code (--*).

- 1 Press .
- 2 Press All Settings.
- 3 Swipe up or down, or press ▲ or ▼ to display Fax.
- 4 Press Fax.
- 5 Swipe up or down, or press ▲ or ▼ to display Remote Access.
- 6 Press Remote Access.
- 7 Enter a three-digit code using the numbers 0 to 9, * or # using the keyboard on the Touchscreen. Press OK.
(The preset '*' cannot be changed.)

NOTE

DO NOT use the same code used for your Fax Receive Code (*51) or Telephone Answer Code (#51) (see Basic User's Guide: *Using Remote Codes*).

- 8 Press .

NOTE

You can change your code at any time. To make your code inactive, press and hold  at step 7 to restore the inactive setting --*, and then press OK.

Using your Remote Access Code

- 1 Dial your fax number from a telephone or another fax machine using touch tone.
- 2 When your machine answers, immediately enter your Remote Access Code (3 digits followed by *).
- 3 The machine signals if it has received messages:
 - 1 long beep -- Fax messages
 - No beeps -- No messages
- 4 When the machine gives two short beeps, enter a command (see *Remote fax commands* on page 34). The machine will hang up if you wait longer than 30 seconds to enter a command. The machine will beep three times if you enter an invalid command.
- 5 Press 90 to reset the machine when you are finished.
- 6 Hang up.

NOTE

- If your machine is set to Manual mode and you want to use the remote retrieval features, wait for about 100 seconds after it starts ringing, and then enter the remote access code within 30 seconds.
- This function may not be available in some countries or supported by your local telephone company.

Remote fax commands

Follow the commands in the table to access features when you are away from the machine. When you call the machine and enter your remote access code (3 digits followed by *), the system will give two short beeps and you must enter a remote command.

Remote commands		Operation details
95	Change the Fax Forwarding, Paging or Fax Storage settings	
	1 OFF	You can choose OFF after you retrieve or erase all your messages.
	2 Fax Forwarding	One long beep means the change is accepted. If you hear three short beeps, you cannot make a change because something has not been set up (for example, a Fax Forwarding or Paging number has not been registered). You can register your Fax Forwarding number by entering 4 (see <i>Changing the Fax Forwarding number</i> on page 35). After you register the number, Fax Forwarding will work.
	3 Paging	
	4 Fax Forwarding number	
6 Fax Storage		
96	Retrieve a fax	
	2 Retrieve all faxes	Enter the number of a remote fax machine to receive stored fax messages (see <i>Retrieving fax messages</i> on page 35).
	3 Erase faxes from the memory	If you hear one long beep, fax messages have been erased from the memory.
97	Check the receiving status	
	1 Fax	You can check whether your machine has received any faxes. If yes, you will hear one long beep. If no, you will hear three short beeps.
98	Change the Receive Mode	
	1 External TAD	If you hear one long beep, your change has been accepted.
	2 Fax/Tel	
	3 Fax Only	
90	Exit	Press 9 0 to stop remote retrieval. Wait for the long beep, then replace the handset.

Retrieving fax messages

You can call your machine from any touch-tone telephone or fax machine and have your fax messages sent to another machine. Before you use this feature, you have to turn on Fax Storage or Fax Preview (see *Fax Storage* on page 31 or Basic User's Guide: *Fax Preview (Black & White only)*).

- 1 Dial your fax number.
- 2 When your machine answers, enter your Remote Access Code (3 digits followed by *). If you hear one long beep, you have messages.
- 3 When you hear two short beeps, press **9 6 2**.
- 4 Wait for a long beep, and then use the dial pad to enter the number of the remote fax machine where you want your fax messages sent, followed by **##** (up to 20 digits).

NOTE

You cannot use * and # as dial numbers. However, press # if you want to create a pause.

- 5 Hang up after you hear your machine beep. Your machine will call the other fax machine, which will then print your fax messages.

Changing the Fax Forwarding number

You can change your fax forwarding number from another touch-tone telephone or fax machine.

- 1 Dial your fax number.
- 2 When your machine answers, enter your Remote Access Code (3 digits followed by *). If you hear one long beep, you have messages.
- 3 When you hear two short beeps, press **9 5 4**.
- 4 Wait for the long beep, enter the new number (up to 20 digits) of the remote fax machine you want your fax messages forwarded to using the dial pad, then enter **##**.

NOTE

You cannot use * and # as dial numbers. However, press # if you want to create a pause.



- 5 Press **9 0** to stop Remote Access when you have finished.
- 6 Hang up after you hear your machine beep.

Additional receiving operations

Printing a reduced incoming fax

If you choose **On**, the machine reduces each page of an incoming fax to fit on one page of Letter, A4, Legal or Folio sized paper.



The machine calculates the reduction ratio by using the page size of the fax and your Paper Size setting (see Basic User's Guide: *Paper settings*).

- 1 Press .
- 2 Press All Settings.
- 3 Swipe up or down, or press ▲ or ▼ to display Fax.
- 4 Press Fax.
- 5 Swipe up or down, or press ▲ or ▼ to display Setup Receive.
- 6 Press Setup Receive.
- 7 Swipe up or down, or press ▲ or ▼ to display Auto Reduction.
- 8 Press Auto Reduction.
- 9 Press On (or Off).
- 10 Press .

2-sided printing for Fax mode (MFC-9330CDW and MFC-9340CDW)

Your machine prints received faxes on both sides of the paper when **2-sided** is set to **On**.

Use Letter, Legal or Folio (8.5 in. × 13 in.) sized paper for this function [16 to 28 lb (60 to 105 g/m²)]



- 1 Press .
- 2 Press All Settings.
- 3 Swipe up or down, or press ▲ or ▼ to display Fax.
- 4 Press Fax.
- 5 Swipe up or down, or press ▲ or ▼ to display Setup Receive.
- 6 Press Setup Receive.
- 7 Swipe up or down, or press ▲ or ▼ to display 2-sided.
- 8 Press 2-sided.
- 9 Press On (or Off).
- 10 Press .

NOTE

When **2-sided** is turned on, incoming faxes will automatically be reduced to fit the size of paper in the paper tray.

Setting the Fax Receive Stamp

You can set the machine to print the received date and time at the top center of each received fax page.

- 1 Press .
- 2 Press All Settings.
- 3 Swipe up or down, or press ▲ or ▼ to display Fax.
- 4 Press Fax.
- 5 Swipe up or down, or press ▲ or ▼ to display Setup Receive.
- 6 Press Setup Receive.
- 7 Swipe up or down, or press ▲ or ▼ to display Fax Rx Stamp.
- 8 Press Fax Rx Stamp.
- 9 Press On (or Off).
- 10 Press .

NOTE

- Make sure you have set the current date and time on the machine (see Quick Setup Guide).
- *If you downloaded Internet Fax:*
The received time and date will not appear when using Internet Fax.

Receiving a fax at the end of a conversation

At the end of a conversation you can ask the other party to send you a fax before you both hang up. Make sure the ADF is empty.

- 1 Ask the other party to place the document in their machine and to press the Start or Send key.
- 2 When you hear the CNG tones (slowly repeating beeps), press Fax Start.



NOTE

- If the Touchscreen is dark for Sleep mode, touch it to display Fax Start.
- If the machine is in Automatic Redial, wait until it is finished and try again.

- 3 Press Receive to receive a fax.
- 4 Replace the external handset.



Setting the Print Density

You can adjust the Print Density setting to make your printed pages darker or lighter.

- 1 Press .
- 2 Press All Settings.
- 3 Swipe up or down, or press ▲ or ▼ to display Fax.
- 4 Press Fax.
- 5 Swipe up or down, or press ▲ or ▼ to display Setup Receive.
- 6 Press Setup Receive.
- 7 Swipe up or down, or press ▲ or ▼ to display Print Density.
- 8 Press Print Density.
- 9 Press a density level on the Touchscreen.
- 10 Press .

Printing a fax from the memory

If you choose Paging or Fax Storage, you can still print a fax from the memory when you are at your machine (see *Fax Storage* on page 31).

- 1 Press .
- 2 Press All Settings.
- 3 Swipe up or down, or press ▲ or ▼ to display Fax.
- 4 Press Fax.
- 5 Press ▲ or ▼ to display Print Fax.
- 6 Press Print Fax.
- 7 Press OK.
- 8 Press .

Receiving faxes into memory when the paper tray is empty

As soon as the paper tray becomes empty during fax reception, the Touchscreen shows **No Paper** and begins receiving faxes into the machine's memory. Load paper in the paper tray (see Basic User's Guide: *Loading paper and print media*).



Incoming faxes will continue to be stored in the memory until the memory becomes full or paper is loaded in the paper tray. When the memory is full the machine will stop automatically answering calls. To print the faxes, load fresh paper in the tray.

Polling

Polling lets you set up your machine so other people can receive faxes from you, but they pay for the call. It also lets you call somebody else's fax machine and receive a fax from it, so you pay for the call. The polling feature needs to be set up on both machines for this to work. Not all fax machines support polling.



Polling receive

Polling receive lets you call another fax machine to receive a fax.

- 1 Do one of the following:
 - When Fax Preview is set to *Off*, press  (Fax).
 - When Fax Preview is set to *On*, press  (Fax) and Sending Fax(es).
- 2 Press *Options*.
- 3 Swipe up or down, or press ▲ or ▼ to display *Polling RX*.
- 4 Press *Polling RX*.
- 5 Press *On*.
- 6 Enter the fax number you are polling using *Address Book* or the dial pad on the *Touchpanel*.
- 7 Press *Fax Start*.

Sequential polling

Sequential polling lets you request documents from several fax machines in one operation. Afterwards, a *Sequential Polling Report* will be printed.

- 1 Do one of the following:
 - When Fax Preview is set to *Off*, press  (Fax).
 - When Fax Preview is set to *On*, press  (Fax) and Sending Fax(es).
- 2 Press *Options*.
- 3 Swipe up or down, or press ▲ or ▼ to display *Polling RX*.
- 4 Press *Polling RX*.
- 5 Press *On*.
- 6 Press *Options*.
- 7 Swipe up or down, or press ▲ or ▼ to display *Broadcasting*.
- 8 Press *Broadcasting*.
- 9 Press *Add Number*.
- 10 You can add numbers to the broadcast in the following ways:
 - Press *Add Number* and enter a number using the keyboard on the *Touchscreen*. Press *OK*.
 - Press *Add from Address book*. Swipe up or down, or press ▲ or ▼ to display the numbers you want to add to the broadcast. Press the check boxes to add a check mark beside all the numbers you want, and then press *OK*.

- Press **Search** in **Address book**. Enter the name and press **OK**. Press the name, and then number you want to add.

- 11 Repeat steps 9 and 10 for each number you want. Press **OK**.
- 12 Press **Fax Start**. The machine polls each number or Group number in turn for a document.

Stop Polling

To cancel the polling process, press **X** while the machine is dialing.

To cancel all sequential polling receive jobs, see *Canceling a Sequential Polling Job* on page 41.

Canceling a Sequential Polling Job

- 1 Press **X**.
- 2 Do one of the following:
 - To cancel the entire sequential polling job, press **Entire Seq. Poll**. Go to step 3.
 - To cancel the current job, press the button that displays the number or name being dialed. Go to step 4.
 - To exit without canceling, press **X**.
- 3 When the Touchscreen asks if you want to cancel the entire sequential polling job, do one of the following:
 - Press **Yes** to confirm.
 - To exit without canceling, press **No**.
- 4 Do one of the following:
 - To cancel the current job, press **Yes**.
 - To exit without canceling, press **No**.



5

Dialing and storing numbers

Telephone line services

Tone or Pulse (Canada only)

If you have a Pulse dialing service, but must send Tone signals (for example, for telephone banking), follow these steps. If you have Touch Tone service, you will not need this feature to send tone signals.

- 1 Do one of the following:
 - When Fax Preview is set to *Off*, press  (Fax).
 - When Fax Preview is set to *On*, press  (Fax) and Sending Fax(es).
- 2 Press *Hook*.
- 3 Press *#* on the machine's Touchpanel. Any digits dialed after this will send tone signals.

When you are finished with the call, the machine will return to the Pulse dialing service.

For Fax/Tel mode only

When the machine is in Fax/Tel mode, it will use the F/T Ring Time (pseudo/double-ringing) to alert you to pick up a voice call.

If you are at the machine, lift the external telephone's handset, and then press *Pickup* to answer.

If you are at an extension telephone, lift the handset during the F/T Ring Time and then press *#51* between the pseudo/double rings. If no one is on the line, or if someone wants to send you a fax, send the call back to the machine by pressing **51*.

Special line considerations

Roll over telephone lines

A roll over telephone system is a group of two or more separate telephone lines that pass incoming calls to each other if they are busy. The calls are usually passed down or "rolled over" to the next available telephone line in a preset order.

Your machine can work in a roll over system as long as it is the last number in the sequence, so the call cannot roll away. Do not place the machine on any of the other numbers; when the other lines are busy and a second fax call is received, the fax call would be transferred to a line that does not have a fax machine. **Your machine will work best on a dedicated line.**

Two-line telephone system

A two-line telephone system is nothing more than two separate telephone numbers on the same wall outlet. The two telephone numbers can be on separate jacks (RJ11) or combined into one jack (RJ14). Your machine must be plugged into an RJ11 jack. RJ11 and RJ14 jacks may be equal in size and appearance and both may contain four wires (black, red, green, yellow). To test the type of jack, plug in a two-line telephone and see if it can access both lines. If it can, you must separate the line for your machine.

Converting telephone wall outlets

There are three ways to convert to an RJ11 jack. The first two ways may require assistance from the telephone company. You can change the wall outlets from one RJ14 jack to two RJ11 jacks. Or, you can have an RJ11 wall outlet installed and slave or jump one of the telephone numbers to it.

The third way is the easiest: Buy a triplex adapter. You can plug a triplex adapter into an RJ14 outlet. It separates the wires into two separate RJ11 jacks (Line 1, Line 2) and a third RJ14 jack (Lines 1 and 2). If your machine is on Line 1, plug the machine into L1 of the triplex adapter. If your machine is on Line 2, plug it into L2 of the triplex adapter.

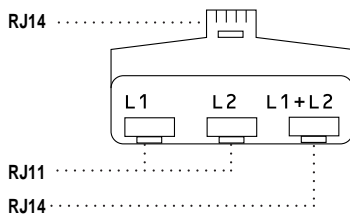

Installing machine, external two-line TAD and two-line telephone

When you are installing an external two-line telephone answering device (TAD) and a two-line telephone, your machine must be isolated on one line at both the wall jack and at the TAD. The most common connection is to place the machine on Line 2, which is explained in the following steps. The back of the two-line TAD must have two telephone jacks: one labeled L1 or L1/L2, and the other labeled L2. You will need at least three telephone line cords, the one that came with your machine and two for your external two-line TAD. You will need a fourth line cord if you add a two-line telephone.

- 1 Place the two-line TAD and the two-line telephone next to your machine.
- 2 Plug one end of the telephone line cord for your machine into the L2 jack of the triplex adapter. Plug the other end into the LINE jack on the back of the machine.
- 3 Plug one end of the first telephone line cord for your TAD into the L1 jack of the triplex adapter. Plug the other end into the L1 or L1/L2 jack of the two-line TAD.
- 4 Plug one end of the second telephone line cord for your TAD into the L2 jack of the two-line TAD. Plug the other end into the EXT. jack on the left side of the machine.

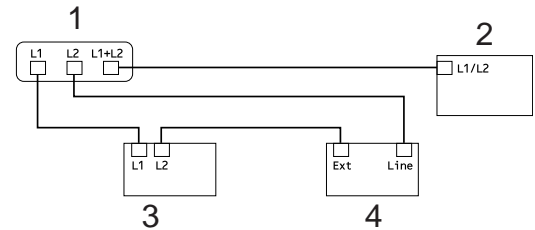

- 1 Triplex Adapter
- 2 Two Line Telephone
- 3 External Two Line TAD
- 4 Machine

You can keep two-line telephones on other wall outlets as always. There are two ways to add a two-line telephone to the machine's wall outlet. You can plug the telephone line cord from the two-line telephone into the L1+L2 jack of the triplex adapter. Or, you can plug the two-line telephone into the TEL jack of the two-line TAD.

Additional dialing operations

Dialing access codes and credit card numbers

Sometimes you may want to choose from several long-distance carriers when you send a fax. Rates may vary depending on the time and destination. To take advantage of low rates, you can store the access codes of long-distance carriers and credit card numbers as Address Book numbers. You can store these long dialing sequences by dividing them and setting them up as separate Address Book numbers in any combination. You can even include manual dialing using the dial pad (see Basic User's Guide: *Storing Numbers*).

For example, you might have stored '555' on Address Book: Brother 1 and '7000' on Address Book: Brother 2. You can use them both to dial '555-7000' if you press the following:

- 1 Press  (Fax).
- 2 Press Address Book.
- 3 Swipe up or down, or press ▲ or ▼ to display the number of Brother 1.
- 4 Press the number.
- 5 Press Apply.
- 6 Press Address Book.
- 7 Swipe up or down, or press ▲ or ▼ to display the number of Brother 2.
- 8 Press the number.
- 9 Press Apply.
- 10 Press Fax Start. You will dial '555-7000'.

To temporarily change a number, you can substitute part of the number by pressing it on the dial pad. For example, to change the number to '555-7001', you could enter the number (Brother 1: 555) using Address Book, press **Apply** and then press **7001** on the dial pad.



NOTE

If you must wait for another dial tone or signal at any point in the dialing sequence, create a pause in the number by pressing **Pause**. Each key press adds a 3.5-second delay. You can press **Pause** as many times as needed to increase the length of the pause.

Additional ways to store numbers

Storing Address Book numbers from Outgoing Calls

You can store Address Book numbers from the Outgoing Call history.

- 1 Press  (Fax).
- 2 Press Call History.
- 3 Press Outgoing Call.
- 4 Press the number.
- 5 Press Edit.
- 6 Press Add to Address Book.
- 7 Press Name.
- 8 Enter the name (up to 15 characters) using the keyboard on the Touchscreen. (To help you enter letters, see Basic User's Guide: *Entering Text*.) Press OK.
- 9 Press OK to confirm the fax or telephone number.
- 10 Press .

Setting up Groups for Broadcasting

A Group, which can be stored in the Address Book, allows you to send the same fax message to many fax numbers by pressing Fax, Address Book, Group name, Apply and Fax Start.

First, you must store each fax number in Address Book (see Basic User's Guide: *Storing Address Book numbers*). Then you can include them as numbers in the Group. Each Group uses up an Address Book number. You can store up to 20 Groups, or you can assign up to 199 numbers to a large Group.

(See *Broadcasting* on page 19.)

- 1 Press  (Fax).
- 2 Press Address Book.
- 3 Press Edit.
- 4 Press Setup Groups.
- 5 Press Name.
- 6 Enter the Group name (up to 15 characters) using the keyboard on the Touchscreen. Press OK.
- 7 Press Add/Delete.
- 8 Add Address Book numbers to the Group by pressing them to display a red checkmark. Press OK.
- 9 Read and confirm the displayed list of names and numbers you have chosen, and then press OK to save your Group.

- 10 Do one of the following:
- To store another Group for broadcasting, repeat steps 3 - 9.
 - To finish storing Groups for broadcasting, press .

NOTE

You can print a list of all the Address Book numbers (see *Reports* on page 49).

Changing a Group name

- 1 Press  (Fax).
- 2 Press Address Book.
- 3 Press Edit.
- 4 Press Change.
- 5 Swipe up or down, or press ▲ or ▼ to display the Group you want.
- 6 Press the Group name.
- 7 Press the Name.
- 8 Enter the new Group name (up to 15 characters) using the keyboard on the Touchscreen.
Press OK.



NOTE

How to change the stored name:



To change a character, press ◀ or ▶ to position the cursor to highlight the incorrect character, and then press . Enter the new character (see Basic User's Guide: *Entering Text*).

- 9 Press OK.
- 10 Press .

Deleting a Group

- 1 Press  (Fax).
- 2 Press Address Book.
- 3 Press Edit.
- 4 Press Delete.
- 5 Swipe up or down, or press ▲ or ▼ to display the Group you want.
- 6 Press the Group name.
Press OK.
- 7 When the Touchscreen asks Erase this data?, press Yes.
- 8 Press .

Adding or deleting Group members

- 1 Press  (Fax).
- 2 Press Address Book.
- 3 Press Edit.
- 4 Press Change.
- 5 Swipe up or down, or press ▲ or ▼ to display the Group you want.
- 6 Press the Group name.
- 7 Swipe up or down, or press ▲ or ▼ to display Add/Delete.
- 8 Press Add/Delete.
- 9 Swipe up or down, or press ▲ or ▼ to display the number you want to add or delete.
- 10 Do the following for each number you want to change:
 - To add a number to the Group, press the check box of the number to add a check mark.
 - To delete a number from the Group, press the check box of the number to remove the check mark.
- 11 Press OK.
- 12 Press OK.
- 13 Press .

6

Printing reports

Fax reports

Press  on the Touchscreen to set up the Transmission Verification Report and the Journal Period.

Transmission Verification Report

You can use the Transmission Verification Report as proof that you sent a fax (see Basic User's Guide: *Transmission Verification Report*).

Fax Journal (Activity Report)

You can set the machine to print a journal at specific intervals (every 50 faxes, 6, 12 or 24 hours, 2 or 7 days). The factory setting is `Every 50 Faxes`.

If you set the interval to `Off`, you can still print the report by following the steps in *How to print a report* on page 50.

- 1 Press .
- 2 Press `All Settings`.
- 3 Swipe up or down, or press ▲ or ▼ to display `Fax`.
- 4 Press `Fax`.
- 5 Swipe up or down, or press ▲ or ▼ to display `Report Setting`.
- 6 Press `Report Setting`.
- 7 Press `Journal Period`.
- 8 Press `Journal Period`.

- 9 Swipe up or down, or press ▲ or ▼ to choose an interval.
If you choose `Every 50 Faxes`, go to step 10.

- 6, 12, 24 hours, 2 or 7 days

The machine will print the report at the chosen time and then erase all jobs from its memory.

If the machine's memory becomes full with 200 jobs before the time you chose has passed, the machine will print the Journal early and then erase all jobs from the memory. If you want an extra report before it is due to print, you can print it without erasing the jobs from the memory.

- `Every 50 Faxes`

The machine will print the Journal when the machine has stored 50 jobs.

- 10 To enter the time to start printing, do one of the following:

- If you have set 12h in the `Date & Time` setting, press `Time` and enter the time (in 12-hour format) using the keyboard on the Touchscreen, and then press `AM` or `PM`.
Press `OK`.

- If you have set 24h in the `Date & Time` setting, press `Time` and enter the time (in 24-hour format) using the keyboard on the Touchscreen.
Press `OK`.
(For example: enter 19:45 for 7:45 PM.)

- 11 If you chose `Every 7 Days`, press `Day`.

- 12 Swipe up or down, or press ▲ or ▼ display Every Monday, Every Tuesday, Every Wednesday, Every Thursday, Every Friday, Every Saturday or Every Sunday, and then press the first day of the 7-day countdown.
- 13 Press .

Reports

The following reports are available:

- 1 **Transmission**
Displays the Transmission Verification Report for your last outgoing 200 faxes and prints the last report.
- 2 **Address Book**
Prints a list of names and numbers stored in the Address Book memory, in alphabetical order.
- 3 **Fax Journal**
Prints a list of information about your last 200 incoming and outgoing faxes. (TX: transmit.) (RX: receive.)
- 4 **User Settings**
Prints a list of your current settings.
- 5 **Network Configuration**
Prints a list of your current network settings.
- 6 **Drum Dot Print**
Prints the Drum Dot Check Sheet to troubleshoot a dotted print problem.
- 7 **WLAN Report**
Prints the result of wireless LAN connectivity diagnosis.

How to print a report

- 1 Press .
- 2 Press All Settings.
- 3 Swipe up or down, or press ▲ or ▼ to display Print Reports.
- 4 Press Print Reports.
- 5 Swipe up or down, or press ▲ or ▼ to display the report you want.
- 6 Press the report name.
- 7 Do one of the following:
 - If you chose Transmission, go to step 8.
 - For other reports, go to step 9.
- 8 Do one of the following:
 - To view the Transmission Verification Report, press View on LCD.
 - To print the Transmission Verification Report, press Print Report.
- 9 Press OK.

Copy settings

You can change the copy settings for the next copy.

These settings are temporary. The machine returns to its default settings one minute after copying.

Press **Copy** and then press **Options**. Swipe up or down, or press ▲ or ▼ to scroll through the copy settings. When the setting you want is displayed, press it and choose your preferred option.

When you have finished changing settings, press **Color Start** or **Black Start**.

Stop copying

To stop copying, press .

Improving copy quality

You can choose from a range of quality settings. The factory setting is *Auto*.

- **Auto**

Auto is the recommended mode for ordinary printouts. Appropriate for documents that contain both text and photographs.

- **Text**

Appropriate for documents containing only text.

- **Photo**

Appropriate for copying photographs.



- **Receipt**

Appropriate for copying receipts.

- 1 Load your document.
- 2 Press  (**Copy**).
- 3 Enter the number of copies.
- 4 Press **Options**.
- 5 Swipe up or down, or press ▲ or ▼ to display **Quality**.
- 6 Press **Quality**.
- 7 Press **Auto**, **Text**, **Photo** or **Receipt**.
- 8 If you do not want to change additional settings, press **OK**.
- 9 Press **Color Start** or **Black Start**.

Enlarging or reducing copies

To enlarge or reduce the next copy follow these steps:

- 1 Load your document.
- 2 Press  (Copy).
- 3 Enter the number of copies you want.
- 4 Press Options.
- 5 Swipe up or down, or press ▲ or ▼ to display Enlarge/Reduce.
- 6 Press Enlarge/Reduce.
- 7 Press 100%, Enlarge, Reduce or Custom(25-400%).
- 8 Do one of the following:
 - If you chose Enlarge, press the enlargement or ratio you want.
 - If you chose Reduce, swipe up or down, or press ▲ or ▼ to display the reduction ratio you want and press it.
 - If you chose Custom(25-400%), press  to erase the displayed percentage, or press ◀ to move the cursor, and then enter an enlargement or reduction ratio from 25% to 400% in 1% increments.
Press OK.
 - If you chose 100%, go to step 9.

100%*
200%
141% A5⇒A4
104% EXE⇒LTR
97% LTR⇒A4
94% A4⇒LTR
91% Full Page
85% LTR⇒EXE
83% LGL⇒A4
78% LGL⇒LTR
70% A4⇒A5
50%
Custom(25-400%) ¹

* The factory setting is shown in Bold with an asterisk.

¹ Custom(25-400%) allows you to enter a ratio from 25% to 400% in 1% increments.

- 9 If you do not want to change additional settings, press OK.
- 10 Press Color Start or Black Start.

NOTE

Page Layout is *not* available with Enlarge/Reduce.

2-sided Copying (MFC-9330CDW and MFC-9340CDW)

You must choose a 2-sided copy layout from the following options before you can start 2-sided copying. The layout of your document determines which 2-sided copy layout you should choose.

MFC-9330CDW

Portrait

■ 1-sided-2-sided Long Edge Flip

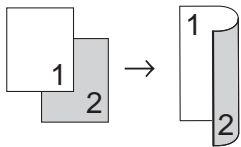

■ 1-sided-2-sided Short Edge Flip

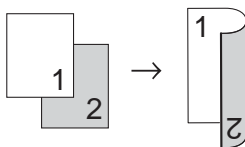

Landscape

■ 1-sided-2-sided Long Edge Flip

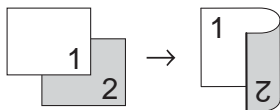

■ 1-sided-2-sided Short Edge Flip

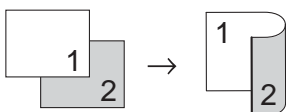

MFC-9340CDW

If you want to use the automatic 2-sided copy feature, load your document in the ADF.

Portrait

■ 2-sided-2-sided

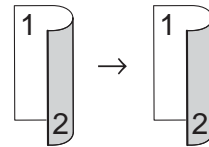

■ 1-sided-2-sided Long Edge Flip

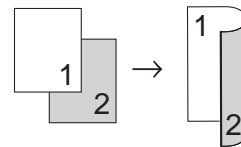

■ 2-sided-1-sided Long Edge Flip

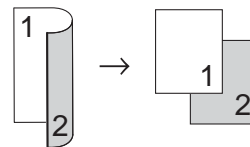

■ 1-sided-2-sided Short Edge Flip

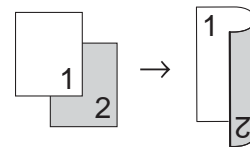

■ 2-sided-1-sided Short Edge Flip

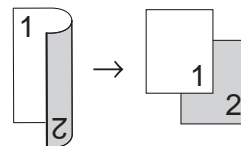

Landscape

■ 2-sided-2-sided

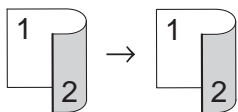

■ 1-sided-2-sided Long Edge Flip

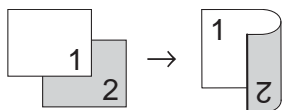

■ 2-sided-1-sided Long Edge Flip

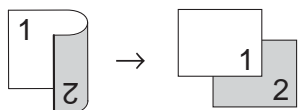

■ 1-sided-2-sided Short Edge Flip

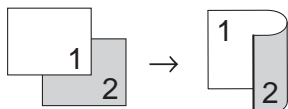

■ 2-sided-1-sided Short Edge Flip

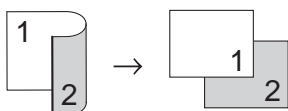

- 1 Load your document.
- 2 Press  (Copy).
- 3 Enter the number of copies.
- 4 Press Options.
- 5 Swipe up or down, or press ▲ or ▼ to display 2-sided Copy.
- 6 Press 2-sided Copy.

- 7 Swipe up or down, or press ▲ or ▼ to display the following layout options:
Off,
2-sided⇒2-sided¹,
1-sided⇒2-sided Long Edge Flip,
2-sided⇒1-sided Long Edge Flip¹,
1-sided⇒2-sided Short Edge Flip,
2-sided⇒1-sided Short Edge Flip¹

¹ For MFC-9340CDW

- 8 Press the option you want.
- 9 If you do not want to change additional settings, press OK.
- 10 Press **Color Start** or **Black Start** to scan the page.
If you placed the document in the ADF, the machine scans the pages and starts printing.

If you are using the scanner glass, go to step 11.

- 11 After the machine scans the page, press **Scan** to scan the next page.
- 12 Place the next page on the scanner glass.
- 13 Press OK.
Repeat steps 11 and 13 for each page of the layout.
- 14 After scanning all the pages, press **Complete** in step 11 to finish.

Adjusting Density and Contrast

Density

Adjust the copy density to make copies darker or lighter.

- 1 Load your document.
- 2 Press  (Copy).
- 3 Enter the number of copies.
- 4 Press Options.
- 5 Swipe up or down, or press ▲ or ▼ to display Density.
- 6 Press Density.
- 7 Press a level of density, from Light to Dark.
- 8 If you do not want to change additional settings, press OK.
- 9 Press **Color Start** or **Black Start**.

Contrast

Adjust the contrast to help an image look sharper and more vivid.

- 1 Load your document.
- 2 Press  (Copy).
- 3 Enter the number of copies.
- 4 Press Options.
- 5 Swipe up or down, or press ▲ or ▼ to display Contrast.
- 6 Press Contrast.
- 7 Press a level of contrast.
- 8 If you do not want to change additional settings, press OK.
- 9 Press **Color Start** or **Black Start**.

Sorting copies

You can sort multiple copies. Pages will be sorted in the order 1 2 3, 1 2 3, 1 2 3, and so on.

- 1 Load your document.
 - 2 Press  (Copy).
 - 3 Enter the number of copies.
 - 4 Press **Options**.
 - 5 Swipe up or down, or press ▲ or ▼ to display **Stack/Sort**.
 - 6 Press **Stack/Sort**.
 - 7 Press **Sort**.
 - 8 Read and confirm the displayed list of settings you have chosen. If you do not want to change additional settings, press **OK**.
 - 9 Press **Color Start** or **Black Start** to scan the page.
If you placed the document in the ADF, the machine scans the pages and starts printing.
- If you are using the scanner glass, go to step 10.**
- 10 After the machine scans the page, press **Scan** to scan the next page.
 - 11 Place the next page on the scanner glass.
 - 12 Press **OK**.
Repeat steps 10 and 12 for each page of the layout.
 - 13 After scanning all the pages, press **Complete** in step 10 to finish.

Making N in 1 copies (page layout)

You can reduce the amount of paper used when copying by using the N in 1 copy feature. This allows you to copy two or four pages onto one page. If you want to copy both sides of an ID card onto one page, see *2 in 1 ID Copy* on page 58.

IMPORTANT

- Make sure the paper size is set to **Letter**, **A4**, **Legal** or **Folio**.
- You cannot use the **Enlarge/Reduce** setting with the N in 1 feature.
- (P) means **Portrait** and (L) means **Landscape**.

- 1 Load your document.
- 2 Press  (Copy).
- 3 Enter the number of copies.
- 4 Press **Options**.
- 5 Swipe up or down, or press ▲ or ▼ to display **Page Layout**.
- 6 Press **Page Layout**.
- 7 Swipe up or down, or press ▲ or ▼ to display **Off(1in1)**, **2in1(P)**, **2in1(L)**, **2in1(ID)**¹, **4in1(P)** or **4in1(L)**.
¹ For information about 2in1(ID), see *2 in 1 ID Copy* on page 58.
- 8 Press the option you want.
- 9 If you do not want to change additional settings, press **OK**.
- 10 Press **Color Start** or **Black Start** to scan the page.
If you placed the document in the ADF, the machine scans the pages and starts printing.

If you are using the scanner glass, go to step 11.

- 11 After the machine scans the page, press Scan to scan the next page.
- 12 Place the next page on the scanner glass.
- 13 Press OK. Repeat steps 11 and 13 for each page of the layout.
- 14 After scanning all the pages, press Complete in step 11 to finish.

If you are copying from the ADF:

Place your document *face up* in the direction shown in the illustration:

■ 2in1(P)



■ 2in1(L)

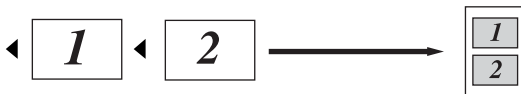

■ 4in1(P)



■ 4in1(L)



If you are copying from the scanner glass:

Place your document *face down* in the direction shown in the illustration:

■ 2in1(P)

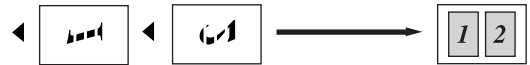

■ 2in1(L)

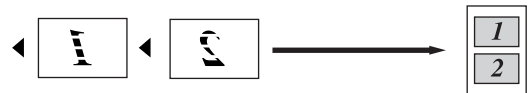

■ 4in1(P)



■ 4in1(L)



2 in 1 ID Copy

You can copy both sides of your identification card onto one page, keeping the original card size.

NOTE

You can copy an identification card to the extent permitted under applicable laws (see *Product Safety Guide: Legal limitations for copying (MFC and DCP only)*)

- 1 Place your identification card *face down* near the left corner of the scanner glass.

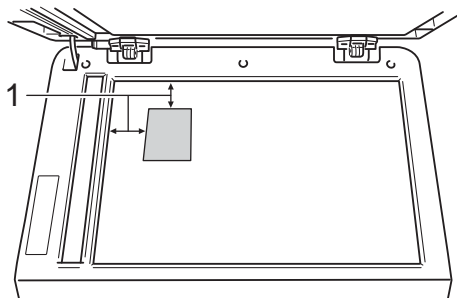

1 0.16 in. (4 mm) or greater (top, left)

- Even if a document is placed on the ADF, the machine scans the data from the scanner glass when in this mode.

- 2 Press  (Copy).
- 3 Enter the number of copies.
- 4 Press **Options**.
- 5 Swipe up or down, or press **▲** or **▼** to display **Page Layout**.
- 6 Press **Page Layout**.
- 7 Swipe up or down, or press **▲** or **▼** to display **2in1 (ID)**.
- 8 Press **2in1 (ID)**.

- 9 Read and confirm the displayed list of settings you have chosen, and then press **OK**.
- 10 Press **Color Start** or **Black Start**. The machine starts scanning one side of the identification card.
- 11 After the machine has scanned one side, press **Scan**. Turn over the identification card and place it near the left corner of the scanner glass, then press **OK** to scan the other side.



NOTE

When 2 in 1 ID Copy is chosen, the machine sets the quality to **Photo** and the contrast to **+2**.

- 12 Press .

Adjusting the Color Saturation

You can change the default setting for color saturation.

- 1 Load your document.
- 2 Press  (Copy).
- 3 Enter the number of copies.
- 4 Press Options.
- 5 Swipe up or down, or press ▲ or ▼ to display Color Adjust.
- 6 Press Color Adjust.
- 7 Press Red, Green or Blue.
- 8 Press a level of color saturation.
- 9 Repeat steps 7 and 8 if you want to adjust the next color. After adjusting the color settings, press .
- 10 If you do not want to change additional settings, press OK.
- 11 Press Color Start.

Making 2-sided N in 1 copies (MFC-9340CDW)

When you make 2-sided N in 1 copies from a 2-sided document, you must choose a layout option in 2-sided Copy Page Layout. You will be able to access 2-sided Copy Page Layout after selecting 2-sided⇒2-sided for 2-sided Copy and any N in 1 layout for Page Layout.

You must select an appropriate option in the table.

Bound Edge of the Document	Edge of the copies to be bound	Option you must choose
Long Edge	Long Edge	LongEdge⇒LongEdge
	Short Edge	LongEdge⇒ShortEdge
Short Edge	Long Edge	ShortEdge⇒LongEdge
	Short Edge	ShortEdge⇒ShortEdge

IMPORTANT

- Load your document in the ADF to use the 2-sided Copy Page Layout feature.
- The 2-sided Copy Page Layout feature does not work when you choose 2in1(ID) for Page Layout.

- 1 Load your document in the ADF.
- 2 Press  (Copy).
- 3 Enter the number of copies.
- 4 Press Options.
- 5 Select 2-sided⇒2-sided in 2-sided Copy (see 2-sided Copying (MFC-9330CDW and MFC-9340CDW) on page 53).

- 6 Select 2in1(P), 2in1(L), 4in1(P) or 4in1(L) in Page Layout (see *Making N in 1 copies (page layout)* on page 56).
- 7 Swipe up or down, or press ▲ or ▼ to display 2-sided Copy Page Layout.
- 8 Press 2-sided Copy Page Layout.
- 9 Press LongEdge⇒LongEdge, LongEdge⇒ShortEdge, ShortEdge⇒LongEdge or ShortEdge⇒ShortEdge.
- 10 If you do not want to change additional settings, press OK.
- 11 Press Color Start or Black Start.

Removing Background Color

Remove Background Color removes the background color of the document when copying. Using this function will make the copy clearer to read and may save toner.



NOTE

This function is for use only when making color copies.

- 1 Load your document.
- 2 Press  (Copy).
- 3 Enter the number of copies.
- 4 Press Options.
- 5 Swipe up or down, or press ▲ or ▼ to display Advanced Settings.
- 6 Press Advanced Settings.
- 7 Press Remove Background Color.
- 8 Press Low, Medium or High.
- 9 If you do not want to change additional settings, press OK.
- 10 Press Color Start.

Saving copy options as a Shortcut

You can store the copy options you use most often by saving them as a Shortcut.

- 1 Press  (Copy).
- 2 Press Options.
- 3 Swipe up or down, or press ▲ or ▼ to display Quality, Enlarge/Reduce, 2-sided Copy¹, Density, Contrast, Stack/Sort, Page Layout, Color Adjust, 2-sided Copy Page Layout or Remove Background Color, and then press the setting you want.
- 4 Swipe up or down, or press ▲ or ▼ to display the available options, and then press your new option. Repeat steps 3 and 4 for each setting you want to change.
- 5 When you have finished choosing new options, press Save as Shortcut.
- 6 Read and confirm the displayed list of options you have chosen for the Shortcut, and then press OK.
- 7 Enter a name for the Shortcut using the keyboard on the Touchscreen. (To help you enter letters: see Basic User's Guide: *Entering Text*.) Press OK.
- 8 Press OK to save your Shortcut.
- 9 Press .

¹ For MFC-9330CDW and MFC-9340CDW

Saving paper

You can use the Paper Save preset to reduce the amount of paper consumed for copies. Paper Save uses the 4 in 1 layout and 2-sided¹ copy options.

¹ For MFC-9330CDW and MFC-9340CDW

- 1 Load your document.
- 2 Press  (Copy).
- 3 Swipe left or right to display Paper Save.
- 4 Press Paper Save.
- 5 Enter the number of copies.
- 6 Do one of the following:
 - To change more settings, go to step 7.
 - When you have finished changing settings, go to step 10.
- 7 Press Options.
- 8 Swipe up or down, or press ▲ or ▼ to display the available settings, and then press the setting you want.
- 9 Swipe up or down, or press ▲ or ▼ to display the available options, and then press your new option. Repeat steps 8 and 9 for each setting you want. When you have finished changing settings, press OK.
- 10 Press Color Start or Black Start.

A

Routine maintenance

Cleaning and checking the machine

Clean the outside and inside of the machine regularly with a dry, lint-free cloth. When you replace the toner cartridge or the drum unit, make sure you clean the inside of the machine. If printed pages are stained with toner, clean the inside of the machine with a dry, lint-free cloth.

WARNING



- DO NOT put a toner cartridge or a toner cartridge and drum unit assembly into a fire. It could explode, resulting in injuries.
- DO NOT use flammable substances, any type of spray, or an organic solvent/liquid containing alcohol or ammonia to clean the inside or outside of the product. Doing so could cause a fire or electrical shock. Instead, use only a dry, lint-free cloth.

(See Product Safety Guide: *To use the product safely.*)



IMPORTANT

- Use neutral detergents. Cleaning with volatile liquids such as thinner or benzene will damage the surface of the machine.
- DO NOT use cleaning materials that contain ammonia.
- DO NOT use isopropyl alcohol to remove dirt from the control panel. It may crack the panel.

Cleaning the outside of the machine

IMPORTANT

DO NOT use any type of liquid cleaners (including ethanol).

Clean the Touchscreen as follows:

- 1 Press and hold down  to turn off the machine.
- 2 Clean the Touchscreen with a *dry*, soft lint-free cloth.

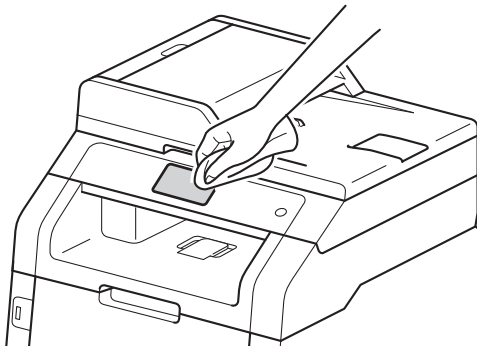

- 3 Press  to turn on the machine.

Clean the outside of the machine as follows:

- 1 Press and hold down  to turn off the machine.

- 2 Wipe the outside of the machine with a *dry*, lint-free cloth to remove dust.

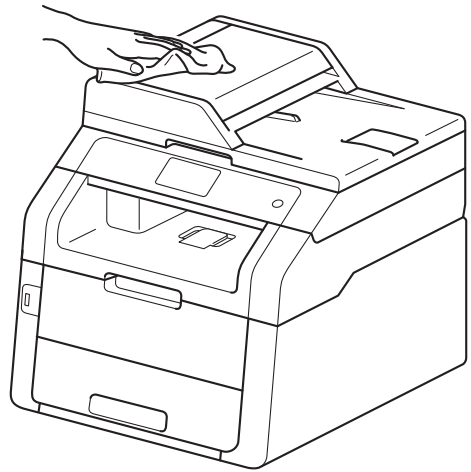

- 3 Pull the paper tray completely out of the machine.

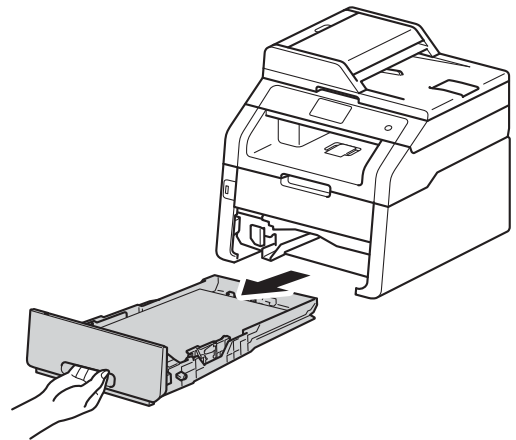

- 4 If paper is loaded in the paper tray, remove it.
- 5 Remove anything that is stuck inside the paper tray.

- 6 Wipe the inside and the outside of the paper tray with a *dry*, lint-free cloth to remove dust.

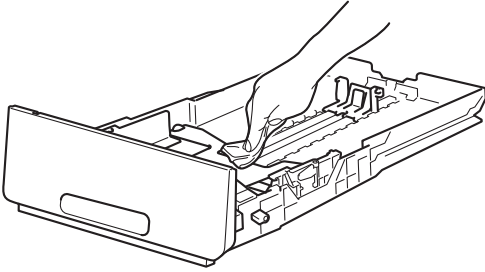

- 7 Re-load the paper and put the paper tray firmly back in the machine.

- 8 Press  to turn on the machine.

Cleaning the LED heads

If there is a problem with the print quality, such as light or faded colors or white streaks or bands down the page, clean the LED heads.

IMPORTANT

DO NOT touch the windows of the LED heads with your fingers.

- 1 Press and hold down  to turn off the machine.
- 2 Open the top cover until it locks in the open position.

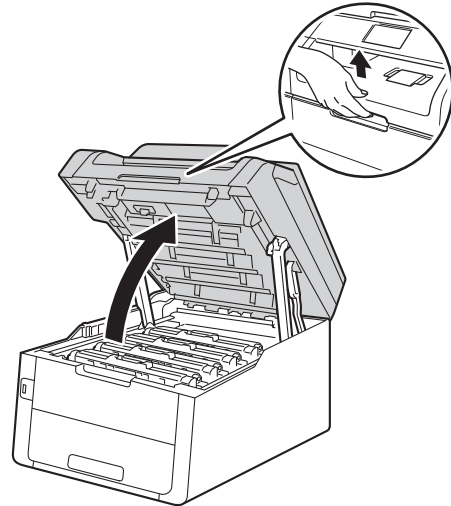

- 3 Wipe the windows of all four LED heads (1) with a *dry*, lint-free cloth. Be careful not to touch the windows of the LED heads (1) with your fingers.

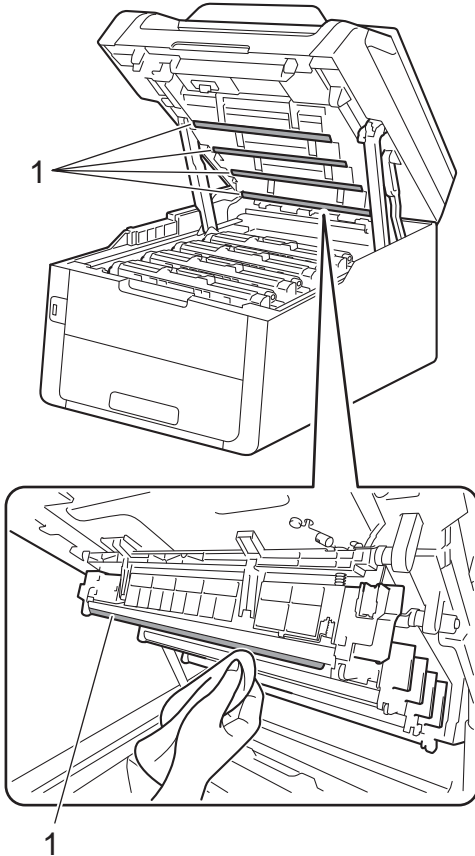

- 4 Close the top cover of the machine.
- 5 Press  to turn on the machine.

Cleaning the scanner

- 1 Press and hold down  to turn off the machine.
- 2 (For MFC-9340CDW)
 Unfold the ADF document support (1) and then open the ADF cover (2).
 Clean the white bar (3) and the scanner glass strip (4) underneath it with a soft lint-free cloth moistened with water.
 Close the ADF cover (2) and fold the ADF document support (1).

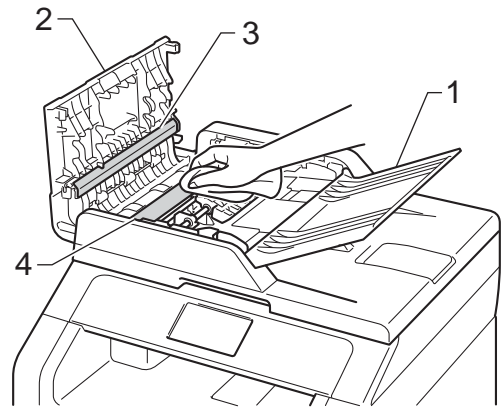

- 3 Lift the document cover (1). Clean the white plastic surface (2) and scanner glass (3) underneath it with a soft lint-free cloth moistened with water.

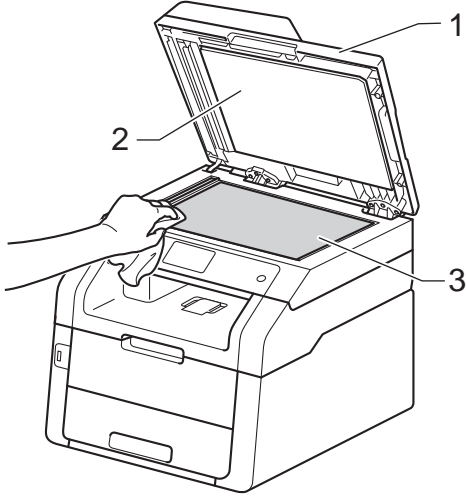

- 5 Close the document cover.
- 6 Press  to turn on the machine.

- 4 In the ADF unit, clean the white bar (1) and the scanner glass strip (2) underneath it with a soft lint-free cloth moistened with water.

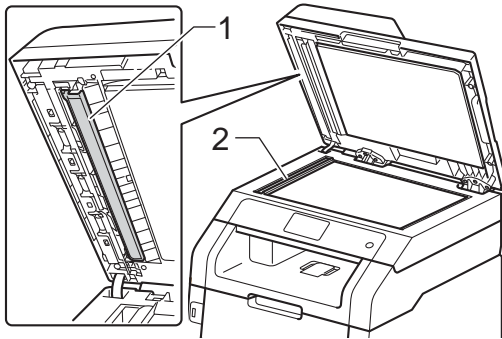

NOTE

In addition to cleaning the scanner glass and glass strip with a soft lint-free cloth moistened with water, run your finger tip over the glass to see if you can feel anything on it. If you feel dirt or debris, clean the glass again concentrating on that area. You may have to repeat the cleaning process three or four times. To test, make a copy after each cleaning.

Cleaning the corona wires

If you have print quality problems or the Touchscreen shows Drum !, clean the corona wires as follows:

- 1 Open the top cover until it locks in the open position.

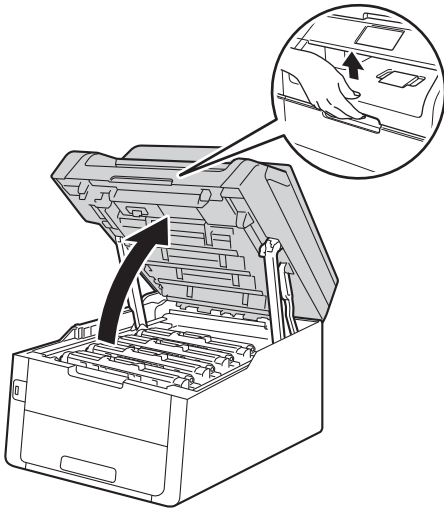

- 2 Remove the toner cartridge and drum unit assembly.

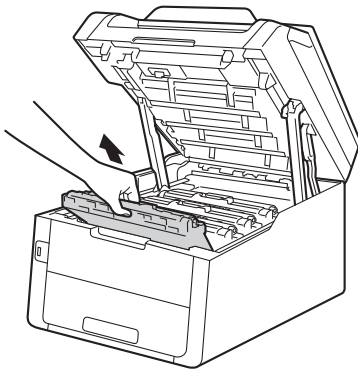

! WARNING

HOT SURFACE

After you have just used the machine, some internal parts of the machine will be extremely hot. Wait for the machine to cool down before you touch the internal parts of the machine.

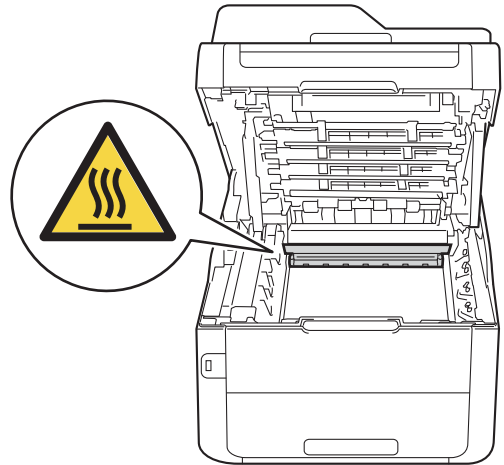

IMPORTANT

- We recommend that you place the toner cartridge and drum unit assembly on a clean, flat surface with disposable paper underneath it in case you accidentally spill or scatter toner.
- To prevent damage to the machine from static electricity, DO NOT touch the electrodes shown in the illustration.

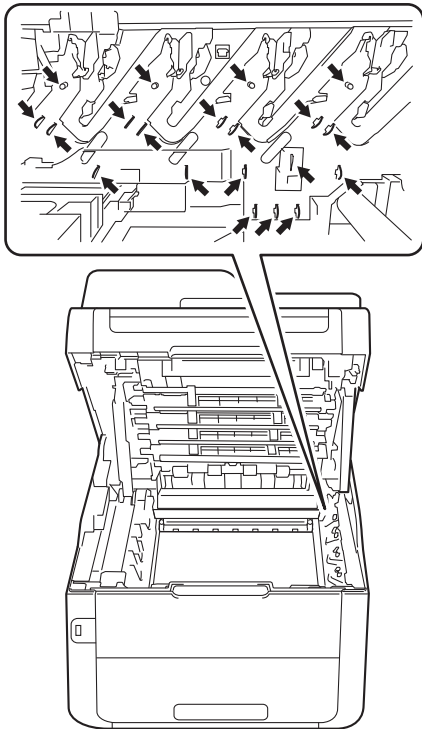

- 3 Clean the corona wire inside the drum unit by gently sliding the green tab from left to right and right to left several times.

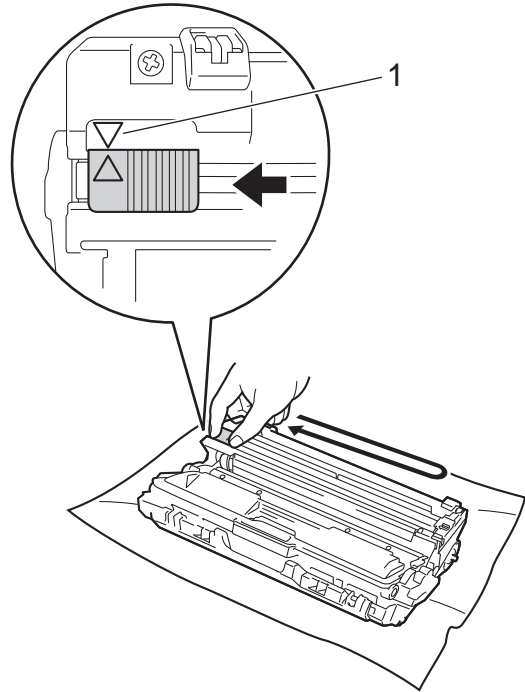

NOTE

Be sure to return the tab to the Home position (▲) (1). The arrow on the tab must be aligned with the arrow on the drum unit. If it is not, printed pages may have a vertical stripe.

- 4 Slide the toner cartridge and drum unit assembly into the machine. Make sure you match the toner cartridge color to the same color label on the machine.

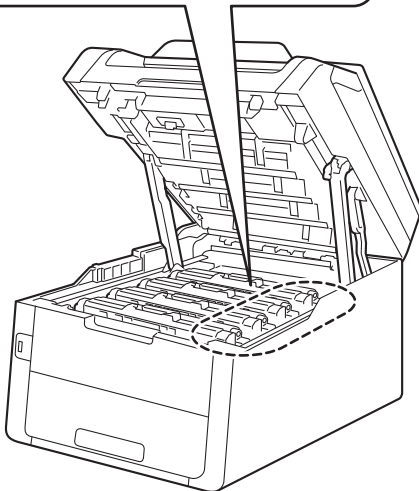
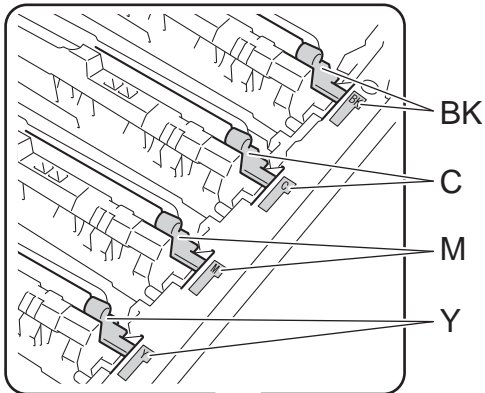
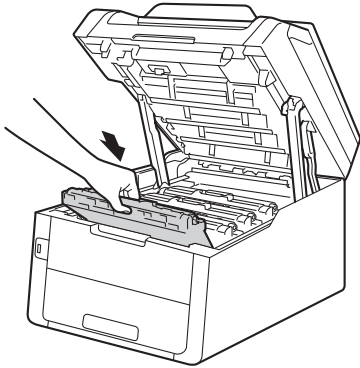

BK = Black, C = Cyan,
M = Magenta, Y = Yellow

- 5 Repeat steps 2 - 4 to clean each of the three remaining corona wires.



NOTE

When cleaning the corona wires, you do not have to remove the toner cartridge from the drum unit.

- 6 Close the top cover of the machine.

Cleaning the drum unit

If your printout has black or white dots or other repeating marks at 3.7 in. (94 mm) intervals, the drum may have foreign material, such as glue from a label stuck on the drum surface. Follow these steps to solve the problem.

- 1 Make sure the machine is in the Ready mode.
- 2 Press .
- 3 Press All Settings.
- 4 Swipe up or down, or press ▲ or ▼ to display Print Reports.
- 5 Press Print Reports.
- 6 Swipe up or down, or press ▲ or ▼ to display Drum Dot Print.
- 7 Press Drum Dot Print.
- 8 The Touchscreen will show Press [OK]. Press OK.
- 9 The machine will print the Drum Dot Check Sheet. Then press .
- 10 Press and hold down  to turn off the machine.

- 11 Open the top cover until it locks in the open position.

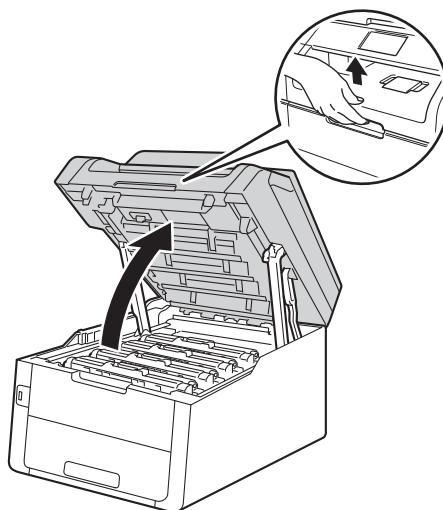

- 12 The color of printed dots is the color of the drum you should clean. Remove the toner cartridge and drum unit assembly of the color causing the problem.

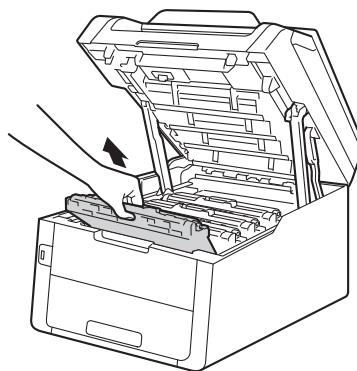

! WARNING**! HOT SURFACE**

After you have just used the machine, some internal parts of the machine will be extremely hot. Wait for the machine to cool down before you touch the internal parts of the machine.

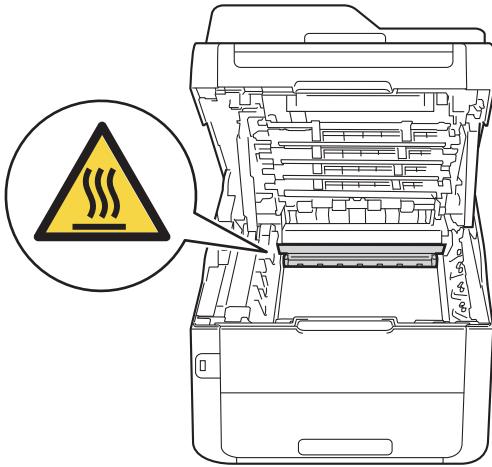
**IMPORTANT**

- We recommend that you place the toner cartridge and drum unit assembly on a clean, flat surface with disposable paper underneath it in case you accidentally spill or scatter toner.
- To prevent damage to the machine from static electricity, **DO NOT** touch the electrodes shown in the illustration.

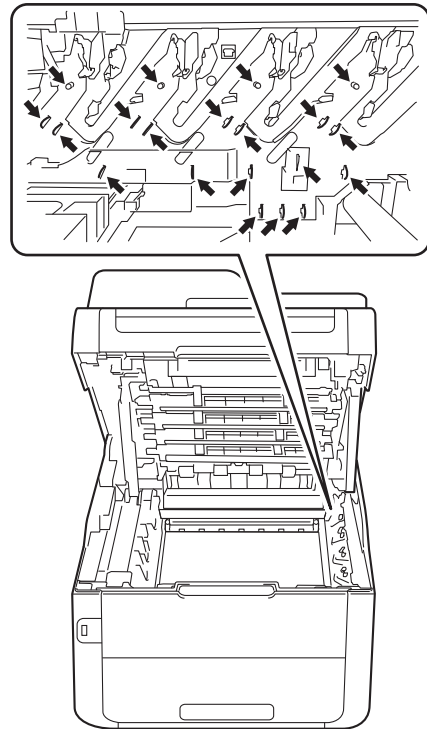

- 13 Push down the green lock lever and take the toner cartridge out of the drum unit.

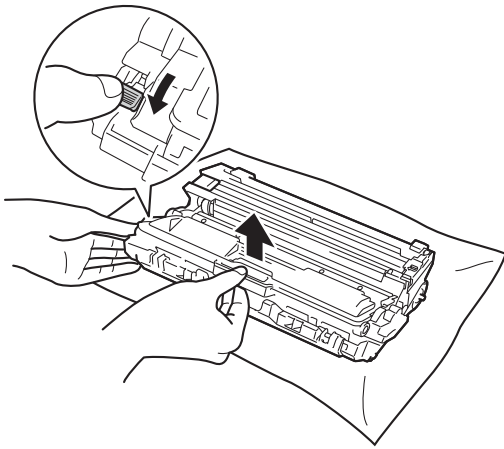

IMPORTANT

- Handle the toner cartridge carefully. If toner scatters on your hands or clothes, immediately wipe or wash it off with cold water.
- To avoid print quality problems, DO NOT touch the shaded parts shown in the illustrations.

<Toner cartridge>

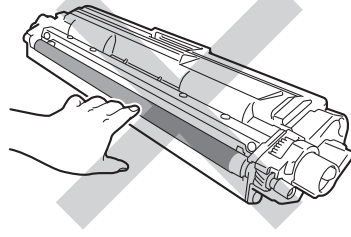

<Drum unit>

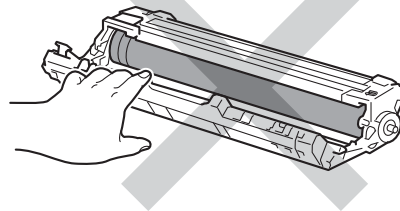
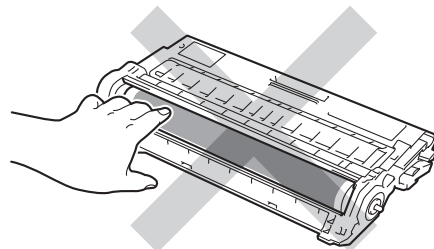

- We recommend that you place the toner cartridge on a clean, flat, level, stable surface with disposable paper or cloth underneath it in case you accidentally spill or scatter toner.

- 14 Turn the drum unit as shown in the illustration. Make sure the drum unit gear (1) is on the left side.

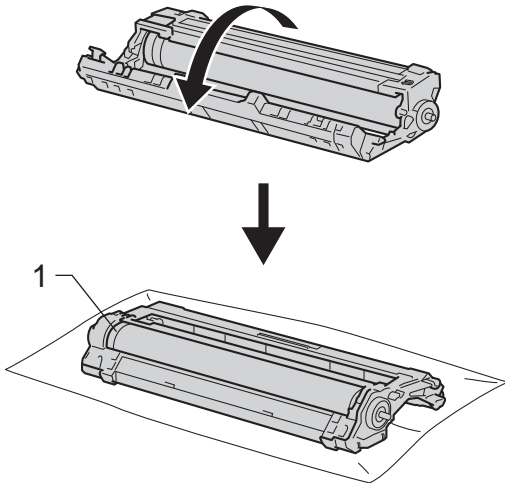

- 15 Read the following information from the Drum Dot Check Sheet.

■ Dot location:

The sheet has eight numbered columns. The number of the column with the printed dot in it is used to find the dot position on the drum.

- 16 Use the numbered markers next to the drum roller to find the mark. For example, a dot in column 2 on the Drum Dot Check Sheet would mean that there is a mark in the "2" region of the drum.

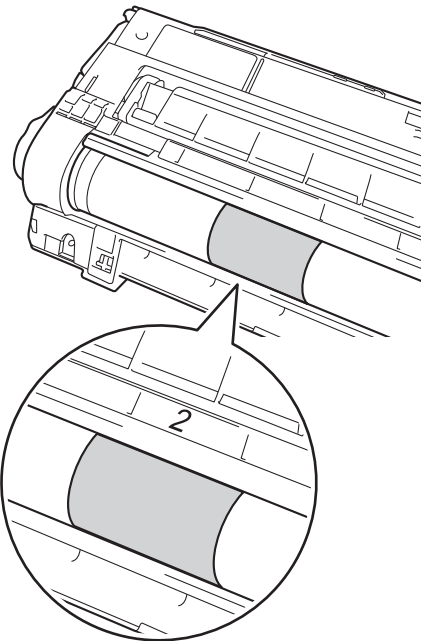
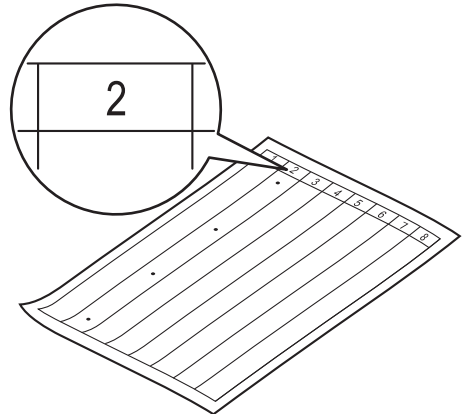

- 17 Turn the edge of the drum unit toward you by hand while looking at the surface of the suspected area.

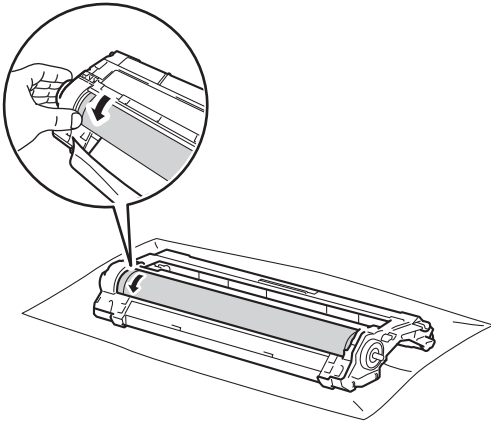

NOTE

DO NOT touch the drum's surface. To avoid print quality problems, hold the edges of the drum unit.

- 18 When you find the mark on the drum that matches the Drum Dot Check Sheet, wipe the surface of the drum gently with a *dry* cotton swab until the mark on the surface comes off.

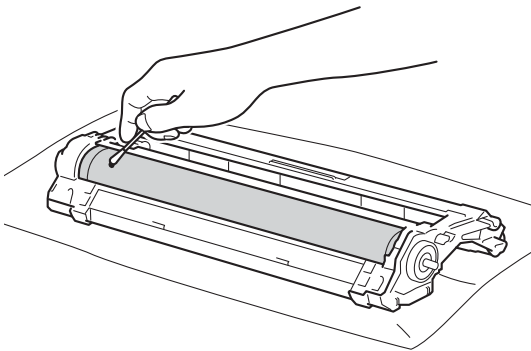

IMPORTANT

DO NOT clean the surface of the photosensitive drum with a sharp object or any liquids.

- 19 Turn the drum unit back over.

- 20 Put the toner cartridge firmly into the new drum unit until you hear it lock into place. If you put the cartridge in correctly, the green lock lever will lift automatically.

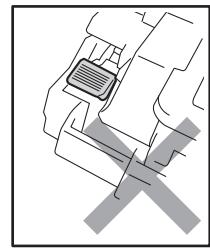
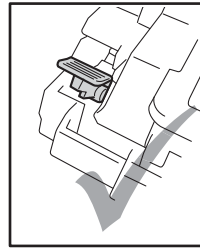
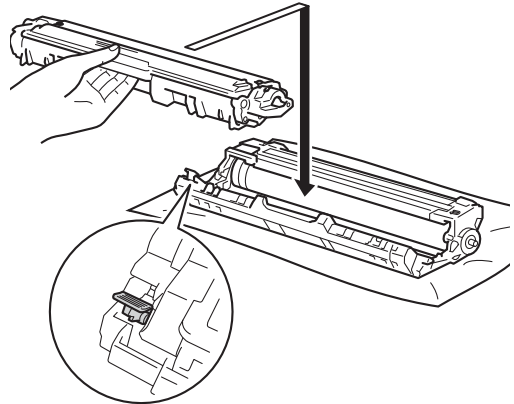

NOTE

Make sure you put in the toner cartridge correctly or it may separate from the drum unit.

- 21 Slide each toner cartridge and drum assembly into the machine. Make sure you match the toner cartridge color to the same color label on the machine.

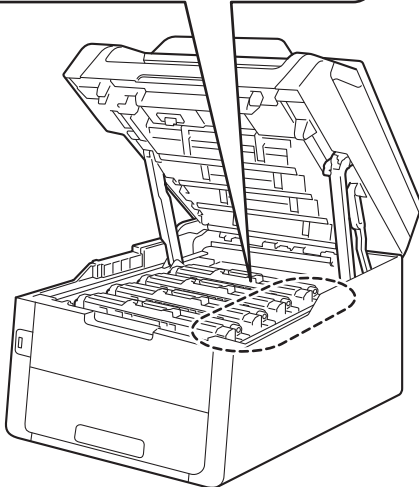
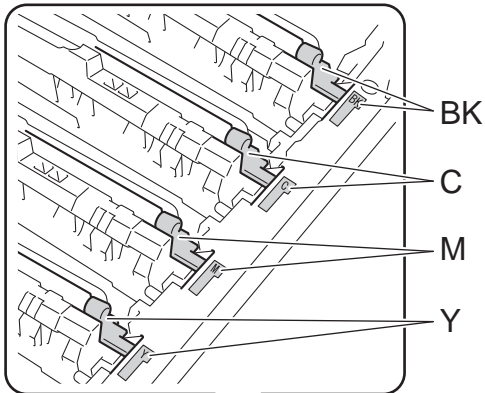
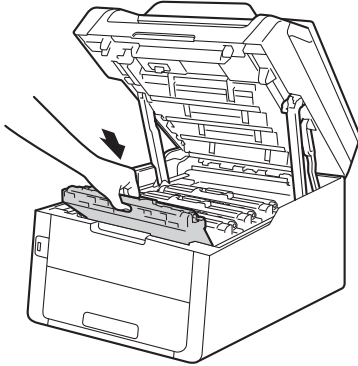

BK = Black, C = Cyan,
M = Magenta, Y = Yellow

- 22 Close the top cover of the machine.
- 23 Press  to turn on the machine and try a test print.

Cleaning the paper pick-up rollers

Cleaning the paper pick-up roller periodically may prevent paper jams by insuring the proper feeding of paper.

If you have paper feed problems, clean the pick-up rollers as follows:

- 1 Press and hold down  to turn off the machine.
- 2 Pull the paper tray completely out of the machine.

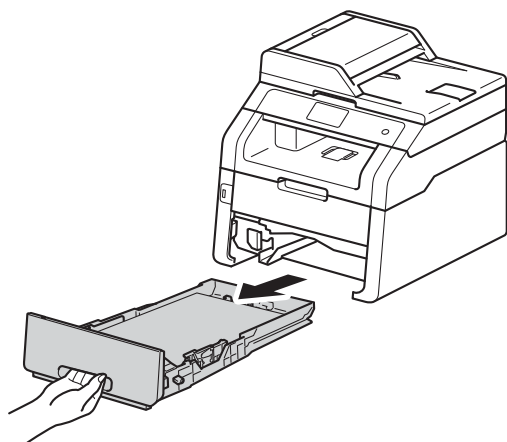

- 3 If paper is loaded or something is stuck inside in the paper tray, remove it.

- 4 Tightly wring out a lint-free cloth soaked in lukewarm water, and then wipe the separator pad (1) on the paper tray to remove dust.

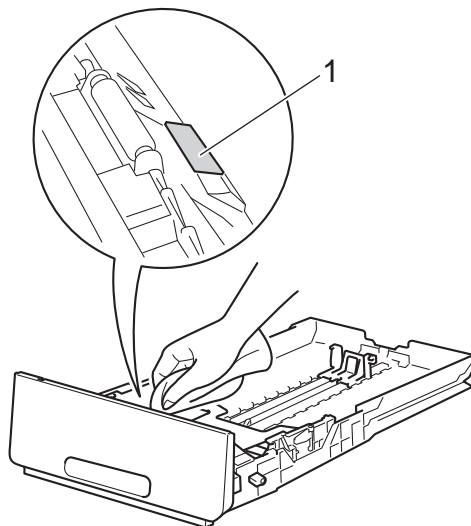

- 5 Wipe the two pick-up rollers (1) inside the machine to remove dust.

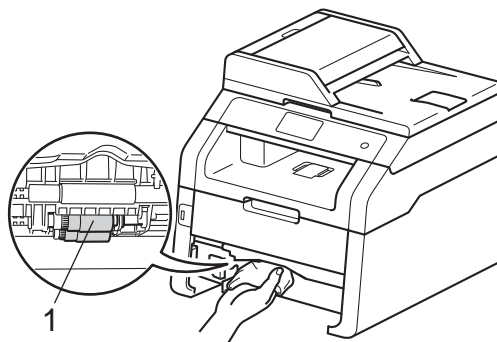



- 6 Reload the paper and put the paper tray back in the machine.



- 7 Press  to turn on the machine.

Calibration

The output density for each color may vary depending on the machine's environment, such as temperature and humidity. Calibration helps you to improve the color density.

- 1 Press .
- 2 Press Calibration.
- 3 Press Calibrate.
- 4 Press Yes to confirm.
- 5 Touchscreen will show Completed.
- 6 Press .

You can reset the calibration parameters back to those set at the factory.

- 1 Press .
- 2 Press Calibration.
- 3 Press Reset.
- 4 Press Yes to confirm.
- 5 Touchscreen will show Completed.
- 6 Press .

NOTE



- If an error message appears, press OK and try again.

(For more information, see Basic User's Guide: *Error and maintenance messages*.)

- If you are using the Windows® printer driver, the driver will get the calibration data automatically if both **Use Calibration Data** and **Get Device Data Automatically** are selected. The factory settings are on (see Software User's Guide).
- If you are using the Macintosh printer driver, the printer driver will get the calibration data automatically. If you want to get calibration data manually, you must perform the calibration using the **Status Monitor** (see Software User's Guide).



Auto Registration

If solid areas of color or images have cyan, magenta or yellow fringes, you can use the auto-registration feature to correct the problem.

- 1 Press .
- 2 Press `Auto Regist..`
- 3 Press `Yes` to confirm.
- 4 Touchscreen will show `Completed`.
- 5 Press .



Frequency (Color Correction)

You can set how often the color correction (Color Calibration and Auto Registration) occurs. The factory setting is Normal. The color correction process consumes some of the toner.

- 1 Press .
- 2 Press `All Settings`.
- 3 Swipe up or down, or press ▲ or ▼ to display `Printer`.
- 4 Press `Printer`.
- 5 Swipe up or down, or press ▲ or ▼ to display `Frequency`.
- 6 Press `Frequency`.
- 7 Press `Normal`, `Low` or `Off`.
- 8 Press .



Printing the test print

You can print a Test Print page to check your print quality.

- 1 Press .
- 2 Press Test Print.
- 3 The Touchscreen will show
Press [OK].
Press OK.
The machine will print the Test Print page.
- 4 Press .



Checking the Page Counters

You can see the machine's Page Counters for copies, printed pages, reports and lists, faxes or a summary total.

- 1 Press .
- 2 Press All Settings.
- 3 Swipe up or down, or press ▲ or ▼ to display Machine Info..
- 4 Press Machine Info..
- 5 Press Page Counter.
The Touchscreen shows number of pages for Total, Fax/List, Copy and Print.
- 6 Press .



Checking the remaining life of toner cartridges

You can see the approximate remaining life of the toner cartridges.

- 1 Press .
- 2 Press **Toner Life**.
The Touchscreen will show the approximate remaining life of the toner cartridges in a bar chart.
- 3 Press .

Checking the remaining life of parts

You can see the machine's parts life on the Touchscreen.

- 1 Press .
- 2 Press **All Settings**.
- 3 Swipe up or down, or press ▲ or ▼ to display **Machine Info..**
- 4 Press **Machine Info..**
- 5 Press **Parts Life**.
- 6 Press ▲ or ▼ to see the approximate remaining parts life of the
Drum Black (BK), Drum Cyan (C),
Drum Magenta (M),
Drum Yellow (Y), Belt Unit,
Fuser, PF Kit.
- 7 Press .

NOTE

- The life check will be accurate only if you reset the part counter when you install a new part. It will not be accurate if that part's life counter is reset during the life of the used part.
 - The remaining life of the toner cartridge is listed on the User Settings report (see *How to print a report* on page 50).
-

Replacing periodic maintenance parts

The periodic maintenance parts will need to be replaced regularly to maintain the print quality. The Fuser Unit and PF Kit parts listed in the table must be replaced after printing approximately 50,000 pages¹. Call Brother Customer Service when these messages appear on the Touchscreen.

Touchscreen message	Description
Replace Fuser	Replace the fuser unit.
Replace PF kit	Replace the paper feeding kit for the paper tray.

¹ Letter or A4 size single-sided pages.

Packing and shipping the machine

WARNING

This machine is heavy and weighs more than 44.1 lb (20.0 kg). To prevent possible injuries, at least two people should lift the machine. One person should hold the front of the machine, and one person should hold the back, as shown in the illustration. Be careful not to trap your fingers when you put the machine down.

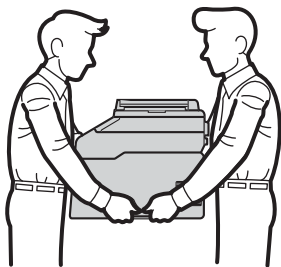

NOTE

- If for any reason you must ship your machine, carefully repack the machine in the original packaging to avoid any damage during transit. The machine should be adequately insured with the carrier.
- Unless you are returning the machine as part of the Brother Exchange Service, leave the toner cartridges and drum units inside the machine when you pack and ship it.

- 1 Press and hold down  to turn off the machine. Leave the machine turned off for at least 10 minutes to cool down.
- 2 Disconnect all the cables, and then unplug the power cord from the AC power outlet.
- 3 Place the packing material (1) into the carton.

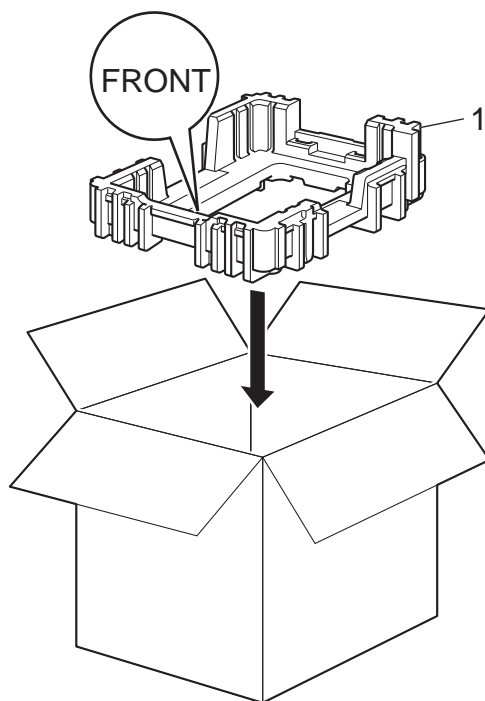

- 4 Wrap the machine in a plastic bag, then place it on the bottom packing material (1).

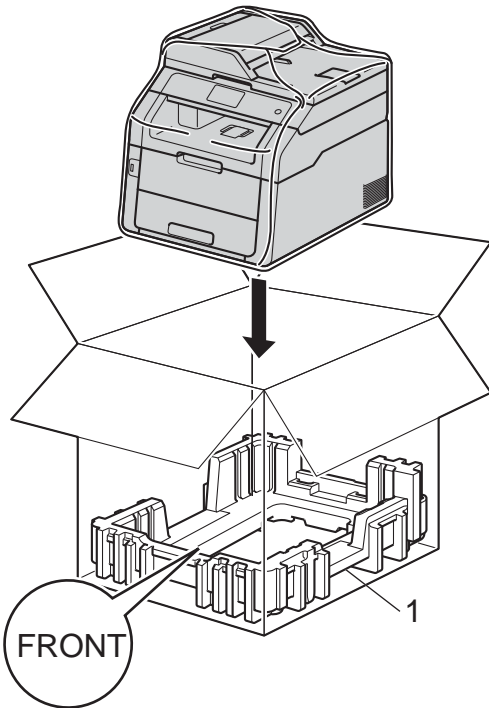

- 5 Place the packing material (2) marked "R" on the right of the machine. Place the packing material (3) marked "L" on the left of the machine. Place the AC power cord and printed materials in the original carton as shown in the illustration.

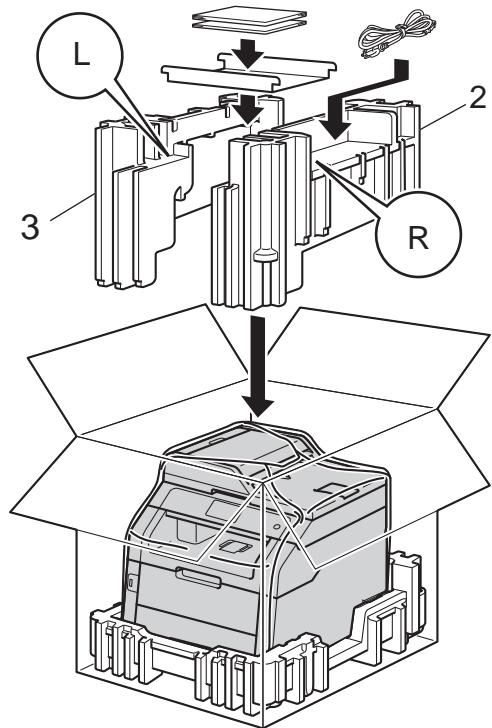

NOTE

If you are returning your machine to Brother as part of the Exchange Service, pack only the machine. Keep all separate parts, including the drum unit, toner cartridge, and printed materials to use with your 'Exchange' machine.

- 6 Close the carton and tape it shut.

This is a comprehensive list of features and terms that appear in Brother manuals. Availability of these features depends on the model you purchased.

3.7 in. Touchscreen LCD and Touchpanel

The Touchscreen LCD (Liquid Crystal Display) on the machine shows interactive messages and prompts for using the machine. You can operate the Touchscreen by pressing or swiping on the screen. The Touchpanel, on the right side of the Touchscreen LCD, illuminates its LEDs when they are available for the current operation.

Address Book

Names and numbers you have stored for easy dialing.

Address Book List

A listing of names and numbers stored in the Address Book memory, in alphabetical order.

ADF (automatic document feeder)

The document can be placed in the ADF and scanned one page at a time automatically.

Auto Reduction

Reduces the size of incoming faxes.

Automatic fax transmission

Sending a fax without picking up the handset of the external telephone or pressing **Hook**.

Automatic Redial

A feature that enables your machine to redial the last fax number after five minutes if the fax did not go through because the line was busy.

Backup Print

Your machine prints a copy of every fax that is received and stored in memory. This is a safety feature so you will not lose messages during a power failure.

Batch Transmission

As a cost saving feature, all delayed faxes to the same fax number will be sent as one transmission.

Beeper Volume

Volume setting for the sound when you press a key or make an error.

Broadcasting

The ability to send the same fax message to more than one location.

Cancel Job

Cancels a programmed print job and clears it from the machine's memory.

CNG tones

The special tones (beeps) sent by fax machines during automatic transmission to tell the receiving machine that a fax machine is calling.

Caller ID

A service purchased from the telephone company that lets you see the number (or name) of the party calling you.

Coding method

Method of coding the information contained in the document. All fax machines must use a minimum standard of Modified Huffman (MH). Your machine is capable of greater compression methods, Modified Read (MR), Modified Modified Read (MMR) and JBIG, if the receiving machine has the same capability.

Communication error (or Comm. Error)

An error during fax sending or receiving, usually caused by line noise or static.

Compatibility group

The ability of one fax unit to communicate with another. Compatibility is assured between ITU-T Groups.

Contrast

Setting to compensate for dark or light documents, by making faxes or copies of dark documents lighter and light documents darker.

Delayed Fax

Sends your fax at a specified later time that day.

Density

Changing the Density makes the whole image lighter or darker.

Distinctive Ring

A subscriber service purchased from the telephone company that gives you another telephone number on an existing telephone line. The Brother machine uses the new number to simulate a dedicated fax line.

Dual Access

Your machine can scan outgoing faxes or scheduled jobs into memory at the same time it is sending a fax or receiving or printing an incoming fax.

Easy Receive

Enables your machine to respond to CNG tones if you interrupt a fax call by answering it.

ECM (Error Correction Mode)

Detects errors during fax transmission and resends the pages of the fax that had an error.

Extension telephone

A telephone on the fax number that is plugged into a separate telephone wall jack.

External telephone

A telephone that is plugged into the EXT jack of your machine.

F/T Ring Time

The length of time that the Brother machine pseudo/double-rings (when the Receive Mode setting is Fax/Tel) to notify you to pick up a voice call that it answered.

Fax Forwarding

Sends a fax received into the memory to another pre-programmed fax number.

Fax Journal

Lists information about the last 200 incoming and outgoing faxes. TX means Transmit. RX means Receive.

Fax Receive Code (Fax/Tel mode only)

Press this code (*51) when you answer a fax call on an extension or external telephone.

Fax Storage

You can store faxes in the memory.

Fax tones

The signals sent by sending and receiving fax machines while communicating information.

Fax/Tel

You can receive faxes and telephone calls. Do not use this mode if you are using a telephone answering device (TAD).

Fine resolution

Resolution is 203 × 196 dpi. It is used for small print and graphs.

Gray Scale

The shades of gray available for copying and faxing photographs.

Group number

A combination of Address Book numbers that are stored in Address Book for Broadcasting.

Journal Period

The pre-programmed time period between automatically printed Fax Journal Reports. You can print the Fax Journal on demand without interrupting the cycle.

Manual fax

When you press **Hook** to hear the receiving fax machine answer before you press **Fax Start** to begin transmission.

OCR (optical character recognition)

Nuance™ PaperPort™ 12SE or Presto! PageManager software application converts an image of text to text you can edit.

Out of Paper Reception

Receives faxes into the machine's memory when the machine is out of paper.

Overseas Mode

Makes temporary changes to the fax tones to accommodate noise and static on overseas telephone lines.

Paging

This feature enables your machine to call your cell phone or pager when a fax is received into its memory.

Pause

Allows you to place a 3.5 second delay in the dialing sequence while you are dialing using the dial pad or while you are storing numbers in Address Book. Press **Pause** as many times as needed for longer pauses.

Polling

The process of a fax machine calling another fax machine to retrieve waiting fax messages.

Pulse (Canada only)

A form of rotary dialing on a telephone line.

Real Time Transmission

When memory is full, you can send faxes in real time.

Remaining Jobs

You can check which programmed fax jobs are waiting in the memory and cancel the jobs individually.

Remote Access Code

Your own four-digit code (— —*) that allows you to call and access your machine from a remote location.

Remote Retrieval Access

The ability to access your machine remotely from a touch tone telephone.

Resolution

The number of vertical and horizontal lines per inch.

Ring Delay

The number of rings before the machine answers in **Fax** and **Fax/Tel** modes.

Ring Volume

Volume setting for the machine's ring.

Scanning

The process of sending an electronic image of a paper document into your computer.

Search

An alphabetical electronic listing of stored Address Book and Group numbers.

Settings Tables

At-a-glance instructions that show all the settings and options that are available for setting up your machine.

Station ID

The stored information that appears on the top of faxed pages. It includes the sender's name and fax number.

TAD (telephone answering device)

You can connect an external device or answering machine to the EXT. jack of your machine.

Telephone Answer Code (Fax/Tel mode only)

When the machine answers a voice call, it pseudo/double-rings. You can pick up at an extension telephone by pressing this code (**#51**).

Temporary settings

You can choose certain options for each fax transmission and copy without changing the default settings.

Tone

A form of dialing on the telephone line used for Touch Tone telephones.

Transmission

The process of sending faxes over the telephone lines from your machine to the receiving fax machine.

Transmission Verification Report

A report for each transmission, that shows its date, time and number.

User Settings List

A printed report that shows the current settings of the machine.

C

Index

Numerics

2-sided copy53

A

Address Book

access codes and credit card
numbers44
broadcasting19
 using Groups19
Group dial
 setting up Groups for broadcasting45

Apple Macintosh

See Software User's Guide.

B

Broadcasting19
 canceling20
 setting up Groups for45

C

Canceling

broadcast in process20
fax jobs in memory23
fax storage31
jobs awaiting redial23
remote fax options32

Cleaning

corona wires67
drum unit70
LED head64
scanner65

Connecting

two-line external TAD or telephone43

ControlCenter2 (for Macintosh)

See Software User's Guide.

ControlCenter4 (for Windows®)

See Software User's Guide.

Copy

2 in 1 ID Copy 58
2-sided 53
button 51
contrast 55
Density 55
enlarge/reduce 52
N in 1 (page layout) 56
quality 51
saving paper 61
sort 56
temporary settings 51
using ADF 57
using scanner glass54, 56, 57
Cover page 25
 custom comments 25
 printed form 26

D

Daylight Saving Time 3
Deep Sleep mode 4
Delayed batch transmission 22
Destination Display 27
Dialing
 access codes and credit card
 numbers 44
 dial prefix 6
 Groups (broadcasting) 19
 restricting dialing 14
Drum unit
 checking (remaining life) 80
 cleaning 67, 70
Dual access 19

E

Enlarge/Reduce 52

F

Fax codes	
changing	33
remote access code	33
Fax forwarding	
changing remotely	34, 35
programming a number	29
Fax storage	31
printing from memory	38
turning off	32
turning on	31
Fax, stand-alone	
receiving	
at end of conversation	37
fax forwarding	29, 34
fax receive stamp	37
into memory (fax storage)	31
paging	30
polling receive	40
reducing to fit on paper	36
retrieving from a remote site	34, 35
sending	15
at end of conversation	18
broadcasting	19
canceling from memory	23
contrast	17
delayed batch	22
delayed fax	22
destination display	27
from memory (dual access)	19
manual	18
overseas	21
polled transmit	28
real time transmission	21
resolution	17
Fax/Tel mode	
receiving faxes	42

G

Groups for broadcasting	45
-------------------------------	----

H

Hook	18
------------	----

J

Jacks	
convert to RJ11 jack	
triplex adapter	42, 43

M

Machine information	
checking remaining life of parts	80
page counts	79
Macintosh	
See Software User's Guide.	
Maintenance, routine	62
checking the remaining life of parts	80
Manual	
transmission	18
Memory	
storage	1

N

N in 1 (page layout)	56
Network	
faxing	
See Software User's Guide.	
printing	
See Network User's Guide.	
scanning	
See Software User's Guide.	
Nuance™ PaperPort™ 12SE	
See Software User's Guide and Help in the	
PaperPort™ 12SE application to access	
How-to-Guides.	

O

Outgoing Calls	
Add to Address Book	45

P

Page layout (N in 1)	56
Paging	30
programming your cell number	30
programming your pager number	30
PC-Fax	
See Software User's Guide.	
Polling	
polled transmit	28
polling receive	40
Power failure	1
Presto! PageManager	
See Software User's Guide. See also Help in the Presto! PageManager application.	
Print	
fax from memory	38
reports	49
Printing	
See Software User's Guide.	

Q

Quality	
copying	51

R

Redial/Pause	44
Reducing	
copies	52
incoming faxes	36
Remote retrieval	33
access code	33
commands	34
getting your faxes	35
Remote setup	
See Software User's Guide.	
Reports	48, 49
Drum Dot Print	49
Fax Journal	48, 49
journal period	48
how to print	50
Network Configuration	49
Tel Index List	49
Transmission Verification	48
User Settings	49
WLAN Report	49
Resolution	
fax (standard, fine, superfine, photo)	17
setting for next fax	17

S

Scanning	
See Software User's Guide.	
Security	
restricting dialing	14
Secure function lock	
administrator password	8
Setting lock	12
Sleep mode	4
Sort	56

T

TAD (telephone answering device),	
external	43
with two-line jack	43
Telephone line	
converting wall outlets	42
roll over lines	42
two-line telephone system	42, 43
Temporary copy settings	51
Toner Save	3
Touchscreen	
backlight brightness	5
Two-line telephone system	42, 43

V

Volume, setting	
beeper	2
ring	1
speaker	2

W

Warranties.....	in the box
Windows®	
See Software User's Guide.	
Wireless Network	
See Quick Setup Guide and	
Network User's Guide.	

Brother International Corporation
200 Crossing Boulevard
P.O. Box 6911
Bridgewater, NJ 08807-0911 USA

Brother International Corporation (Canada) Ltd.
1 rue Hôtel de Ville,
Dollard-des-Ormeaux, QC, Canada H9B 3H6

brother[®]

**Visit us on the World Wide Web
<http://www.brother.com/>**

These machines are approved for use in the country of purchase only. Local Brother companies or their dealers will only support machines purchased in their own countries.



www.brotherearth.com

Free Manuals Download Website

<http://myh66.com>

<http://usermanuals.us>

<http://www.somanuals.com>

<http://www.4manuals.cc>

<http://www.manual-lib.com>

<http://www.404manual.com>

<http://www.luxmanual.com>

<http://aubethermostatmanual.com>

Golf course search by state

<http://golfingnear.com>

Email search by domain

<http://emailbydomain.com>

Auto manuals search

<http://auto.somanuals.com>

TV manuals search

<http://tv.somanuals.com>