

brother®

USER'S GUIDE

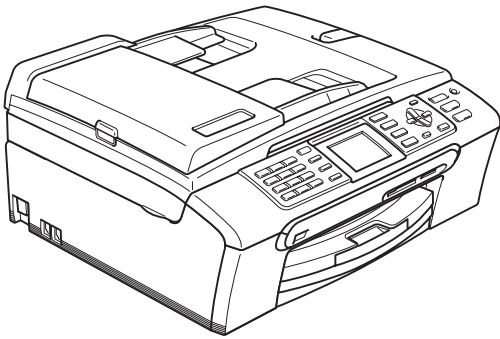

MFC-440CN
MFC-665CW
MFC-845CW

If you need to call Customer Service

Please complete the following information for future reference:

Model Number: MFC-440CN, MFC-665CW and MFC-845CW (Circle your model number)

Serial Number: ¹ _____

Date of Purchase: _____

Place of Purchase: _____

¹ The serial number is on the back of the unit. Retain this User's Guide with your sales receipt as a permanent record of your purchase, in the event of theft, fire or warranty service.

Register your product on-line at

<http://www.brother.com/registration/>

By registering your product with Brother, you will be recorded as the original owner of the product. Your registration with Brother:

- may serve as confirmation of the purchase date of your product should you lose your receipt;
- may support an insurance claim by you in the event of product loss covered by insurance; and,
- will help us notify you of enhancements to your product and special offers.

The most convenient and efficient way to register your new product is on-line at <http://www.brother.com/registration/>

Brother numbers

IMPORTANT

For technical help, you must call the country where you bought the machine. Calls must be made *from within* that country.

Register your product

By registering your product with Brother International Corporation, you will be recorded as the original owner of the product. Your registration with Brother:

- may serve as confirmation of the purchase date of your product should you lose your receipt;
- may support an insurance claim by you in the event of product loss covered by insurance; and,
- will help us notify you of enhancements to your product and special offers.

Please complete and fax the Brother Warranty Registration And Test Sheet or, for your convenience and most efficient way to register your new product, register on-line at

<http://www.brother.com/registration/>

FAQs (frequently asked questions)

The Brother Solutions Center is our one-stop resource for all your Fax Machine/Multi-Function Center needs. You can download the latest software documents and utilities, read FAQs and troubleshooting tips, and learn how to get the most from your Brother product.

<http://solutions.brother.com>



Note

- You can check here for Brother driver updates.
- To keep your machine performance up to date, check here for the latest firmware upgrade (for Windows® only).

For Customer Service

In USA:	1-800-284-4329 (voice)
	1-901-379-1215 (fax)
	1-800-284-3238 (TTY service for the hearing-impaired)
In Canada:	1-877-BROTHER (voice)
	(514) 685-4898 (fax)

Service Center Locator (USA only)

For the location of a Brother authorized service center, call 1-800-284-4357.

Service Center Locations (Canada only)

For the location of a Brother authorized service center, call 1-877-BROTHER.

Brother fax back system (USA only)

Brother has installed an easy-to-use fax back system, so you can get instant answers to common technical questions and product information for all Brother products. This system is available 24 hours a day, 7 days a week. You can use the system to receive faxed instructions and an Index of fax back subjects.

In USA only:

1-800-521-2846

Ordering accessories and supplies

For best quality results use only genuine Brother accessories, which are available at most Brother retailers. If you cannot find the accessory you need and you have a Visa, MasterCard, Discover, or American Express credit card, you can order accessories directly from Brother. (In the USA, you can visit us online for a complete selection of the Brother accessories and supplies that are available for purchase.)

In USA: 1-888-879-3232 (voice)

1-800-947-1445 (fax)

<http://www.brothermall.com>

In Canada: 1-877-BROTHER (voice)

Description	Item
Ink Cartridge Standard <black>	LC51BK (Prints approx. 500 pages)
Ink Cartridge <cyan> (blue)	LC51C (Prints approx. 400 pages)
Ink Cartridge <magenta> (red)	LC51M (Prints approx. 400 pages)
Ink Cartridge <yellow>	LC51Y (Prints approx. 400 pages)
Premium Glossy Photo Paper (Letter size / 20 sheets) (4"×6" size / 20 sheets)	BP61GLL ¹ BP61GLP ¹
Matte Inkjet Paper (Letter size / 25 sheets)	BP60ML (USA only)
Inkjet Plain Paper (Letter size / 250 sheets)	BP60PL (USA only)
Telephone Line Cord	LG3077001 (USA only)
Telephone Handset (MFC-665CW only)	LE5803016 (USA only)
Handset Curled Cord (MFC-665CW only)	UL8019005 (USA only)
Cordless Handset (MFC-845CW only)	BCL-D10
Battery (MFC-845CW only)	BCL-BT10
User's Guide	LP5196001 (English for USA and Canada) LP3290002 (French for Canada)

¹ Available in the USA and from November 2006 in Canada.

Notice - Disclaimer of Warranties (USA and Canada)

BROTHER'S LICENSOR(S), AND THEIR DIRECTORS, OFFICERS, EMPLOYEES OR AGENTS (COLLECTIVELY BROTHER'S LICENSOR) MAKE NO WARRANTIES, EXPRESS OR IMPLIED, INCLUDING WITHOUT LIMITATION THE IMPLIED WARRANTIES OF MERCHANTABILITY AND FITNESS FOR A PARTICULAR PURPOSE, REGARDING THE SOFTWARE. BROTHER'S LICENSOR(S) DOES NOT WARRANT, GUARANTEE OR MAKE ANY REPRESENTATIONS REGARDING THE USE OR THE RESULTS OF THE USE OF THE SOFTWARE IN TERMS OF ITS CORRECTNESS, ACCURACY, RELIABILITY, CURRENTNESS OR OTHERWISE. THE ENTIRE RISK AS TO THE RESULTS AND PERFORMANCE OF THE SOFTWARE IS ASSUMED BY YOU. THE EXCLUSION OF IMPLIED WARRANTIES IS NOT PERMITTED BY SOME STATES IN THE USA AND SOME PROVINCES IN CANADA. THE ABOVE EXCLUSION MAY NOT APPLY TO YOU.

IN NO EVENT WILL BROTHER'S LICENSOR(S) BE LIABLE TO YOU FOR ANY CONSEQUENTIAL, INCIDENTAL OR INDIRECT DAMAGES (INCLUDING DAMAGES FOR LOSS OF BUSINESS PROFITS, BUSINESS INTERRUPTION, LOSS OF BUSINESS INFORMATION, AND THE LIKE) ARISING OUT OF THE USE OR INABILITY TO USE THE SOFTWARE EVEN IF BROTHER'S LICENSOR HAS BEEN ADVISED OF THE POSSIBILITY OF SUCH DAMAGES. BECAUSE SOME STATES IN THE USA AND SOME PROVINCES IN CANADA DO NOT ALLOW THE EXCLUSION OR LIMITATION OF LIABILITY FOR CONSEQUENTIAL OR INCIDENTAL DAMAGES, THE ABOVE LIMITATIONS MAY NOT APPLY TO YOU. IN ANY EVENT BROTHER'S LICENSOR'S LIABILITY TO YOU FOR ACTUAL DAMAGES FROM ANY CAUSE WHATSOEVER, AND REGARDLESS OF THE FORM OF THE ACTION (WHETHER IN CONTRACT, TORT (INCLUDING NEGLIGENCE), PRODUCT LIABILITY OR OTHERWISE), WILL BE LIMITED TO \$50.

Compilation and Publication Notice

Under the supervision of Brother Industries Ltd., this manual has been compiled and published, covering the latest product descriptions and specifications.

The contents of this manual and the specifications of this product are subject to change without notice.

Brother reserves the right to make changes without notice in the specifications and materials contained herein and shall not be responsible for any damages (including consequential) caused by reliance on the materials presented, including but not limited to typographical and other errors relating to the publication.

Brother® One Year Limited Warranty and Replacement Service (USA only)

Who is covered:

- This limited warranty (“warranty”) is given only to the original end-use/retail purchaser (referred to in this warranty as “Original Purchaser”) of the accompanying product, consumables and accessories (collectively referred to in this warranty as “this Product”).
- If you purchased a product from someone other than an authorized Brother reseller in the United States or if the product was used (including but not limited to floor models or refurbished product), prior to your purchase you are not the Original Purchaser and the product that you purchased is not covered by this warranty.

What is covered:

- This Product includes a Machine and Consumable and Accessory Items. Consumable and Accessory Items include but are not limited to print heads, toner, drums, ink cartridges, print cartridges, refill ribbons, therma PLUS paper, thermal paper, and the cordless handset battery.
- Except as otherwise provided herein, Brother warrants that the Machine and the accompanying Consumable and Accessory Items will be free from defects in materials and workmanship, when used under normal conditions.
- This warranty applies only to products purchased and used in the United States. For products purchased in, but used outside, the United States, this warranty covers only warranty service within the United States (and does not include shipping outside the United States).

What is the length of the Warranty Periods:

- Machines: one year from the original purchase date.
- Accompanying Consumable and Accessory Items: 90 days from the original purchase date or the rated life of consumable, whichever comes first.

What is NOT covered:

This warranty does not cover:

- 1 Physical damage to this Product;
- 2 Damage caused by improper installation, improper or abnormal use, misuse, neglect or accident (including but not limited to transporting this Product without the proper preparation and/or packaging);

- 3 Damage caused by another device or software used with this Product (including but not limited to damage resulting from use of non Brother®-brand parts and Consumable and Accessory Items);
- 4 Consumable and Accessory Items that expired in accordance with a rated life; and,
- 5 Problems arising from other than defects in materials or workmanship.
- 6 Normal Periodic Maintenance Items, such as Paper Feeding Kit, Fuser and Laser Units.

This limited warranty is VOID if this Product has been altered or modified in any way (including but not limited to attempted warranty repair without authorization from Brother and/or alteration/removal of the serial number).

What to do if you think your Product is eligible for warranty service:

Report your issue to either our Customer Service Hotline at 1-800-284-4329 for Fax, MFC and DCP and 1-800-276-7746 for Printers, or to a Brother Authorized Service Center **within the applicable warranty period.** Supply Brother or the Brother Authorized Service Center with a copy of your dated bill of sale showing that this Product was purchased within the U.S. For the name of local Brother Authorized Service Center(s), call 1-800-521-2846.

What Brother will ask you to do:

After contacting Brother or a Brother Authorized Service Center, you may be required to deliver (by hand if you prefer) or send the Product properly packaged, freight prepaid, to the Authorized Service Center together with a photocopy of your bill of sale.

You are responsible for the cost of shipping, packing product, and insurance (if you desire). You are also responsible for loss or damage to this Product in shipping.

What Brother will do:

If the problem reported concerning your Machine and/or accompanying Consumable and Accessory Items is covered by this warranty and if you first reported the problem to Brother or an Authorized Service Center within the applicable warranty period, Brother or its Authorized Service Center will repair or replace the Machine and/or accompanying Consumable and Accessory Items at no charge to you for parts or labor. The decision as to whether to repair or replace the Machine and/or accompanying Consumable and Accessory Items is made by Brother in its sole

Brother® One Year Limited Warranty and Replacement Service (USA only)

discretion. Brother reserves the right to supply a refurbished or remanufactured replacement Machine and/or accompanying Consumable and Accessory Items and use refurbished parts provided such replacement products conform to the manufacturer's specifications for new product/parts. The repaired or replacement Machine and/or accompanying Consumable and Accessory Items will be returned to you freight prepaid or made available for you to pick up at a conveniently located Authorized Service Center.

If the Machine and/or accompanying Consumable and Accessory Items are not covered by this warranty (either stage), you will be charged for shipping the Machine and/or accompanying Consumable and Accessory Items back to you and charged for any service and/or replacement parts/products at Brother's then current published rates.

The foregoing are your sole (i.e., only) and exclusive remedies under this warranty.

What happens when Brother elects to replace your Machine:

When a replacement Machine is authorized by Brother, and you have delivered the Machine to an Authorized Service Center, the Authorized Service Center will provide you with a replacement Machine after receiving one from Brother. If you are dealing directly with Brother, Brother will send to you a replacement Machine with the understanding that you will, after receipt of the replacement Machine, supply the required proof of purchase information, together with the Machine that Brother agreed to replace. You are then expected to pack the Machine that Brother agreed to replace in the package from the replacement Machine and return it to Brother using the pre-paid freight bill supplied by Brother in accordance with the instructions provided by Brother. Since you will be in possession of two machines, Brother will require that you provide a valid major credit card number. Brother will issue a hold against the credit card account number that you provide until Brother receives your original Product and determines that your original Product is entitled to warranty coverage. Your credit card will be charged up to the cost of a new Product only if: (i) you do not return your original Product to Brother within five (5) business days; (ii) the problems with your original Product are not covered by the limited warranty; (iii) the proper packaging instructions are not followed and has caused damage to the product; or (iv) the warranty period on your original Product has expired or

has not been sufficiently validated with a copy of the proof of purchase (bill of sale). The replacement Machine you receive (even if refurbished or remanufactured) will be covered by the balance of the limited warranty period remaining on the original Product, plus an additional thirty (30) days. You will keep the replacement Machine that is sent to you and your original Machine shall become the property of Brother. **Retain your original Accessory Items and a copy of the return freight bill, signed by the courier.**

Limitations:

Brother is not responsible for damage to or loss of any equipment, media, programs or data related to the use of this Product. Except for that repair or replacement as described above, Brother shall not be liable for any direct, indirect, incidental or consequential damages or specific relief. Because some states do not allow the exclusion or limitation of consequential or incidental damages, the above limitation may not apply to you.

THIS WARRANTY IS GIVEN IN LIEU OF ALL OTHER WARRANTIES, WRITTEN OR ORAL, WHETHER EXPRESSED BY AFFIRMATION, PROMISE, DESCRIPTION, DRAWING, MODEL OR SAMPLE. ANY AND ALL WARRANTIES OTHER THAN THIS ONE, WHETHER EXPRESS OR IMPLIED, INCLUDING IMPLIED WARRANTIES OF MERCHANTABILITY AND FITNESS FOR A PARTICULAR PURPOSE, ARE HEREBY DISCLAIMED.

- This Limited Warranty is the only warranty that Brother is giving for this Product. It is *the final expression and the exclusive and only statement* of Brother's obligations to you. It replaces all other agreements and understandings that you may have with Brother or its representatives.
- This warranty gives you certain rights and you may also have other rights that may vary from state to state.
- This Limited Warranty (and Brother's obligation to you) may not be changed in any way unless you and Brother sign the same piece of paper in which we (1) refer to this Product and your bill of sale date, (2) describe the change to this warranty and (3) agree to make that change.

Important:

We recommend that you keep all original packing materials, in the event that you ship this Product.

BROTHER MULTIFUNCTION CENTER/FACSIMILE MACHINE LIMITED WARRANTY (Canada only)

Pursuant to this limited warranty of 1 year from the date of purchase for labour and parts, Brother International Corporation (Canada) Ltd. ("Brother"), or its Authorized Service Centers, will repair this MFC/Facsimile machine free of charge if defective in material or workmanship. This Limited Warranty does not include cleaning, consumables (including, without limitation, print cartridges, print head, toner and drum) or damage caused by accident, neglect, misuse or improper installation or operation, any damage caused from service, maintenance, modifications, or tampering by anyone other than a Brother Authorized Service Representative, or from the use of supplies or consumable items that are non-Brother products. Operation of the MFC/Facsimile machine in excess of the specifications or with the Serial Number or Rating Label removed shall be deemed abuse and all repairs thereafter shall be the sole liability of the end-user/purchaser. In order to obtain warranty service, the MFC/Facsimile machine must be delivered or shipped freight prepaid by the end user/purchaser to a "Brother" Authorized Service Center, together with your Proof of Purchase in the form of a Sales Receipt.

For laser products: Failure to remove the Toner Cartridge (and Toner Drum Unit on applicable models) during shipping will cause severe damage to the MFC/Facsimile and will VOID the Warranty. (Refer to your User's Guide for proper packaging.)

For ink-jet products: Do not remove the ink cartridges during shipping. Damage to your print head resulting from packing without the ink cartridges will VOID your warranty. (Refer to your User's Guide for proper packaging.)

BROTHER DISCLAIMS ALL OTHER WARRANTIES EXPRESSED OR IMPLIED INCLUDING, WITHOUT LIMITATION, ANY IMPLIED WARRANTIES OF MERCHANTABILITY OR FITNESS FOR A PARTICULAR PURPOSE, EXCEPT TO THE EXTENT THAT ANY WARRANTIES IMPLIED BY LAW CANNOT BE VALIDLY WAIVED.

No oral or written information, advice or representation provided by Brother, its Authorized Service Centers, Distributors, Dealers, Agents or employees, shall create another warranty or modify this warranty. This warranty states Brother's entire liability and your exclusive remedy against Brother for any failure of the MFC/Facsimile machine to operate properly.

Neither Brother nor anyone else involved in the development, production, or delivery of this MFC/Facsimile machine shall be liable for any indirect, incidental, special, consequential, exemplary, or punitive damages, including lost profits, arising from the use of or inability to use the product, even if advised by the end user/purchaser of the possibility of such damages. Since some Provinces do not allow the above limitation of liability, such limitation may not apply to you.

This Limited Warranty gives you specific legal rights and you may also have other rights which vary from Province to Province.

Warranty Service is available at Brother Authorized Service Centers throughout Canada. For Technical Support or for the name and location of your nearest Authorized Service Center call 1-877-BROTHER.

Internet support: support@brother.ca or browse

Brother's Web Site: www.brother.com

Brother International Corporation (Canada) Ltd.

1 Rue Hôtel de Ville

Dollard-Des-Ormeaux, QC H9B 3H6

At your side.
brother®

Table of Contents

Section I General

1 General Information

Using the documentation	2
Symbols and conventions used in the documentation	2
Accessing the Software User's Guide and Network User's Guide	2
Viewing Documentation	2
Accessing Brother Support (For Windows®)	5
Control panel overview	6
LCD display screen	9
Basic Operations	10

2 Loading documents and paper

Loading documents	11
Using the ADF	11
Using the scanner glass	12
Scannable area	12
Acceptable paper and other media	13
Recommended media	13
Handling and using media	13
Choosing the right media	15
Loading paper and other media	17
Loading envelopes and post cards	19
Loading photo paper	21
Removing small printouts from the machine	22
Printable area	23

3 General setup

On/Off key	24
Turning the machine off	24
Turning the machine on	24
On/Off setting	24
Mode Timer	26
Paper settings	26
Paper Type	26
Paper Size	27
Volume Settings	27
Ring Volume	27
Beeper Volume	27
Speaker Volume	28
Handset Volume (MFC-665CW only)	28
Choosing the Handset Volume (For Volume Amplify) (MFC-665CW only)	29
Setting Volume Amplify (MFC-665CW only)	30
Automatic Daylight Savings Time	30

LCD display	31
LCD Contrast.....	31
Setting the backlight brightness.....	31
Setting the Dim Timer for the backlight	31
Setting the Off Timer	31
Setting the Wallpaper	32

4 Security features

TX Lock (MFC-440CN only)	33
Setting and changing the TX Lock password	33
Turning the TX Lock on/off	34
Memory Security (MFC-665CW and MFC-845CW only).....	34
Setting and changing the memory security password	35
Turning the memory security on/off	36

Section II Fax

5 Sending a fax

Entering Fax mode	38
Faxing from the ADF	38
Faxing from the scanner glass	39
Faxing A4 size documents from the scanner glass	39
Color fax transmission	39
Canceling a fax in progress	39
Broadcasting (Black & White only)	40
Canceling a Broadcast in progress.....	40
Additional sending operations.....	41
Sending faxes using multiple settings	41
Contrast	41
Changing fax resolution	41
Dual access (Black & White only).....	42
Real time transmission	42
Overseas Mode	43
Delayed Faxing (Black & White only)	43
Delayed Batch Transmission (Black & White only)	43
Checking and canceling waiting jobs.....	43
Setting your changes as a new default.....	44
Restoring all the settings to factory settings	44
Sending a fax manually	44
Sending a fax at the end of a conversation (MFC-440CN and MFC-665CW only)	44
Out of Memory message	45

6 Receiving a Fax

Receive modes	46
Choosing the Receive Mode	46
Using receive modes	48
Fax only	48
Fax/Tel	48
Manual	48
Message Center (MC) (MFC-665CW and MFC-845CW only)	48
External TAD (MFC-440CN only)	48
Receive mode settings	49
Ring Delay	49
F/T Ring Time (Fax/Tel mode only)	49
Easy Receive	50
Additional receiving operations	51
Printing a reduced incoming fax	51
Receiving a fax at the end of a conversation (MFC-440CN and MFC-665CW only)	51
Printing a fax from the memory	51

7 Telephone Services and External devices

Voice operations	52
Making a telephone call (MFC-665CW and MFC-845CW only)	52
Answering calls with the Speaker Phone (MFC-665CW and MFC-845CW only)	52
Hold (MFC-665CW and MFC-845CW only)	52
Tone or Pulse (Canada only)	53
Fax/Tel mode when the power key is on	53
Fax/Tel mode when the power key is off	53
Telephone services	54
Distinctive Ring	54
Caller ID	56
Connecting an external TAD (telephone answering device)	57
Connections	58
Recording outgoing message (OGM) on an external TAD	59
Special line considerations	59
Multi-line connections (PBX)	61
External and extension phones	61
Connecting an external or extension telephone	61
Using external and extension telephones	61
Using a Non-Brother cordless external telephone (MFC-440CN and MFC-665CW only)	62
Using remote codes	62

8 Dialing and storing numbers

How to Dial	63
Manual dialing	63
Speed-Dialing	63
Search	63
Fax Redial	64
Outgoing Call	64
Caller ID history	65

Storing numbers	66
Storing a pause	66
Storing Speed-Dial numbers	66
Changing Speed-Dial names or numbers	67
Setting up groups for broadcasting.....	68
Dialing Access codes and credit card numbers.....	70

9 Message Center (MFC-665CW and MFC-845CW only)

Message Center mode	71
Setting up the Message Center	71
Outgoing message (OGM)	71
Fax/Tel OGM (Announcement)	72
Activating Message Center mode.....	72
Managing your messages.....	73
Message indicator	73
Playing voice messages	73
Erasing incoming messages.....	73
Additional Message Center operations.....	74
Setting maximum time for incoming messages	74
Setting toll saver	74
ICM Recording Monitor.....	75
Recording a conversation (MFC-665CW only).....	75

10 Advanced fax operations (Black & White only)

Fax Forwarding.....	76
Paging	77
Fax Storage	78
Fax Preview (MFC-665CW and MFC-845CW only).....	78
Setting Fax Preview.....	78
How to preview a fax	79
How to delete all faxes in the list	79
How to print all faxes in the list	79
PC Fax Receive.....	80
Changing the destination PC.....	81
Turning off Advanced Fax Operations.....	81
Changing Advanced Fax Operations.....	82
Remote Retrieval.....	82
Setting a Remote Access Code.....	82
Using your Remote Access Code.....	83
Remote Fax commands	84
Retrieving fax messages	86
Changing your Fax Forwarding number	86

11 Printing Reports

Fax reports.....	87
Transmission Verification Report.....	87
Fax Journal (activity report).....	87
Reports	88
How to print a report.....	88

12 Polling

Polling overview	89
Polling receive	89
Setup to receive polling	89
Sequential polling (Black & White only)	89
Polled transmit (Black & White only).....	90
Set up for polled transmit.....	90

Section III Copy

13 Making copies

How to copy	92
Entering Copy mode	92
Making a single copy	92
Making multiple copies	93
Stop copying.....	93
Copy settings	93
Changing copy quality	93
Enlarging or reducing the image copied	94
Making N in 1 copies or a poster (page layout)	94
Sorting copies using the ADF	95
Adjusting Brightness, Contrast and Color.....	96
Paper Options.....	97
Setting your changes as new default.....	97
Restoring all the settings to factory settings	97
‘Out of Memory’ message.....	98

Section IV Walk-up Photo Printing

14 PhotoCapture Center®

PhotoCapture Center® Operations	100
Printing from a media card without a PC	100
Scanning to a media card without a PC	100
Using PhotoCapture Center® from your computer	100
Using media cards.....	100
Media card folder structure	100
Getting started	101
Entering PhotoCapture mode	102
Print Images.....	102
View Photo(s)	102
Print Index (Thumbnails)	103
Print All Photos	103
Print Photos	104
DPOF printing.....	104
PhotoCapture Center® print settings	105
Print Quality	106
Paper options	106

Adjusting Brightness, Contrast and Color	106
Cropping	108
Borderless printing.....	108
Setting your changes as new default.....	108
Restoring all the settings to factory settings	108
Scan to Card	109
Entering Scan mode	109
How to scan to card	109
Understanding the Error Messages	110

15 PictBridge

Before Using PictBridge.....	111
PictBridge requirements	111
Using PictBridge	111
Setting your digital camera	111
Printing Images.....	112
DPOF printing.....	112
Understanding the Error Messages	113

Section V Software

16 Software and Network features

Section VI Appendixes

A Safety and Legal

Choosing a location	118
To use the machine safely.....	119
Important safety instructions.....	123
Standard telephone and FCC Notices (These notices are in effect on models sold and used in the United States only.).....	125
Federal Communications Commission (FCC) Declaration of Conformity (USA only)	126
Industry Canada Compliance Statement (Canada only)	127
LAN connection	127
Legal limitations for copying	128
Trademarks	129

B Troubleshooting and Routine Maintenance

Troubleshooting	130
If you are having difficulty with your machine	130
Error messages	136
Transferring your faxes or Fax Journal report	139
Document jam	140
Printer jam or paper jam	141
Dial Tone	142

Phone line interference.....	143
Routine maintenance.....	143
Replacing the ink cartridges.....	143
Cleaning the outside of the machine.....	145
Cleaning the scanner.....	146
Cleaning the machine printer platen.....	147
Cleaning the paper pick-up roller.....	147
Cleaning the print head.....	148
Checking the print quality.....	148
Checking the printing alignment.....	149
Checking the ink volume.....	150
Uninstalling and installing the handset and handset cradle (MFC-665CW only).....	150
Uninstalling and installing the cradle and the bracket (MFC-845CW only).....	152
Machine Information.....	154
Checking the serial number.....	154
Packing and shipping the machine.....	154

C Menu and Features

On-screen programming.....	158
Memory storage.....	158
Menu keys.....	158
Menu table.....	159
Entering Text.....	174

D Specifications

General.....	175
Print media.....	177
Fax.....	178
Message Center (MFC-665CW and MFC-845CW only).....	180
Digital Cordless Handset (MFC-845CW only).....	181
Cordless handset.....	181
Battery.....	181
Battery cradle.....	182
AC adapter.....	182
Copy.....	183
PhotoCapture Center®.....	184
PictBridge.....	184
Scanner.....	185
Printer.....	186
Interfaces.....	187
Computer requirements.....	188
Consumable items.....	189
Network (LAN).....	190

E Glossary

F Index



General

General Information	2
Loading documents and paper	11
General setup	24
Security features	33

Using the documentation

Thank you for buying a Brother machine! Reading the documentation will help you make the most of your machine.

Symbols and conventions used in the documentation

The following symbols and conventions are used throughout the documentation.

Bold Bold typeface identifies specific keys on the machine's control panel.

Italics Italicized typeface emphasizes an important point or refers you to a related topic.

`Courier New` Text in the Courier New font identifies messages on the LCD of the machine.



Warnings tell you what to do to prevent possible personal injury.



Electrical Hazard icons alert you to possible electrical shock.



Cautions specify procedures you must follow or avoid to prevent possible damage to the machine or other objects.



Notes tell you how you should respond to a situation that may arise or give tips about how the operation works with other features.



Improper Setup icons alert you to devices and operations that are not compatible with the machine.

Accessing the Software User's Guide and Network User's Guide

This User's Guide does not contain all the information about the machine such as how to use the advanced features of the Fax, Printer, Scanner, PC Fax and Network. When you are ready to learn detailed information about these operations, read the **Software User's Guide** and **Network User's Guide** that are on the CD-ROM.

Viewing Documentation

Viewing Documentation (For Windows®)

To view the documentation, from the **Start** menu, point to **Brother, MFC-XXXX** (where XXXX is your model name) from the programs group, and then choose **User's Guide**.

If you have not installed the software, you can find the documentation by following the instructions below:

- 1 Turn on your PC. Insert the Brother CD-ROM into your CD-ROM drive.
- 2 If the model name screen appears, click your model name.

- 3 If the language screen appears, click your language. The CD-ROM main menu will appear.

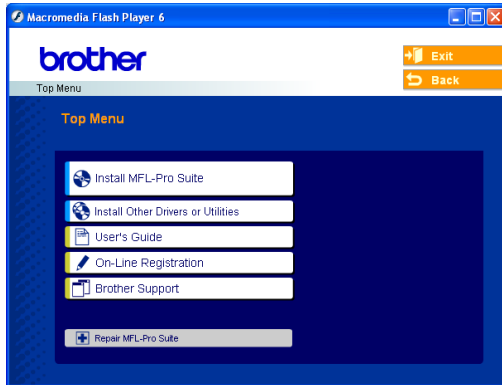

Note

If this window does not appear, use Windows® Explorer to run the setup.exe program from the root directory of the Brother CD-ROM.

- 4 Click **User's Guide** to view the **Software User's Guide** and **Network User's Guide** in HTML format.

How to find Scanning instructions

There are several ways you can scan documents. You can find the instructions as follows:

Software User's Guide

- **Scanning**
(For Windows® 98/98SE/Me/2000 Professional and Windows® XP)
- **ControlCenter3**
(For Windows® 98/98SE/Me/2000 Professional and Windows® XP)
- **Network Scanning**

PaperPort® SE with OCR User's Guide

- The complete ScanSoft® PaperPort® SE with OCR User's Guide can be viewed from the Help selection in the ScanSoft® PaperPort® SE with OCR application.

How to find Network setup instructions (MFC-665CW and MFC-845CW only)

Your machine can be connected to a wireless or wired network. You can find basic setup instructions in the Quick Setup Guide. For more information, or if your access point supports SecureEasySetup™, please see the Network User's Guide on the CD-ROM.

Viewing Documentation (For Macintosh®)

- 1 Turn on your Macintosh®. Insert the Brother CD-ROM into your CD-ROM drive. The following window will appear.



- 2 Double-click the **Documentation** icon.
- 3 Double-click your language folder.
- 4 Double-click the top page file to view the **Software User's Guide** and **Network User's Guide** in HTML format.
- 5 Click the documentation you want to read:
 - **Software User's Guide**
 - **Network User's Guide**

How to find Scanning instructions

There are several ways you can scan documents. You can find the instructions as follows:

Software User's Guide

- *Scanning*
(For Mac OS® X 10.2.4 or greater)
- *ControlCenter2*
(For Mac OS® X 10.2.4 or greater)
- *Network Scanning*
(For Mac OS® X 10.2.4 or greater)

Presto!® PageManager® User's Guide

- The complete Presto!® PageManager® User's Guide can be viewed from the Help selection in the Presto!® PageManager® application.

How to find Network setup instructions (MFC-665CW and MFC-845CW only)

Your machine can be connected to a wireless or wired network. You can find basic setup instructions in the Quick Setup Guide. For more information, or if your access point supports SecureEasySetup™, please see the Network User's Guide on the CD-ROM.

Accessing Brother Support (For Windows®)

You can find all the contacts you will need, such as Web support (Brother Solutions Center), Customer Service and Brother Authorized Service Centers on page i and on the Brother CD-ROM.

- Click **Brother Support** on the main menu. The following screen will appear:

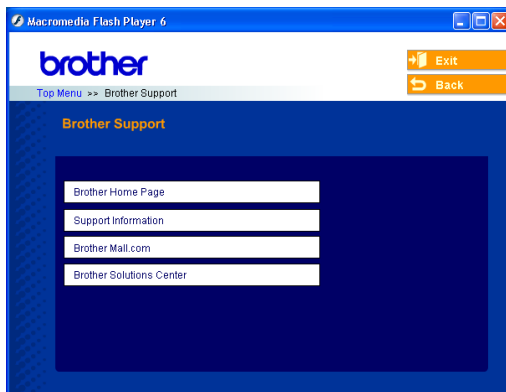

- To access our web site (www.brother.com), click **Brother Home Page**.
- To view all Brother Numbers, including Customer Service numbers for the USA and Canada, click **Support Information**.
- To access the USA Brother online shopping mall (www.brothermall.com) for additional product and services information, click **Brother Mall.com**.
- For the latest news and product support information (<http://solutions.brother.com>), click **Brother Solutions Center**.
- To return to the main page, click **Back** or If you have finished, click **Exit**.

Control panel overview

MFC-440CN

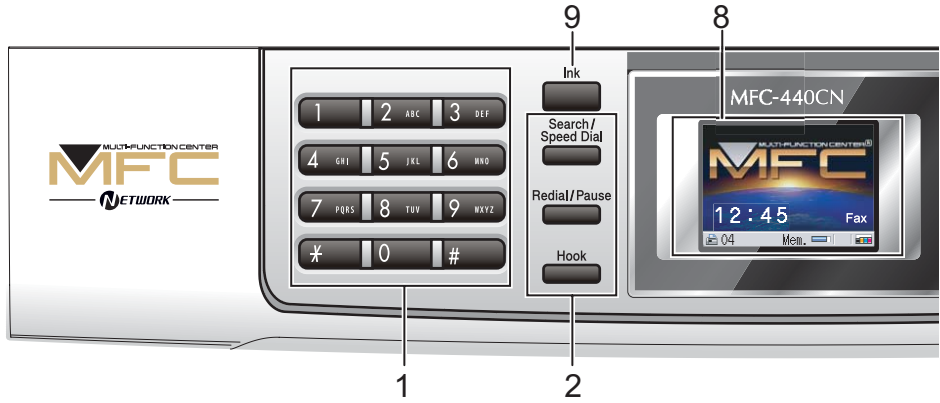

MFC-665CW

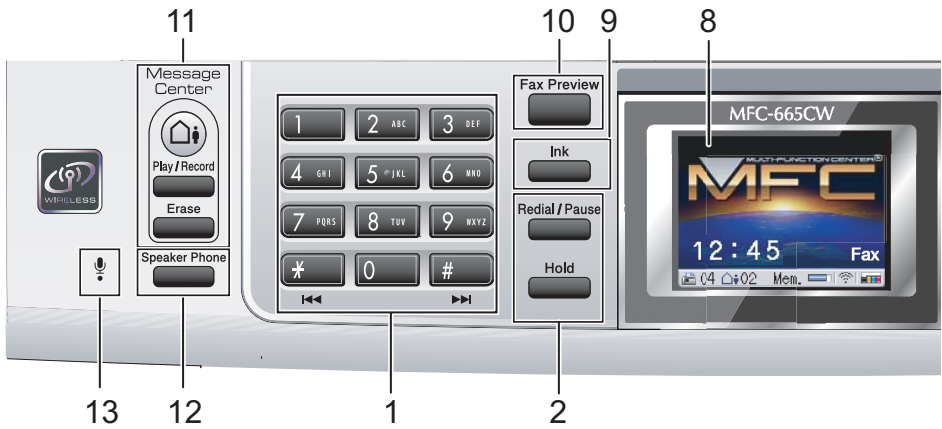

MFC-845CW

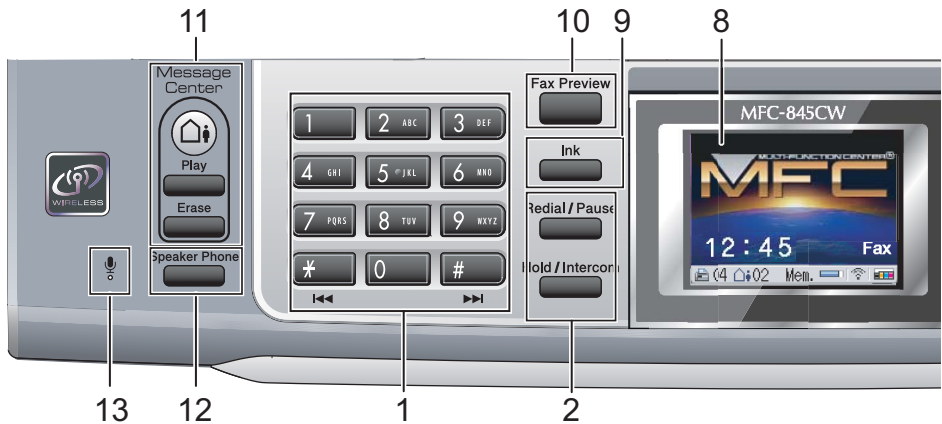

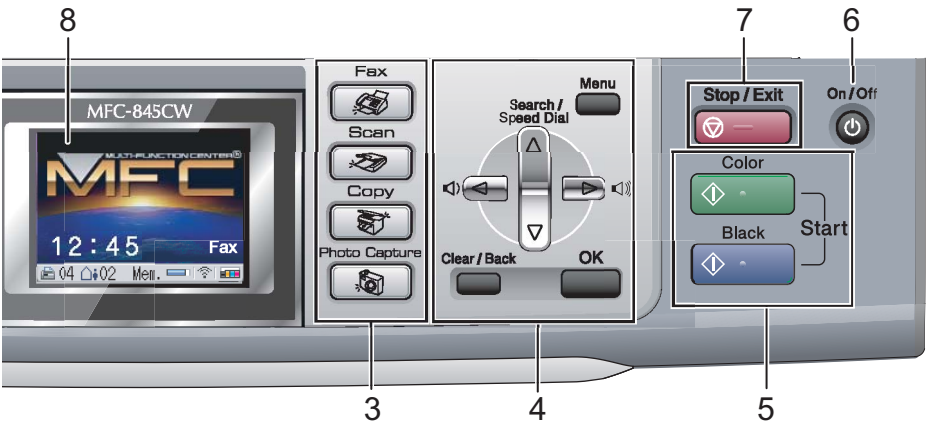
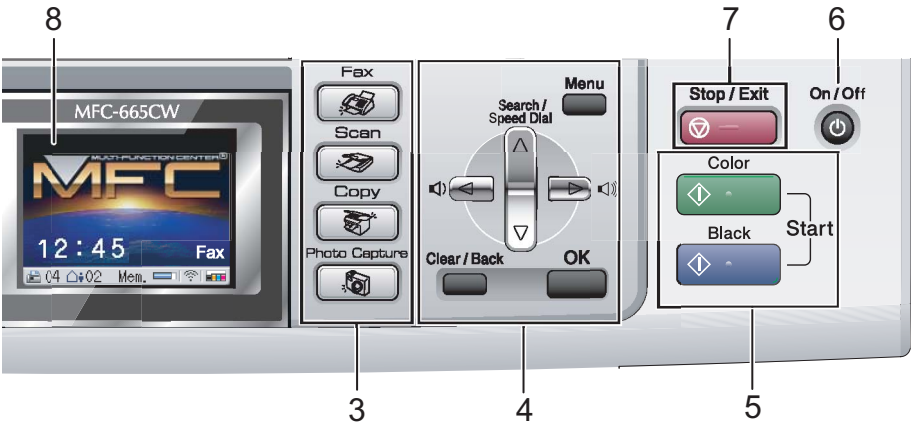
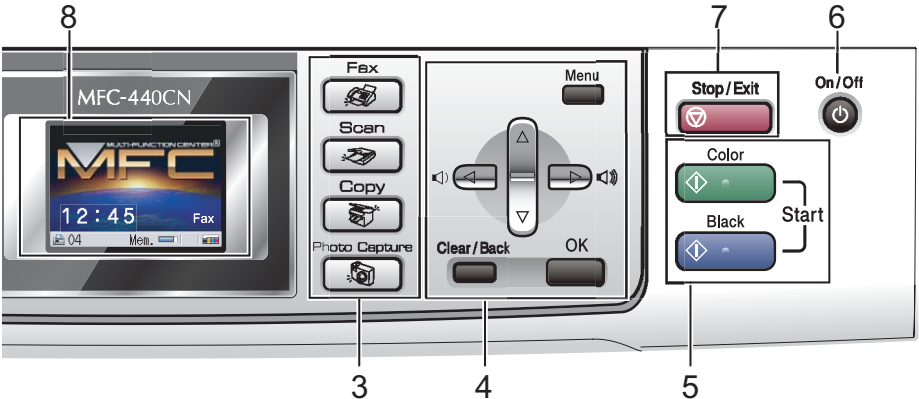

**Note**

Most of the illustrations in this User's Guide show the MFC-440CN.

1 Dial Pad



Use these keys to dial telephone and fax numbers and as a keyboard for entering information into the machine.

(Canada only) The # key lets you temporarily switch the dialing mode during a telephone call from Pulse to Tone.

2 Fax and telephone keys

- **Search/Speed Dial** (MFC-440CN)
Lets you look up and dial numbers that are stored in the memory.
- **Redial/Pause**
Redials the last 30 numbers called. It also inserts a pause when programming quick dial numbers.
- **Hook** (MFC-440CN)
Press before dialing if you want to make sure a fax machine will answer, and then press **Black Start** or **Color Start**.
Also, press this key after picking up the handset of an external telephone during the F/T double/pseudo-ring.
- **Hold** (MFC-665CW)
Lets you place telephone calls on hold.
- **Hold/Intercom** (MFC-845CW)
Lets you place telephone calls on hold.
Also, press this key to speak on the intercom or to transfer an incoming call to the cordless handset.



3 Mode keys:

-  **Fax**
Lets you access Fax mode.
-  **Scan**
Lets you access Scan mode.
-  **Copy**
Lets you access Copy mode.
-  **PhotoCapture**
Lets you access PhotoCapture Center® mode.

4 Menu keys:

- **Volume keys**

In Fax mode, you can press these keys to adjust the ring volume.
- **▲ Search/Speed Dial** (MFC-665CW and MFC-845CW)
Lets you look up and dial numbers that are stored in the memory.
- **◀ or ▶**
Press to scroll backward or forward to a menu selection.
- **▲ or ▼**
Press to scroll through the menus and options.
- **Menu**
Access the main menu.
- **OK**
Selects a setting.
- **Clear/Back**
Press to cancel the current setting.

5 Start keys:

-  **Color Start**
Lets you start sending faxes or making copies in full color. Also lets you start a scanning operation (in color or black & white, depending on the scanning setting in the ControlCenter software).
-  **Black Start**
Lets you start sending faxes or making copies in black & white. Also lets you start a scanning operation (in color or black & white depending on the scanning setting in the ControlCenter software).

6 On/Off

You can turn the machine on or off.

7  Stop/Exit

Stops an operation or exits from a menu.

8 LCD (liquid crystal display)

Displays messages on the screen to help you set up and use your machine.

Also, you can adjust the angle of the LCD display by lifting it.

9 Ink

Lets you clean the print head, check the print quality, and check the available ink volume.

10 Fax Preview (MFC-665CW and MFC-845CW)

Lets you preview incoming faxes on the LCD.

11 Message Center keys (MFC-665CW and MFC-845CW only):

■ **MC On/Off**

Turns the Message Center on or off. Will also flash if you have new messages.

■ **Play/Record (MFC-665CW)**

Plays voice messages stored in the memory. Will also let you record telephone calls.

■ **Play (MFC-845CW)**

Plays voice messages stored in memory.

■ **Erase**

Deletes voice messages.

12 Speaker Phone (MFC-665CW and MFC-845CW)

Turns the speaker phone on or off.

13 Microphone (MFC-665CW and MFC-845CW)

Picks up your voice when you speak to another party using **Speaker Phone**.

LCD display screen

The LCD shows the current machine status when the machine is idle.

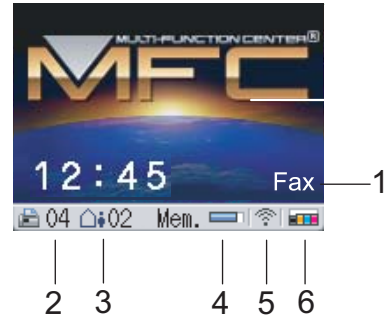
**1 Current Receive Mode**

Lets you see the current receive mode.

- Fax (Fax only)
- F/T (Fax/Tel)
- TAD (External TAD) (MFC-440CN)
- MC (Msg Ctr) (MFC-665CW and MFC-845CW)
- Mnl (Manual)

2 Fax in the machine's memory

Shows how many received faxes are in the memory.

3 Voice message in the machine's memory. (MFC-665CW and MFC-845CW)

Shows how many received voice messages are in the memory.

4 Memory Status

Lets you see the available memory in the machine.

5 Wireless Status (MFC-665CW and MFC-845CW)

A four level indicator shows the current wireless signal strength if you are using a wireless connection.



0

Max

6 Ink indicator

Lets you see the available ink volume.

Basic Operations

The following steps show how to change a setting in the machine. In this example the Mode Timer setting is changed from 2 minutes to 30 seconds.

- 1 Press **Menu**.
- 2 Press **▲** or **▼** to choose **General Setup**.

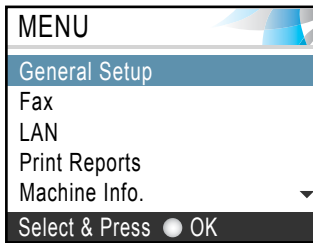

- 3 Press **OK**.
- 4 Press **▲** or **▼** to choose **Mode Timer**.

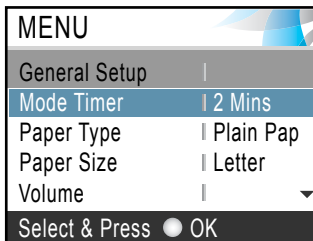

- 5 Press **OK**.
- 6 Press **▲** or **▼** to choose **30 Secs**.

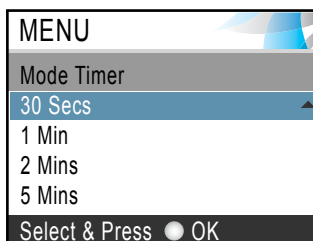

- 7 Press **OK**.
You can see the current setting on the LCD:

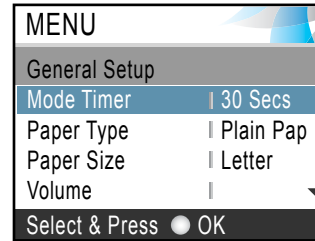

- 8 Press **Stop/Exit**.

2

Loading documents and paper

Loading documents

You can send a fax, make copies, and scan from the ADF (automatic document feeder) and from the scanner glass.

Using the ADF

The ADF can hold up to 10 pages and feeds each sheet individually. Use standard 20 lb (80 g/m²) paper and always fan the pages before putting them in the ADF.

Recommended environment

Temperature:	68 to 86° F (20 to 30° C)
Humidity:	50% to 70%
Paper:	20 lb LTR (80 g/m ² A4)

Document Sizes Supported

Length:	5.8 to 14 in. (148 to 355.6 mm)
Width:	5.8 to 8.5 in. (148 to 215.9 mm)
Weight:	17 to 24 lb (64 to 90 g/m ²)

How to load documents

! CAUTION

DO NOT pull on the document while it is feeding.

DO NOT use paper that is curled, wrinkled, folded, ripped, stapled, paper clipped, pasted or taped.

DO NOT use cardboard, newspaper or fabric.

■ Make sure documents written with ink are completely dry.

- 1 Fan the pages well. Make sure you put the documents **face down, top edge first** in the ADF until you feel them touch the feed roller.
- 2 Adjust the paper guides to fit the width of your documents.
- 3 Unfold the ADF Document Output Support Flap (1).

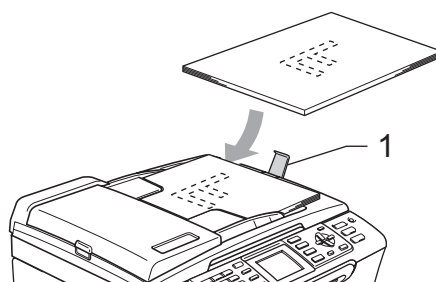

! CAUTION

DO NOT leave thick documents on the scanner glass. If you do this, the ADF may jam.

Using the scanner glass

You can use the scanner glass to fax, copy or scan pages of a book or one page at a time.

Document Sizes Supported

Length:	Up to 11.7 in. (297 mm)
Width:	Up to 8.5 in. (215.9 mm)
Weight:	Up to 4.4 lb (2 kg)

How to load documents



Note

To use the scanner glass, the ADF must be empty.

- 1 Lift the document cover.
- 2 Using the document guidelines on the left, center the document face down on the scanner glass.

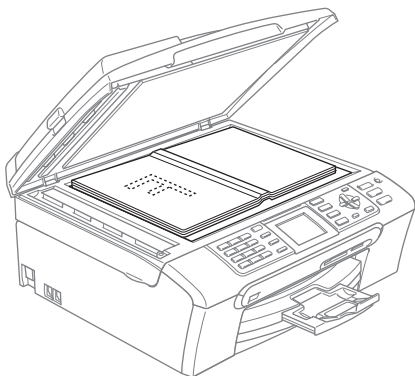
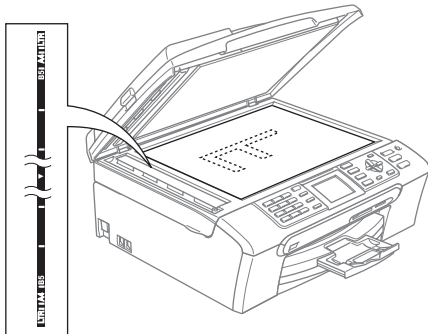

- 3 Close the document cover.

! CAUTION

If you are scanning a book or thick document, **DO NOT** slam the cover down or press on it.

Scannable area

The scannable area depends on the settings in the application you are using. The figures below show the areas you cannot scan on paper.

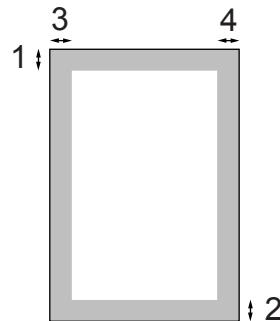

Usage	Document Size	Top (1) Bottom (2)	Left (3) Right (4)
Fax	Letter	0.12 in. (3 mm)	0.16 in. (4 mm)
	A4	0.12 in. (3 mm)	0.04 in. (1 mm)
Copy	Letter	0.12 in. (3 mm)	0.12 in. (3 mm)
	A4	0.12 in. (3 mm)	0.12 in. (3 mm)
Scan	Letter	0.12 in. (3 mm)	0.12 in. (3 mm)
	A4	0.12 in. (3 mm)	0 in. (0 mm)

Acceptable paper and other media

The print quality can be affected by the type of paper you are using in the machine.

To get the best print quality for the settings you have chosen, always set the Paper Type to match the type of paper you load.

You can use plain paper, inkjet paper (coated paper), glossy paper, transparencies and envelopes.

We recommend testing various paper types before buying large quantities.

For best results, use Brother paper.

- When you print on inkjet paper (coated paper), transparencies and photo paper, be sure to choose the proper media in the **'Basic'** tab of the printer driver or in the Paper Type setting of the menu (See *Paper Type* on page 26).
- When you print on Brother photo paper, load the instruction sheet included with the photo paper in the paper tray first, and then put the photo paper on top of the instruction sheet.
- When you use transparencies or photo paper, remove each sheet at once to prevent smudging or paper jams.
- Avoid touching the printed surface of the paper immediately after printing; the surface may not be completely dry and may stain your fingers.

Recommended media

To get the best print quality, we suggest using Brother paper. (See table below.)

We recommend using '3M Transparency Film' when you print on transparencies.

Brother paper

Paper Type	Item
Letter Plain	BP60PL (USA only)
Letter Glossy Photo	BP61GLL ¹
Letter Inkjet (Matte)	BP60ML (USA only)
4 × 6 in. Glossy Photo	BP61GLP ¹

¹ Available in the USA and from November 2006 in Canada.

Handling and using media

- Store paper in its original packaging, and keep it sealed. Keep the paper flat and away from moisture, direct sunlight and heat.
- The coated side of photo paper is shiny. Avoid touching the shiny (coated) side. Load photo paper with the shiny side facing down.
- Avoid touching either side of transparencies because they absorb water and perspiration easily, and this may cause decreased output quality. Transparencies designed for laser printers/copiers may stain your next document. Use only transparencies recommended for inkjet printing.

Improper Setup

DO NOT use the following kinds of paper:

- Damaged, curled, wrinkled, or irregularly shaped paper

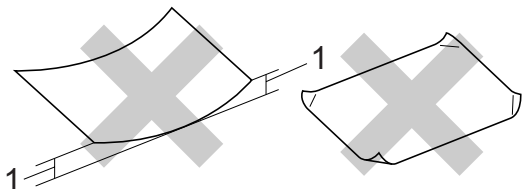

1 0.08 in. (2 mm) or longer

- Extremely shiny or highly textured paper
- Paper already printed on by a printer
- Paper that cannot be arranged uniformly when stacked
- Paper made with a short grain

Paper capacity of the output paper tray

Up to 50 sheets of 20 lb Letter or 80 g/m² A4 paper.

- Transparencies or photo paper must be picked up from the output paper tray one page at a time to avoid smudging.

Choosing the right media

Paper type and size for each operation

Paper Type	Paper Size		Usage			
			Fax	Copy	Photo Capture	Printer
Cut Sheet	Letter	8 1/2 × 11 in. (216 × 279 mm)	Yes	Yes	Yes	Yes
	A4	8.3 × 11.7 in. (210 × 297 mm)	Yes	Yes	Yes	Yes
	Legal	8 1/2 × 14 in. (216 × 356 mm)	Yes	Yes	–	Yes
	Executive	7 1/4 × 10 1/2 in. (184 × 267 mm)	–	–	–	Yes
	JIS B5	7.2 × 10.1 in. (182 × 257 mm)	–	–	–	Yes
	A5	5.8 × 8.3 in. (148 × 210 mm)	–	Yes	–	Yes
	A6	4.1 × 5.8 in. (105 × 148 mm)	–	–	–	Yes
Cards	Photo	4 × 6 in. (10 × 15 cm)	–	Yes	Yes	Yes
	Photo L	3 1/2 × 5 in. (89 × 127 mm)	–	–	–	Yes
	Photo 2L	5 × 7 in. (13 × 18 cm)	–	–	Yes	Yes
	Index Card	5 × 8 in. (127 × 203 mm)	–	–	–	Yes
	Post Card 1	3.9 × 5.8 in. (100 × 148 mm)	–	–	–	Yes
	Post Card 2 (Double)	5.8 × 7.9 in. (148 × 200 mm)	–	–	–	Yes
Envelopes	C5 Envelope	6.4 × 9 in. (162 × 229 mm)	–	–	–	Yes
	DL Envelope	4.3 × 8.7 in. (110 × 220 mm)	–	–	–	Yes
	COM-10	4 1/8 × 9 1/2 in. (105 × 241 mm)	–	–	–	Yes
	Monarch	3 7/8 × 7 1/2 in. (98 × 191 mm)	–	–	–	Yes
	JE4 Envelope	4.1 × 9.3 in. (105 × 235 mm)	–	–	–	Yes
	Transparencies	Letter	8 1/2 × 11 in. (216 × 279 mm)	–	Yes	–
A4		8.3 × 11.7 in. (210 × 297 mm)	–	Yes	–	Yes

Paper weight, thickness and capacity

Paper Type		Weight	Thickness	No. of sheets
Cut Sheet	Plain Paper	17 to 32 lb (64 to 120 g/m ²)	0.003 to 0.006 in. (0.08 to 0.15 mm)	100 ¹
	Inkjet Paper	17 to 53 lb (64 to 200 g/m ²)	0.003 to 0.01 in. (0.08 to 0.25 mm)	20
	Glossy Paper	Up to 58 lb (Up to 220 g/m ²)	Up to 0.01 in. (Up to 0.25 mm)	20
Cards	Photo 4"×6"	Up to 64 lb (Up to 240 g/m ²)	Up to 0.01 in. (Up to 0.28 mm)	20 ²
	Index Card	Up to 32 lb (Up to 120 g/m ²)	Up to 0.006 in. (Up to 0.15 mm)	30
	Post Card	Up to 53 lb (Up to 200 g/m ²)	Up to 0.01 in. (Up to 0.23 mm)	30
Envelopes		20 to 25 lb (75 to 95 g/m ²)	Up to 0.02 in. (Up to 0.52 mm)	10
Transparencies		–	–	10

¹ Up to 50 sheets for Legal size paper 20 lb (80 g/m²).
Up to 100 sheets of 20 lb (80 g/m²) paper.

² For Photo 4"×6" and Photo L 3.5"×5" paper, use the photo bypass tray (in USA) or the photo paper tray (in Canada). (See *Loading photo paper* on page 21.)

Loading paper and other media



Note

To print on Photo (4"×6") or Photo L (3.5"×5") paper, see *Loading photo paper* on page 21.

- 1 If the paper support flap is open, close it, and then pull the paper tray completely out of the machine. Lift the output paper tray cover (1).

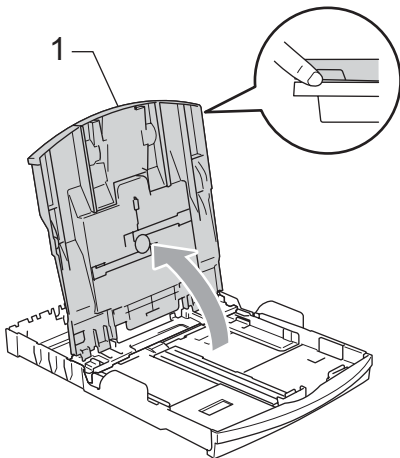
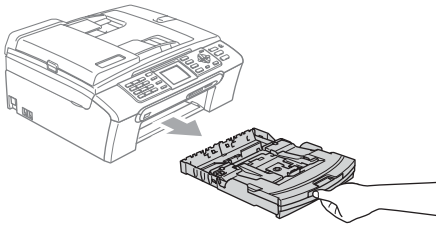

- 2 Press and slide the paper side guides (1) and paper length guide (2) to fit the paper size.

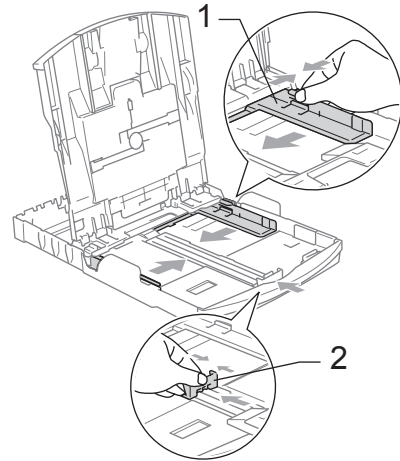

- 3 Fan the stack of paper well to avoid paper jams and misfeeds.

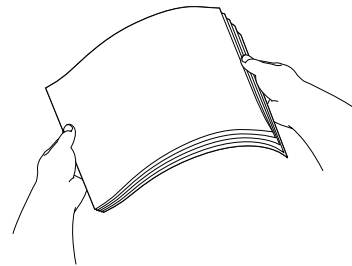

Note

Always make sure that the paper is not curled.

- 4 Gently put the paper into the paper tray print side down and top edge first. Check that the paper is flat in the tray.

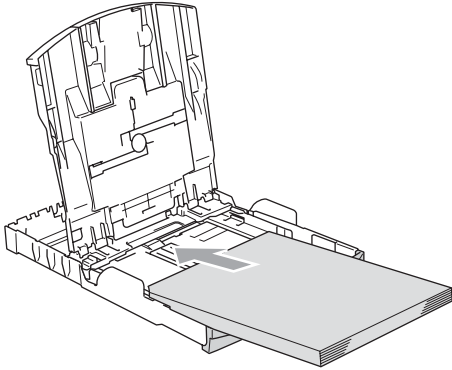

 **Note**

When you use Legal size paper, press and hold the universal guide release button as you slide out the front of the paper tray.

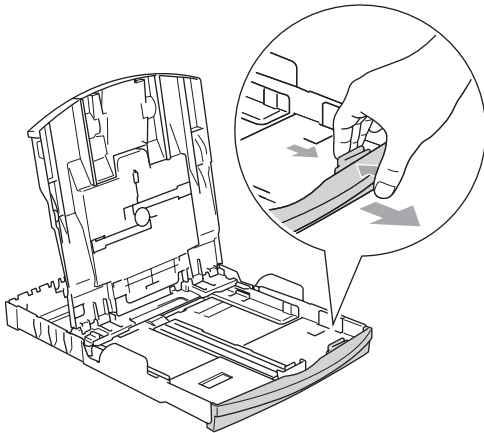

- 5 Gently adjust the paper side guides with both hands to the paper. Make sure the paper side guides touch the sides of the paper.

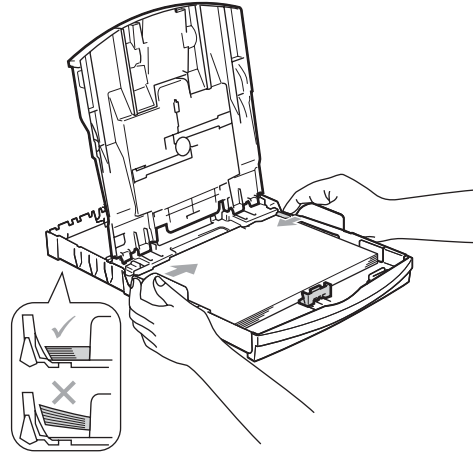

 **Note**

Be careful that you do not push the paper in too far; it may lift at the back of the tray and cause feed problems.

- 6 Close the output paper tray cover.

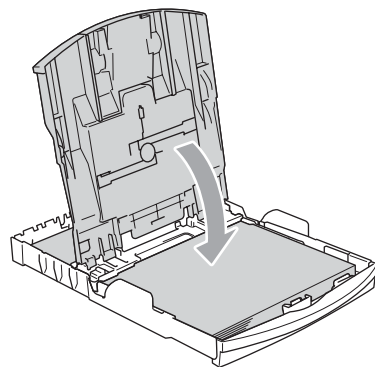

- 7 Slowly push the paper tray completely into the machine.

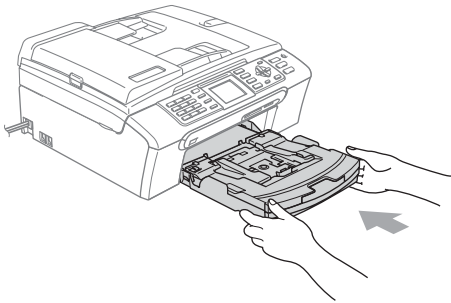

- 8 While holding the paper tray in place, pull out the paper support (1) until it clicks and unfold the paper support flap (2).

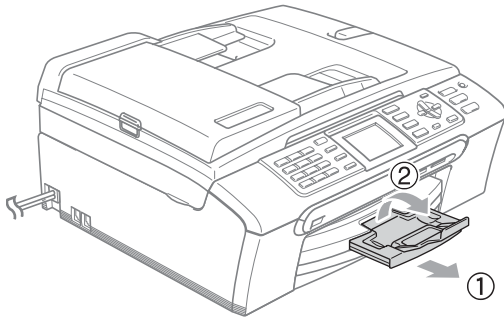

Note

Do not use the paper support flap for Legal paper.

Loading envelopes and post cards



About envelopes

- Use envelopes that weigh from 20 to 25 lb (75 to 95 g/m²).
- Some envelopes need margin settings to be set in the application. Make sure you do a test print first.

! CAUTION

Do not use any of the following types of envelopes, as they will cause paper feed problems:

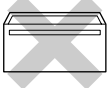
- That are of a baggy construction.
- That are embossed (have raised writing on them).
- That have clasps or staples.
- That are pre-printed on the inside.

Glue	Double flap
	

Occasionally you may experience paper feed problems caused by the thickness, size and flap shape of the envelopes you are using.

How to load envelopes and post cards

- 1 Before loading, press the corners and sides of the envelopes or post cards to make them as flat as possible.



Note

If the envelopes or post cards are 'double-feeding', put one envelope in the paper tray at a time.

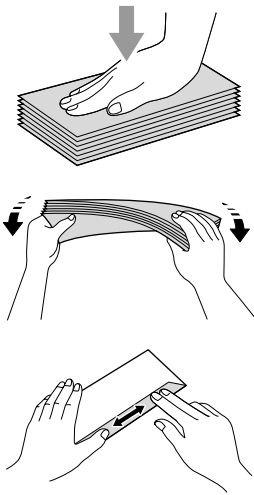

- 2 Put the envelopes or post cards into the paper tray with the address side down and the leading edge in first as shown in the illustration. Slide the paper side guides (1) and paper length guide (2) to fit the size of the envelopes or post cards.

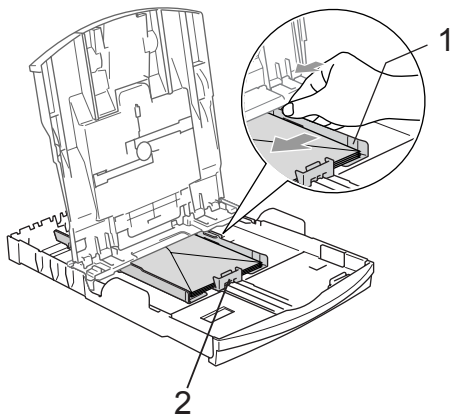

If you have problems when printing on envelopes, try the following suggestions:

- 1 Open the envelope flap.
- 2 Make sure the open flap is either to the side of the envelope or to the back edge of the envelope when printing.
- 3 Adjust the size and margin in your application.

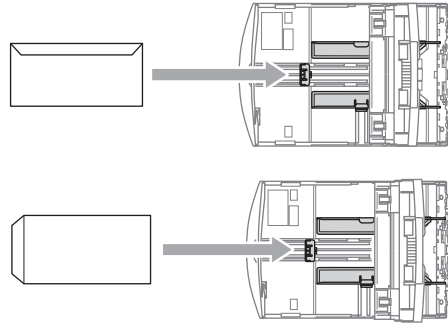

Loading photo paper



Note

In Canada, the **photo bypass tray** is called the **photo paper tray**.

Use the photo bypass tray, which has been assembled on the top of the output paper tray cover, to print on photo 4"×6" and photo L 3.5"×5" size paper. When you use the photo bypass tray, you do not have to take out the paper that is in the tray beneath it.

- 1 Press the photo bypass tray (1) release button with your left thumb and push the photo bypass tray backward until it clicks into the photo printing position.

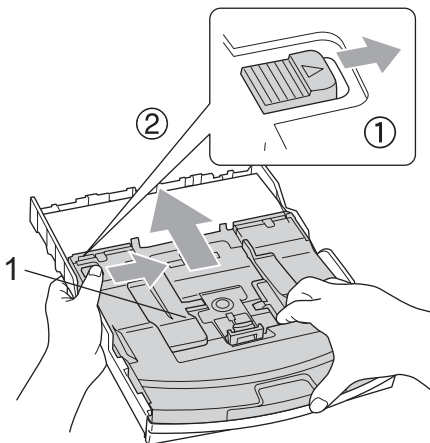

1 Photo Bypass Tray

- 2 Press and slide the paper side guides (1) and paper length guide (2) to fit the paper size.

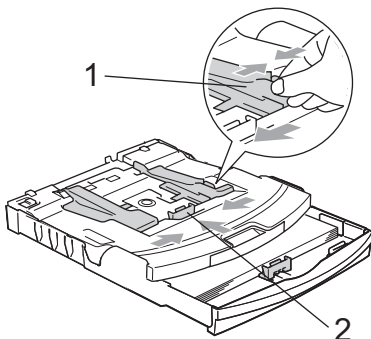

- 3 Put the photo paper into the photo bypass tray and gently adjust the paper side guides to the paper. Make sure the paper side guides touch the sides of the paper.

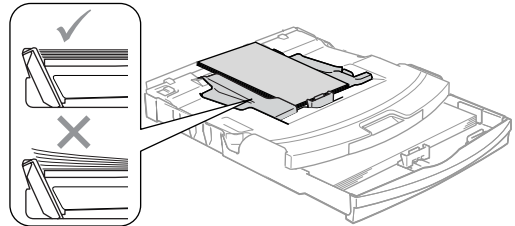

Note

- Be careful that you do not push the paper in too far; it may lift at the back of the tray and cause feed problems.
- Always make sure that the paper is not curled.

- 4 When you have finished printing photos return the photo bypass tray to the normal printing position. Press the photo bypass tray release button with your left thumb and pull the photo bypass tray forward until it clicks.

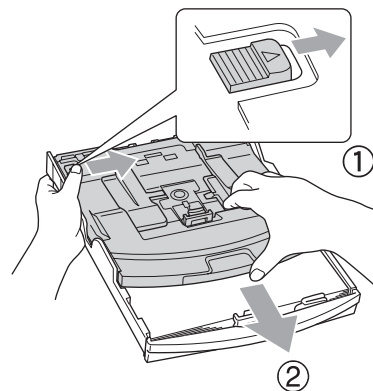

Removing small printouts from the machine

When the machine ejects small paper onto the output paper tray you may not be able to reach it. Make sure printing has finished, and then pull the tray completely out of the machine.

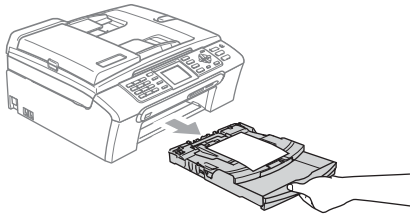

Printable area

The printable area depends on the settings in the application you are using. The figures below show the unprintable areas on cut sheet paper and envelopes. The machine can only print in the shaded areas when the Borderless print feature is available and turned on.

Cut Sheet Paper

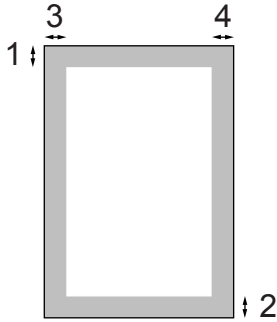

Envelopes

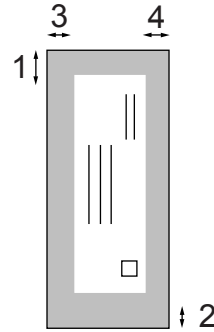

	Top (1)	Bottom (2)	Left (3)	Right (4)
Cut Sheet	0.12 in. (3 mm)	0.12 in. (3 mm)	0.12 in. (3 mm)	0.12 in. (3 mm)
Envelopes	0.47 in. (12 mm)	0.95 in. (24 mm)	0.12 in. (3 mm)	0.12 in. (3 mm)



Note

The Borderless feature is not available for envelopes.

3

General setup

On/Off key

When the machine is idle, you can turn it on and off by pressing the **On/Off** key.



Note

If you have connected an external telephone or TAD, it is always available.

Turning the machine off

- 1 Press and hold down the **On/Off** key until the LCD shows *Shutting Down*. The LCD light goes off.

Turning the machine on

- 1 Press the **On/Off** key.

On/Off setting

You can customize the machine's **On/Off** key. The factory setting is *Fax Receive:Off*. Your machine will not work when it is switched off, but it will clean the print head periodically. If you turn this setting to *Fax Receive:On*, you can receive faxes or calls even when the machine is switched off. (See *On/Off key* on this page.)

- 1 Press **Menu**.
- 2 Press **▲** or **▼** to choose *General Setup*. Press **OK**.
- 3 Press **▲** or **▼** to choose *On/Off Setting*. Press **OK**.
- 4 Press **▲** or **▼** to choose *Fax Receive:On* (or *Fax Receive:Off*). Press **OK**.
- 5 Press **Stop/Exit**.

MFC-440CN

On/Off setting	Receive mode	Available operations
Fax Receive: Off (factory setting)	—	No machine operations will be available.
Fax Receive: On ¹	Fax Only External TAD	Fax Receive Easy Receive Delayed Fax ³ Fax Forward ³ Paging ³ Fax Storage ³ PC Fax Receive ³ Remote Retrieval ³
	Manual Fax/Tel ²	Easy Receive Delayed Fax ³

- ¹ You cannot receive a fax with **Black Start** or **Color Start**.
- ² You cannot receive a fax automatically if you have set the receive mode to Fax/Tel.
- ³ Set before you switch off the machine.

MFC-665CW and MFC-845CW

On/Off setting	Receive mode	Available operations
Fax Receive: Off (factory setting)	—	No machine operations will be available.
Fax Receive: On ^{1,2}	Fax Only Fax/Tel ³ Manual ⁴	Fax Receive Easy Receive Delayed Fax ⁶ Fax Forward ⁶ Paging ⁶ Fax Storage ⁶ Fax Preview ⁶ PC Fax Receive ⁶ Remote Retrieval ⁶
	MC	Fax Receive Recording Incoming Message Easy Receive, Delayed Fax ⁶ Fax Forward ⁶ Paging ⁶ Fax Storage ⁶ Fax Preview ⁶ PC Fax Receive ⁶ Remote Retrieval ⁶
	Manual Fax/Tel ⁵	Easy Receive Delayed Fax ⁶

- ¹ You cannot receive a fax with **Black Start** or **Color Start**.
- ² You can receive telephone calls by lifting the handset (MFC-665CW) or using the cordless handset (MFC-845CW).
- ³ MFC-665CW
- ⁴ When an external TAD is connected and Easy Receive is turned on.
- ⁵ You cannot receive a fax automatically if you have set the receive mode to Fax/Tel (MFC-845CW).
- ⁶ Set before you switch off the machine.

Mode Timer

The machine has four temporary mode keys on the control panel: **Fax**, **Scan**, **Copy** and **PhotoCapture**. You can change the amount of time the machine takes after the last Scan, Copy or PhotoCapture operation before it returns to Fax mode. If you choose *Off*, the machine stays in the mode you used last.

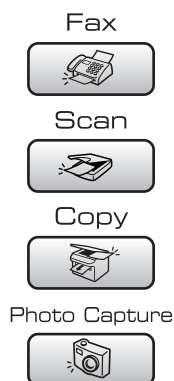

- 1 Press **Menu**.
- 2 Press **▲** or **▼** to choose *General Setup*. Press **OK**.
- 3 Press **▲** or **▼** to choose *Mode Timer*. Press **OK**.
- 4 Press **▲** or **▼** to choose *0 Sec*, *30 Secs*, *1 Min*, *2 Mins*, *5 Mins* or *Off*. Press **OK**.
- 5 Press **Stop/Exit**.

Paper settings

Paper Type

To get the best print quality, set the machine for the type of paper you are using.

- 1 Press **Menu**.
- 2 Press **▲** or **▼** to choose *General Setup*. Press **OK**.
- 3 Press **▲** or **▼** to choose *Paper Type*. Press **OK**.
- 4 Press **▲** or **▼** to choose *Plain Paper*, *Inkjet Paper*, *Brother Photo*, *Other Photo* or *Transparency*. Press **OK**.
- 5 Press **Stop/Exit**.



Note

The machine ejects paper with printed surfaces face up onto the paper tray in front of the machine. When you use transparencies or glossy paper, remove each sheet at once to prevent smudging or paper jams.

Paper Size



You can use five sizes of paper for printing copies: Letter, Legal, A4, A5, and 4 × 6 in. (10 × 15 cm) and three sizes for printing faxes: Letter, Legal and A4. When you change the size of paper you load in the machine, you will need to change the paper size setting at the same time so your machine can fit an incoming fax on the page.

- 1 Press **Menu**.
- 2 Press ▲ or ▼ to choose `General Setup`. Press **OK**.
- 3 Press ▲ or ▼ to choose `Paper Size`. Press **OK**.
- 4 Press ▲ or ▼ to choose `Letter`, `Legal`, `A4`, `A5` or `4"×6"`. Press **OK**.
- 5 Press **Stop/Exit**.

Volume Settings

Ring Volume

You can choose a range of ring volume levels, from `High` to `Off`.

While in Fax mode , press  ◀ or ▶  to adjust the volume level. The LCD shows the current setting, and each key press will change the volume to the next level. The machine will keep the new setting until you change it. You can also change the volume through the menu, by following the instructions below:

Setting the Ring Volume from the menu

- 1 Press **Menu**.
- 2 Press ▲ or ▼ to choose `General Setup`. Press **OK**.
- 3 Press ▲ or ▼ to choose `Volume`. Press **OK**.
- 4 Press ▲ or ▼ to choose `Ring`. Press **OK**.
- 5 Press ▲ or ▼ to choose `Low`, `Med`, `High` or `Off`. Press **OK**.
- 6 Press **Stop/Exit**.

Beeper Volume

When the beeper is on, the machine will beep when you press a key, make a mistake or after you send or receive a fax.

You can choose a range of volume levels, from `High` to `Off`.

- 1 Press **Menu**.

- 2 Press ▲ or ▼ to choose *General Setup*. Press **OK**.
- 3 Press ▲ or ▼ to choose *Volume*. Press **OK**.
- 4 Press ▲ or ▼ to choose *Beeper*. Press **OK**.
- 5 Press ▲ or ▼ to choose *Low, Med, High or Off*. Press **OK**.
- 6 Press **Stop/Exit**.

Speaker Volume

You can choose a range of speaker volume levels, from *High* to *Off*.

- 1 Press **Menu**.
- 2 Press ▲ or ▼ to choose *General Setup*. Press **OK**.
- 3 Press ▲ or ▼ to choose *Volume*. Press **OK**.
- 4 Press ▲ or ▼ to choose *Speaker*. Press **OK**.
- 5 Press ▲ or ▼ to choose *Low, Med, High or Off*. Press **OK**.
- 6 Press **Stop/Exit**.

You can also adjust the speaker volume by pressing **Hook** or **Speaker Phone**.

- 1 Press **Hook** or **Speaker Phone**.
- 2 Press ◀▶ or ▶▶◀◀. This setting will stay until you change it again.
- 3 Press **Hook** or **Speaker Phone**.



Note

(MFC-665CW and MFC-845CW only)

You can adjust the speaker volume while you are listening to your outgoing message (OGM) and incoming messages (ICM's) by pressing ◀▶ ◀◀ or ▶▶▶▶.

Handset Volume (MFC-665CW only)

- 1 Press **Menu**.
- 2 Press ▲ or ▼ to choose *General Setup*. Press **OK**.
- 3 Press ▲ or ▼ to choose *Volume*. Press **OK**.
- 4 Press ▲ or ▼ to choose *Handset*. Press **OK**.
- 5 Press ▲ or ▼ to choose *Low or High*. Press **OK**.
- 6 Press **Stop/Exit**.



Note

- You can adjust the handset volume any time you are talking on the telephone. There are two handset volume levels, *Low* and *High*. The default setting is *Low*.
- Press ◀▶ ◀◀ or ▶▶▶▶ to adjust the volume level. The LCD shows the setting you are choosing. The new setting will remain until you change it again.

Choosing the Handset Volume (For Volume Amplify) (MFC-665CW only)

Before you begin to use the machine, you must decide if you need to set the handset volume to `Volume Amplify On` for a user who is hearing-impaired. The AMPLIFY volume level complies with FCC standards.

`Volume Amplify Off`

This default setting is appropriate if *none* of the users are hearing-impaired. During a conversation, users can press `⏪` or `⏩` on the control panel to adjust the volume to `Low` or `High`. When the handset is replaced, the handset volume will remain until you change it again.

`Volume Amplify On - Temporary`

This setting is appropriate if *some* of the users are hearing-impaired. During a conversation, users can press `⏪` or `⏩` on the control panel to adjust the volume to `Low`, `High` or `Amplify`. When the handset is replaced, the handset volume returns to the default setting of `Low`.

`Volume Amplify:On - Permanent`

Choose `Volume Amplify On - Permanent` if *all* of the users are hearing-impaired. During a conversation, users can press `⏪` or `⏩` on the control panel to adjust the volume to `Low`, `High` or `Amplify`. When the handset is replaced, the handset volume returns to the default setting of `Amplify`.



Note

When you press `⏪` or `⏩` on the control panel to adjust the volume, the LCD shows the setting you are choosing. Each key press changes the volume to the next setting.



WARNING

It is important that you do NOT choose Permanent unless ALL the users are hearing-impaired. Otherwise, the default setting of `Amplify` may damage the hearing of some users.

Setting Volume Amplify (MFC-665CW only)

Please carefully read *Choosing the Handset Volume (For Volume Amplify) (MFC-665CW only)* on page 29.

- 1 Press **Menu**.
- 2 Press ▲ or ▼ to choose *General Setup*. Press **OK**.
- 3 Press ▲ or ▼ to choose *Volume*. Press **OK**.
- 4 Press ▲ or ▼ to choose *Volume Amplify*. Press **OK**.
- 5 Do one of the following.
 - If none of the users are hearing-impaired, press ▲ or ▼ to choose *Off*, and then press **OK** and go to step 7.
 - If some or all of the users are hearing-impaired, press ▲ or ▼ to choose *On*, and then press **OK**.
- 6 Do one of the following.
 - If *all* the users are hearing-impaired, press ▲ or ▼ to choose *Permanent*, and then press **OK**.
 - If only *some* of the users are hearing-impaired, choose *Temporary*, and then press **OK**.
- 7 Press **Stop/Exit**.

Automatic Daylight Savings Time

You can set the machine to change automatically for daylight savings time. It will reset itself forward one hour in the Spring and backward one hour in the Fall. Make sure you have set the correct date and time in the *Date/Time setting*.

- 1 Press **Menu**.
- 2 Press ▲ or ▼ to choose *General Setup*. Press **OK**.
- 3 Press ▲ or ▼ to choose *Auto Daylight*. Press **OK**.
- 4 Press ▲ or ▼ to choose *On (or Off)*. Press **OK**.
- 5 Press **Stop/Exit**.

LCD display

LCD Contrast

You can adjust the LCD contrast for a sharper and more vivid display. If you are having difficulty reading the LCD, try changing the contrast setting.

- 1 Press **Menu**.
- 2 Press **▲** or **▼** to choose `General Setup`. Press **OK**.
- 3 Press **▲** or **▼** to choose `LCD Settings`. Press **OK**.
- 4 Press **▲** or **▼** to choose `LCD Contrast`. Press **OK**.
- 5 Press **▲** or **▼** to choose `Light`, `Med` or `Dark`. Press **OK**.
- 6 Press **Stop/Exit**.

Setting the backlight brightness

You can adjust the brightness of the LCD backlight. If you are having difficulty reading the LCD, try changing the brightness setting.

- 1 Press **Menu**.
- 2 Press **▲** or **▼** to choose `General Setup`. Press **OK**.
- 3 Press **▲** or **▼** to choose `LCD Settings`. Press **OK**.
- 4 Press **▲** or **▼** to choose `Backlight`. Press **OK**.

- 5 Press **▲** or **▼** to choose `Light`, `Med` or `Dark`. Press **OK**.

- 6 Press **Stop/Exit**.

Setting the Dim Timer for the backlight

You can set how long the LCD backlight stays on after the last key press.

- 1 Press **Menu**.
- 2 Press **▲** or **▼** to choose `General Setup`. Press **OK**.
- 3 Press **▲** or **▼** to choose `LCD Settings`. Press **OK**.
- 4 Press **▲** or **▼** to choose `Dim Timer`. Press **OK**.
- 5 Press **▲** or **▼** to choose `10 Secs`, `20 Secs`, `30 Secs` or `Off`. Press **OK**.
- 6 Press **Stop/Exit**.

Setting the Off Timer

You can set how long the LCD stays on after the last key press. This is a power saving feature. The machine can print, scan and receive faxes and voice calls when the LCD is off.

- 1 Press **Menu**.
- 2 Press **▲** or **▼** to choose `General Setup`. Press **OK**.
- 3 Press **▲** or **▼** to choose `LCD Settings`. Press **OK**.

- 4 Press ▲ or ▼ to choose Off Timer.
Press **OK**.
- 5 Press ▲ or ▼ to choose 1 Min,
2 Mins, 3 Mins, 5 Mins, 10 Mins,
30 Mins or Off.
Press **OK**.
- 6 Press **Stop/Exit**.



Note

When the display is off you can press any key to turn it back on.

Setting the Wallpaper

You can change the wallpaper.

- 1 Press **Menu**.
- 2 Press ▲ or ▼ to choose
General Setup.
Press **OK**.
- 3 Press ▲ or ▼ to choose
LCD Settings.
Press **OK**.
- 4 Press ▲ or ▼ to choose Wallpaper.
Press **OK**.
- 5 Press ▲ or ▼ to choose a wallpaper.
Press **OK**.
- 6 Press **Stop/Exit**.

TX Lock (MFC-440CN only)

TX Lock lets you prevent unauthorized access to the machine. You will not be able to continue to schedule Delayed Faxes or Polling jobs. However, any pre-scheduled Delayed Faxes will be sent even if you turn on TX Lock, so they will not be lost.

While TX Lock is On, the following operations are available:

- Receiving faxes
- Fax Forwarding (If Fax Forwarding was already On)
- Remote retrieval (If Fax Storage was already On)
- PC Fax Receive (if PC Fax Receive was already On)

While TX Lock is On, the following operations are NOT available:

- Sending faxes
- Copying
- PC printing
- Scanning
- PhotoCapture



Note

If you forget the TX Lock password, please call Brother Customer Service.

Setting and changing the TX Lock password



Note

If you have already set the password, you will not need to set it again.

Setting up the password

- 1 Press **Menu**.
- 2 Press **▲** or **▼** to choose **Fax**. Press **OK**.
- 3 Press **▲** or **▼** to choose **Miscellaneous**. Press **OK**.
- 4 Press **▲** or **▼** to choose **TX Lock**. Press **OK**.
- 5 Enter a 4-digit number for the password. Press **OK**.
- 6 When the LCD shows **Verify:**, re-enter the password. Press **OK**.
- 7 Press **Stop/Exit**.

Changing the TX Lock password

- 1 Press **Menu**.
- 2 Press **▲** or **▼** to choose **Fax**. Press **OK**.
- 3 Press **▲** or **▼** to choose **Miscellaneous**. Press **OK**.
- 4 Press **▲** or **▼** to choose **TX Lock**. Press **OK**.
- 5 Press **▲** or **▼** to choose **Set Password**. Press **OK**.
- 6 Enter a 4-digit number for the current password. Press **OK**.
- 7 Enter a 4-digit number for a new password. Press **OK**.

- 8 When the LCD shows *Verify:*, re-enter the password.
Press **OK**.
- 9 Press **Stop/Exit**.

Turning the TX Lock on/off

Turning TX Lock on

- 1 Press **Menu**.
- 2 Press **▲** or **▼** to choose *Fax*.
Press **OK**.
- 3 Press **▲** or **▼** to choose *Miscellaneous*.
Press **OK**.
- 4 Press **▲** or **▼** to choose *TX Lock*.
Press **OK**.
- 5 Press **▲** or **▼** to choose *Set TX Lock*.
Press **OK**.
- 6 Enter the registered 4-digit password.
Press **OK**.
The machine goes offline and the LCD shows *TX Lock Mode*.

Turning TX Lock off

- 1 Press **Menu**.
- 2 Enter the registered 4-digit password.
Press **OK**.
TX lock is automatically turned off.



Note

If you enter the wrong password, the LCD shows *Wrong Password* and stays offline. The machine will stay in TX Lock mode until the registered password is entered.

Memory Security (MFC-665CW and MFC-845CW only)

Memory Security lets you prevent unauthorized access to the machine. You will not be able to continue to schedule Delayed Faxes or Polling jobs. However, any pre-scheduled Delayed Faxes will be sent even if you turn on Memory Security, so they will not be lost.

While Memory Security is On, the following operations are available:

- Receiving faxes into memory (limited by memory capacity)
- Fax Forwarding (If Fax Forwarding was already On)
- Remote retrieval (If Fax Storage was already On)
- Cordless handset (MFC-845CW only)
 - Making a call
 - Receiving a call
 - Viewing Caller ID (with subscriber service)

While Memory Security is on, the following operations are NOT available:

- Printing received faxes
- Sending faxes
- Copying
- PC printing
- Scanning
- PhotoCapture
- PC Fax Receive
- Cordless handset (MFC-845CW only)
 - Intercom
 - Transfer a call
 - Register cordless handset

**Note**

- To print the faxes in memory, turn off Memory Security.
- You must turn off PC Fax Receive before you can turn on Memory Security. (See *Turning off Advanced Fax Operations* on page 81.)
- If you forget the Memory Security password, please call Brother Customer Service.

Setting and changing the memory security password

**Note**

If you have already set the password, you will not need to set it again.

Setting a password for the first time

- 1 Press **Menu**.
- 2 Press **▲** or **▼** to choose **Fax**. Press **OK**.
- 3 Press **▲** or **▼** to choose **Miscellaneous**. Press **OK**.
- 4 Press **▲** or **▼** to choose **Mem Security**. Press **OK**.
- 5 Enter a 4-digit number for the password. Press **OK**.
- 6 When the LCD shows **Verify:**, re-enter the password. Press **OK**.
- 7 Press **Stop/Exit**.

Changing your memory security password

- 1 Press **Menu**.
- 2 Press **▲** or **▼** to choose **Fax**. Press **OK**.
- 3 Press **▲** or **▼** to choose **Miscellaneous**. Press **OK**.
- 4 Press **▲** or **▼** to choose **Mem Security**. Press **OK**.
- 5 Press **▲** or **▼** to choose **Set Password**. Press **OK**.
- 6 Enter the registered 4-digit number for the current password. Press **OK**.
- 7 Enter a 4-digit number for a new password. Press **OK**.
- 8 When the LCD shows **Verify:**, re-enter the new password. Press **OK**.
- 9 Press **Stop/Exit**.

Turning the memory security on/off

Turning on the memory security lock

- 1 Press **Menu**.
- 2 Press **▲** or **▼** to choose `Fax`.
Press **OK**.
- 3 Press **▲** or **▼** to choose `Miscellaneous`.
Press **OK**.
- 4 Press **▲** or **▼** to choose `Mem Security`.
Press **OK**.
- 5 Press **▲** or **▼** to choose `Set Security`.
Press **OK**.
- 6 Enter the registered 4-digit password.
Press **OK**.
The machine goes offline and the LCD shows `Secure Mode`.



Note

If there is a power failure the data will stay in memory for approximately 24 hours.

Turning off the memory security

- 1 Press **Menu**.
- 2 Enter the registered 4-digit password.
Press **OK**.
Memory Security is automatically turned off.



Note

If you enter the wrong password, the LCD shows `Wrong Password` and stays offline. The machine will stay in Secure mode until the registered password is entered.



Fax

Sending a fax	38
Receiving a Fax	46
Telephone Services and External devices	52
Dialing and storing numbers	63
Message Center (MFC-665CW and MFC-845CW only)	71
Advanced fax operations (Black & White only)	76
Printing Reports	87
Polling	89

5

Sending a fax

Entering Fax mode

When the machine is idle, the time appears on the LCD. When you want to send a fax, or change fax send or receive settings, press the  (**Fax**) key to illuminate it in green.

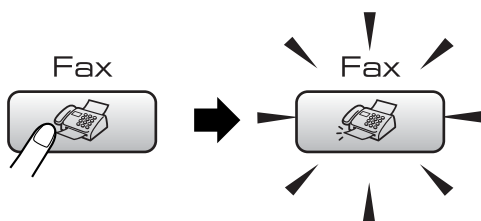

The LCD shows:



Press **▲** or **▼** to scroll through the **Fax** key options. Some functions are only available when sending black & white faxes.

- Fax Resolution (See page 41.)
- Contrast (See page 41.)
- Speed-Dial (See page 63.)
- Outgoing Call (See page 64.)
- Caller ID hist. (See page 65.)
- Broadcasting (See page 40.)
- Delayed Fax (See page 43.)
- Batch TX (See page 43.)
- Real Time TX (See page 42.)
- Polled TX (See page 90.)
- Polling RX (See page 89.)
- Overseas Mode (See page 43.)

- Scan Size (See page 39.)
- Set New Default (See page 44.)
- Factory Reset (See page 44.)

When the option you want is highlighted, press **OK**.

Faxing from the ADF

- 1 Press  (**Fax**).
- 2 Put the document face down in the ADF.
- 3 Enter the fax number using the dial pad, Speed-Dial or Search.
- 4 Press **Black Start** or **Color Start**. The machine starts scanning the document.



Note

- To cancel, press **Stop/Exit**.
- If the memory is full, the fax will be sent in real time.

Faxing from the scanner glass

You can use the scanner glass to fax pages of a book one at a time. The documents can be up to letter or A4 size.

You cannot send multiple pages for color faxes.



Note

Since you can only scan one page at a time, it is easier to use the ADF if you are sending a multiple page document.

- 1 Press  (**Fax**).
- 2 Load your document face down on the scanner glass.
- 3 Enter the fax number using the dial pad, Speed-Dial or Search.
- 4 Press **Black Start** or **Color Start**.
 - If you press **Black Start**, the machine starts scanning the first page. Go to step 5.
 - If you press **Color Start**, the machine starts sending the document.
- 5 Do one of the following:
 - To send a single page, press 2 to choose **No** (or press **Black Start** again).
The machine starts sending the document.
 - To send more than one page, press 1 to choose **Yes** and go to step 6.
- 6 Put the next page on the scanner glass. Press **OK**.
The machine starts scanning the page. (Repeat steps 5 and 6 for each additional page.)



Note

If the memory is full and you are faxing a single page, it will be sent in real time.

Faxing A4 size documents from the scanner glass

When documents are A4 size, you need to set Scan Size to A4. If you do not, the bottom portion of the faxes will be missing.

- 1 Press  (**Fax**).
- 2 Press **▲** or **▼** to choose **Scan Size**. Press **OK**.
- 3 Press **▲** or **▼** to choose **A4**. Press **OK**.



Note

You can save the setting you use most often by setting it as default. (See page 44.)

Color fax transmission

Your machine can send a color fax to machines that support this feature.

Color faxes cannot be stored in the memory. When you send a color fax, the machine will send it in real time (even if **Real Time TX** is set to **Off**).

Canceling a fax in progress

If you want to cancel a fax while the machine is scanning, dialing or sending, press **Stop/Exit**.

Broadcasting (Black & White only)

Broadcasting is when the same fax message is automatically sent to more than one fax number. You can include Groups, Speed-Dial numbers and up to 50 manually dialed numbers in the same broadcast.

After the broadcast is finished, a Broadcast Report will be printed.

- 1 Press  (Fax).
- 2 Load your document.
- 3 Press ▲ or ▼ to choose *Broadcasting*. Press **OK**.
- 4 Press ▲ or ▼ to choose *Add Number*. Press **OK**.
- 5 Enter a number using Speed-Dial, a Group, or the dial pad. Press **OK**.
- 6 After you have entered all the fax numbers by repeating steps 4 and 5, press ▲ or ▼ to choose *Complete*. Press **OK**.
- 7 Press **Black Start**.



Note

- If you did not use up any of the numbers for Groups, you can 'broadcast' faxes to as many as 210 (MFC-440CN and MFC-665CW) or 250 (MFC-845CW) different numbers.
- The available memory will vary depending on the types of jobs in the memory and the number of locations used for broadcasting. If you broadcast to the maximum numbers available, you will not be able to use dual access and delayed fax.

- If the memory is full, press **Stop/Exit** to stop the job. If more than one page has been scanned, press **Black Start** to send the portion that is in the memory.

Canceling a Broadcast in progress

- 1 Press **Menu**.
- 2 Press ▲ or ▼ to choose *Fax*. Press **OK**.
- 3 Press ▲ or ▼ to choose *Remaining Jobs*. Press **OK**.
The LCD will show the fax number being dialed and the Broadcast job number.
- 4 Press **OK**.
The LCD will ask you the following message:
Cancel Job?
Yes → Press **1**
No → Press **2**
- 5 Press **1** to clear the number being dialed.
The LCD will then show the Broadcast job number.
- 6 Press **OK**.
The LCD will ask you the following message:
Cancel Job?
Yes → Press **1**
No → Press **2**
- 7 Press **1** to cancel the Broadcast.
- 8 Press **Stop/Exit**.

Additional sending operations

Sending faxes using multiple settings

When you send a fax you can choose any combination of these settings: resolution, contrast, overseas mode, delayed fax timer, polling transmission and real time transmission.

- 1 Press  (**Fax**).
The LCD shows:

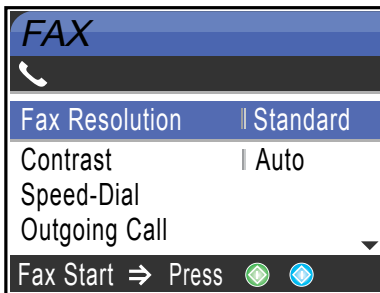

- 2 Press \blacktriangle or \blacktriangledown to choose any settings you want to change.
Press **OK**.
- 3 After each setting is accepted, you can continue to change more settings.



Note

- Most settings are temporary and the machine returns to its default settings after you send a fax.
- You can save some of the settings you use most often by setting them as default. These settings will stay until you change them again. (See *Setting your changes as a new default* on page 44.)

Contrast

If your document is very light or very dark, you may want to change the contrast.

Use Light when sending a light document.

Use Dark when sending a dark document.

- 1 Press  (**Fax**).
- 2 Press \blacktriangle or \blacktriangledown to choose **Contrast**.
Press **OK**.
- 3 Press \blacktriangle or \blacktriangledown to choose **Auto**, **Light** or **Dark**.
Press **OK**.



Note

Even if you choose **Light** or **Dark**, the machine will send the fax using the **Auto** setting in any of the following conditions:

- When you send a color fax.
- When you choose **Photo** as the Fax Resolution.

Changing fax resolution

The quality of a fax can be improved by changing the fax resolution.

- 1 Press  (**Fax**).
- 2 Press \blacktriangle or \blacktriangledown to choose **Fax Resolution**.
Press **OK**.
- 3 Press \blacktriangle or \blacktriangledown to choose the resolution you want.
Press **OK**.

**Note**

You can choose four different resolution settings for black & white faxes and two for color.

Black & White	
Standard	Suitable for most typed documents.
Fine	Good for small print and transmits a little slower than Standard resolution.
S.Fine	Good for small print or artwork and transmits slower than Fine resolution.
Photo	Use when the document has varying shades of gray or is a photograph. This has the slowest transmission.

Color	
Standard	Suitable for most typed documents.
Fine	Use when the document is a photograph. The transmission time is slower than Standard resolution.

If you choose **S.Fine** or **Photo** and then use the **Color Start** key to send a fax, the machine will send the fax using the **Fine** setting.

Dual access (Black & White only)

You can dial a number and start scanning the fax into memory—even when the machine is sending from memory, receiving faxes or printing PC data. The LCD shows the new job number and available memory.

The number of pages you can scan into the memory will vary depending on the data that is printed on them.

**Note**

If the **Out of Memory** message appears while scanning documents, press **Stop/Exit** to cancel or **Black Start** to send the scanned pages.

Real time transmission

When you are sending a fax, the machine will scan the documents into the memory before sending. Then, as soon as the phone line is free, the machine will start dialing and sending.

If the memory is full, the machine will send the document in real time (even if **Real Time TX** is set to **Off**).

Sometimes, you may want to send an important document immediately, without waiting for memory transmission. You can turn on **Real Time TX**.

To send a document at once without waiting for memory transmission, set **Real Time TX** to **On**.

- 1 Press  (**Fax**).
- 2 Press **▲** or **▼** to choose **Real Time TX**. Press **OK**.
- 3 Press **▲** or **▼** to choose **On**. Press **OK**.

**Note**

- In real time transmission, the automatic redial feature does not work when using the scanner glass.
- If you are sending a color fax, the machine will send it in real time (even if **Real Time TX** is set to **Off**).

Overseas Mode

If you are having difficulty sending a fax overseas due to possible interference on the phone line, we recommend that you turn on the Overseas mode. After you send a fax using this feature, the feature will turn itself off.

- 1 Press  (Fax).
- 2 Load your document.
- 3 Press ▲ or ▼ to choose Overseas Mode.
Press **OK**.
- 4 Press ▲ or ▼ to choose On (or Off).
Press **OK**.

Delayed Faxing (Black & White only)

During the day you can store up to 50 faxes in the memory to be sent within 24-hours. These faxes will be sent at the time of day you enter in step 5.

- 1 Press  (Fax).
- 2 Load your document.
- 3 Press ▲ or ▼ to choose Delayed Fax.
Press **OK**.
- 4 Press ▲ or ▼ to choose On.
Press **OK**.
- 5 Enter the time you want the fax to be sent (in 24-hour format).
(For example, enter 19:45 for 7:45 PM.)
Press **OK**.



Note

The number of pages you can scan into the memory depends on the amount of data that is printed on each page.

Delayed Batch Transmission (Black & White only)

Before sending the delayed faxes, your machine will help you economize by sorting all the faxes in the memory by destination and scheduled time. All delayed faxes that are scheduled to be sent at the same time to the same fax number will be sent as one fax to save transmission time.

- 1 Press  (Fax).
- 2 Press ▲ or ▼ to choose Batch TX.
Press **OK**.
- 3 Press ▲ or ▼ to choose On.
Press **OK**.
- 4 Press **Stop/Exit**.

Checking and canceling waiting jobs

You can check which jobs are still waiting in the memory to be sent and cancel a job. (If there are no jobs, the LCD shows No Jobs Waiting.)

- 1 Press **Menu**.
- 2 Press ▲ or ▼ to choose Fax.
Press **OK**.
- 3 Press ▲ or ▼ to choose Remaining Jobs.
Press **OK**.
Any waiting jobs appear on the LCD.
- 4 Press ▲ or ▼ to scroll through the jobs and choose the job you want to cancel.
Press **OK**.
- 5 Do one of the following:
 - To cancel, press **1** to choose Yes.
If you want to cancel another job go to step 4.
 - To exit without canceling, press **2** to choose No.

- 6 When you have finished, press **Stop/Exit**.

Setting your changes as a new default

You can save the fax settings for Fax Resolution, Contrast, Real Time TX and Scan Size you use most often by setting them the default setting. These settings will stay until you change them again.

- 1 Press  (**Fax**).
- 2 Press **▲** or **▼** to choose your new setting. Press **OK**. Repeat this step for each setting you want to change.
- 3 After changing the last setting, press **▲** or **▼** to choose **Set New Default**. Press **OK**.
- 4 Press **1** to choose **Yes**.
- 5 Press **Stop/Exit**.

Restoring all the settings to factory settings

You can restore all the settings you have changed to the factory settings. These settings will stay until you change them again.

- 1 Press  (**Fax**).
- 2 Press **▲** or **▼** to choose **Factory Reset**. Press **OK**.
- 3 Press **1** to choose **Yes**.
- 4 Press **Stop/Exit**.

Sending a fax manually

Manual transmission lets you hear the dialing, ringing and fax-receiving tones while sending a fax.

- 1 Press  (**Fax**).
- 2 Load your document.
- 3 To listen for a dial tone do one of the following:
 - (MFC-440CN) Press **Hook** or pick up the handset of an external phone.
 - (MFC-665CW) Press **Speaker Phone** or pick up the handset.
 - (MFC-845CW) Press **Speaker Phone** on the machine.
- 4 Dial using the machine's dial pad.
- 5 When you hear the fax tone, press **Black Start** or **Color Start**. If you are using the scanner glass press **1** to send a fax.
- 6 If you picked up the machine's handset, or an external handset replace it.

Sending a fax at the end of a conversation (MFC-440CN and MFC-665CW only)

At the end of a conversation you can send a fax to the other party before you both hang up.

- 1 Ask the other party to wait for fax tones (beeps) and then to press the **Start** or **Send** key before hanging up.
- 2 Load your document.
- 3 Press **Black Start** or **Color Start**.
 - If you are using the scanner glass, press **1** to send a fax.
- 4 Replace the handset.

Out of Memory message

If you get an **Out of Memory** message while scanning the first page of a fax, press **Stop/Exit** to cancel the fax.

If you get an **Out of Memory** message while scanning a subsequent page, you will have the option to press **Black Start** to send the pages scanned so far, or to press **Stop/Exit** to cancel the operation.



Note

If you get an **Out of Memory** message while faxing and you do not want to delete your stored faxes to clear the memory, you can send the fax in real time. (See *Real time transmission* on page 42.)

6

Receiving a Fax

Receive modes

You must choose the receive mode depending on the external devices and telephone subscriber services you have on your line. The diagrams below will help you choose the correct mode. For more detailed information about the receive modes, see page 48.

Choosing the Receive Mode

MFC-440CN

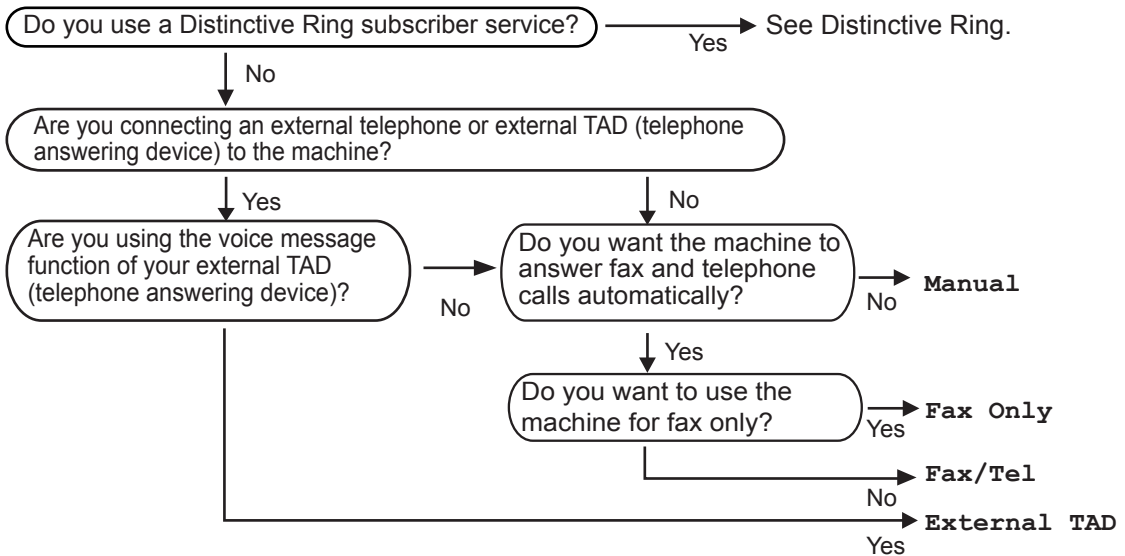

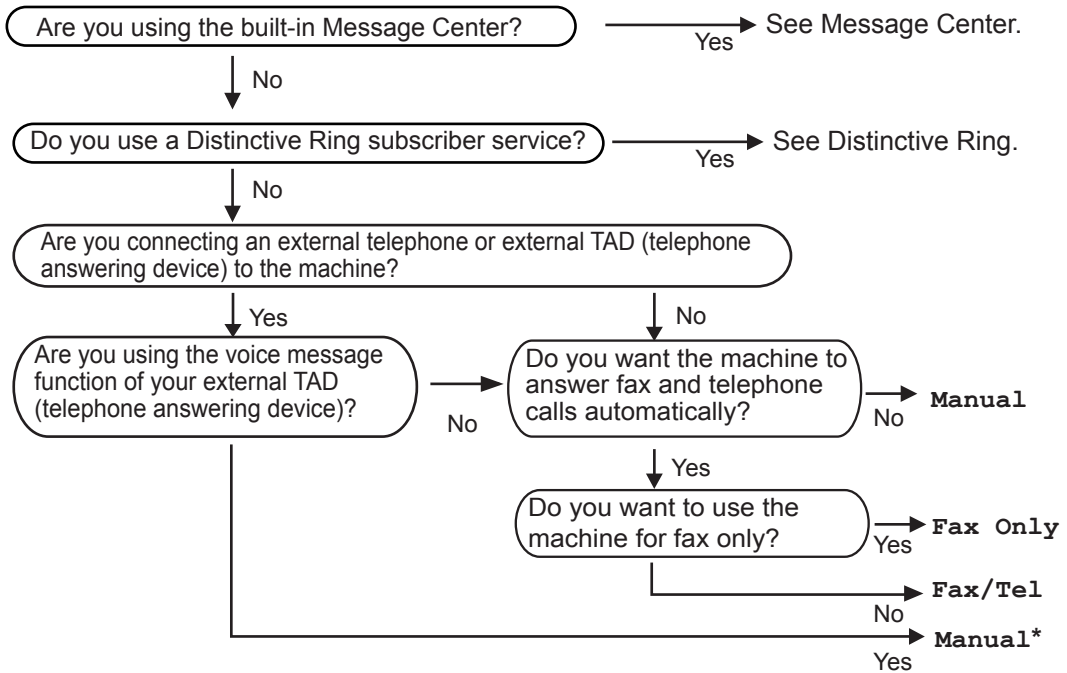
MFC-665CW and MFC-845CW

* We recommend you set **Easy Receive** to On.

To set a receive mode follow the instructions below.

- 1 Press **Menu**.
- 2 Press **▲** or **▼** to choose **Initial Setup**. Press **OK**.
- 3 Press **▲** or **▼** to choose **Receive Mode**. Press **OK**.
- 4 Press **▲** or **▼** to choose **Fax Only**, **Fax/Tel**, **External TAD** (MFC-440CN only) or **Manual**. Press **OK**.
- 5 Press **Stop/Exit**.

The LCD will display the current receive mode.

Using receive modes

Some receive modes answer automatically (**Fax Only** and **Fax/Tel**). You may want to change the ring delay before using these modes. See *Ring Delay* on page 49.

Fax only

Fax only mode will automatically answer every call. If the call is a fax your machine will receive it.

Fax/Tel

Fax/Tel mode helps you automatically manage incoming calls, by recognizing whether they are fax or voice calls and handling them in one of the following ways:

- Faxes will be automatically received.
- Voice calls will start the F/T ring to tell you to pick up the line. The F/T ring is a fast double ring made by your machine.

Also see *F/T Ring Time (Fax/Tel mode only)* on page 49 and *Ring Delay* on page 49.

Manual

Manual mode turns off all automatic answering functions unless you are using the Distinctive Ring feature or you are using an external TAD with the MFC-665CW or the MFC-845CW.

To receive a fax in manual mode press **Black Start** or **Color Start** when you hear fax tones (short repeating beeps). You can also use the Easy Receive feature to receive faxes by lifting a handset on the same line as the machine.



Also see *Easy Receive* on page 50.

Message Center (MC) (MFC-665CW and MFC-845CW only)

Message Center (MC) helps you automatically manage incoming calls, by recognizing whether they are fax or voice calls and handling them in one of the following ways:

- Faxes will be automatically received.
- Voice callers can record a message.

To set up the Message Center mode see page 71.

	<p>If Message Center Mode is On, it will override your receive mode setting. The screen shows MC.</p>
	<p>If Message Center Mode is Off, the receive mode returns to your original setting. (See <i>Message Center mode</i> on page 71.)</p>

External TAD (MFC-440CN only)

External TAD mode lets an external answering device manage your incoming calls. Incoming calls will be handled in one of the following ways:

- Faxes will be automatically received.
- Voice callers can record a message on the external TAD.

For more information see *Connecting an external TAD (telephone answering device)* on page 57.

Receive mode settings

Ring Delay

The Ring Delay sets the number of times the machine rings before it answers in **Fax Only** or **Fax/Tel** mode. If you have external or extension phones on the same line as the machine or subscribe to the telephone company's Distinctive Ring service, keep the ring delay setting of 4.

(See *Using external and extension telephones* on page 61 and *Easy Receive* on page 50.)

If toll saver is **on**, then the ring delay setting has no effect. See *Setting toll saver* on page 74. (MFC-665CW and MFC-845CW only)

- 1 Press **Menu**.
- 2 Press **▲** or **▼** to choose **Fax**. Press **OK**.
- 3 Press **▲** or **▼** to choose **Setup Receive**. Press **OK**.
- 4 Press **▲** or **▼** to choose **Ring Delay**. Press **OK**.
- 5 (MFC-665CW and MFC-845CW) Press **▲** or **▼** to choose **Ring Delay** again. Press **OK**.
- 6 Press **▲** or **▼** to choose how many times the line rings before the machine answers (0-4). Press **OK**.
If you choose 0, the line will not ring at all.
- 7 Press **Stop/Exit**.

F/T Ring Time (Fax/Tel mode only)

If you set the Receive Mode to **Fax/Tel**, you need to decide how long the machine will signal you with its special pseudo/double-ring when you have a voice call. If it's a fax call, the machine receives the fax.

This pseudo/double-ring happens after the initial ringing from the phone company. Only the machine rings and no other phones on the same line will ring with the special pseudo/double-ring. However, you can still answer the call on any telephone on the same line as the machine. (See *Using external and extension telephones* on page 61.)

- 1 Press **Menu**.
- 2 Press **▲** or **▼** to choose **Fax**. Press **OK**.
- 3 Press **▲** or **▼** to choose **Setup Receive**. Press **OK**.
- 4 Press **▲** or **▼** to choose **F/T Ring Time**. Press **OK**.
- 5 Press **▲** or **▼** to choose how long the machine will ring to alert you that you have a voice call (20, 30, 40 or 70 seconds). Press **OK**.
- 6 Press **Stop/Exit**.



Note

Even if the caller hangs up during the pseudo/double-ringing, the machine will continue to ring for the set time.

Easy Receive

If Easy Receive is **On**:

The machine receives a fax call automatically, even if you answer the call. When you see *Receiving* on the LCD or when you hear “chirps” through the handset you are using, just replace the handset. Your machine will do the rest.

If Easy Receive is **Semi**: (MFC-665CW and MFC-845CW only)

The machine will only receive a fax call automatically if you answered it using the machine’s handset or cordless handset or Speaker Phone. If you answered at an extension phone press **✳ 5 1**. (See *Using external and extension telephones* on page 61.)

If Easy Receive is **Off**:

If you are at the machine and answer a call first by lifting a handset, then press **Black Start** or **Color Start**, and then press **2** to receive.

If you answered at an extension phone press **✳ 5 1**. (See *Using external and extension telephones* on page 61.)



Note

- If this feature is set to **On**, but your machine does not connect a fax call when you lift an extension or external phone handset, press the fax receive code **✳ 5 1**.
- If you send faxes from a computer on the same phone line and the machine intercepts them, set Easy Receive to **Off**.
- (MFC-845CW) If you typically carry the cordless handset away from the machine, we recommend that you turn on Easy Receive. If Easy Receive is turned off and you answer a fax call you will have to go to the machine and press **Black Start** or **Color Start**.

-
- 1 Press **Menu**.
 - 2 Press **▲** or **▼** to choose *Fax*. Press **OK**.
 - 3 Press **▲** or **▼** to choose *Setup Receive*. Press **OK**.
 - 4 Press **▲** or **▼** to choose *Easy Receive*. Press **OK**.
 - 5 Press **▲** or **▼** to choose **On**, **Semi** (or **Off**). Press **OK**.
 - 6 Press **Stop/Exit**.

Additional receiving operations

Printing a reduced incoming fax

If you choose **On**, the machine automatically reduces each page of an incoming fax to fit on one page of A4, Letter, Legal size paper. The machine calculates the reduction ratio by using the page size of the fax and your Paper Size setting (See *Paper Size* on page 27).

- 1 Press **Menu**.
- 2 Press **▲** or **▼** to choose **Fax**. Press **OK**.
- 3 Press **▲** or **▼** to choose **Setup Receive**. Press **OK**.
- 4 Press **▲** or **▼** to choose **Auto Reduction**. Press **OK**.
- 5 Press **▲** or **▼** to choose **On** (or **Off**). Press **OK**.
- 6 Press **Stop/Exit**.

Receiving a fax at the end of a conversation (MFC-440CN and MFC-665CW only)

At the end of a conversation you can ask the other party to fax you information before you both hang up.

- 1 Ask the other party to place the document in their machine and to press the Start or Send key.
- 2 When you hear the other machine's CNG tones (slowly repeating beeps), press **Black Start** or **Color Start**.
- 3 Press **2** to receive a fax.
- 4 Replace the handset.

6

Printing a fax from the memory

If you have chosen paging or fax storage, you can still print a fax from the memory when you are at your machine. (See *Turning off Advanced Fax Operations* on page 81.)

- 1 Press **Menu**.
- 2 Press **▲** or **▼** to choose **Fax**. Press **OK**.
- 3 Press **▲** or **▼** to choose **Advanced Fax Operation**. Press **OK**.
- 4 Press **▲** or **▼** to choose **Print Fax**. Press **OK**.
- 5 Press **Black Start**.

Voice operations



Voice calls can be made either with the handset, the cordless handset (MFC-845CW only), the speaker phone, an extension or external telephone, by dialing manually, or by using Quick-Dial numbers.



Note

If you have the MFC-845CW, please see the Digital Cordless Handset User's Guide.

Making a telephone call (MFC-665CW and MFC-845CW only)

- 1 Do one of the following:
 - (MFC-665CW) Pick up the handset or press **Speaker Phone**.
 - (MFC-845CW) Pick up the cordless handset and press  (**Talk**) or press **Speaker Phone** on the machine.
- 2 When you hear the dial tone, enter a number using the dial pad, Speed-Dial or Search.
- 3 (*Speaker phone*) speak clearly toward the microphone .
- 4 To hang up, do one of the following:
 - (MFC-665CW) Replace the handset or press **Speaker Phone**.
 - (MFC-845CW) Press  (**Off**) on the cordless handset or press **Speaker Phone** on the machine.

Answering calls with the Speaker Phone (MFC-665CW and MFC-845CW only)

When the machine rings, instead of lifting the handset, press **Speaker Phone** on the machine. Speak clearly toward the microphone . To end the call, press **Speaker Phone**.



Note

If you have a bad connection, your caller might hear your voice echoed during the call. If you experience this problem, pick up the handset, or hang up and try the call again.

Hold (MFC-665CW and MFC-845CW only)

For MFC-665CW

- 1 Press **Hold** to put a call on Hold. You can replace the handset without disconnecting the call.
- 2 Pick up the machine's handset or press **Speaker Phone** to release the call from Hold.



Note

You can pick up an extension phone and continue speaking without releasing the call from Hold on the machine.

For MFC-845CW

- 1 If you answered by pressing **Speaker Phone** on the machine, press **Hold/Intercom** on the machine to put a call on Hold.
- 2 To release the call from Hold, press **Speaker Phone** on the machine.

**Note**

You can pick up an extension phone and continue speaking without releasing the call from Hold on the machine.

Tone or Pulse (Canada only)

If you have a Pulse dialing service, but need to send Tone signals (for example, for telephone banking), follow the instructions below:

- 1 Do one of the following:
 - (MFC-440CN) Pick up the handset of an external phone or press **Hook**.
 - (MFC-665CW) Pick up the handset or press **Speaker Phone**.
 - (MFC-845CW) Pick up the cordless handset and press  (**Talk**) or press **Speaker Phone** on the machine.
- 2 Press **#** on the machine's control panel. Any digits dialed after this will send tone signals.

When you hang up, the machine will return to the Pulse dialing service.

Fax/Tel mode when the power key is on

When the machine is in Fax/Tel mode, it will use the F/T Ring Time (pseudo/double-ringing) to alert you to pick up a voice call.

If you are at an extension phone, you'll need to lift the handset during the F/T Ring Time and then press **# 5 1** between the pseudo/double rings. If no one is on the line, or if someone wants to send you a fax, send the call back to the machine by pressing *** 5 1**.

(MFC-440CN) Lift the external telephone's handset, and then press **Hook** to answer.

(MFC-665CW) If you are at the machine, you can lift the handset or press **Speaker Phone** to answer.

(MFC-845CW) Press **Speaker Phone** on the machine or use the cordless handset.

Fax/Tel mode when the power key is off

You can change the default setting of the **On/Off** key to **Fax Receive:On** so that you can receive faxes when the power key is off. (See *On/Off setting* on page 24.) Fax/Tel mode will work in the following ways.

(For MFC-440CN)

Fax/Tel mode does not work when the power key is off. The machine will not answer telephone or fax calls and will keep ringing. If you are at an external or extension phone, lift the handset and talk. If you hear fax tones, hold the handset until Easy Receive activates your machine. If the other party says they want to send you a fax, activate the machine by pressing *** 5 1**.

(MFC-665CW and MFC-845CW only)

When the machine is in Fax/Tel mode and pseudo/double-rings to tell you to pick up a voice call, you can only answer by picking up the machine's handset or cordless handset and pressing  (**Talk**).

If you answer before the machine pseudo/double-rings, you can also pick up the call at an external or extension phone.

Telephone services

Your machine supports the Caller ID and Distinctive Ring subscriber telephone services that some telephone companies offer.

Features like Voice Mail, Call Waiting, Call Waiting/Caller ID, RingMaster, answering services, alarm systems or other custom features on one phone line may affect the way your machine works. If you have Voice Mail on your phone line, please read the following carefully.

Distinctive Ring

Brother uses the term 'Distinctive Ring' but different telephone companies have other names for this service such as SmartRing, RingMaster, Teen-Ring, Indent-a-Call or Indent-a-Ring.

What does your telephone company's 'Distinctive Ring' do?

Your telephone company's Distinctive Ring service allows you to have more than one number on the same phone line. **If you need more than one phone number, it is cheaper than paying for an extra line.** Each phone number has its own distinctive ring pattern, so you will know which phone number is ringing. This is one way you can have a separate phone number for your machine.



Note

Please call your telephone company for availability and rates.

What does Brother's 'Distinctive Ring' do?

The Brother machine has a Distinctive Ring feature that allows you to use your machine to take full advantage of the telephone company's Distinctive Ring service. The new phone number on your line can just receive faxes.



Note

You must pay for your telephone company's Distinctive Ring service before you program the machine to work with it.

Do you have Voice Mail?

If you have Voice Mail on the phone line that you will install your new machine on, *there is a strong possibility that Voice Mail and the machine will conflict with each other while receiving incoming calls.* **However, the Distinctive Ring feature allows you to use more than one number on your line, so both Voice Mail and the machine can work together without any problems.** If each one has a separate phone number, neither will interfere with the other's operations.

If you decide to get the Distinctive Ring service from the telephone company, you will need to follow the directions on next page to 'register' the new Distinctive Ring pattern they give you. This is so your machine can recognize its incoming calls.







Note

You can change or cancel the Distinctive Ring pattern at any time. You can switch it off temporarily, and turn it back on later. When you get a new fax number, make sure you reset this feature.

Before you choose the ring pattern to register

You can only register one Distinctive Ring pattern with the machine. Some ring patterns cannot be registered. The ring patterns below are supported by your Brother machine. Register the one your telephone company gives you.

Ring Pattern	Rings	
1	long-long	
2	short-long-short	
3	short-short-long	
4	very long (normal pattern)	



Note

If the ring pattern you received is not on this chart, **please call your telephone company and ask for one that is shown.**

- The machine will only answer calls to its registered number.
- The first two rings are silent on the machine. This is because the fax must 'listen' to the ring pattern (to compare it to the pattern that was 'registered'). (Other telephones on the same line will ring.)
- If you program the machine properly, it will recognize the registered ring pattern of the 'fax number' within 2 ring patterns and then answer with a fax tone. When the 'voice number' is called, the machine will not answer.

Registering the Distinctive Ring pattern

After you have set the Distinctive Ring feature to on, the receive mode is set to *Manual* automatically. You cannot change the receive mode to another mode while the Distinctive Ring is set to on.

- 1 Press **Menu**.
- 2 Press **▲** or **▼** to choose *Fax*. Press **OK**.
- 3 Press **▲** or **▼** to choose *Miscellaneous*. Press **OK**.
- 4 Press **▲** or **▼** to choose *Distinctive*. Press **OK**.
- 5 Press **▲** or **▼** to choose *Set*. Press **OK**.
- 6 Press **▲** or **▼** to choose the stored ring pattern you want to use. Press **OK**. (You hear each pattern as you scroll through the four patterns. Make sure you choose the pattern that the telephone company gave you.)
- 7 Press **Stop/Exit**. Distinctive Ring is now set to on.

Turning off Distinctive Ring

- 1 Press **Menu**.
- 2 Press **▲** or **▼** to choose *Fax*. Press **OK**.
- 3 Press **▲** or **▼** to choose *Miscellaneous*. Press **OK**.
- 4 Press **▲** or **▼** to choose *Distinctive*. Press **OK**.
- 5 Press **▲** or **▼** to choose *Off*. Press **OK**.
- 6 Press **Stop/Exit**.



Note

If you turn off Distinctive Ring, the machine will stay in *Manual* receive mode. You will need to set the Receive Mode again. (See *Choosing the Receive Mode* on page 46.)

Caller ID

The Caller ID feature lets you use the Caller ID subscriber service offered by many local telephone companies. Call your telephone company for details. This service shows the telephone number, or name if it is available, of your caller as the line rings.

You can use a number in the Caller ID History to make a phone call (MFC-665CW and MFC-845CW only), send a fax, add it to Speed-Dial, or delete it from the history. (See *Caller ID history* on page 65.)

After a few rings, the LCD shows the telephone number of your caller (and name, if available). Once you answer a call, the Caller ID information disappears from the LCD, but the call information stays stored in the Caller ID memory.

- You can see the first 15 characters of the number (or name).
- The *Out of Area* message means the call originated outside your Caller ID service area.
- The *Private Call* message means the caller has intentionally blocked transmission of information.

You can print a list of the Caller ID information received by your machine. (See *Printing Caller ID List* on page 57.)



Note

- This feature may not be available in certain areas of the USA and Canada.
- Caller ID service varies with different carriers. Call your local telephone company to find out about the kind of service available in your area.

Setting up your area code (USA only)

Your machine will automatically dial "1" plus the area code for any number that does not originate in your area code. The machine can identify local calls from your area code by entering your area code in the *Area Code* setting. With this setting, calls returned from the caller ID history to your area code will be dialed using only 7-digits. If you must dial the area code to call within your area code, do not enter this setting. If your dialing plan does not follow the standard 1 + area code + 7-digit number dialing system for calling outside your area code, you may experience problems returning calls automatically from the caller ID history. If this is not the procedure followed by your dialing plan, you will not be able to return calls automatically.

- 1 Press **Menu**.
- 2 Press **▲** or **▼** to choose *Fax*. Press **OK**.
- 3 Press **▲** or **▼** to choose *Miscellaneous*. Press **OK**.
- 4 Press **▲** or **▼** to choose *Caller ID*. Press **OK**.
- 5 Press **▲** or **▼** to choose *Area Code*. Press **OK**.
- 6 Use the dial pad to enter your area code. Press **OK**.
- 7 Press **Stop/Exit**.

Viewing Caller ID List

Your machine stores information for the last thirty calls in the Caller ID list. You can view or print this list. When the thirty-first call comes in to the machine, it replaces information about the first call.

- 1 Press **Menu**.
- 2 Press **▲** or **▼** to choose *Fax*. Press **OK**.

- 3 Press ▲ or ▼ to choose `Miscellaneous`. Press **OK**.
- 4 Press ▲ or ▼ to choose `Caller ID`. Press **OK**.
- 5 Press ▲ or ▼ to choose `Display#`. Press **OK**.
The Caller ID list will appear on the display. If no ID is stored, the beeper will sound and `No Caller ID` will appear on the display.
- 6 Press ▲ or ▼ to scroll through the Caller ID memory to view the Caller ID information.
The LCD shows the caller's number or name and the date and time of the call.
- 7 To finish viewing, press **Stop/Exit**.

**Note**

You can also view the Caller ID list by pressing  (**Fax**). (See *Caller ID history* on page 65.)

Printing Caller ID List

- 1 Press **Menu**.
- 2 Press ▲ or ▼ to choose `Fax`. Press **OK**.
- 3 Press ▲ or ▼ to choose `Miscellaneous`. Press **OK**.
- 4 Press ▲ or ▼ to choose `Caller ID`. Press **OK**.
- 5 Press ▲ or ▼ to choose `Print Report`. Press **OK**.
If no ID is stored, the beeper will sound and `No Caller ID` will appear on the LCD.
- 6 Press **Black Start** or **Color Start**.
- 7 After printing has finished, press **Stop/Exit**.

Connecting an external TAD (telephone answering device)

You may choose to connect an external answering device. However, when you have an **external** TAD on the same telephone line as the machine, the TAD answers all calls and the machine 'listens' for fax calling (CNG) tones. If it hears them, the machine takes over the call and receives the fax. If it does not hear CNG tones, the machine lets the TAD continue playing your outgoing message so your caller can leave you a voice message.

The TAD must answer within four rings (the recommended setting is two rings). The machine cannot hear CNG tones until the TAD has answered the call, and with four rings there are only 8 to 10 seconds of CNG tones left for the fax 'handshake'. Make sure you carefully follow the instructions in this guide for recording your outgoing message. We do not recommend using the toll saver feature on your external answering machine if it exceeds five rings.

**Note**

- If you do not receive all your faxes, reduce the Ring Delay setting on your external TAD.
- If You Subscribe to your Telephone company's Distinctive Ring Service:
You may connect an external TAD to a separate wall jack only if you subscribe to your telephone company's Distinctive Ring service, have registered the distinctive ring pattern on your machine, and use that number as a fax number. The recommended setting is at least four rings on the external TAD when you have the telephone company's Distinctive Ring Service. You cannot use the Toll Saver setting.

- If You Do Not Subscribe to Distinctive Ring Service:

You must plug your TAD into the EXT. jack of your machine. If your TAD is plugged into a wall jack, both your machine and the TAD will try to control the phone line. (See the illustration below.)

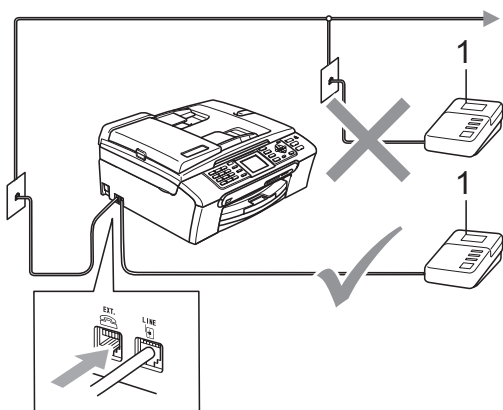

1 TAD

When the TAD answers a call, the LCD shows `Telephone` (MFC-440CN) or `Ext. Tel in Use` (MFC-665CW and MFC-845CW).

Connections

The external TAD must be plugged into the jack labeled EXT. Your machine cannot work properly if you plug the TAD into a wall jack (unless you are using Distinctive Ring).

- 1 Plug the telephone line cord from the telephone wall jack into the jack labeled LINE.
- 2 Plug the telephone line cord from the external TAD into the jack labeled EXT. (Make sure this cord is connected to the TAD at the TAD's telephone line jack, and not its handset jack.)
- 3 Set your external TAD to four rings or less. (The machine's Ring Delay setting does not apply.)
- 4 Record the outgoing message on your external TAD.
- 5 Set the TAD to answer calls.
- 6 Do one of the following:
 - (For MFC-440CN)
Set the Receive Mode to `External TAD`.
 - (For MFC-665CW and MFC-845CW)
Set the Receive Mode to `Manual` with Easy Receive turned on. (See *Choosing the Receive Mode* on page 46.)

Recording outgoing message (OGM) on an external TAD

Timing is important in recording this message. The message sets up the ways to handle both manual and automatic fax reception.

- 1 Record 5 seconds of silence at the beginning of your message. (This allows your machine time to listen for the fax CNG tones of automatic transmissions before they stop.)
- 2 Limit your speaking to 20 seconds.
- 3 End your 20-second message by giving your Fax Receive Code for people sending manual faxes. For example: 'After the beep, leave a message or send a fax by pressing ✕ 5 1 and **Start**.'



Note

We recommend beginning your OGM with an initial 5-second silence because the machine cannot hear fax tones over a resonant or loud voice. You may try omitting this pause, but if your machine has trouble receiving, then you must re-record the OGM to include it.

Special line considerations

Roll over phone lines

A roll over phone system is a group of two or more separate telephone lines that pass incoming calls to each other if they are busy. The calls are usually passed down or 'rolled over' to the next available phone line in a preset order.

Your machine can work in a roll over system as long as it is the last number in the sequence, so the call cannot roll away. Do not put the machine on any of the other numbers; when the other lines are busy and a second fax call is received, the fax call will be sent to a line that does not have a fax machine. **Your machine will work best on a dedicated line.**

Two-line phone system

A two-line phone system is nothing more than two separate phone numbers on the same wall outlet. The two phone numbers can be on separate jacks (RJ11) or mixed into one jack (RJ14). Your machine must be plugged into an RJ11 jack. RJ11 and RJ14 jacks may be equal in size and appearance and both may contain four wires (black, red, green, yellow). To test the type of jack, plug in a two-line phone and see if it can access both lines. If it can, you must separate the line for your machine. (See page 50.)

Converting telephone wall outlets

There are three ways to convert to an RJ11 jack. The first two ways may require help from the telephone company. You can change the wall outlets from one RJ14 jack to two RJ11 jacks. Or you can have an RJ11 wall outlet installed and slave or jump one of the phone numbers to it.

The third way is the easiest: Buy a triplex adapter. You can plug a triplex adapter into an RJ14 outlet. It separates the wires into two separate RJ11 jacks (Line 1, Line 2) and a third RJ14 jack (Lines 1 and 2). If your machine is on Line 1, plug the machine into L1 of the triplex adapter. If your machine is on Line 2, plug it into L2 of the triplex adapter.

Triplex Adapter

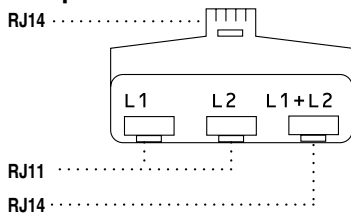

Installing machine, external two-line TAD and two-line telephone

When you are installing an external two-line telephone answering device (TAD) and a two-line telephone, your machine must be isolated on one line at both the wall jack and at the TAD. The most common connection is to put the machine on Line 2, which is explained in the following steps. The back of the two-line TAD must have two telephone jacks: one labeled L1 or L1/L2, and the other labeled L2. You will need at least three telephone line cords, the one that came with your machine and two for your external two-line TAD. You will need a fourth line cord if you add a two-line telephone.

- 1 Put the two-line TAD and the two-line telephone next to your machine.

- 2 Plug one end of the telephone line cord for your machine into the L2 jack of the triplex adapter. Plug the other end into the LINE jack on the back of the machine.
- 3 Plug one end of the first telephone line cord for your TAD into the L1 jack of the triplex adapter. Plug the other end into the L1 or L1/L2 jack of the two-line TAD.
- 4 Plug one end of the second telephone line cord for your TAD into the L2 jack of the two-line TAD. Plug the other end into the EXT. jack on the left side of the machine.

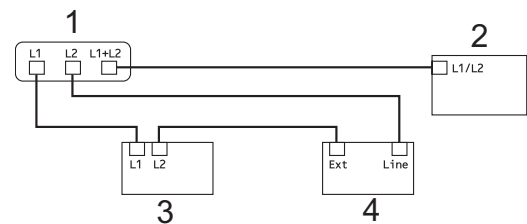

- 1 Triplex Adapter
- 2 Two Line Phone
- 3 External Two Line TAD
- 4 Machine

You can keep two-line telephones on other wall outlets as always. There are two ways to add a two-line telephone to the machine's wall outlet. You can plug the telephone line cord from the two-line telephone into the L1+L2 jack of the triplex adapter. Or you can plug the two-line telephone into the TEL jack of the two-line TAD.

Multi-line connections (PBX)

We suggest you ask the company who installed your PBX to connect your machine. If you have a multi line system we suggest you ask the installer to connect the unit to the last line on the system. This prevents the machine being activated each time the system receives telephone calls. If all incoming calls will be answered by a switchboard operator we recommend that you set the Receive Mode to *Manual*.

We cannot guarantee that your machine will operate properly under all circumstances when connected to a PBX. Any difficulties with sending or receiving faxes should be reported first to the company who handles your PBX.

External and extension phones

Connecting an external or extension telephone

You can connect a separate telephone (or telephone answering device) directly to your machine as shown in the diagram below.

Connect the telephone line cord to the jack labeled EXT.

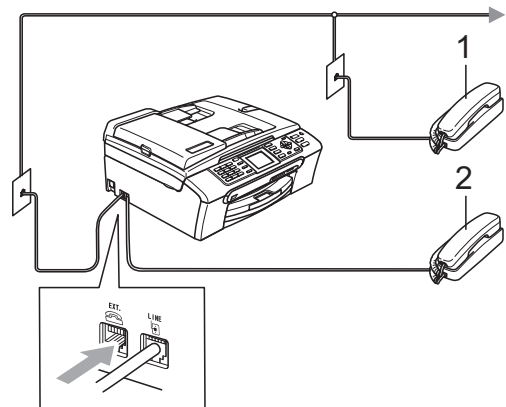

1 Extension telephone

2 External telephone

When you are using an external or extension phone, the LCD shows *Telephone* (MFC-440CN) or *Ext. Tel in Use* (MFC-665CW and MFC-845CW).

Using external and extension telephones

If you answer a fax call on an extension or an external telephone connected to the EXT. jack of the machine, you can make your machine take the call by using the Fax Receive Code. When you press the Fax Receive Code *** 5 1**, the machine starts to receive the fax.

If the machine answers a voice call and pseudo/double-rings for you to take over, use the Telephone Answer Code **# 5 1** to take the call at an extension phone. (See *F/T Ring Time (Fax/Tel mode only)* on page 49.)

If you answer a call and no one is on the line:

You should assume that you're receiving a manual fax.

Press **✕ 5 1** and wait for the chirp or until the LCD shows *Receiving*, and then hang up.



Note

You can also use the Easy Receive feature to make your machine automatically take the call. (See *Easy Receive* on page 50.)

Using a Non-Brother cordless external telephone (MFC-440CN and MFC-665CW only)

If your non-Brother cordless telephone is connected to the EXT. jack of the machine and you typically carry the cordless handset elsewhere, it is easier to answer calls during the Ring Delay.

If you let the machine answer first, you will have to go to the machine so you can press **Hook** or **Speaker Phone** to send the call to the cordless handset.

Using remote codes

Fax receive code

If you answer a fax call on an extension or external telephone, you can tell your machine to receive it by dialing the fax receive code **✕ 5 1**. Wait for the chirping sounds then replace the handset. See *Easy Receive* on page 50. Your caller will have to press **Start** to send the fax.

Telephone answer code

If you receive a voice call and the machine is in F/T mode, it will start to sound the F/T (double) ring after the initial ring delay. If you pick up the call on an extension phone you can turn the F/T ring off by pressing **# 5 1** (make sure you press this *between* the rings).

Changing the remote codes

The preset Fax Receive Code is **✕ 5 1**. The preset Telephone Answer Code is **# 5 1**. If you want to, you can replace them with your own codes.

- 1 Press **Menu**.
- 2 Press **▲** or **▼** to choose *Fax*. Press **OK**.
- 3 Press **▲** or **▼** to choose *Setup Receive*. Press **OK**.
- 4 Press **▲** or **▼** to choose *Remote Codes*. Press **OK**.
- 5 Press **▲** or **▼** to choose *On* (or *Off*). Press **OK**.
- 6 Enter the new Fax Receive Code. Press **OK**.
- 7 Enter the new Telephone Answer Code. Press **OK**.
- 8 Press **Stop/Exit**.



Note

- If you are always disconnected when accessing your external TAD remotely, try changing the Fax Receive Code and Telephone Answer Code to another three-digit code (such as **###** and **999**).
- Remote Codes might not work with some telephone systems.

How to Dial

Manual dialing

Press all of the digits of the fax or telephone number.



Speed-Dialing

- 1 Press **Search/Speed Dial**.

MFC-440CN



MFC-665CW and MFC-845CW



You can also choose *Speed-Dial* by pressing  (**Fax**).

- 2 Press the two-digit *Speed-Dial* number. (See *Storing Speed-Dial numbers* on page 66.)

- 3 If you have two numbers in the location, press **▲** or **▼** to choose the number you want to call. Press **OK**.



Note

If the LCD shows *Not Registered* when you enter a *Speed-Dial* number, a number has not been stored at this location.

Search

You can search for names you have stored in the *Speed-Dial* memory.

- 1 Press **Search/Speed Dial**. You can also choose *Speed-Dial* by pressing  (**Fax**).
- 2 Press **▲** or **▼** to choose *Alphabetical Order* or *Numerical Order*. Press **OK**.



Note

- Press ***** to make the LCD font size larger.
- Press **#** to make the LCD font size smaller.

- 3 If you chose *Alphabetical Order* in step 2, use the dial pad to enter the first letter of the name, and then press **▲** or **▼** to choose the name and number you want to call. Press **OK**.

Fax Redial

If you are sending a fax manually and the line is busy, press **Redial/Pause**, and then press **Black Start** or **Color Start** to try again. If you want to make a second call to a number you recently dialed, you can press **Redial/Pause** and choose one of the last 30 numbers from the Outgoing Call List.

Redial/Pause only works if you dialed from the control panel. *If you are sending a fax automatically* and the line is busy, the machine will automatically redial once after five minutes.

- 1 Press **Redial/Pause**.
- 2 Press ▲ or ▼ to choose the number you want to redial.
Press **OK**.
- 3 Press ▲ or ▼ to choose *Send a Fax*.
Press **OK**.
- 4 Press **Black Start** or **Color Start**.



Note

In Real Time Transmission the automatic redial feature does not work when using the scanner glass.

Outgoing Call

The last 30 numbers you telephoned (MFC-665CW and MFC-845CW only) or sent a fax to will be stored in the outgoing call history. You can choose one of these numbers to telephone (MFC-665CW and MFC-845CW only), fax to, add to Speed-Dial, or delete from the history.

- 1 Press **Redial/Pause**.
You can also choose *Outgoing Call* by pressing  (**Fax**).
- 2 Press ▲ or ▼ to choose the number you want to call.
Press **OK**.
- 3 Do one of the following:
 - (MFC-665CW and MFC-845CW only)
To make a phone call, press ▲ or ▼ to choose *Make a Phone Call*.
Press **OK**.
 - To send a fax, press ▲ or ▼ to choose *Send a Fax*.
Press **OK**.
 - If you want to store the number, press ▲ or ▼ to choose *Add to Speed-Dial*.
Press **OK**.
(See *Storing Speed-Dial numbers from Outgoing Calls* on page 66.)
 - Press ▲ or ▼ to choose *Delete*.
Press **OK**.
Then, confirm the Delete by pressing **1**.

Caller ID history

This feature requires the Caller ID subscriber service offered by many local telephone companies. (See *Caller ID* on page 56.)

The last 30 numbers of phone calls (MFC-665CW and MFC-845CW only) or faxes you received will be stored in the Caller ID history. You can choose one of these numbers to telephone (MFC-665CW and MFC-845CW only), fax to, add to Speed-Dial, or delete from the history.

- 1 Press  (Fax).
- 2 Press ▲ or ▼ to choose
Caller ID hist..
Press **OK**.
- 3 Press ▲ or ▼ to choose the number you want to call.
Press **OK**.
- 4 Do one of the following:
 - (MFC-665CW and MFC-845CW only)
To make a phone call, press ▲ or ▼ to choose *Make a Phone Call*.
Press **OK**.
 - To send a fax, press ▲ or ▼ to choose *Send a Fax*.
Press **OK**.
 - If you want to store the number, press ▲ or ▼ to choose *Add to Speed-Dial*.
Press **OK**.
(See *Storing Speed-Dial numbers from Outgoing Calls* on page 66.)
 - Press ▲ or ▼ to choose *Delete*.
Press **OK**.
Then, confirm the Delete by pressing **1**.



Note

- (USA only) If you redial from the Caller ID history outside your area code, you must set up your AREA CODE in advance. (See *Setting up your area code (USA only)* on page 56.)
- You can print the Caller ID list. (See *Printing Caller ID List* on page 57.)

Storing numbers

You can set up your machine to do the following types of easy dialing: Speed-Dial and Groups for broadcasting faxes. When you dial a Quick-Dial number, the LCD shows the name, if you stored it, or the number.



Note

If you lose electrical power, the Quick-Dial numbers that are in the memory will not be lost.

Storing a pause

Press **Redial/Pause** to put a 3.5-second pause between numbers. If you are dialing overseas, you can press **Redial/Pause** as many times as needed to increase the length of the pause.

Storing Speed-Dial numbers

You can store up to 80 (MFC-440CN and MFC-665CW) or 100 (MFC-845CW) 2-digit Speed-Dial locations with a name, and each name can have two numbers. When you dial you will only have to press a few keys (For example: **Search/Speed Dial**, the two-digit number, and **Black Start** or **Color Start**).

- 1 Press **Menu**.
- 2 Press **▲** or **▼** to choose **Fax**. Press **OK**.
- 3 Press **▲** or **▼** to choose **Set Quick-Dial**. Press **OK**.
- 4 Press **▲** or **▼** to choose **Speed-Dial**. Press **OK**.
- 5 Press **▲** or **▼** to choose the 2-digit Speed-Dial location you want to store the number in. Press **OK**.

- 6 Do one of the following:
 - Enter the name (up to 16 characters) using the dial pad. Press **OK**.
(To help you enter letters, see *Entering Text* on page 174.)
 - To store the number without a name, press **OK**.
- 7 Enter the fax or telephone number (up to 20 digits). Press **OK**.
- 8 Do one of the following:
 - Enter the second fax or telephone number (up to 20 digits). Press **OK**.
 - If you do not want to store a second number, press **OK**.
- 9 Do one of the following:
 - To store another Speed-Dial number, go to step 6.
 - To finish the setting, press **Stop/Exit**.

Storing Speed-Dial numbers from Outgoing Calls

You can also store Speed-Dial numbers from the Outgoing Call history.

- 1 Press **Redial/Pause**. You can also choose **Outgoing Call** by pressing  (**Fax**).
- 2 Press **▲** or **▼** to choose the name or number you want to store. Press **OK**.
- 3 Press **▲** or **▼** to choose **Add to Speed-Dial**. Press **OK**.
- 4 Press **▲** or **▼** to choose the 2-digit Speed-Dial location you want to store the number in. Press **OK**.

- 5 Do one of the following:
 - Enter the name (up to 16 characters) using the dial pad.
Press **OK**.
(To help you enter letters, see *Entering Text* on page 174.)
 - To store the number without a name, press **OK**.
 - 6 Press **OK** to confirm the fax or telephone number.
 - 7 Do one of the following:
 - Enter the second fax or telephone number (up to 20 digits).
Press **OK**.
 - If you do not want to store a second number, press **OK**.
 - 8 Press **Stop/Exit**.
- 6 Do one of the following:
 - Enter the name (up to 16 characters) using the dial pad.
Press **OK**.
(To help you enter letters, see *Entering Text* on page 174.)
 - To store the number without a name, press **OK**.
 - 7 Press **OK** to confirm the fax or telephone number.
 - 8 Do one of the following:
 - Enter the second fax or telephone number (up to 20 digits).
Press **OK**.
 - If you do not want to store a second number, press **OK**.
 - 9 Press **Stop/Exit**.

Storing Speed-Dial numbers from the Caller ID history

If you have the Caller ID subscriber service from your telephone company you can also store Speed-Dial numbers from incoming calls in the Caller ID History. (See *Caller ID* on page 56.)

- 1 Press  (**Fax**).
- 2 Press **▲** or **▼** to choose `Caller ID hist..`
Press **OK**.
- 3 Press **▲** or **▼** to choose the number you want to store.
Press **OK**.
- 4 Press **▲** or **▼** to choose `Add to Speed-Dial`.
Press **OK**.
- 5 Press **▲** or **▼** to choose the 2-digit Speed-Dial location you want to store the number in.
Press **OK**.

Changing Speed-Dial names or numbers

You can change or delete a Speed-Dial number that has already been stored.

- 1 Press **Menu**.
- 2 Press **▲** or **▼** to choose `Fax`.
Press **OK**.
- 3 Press **▲** or **▼** to choose `Set Quick-Dial`.
Press **OK**.
- 4 Press **▲** or **▼** to choose `Speed-Dial`.
Press **OK**.
- 5 Press **▲** or **▼** to choose the 2-digit Speed-Dial location you want to change.
Press **OK**.
- 6 Do one of the following:
 - Press **▲** or **▼** to choose `Change`.
Press **OK**.
 - Press **▲** or **▼** to choose `Delete`.
Press **OK**.
Then, confirm the Delete by pressing 1 and **Stop/Exit**.

**Note**

How to change the stored name or number:

If you want to change a character, press ◀ or ▶ to position the cursor under the character you want to change, and then press **Clear/Back**. Re-enter the character.

- 7 Do one of the following:
 - Enter the name (up to 16 characters) using the dial pad. Press **OK**. (See *Entering Text* on page 174.)
 - If you do not want to change the name, press **OK**.
- 8 Do one of the following:
 - Enter the new fax or telephone number (up to 20 digits). Press **OK**.
 - If you do not want to change the number, press **OK**.
- 9 Do one of the following:
 - Enter the second new fax or telephone number (up to 20 digits). Press **OK**.
 - If you do not want to change the number, press **OK**.
- 10 Press **Stop/Exit**.

Setting up groups for broadcasting

Groups, which can be stored on a Speed-Dial location, allow you to send the same fax message to many fax numbers by pressing only **Search/Speed Dial**, the two-digit location and **Black Start**. First, you'll need to store each fax number in a Speed-Dial location. Then you can include them as numbers in the Group. Each Group uses up a Speed-Dial location. You can have up to six Groups, or you can assign up to 158 numbers (MFC-440CN and MFC-665CW) or 198 numbers (MFC-845CW) in large Group if you have 2 numbers in each location.

(See *Storing Speed-Dial numbers* on page 66 and *Broadcasting (Black & White only)* on page 40.)

- 1 Press **Menu**.
- 2 Press ▲ or ▼ to choose **Fax**. Press **OK**.
- 3 Press ▲ or ▼ to choose **Set Quick-Dial**. Press **OK**.
- 4 Press ▲ or ▼ to choose **Setup Groups**. Press **OK**.
- 5 Press ▲ or ▼ to choose **GROUP 1**, **GROUP 2**, **GROUP 3**, **GROUP 4**, **GROUP 5** or **GROUP 6** for the Group name where you will store the fax numbers. Press **OK**.
- 6 Press ▲ or ▼ to choose the 2-digit location where you want to add to the Group. Press **OK**.
- 7 Press ▲ or ▼ to choose **Add Number**. Press **OK**.

- 8 Press ▲ or ▼ to choose the number you want to add.
Press **OK**.
(See *Search* on page 63.)
- 9 After you have finished adding numbers by repeating steps 7 and 8, press ▲ or ▼ to choose *Complete*.
Press **OK**.
- 10 Press **Stop/Exit**.



Note

You can print a list of all the Speed-Dial numbers. Group numbers will be marked in the GROUP column. (See *Reports* on page 88.)

Changing Group name

- 1 Press **Menu**.
- 2 Press ▲ or ▼ to choose *Fax*.
Press **OK**.
- 3 Press ▲ or ▼ to choose *Set Quick-Dial*.
Press **OK**.
- 4 Press ▲ or ▼ to choose *Setup Groups*.
Press **OK**.
- 5 Press ▲ or ▼ to choose the Group name you want to change.
Press **OK**.
- 6 Press ▲ or ▼ to choose *Change Group name*.
Press **OK**.



Note

How to change the stored name or number:

If you want to change a character, press ◀ or ▶ to position the cursor under the character you want to change, and then press **Clear/Back**. Re-enter the character.

- 7 Enter the new name (up to 16 characters) using the dial pad.
Press **OK**.
(See *Entering Text* on page 174. For example, type NEW CLIENTS).
- 8 Press ▲ or ▼ to choose *Complete*.
Press **OK**.
- 9 Press **Stop/Exit**.

Deleting a Group

- 1 Press **Menu**.
- 2 Press ▲ or ▼ to choose *Fax*.
Press **OK**.
- 3 Press ▲ or ▼ to choose *Set Quick-Dial*.
Press **OK**.
- 4 Press ▲ or ▼ to choose *Setup Groups*.
Press **OK**.
- 5 Press ▲ or ▼ to choose the Group you want to delete.
Press **OK**.
- 6 Press ▲ or ▼ to choose *Delete*.
Press **OK**.
Then, confirm the Delete by pressing 1.
- 7 Press ▲ or ▼ to choose *Complete*.
Press **OK**.
- 8 Press **Stop/Exit**.

Deleting a number from a Group

- 1 Press **Menu**.
- 2 Press **▲** or **▼** to choose **Fax**. Press **OK**.
- 3 Press **▲** or **▼** to choose **Set Quick-Dial**. Press **OK**.
- 4 Press **▲** or **▼** to choose **Setup Groups**. Press **OK**.
- 5 Press **▲** or **▼** to choose the Group you want to change. Press **OK**.
- 6 Press **▲** or **▼** to choose the number you want to delete. Press **OK**. Then, confirm the Delete by pressing **1**.
- 7 Press **▲** or **▼** to choose **Complete**. Press **OK**.
- 8 Press **Stop/Exit**.

Dialing Access codes and credit card numbers

Sometimes you may want to choose from several long distance carriers when you make a call. Rates may vary depending on the time and destination. To take advantage of low rates, you can store the access codes of long-distance carriers and credit card numbers as Speed-Dial numbers. You can store these long dialing sequences by dividing them and setting them up as separate Speed-Dial numbers in any combination. You can even include manual dialing using the dial pad. (See *Storing Speed-Dial numbers* on page 66.)

For example, you have stored '555' on Speed-Dial: 03 and '7000' on Speed-Dial: 02.

- 1 Press **Search/Speed Dial**.
- 2 Enter **03**.



Note

If you stored 2 numbers in one Speed-Dial location, you will be asked which number you want to send to.

- 3 Press **▲** or **▼** to choose **Speed-Dial**. Press **OK**.
- 4 Enter **02**.
- 5 Press **Black Start** or **Color Start**. You will dial '555-7000'.

To temporarily change a number, you can substitute part of the number with manual dialing using the dial pad. For example, to change the number to 555-7001 you could press **Search/Speed Dial**, **03** and then press **7001** using the dial pad.



Note

If you must wait for another dial tone or signal at any point in the dialing sequence, create a pause in the number by pressing **Redial/Pause**. Each key press adds a 3.5-second delay.

Message Center (MFC-665CW and MFC-845CW only)

Message Center mode

The Message Center feature will store up to 99 incoming messages. Messages are stored in the order in which they are received.

Voice messages can be up to 3 minutes in length, and can also be picked up remotely (see *Using your Remote Access Code* on page 83). The number of messages you can store will depend on how much memory is being used by other features (for example, delayed and stored faxes).

Setting up the Message Center

Recording the Message Center outgoing message (Msg Ctr OGM) is the first step you need to follow before you can use the Message Center.

To enter Message Center mode, follow the steps below:

- 1 Record your Message Center OGM.
- 2 Press  to activate the Message Center.

Outgoing message (OGM)

Recording your OGM

You can record the following two different types of OGM:

■ Msg Ctr OGM

This message will be played when a call is received. The caller will be able to leave a voice or fax message.

■ F/T OGM

This message is played when a call is received and your machine is set to Fax/Tel mode. The caller will not be able to leave a message. See *Fax/Tel OGM (Announcement)* on page 72.

- 1 Press **Menu**.
- 2 Press **▲** or **▼** to choose **Fax**. Press **OK**.
- 3 Press **▲** or **▼** to choose **Setup Msg Ctr**. Press **OK**.
- 4 Press **▲** or **▼** to choose **OGM**. Press **OK**. The LCD prompts you to choose an OGM.
- 5 Press **▲** or **▼** to choose either **Msg Ctr OGM** or **F/T OGM**, then press **OK**.



Note

If callers tell you they cannot leave a message on your machine, make sure you have chosen **Msg Ctr OGM** (not **F/T OGM**).

- 6 Press **▲** or **▼** to choose **Record OGM**. Press **OK**.
- 7 Record your message, using one of the options below:
 - (MFC-665CW only) Pick up the handset, record your message, and replace the handset when finished.
 - (MFC-845CW only) Speak clearly toward the microphone  to record your message. Press **Stop/Exit** when finished.

The Message Center will play your OGM back to you.

- 8 Press **Stop/Exit**.

Listening to your OGM

- 1 Press **Menu**.
- 2 Press **▲** or **▼** to choose *Fax*. Press **OK**.
- 3 Press **▲** or **▼** to choose *Setup Msg Ctr*. Press **OK**.
- 4 Press **▲** or **▼** to choose *OGM*. Press **OK**.
- 5 Press **▲** or **▼** to choose *Msg Ctr OGM* or *F/T OGM*. Press **OK**.
- 6 Press **▲** or **▼** to choose *Playing OGM*. Press **OK**. Adjust the volume by pressing Volume **◀** or **▶**.
- 7 Press **Stop/Exit**.

Erasing your OGM

- 1 Press **Menu**.
- 2 Press **▲** or **▼** to choose *Fax*. Press **OK**.
- 3 Press **▲** or **▼** to choose *Setup Msg Ctr*. Press **OK**.
- 4 Press **▲** or **▼** to choose *OGM*. Press **OK**.
- 5 Press **▲** or **▼** to choose either *Msg Ctr OGM* or *F/T OGM*. Press **OK**.
- 6 Press **▲** or **▼** to choose *Erase OGM*. Press **OK**.

- 7 Do one of the following:
 - Press **1** to erase the OGM.
 - Press **2** to exit without erasing.

- 8 Press **Stop/Exit**.



Fax/Tel OGM (Announcement)

If your machine is set to Fax/Tel receive mode this message will be played by your Brother machine to a caller. Unlike the Msg Ctr OGM, the caller *will not* be able to leave a message.

To record your Fax/Tel OGM follow the instructions on *Outgoing message (OGM)* on page 71 and choose *F/T OGM* (not *Msg Ctr OGM*).

If you need to review the steps for setting up the Fax/Tel receive mode, see *Receive modes* on page 46.

Activating Message Center mode

When the  light glows, Message Center mode is active. Press  to enter MC mode.

Managing your messages

Message indicator

The  light flashes if you have any new messages waiting for you.

The LCD displays the total number of voice and fax messages stored in the Message Center memory.

Fax messages are only stored when Fax Storage or Fax Preview is turned on. See *Advanced fax operations (Black & White only)* on page 76.

Playing voice messages



All messages are played in the order they were recorded. The LCD shows the number of the current message, the total number of messages, and the time and date the message was recorded.

Follow the steps below to listen to your voice messages:

- 1 Press **Play/Record** or **Play**.
The following commands are available when playing messages:

*  (RWD) Repeats a message.

 (FWD) Skips to the next message.

 or  Adjusts the volume.

- 2 Press **Stop/Exit**.

Erasing incoming messages

To erase voice messages individually

- 1 Press **Play/Record** or **Play**.
The machine will sound a two second beep and begins message playback. Each message is preceded by one long beep, and followed by two short beeps.
- 2 To erase a specific message, press **Erase** immediately after the two short beeps, or while the message is playing.
- 3 Do one of the following:
 - Press **1** to erase the message.
 - Press **2** to cancel.
- 4 Press **Stop/Exit**.

To erase all of your messages

- 1 Press **Erase**.
The LCD displays the following:
 - Erase All Voice?
 - Yes→Press **1**
 - No→Press **2**
- 2 Do one of the following:
 - Press **1** to erase all of your voice messages.
 - Press **2** to cancel.
- 3 Press **Stop/Exit**.

Additional Message Center operations

Setting maximum time for incoming messages

Your machine's default setting will save incoming messages up to 30 seconds long. To change this setting follow the steps below:

- 1 Press **Menu**.
- 2 Press **▲** or **▼** to choose **Fax**.
Press **OK**.
- 3 Press **▲** or **▼** to choose **Setup Msg Ctr**.
Press **OK**.
- 4 Press **▲** or **▼** to choose **ICM Max. Time**.
Press **OK**.
- 5 Press **▲** or **▼** to choose the maximum time setting for incoming messages (30, 60, 120 or 180 seconds).
Press **OK**.
- 6 Press **Stop/Exit**.

Setting toll saver

When the toll saver feature is on, the machine will answer after two rings if you do have voice or fax messages, and after four rings if you do not have any messages.

This way, when you call your machine for remote retrieval, if it rings three times, you have no messages and can hang up to avoid a toll charge.

The toll saver feature is only available when Message Center mode is on. When toll saver is **On**, it overrides your ring delay setting.

If you are using Distinctive Ring, do not use the Toll Saver feature.

- 1 Press **Menu**.
- 2 Press ▲ or ▼ to choose **Fax**.
Press **OK**.
- 3 Press ▲ or ▼ to choose
Setup Receive.
Press **OK**.
- 4 Press ▲ or ▼ to choose **Ring Delay**.
Press **OK**.
- 5 Press ▲ or ▼ to choose **Toll Saver**.
Press **OK**.
- 6 Press ▲ or ▼ to choose **On (or Off)**.
Press **OK**.
- 7 Press **Stop/Exit**.

ICM Recording Monitor

This feature lets you turn the speaker volume for voice messages **On** or **Off**. When you turn the monitor **Off**, you will not hear messages as they come in.

- 1 Press **Menu**.
- 2 Press ▲ or ▼ to choose **Fax**.
Press **OK**.
- 3 Press ▲ or ▼ to choose
Setup Msg Ctr.
Press **OK**.
- 4 Press ▲ or ▼ to choose **ICM
Rec.Monitr.**
Press **OK**.
- 5 Use ▲ or ▼ to choose **Off** or **On**.
Press **OK**.
- 6 Press **Stop/Exit**.

Recording a conversation (MFC-665CW only)

If you are using the handset, you can record a telephone conversation by pressing **Play/Record** during the conversation. Your recording can be as long as the incoming message maximum time (up to 3 minutes). The other party will hear an intermittent beeping while recording. To stop recording, press **Stop/Exit**.

10

Advanced fax operations (Black & White only)

You can *only* use one advanced fax operation at a time:

- Fax Forwarding
- Paging
- Fax Storage
- Fax Preview (MFC-665CW and MFC-845CW only)
- PC Fax Receive
- Off

You can change your selection at any time. If received faxes are still in the machine's memory when you change the advanced fax operations, an LCD question will appear. (See *Changing Advanced Fax Operations* on page 82.)

Fax Forwarding

When you choose Fax Forward, your machine stores the received fax in the memory. The machine will then dial the fax number you have programmed and forward the fax message.

- 1 Press **Menu**.
- 2 Press ▲ or ▼ to choose **Fax**. Press **OK**.
- 3 Press ▲ or ▼ to choose **Advanced Fax Operation**. Press **OK**.
- 4 Press ▲ or ▼ to choose **Fwd/Page/Store**. Press **OK**.
- 5 Press ▲ or ▼ to choose **Fax Forward**. Press **OK**.
- 6 Enter the forwarding number (up to 20 digits). Press **OK**.

- 7 Press ▲ or ▼ to choose **Backup Print:On** or **Backup Print:Off**. Press **OK**.



Note

- If you choose **Backup Print:On**, the machine will also print the fax at your machine so you will have a copy. This is the safety feature in case there is a power failure before the fax is forwarded or a problem at the receiving machine.
- (MFC-665CW and MFC-845CW only) The machine can store faxes approximately 24 hours if there is a power failure.
- When Fax Forwarding is turned on your machine will only receive black & white faxes into memory. Color faxes will not be received, unless the sending machine converts them to black & white before sending.

- 8 Press **Stop/Exit**.

Paging

When you choose Paging, your machine dials the pager number you have programmed, and then dials your PIN (Personal identification Number). This activates your pager so you will know that you have a fax message in the memory.

If you have set Paging, a backup copy of the received fax will automatically be printed at the machine.

- 1 Press **Menu**.
- 2 Press **▲** or **▼** to choose **Fax**. Press **OK**.
- 3 Press **▲** or **▼** to choose **Advanced Fax Operation**. Press **OK**.
- 4 Press **▲** or **▼** to choose **Fwd/Page/Store**. Press **OK**.
- 5 Press **▲** or **▼** to choose **Paging**. Press **OK**.
- 6 Enter your pager phone number followed by **# #** (up to 20 digits). Press **OK**.
Do not include the area code if it is the same as that of your machine.
For example, press:
1 8 0 0 5 5 1 2 3 4 # #.
- 7 Do one of the following:
 - If your pager needs a PIN, enter the PIN, press **#**, press **Redial/Pause**, and then enter your fax number followed by **# #**. Press **OK**.
For example, press:
1 2 3 4 5 # Redial/Pause 1 8 0 0 5 5 6 7 8 9 # #

- If you do not need a PIN, press: **Redial/Pause**, and then enter your fax number followed by **# #**. Press **OK**.
For example, press:
Redial/Pause 1 8 0 0 5 5 6 7 8 9 # #

- 8 Press **Stop/Exit**.



Note

- You cannot change a paging number or PIN remotely.
- If Paging is turned on your machine cannot receive a color fax unless the sending machine converts it to black & white.
- (MFC-665CW and MFC-845CW only)
If you want to be paged for voice messages, make sure you pressed MC on/off key to turn the Message Center on.

Fax Storage

If you choose Fax Storage, your machine stores the received fax in the memory. You will be able to retrieve fax messages from another location using the remote retrieval commands.

If you have set Fax Storage, a backup copy will automatically be printed at the machine.

- 1 Press **Menu**.
- 2 Press **▲** or **▼** to choose `Fax`. Press **OK**.
- 3 Press **▲** or **▼** to choose `Advanced Fax Operation`. Press **OK**.
- 4 Press **▲** or **▼** to choose `Fwd/Page/Store`. Press **OK**.
- 5 Press **▲** or **▼** to choose `Fax Storage`. Press **OK**.
- 6 Press **Stop/Exit**.



Note

If Fax Storage is turned on your machine cannot receive a color fax unless the sending machine converts it to black & white.

Fax Preview (MFC-665CW and MFC-845CW only)

If you choose Fax Preview you can view received faxes on the LCD by pressing the **Fax Preview** key. When the machine is in Ready mode, a popup message will appear on the LCD to alert you of new faxes. You can continue all operations.

Setting Fax Preview

- 1 Press **Menu**.
- 2 Press **▲** or **▼** to choose `Fax`. Press **OK**.
- 3 Press **▲** or **▼** to choose `Advanced Fax Operation`. Press **OK**.
- 4 Press **▲** or **▼** to choose `Fwd/Page/Store`. Press **OK**.
- 5 Press **▲** or **▼** to choose `Fax Preview`. Press **OK**.
- 6 Press **Stop/Exit**.



Note

When Fax Preview is turned on your machine can only print the color faxes it receives. It cannot store them in memory.

How to preview a fax

When you receive a fax, you will see the pop-up message on the LCD. (For example: New Fax(es) : 02)

- 1 Press **Fax Preview**.
You can see the new fax list.



Note

You can also see your old fax list by pressing *****. Press **#** to go back to your new fax list.

- 2 Press **▲** or **▼** to choose the fax you want to see.
Press **OK**.











Note

If your fax is large there may be a delay before it is displayed on the LCD.

- 3 Press **Stop/Exit**.

When a fax is open the control panel keys will perform the operations shown below.

Key	Description
	Enlarge the fax.
	Reduce the fax.
▲ or ▼	Scroll vertically.
◀ or ▶	Scroll horizontally.
	Rotate the fax clockwise.
	Delete the fax. Then, confirm the Delete by pressing 1 .
	Go back to the previous page.
	Go to the next page.
OK 	Go to the next step. (Print, Back and Exit are available.)
Clear / Back 	Go back to the fax list.
 Black Start	Print the fax.

How to delete all faxes in the list

- 1 Press **Fax Preview**.
- 2 Press **▲** or **▼** to choose **Delete All**.
Press **OK**.
Then, confirm the Delete by pressing **1**.

How to print all faxes in the list

- 1 Press **Fax Preview**.
- 2 Press **▲** or **▼** to choose **Print All**.
Press **OK**.

PC Fax Receive

If you turn on the PC-Fax Receive feature your machine will store received faxes in memory and send them to your PC automatically. You can then use your PC to view and store these faxes.

Even if you have turned off your PC (at night or on the weekend, for example), your machine will receive and store your faxes in its memory. The number of received faxes that are stored in the memory will appear at the bottom left side of the LCD.

When you start your PC and the PC-FAX Receiving software runs, your machine transfers your faxes to your PC automatically.

To transfer the received faxes to your PC you must have the PC-FAX Receiving software running on your PC. (For details, see *PC-FAX receiving* in the Software User's Guide on the CD-ROM.)

If you choose `Backup Print:On` the machine will also print the fax.

- 1 Press **Menu**.
- 2 Press **▲** or **▼** to choose `Fax`. Press **OK**.
- 3 Press **▲** or **▼** to choose `Advanced Fax Operation`. Press **OK**.
- 4 Press **▲** or **▼** to choose `Fwd/Page/Store`. Press **OK**.
- 5 Press **▲** or **▼** to choose `PC Fax Receive`. Press **OK**.
- 6 Press **▲** or **▼** to choose `<USB>` or the PC you want to receive. Press **OK**.

- 7 Press **▲** or **▼** to choose `Backup Print:On` or `Backup Print:Off`. Press **OK**.

- 8 Press **Stop/Exit**.



Note

- PC Fax Receive is not supported in the Mac OS®.
- Before you can set up PC Fax Receive you must install the MFL-Pro Suite software on your PC. Make sure your PC is connected and turned on. (For details see *PC-FAX Receiving* in the Software User's Guide on the CD-ROM.)
- (MFC-665CW and MFC-845CW only) In the event of a power failure, the machine will store your faxes in the memory for approximately 24 hours. However, if you choose `Backup Print:On` the machine will print the fax, so you will have a copy if there is a power failure before it is sent to the PC.
- If you get an error message and the machine cannot print the faxes in memory, you can use this setting to transfer your faxes to your PC. (For details, see *Error messages* on page 136.)
- When PC Fax Receive is turned on only black & white faxes can be received into the memory and sent to the PC. Color faxes will be received in real time and printed in color.

Changing the destination PC

- 1 Press **Menu**.
- 2 Press **▲** or **▼** to choose `Fax`.
Press **OK**.
- 3 Press **▲** or **▼** to choose
Advanced Fax Operation.
Press **OK**.
- 4 Press **▲** or **▼** to choose
Fwd/Page/Store.
Press **OK**.
- 5 Press **▲** or **▼** to choose
PC Fax Receive.
Press **OK**.
- 6 Press **▲** or **▼** to choose `Change`.
Press **OK**.
- 7 Press **▲** or **▼** to choose `<USB>` or the
PC you want to receive.
Press **OK**.
- 8 Press **▲** or **▼** to choose
Backup Print:On or
Backup Print:Off.
Press **OK**.
- 9 Press **Stop/Exit**.

Turning off Advanced Fax Operations

- 1 Press **Menu**.
- 2 Press **▲** or **▼** to choose `Fax`.
Press **OK**.
- 3 Press **▲** or **▼** to choose
Advanced Fax Operation.
Press **OK**.
- 4 Press **▲** or **▼** to choose
Fwd/Page/Store.
Press **OK**.
- 5 Press **▲** or **▼** to choose `Off`.
Press **OK**.
- 6 Press **Stop/Exit**.



Note

The LCD will give you more options if there are received faxes still in your machine's memory. (See *Changing Advanced Fax Operations* on page 82.)

Changing Advanced Fax Operations

If received faxes are left in your machine's memory when you change the Advanced Fax Operations, the LCD will ask you one of the following questions:

■ Erase All Fax?

Yes → Press **1**

No → Press **2**

■ Print All Fax?

Yes → Press **1**

No → Press **2**

- If you press **1**, faxes in the memory will be erased or printed before the setting changes. If a backup copy has already been printed it will not be printed again.
- If you press **2**, faxes in the memory will not be erased or printed and the setting will be unchanged.

If received faxes are left in the machine's memory when you change to PC Fax Receive from another option [Fax Forward, Paging, Fax Storage or Fax Preview (MFC-665CW and MFC-845CW only)], press ▲ or ▼ to choose the PC.

The LCD will ask you the following message:

■ Send Fax to PC?

Yes → Press **1**

No → Press **2**

- If you press **1**, faxes in the memory will be sent to your PC before the setting changes. You will be asked if you want to turn on Backup Print. (For detail, see *PC Fax Receive* on page 80.)
- If you press **2**, faxes in the memory will not be erased or transferred to your PC and the setting will be unchanged.

Remote Retrieval

You can call your machine from any touch tone telephone or fax machine, then use the remote access code and remote commands to retrieve fax messages.

Setting a Remote Access Code

The remote access code lets you access the remote retrieval features when you are away from your machine. Before you can use the remote access and retrieval features, you have to set up your own code. The factory default code is inactive code (---✳).

- 1 Press **Menu**.
- 2 Press ▲ or ▼ to choose **Fax**. Press **OK**.
- 3 Press ▲ or ▼ to choose **Advanced Fax Operation**. Press **OK**.
- 4 Press ▲ or ▼ to choose **Remote Access**. Press **OK**.
- 5 Enter a three-digit code using numbers **0-9**, **✳**, or **#**. Press **OK**. (The preset '✳' cannot be changed.)



Note

Do not use the same code as your fax receive code (✳ 5 1) or telephone answer code (# 5 1). (See *Using external and extension telephones* on page 61.)

- 6 Press **Stop/Exit**.

**Note**

You can change your code at any time by entering a new one. If you want to make your code inactive, press **Clear/Back** in step ⑤ to restore the inactive setting (---*) and press **OK**.

**Note**

If your machine is set to **Manual** mode and you want to use the remote retrieval features, wait about 2 minutes after it starts ringing, and then enter the remote access code within 30 seconds.

Using your Remote Access Code

- ① Dial your fax number from a touch tone telephone or another fax machine.
- ② When your machine answers, enter your remote access code (3 digits followed by *) at once.
- ③ The machine signals if it has received messages:
 - **1 long beep — Fax messages**
 - **2 long beeps — Voice messages**
(MFC-665CW and MFC-845CW only)
 - **3 long beeps — Fax & Voice messages**
(MFC-665CW and MFC-845CW only)
 - **No beeps — No messages**
- ④ When the machine gives two short beeps, enter a command.
The machine will hang up if you wait longer than 30 seconds to enter a command.
The machine will beep three times if you enter an invalid command.
- ⑤ Press **9 0** to reset the machine when you have finished.
- ⑥ Hang up.

Remote Fax commands

Follow the commands below to access features when you are away from the machine. When you call the machine and enter your remote access code (3 digits followed by *), the system will give two short beeps and you must enter a remote command.

Remote commands		Operation details	
91	Playing Voice messages (MFC-665CW and MFC-845CW only)	After one long beep, the machine plays the ICM.	
	1 Repeat or Skip Backward	Press 1 while listening to an ICM to repeat it. If you press 1 before a message, you will hear the previous message.	
	2 Skip Forward	While playing the ICM, you can skip to the next message.	
	9 STOP Playing	Stop Playing the ICM.	
93	Erase all ICM (MFC-665CW and MFC-845CW only)	If you hear one long beep, the erase is accepted. If you hear three short beeps, you cannot erase because all voice messages have not been played, or there are no voice message to erase. *This code erases all recorded messages, not one at a time.	
94	Play and Record OGM in Memory (MFC-665CW and MFC-845CW only)		
	1 Play	1 Msg Ctr OGM	The machine plays the selected OGM. You can stop playing OGMs by pressing 9 .
		2 F/T OGM	
	2 Record	1 Msg Ctr OGM	After one long beep, you can record the selected OGM. You will hear the message played once. You can stop recording the message by pressing 9 .
2 F/T OGM			
95	Change the Fax Forwarding, Paging or Fax Storage settings		
	1 OFF	You can choose <i>Off</i> after you have retrieved or erased all your messages.	
	2 Fax Forwarding	One long beep means the change is accepted. If you hear three short beeps, you cannot change because something has not been set up (for example, a Fax Forwarding or Paging number has not been registered). You can register your Fax Forwarding number by entering 4. (See <i>Changing your Fax Forwarding number</i> on page 86.) Once you have registered the number, Fax Forwarding will work.	
	3 Paging		
	4 Fax Forwarding number		
	6 Fax Storage		
96	Retrieve a fax		
	2 Retrieve all faxes	Enter the number of a remote fax machine to receive stored fax messages. (See <i>Retrieving fax messages</i> on page 86.)	
	3 Erase faxes from the memory	If you hear one long beep, fax messages have been erased from the memory.	
97	Check the receiving status (MFC-440CN only)		
	1 Fax	You can check whether your machine has received any faxes. If yes, you will hear one long beep. If no, you will hear three short beeps.	

Remote commands		Operation details
97	Check the receiving status (MFC-665CW and MFC-845CW only)	
	1 Fax 2 Voice	You can check whether your machine has received any faxes or voice messages. If yes, you will hear one long beep. If no, you will hear three short beeps.
98	Change the Receive Mode (MFC-440CN only)	
	1 External TAD	If you hear one long beep, your change has been accepted.
	2 Fax/Tel	
3 Fax Only		
98	Change the Receive Mode (MFC-665CW and MFC-845CW only)	
	1 Msg Ctr	If you hear one long beep, your change has been accepted.
	2 Fax/Tel	
3 Fax Only		
90	Exit	Pressing 9 0 allows you to exit remote retrieval. Wait for the long beep, then replace the handset.

Retrieving fax messages

You can call your machine from any touch tone phone and have your fax messages sent to a machine.

- 1 Dial your fax number.
- 2 When your machine answers, enter your remote access code (3 digits followed by ✕) at once. If you hear one long beep, you have messages.
- 3 When you hear two short beeps, press **9 6 2**.
- 4 Wait for the long beep, enter the number (up to 20 digits) of the remote fax machine you want your fax messages sent to using the dial pad, then enter **# #**.



Note

You cannot use ✕ and # as dial numbers. However, press # if you want to create a pause.

- 5 Press **9 0** to reset the machine when you've finished.
- 6 Hang up after you hear your machine beep. Your machine will call the other fax machine, which will then print your fax messages.

Changing your Fax Forwarding number

You can change the default setting of your fax forwarding number from another touch tone telephone or fax machine.

- 1 Dial your fax number.
- 2 When your machine answers, enter your remote access code (3 digits followed by ✕) at once. If you hear one long beep, you have messages.
- 3 When you hear two short beeps, press **9 5 4**.
- 4 Wait for the long beep, enter the new number (up to 20 digits) of the remote fax machine you want your fax messages forwarded to using the dial pad, then enter **# #**.



Note

You cannot use ✕ and # as dial numbers. However, press # if you want to create a pause.

- 5 Press **9 0** to reset the machine when you have finished.
- 6 Hang up after you hear your machine beep.

Fax reports

You need to set up the Transmission Verification Report and Journal Period using the **Menu** keys.

Transmission Verification Report

You can use the Transmission Verification Report as proof that you sent a fax. This report lists the time and date of transmission and whether the transmission was successful (OK). If you choose **On** or **On+Image**, the report will print for every fax you send.

If you send a lot of faxes to the same place, you may need more than the job numbers to know which faxes you must send again. Choosing **On+Image** or **Off+Image** will print a section of the fax's first page on the report to help you remember.

When the Transmission Verification Report is turned **Off** or **Off+Image**, the Report will only print if there is a transmission error, with NG in the RESULT column.

- 1 Press **Menu**.
- 2 Press **▲** or **▼** to choose **Fax**. Press **OK**.
- 3 Press **▲** or **▼** to choose **Report Setting**. Press **OK**.
- 4 Press **▲** or **▼** to choose **Transmission**. Press **OK**.
- 5 Press **▲** or **▼** to choose **On**, **On+Image**, **Off** or **Off+Image**. Press **OK**.
- 6 Press **Stop/Exit**.

Fax Journal (activity report)

You can set the machine to print a journal at specific intervals (every 50 faxes, 6, 12 or 24 hours, 2 or 7 days). If you set the interval to **Off**, you can still print the report by following the steps on *How to print a report* on page 88. The factory setting is **Every 50 Faxes**.

- 1 Press **Menu**.
- 2 Press **▲** or **▼** to choose **Fax**. Press **OK**.
- 3 Press **▲** or **▼** to choose **Report Setting**. Press **OK**.
- 4 Press **▲** or **▼** to choose **Journal Period**. Press **OK**.
- 5 Press **▲** or **▼** to choose an interval. Press **OK**.
(If you choose 7 days, the LCD will ask you to choose the first day for the 7-day countdown.)
 - 6, 12, 24 hours, 2 or 7 days
The machine will print the report at the chosen time and then erase all jobs from its memory. If the machine's memory becomes full with 200 jobs before the time you chose has passed, the machine will print the Journal early and then erase all jobs from the memory. If you want an extra report before it is due to print, you can print it without erasing the jobs from the memory.
 - Every 50 Faxes
The machine will print the Journal when the machine has stored 50 jobs.

- 6 Enter the time to start printing in 24-hour format.
Press **OK**.
(For example: enter 19:45 for 7:45 PM.)
- 7 Press **Stop/Exit**.

Reports

The following reports are available:

- **Transmission**
Prints a Transmission Verification Report for your last transmission.
- **Help List**
A help list about how to quickly program your machine.
- **Quick-Dial**
Lists names and numbers stored in the Speed-Dial memory, in alphabetical or numerical order.
- **Fax Journal**
Lists information about the last incoming and outgoing faxes. (TX: Transmit.) (RX: Receive.)
- **User Settings**
Lists your settings.
- **Network Config**
Lists your Network settings.

How to print a report

- 1 Press **Menu**.
- 2 Press **▲** or **▼** to choose **Print Reports**.
Press **OK**.
- 3 Press **▲** or **▼** to choose the report you want.
Press **OK**.
- 4 Press **Black Start**.

12 Polling

Polling overview

Polling lets you set up your machine so other people can receive faxes from you, but they pay for the call. It also lets you call somebody else's fax machine and receive a fax from it, so you pay for the call. The polling feature needs to be set up on both machines for this to work. Not all fax machines support polling.

Polling receive

Polling receive lets you call another fax machine to receive a fax.

Setup to receive polling

- 1 Press  (Fax).
- 2 Press ▲ or ▼ to choose `Polling RX`. Press **OK**.
- 3 Press ▲ or ▼ to choose `On (or Off)`. Press **OK**.
- 4 Enter the fax number you are polling.
- 5 Press **Black Start** or **Color Start**.
The LCD shows `Dialing`.

Sequential polling (Black & White only)

Sequential polling lets you request documents from several fax machines in one operation. Afterwards, a Sequential Polling Report will be printed.

- 1 Press  (Fax).
- 2 Press ▲ or ▼ to choose `Polling RX`. Press **OK**.
- 3 Press ▲ or ▼ to choose `On (or Off)`. Press **OK**.
- 4 Press ▲ or ▼ to choose `Broadcasting`. Press **OK**.
- 5 Press ▲ or ▼ to choose `Add Number`. Press **OK**.
- 6 Enter a number using Speed-Dial, a Group, or the dial pad. Press **OK**.
- 7 Repeat steps 5 and 6 for all the fax numbers you want to poll, and then press ▲ or ▼ to choose `Complete`. Press **OK**.
- 8 Press **Black Start**.
The machine polls each number or Group number in turn for a document.

Press **Stop/Exit** while the machine is dialing to cancel the polling process.

To cancel all sequential polling receive jobs, see *Checking and canceling waiting jobs* on page 43.

Polled transmit (Black & White only)

Polled transmit lets you set up your machine to wait with a document so another fax machine can call and retrieve it.

The document will be stored and can be retrieved by any other fax machine until you delete it from the memory. (See *Checking and canceling waiting jobs* on page 43.)

Set up for polled transmit

- 1 Press  (Fax).
- 2 Load your document.
- 3 Press ▲ or ▼ to choose Polled TX.
Press **OK**.
- 4 Press ▲ or ▼ to choose On (or Off).
Press **OK**.
- 5 Press ▲ or ▼ to choose any settings you want to change.
Press **OK**.
After each setting is accepted, you can continue to change more settings.
- 6 Press **Black Start**.



Copy

Making copies

92

13

Making copies

How to copy

Entering Copy mode

When you want to make a copy, press

 (**Copy**) to illuminate it in green.

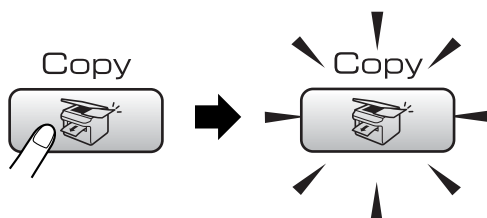

The LCD shows:

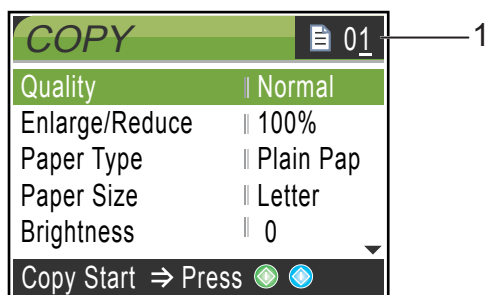

1 No of Copies

You can enter the number of copies you want by using the dial pad.

Press ▲ or ▼ to scroll through the **Copy** key options.

- Quality (See page 93.)
- Enlarge/Reduce (See page 94.)
- Paper Type (See page 97.)
- Paper Size (See page 97.)
- Brightness (See page 96.)
- Contrast (See page 96.)
- Color Adjust (See page 96.)
- Stack/Sort (See page 95.)
- Page Layout (See page 94.)
- Set New Default (See page 97.)
- Factory Reset (See page 97.)

When the option you want is highlighted, press **OK**.

Note

The default setting is Fax mode. You can change the amount of time that the machine stays in Copy mode after the last copy operation. (See *Mode Timer* on page 26.)

Making a single copy

- 1 Press  (**Copy**).
- 2 Load your document.
(See *Loading documents* on page 11.)
- 3 Press **Black Start** or **Color Start**.

Making multiple copies

You can make up to 99 copies.

- 1 Press  (**Copy**).
- 2 Load your document.
- 3 Enter the number of copies you want.
- 4 Press **Black Start** or **Color Start**.



Note

To sort the copies, press ▲ or ▼ to choose *Stack/Sort*. (See *Sorting copies using the ADF* on page 95.)

Stop copying

To stop copying, press **Stop/Exit**.

Copy settings

You can change the copy settings temporarily for the next copy.

These settings are temporary, and the machine returns to its default settings 60 seconds after copying, unless you have set the Mode Timer to 30 seconds or less. (See *Mode Timer* on page 26.)

If you have finished choosing settings, press **Black Start** or **Color Start**.

If you want to choose more settings, press ▲ or ▼.



Note

You can save some of the settings that you use most often by setting them as default. These settings will stay until you change them again. (See *Setting your changes as new default* on page 97.)

Changing copy quality

You can choose from a range of quality. The factory setting is *Normal*.

■ Fast

Fast copy speed and lowest amount of ink used. Use to save time printing documents to be proof-read, large documents or many copies.

■ Normal

Normal is the recommended mode for ordinary printouts. This produces good copy quality with good copy speed.

■ Best

Use best mode to copy precise images such as photographs. This provides the highest resolution and slowest speed.

- 1 Press  (**Copy**).
- 2 Load your document.
- 3 Enter the number of copies you want.
- 4 Press ▲ or ▼ to choose *Quality*. Press **OK**.
- 5 Press ▲ or ▼ to choose *Fast*, *Normal* or *Best*. Press **OK**.
- 6 If you do not want to change additional settings, press **Black Start** or **Color Start**.

Enlarging or reducing the image copied

You can choose an enlargement or reduction ratio.

- 1 Press  (**Copy**).
- 2 Load your document.
- 3 Enter the number of copies you want.
- 4 Press **▲** or **▼** to choose *Enlarge/Reduce*. Press **OK**.
- 5 Do one of the following:
 - Press **▲** or **▼** to choose the enlargement or reduction ratio you want. Press **OK**.
 - Press **▲** or **▼** to choose *Custom(25-400%)* and then enter an enlargement or reduction ratio from 25% to 400%. Press **OK**. (For example, press **5 3** to enter 53%.)

50%
69% A4→A5
78% LGL→LTR
83% LGL→A4
93% A4→LTR
97% LTR→A4
100%*
104% EXE→LTR
142% A5→A4
186% 4"×6"→LTR
198% 4"×6"→A4
200%
Custom(25-400%)

- 6 If you do not want to change additional settings, press **Black Start** or **Color Start**.



Note

Page Layout Options are not available with *Enlarge/Reduce*.

Making N in 1 copies or a poster (page layout)

The N in 1 copy feature can help you save paper by letting you copy two or four pages onto one printed page.

You can also produce a poster. When you use the poster feature your machine divides your document into sections, then enlarges the sections so you can assemble them into a poster. If you want to print a poster, use the scanner glass.

Important

- Please make sure paper size is set to *Letter* or *A4*.
- You can not use the *Enlarge/Reduce* setting with the N in 1 and Poster features.
- If you are producing multiple color copies, N in 1 copy is not available.
- (P) means Portrait and (L) means Landscape.
- You can only make one poster copy at a time.

- 1 Press  (**Copy**).
- 2 Load your document.
- 3 Enter the number of copies you want.
- 4 Press **▲** or **▼** to choose *Page Layout*. Press **OK**.
- 5 Press **▲** or **▼** to choose *Off (1 in 1), 2 in 1 (P), 2 in 1 (L), 4 in 1 (P), 4 in 1 (L) or Poster(3 × 3)*. Press **OK**.

- 6 If you do not want to change additional settings, press **Black Start** or **Color Start** to scan the page.
If you are making a poster or placed the document in the ADF, the machine scans the pages and starts printing.
If you are using the scanner glass, go to step 7.
- 7 After the machine scans the page, press **1** to scan the next page.
- 8 Place the next page on the scanner glass.
Press **OK**.
Repeat steps 7 and 8 for each page of the layout.
- 9 After all the pages have been scanned, press **2** to finish.



Note

If photo paper has been chosen in the Paper Type setting for N in 1 copies, the machine will print the images as if Plain paper had been chosen.

Place your document face down in the direction shown below.

■ **2 in 1 (P)**



■ **2 in 1 (L)**

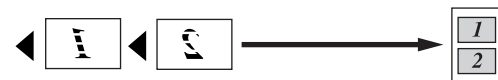

■ **4 in 1 (P)**



■ **4 in 1 (L)**



■ **Poster (3 x 3)**

You can make a poster size copy of a photograph.

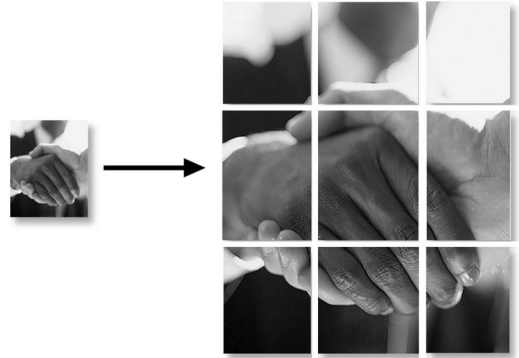

Sorting copies using the ADF

You can sort multiple copies. Pages will be stacked in the order 123, 123, 123, and so on.

- 1 Press  (**Copy**).
- 2 Load your document.
- 3 Enter the number of copies you want.
- 4 Press **▲** or **▼** to choose *Stack/Sort*. Press **OK**.
- 5 Press **▲** or **▼** to choose *Sort*. Press **OK**.
- 6 If you do not want to change additional settings, press **Black Start** or **Color Start**.

Adjusting Brightness, Contrast and Color

Brightness

You can adjust the copy brightness to make copies darker or lighter.

- 1 Press  (**Copy**).
- 2 Load your document.
- 3 Enter the number of copies you want.
- 4 Press ▲ or ▼ to choose *Brightness*. Press **OK**.
- 5 Press ◀ to make a darker copy or press ▶ to make a lighter copy. Press **OK**.
- 6 If you do not want to change additional settings, press **Black Start** or **Color Start**.

Contrast

You can adjust the copy contrast to help an image look sharper and more vivid.

- 1 Press  (**Copy**).
- 2 Load your document.
- 3 Enter the number of copies you want.
- 4 Press ▲ or ▼ to choose *Contrast*. Press **OK**.
- 5 Press ▶ to increase the contrast or press ◀ to decrease the contrast. Press **OK**.
- 6 If you do not want to change additional settings, press **Black Start** or **Color Start**.

Color Saturation

- 1 Press  (**Copy**).
- 2 Load your document.
- 3 Enter the number of copies you want.
- 4 Press ▲ or ▼ to choose *Color Adjust*. Press **OK**.
- 5 Press ▲ or ▼ to choose *Red, Green or Blue*. Press **OK**.
- 6 Press ▶ to increase the color saturation, or press ◀ to decrease the color saturation. Press **OK**.
- 7 Do one of the following:
 - If you want to change another color saturation, go to step 5.
 - If you want to change additional settings, press ▲ or ▼ to choose *Exit*. Press **OK**.
 - If you do not want to change additional settings, press **Black Start** or **Color Start**.

Paper Options

Paper Type

If you are copying on special paper, set the machine for the type of paper you are using to get the best print quality.

- 1 Press  (**Copy**).
- 2 Load your document.
- 3 Enter the number of copies you want.
- 4 Press ▲ or ▼ to choose `Paper Type`. Press **OK**.
- 5 Press ▲ or ▼ to choose `Plain Paper`, `Inkjet Paper`, `Brother Photo`, `Other Photo` or `Transparency`. Press **OK**.
- 6 If you do not want to change additional settings, press **Black Start** or **Color Start**.

Paper Size

If copying on paper other than Letter size, you will need to change the paper size setting. You can copy only on Letter, Legal, A4, A5 or Photo [4 in. (W) × 6 in. (H) or 10 cm (W) × 15 cm (H)] paper.

- 1 Press  (**Copy**).
- 2 Load your document.
- 3 Enter the number of copies you want.
- 4 Press ▲ or ▼ to choose `Paper Size`. Press **OK**.
- 5 Press ▲ or ▼ to choose `Letter`, `Legal`, `A4`, `A5` or `4" x 6"`. Press **OK**.
- 6 If you do not want to change additional settings, press **Black Start** or **Color Start**.

Setting your changes as new default

You can save the copy settings for `Quality`, `Paper Type`, `Brightness`, `Contrast` and `Color Adjust` that you use most often by setting them the default settings. These settings will stay until you change them again.

- 1 Press  (**Copy**).
- 2 Press ▲ or ▼ to choose your new setting. Press **OK**. Repeat this step for each setting you want to change.
- 3 After changing the last setting, press ▲ or ▼ to choose `Set New Default`. Press **OK**.
- 4 Press **1** to choose `Yes`.
- 5 Press **Stop/Exit**.

Restoring all the settings to factory settings

You can restore all the settings you have changed to the factory settings. These settings will stay until you change them again.

- 1 Press  (**Copy**).
- 2 Press ▲ or ▼ to choose `Factory Reset`. Press **OK**.
- 3 Press **1** to choose `Yes`.
- 4 Press **Stop/Exit**.

'Out of Memory' message

If the `Out of Memory` message appears while scanning documents, press **Stop/Exit** to cancel or **Black Start** or **Color Start** to copy the scanned pages.

You will need to clear some jobs from the memory before you can continue.

To free up extra memory, do the following:

- Turn off Advanced Fax Operation. (See *Turning off Advanced Fax Operations* on page 81.)
- Print the faxes that are in the memory. (See *Printing a fax from the memory* on page 51.)

When you get an `Out of Memory` message, you may be able to make copies if you first print incoming faxes in the memory to restore the memory to 100%.



Walk-up Photo Printing

PhotoCapture Center[®]	100
PictBridge	111

PhotoCapture Center[®] Operations

Printing from a media card without a PC

Even if your machine is not connected to your computer, you can print photos directly from digital camera media. (See *Print Images* on page 102.)

Scanning to a media card without a PC

You can scan documents and save them directly to a media card. (See *Scan to Card* on page 109.)

Using PhotoCapture Center[®] from your computer

You can access the media card that is in the media drive (slot) of the machine from your PC.

(See *PhotoCapture Center[®] for Windows[®]* or *Remote Setup & PhotoCapture Center[®] for Macintosh[®]* in the Software User's Guide on the CD-ROM.)

Using media cards

Your Brother machine includes media drives (slots) for use with popular digital camera media: CompactFlash[®], Memory Stick[®], Memory Stick Pro[™], SecureDigital[™], MultiMediaCard[™] and xD-Picture Card[™].



CompactFlash[®]



Memory Stick[®]

Memory Stick Pro[™]



SecureDigital[™]

MultiMediaCard[™]



xD-Picture Card[™]

- miniSD[™] can be used with a miniSD[™] adapter.
- Memory Stick Duo[™] can be used with a Memory Stick Duo[™] adapter.
- Memory Stick Pro Duo[™] can be used with a Memory Stick Pro Duo[™] adapter.
- Adapters are not included with the machine. Contact a third party supplier for adapters.

The PhotoCapture Center[®] feature lets you print digital photos from your digital camera at high resolution to get photo quality printing.

Media card folder structure

To avoid errors, remember the following points:

- The DPOF file on the media card must be in a valid format. (See *DPOF printing* on page 104.)

- The image file extension must be .JPG (Other image file extensions like .JPEG, .TIF, .GIF and so on will not be recognized).
- Walk-up PhotoCapture Center® printing must be performed separately from PhotoCapture Center® operations using the PC. (Simultaneous operation is not available.)
- IBM Microdrive™ is not compatible with the machine.
- The machine can read up to 999 files (including the folder inside memory) on a media card.
- CompactFlash® Type II is not supported.
- This product supports xD-Picture Card™ Type M / Type H (Large Capacity).

Please be aware of the following:

- When printing the INDEX or IMAGE, the PhotoCapture Center® will print all the valid images, even if one or more images have been corrupted. A portion of the corrupted image may be printed.
- Your machine is designed to read media cards that have been formatted by a digital camera.

When a digital camera formats a media card it creates a special folder into which it copies image data. If you need to modify the image data stored on a media card with your PC, we recommend that you do not modify the folder structure created by the digital camera. When saving new or modified image files to the media card we also recommend you use the same folder your digital camera uses. If the data is not saved to the same folder, the machine may not be able to read the file or print the image.

Getting started

Firmly put the card into the proper slot.

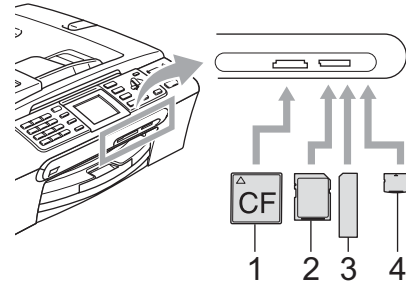

- 1 CompactFlash®
- 2 SecureDigital™, MultiMediaCard™
- 3 Memory Stick®, Memory Stick Pro™
- 4 xD-Picture Card™

PhotoCapture key lights:

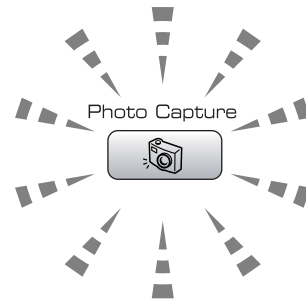

- **PhotoCapture** light is on, the media card is properly inserted.
- **PhotoCapture** light is off, the media card is not properly inserted.
- **PhotoCapture** light is blinking, the media card is being read or written to.

! CAUTION

DO NOT unplug the power cord or remove the media card from the media drive (slot) while the machine is reading or writing to the card (the **PhotoCapture** key is blinking). **You will lose your data or damage the card.**

The machine can only read one media card at a time so do not put more than one card in a slot.

Entering PhotoCapture mode

After you insert the media card, press the  (**PhotoCapture**) key to illuminate it in green and display the PhotoCapture options on the LCD.

The LCD shows:



Press **▲** or **▼** to scroll through the PhotoCapture key options.

- **View Photo(s)** (See page 102.)
- **Print Index** (See page 103.)
- **Print All Photos** (See page 103.)
- **Print Photos** (See page 104.)

Note

If your digital camera supports DPOF printing, see *DPOF printing* on page 104.

When the option you want is highlighted, press **OK**.

Print Images

View Photo(s)

You can preview your photos on the LCD before you print them. If your photos are large files there may be a delay before each photo is displayed on the LCD.

- 1 Make sure you have put the media card in the proper slot.
Press  (**PhotoCapture**).
- 2 Press **▲** or **▼** to choose **View Photo(s)**.
Press **OK**.

- 3 Press **◀** or **▶** to choose your photo.

**Note**

Instead of scrolling through your photos, you can use the dial pad to enter the 3-digit number of the image from the index page. (See *Print Index (Thumbnails)* on page 103.)

- 4 Press **▲** to **▼** to increase or decrease the number of copies.
- 5 Repeat step 3 and step 4 until you have chosen all the photos.

**Note**

Press **Clear/Back** to go back to the previous level.

- 6 After you have chosen all the photos, do one of the following:
 - Press **OK** and change the print setting. (See page 105.)
 - If you do not want to change any settings, press **Color Start** to print.

Print Index (Thumbnails)

The PhotoCapture Center® assigns numbers for images (such as No.1, No.2, No.3, and so on).



→ No. 1
DEI.JPG 01.01.2003
100KB

The PhotoCapture Center® does not recognize any other numbers or file names that your digital camera or PC has used to identify the pictures. You can print a thumbnail page (Index page with 6 or 5 images per line). This will show all the pictures on the media card.

- 1 Make sure you have put the media card in the proper slot.
Press  (**PhotoCapture**).
- 2 Press ▲ or ▼ to choose `Print Index`.
Press **OK**.
- 3 Press ▲ or ▼ to choose
`6 Images/Line Fast` or
`5 Images/Line Photo`.
Press **OK**.



5 Images/Line
Photo

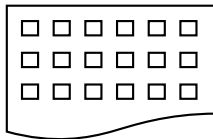

6 Images/Line
Fast

Print time for 5 Images/Line will be slower than 6 Images/Line, but the quality is better.

- 4 Press **Color Start** to print.

Print All Photos

You can print all the photos on your media card.

- 1 Make sure you have put the media card in the proper slot.
Press  (**PhotoCapture**).
- 2 Press ▲ or ▼ to choose `Print All Photos`.
Press **OK**.
- 3 Enter the number of copies you want using the dial pad.
- 4 Do one of the following:
 - Change the print setting. (See page 105.)
 - If you do not want to change any settings, press **Color Start** to print.

Print Photos

Before you can print an individual image, you have to know the image number.

- 1 Make sure you have put the media card in the proper slot.
Press  (**PhotoCapture**).
- 2 Print the Index. (See *Print Index (Thumbnails)* on page 103.)
- 3 Press **▲** or **▼** to choose *Print Photos*.
Press **OK**.
- 4 Enter the image number that you want to print from the Index page (Thumbnails).
Press **OK**.
- 5 Repeat step 4 until you have entered all the image numbers that you want to print.



Note

You can enter all the numbers at one time by using the **✕** key for a comma or the **#** key for a hyphen. For example, Enter **1, ✕, 3, ✕, 6** to print images No.1, No.3 and No.6. Enter **1, #, 5** to print images No.1 to No.5.

- 6 After you have chosen all the image numbers, press **OK** again.
- 7 Enter the number of copies you want using the dial pad.
- 8 Do one of the following:
 - Change the print setting. (See page 105.)
 - If you do not want to change any settings, press **Color Start** to print.

DPOF printing

DPOF stands for Digital Print Order Format.

Major digital camera manufacturers (Canon Inc., Eastman Kodak Company, Fuji Photo Film Co. Ltd., Matsushita Electric Industrial Co. Ltd. and Sony Corporation) created this standard to make it easier to print images from a digital camera.

If your digital camera supports DPOF printing, you will be able to choose on the digital camera display the images and number of copies you want to print.

When the memory card (CompactFlash[®], Memory Stick[®], Memory Stick Pro[™], SecureDigital[™] MultiMediaCard[™] or xD-Picture Card[™]) with DPOF information is put into your machine, you can print the chosen image easily.

- 1 Make sure you have put the media card into the proper slot.
Press  (**PhotoCapture**). The machine will ask you if you want to use DPOF setting.
- 2 Press **1** to choose *Yes*.
- 3 Do one of the following:
 - Change the print settings. (See page 105.)
 - If you do not want to change any settings, press **Color Start** to print.

PhotoCapture Center® print settings

You can change the print settings temporarily for the next printing.

These settings are temporary, and the machine returns to its default settings 180 seconds after printing, unless you have set the Mode Timer to 2 minutes or less. (See *Mode Timer* on page 26.)



Note

You can save the print settings you use most often by setting them as default. (See *Setting your changes as new default* on page 108.)

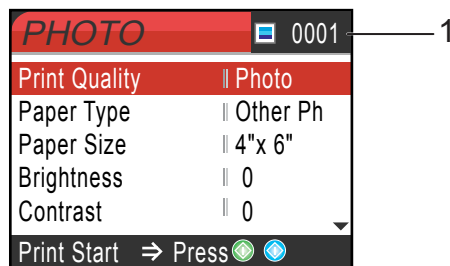

1 No of prints

(For View Photo(s))

You can see the total number of photos that will be printed.

(For Print All Photos, Print Photos)

You can see the number of copies of each photo that will be printed.

Menu Selections	Option1	Option2	Page
Print Quality	Normal/Photo	—	106
Paper Type	Plain Paper/Inkjet Paper/ Brother Photo/Other Photo	—	106
Paper Size	Letter/A4/4"x 6"/5"x 7"	(When A4 or Letter is chosen) 4"x 3"/5"x 3.5"/6"x 4"/ 7"x 5"/8"x 6"/Max. Size	106
Brightness	0 ← → 100 Dark Light	—	106
Contrast	← → - +	—	106
True2Life	On/Off White Balance ← → / Sharpness ← → / Color Density ← → Exit	—	107
Cropping	On/Off	—	108
Borderless	On/Off	—	108
Set New Default	Yes/No	—	108
Factory Reset	Yes/No	—	108

Print Quality

- 1 Press ▲ or ▼ to choose **Print Quality**. Press **OK**.
- 2 Press ▲ or ▼ to choose **Normal** or **Photo**. Press **OK**.
- 3 If you do not want to change additional settings, press **Color Start** to print.

Paper options



Paper Type

- 1 Press ▲ or ▼ to choose **Paper Type**. Press **OK**.
- 2 Press ▲ or ▼ to choose the type of paper you are using, **Plain Paper**, **Inkjet Paper**, **Brother Photo** or **Other Photo**. Press **OK**.
- 3 If you do not want to change additional settings, press **Color Start** to print.

Paper and print size

- 1 Press ▲ or ▼ to choose **Paper Size**. Press **OK**.
- 2 Press ▲ or ▼ to choose the type of paper you are using, **Letter**, **4"× 6"**, **5"× 7"** or **A4**. Press **OK**.
- 3 If you chose **Letter** or **A4**, press ▲ or ▼ to choose the print size. Press **OK**.

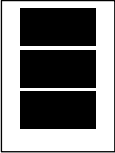
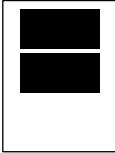
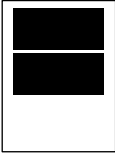
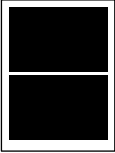
Example: Printed Position for Letter paper

1 4"× 3"	2 5"× 3.5"	3 6"× 4"
		
4 7"× 5"	5 8"× 6"	6 Max. Size
		

- 4 If you do not want to change additional settings, press **Color Start** to print.

Adjusting Brightness, Contrast and Color

Brightness

- 1 Press ▲ or ▼ to choose **Brightness**. Press **OK**.
- 2 Press ◀ to make a darker copy or press ▶ to make a lighter copy. Press **OK**.
- 3 If you do not want to change additional settings, press **Color Start** to print.

Contrast

You can choose the contrast setting. More contrast will make an image look sharper and more vivid.

- 1 Press ▲ or ▼ to choose **Contrast**. Press **OK**.
- 2 Press ▶ to increase the contrast or press ◀ to decrease the contrast. Press **OK**.

- 3 If you do not want to change additional settings, press **Color Start** to print.

Color Enhancement (True2Life®)

The color enhancement (True2Life®) feature will produce more vivid images. Your photographs will take slightly longer to print.

- 1 Press ▲ or ▼ to choose `True2Life`. Press **OK**.
- 2 Do one of the following:
 - If you want to customize the `White Balance`, `Sharpness` or `Color Density`, press ◀ or ▶ to choose `On` and then go to step 3.
 - If you do not want to customize, press ◀ or ▶ to choose `Off`. Press **OK** and then go to step 6.
- 3 Press ▲ or ▼ to choose `White Balance`, `Sharpness` or `Color Density`. Press **OK**.
- 4 Press ◀ or ▶ to adjust the degree of the setting. Press **OK**.
- 5 Do one of the following:
 - If you want to customize other color enhancement, press ▲ or ▼ to choose other option.
 - If you want to change other settings, press ▲ or ▼ to choose `Exit`, and then press **OK**.
- 6 If you do not want to change additional settings, press **Color Start** to print.



Note

• White Balance

This setting adjusts the hue of the white areas of an image. Lighting, camera settings and other factors will effect the appearance of white. By using this adjustment, you can correct this effect and bring the white areas back to pure white.

• Sharpness

This setting enhances the detail of an image. It is similar to adjusting the fine focus on a camera. If the image is not in focus and you cannot see the fine details of the picture, then adjust the sharpness.

• Color Density

This setting adjusts the total amount of color in the image. You can increase or decrease the amount of color in an image to improve a washed out picture.

Cropping

If your photo is too long or wide to fit the available space on your chosen layout, part of the image will automatically be cropped.

The factory setting is *On*. If you want to print the whole image, turn this setting to *Off*.

- 1 Press ▲ or ▼ to choose *Cropping*. Press **OK**.
- 2 Press ▲ or ▼ to choose *Off* (or *On*). Press **OK**.
- 3 If you do not want to change additional settings, press **Color Start** to print.

Cropping: On

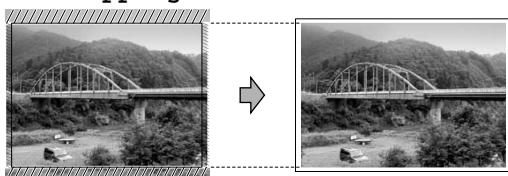

Cropping: Off

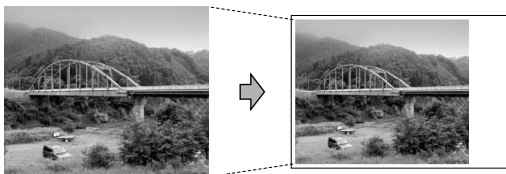

Borderless printing

This feature expands the printable area to the edges of the paper. Printing time will be slightly slower.

- 1 Press ▲ or ▼ to choose *Borderless*. Press **OK**.
- 2 Press ▲ or ▼ to choose *Off* (or *On*). Press **OK**.
- 3 If you do not want to change additional settings, press **Color Start** to print.

Setting your changes as new default

You can save the print settings you use most often by setting them the default settings. These settings will stay until you change them again.

- 1 Press ▲ or ▼ to choose your new setting. Press **OK**. Repeat this step for each setting you want to change.
- 2 After changing the last setting, press ▲ or ▼ to choose *Set New Default*. Press **OK**.
- 3 Press **1** to choose *Yes*.
- 4 Press **Stop/Exit**.

Restoring all the settings to factory settings

You can restore all the settings you have changed to the factory settings. These settings will stay until you change them again.

- 1 Press ▲ or ▼ to choose *Factory Reset*. Press **OK**.
- 2 Press **1** to choose *Yes*.
- 3 Press **Stop/Exit**.

Scan to Card

Entering Scan mode

When you want to scan to card, press

 (**Scan**) to illuminate it in green.

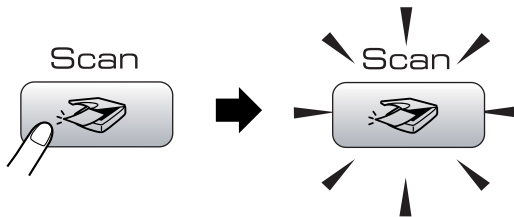

The LCD shows:

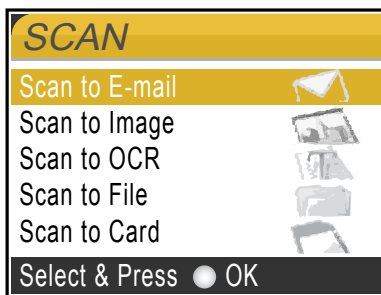

Press ▲ or ▼ to choose Scan to Card.

Press **OK**.

If you are not connected to your computer only the Scan to Card selection will appear on the LCD.

(See *Scanning* for Windows® or Macintosh® in the Software User's Guide on the CD-ROM for details about the other menu options.)

How to scan to card

You can scan black & white and color documents into a media card. Black & white documents will be stored in PDF (*.PDF) or TIFF file formats (*.TIF). Color documents may be stored in PDF (*.PDF) or JPEG (*.JPG) file formats. For color documents the factory setting is 150 dpi Color and the default file format is PDF. File names default to the current date that you set using the control panel keys. (For details, see Quick Setup Guide.) For example, the fifth image scanned on July 1, 2006 would be named 07010605.PDF. You can change the color, quality and file name.

Quality	Selectable File Format
150 dpi Color	JPEG / PDF
300 dpi Color	JPEG / PDF
600 dpi Color	JPEG / PDF
200x100 dpi B/W	TIFF / PDF
200 dpi B/W	TIFF / PDF

- 1 Insert a CompactFlash®, Memory Stick®, Memory Stick Pro™, SecureDigital™, MultiMediaCard™ or xD-Picture Card™ into your machine.

WARNING

Do not take out the media card while **PhotoCapture** is blinking to avoid damaging the card or data stored on the card.

- 2 Load your document.
- 3 Press  (**Scan**).
- 4 Press ▲ or ▼ to choose Scan to Card.
Press **OK**.

- 5 Do one of the following.
- To change the quality, go to step 6.
 - Press **Black Start** or **Color Start** to start scanning without changing additional settings.
- 6 Press ▲ or ▼ to choose 150 dpi Color, 300 dpi Color, 600 dpi Color, 200x100 dpi B/W or 200 dpi B/W. Press **OK**.
- 7 Do one of the following.
- To change the file type, go to step 8.
 - Press **Black Start** or **Color Start** to start scanning without changing additional settings.
- 8 Press ▲ or ▼ to choose JPEG, PDF or TIFF. Press **OK**.



Note

- If you chose color in the resolution setting, you cannot choose TIFF.
- If you chose black & white in the resolution setting, you cannot choose JPEG.

- 9 Do one of the following.
- To change the file name, go to step 10.
 - Press **Black Start** or **Color Start** to start scanning without changing additional settings.
- 10 The file name is set automatically however, you can set a name of your choice using the dial pad. You can only change the first 6 digits. Press **OK**.



Note

Press **Clear/Back** to delete the current name.

- 11 Press **Black Start** or **Color Start**.

Understanding the Error Messages

Once you are familiar with the types of errors that can occur while you are using the PhotoCapture Center®, you can easily identify and troubleshoot any problems.

When an error message is displayed on the LCD and you press a key, the machine will beep to get your attention.

Media Error

This message will appear if you put in a media card that is either bad or not formatted, or when there is a problem with the media drive. To clear this error, take out the media card.

No File

This message will appear if you try to access a media card in the drive (slot) that does not contain a .JPG file.

Out of Memory

This message will appear if you are working with images that are too large for the machine's memory.

15 PictBridge



Your Brother machine supports the PictBridge standard, allowing you to connect to and print photos directly from any PictBridge compatible digital camera.

Before Using PictBridge

PictBridge requirements

To avoid errors, remember the following points:

- The machine and the digital camera must be connected using a suitable USB cable.
- The image file extension must be .JPG (Other image file extensions like .JPEG, .TIF, .GIF and so on will not be recognized).
- PhotoCapture Center[®] operations are not available when using the PictBridge feature.

Using PictBridge

Setting your digital camera

Make sure your camera is in PictBridge mode. The following PictBridge settings may be available from the LCD of your PictBridge compatible camera.

Depending on your camera some of these settings may not be available.

Camera Menu Selections	Options
Paper Size	Letter, A4, 4"×6", Printer Settings (Default setting) ²
Paper Type	Plain Paper, Glossy Paper, Inkjet Paper, Printer Settings (Default setting) ²
Layout	Borderless: On, Borderless: Off, Printer Settings (Default setting) ²
DPOF setting ¹	—
Print Quality	Normal, Fine, Printer Settings (Default setting) ²
Color Enhancement	On, Off, Printer Settings (Default setting) ²

¹ See *DPOF printing* on page 112 for more details.

² If your camera is set to use the Printer Settings (Default setting), the machine will print your photo using the settings below.

Settings	Options
Paper Size	4"×6"
Paper Type	Glossy Paper
Layout	Borderless: On
Print Quality	Fine
Color Enhancement	Off

- The names and availability of each setting depend on the specification of your camera.

Please refer to the documentation supplied with your camera for more detailed information on changing PictBridge settings.

Printing Images

- 1 Make sure that your camera is turned off. Connect your camera to the PictBridge port on the machine using the USB cable.

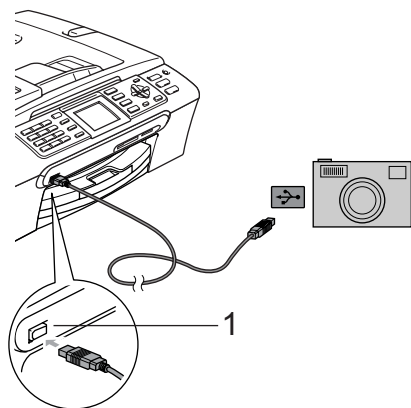

1 PictBridge port



Note

Remove any media cards from the machine before connecting the digital camera.

- 2 Turn on the camera. When the machine has recognized the camera, the LCD shows *Camera Connected*. When the machine starts printing a photo, the LCD will show *Printing*.



WARNING

To prevent damage to your machine, do not connect any device other than a PictBridge compatible camera to the PictBridge port.

DPOF printing

DPOF stands for Digital Print Order Format.

Major digital camera manufacturers (Canon Inc., Eastman Kodak Company, Fuji Photo Film Co. Ltd., Matsushita Electric Industrial Co. Ltd. and Sony Corporation) created this standard to make it easier to print images from a digital camera.

If your digital camera supports DPOF printing, you will be able to choose on the digital camera display the images and number of copies you want to print.

Understanding the Error Messages

Once you are familiar with the types of errors that can occur while you are using the PictBridge, you can easily identify and troubleshoot any problems.

■ Out of Memory

This message will appear if you are working with images that are too large for the machine's memory.

■ Wrong USB device

This message will appear if you connect a non-PictBridge compatible or broken device to the PictBridge port. To clear the error, unplug the device from the PictBridge port, then press **On/Off** to turn the machine off and then on again.

See *Error messages* on page 136 for the detailed solution.



Software

Software and Network features

116

16

Software and Network features

The CD-ROM includes the Software User's Guide and Network User's Guide for features available when connected to a computer (for example, printing and scanning). These guides have easy to use links that, when clicked, will take you directly to a particular section.

You can find information on these features:

- Printing
- Scanning
- ControlCenter3 (for Windows®)
- ControlCenter2 (for Macintosh®)
- Remote Setup
- Faxing from your computer
- PhotoCapture Center®
- Network Printing
- Network Scanning
- Wireless Network Users (MFC-665CW and MFC-845CW only)

How to read HTML User's Guide

This is a quick reference for using the HTML User's Guide.

(For Windows®)



Note

If you have not installed the software, see *Viewing Documentation* on page 2.

- 1 From the **Start** menu, point to **Brother**, **MFC-XXXX** (where XXXX is your model number) from the programs group, then click **User's Guide**.
- 2 Click **SOFTWARE USER'S GUIDE** (or **NETWORK USER'S GUIDE**) from the top menu.

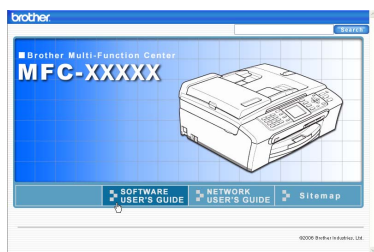

- 3 Click the heading you would like to view from the list at the left of the window.

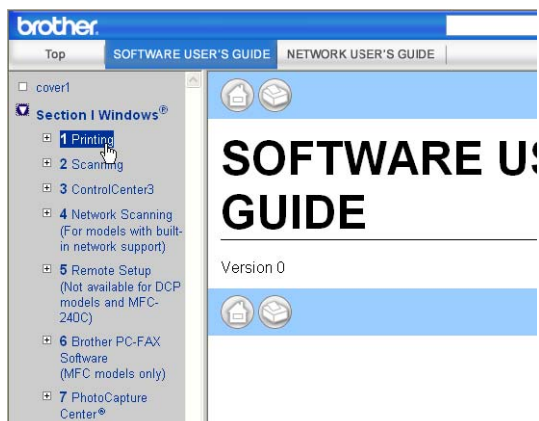

(For Macintosh®)

- 1 Make sure your Macintosh® is turned on. Insert the Brother CD-ROM into your CD-ROM drive.
- 2 Double-click the **Documentation** icon.
- 3 Double-click your language folder, and then double-click the top page file.
- 4 Click **SOFTWARE USER'S GUIDE** (or **NETWORK USER'S GUIDE**) in the top menu, and then click the heading you would like to read from the list at the left of the window.

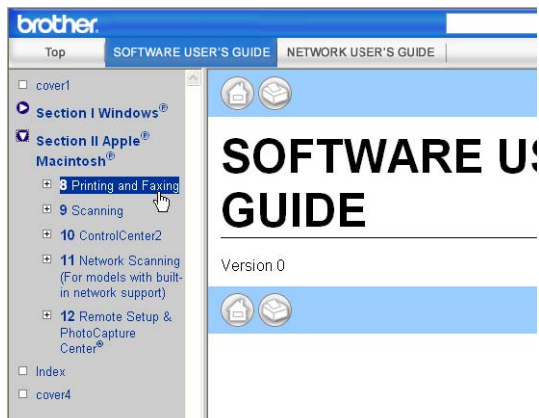



Appendixes

Safety and Legal	118
Troubleshooting and Routine Maintenance	130
Menu and Features	158
Specifications	175
Glossary	191

A

Safety and Legal

Choosing a location

Put your machine on a flat, stable surface that is free of vibration and shocks, such as a desk. Put the machine near a telephone wall jack and a standard AC power outlet. Choose a location where the temperature remains between 50° F and 95° F (10° and 35° C).

! CAUTION

- Avoid placing your machine in a high-traffic area.
- Avoid placing your machine on a carpet.
- DO NOT put the machine near heaters, air conditioners, refrigerators, medical equipment, chemicals or water.
- DO NOT expose the machine to direct sunlight, excessive heat, moisture, or dust.
- DO NOT connect your machine to electrical outlets controlled by wall switches or automatic timers.
- Disruption of power can wipe out information in the machine's memory.
- Do NOT connect your machine to electrical outlets on the same circuit as large appliances or other equipment that might disrupt the power supply.
- Avoid interference sources, such as speakers or the base units of non-Brother cordless phones.
- DO NOT place the MFC-845CW and the cordless handset near electro-medical equipment.

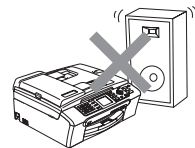
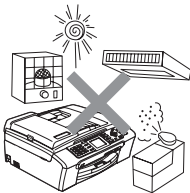

To use the machine safely

Please keep these instructions for later reference and read them before attempting any maintenance.



Note

(MFC-665CW and MFC-845CW only)

If there are faxes in the machine's memory, you need to print them or save them before you unplug the machine from the AC power outlet for more than 24 hours. (To print the faxes in memory, see *Printing a fax from the memory* on page 51. To save the faxes in memory, see *Transferring faxes to another fax machine* on page 139 or *Transferring faxes to your PC* on page 139.)



WARNING



There are high voltage electrodes inside the machine. Before you clean the inside of the machine, make sure you have unplugged the telephone line cord first and then the power cord from the AC power outlet. Doing this will prevent an electrical shock.

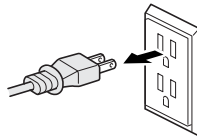

DO NOT handle the plug with wet hands. Doing this might cause an electrical shock.

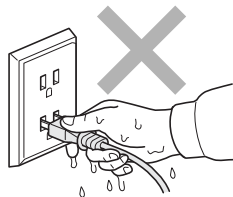

Always make sure the plug is fully inserted.



DO NOT pull on the middle of the AC power cord. Doing this might cause an electrical shock.



DO NOT put your hands on the edge of the machine under the document cover or the scanner cover. Doing this may cause injury.

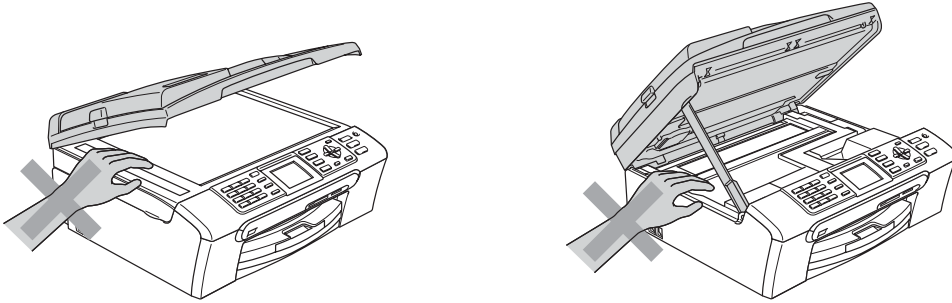

DO NOT put your hands on the edge of the paper tray under the output paper tray cover. Doing this may cause injury.

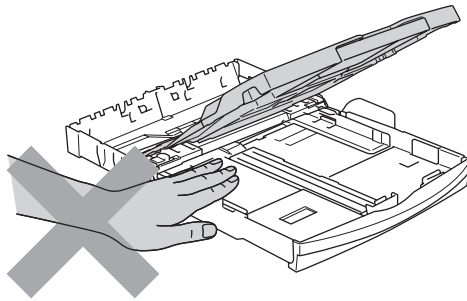

DO NOT touch the paper feed roller. Doing this may cause injury.

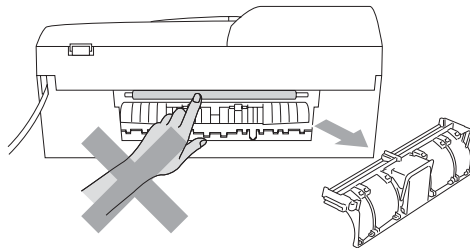



DO NOT touch the area shaded in the illustration. Doing this may cause injury.

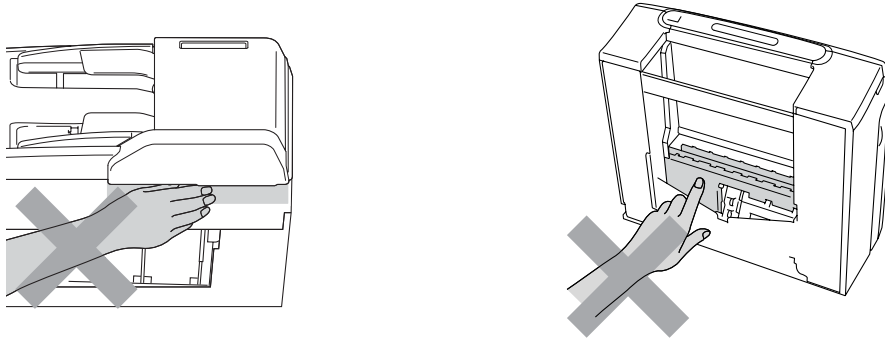

When moving the machine you must lift it from the base, by placing a hand at each side of the unit as shown in the illustration. Do not carry the machine by holding the scanner cover.



If the machine becomes hot, releases smoke, or generates any strong smells, immediately unplug the machine from the AC power outlet. Call Brother Customer Service (See *Brother numbers* on page i.).

If metal objects, water or other liquids get inside the machine, immediately unplug the machine from the AC power outlet. Call Brother Customer Service (See *Brother numbers* on page i.).

WARNING

- Use caution when installing or modifying telephone lines. Never touch telephone wires or terminals that are not insulated unless the telephone line has been unplugged at the wall jack. Never install telephone wiring during a lightning storm. Never install a telephone wall jack in a wet location.
- This product must be installed near an AC power outlet that is easily accessible. In case of an emergency, you must unplug the power cord from the AC power outlet to shut off the power completely.
- Always make sure the plug is fully inserted.
- To reduce the risk of shock or fire, use only a No. 26 AWG or larger telecommunication line cord.

CAUTION

Lightning and power surges can damage this product! We recommend that you use a quality surge protection device on the AC power line and on the telephone line, or unplug the cords during a lightning storm.

WARNING

IMPORTANT SAFETY INSTRUCTIONS

When using your telephone equipment, basic safety precautions should always be followed to reduce the risk of fire, electric shock and injury to people, including the following:

- 1 DO NOT use this product near water, for example, near a bath tub, wash bowl, kitchen sink or washing machine, in a wet basement or near a swimming pool.
- 2 Avoid using this product during an electrical storm. There may be a remote risk of electric shock from lightning.
- 3 DO NOT use this product to report a gas leak in the vicinity of the leak.
- 4 Use only the power cord provided with the machine.

Important safety instructions

- 1 Read all of these instructions.
- 2 Save them for later reference.
- 3 Follow all warnings and instructions marked on the product.
- 4 Unplug this product from the wall outlet before cleaning the inside of the machine. Do not use liquid or aerosol cleaners. Use a damp cloth for cleaning.
- 5 Do not use this product near water.
- 6 Do not place this product on an unstable cart, stand, or table. The product may fall, causing serious damage to the product.
- 7 Slots and openings in the cabinet and the back or bottom are provided for ventilation. To ensure reliable operation of the product and to protect it from overheating, these openings must not be blocked or covered. The openings should never be blocked by placing the product on a bed, sofa, rug, or other similar surface. This product should never be placed near or over a radiator or heater. This product should never be placed in a built-in installation unless proper ventilation is provided.
- 8 This product should be operated from the type of power source indicated on the label. If you are not sure of the type of power available, call your dealer or local power company.
- 9 Use only the power cord supplied with this machine.
- 10 Do not allow anything to rest on the power cord. Do not place this product where people can walk on the cord.
- 11 If an extension cord is used with this product, make sure that the total ampere ratings of the products plugged into the extension cord do not exceed the extension cord ampere rating. Also, make sure that the total of all products plugged into the AC power outlet does not exceed 15 amperes (USA only).
- 12 Do not place anything in front of the machine that will block received faxes. Do not place anything in the path of received faxes.
- 13 Wait until pages have exited the machine before picking them up.
- 14 Never push objects of any kind into this product through cabinet slots, since they may touch dangerous voltage points or short out parts resulting in the risk of fire or electric shock. Never spill liquid of any kind on the product. Do not attempt to service this product yourself because opening or removing covers may expose you to dangerous voltage points and other risks and may void your warranty. Refer all servicing to a Brother Authorized Service Center. For the location of your nearest Brother Authorized Service Center, please call the following:

In USA: 1-800-284-4357

In Canada: 1-877-BROTHER

15 Unplug this product from the AC power outlet and refer all servicing to Brother Authorized Service Personnel under the following conditions:

- When the power cord is damaged or frayed.
- If liquid has been spilled into the product.
- If the product has been exposed to rain or water.
- If the product does not operate normally when the operating instructions are followed, adjust only those controls that are covered by the operating instructions. Improper adjustment of other controls may result in damage and will often require extensive work by a qualified technician to restore the product to normal operation.
- If the product has been dropped or the cabinet has been damaged.
- If the product exhibits a distinct change in performance, indicating a need for service.

16 To protect your product against power surges, we recommend the use of a power protection device (Surge Protector).

17 To reduce the risk of fire, electric shock and injury to people, note the following:

- Do not use this product near appliances that use water, a swimming pool, or in a wet basement.
- Do not use the machine during an electrical storm (there is the remote possibility of an electrical shock) or to report a gas leak in the vicinity of the leak.

18 Caution - To reduce the risk of fire, use only No.26 AWG or larger telecommunication line cord.

Standard telephone and FCC Notices (These notices are in effect on models sold and used in the United States only.)

This equipment is hearing-aid compatible. (MFC-665CW and MFC-845CW only)

When programming emergency numbers or making test calls to emergency numbers:

- Remain on the line and briefly explain to the dispatcher the reason for the call before hanging up.
- Perform these activities in the off-peak hours, such as early morning or late evening.

This equipment complies with Part 68 of the FCC rules and the requirements adopted by the ACTA. On the backside of this equipment is a label that contains, among other information, a product identifier in the format US: AAAEQ##TXXXX. If requested, this number must be provided to the telephone company.

You may safely connect this equipment to the telephone line by means of a standard modular jack, USOC RJ11C.

A plug and jack used to connect this equipment to the premises wiring and telephone network must comply with the applicable FCC Part 68 rules and requirements adopted by the ACTA. A compliant telephone cord and modular plug is provided with this product. It is designed to be connected to a compatible modular jack that is also compliant. See installation instructions for details.

The REN is used to determine the number of devices that may be connected to a telephone line. Excessive RENs on a telephone line may result in the devices not ringing in response to an incoming call. In most but not all areas, the sum of RENs should not exceed five (5.0). To be certain of the number of devices that may be connected to a line, as determined by the total RENs, contact the local telephone company. For products approved after July 23, 2001, the REN for this product is part of the product identifier that has the format US:AAAEQ##TXXXX. The digits represented by ## are the REN without a decimal point (e.g., 06 is a REN of 0.6). For earlier products, the REN is separately shown on the label.

If this equipment causes harm to the telephone network, the telephone company will notify you in advance that temporary discontinuance of service may be required. But if advance notice isn't practical, the telephone company will notify the customer as soon as possible. Also, you will be advised of your right to file a complaint with the FCC if you believe it is necessary.

The telephone company may make changes in its facilities, equipment, operations or procedures that could affect the operation of the equipment. If this happens the telephone company will provide advance notice in order for you to make necessary modifications to maintain uninterrupted service.

If trouble is experienced with this equipment, for repair or warranty information, please contact Brother Customer Service. (See *Brother numbers* on page i.) If the equipment is causing harm to the telephone network, the telephone company may request that you disconnect the equipment until the problem is resolved.

Connection to party line service is subject to state tariffs. Contact the state public utility commission, public service commission or corporation commission for information.

If your home has specially wired alarm equipment connected to the telephone line, ensure the installation of this equipment does not disable your alarm equipment. If you have questions about what will disable alarm equipment, call your telephone company or a qualified installer.

If you are not able to solve a problem with your machine, call Brother Customer Service. (See *Brother numbers* on page i.)



WARNING

For protection against the risk of electrical shock, always disconnect all cables from the wall outlet before servicing, modifying or installing the equipment.

This equipment may not be used on coin service lines provided by the telephone company or connected to party lines.

Brother cannot accept any financial or other responsibilities that may be the result of your use of this information, including direct, special or consequential damages. There are no warranties extended or granted by this document.

This machine has been certified to comply with FCC standards, which are applied to the USA only.

Federal Communications Commission (FCC) Declaration of Conformity (USA only)

Responsible Party: Brother International Corporation
100 Somerset Corporate Boulevard
Bridgewater, NJ 08807-0911
USA
TEL: (908) 704-1700

declares, that the products

Product Name: MFC-440CN, MFC-665CW and MFC-845CW

comply with Part 15 of the FCC Rules. Operation is subject to the following two conditions: (1) This device may not cause harmful interference, and (2) this device must accept any interference received, including interference that may cause undesired operation.

This equipment has been tested and found to comply with the limits for a Class B digital device, pursuant to Part 15 of the FCC Rules. These limits are designed to provide reasonable protection against harmful interference in a residential installation. This equipment generates, uses, and can radiate radio frequency energy and, if not installed and used in accordance with the instructions, may cause harmful interference to radio communications. However, there is no guarantee that interference will not occur in a particular installation. If this equipment does cause harmful interference to radio or television reception, which can be determined by turning the equipment off and on, the user is encouraged to try to correct the interference by one or more of the following measures:

- Reorient or relocate the receiving antenna.
- Increase the separation between the equipment and receiver.
- Connect the equipment into an outlet on a circuit different from that to which the receiver is connected.
- Call the dealer or an experienced radio/TV technician for help.
- This transmitter must not be co-located or operated in conjunction with any other antenna or transmitter.
- This equipment complies with FCC radiation exposure limits set forth for uncontrolled equipment and meets the FCC radio frequency (RF) Exposure Guidelines in Supplement C to OET65. This equipment should be installed and operated with at least 20cm and more between the radiator and person's body (excluding extremities: hands, wrists, feet and legs).

IMPORTANT

Changes or modifications not expressly approved by Brother Industries, Ltd. could void the user's authority to operate the equipment.

Industry Canada Compliance Statement (Canada only)

This Class B digital apparatus complies with Canadian ICES-003.

Cet appareil numérique de la classe B est conforme à la norme NMB-003 du Canada.

LAN connection

CAUTION

DO NOT connect this product to a LAN connection that is subject to over-voltages.

Legal limitations for copying

Color reproductions of certain documents are illegal and may result in either criminal or civil liability. This memorandum is intended to be a guide rather than a complete listing of every possible prohibition. In case of doubt, we suggest that you check with counsel as to any particular questionable documents.

The following documents issued by the United States/Canadian Government or any of its Agencies may not be copied:

- Money
- Bonds or other certificates of indebtedness
- Certificates of Deposit
- Internal Revenue Stamps (canceled or uncanceled)
- Selective Service or draft papers
- Passports
- United States/Canadian Postage Stamps (canceled or uncanceled)
- Food Stamps
- Immigration Papers
- Checks or drafts drawn by Governmental agencies
- Identifying badges or insignias

Copyrighted works cannot be copied. Sections of a copyrighted work can be copied for 'fair use.' Multiple copies would indicate improper use.

Works of art should be considered the equivalent of copyrighted works.

Licenses and Certificates of Title to motor vehicles may not be copied under certain state/provincial laws.

Trademarks

The Brother logo is a registered trademark of Brother Industries, Ltd.

Brother is a registered trademark of Brother Industries, Ltd.

Multi-Function Link is a registered trademark of Brother International Corporation.

© 2006 Brother Industries, Ltd. All rights reserved.

Windows and Microsoft are registered trademarks of Microsoft in the U.S. and other countries.

Macintosh and TrueType are registered trademarks of Apple Computer, Inc.

PaperPort is a registered trademark of ScanSoft, Inc.

Presto! PageManager is a registered trademark of NewSoft Technology Corporation.

Microdrive is a trademark of International Business Machine Corporation.

CompactFlash is a registered trademark of SanDisk Corporation.

Memory Stick is a registered trademark of Sony Corporation.

SecureDigital is a trademark of Matsushita Electric Industrial Co. Ltd., SanDisk Corporation and Toshiba Corporation.

SanDisk is a licensee of the SD and miniSD trademarks.

MultiMediaCard is a trademark of Infineon Technologies and licensed to the MultiMediaCard Association.

xD-Picture Card is a trademark of Fujifilm Co. Ltd., Toshiba Corporation and Olympus Optical Co. Ltd.

PictBridge is a trademark.

Memory Stick Pro, Memory Stick Pro Duo, Memory Stick Duo and MagicGate are trademarks of Sony Corporation.

BROADCOM, SecureEasySetup and the SecureEasySetup logo are trademarks or registered trademarks of Broadcom Corporation in the United States and/or other countries.

Each company whose software title is mentioned in this manual has a Software License Agreement specific to its proprietary programs.

All other brand and product names mentioned in this User's Guide, the Software User's Guide and the Network User's Guide are registered trademarks of their respective companies.

B

Troubleshooting and Routine Maintenance

Troubleshooting

IMPORTANT

For technical help, you must call the country where you bought the machine. Calls must be made **from within** that country.

If you think there is a problem with your machine, check the chart below and follow the troubleshooting tips.

Most problems can be easily resolved by yourself. If you need additional help, the Brother Solutions Center offers the latest FAQs and troubleshooting tips. Visit us at <http://solutions.brother.com>.

If you are having difficulty with your machine

Printing

Difficulty	Suggestions
No printout	Check the interface cable or wireless connection (MFC-665CW and MFC-845CW only) on both the machine and your computer. (See the <i>Quick Setup Guide</i> .)
	Check that the machine is plugged in and that the On/Off key is on.
	One or more ink cartridges are empty. (See <i>Replacing the ink cartridges</i> on page 143.)
	Check to see if the LCD is showing an error message. (See <i>Error messages</i> on page 136.)
	Check that the correct printer driver has been installed and chosen.
	Make sure that the machine is online. Click Start and then Printers and Faxes . Right-click and choose Brother MFC-XXXX (where XXXX is your model name), and make sure that Use Printer Offline is unchecked.
Poor print quality	Check the print quality. (See <i>Checking the print quality</i> on page 148.)
	Make sure that the Media Type setting in the printer driver or the Paper Type setting in the machine's menu matches the type of paper you are using. (See <i>Printing for Windows®</i> or <i>Printing and Faxing for Macintosh®</i> in the Software User's Guide on the CD-ROM and <i>Paper Type</i> on page 26.)
	Make sure that your ink cartridges are fresh. The following may cause ink to clog: <ul style="list-style-type: none"> ■ The expiration date written on the cartridge package has passed. (Cartridges stay usable for up to two years if kept in their original packaging.) ■ The ink cartridge was in your machine over six months. ■ The ink cartridge may not have been stored properly before use.
	Try using the recommended types of paper. (See <i>Acceptable paper and other media</i> on page 13.)
	The recommended environment for your machine is between 68° F to 91° F (20° C to 33° C).

Printing (Continued)

Difficulty	Suggestions
White horizontal lines appear in text or graphics.	Clean the print head. (See <i>Cleaning the print head</i> on page 148.)
	Try using the recommended types of paper. (See <i>Acceptable paper and other media</i> on page 13.)
	If you want to print on Photo 4"×6" or Photo L 3.5"×5" paper, make sure you use the photo bypass tray. (See <i>Loading photo paper</i> on page 21.)
The machine prints blank pages.	Clean the print head. (See <i>Cleaning the print head</i> on page 148.)
Characters and lines are stacked.	Check the printing alignment. (See <i>Checking the printing alignment</i> on page 149.)
Printed text or images are skewed.	Make sure the paper is loaded properly in the paper tray and the paper side guide is adjusted correctly. (See <i>Loading paper and other media</i> on page 17.)
	Make sure the Jam Clear Cover is set properly.
Smudged stain at the top center of the printed page.	Make sure the paper is not too thick or curled. (See <i>Acceptable paper and other media</i> on page 13.)
Printing appears dirty or ink seems to run.	Make sure you are using the proper types of paper. (See <i>Acceptable paper and other media</i> on page 13.) Don't handle the paper until the ink is dry.
Stains appear on the reverse side or at the bottom of the page.	Make sure the printer platen is not dirty with ink. (See <i>Cleaning the machine printer platen</i> on page 147.)
	Make sure you are using the paper support flap. (See <i>Loading paper and other media</i> on page 17.)
There are some dense lines.	Check Reverse Order in the Basic tab of the printer driver.
The printouts are wrinkled.	In the printer driver Basic tab, click Settings , and uncheck Bi-Directional Printing .
Cannot perform '2 in 1 or 4 in 1' printing.	Check that the paper size setting in the application and in the printer driver are the same.
Print speed is too slow.	Try changing the printer driver setting. The highest resolution needs longer data processing, sending and printing time. Try the other quality settings in the printer driver Basic tab. Also, click the Settings tab, and make sure you uncheck Color Enhancement (True2Life®) .
	Turn the borderless feature off. Borderless printing is slower than normal printing. (See <i>Printing for Windows®</i> or <i>Printing and Faxing for Macintosh®</i> in the Software User's Guide on the CD-ROM.)
True2Life® is not working properly.	If the image data is not full color in your application (such as 256 color), True2Life® will not work. Use at least 24 bit color data with the True2Life® feature.
Machine feeds multiple pages.	Make sure the paper is loaded properly in the paper tray. (See <i>Loading paper and other media</i> on page 17.)
	Check that more than two types of paper are not loaded in the paper tray at any one time.
Printed pages are not stacked neatly.	Make sure you are using the paper support flap. (See <i>Loading paper and other media</i> on page 17.)
Printed pages double feed and cause a paper jam.	Make sure you pull out the paper support until it clicks and unfold the paper support flap.
Machine does not print from Paint Brush.	Try setting the Display setting to '256 colors.'
Machine does not print from Adobe Illustrator.	Try to reduce the print resolution. (See <i>Printing for Windows®</i> or <i>Printing and Faxing for Macintosh®</i> in the Software User's Guide on the CD-ROM.)

Printing (Continued)

Difficulty	Suggestions
Machine cannot print full pages of a document. Out of memory message occurs.	Reduce the print resolution. (See <i>Printing for Windows®</i> or <i>Printing and Faxing for Macintosh®</i> in the Software User's Guide on the CD-ROM.) Reduce the complexity of your document and try again. Reduce the graphic quality or the number of font sizes within your application software.

Printing Received Faxes

Difficulty	Suggestions
Condensed print and white streaks across the page or the top and bottom of sentences are cut off.	You probably had a bad connection, with static or interference on the telephone line. Ask the other party to send the fax again.
Vertical black lines when receiving.	The sender's scanner may be dirty. Ask the sender to make a copy to see if the problem is with the sending machine. Try receiving from another fax machine.
Received color fax prints only in black and white.	Replace the color ink cartridges that are empty or nearly empty, and then ask the other person to send the color fax again. (See <i>Replacing the ink cartridges</i> on page 143.) Check that Advanced Fax Operation is set to off. (See <i>Turning off Advanced Fax Operations</i> on page 81.)
Left and Right margins are cut off or a single page is printed on two pages.	Turn on Auto Reduction. (See <i>Printing a reduced incoming fax</i> on page 51.)

Phone Line or Connections

Difficulty	Suggestions
Dialing does not work. (No dial tone)	Check that the machine is plugged in and that the On/Off key is on.
	Check all line cord connections.
	(Canada only) Change Tone/Pulse setting. (See <i>Quick Setup Guide</i> .)
	Send a fax manually and wait to hear the fax receiving tone before you press Black Start or Color Start . (See <i>Sending a fax manually</i> on page 44)
The machine does not answer when called.	Make sure the machine is in the correct receiving mode for your setup. (See <i>Choosing the Receive Mode</i> on page 46.) Check for a dial tone. If possible, call your machine to hear it answer. If there is still no answer, check the telephone line cord connection. If there is no ringing when you call your machine, ask your telephone company to check the line.

Receiving Faxes

Difficulty	Suggestions
Cannot receive a fax.	Check all line cord connections.
	Make sure the machine is in the correct receiving mode for your setup. (See <i>Receive mode settings</i> on page 49.)
	If you often have interference on the phone line, try changing the menu setting of Compatibility to Basic . (See <i>Phone line interference</i> on page 143.)

Sending Faxes

Difficulty	Suggestions
Cannot send a fax.	Check all line cord connections.
	Make sure that the Fax  key is illuminated. (See <i>Entering Fax mode</i> on page 38.)
	Ask the other party to check that the receiving machine has paper.
	Print the Transmission Verification Report and check for an error. (See <i>Reports</i> on page 88.)
Transmission Verification Report says 'Result:NG'.	There is probably temporary noise or static on the line. Try sending the fax again. If you send a PC FAX message and get 'Result:NG' on the Transmission Verification Report, your machine may be out of memory. To gain extra memory, you can turn off Advanced Fax Operation (see <i>Turning off Advanced Fax Operations</i> on page 81), print fax messages in memory (see <i>Printing a fax from the memory</i> on page 51) or cancel a Delayed Fax or Polling Job (see <i>Canceling a fax in progress</i> on page 39). If the problem continues, ask the telephone company to check your phone line.
	If you often get transmission errors due to possible interference on the phone line, try changing the menu setting of Compatibility to <i>Basic</i> . (See <i>Phone line interference</i> on page 143.)
Poor fax send quality.	Try changing your resolution to <i>Fine</i> or <i>S.Fine</i> . Make a copy to check your machine's scanner operation. If the copy quality is not good, clean the scanner. (See <i>Cleaning the scanner</i> on page 146.)
Vertical black lines when sending.	If the copy you made shows the same problem, clean the scanner. (See <i>Cleaning the scanner</i> on page 146.)

Handling Incoming Calls

Difficulty	Suggestions
The machine 'Hears' a voice as a CNG Tone.	If Easy Receive is set to on, your machine is more sensitive to sounds. It may mistakenly interpret certain voices or music on the line as a fax machine calling and respond with fax receiving tones. Deactivate the machine by pressing Stop/Exit . Try avoiding this problem by turning Easy Receive to off. (See <i>Easy Receive</i> on page 50.)
Sending a fax call to the machine.	If you answered on an external or extension phone, press your Fax Receive Code (the factory setting is * 5 1). When your machine answers, hang up.
Custom features on a single line.	If you have Call Waiting, Call Waiting/Caller ID, Voice Mail, an alarm system or other custom feature on a single phone line with your machine, it may create a problem sending or receiving faxes. For example: If you subscribe to Call Waiting or some other custom service and its signal comes through the line while your machine is sending or receiving a fax, the signal can temporarily interrupt or disrupt the faxes. Brother's ECM feature should help overcome this problem. This condition is related to the telephone system industry and is common to all devices that send and receive information on a single, shared line with custom features. If avoiding a slight interruption is crucial to your business, a separate phone line with no custom features is recommended.

Copying Difficulties

Difficulty	Suggestions
Cannot make a copy.	Make sure that the Copy  key is illuminated. (See <i>Entering Copy mode</i> on page 92.)
Vertical streaks appear in copies.	If you see vertical streaks on copies, clean the scanner. (See <i>Cleaning the scanner</i> on page 146.)
Poor copy results when using the ADF.	Try using the scanner glass. (See <i>Using the scanner glass</i> on page 12.)

Scanning Difficulties

Difficulty	Suggestions
TWAIN/WIA errors appear while scanning.	Make sure the Brother TWAIN/WIA driver is chosen as the primary source. In PaperPort® SE with OCR, click File, Scan and choose the Brother TWAIN/WIA driver.
Poor scanning results when using the ADF.	Try using the scanner glass. (<i>Using the scanner glass</i> on page 12.)

Software Difficulties

Difficulty	Suggestions
Cannot install software or print.	Run the Repair MFL-Pro Suite program on the CD-ROM. This program will repair and reinstall the software.
'Device Busy'	Make sure the machine is not showing an error message on the LCD.

PhotoCapture Center® Difficulties

Difficulty	Suggestions
Removable Disk does not work properly.	<ol style="list-style-type: none"> 1) Have you installed the Windows® 2000 update? If not, do the following: <ol style="list-style-type: none"> 1) Unplug the USB cable. 2) Install the Windows® 2000 update, and see the Quick Setup Guide. After the installation the PC will be automatically restarted. 3) Wait about 1 minute after you restart the PC, and then connect the USB cable. 2) Take out the media card and put it back in again. 3) If you have tried 'Eject' from within Windows®, take out the media card before you continue. 4) If an error message appears when you try to eject the media card, it means the card is being accessed. Wait a while and then try again. 5) If all of the above do not work, turn off your PC and machine, and then turn them on again. (You will have to unplug the power cord of the machine to turn it off.)
Cannot access Removable Disk from Desktop icon.	Make sure you have put the media card into the media slot.

Network Difficulties

Difficulty	Suggestions
Cannot print over the Network.	<p>Make sure that your machine is powered on and is online and in Ready mode. Print a Network Configuration list (see <i>Reports</i> on page 88.) and check the current Network settings printed in this list. Reconnect the LAN cable to the hub to verify that the cabling and network connections are good. If possible, try connecting the machine to a different port on your hub using a different cable. If the connections are good, the machine shows <i>LAN Active</i> for 2 seconds.</p> <p>(If you are using a wireless connection (MFC-665CW and MFC-845CW only) or are having Network problems, see the Network User's Guide on the CD-ROM for more information.)</p>
The network scanning feature does not work.	<p>(For Windows® users only) A Firewall setting on your PC may be rejecting the necessary network connection. Follow the instructions below to configure the Firewall. If you are using a personal Firewall software, see the User's Guide for your software or contact the software manufacturer.</p> <p><Windows® XP SP2 users></p> <ol style="list-style-type: none"> 1 Click the Start button, Control Panel and then Windows Firewall. Make sure that Windows Firewall on the General tab is set to On. 2 Click Advanced tab and Settings button in Network Connection Settings. 3 Click Add button, and in the "Description of service" field, enter any name. In the "Name or IP Address" field enter "localhost". In the internal and external port numbers fields enter "54925" for network scanning. Choose UDP and click OK. Repeat this step adding Port 54926 for network PC-FAX receiving and Port 137 for both network scanning and network PC-FAX receiving. 4 Make sure the new settings are added and the box is checked, and then click OK.
The network PC-Fax Receive feature does not work.	
Your computer cannot find your machine.	<p><Windows® users></p> <p>Firewall setting on you PC may be rejecting the necessary network connection. For detail, see the instruction above.</p> <p><Macintosh® users></p> <p>Re-select your machine in the DeviceSelector application located in Macintosh HD/Library/Printers/Brother/Utilities or from the model of ControlCenter2.</p>

Error messages

As with any sophisticated office product, errors may occur. If this happens, your machine identifies the error and shows an error message. The most common error messages are shown below.

You can correct most errors by yourself. If you need more help, the Brother Solutions Center offers the latest FAQs and troubleshooting tips.

Visit us at <http://solutions.brother.com>.

Error Message	Cause	Action
Comm. Error	Poor phone line quality caused a communication error.	Send the fax again or connect the machine to another telephone line. If the problem continues, call the telephone company and ask them to check your phone line.
Connection Fail	You tried to poll a fax machine that is not in Polled Waiting mode.	Check the other fax machine's polling setup.
Cover is Open	The scanner cover is not closed completely.	Lift the scanner cover and then close it again.
	The ink cartridge cover is not completely closed.	Firmly close the ink cartridge cover until it clicks.
Data Remaining	Print data is left in the machine's memory.	Re-start printing from your computer.
	Print data is left in the machine's memory. The USB cable was unplugged while the computer was sending the data to the machine.	Press Stop/Exit . The machine will cancel the job and clear it from the memory. Try to print again.
Disconnected	The other person or other person's fax machine stopped the call.	Try to send or receive again.
Document Jam	The document was not inserted or fed properly, or the document scanned from the ADF was too long.	See <i>Using the ADF</i> on page 11. See <i>Document jam</i> on page 140.
DR Mode in Use	The machine is set to Distinctive Ring mode. You cannot change the Receive Mode from Manual to another mode.	Set Distinctive Ring to off. (See <i>Turning off Distinctive Ring</i> on page 55.)
High Temperature	The print head is too warm.	Allow the machine to cool down.
Ink Empty	One or more of the ink cartridges is empty. The machine will stop all print operations. While memory is available, black and white faxes will be stored in the memory. If a sending machine has a color fax, the machine's 'handshake' will ask that the fax be sent as black and white. If the sending machine has the ability to convert it, the color fax will be stored in the memory as a black and white fax.	Replace the ink cartridges. (See <i>Replacing the ink cartridges</i> on page 143.)

Error Message	Cause	Action
Low Temperature	The print head is too cold.	Allow the machine to warm up.
Media Error	The media card is either corrupted, improperly formatted, or there is a problem with the media card.	Put the card firmly into the slot again to make sure it is in the correct position. If the error remains, check the media drive by putting in another media card that you know is working.
Near Empty	One or more of the ink cartridges are running out of ink. If a sending machine has a color fax, the machine's 'handshake' will ask that the fax be sent as black and white. If the sending machine has the ability to convert it, the color fax will be received into memory as a black and white fax.	Order a new ink cartridge. (See <i>Ordering accessories and supplies</i> on page iii.)
No Caller ID	There is no incoming call history. You did not receive calls or you have not subscribed to the Caller ID service from your telephone company.	If you want to use the Caller ID feature call your telephone company. (See <i>Caller ID</i> on page 56.)
No Cartridge	An ink cartridge is not installed properly.	Reinstall the ink cartridge. (See <i>Replacing the ink cartridges</i> on page 143.)
No File	The media card in the media drive does not contain a .JPG file.	Put the correct media card into the slot again.
No Paper Fed	The machine is out of paper or paper is not properly loaded in the paper tray.	Do one of the following: <ul style="list-style-type: none"> ■ Refill the paper in the paper tray, and then press Black Start or Color Start. ■ Remove the paper and load it again and then press Black Start or Color Start.
	The paper is jammed in the machine.	See <i>Printer jam or paper jam</i> on page 141.
No Response/Busy	The number you dialed does not answer or is busy.	Verify the number and try again.
Not Registered	You tried to access a Speed Dial number that is not programmed.	Set up the Speed Dial number. (See <i>Storing Speed-Dial numbers</i> on page 66.)

Error Message	Cause	Action
Out of Memory	The machine's memory is full.	<p>Fax sending or copy operation in progress</p> <p>Do one of the following:</p> <ul style="list-style-type: none"> ■ Press Stop/Exit and wait until the other operations in progress finish and then try again. ■ Clear the data in the memory. To gain extra memory, you can turn off Advanced Fax Operation. (See <i>Turning off Advanced Fax Operations</i> on page 81.) ■ Print the faxes that are in the memory. (See <i>Printing a fax from the memory</i> on page 51.) <p>Printing operation in progress</p> <p>Reduce print resolution. (For details, see <i>Printing for Windows</i>[®] or <i>Printing and Faxing for Macintosh</i>[®] in the Software User's Guide on the CD-ROM.)</p>
Paper Jam	Paper is jammed in the machine.	Open the Jam Clear Cover (at the back of the machine) and remove the jammed paper. (See <i>Printer jam or paper jam</i> on page 141.)
Unable to Change XX Unable to Clean XX Unable to Init. XX Unable to Print XX Unable to Scan XX Unable to use Phone XX	<p>The machine has a mechanical problem.</p> <p>—OR—</p> <p>A foreign objects such as a clip or ripped paper is in the machine.</p>	<p>Open the scanner cover and remove any foreign objects inside the machine. If the error message continues, do one of the following:</p> <ul style="list-style-type: none"> ■ (MFC-440CN only) See <i>Transferring your faxes or Fax Journal report</i> on page 139 before disconnecting the machine so you will not lose any important messages. Then, disconnect the machine from the power for several minutes and then reconnect it. ■ (MFC-665CW and MFC-845CW only) Disconnect the machine from the power for several minutes, then reconnect it. (The machine can be turned off for approximately 24 hours without losing faxes stored in the memory. See <i>Transferring your faxes or Fax Journal report</i> on page 139.)
Wrong Paper Size	Paper is not the correct size.	Load the correct size of paper (Letter, Legal or A4), and then press Black Start or Color Start .
Wrong USB device	A non-PictBridge compatible or broken device has been connected to the PictBridge port.	Unplug the device from the PictBridge port, then press On/Off to turn the machine off and then on again.

Transferring your faxes or Fax Journal report

If the LCD shows:

- Unable to Change XX
- Unable to Clean XX
- Unable to Init. XX
- Unable to Print XX
- Unable to Scan XX
- Unable to use Phone XX

We recommend transferring your faxes to another fax machine or to your PC. (See *Transferring faxes to another fax machine* on page 139 or *Transferring faxes to your PC* on page 139.)

You can also transfer the Fax Journal report to see if there are any faxes you need to transfer. (See *Transferring Fax Journal report to another fax machine* on page 140.)



Note

If there is an error message on the machine's LCD, after the faxes have been transferred, disconnect the machine from the power source for several minutes, and then reconnect it.

Transferring faxes to another fax machine

If you have not set up your Station ID, you cannot enter fax transfer mode.

- 1 Press **Stop/Exit** to interrupt the error temporarily.
- 2 Press **Menu**.
- 3 Press **▲** or **▼** to choose *Service*. Press **OK**.
- 4 Press **▲** or **▼** to choose *Data Transfer*. Press **OK**.

- 5 Press **▲** or **▼** to choose *Fax Transfer*. Press **OK**.
- 6 Do one of the following:
 - If the LCD shows *No Data*, there are no faxes left in the machine's memory. Press **Stop/Exit**.
 - Enter the fax number to which faxes will be forwarded.
- 7 Press **Black Start**.

Transferring faxes to your PC

You can transfer the faxes from your machine's memory to your PC.

- 1 Press **Stop/Exit** to interrupt the error temporarily.
- 2 Make sure you have installed **MFL-Pro Suite** on your PC, and then turn on **PC FAX Receiving** on the PC. (For details see *PC- FAX receiving for Windows®* in the Software User's Guide on the CD-ROM.)
- 3 Make sure you have set **PC Fax Receive** on the machine. (See *PC Fax Receive* on page 80.)
If faxes are in the machine's memory when you set up **PC Fax Receive**, the LCD will ask if you want to transfer the faxes to your PC.
- 4 Do one of the following:
 - To transfer all faxes to your PC, press **1**. You will be asked if you want a backup print.
 - To exit and leave the faxes in the memory, press **2**.
- 5 Press **Stop/Exit**.

Transferring Fax Journal report to another fax machine

If you have not set up your Station ID, you cannot enter fax transfer mode.

- 1 Press **Stop/Exit** to interrupt the error temporarily.
- 2 Press **Menu**.
- 3 Press **▲** or **▼** to choose *Service*. Press **OK**.
- 4 Press **▲** or **▼** to choose *Data Transfer*. Press **OK**.
- 5 Press **▲** or **▼** to choose *Report Trans..* Press **OK**.
- 6 Enter the fax number to which Fax Journal report will be forwarded.
- 7 Press **Black Start**.

Document jam

Documents can jam if they are not inserted or fed properly, or if they are too long. Follow the steps below to clear a document jam.

Document is jammed in the top of the ADF unit

- 1 Take out any paper from the ADF that is not jammed.
- 2 Open the ADF cover.

- 3 Pull the jammed document up and to the left.

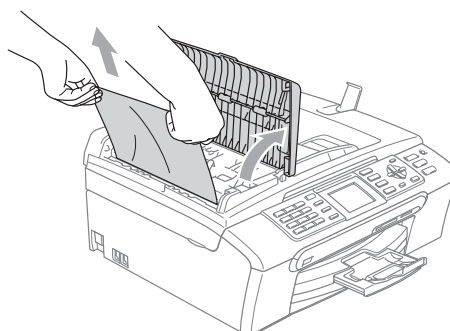

- 4 Close the ADF cover.
- 5 Press **Stop/Exit**.



Note

To avoid document jams close the ADF cover properly by pressing it down in the center.

Document is jammed inside the ADF unit

- 1 Take out any paper from the ADF that is not jammed.
- 2 Lift the document cover.
- 3 Pull the jammed document out to the left.

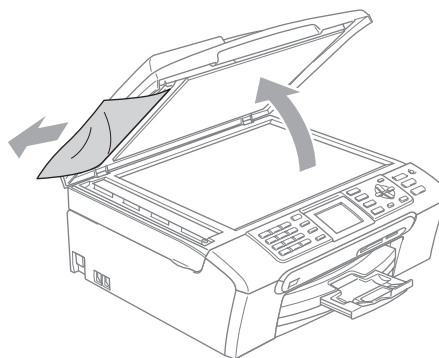

- 4 Close the document cover.
- 5 Press **Stop/Exit**.

Printer jam or paper jam

Take out the jammed paper depending on where it is jammed in the machine.

- 1 Pull the paper tray (1) out of the machine.

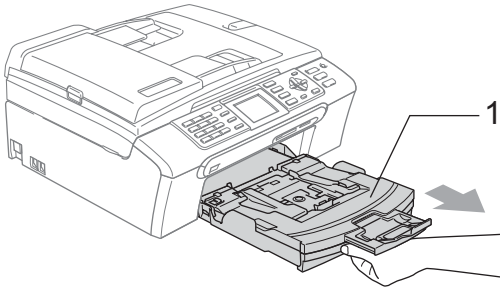

- 2 Pull out the jammed paper (1).

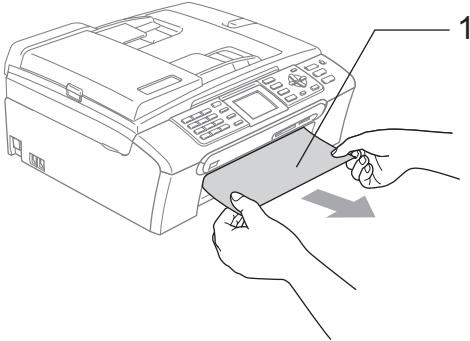

- 3 Reset the machine by lifting the scanner cover from the front of the machine and then closing it.

- If you cannot remove the jammed paper from the front of the machine, or the error message still appears on the LCD after you have removed the jammed paper, please go to the next step.

- 4 Remove the Jam Clear Cover (1) from the back of the machine. Pull the jammed paper out of the machine.

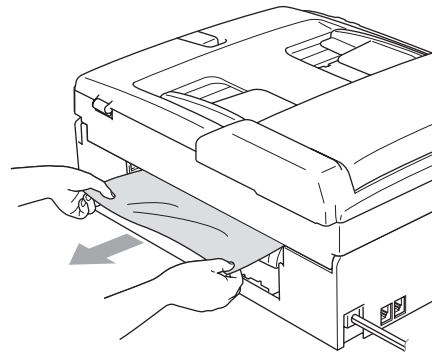
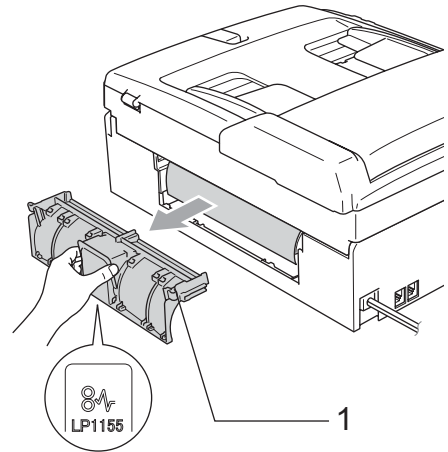

- 5 Put the Jam Clear Cover back on. Make sure the cover is set properly.

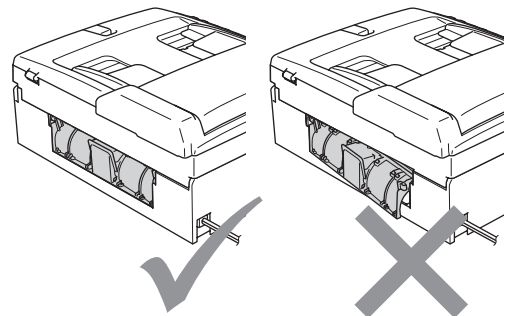

- 6 Using both hands, use the plastic tabs on both sides of the machine to lift the scanner cover (1) until it locks securely into the open position. Make sure that there is no jammed paper left in the corners of the machine.

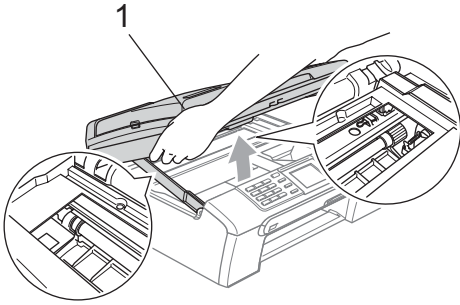

 **Note**

If the paper is jammed under the print head, unplug the machine from the power source, and then move the print head to take out the paper.

- 7 Lift the scanner cover to release the lock (1). Gently push the scanner cover support down (2) and close the scanner cover (3).

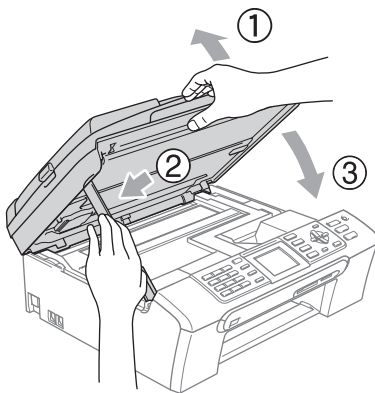

- 8 Push the paper tray firmly back into the machine.

 **Note**

Make sure you pull out the paper support until it clicks.

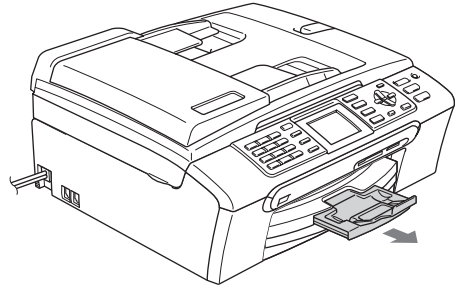

Dial Tone

Setting the dial tone to Detection will shorten the dial detect pause.

- 1 Press **Menu**.
- 2 Press **▲** or **▼** to choose *Initial Setup*. Press **OK**.
- 3 Press **▲** or **▼** to choose *Dial Tone*. Press **OK**.
- 4 Press **▲** or **▼** to choose *Detection* or *No Detection*. Press **OK**.
- 5 Press **Stop/Exit**.

Phone line interference

If you are having problems sending or receiving a fax due to possible interference on the phone line, we recommend that you adjust the Equalization for compatibility to reduce the modem speed for fax operations.

- 1 Press **Menu**.
- 2 Press **▲** or **▼** to choose **Fax**.
Press **OK**.
- 3 Press **▲** or **▼** to choose **Miscellaneous**.
Press **OK**.
- 4 Press **▲** or **▼** to choose **Compatibility**.
Press **OK**.
- 5 Press **▲** or **▼** to choose **Normal** (or **Basic**).
 - **Basic** reduces the modem speed to 9600 bps. Unless interference is a recurring problem on your phone line, you may prefer to use it only when needed.
 - **Normal** sets the modem speed at 14400 bps. (factory setting)
 Press **OK**.
- 6 Press **Stop/Exit**.



Note

When you change the compatibility to **Basic**, the ECM feature is only available for color fax sending.

Routine maintenance

Replacing the ink cartridges

Your machine is equipped with an ink dot counter. The ink dot counter automatically monitors the level of ink in each of the 4 cartridges. When the machine detects an ink cartridge is running out of ink, the machine will tell you with a message on the LCD.

The LCD will tell you which ink cartridge is low or needs replacing. Be sure to follow the LCD prompts to replace the ink cartridges in the correct order.

Even though the machine tells you that an ink cartridge is empty, there will be a small amount of ink left in the ink cartridge. It is necessary to keep some ink in the ink cartridge to prevent air from drying out and damaging the print head assembly.

- 1 Open the ink cartridge cover.
If one or more ink cartridges are empty, for example **Black**, the LCD shows **Ink Empty** and **Black**.
- 2 Pull the lock release lever down and take out the ink cartridge for the color shown on the LCD.

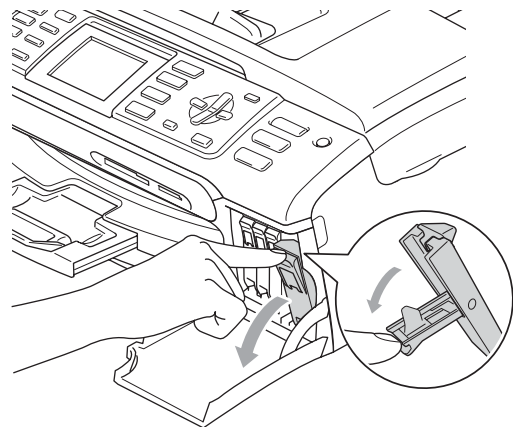

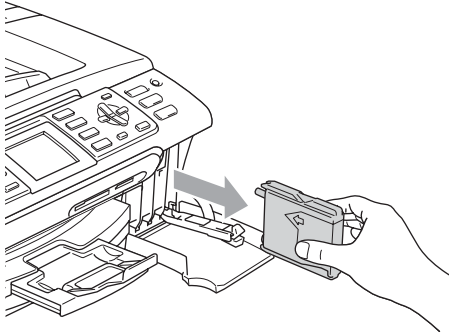

- 3 Open the new ink cartridge bag for the color shown on the LCD, and then take out the ink cartridge.
- 4 Remove the protective yellow cap (1).

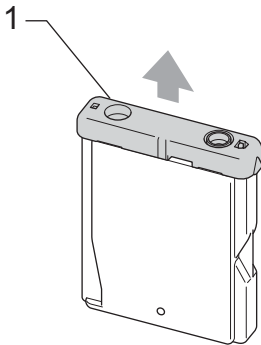

Improper Setup

DO NOT touch the area shown in the illustration below.

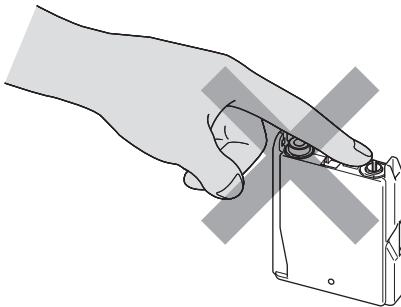

Note

If the protective yellow caps come off when you open the bag, the cartridge will not be damaged.

- 5 Each color has its own correct position. Insert the ink cartridge in the direction of the arrow on the label.

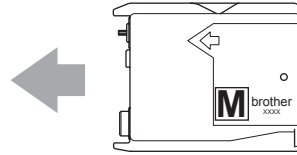

- 6 Lift the lock release lever and push it until it clicks, and then close the ink cartridge cover.

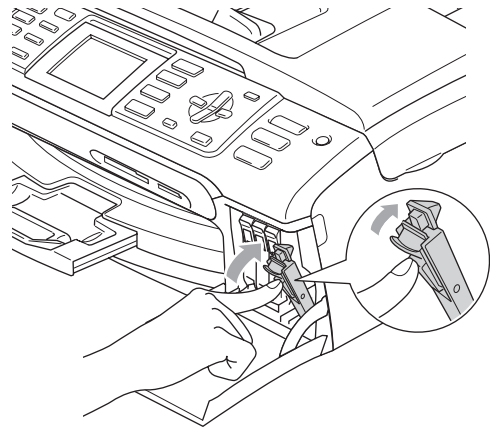

- 7 If you replaced an ink cartridge, the LCD may ask you to verify that it was a brand new one. (For example, Did You Change Black) For each new cartridge you installed, press **1** (Yes) to automatically reset the ink dot counter for that color. If the ink cartridge you installed is not a brand new one, be sure to press **2** (No). If you wait until the LCD shows *Near Empty* and *Ink Empty*, the machine will automatically reset the ink dot counter.



Note

If the LCD shows **No Cartridge** after you install the ink cartridges, check that the ink cartridges are installed properly.



WARNING

If ink gets in your eyes, wash them out with water at once and call a doctor if you are concerned.



CAUTION

DO NOT take out ink cartridges if you do not need to replace them. If you do so, it may reduce the ink quantity and the machine will not know the quantity of ink left in the cartridge.

DO NOT touch the cartridge insertion slots. If you do so, the ink may stain your skin.

If ink stains your skin or clothing, wash with soap or detergent at once.

If you mix the colors by installing an ink cartridge in the wrong position, clean the print head several times after correcting the cartridge installation.

Once you open an ink cartridge, install it in the machine and use it up within six months of installation. Use unopened ink cartridges by the expiration date written on the cartridge package.

DO NOT dismantle or tamper with the ink cartridge, this can cause the ink to leak out of the cartridge.

Brother strongly recommends that you do not refill the ink cartridges provided with your machine. We also strongly recommend that you continue to use only Genuine Brother Brand replacement ink cartridges. Use or attempted use of potentially incompatible ink and/or cartridges in the Brother machine may cause damage to the machine and/or may result in unsatisfactory print quality. Our warranty coverage does not apply to any problem that is caused by the use of unauthorized third party ink and/or cartridges. To protect your investment and obtain premium performance from the Brother machine, we strongly recommend the use of Genuine Brother Supplies.

Cleaning the outside of the machine



CAUTION

Use neutral detergents. Cleaning with volatile liquids such as thinner or benzene will damage the outside surface of the machine.

DO NOT use cleaning materials that contain ammonia.

DO NOT use isopropyl alcohol to remove dirt from the control panel. It may crack the panel.

Clean the outside of the machine as follows:

- 1 Pull the paper tray (1) completely out of the machine.

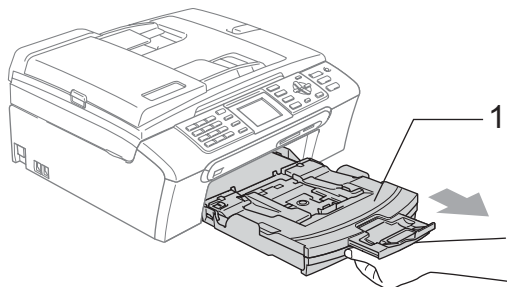

- 2 Wipe the outside of the machine with a soft cloth to remove dust.

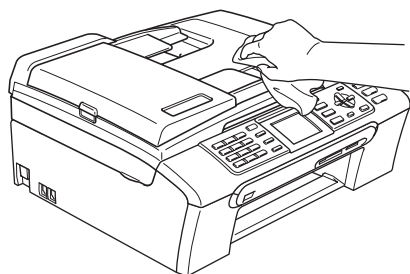

- 3 Remove anything that is stuck inside the paper tray.

- 4 Wipe the paper tray with a soft cloth to remove dust.

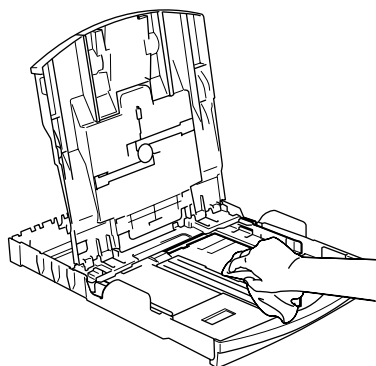

- 5 Put the paper tray firmly back in the machine.

Cleaning the scanner

- 1 Lift the document cover (1). Clean the scanner glass (2) and the white plastic (3) with isopropyl alcohol on a soft lint-free cloth.

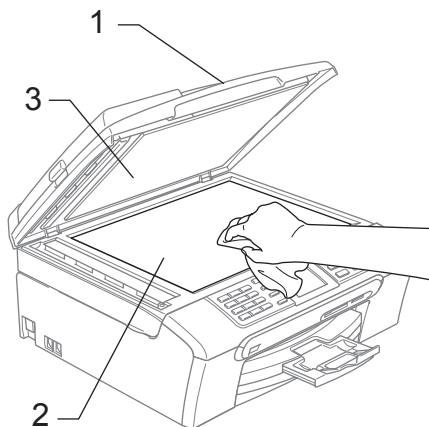

- 2 In the ADF unit, clean the white bar (1) and the glass strip (2) under it with isopropyl alcohol on a lint-free cloth.

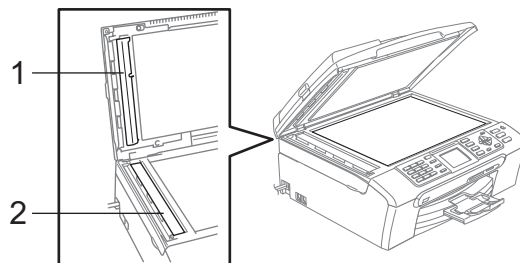

Cleaning the machine printer platen

WARNING

Be sure to unplug the machine from the AC power outlet before cleaning the printer platen (1).

If ink is scattered on or around the printer platen wipe it off with a soft, *dry*, lint-free cloth.

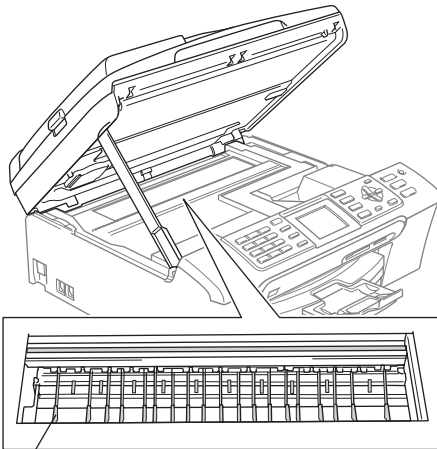

1

- 1 Using both hands, use the plastic tabs on both sides of the machine to lift the scanner cover until it locks securely into the open position.
- 2 Clean the machine printer platen (1).

Cleaning the paper pick-up roller

- 1 Pull the paper tray completely out of the machine.
- 2 Unplug the machine from the AC power outlet and remove the Jam Clear Cover (1).

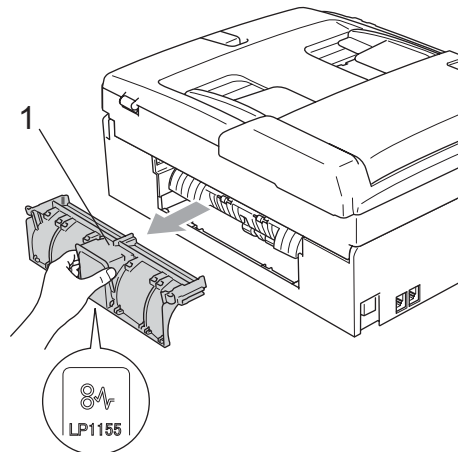

- 3 Clean the Paper Pick-up Roller (1) with isopropyl alcohol on a cotton swab.

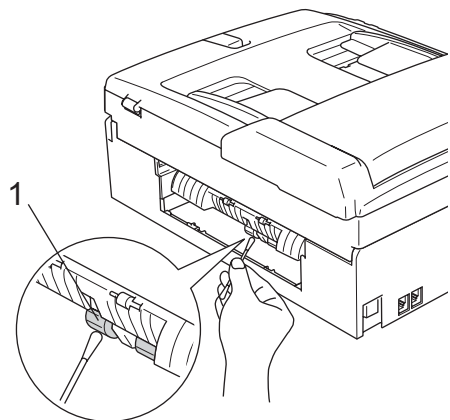

- 4 Put the Jam Clear Cover back on. Make sure the cover is set properly.
- 5 Put the paper tray firmly back in the machine.
- 6 Re-connect the power cord.

Cleaning the print head

To ensure the good print quality, the machine will regularly clean the print head. You can start the cleaning process manually if needed.

Clean the print head and ink cartridges if you get a horizontal line in the text or graphics on your printed pages. You can clean Black only, three colors at a time (Cyan/Yellow/Magenta), or all four colors at once.

Cleaning the print head consumes ink. Cleaning too often uses ink unnecessarily.

! CAUTION

DO NOT touch the print head. Touching the print head may cause permanent damage and may void the print head's warranty.

- 1 Press **Ink**.
- 2 Press ▲ or ▼ to choose **Cleaning**. Press **OK**.
- 3 Press ▲ or ▼ to choose **Black, Color** or **All**. Press **OK**.
The machine cleans the print head. When cleaning is finished, the machine will go back to standby mode automatically.

Note

If you clean the print head at least five times and the print has not improved, call Brother Customer Service (See *Brother numbers* on page i).

Checking the print quality

If faded or streaked colors and text appear on your output, some of the nozzles may be clogged. You can check this by printing the Print Quality Check Sheet and looking at the nozzle check pattern.

- 1 Press **Ink**.
- 2 Press ▲ or ▼ to choose **Test Print**. Press **OK**.
- 3 Press ▲ or ▼ to choose **Print Quality**. Press **OK**.
- 4 Press **Color Start**.
The machine begins printing the Print Quality Check Sheet.
- 5 Check the quality of the four color blocks on the sheet.
- 6 The LCD asks you if the print quality is OK.
Do one of the following:
 - If all lines are clear and visible, press **1 (Yes)** to finish the Print Quality check.
 - If you can see missing short lines as shown below, press **2** to choose **No**.

OK

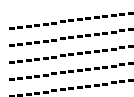

Poor

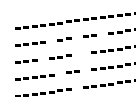

- 7 The LCD asks you if the print quality is OK for black and three colors. Press **1 (Yes)** or **2 (No)**.
- 8 The LCD asks you if you want to start cleaning. Press **1 (Yes)**.
The machine starts cleaning the print head.

- 9 After cleaning is finished, press **Color Start**.
The machine starts printing the Print Quality Check Sheet again and then return to step 5.
- 10 Press **Stop/Exit**.
If you repeat this procedure at least five times and the print quality is still poor, replace the ink cartridge for the clogged color.
After replacing the ink cartridge, check the print quality. If the problem still exists, repeat the cleaning and test print procedures at least five times for the new ink cartridge. If ink is still missing, call Brother Customer Service (see *Brother numbers* on page i).

! CAUTION

DO NOT touch the print head. Touching the print head may cause permanent damage and may void the print head's warranty.

Note



When a print head nozzle is clogged the printed sample looks like this.



After the print head nozzle is cleaned, the horizontal lines are gone.

Checking the printing alignment

You may need to adjust the printing alignment after transporting the machine if your printed text becomes blurred or images become faded.

- 1 Press **Ink**.
- 2 Press **▲** or **▼** to choose `Test Print`. Press **OK**.
- 3 Press **▲** or **▼** to choose `Alignment`. Press **OK**.
- 4 Press **Black Start** or **Color Start**.
The machine starts printing the Alignment Check Sheet.
- 5 Check the 600 dpi and 1200 dpi test prints to see if number 5 most closely matches number 0.
- 6 Do one of the following:
 - If the number 5 sample of both the 600 dpi and 1200 dpi are the best matches, press **1** (`Yes`) to finish the Alignment Check.
 - If another test print number is a better match for either 600 dpi or 1200 dpi, press **2** (`No`) to choose it.
- 7 For 600 dpi, press the number of the test print that most closely matches the number 0 sample (1-8).
- 8 For 1200 dpi, press the number of the test print that most closely matches the number 0 sample (1-8).
- 9 Press **Stop/Exit**.

Checking the ink volume

Although an ink volume icon appears on the LCD, you can use the **Ink** key to see a large graph showing the ink that is left in each cartridge.

- 1 Press **Ink**.
- 2 Press **▲** or **▼** to choose **Ink Volume**. Press **OK**. The LCD shows the ink volume.
- 3 Press **Stop/Exit**.



Note

You can check the ink volume from your computer. (See *Printing for Windows®* or *Printing and Faxing for Macintosh®* in the Software User's Guide on the CD-ROM.)

Uninstalling and installing the handset and handset cradle (MFC-665CW only)

If you do not use the handset you can remove the handset and handset cradle.

Uninstalling the handset and handset cradle

- 1 Unplug the curled handset cord from the machine.

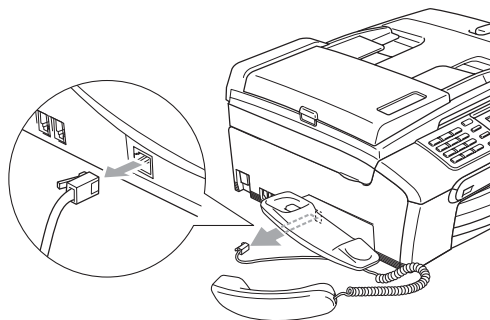

- 2 Pull the tab (1) back and hold it in position as you push the cradle (2) to the back of the machine.

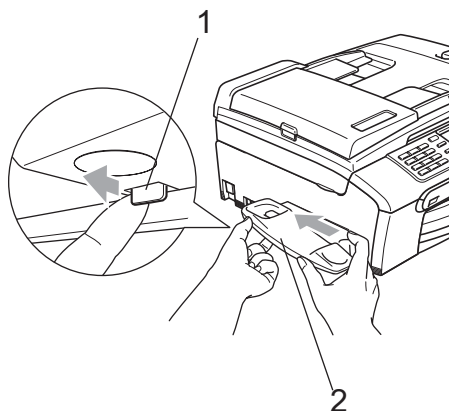

- 3 Attach the side cover.

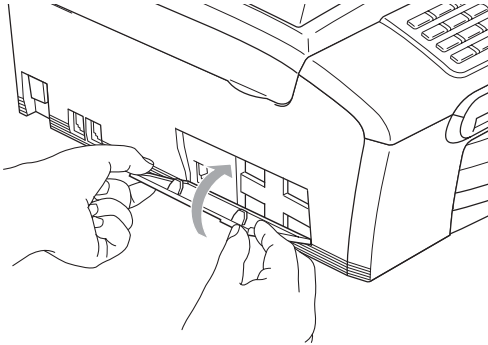

Installing the handset and handset cradle

- 1 Remove the side cover.

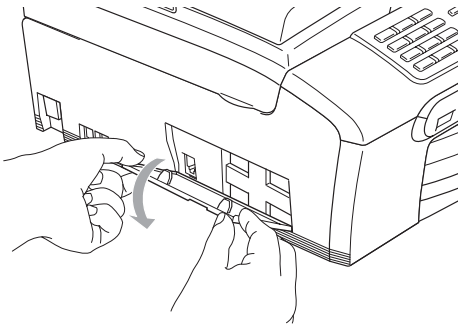

Note

If you cannot open the cover with your hand, use a coin to open it.

- 2 Align the recessed arrows on the cradle with those on the machine, and then slide the cradle toward the front of the machine until it clicks into place.

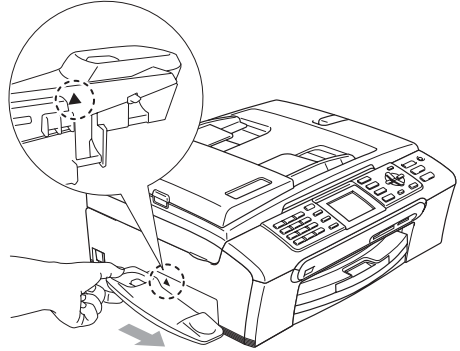

- 3 Connect the curled handset cord to the machine.

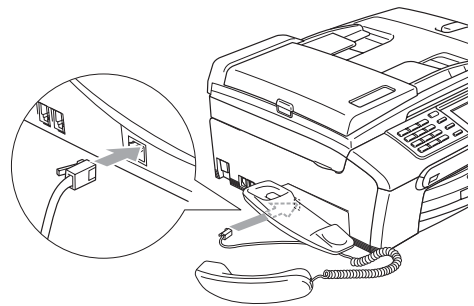

Uninstalling and installing the cradle and the bracket (MFC-845CW only)

Uninstalling the cradle and the bracket

If you want to use the cordless handset separately from the machine, you can remove the cradle and the bracket.

- 1 Unplug the AC adapter from AC power outlet.
- 2 Remove the AC adapter cord from the guide on the side of the machine.

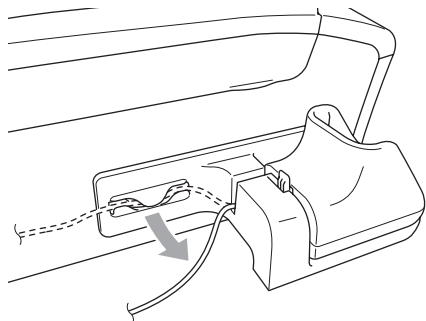

- 3 Press the tab (1) and lift the cradle (2).

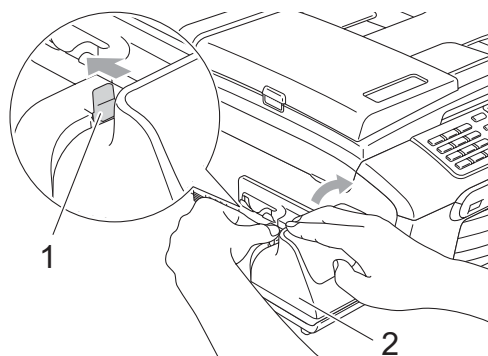

- 4 Pull the tab (1) back and hold it in position as you push the bracket (2) to the back of the machine.

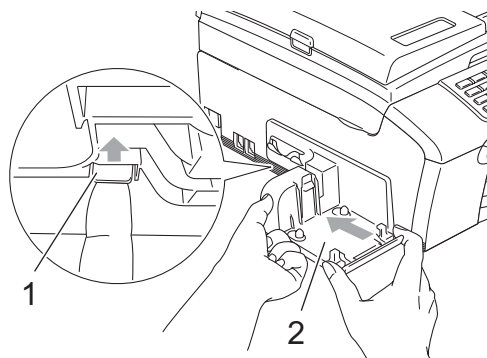

- 5 Attach the side cover.

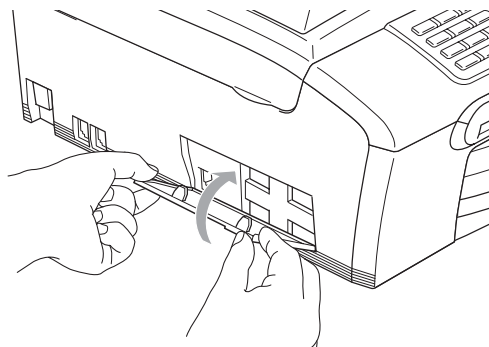

Installing the cradle and the bracket

- 1 Remove the side cover.

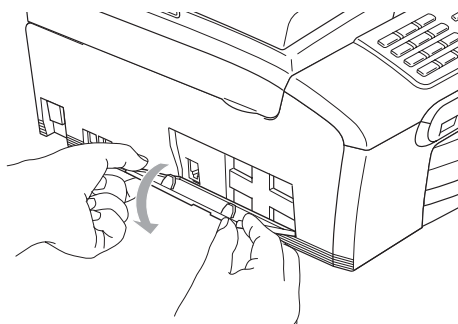

Note

If you cannot open the cover with your hand, use a coin to open it.

- 2** Align the recessed arrows on the bracket with those on the machine, and then slide the bracket toward the front of the machine until it clicks into place.

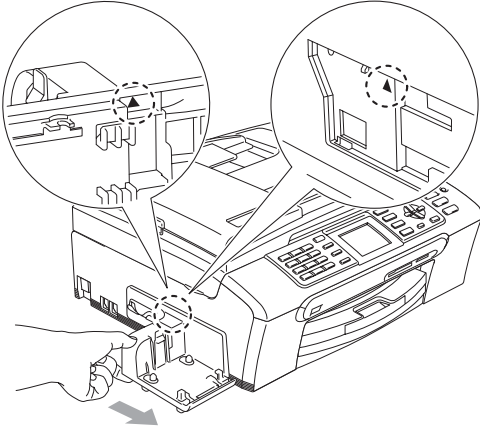

- 3** Make sure you plug the connector into the jack (1) and route the cable through the hook (2) as shown below.

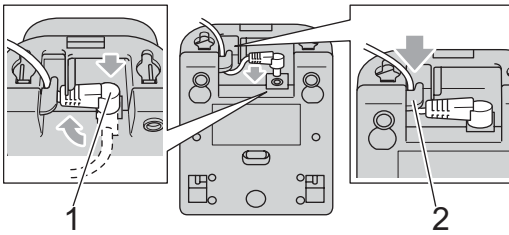

- 4** Press the tab (1) and place the front of the cradle in position.

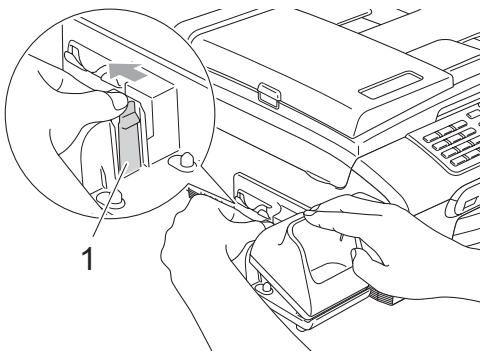

- 5** Push the cradle down.

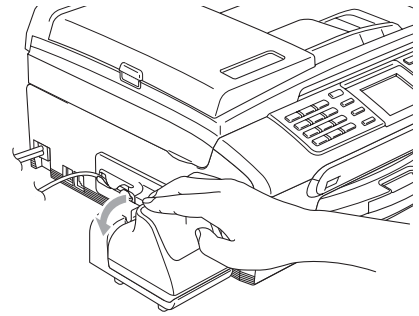

- 6** Route the AC power cord through the guide on the side of the machine.

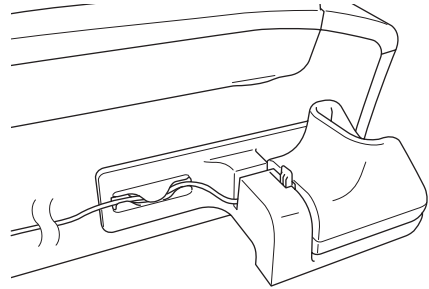

- 7** Plug the AC adapter into the AC power outlet.

Machine Information

Checking the serial number

You can see the machine's serial number on the LCD.

- 1 Press **Menu**.
- 2 Press **▲** or **▼** to choose `Machine Info..`
Press **OK**.
- 3 Press **▲** or **▼** to choose `Serial No..`
Press **OK**.
- 4 Press **Stop/Exit**.

Packing and shipping the machine

When you transport the machine, use the packing materials that came with your machine. If you do not pack the machine properly, you could void your warranty.

! CAUTION

It is important to allow the machine to 'park' the print head after a print job. Listen carefully to the machine before unplugging it to make sure that all mechanical noise has stopped. Not allowing the machine to finish this parking process may lead to print problems and possible damage to the print head.

- 1 Open the ink cartridge cover.
- 2 Pull the lock release levers down and take out all the ink cartridges. (See *Replacing the ink cartridges* on page 143.)
- 3 Install the yellow protective part, lift each lock release lever and push it until it clicks and then close the ink cartridge cover.

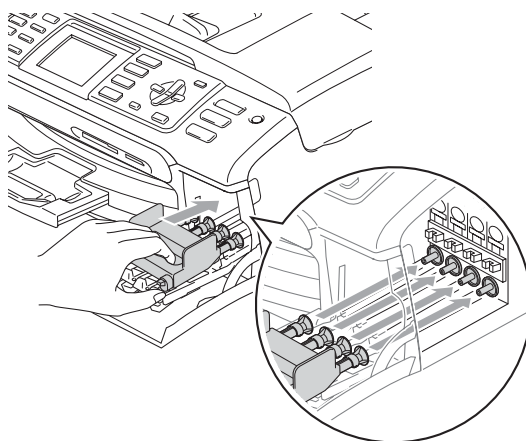

! CAUTION

If you are not able to find the yellow protective part, DO NOT remove the ink cartridges before shipping. It is essential that the machine be shipped with either the yellow protective part or the ink cartridges in position. Shipping without them will cause damage to your machine and may void your warranty.

- 4 Unplug the machine from the telephone wall jack and take the telephone line cord out of the machine.
- 5 Unplug the machine from the AC power outlet.
- 6 (MFC-845CW) Unplug the AC adapter from the AC power outlet and remove the AC adapter cord from the guide on the side of the machine.

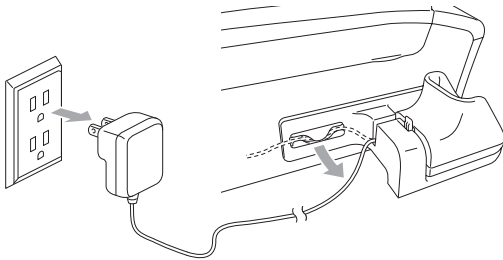

- 7 Using both hands, use the plastic tabs on both sides of the machine to lift the scanner cover until it locks securely into the open position. Then unplug the interface cable from the machine, if it is connected.

- 8 Lift the scanner cover (1) to release the lock. Gently push the scanner cover support down (2) and close the scanner cover (3).

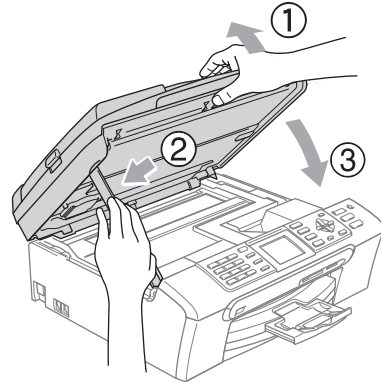

- 9 If your machine has a handset, remove it and the handset curled cord.
- 10 (MFC-845CW) Rotate the machine's antenna to the down position.

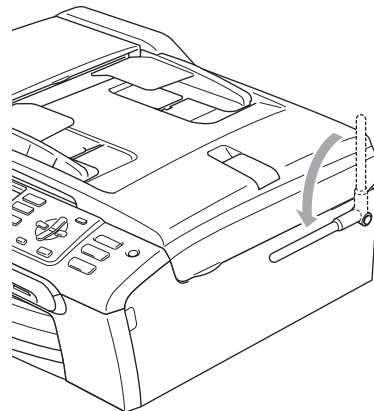

- 11 Wrap the machine in the bag and put it in the original carton with the original packing material.

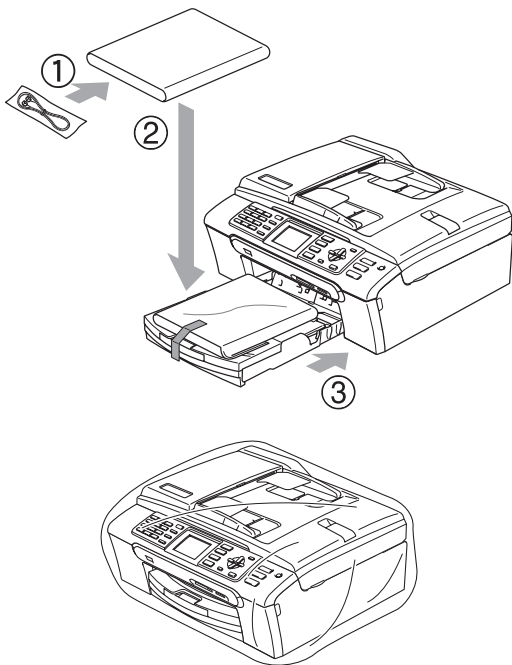

MFC-440CN

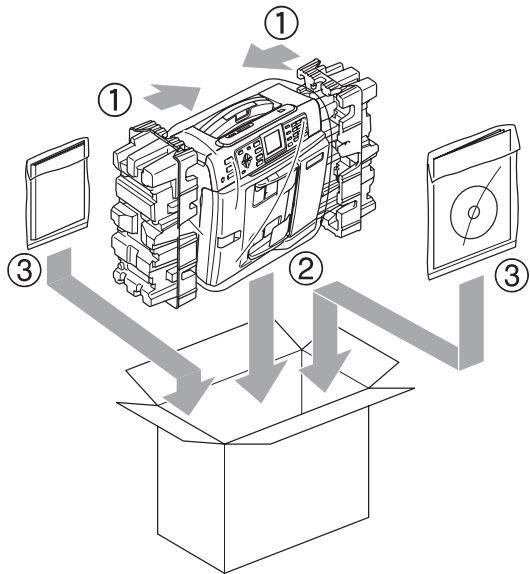

- 12 Pack the printed materials in the original carton as shown below. Do not pack the used ink cartridges in the carton.



Note

If you are returning your machine to Brother as part of the Exchange Service, pack *only* the machine. Keep all separate parts and printed materials to use with your 'Exchange' machine.

MFC-665CW and MFC-845CW

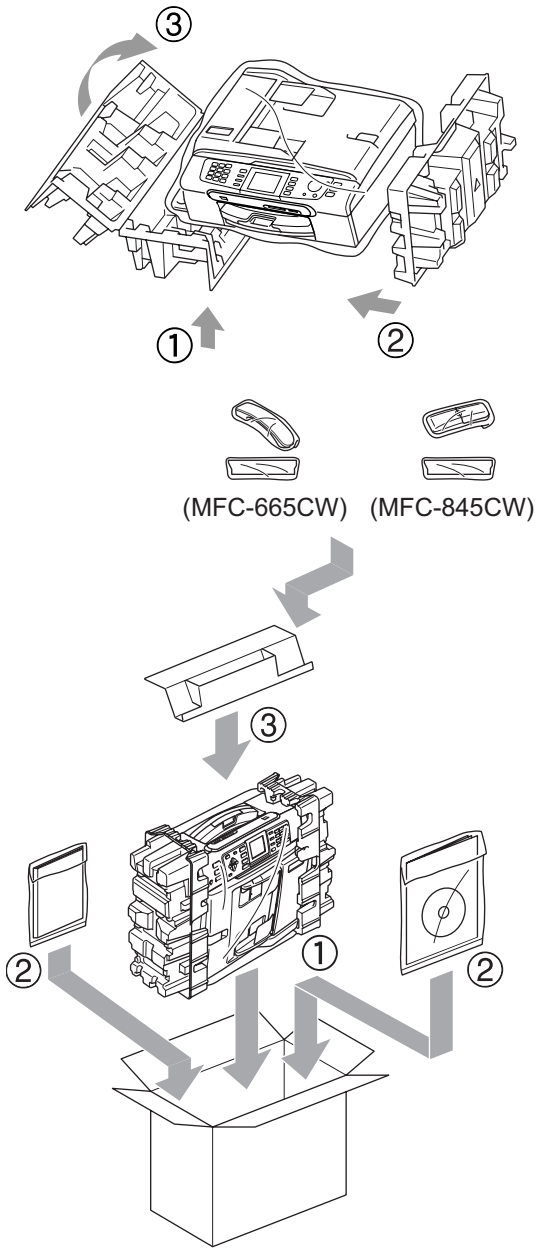

13 Close the carton and tape it shut.

On-screen programming

Your machine is designed to be easy to use with LCD on-screen programming using the menu keys. User-friendly programming helps you take full advantage of all the menu selections your machine has to offer.

Since your programming is done on the LCD, we have created step-by-step on-screen instructions to help you program your machine. All you need to do is follow the instructions as they guide you through the menu selections and programming options.

Memory storage













Even if there is a power failure, you will not lose the settings you have chosen using the Menu key because they are stored permanently. Also, you will not lose your settings in the PhotoCapture, Fax and Copy mode key menus if you have chosen *Set New Default*. You may have to reset the date and time.



Note

During a power failure the MFC-665CW and MFC-845CW will retain messages that are in the memory for approximately 24 hours.

Menu keys

	Access the main menu.
Fax  Scan  Copy  Photo Capture 	Access the mode and its menu of temporary settings.
 	Scroll through the current menu level.
 	Go back to the previous menu level. Go to the next menu level.
OK 	<ul style="list-style-type: none"> ■ Go to the next menu level. ■ Accept an option.
Clear / Back 	<ul style="list-style-type: none"> ■ Cancel the current operation. ■ Go back to the previous menu level.
Stop / Exit 	<ul style="list-style-type: none"> ■ Stop the current operation.

Menu table

The menu table will help you understand the menu selections and options that are found in the machine's programs. The factory settings are shown in Bold with an asterisk.

Menu ()

Level1	Level2	Level3	Options	Descriptions	Page	
General Setup	Mode Timer	—	Off 0 Sec 30 Secs 1 Min 2 Mins* 5 Mins	Sets the time to return to Fax mode.	26	
	Paper Type	—	Plain Paper* Inkjet Paper Brother Photo Other Photo Transparency	Sets the type of paper in the paper tray.	26	
	Paper Size	—	Letter* Legal A4 A5 4"x6"	Sets the size of the paper in the paper tray.	27	
	Volume	Ring		Off Low Med* High	Adjusts the ring volume.	27
		Beeper		Off Low* Med High	Adjusts the volume level of the beeper.	27
		Speaker		Off Low Med* High	Adjusts the speaker volume.	28
		Handset (MFC-665CW only)		Low* High	Adjusts the handset volume.	28



The factory settings are shown in Bold with an asterisk.

Level1	Level2	Level3	Options	Descriptions	Page
General Setup (Continued)	Volume (Continued)	Volume Amplify (MFC-665CW only)	On (Permanent/ Temporary) Off*	For the hearing-impaired, you can set the volume to the Volume Amplify:On setting on a permanent or temporary basis.	30
		Auto Daylight	— Off*	Changes for Daylight Savings Time automatically.	30
		On/Off Setting	— Fax Receive:On Fax Receive:Off*	Customizes the On/Off key to receive faxes even in off mode.	24
	LCD Settings	LCD Contrast	Light Med* Dark	Adjusts the contrast of the LCD.	31
			Backlight	Light* Med Dark	You can adjust the brightness of the LCD backlight.
		Dim Timer	Off 10 Secs 20 Secs 30 Secs*	You can set how long the LCD backlight stays on after the last key press.	31
		Off Timer	Off* 1 Min 2 Mins 3 Mins 5 Mins 10 Mins 30 Mins	You can set how long the LCD stays on for after the last key press.	31
		Wallpaper	—	You can choose the wallpaper of the LCD.	32
		Echo Control	— level1 level2 level3 level4	Adjusts the Echo Control level.	See <i>Digital Cordless Handset User's Guide</i>
	Fax	Setup Receive	Ring Delay (MFC-440CN only) 0 1 2 3 4*	Sets the number of rings before the machine answers in Fax Only or Fax/Tel mode.	49



The factory settings are shown in Bold with an asterisk.

Level1	Level2	Level3	Options	Descriptions	Page
Fax (Continued)	Setup Receive (Continued)	Ring Delay (MFC-665CW and MFC-845CW only)	Ring Delay	Sets the number of rings before the machine answers in Fax Only or Fax/Tel mode.	49
			0 1 2 3 4*		
			Toll Saver	Cost saving feature: the machine rings 2 times if there are messages and 4 times if there are no messages, so you can hang up and not pay for the call.	74
			On Off*		
		F/T Ring Time	20 Sec* 30 Sec 40 Sec 70 Sec	Sets the pseudo/double- ring time in Fax/Tel mode.	49
		Easy Receive	On* Off Semi (MFC-665CW and MFC-845CW only)	Receives fax messages without pressing the Black Start or Color Start key.	50
		Remote Codes	On* (* 51, #51) Off	Allows you to answer all calls at an extension or external phone and use codes to turn the machine on or off. You can personalize these codes.	62
		Auto Reduction	On* Off	Reduces the size of incoming faxes.	51
		Set Quick-Dial	Speed-Dial	—	Stores Speed-Dial numbers, so you can dial by pressing only a few keys (and Start).
	Setup Groups	—	Sets up a Group number for Broadcasting.	68	

 The factory settings are shown in Bold with an asterisk.

Level1	Level2	Level3	Options	Descriptions	Page
Fax (Continued)	Report Setting	Transmission	On On+Image Off* Off+Image	Initial setup for Transmission Verification Report and Fax Journal Report.	87
		Journal Period	Off Every 50 Faxes* Every 6 Hours Every 12 Hours Every 24 Hours Every 2 Days Every 7 Days		87
	Advanced Fax Operation	Fwd/Page/Store	Off* Fax Forward Paging Fax Storage Fax Preview (MFC-665CW and MFC-845CW only) PC Fax Receive	Sets the machine to forward fax messages, to call your pager, to store incoming faxes in the memory (so you can retrieve them while you are away from your machine), to preview faxes or to send faxes to your PC.	76
		Remote Access	Access Code: ---*	Set your own code for Remote Retrieval.	82
		Print Fax (Backup Print)	—	Prints incoming faxes stored in the memory.	51
	Remaining Jobs	—	—	Check which jobs are in the memory and lets you cancel chosen jobs.	43
	Setup Msg Ctr (MFC-665CW and MFC-845CW only)	OGM	Msg Ctr OGM F/T OGM	Play/Record or erase the outgoing message.	71
		ICM Max.Time	30 Sec* 60 Sec 120 Sec 180 Sec	Choose the maximum length of incoming messages.	74
		ICM Rec.Monitr	On* Off	Allows you to turn the speaker volume for voice messages as they come in On or Off.	75
	 The factory settings are shown in Bold with an asterisk.				

Level1	Level2	Level3	Options	Descriptions	Page
Fax (Continued)	Miscellaneous	TX Lock (MFC-440CN only)	—	Prohibits most operations other than receiving faxes.	33
		Mem Security (MFC-665CW and MFC-845CW only)	—	Prohibits most functions except receiving faxes into memory.	34
		Compatibility	Normal* Basic	Adjusts the transmissions that are having problems.	143
		Distinctive	Off* Set (On)	Uses the Telephone company's Distinctive Ring subscriber service to register the ring pattern with the machine.	54
		Caller ID	Display# Print Report Area Code (USA only)	View or print a list of the last 30 Caller IDs stored in the memory. Set up your 3-digit area code only if you do not dial it within your own area code.	56
LAN (MFC-440CN only)	TCP/IP	BOOT Method	Auto* Static RARP BOOTP DHCP	Chooses the BOOT method that best suits your needs.	See <i>Network User's Guide on the CD-ROM</i>
		IP Address	[000-255]. [000-255]. [000-255]. [000-255]	Enter the IP address.	
		Subnet Mask	[000-255]. [000-255]. [000-255]. [000-255]	Enter the Subnet mask.	
		Gateway	[000-255]. [000-255]. [000-255]. [000-255]	Enter the Gateway address.	
		Node Name	BRN_XXXXXX	Enter the Node name.	
		WINS Config	Auto* Static	Chooses the WINS configuration mode.	





The factory settings are shown in Bold with an asterisk.

Level1	Level2	Level3	Options	Descriptions	Page
LAN (MFC-440CN only) (Continued)	TCP/IP (Continued)	WINS Server	(Primary) 000.000.000.000 (Secondary) 000.000.000.000	Specifies the IP address of the primary or secondary server.	See <i>Network User's Guide on the CD-ROM</i>
		DNS Server	(Primary) 000.000.000.000 (Secondary) 000.000.000.000	Specifies the IP address of the primary or secondary server.	
		APIPA	On* Off	Automatically allocates the IP address from the link-local address range.	
	Setup Misc.	Ethernet	Auto* 100B-FD 100B-HD 10B-FD 10B-HD	Chooses the Ethernet link mode.	
	Factory Reset	—	Yes No	Restores all network settings to the factory default.	
	LAN (MFC-665CW and MFC-845CW only)	TCP/IP (Wired)	BOOT Method	Auto* Static RARP BOOTP DHCP	
IP Address			[000-255]. [000-255]. [000-255]. [000-255]	Enter the IP address.	
Subnet Mask			[000-255]. [000-255]. [000-255]. [000-255]	Enter the Subnet mask.	
Gateway			[000-255]. [000-255]. [000-255]. [000-255]	Enter the Gateway address.	
Node Name			BRN_XXXXXX	Enter the Node name.	
WINS Config			Auto* Static	Chooses the WINS configuration mode.	



The factory settings are shown in Bold with an asterisk.

Level1	Level2	Level3	Options	Descriptions	Page			
LAN (MFC-665CW and MFC-845CW only) (Continued)	TCP/IP (Wired) (Continued)	WINS Server	(Primary) 000.000.000.000 (Secondary) 000.000.000.000	Specifies the IP address of the primary or secondary server.	See <i>Network User's Guide on the CD-ROM</i>			
		DNS Server	(Primary) 000.000.000.000 (Secondary) 000.000.000.000	Specifies the IP address of the primary or secondary server.				
		APIPA	On* Off	Automatically allocates the IP address from the link-local address range.				
	TCP/IP (WLAN)	BOOT Method	Auto* Static RARP BOOTP DHCP	Chooses the BOOT method that best suits your needs.				
		IP Address	[000-255]. [000-255]. [000-255]. [000-255]	Enter the IP address.				
		Subnet Mask	[000-255]. [000-255]. [000-255]. [000-255]	Enter the Subnet mask.				
		Gateway	[000-255]. [000-255]. [000-255]. [000-255]	Enter the Gateway address.				
		Node Name	BRW_XXXXXX	Enter the Node name.				
		WINS Config	Auto* Static	Chooses the WINS configuration mode.				
		WINS Server	(Primary) 000.000.000.000 (Secondary) 000.000.000.000	Specifies the IP address of the primary or secondary server.				
		DNS Server	(Primary) 000.000.000.000 (Secondary) 000.000.000.000	Specifies the IP address of the primary or secondary server.				
		APIPA	On* Off	Automatically allocates the IP address from the link-local address range.				
		 The factory settings are shown in Bold with an asterisk.						

Level1	Level2	Level3	Options	Descriptions	Page
LAN (MFC-665CW and MFC-845CW only) (Continued)	Setup WLAN	Setup Wizard	—	You can configure your print server.	See <i>Network User's Guide on the CD-ROM</i>
		SecureEasySetup	—	You can configure the wireless network easily.	
	WLAN Status	Status	—	You can see the current wireless network status.	
		Signal	—	You can see the current wireless network signal strength.	
		SSID	—	You can see the current SSID.	
		Comm. Mode	—	You can see the current Communication Mode.	
	Setup Misc.	Wired LAN	Auto* 100B-FD 100B-HD 10B-FD 10B-HD	Chooses the Ethernet link mode.	
	Network I/F	—	Wired LAN* WLAN	You can choose the network connection type.	
Factory Reset	—	Yes No	Restores all wired and wireless network settings to the factory default.		
Print Reports	Transmission	—	—	Prints these lists and reports.	88
	Help List	—	—		
	Quick-Dial	—	—		
	Fax Journal	—	—		
	User Settings	—	—		
	Network Config	—	—		
Machine Info.	Serial No.	—	—	Lets you check the serial number of your machine.	154
Initial Setup	Receive Mode	—	Fax Only* Fax/Tel External TAD (MFC-440CN only) Manual	Choose the receive mode that best suits your needs.	46
	Date/Time	—	—	Puts the date and time on the LCD and in headings of faxes you send.	See <i>Quick Setup Guide</i>
 The factory settings are shown in Bold with an asterisk.					

Level1	Level2	Level3	Options	Descriptions	Page
Initial Setup (Continued)	Station ID	—	Fax: Name:	Set your name and fax number to appear on each page you fax.	See <i>Quick Setup Guide</i>
	Tone/Pulse (Canada only)	—	Tone* Pulse	Choose the dialing mode.	
	Dial Tone	—	Detection No Detection*	You can shorten the dial tone detect pause.	142
	Register Handset (MFC-845CW only)	—	—	Sets the machine to register the cordless handset.	See <i>Digital Cordless Handset User's Guide</i>
	Local Language (MFC-440CN and MFC-665CW only) (Canada only)	—	English* French	Allows you to change the LCD language for your country.	See <i>Quick Setup Guide</i>
 The factory settings are shown in Bold with an asterisk.					

Fax ()









Level1	Level2	Level3	Options	Descriptions	Page
Fax Resolution	—	—	Standard* Fine S.Fine Photo	Sets the resolution for outgoing faxes.	41
Contrast	—	—	Auto* Light Dark	Changes the lightness or darkness of faxes you send.	41
Speed-Dial	—	—	Alphabetical Order Numerical Order	You can dial by pressing only a few keys (and Start).	63
 The factory settings are shown in Bold with an asterisk.					



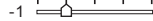
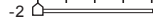

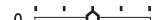

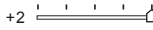
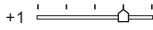
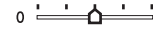

Level1	Level2	Level3	Options	Descriptions	Page
Outgoing Call	Make a Phone Call (MFC-665CW and MFC-845CW only) Send a fax Add to Speed-Dial Delete	—	—	You can choose a number from the Outgoing Call history and then make a phone call to it, send a fax to it, add it to Speed-Dial, or delete it.	64
Caller ID hist.	Make a Phone Call (MFC-665CW and MFC-845CW only) Send a fax Add to Speed-Dial Delete	—	—	You can choose a number from the Caller ID history and then make a phone call to it, send a fax to it, add it to Speed-Dial, or delete it.	65
Broadcasting	Add Number Complete	—	—	You can send the same fax message to more than one fax number.	40
Delayed Fax	—	—	On Off*	Sets the time of day in 24-hour format that the delayed faxes will be sent.	43
Batch TX	—	—	On Off*	Combines delayed faxes to the same fax number at the same time of day into one transmission.	43
Real Time TX	—	—	On Off*	You can send a fax without using the memory.	42
Polled TX	—	—	On Off*	Sets up your machine with an document to be retrieved by another fax machine.	90
Polling RX	—	—	On Off*	Sets up your machine to poll another fax machine.	89
Overseas Mode	—	—	On Off*	If you are having difficulty sending faxes overseas, set this to On.	43
Scan Size	—	—	A4 Letter*	Adjust the scan area of the scanner glass to the size of the document.	39
Set New Default	—	—	Yes No	You can save your fax settings.	44
Factory Reset	—	—	Yes No	You can restore all the settings to factory settings.	44
 The factory settings are shown in Bold with an asterisk.					

Scan ()

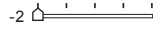
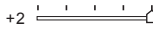
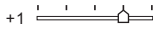
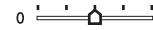
Level1	Option1	Option2	Option3	Descriptions	Page
Scan to E-mail	—	—	—	You can scan a black & white or a color document into your E-mail application.	See <i>Software User's Guide on the CD-ROM</i>
Scan to Image	—	—	—	You can scan a color picture into your graphics application.	
Scan to OCR	—	—	—	You can have your text document converted to an editable text file.	
Scan to File	—	—	—	You can scan a black & white or a color document into your computer.	
Scan to Card (when a card is inserted)	150 dpi Color* 300 dpi Color 600 dpi Color 200x100 dpi B/W 200 dpi B/W	PDF*/JPEG PDF*/JPEG PDF*/JPEG TIFF*/PDF TIFF*/PDF	(File Name) XXXXXXXX	You can choose the scan resolution, file format and enter a file name for your document.	109
 The factory settings are shown in Bold with an asterisk.					

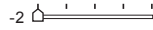
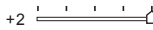
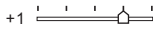
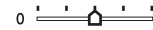
Copy ()

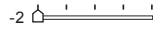

Level1	Level2	Level3	Options	Descriptions	Page
Quality	—	—	Fast Normal* Best	Choose the Copy resolution for your type of document.	93
Enlarge/Reduce	—	—	50% 69% A4→A5 78% LGL→LTR 83% LGL→A4 93% A4→LTR 97% LTR→A4 100%* 104% EXE→LTR 142% A5→A4 186% 4"x6"→LTR 198% 4"x6"→A4 200% Custom(25-400%)	You can choose the enlargement or reduction ratio for your type of document.	94
Paper Type	—	—	Plain Paper* Inkjet Paper Brother Photo Other Photo Transparency	Choose the paper type that matches the paper in the tray.	97
Paper Size	—	—	Letter* Legal A4 A5 4"x6"	Choose the paper size that matches the paper in the tray.	97
Brightness	—	—	Light +2  +1  0  -1  -2  Dark	Adjusts the brightness of copies.	96
Contrast	—	—	+2  +1  0  -1  -2 	Adjusts the contrast of copies.	96
 The factory settings are shown in Bold with an asterisk.					







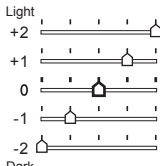



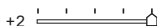
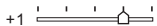
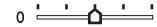

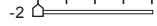

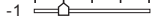
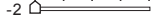

Level1	Level2	Level3	Options	Descriptions	Page
Color Adjust	Red	—	+2  +1  0  -1  -2 	Adjusts the amount of Red in copies.	96
	Green	—	+2  +1  0  -1  -2 	Adjusts the amount of Green in copies.	
	Blue	—	+2  +1  0  -1  -2 	Adjusts the amount of Blue in copies.	
Stack/Sort	—	—	Stack* Sort	You can choose to stack or sort multiple copies.	95
Page Layout	—	—	Off (1 in 1)* 2 in 1 (P) 2 in 1 (L) 4 in 1 (P) 4 in 1 (L) Poster (3 x 3)	You can make N in 1 or Poster copies.	94
Set New Default	—	—	Yes No	You can save your copy settings.	97
Factory Reset	—	—	Yes No	You can restore all the settings to factory settings.	97
 The factory settings are shown in Bold with an asterisk.					

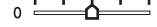
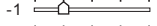
PhotoCapture ()

Level1	Level2	Level3	Options	Descriptions	Page
View Photo(s)	—	—	See the print settings table below.	You can preview your photos on the LCD.	102
Print Index	—	—	6 Images/Line Fast 5 Images/Line Photo	You can print a thumbnail page.	103
Print All Photos	—	—	See the print settings table below.	You can print all photos in your media card.	103
Print Photos	—	—	See the print settings table below.	You can print an individual image.	104

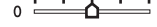
Print Settings

Option1	Option2	Option3	Option4	Descriptions	Page
Print Quality	Normal Photo*	—	—	Choose the print quality.	106
Paper Type	Plain Paper Inkjet Paper Brother Photo Other Photo*	—	—	Choose the paper type.	106
Paper Size	Letter 4"x 6"* 5"x 7" A4	(When A4 or Letter is chosen) 4"x 3" 5"x 3.5" 6"x 4" 7"x 5" 8"x 6" Max. Size*	—	Choose the paper and print size.	106
Brightness	Light +2 +1 0 -1 -2 Dark 	—	—	Adjusts the brightness.	106
 The factory settings are shown in Bold with an asterisk.					

Option1	Option2	Option3	Option4	Descriptions	Page
Contrast	+2  +1  0  -1  -2 	—	—	Adjusts the contrast.	106
True2Life	On Off*	White Balance	+2  +1  0  -1  -2 	Adjusts the hue of the white areas.	107
		Sharpness	+2  +1  0  -1  -2 	Enhances the detail of the image.	
		Color Density	+2  +1  0  -1  -2 	Adjusts the total amount of color in the image.	
Cropping	On* Off	—	—	Crops the image around the margin to fit the paper size or print size. Turn this feature off if you want to print whole images or prevent unwanted cropping.	108
Borderless	On* Off	—	—	Expands the printable area to fit the edges of the paper.	108
Set New Default	Yes No	—	—	You can save your print settings.	108
Factory Reset	Yes No	—	—	You can restore all the settings to factory settings.	108
 The factory settings are shown in Bold with an asterisk.					

Entering Text

When you are setting certain menu selections, such as the Station ID, you may need to enter text into the machine. Most dial pad keys have three or four letters printed on keys. The keys for **0**, **#** and ***** do not have printed letters because they are used for special characters.

By pressing the proper dial pad key repeatedly, you can access the character you want.

Press Key	one time	two times	three times	four times
2	A	B	C	2
3	D	E	F	3
4	G	H	I	4
5	J	K	L	5
6	M	N	O	6
7	P	Q	R	S
8	T	U	V	8
9	W	X	Y	Z

Putting spaces

To enter a space in a fax number, press ► once between numbers. To enter a space in a name, press ► twice between characters.

Making corrections

If you entered an incorrect letter and want to change it, press ◀ to move the cursor under the incorrect character. Then press **Clear/Back**. Re-enter the correct character. You can also back up and insert letters.

Repeating letters

If you need to enter a letter that is on the same key as the letter before, press ► to move the cursor to the right before you press the key again.

Special characters and symbols

Press *****, **#** or **0**, repeatedly until you see the special character or symbol you want.

Press ***** for (space) ! " # \$ % & ' () *
+ , - . / €

Press **#** for ; : < = > ? @ [] ^ _

Press **0** for É À È Ê Î Ç Ë Ö 0

D

Specifications

General

Memory Capacity	32 MB
ADF (automatic document feeder)	Up to 10 pages Temperature: 68° F - 86° F (20° C - 30° C) Humidity: 50% - 70% Paper: [20 lb (80 g/m ²)] A4 or Letter size
Paper Tray	100 Sheets [20 lb (80 g/m ²)]
Printer Type	Ink Jet
Print Method	Black: Piezo with 94 × 1 nozzles Color: Piezo with 94 × 3 nozzles
LCD (liquid crystal display)	(MFC-440CN) 2.0 in. (50.8 mm) Color LCD (MFC-665CW and MFC-845CW) 2.5 in. (63.5 mm) Color LCD
Power Source	AC 100 to 120 V 50/60 Hz
Power Consumption	(MFC-440CN) Off Mode: Average 4 W Standby: Average 6 W Operating: Average 31 W (MFC-665CW) Off Mode: Average 6 W Standby: Average 8 W Operating: Average 34 W (MFC-845CW) Off Mode: Average 6.5 W Standby: Average 9 W Operating: Average 34 W

Dimensions

(MFC-440CN)

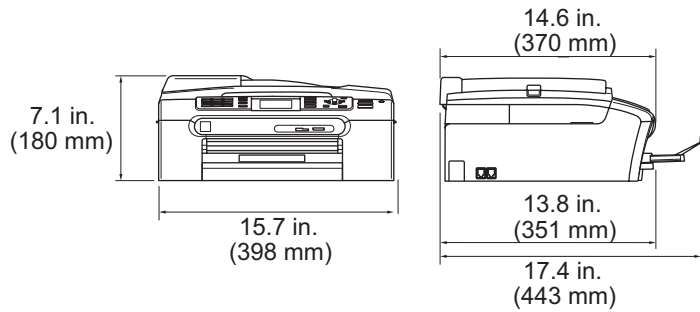

(MFC-665CW)

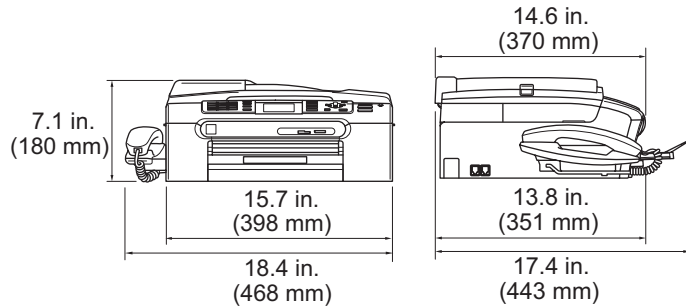

(MFC-845CW)

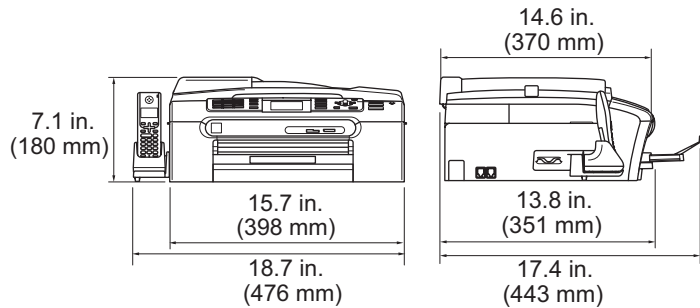

Weight	MFC-440CN	17.9 lb (8.1 kg)
	MFC-665CW	18.5 lb (8.4 kg)
	MFC-845CW	19.2 lb (8.7 kg)
Noise	Operating:	50 dB or less ¹
Temperature	Operating:	50° F to 95° F (10 to 35° C)
	Best Print Quality:	68° F to 91° F (20 to 33° C)
Humidity	Operating:	20 to 80% (without condensation)
	Best Print Quality:	20 to 80% (without condensation)

¹ This depends on printing conditions.

Print media

Paper Input

Paper Tray

- Paper type:

Plain paper, inkjet paper (coated paper), glossy paper², transparencies^{1 2} and envelopes

- Paper size:

Letter, Legal, Executive, A4, A5, A6, JIS B5, envelopes (commercial No.10, DL, C5, Monarch, JE4), Photo 2L 5"×7", Index card and Post card³.

Width: 3.5 in. (89 mm) - 8.5 in. (216 mm)

Height: 5.0 in. (127 mm) - 14.0 in. (356 mm)

For more details, see *Paper weight, thickness and capacity* on page 16.

- Maximum paper tray capacity: Approx. 100 sheets of 20 lb (80 g/m²) plain paper

Photo Bypass Tray (USA)

Photo Paper Tray (Canada)

- Paper type:

Plain paper, inkjet paper (coated paper) and glossy paper²

- Paper size:

Photo 4×6 in. and Photo L 3.5×5 in.

Width: 3.5 in. (89 mm) - 4.0 in. (101.6 mm)

Height: 5.0 in. (127 mm) - 6.0 in. (152.4 mm)

- Maximum paper tray capacity: Approx. 20 sheets

Paper Output

Up to 50 sheets of 20 lb (80 g/m²) plain paper (face up print delivery to the output paper tray)²

¹ Use only transparencies recommended for inkjet printing.

² For glossy paper or transparencies, we recommend removing printed pages from the output paper tray immediately after they exit the machine to avoid smudging.

³ See *Paper type and size for each operation* on page 15.

Fax

Compatibility	ITU-T Group 3
Coding System	MH/MR/MMR/JPEG
Modem Speed	Automatic Fallback 14400 bps
Document Size	ADF Width: 5.8 in. to 8.5 in. (148 mm to 215.9 mm) ADF Height: 5.8 in. to 14 in. (148 mm to 355.6 mm) Scanner Glass Width: Max. 8.5 in. (215.9 mm) Scanner Glass Height: Max. 11.7 in. (297 mm)
Scanning Width	8.2 in. (208 mm)
Printing Width	8.03 in. (204 mm)
Gray Scale	256 levels
Polling Types	Standard, Sequential: (Black only)
Contrast Control	Automatic/Light/Dark (manual setting)
Resolution	■ Horizontal 203 dot/in. (8 dot/mm) ■ Vertical Standard 98 line/in. (3.85 line/mm) (Monochrome) 196 line/in. (7.7 line/mm) (Color) Fine 196 line/in. (7.7 line/mm) (Monochrome/Color) Photo 196 line/in. (7.7 line/mm) (Monochrome) Superfine 392 line/in. (15.4 line/mm) (Monochrome)
Speed-Dial	MFC-440CN, 80 stations × 2 numbers MFC-665CW MFC-845CW 100 stations × 2 numbers
Broadcasting ³	MFC-440CN, 210 stations MFC-665CW MFC-845CW 250 stations
Automatic Redial	1 time after 5 minutes
Auto Answer	0, 1, 2, 3 or 4 rings
Communication Source	Public switched telephone network.

Memory Transmission

Up to 480 $1/400^2$ pages

Out of Paper Reception

Up to 480 $1/400^2$ pages

- ¹ 'Pages' refers to the 'Brother Standard Chart No. 1' (a typical business letter, Standard resolution, MMR code). Specifications and printed materials are subject to change without prior notice.
- ² 'Pages' refers to the 'ITU-T Test Chart #1' (a typical business letter, Standard resolution, MMR code). Specifications and printed materials are subject to change without prior notice.
- ³ Black & White only

Message Center (MFC-665CW and MFC-845CW only)

Message Center	Yes
ICM Recording Time	Max. 29 minutes / Max. 99 messages (Max.180 secs / 1 message)
Toll Saver	Yes
Recording Conversation (MFC-665CW only)	Yes
OGM	Yes
Recording OGM Time	20 secs

Digital Cordless Handset (MFC-845CW only)

Cordless handset

Frequency	5.8 GHz
Technology	FHSS (Frequency Hopping Spread Spectrum)
Multi Handset Capability	Up to 4 handsets
Dimensions	

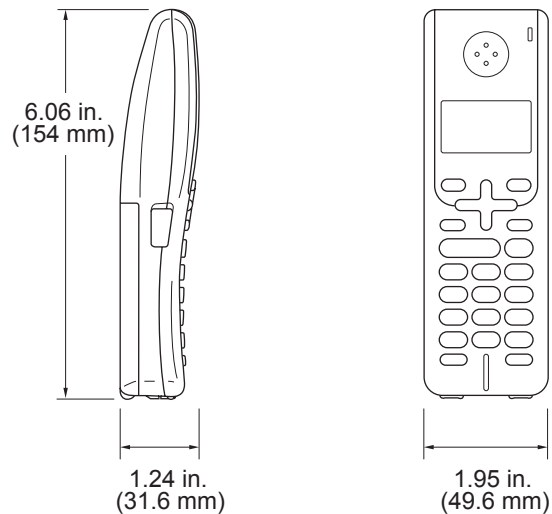

Weight (including battery)	5.43 oz (154 g)
LCD (liquid crystal display)	16-Digit, 3-Line (+1-Line for Pict), Backlit (Orange)
Charge Indicator	Yes (LED)
Full Charge Time	12 hours
While in Use (TALK)	4 hours ¹ 6 hours ²
While Not in Use (Standby)	200 hours

¹ When Voice Enhance is set to On.

² When Voice Enhance is set to Off.

Battery

Type	BCL-BT10
Rating	Ni-MH 3.6 V 730 mAh

Battery cradle

Dimensions

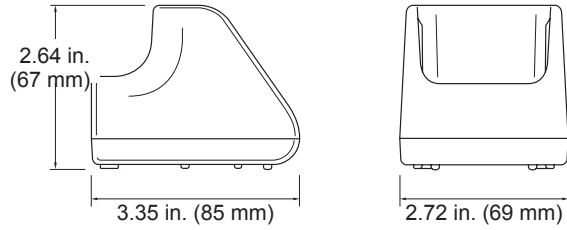

Weight

2.53 oz (71.6 g)

Power Consumption (during charge)

Charging: Average 2 W

AC adapter

Type

BCL-ADA

Input

AC 100 to 240 V 50/60 Hz

Output

DC 11.0 V

Copy

Color/Black		Yes/Yes
Document Size		ADF Width: 5.8 in. to 8.5 in. (148 mm to 215.9 mm) ADF Height: 5.8 in. to 14 in. (148 mm to 355.6 mm) Scanner Glass Width: Max. 8.5 in. (215.9 mm) Scanner Glass Height: Max. 11.7 in. (297 mm) Copy Width: Max. 8.26 in. (210 mm)
Copy Speed	MFC-440CN	Black: Up to 18 pages/minute (Letter paper) ¹ Color: Up to 16 pages/minute (Letter paper) ¹
	MFC-665CW, MFC-845CW	Black: Up to 20 pages/minute (Letter paper) ¹ Color: Up to 18 pages/minute (Letter paper) ¹
Multiple Copies		Stacks/Sorts up to 99 pages
Enlarge/Reduce		25% to 400% (in increments of 1%)
Resolution		(Black & White) ■ Scans up to 600×1200 dpi ■ Prints up to 1200×1200 dpi (Color) ■ Scans up to 600×1200 dpi ■ Prints up to 600×1200 dpi

¹ Based on Brother standard pattern. (Fast mode/Stack Copy) Copy speeds vary with the complexity of the document.

PhotoCapture Center[®]

Available Media

CompactFlash[®]
(Type I only)
(Microdrive[™] is not compatible)
(Compact I/O cards such as Compact LAN card and Compact Modem card are not supported.)

Memory Stick[®]
Memory Stick Pro[™]
(Not available for music data with MagicGate[™])

MultiMediaCard[™]
Secure Digital[™]
xD-Picture Card[™] ¹

File Extension

(Media Format)

DPOF, EXIF, DCF

(Image Format)

Photo Print:JPEG ²

Scan to Card:JPEG, PDF (Color)

TIFF, PDF (Black)

Color Enhancement

True2Life[®]

Number of Files

Up to 999 files in the media card (including the folder inside media)

Folder

File must be in the 3rd folder level of the Media Card.

Borderless

Letter, A4, Photo 4" × 6", Photo 5" × 7" ³

¹ xD-Picture Card[™] Conventional Card from 16MB to 512MB
xD-Picture Card[™] Type M from 256MB to 1GB
xD-Picture Card[™] Type H from 256MB to 1GB

² Progressive JPEG format is not supported.

³ See *Paper type and size for each operation* on page 15.

PictBridge

Compatibility

Supports the Camera & Imaging Products Association PictBridge standard CIPA DC-001.

Visit <http://www.cipa.jp/pictbridge> for more information.

Interface

PictBridge (USB) Port

Scanner

Color/Black	Yes/Yes
TWAIN Compliant	Yes (Windows® 98/98SE/Me/2000 Professional/XP/ Windows® XP Professional x64 Edition) Mac OS® X 10.2.4 or greater
WIA Compliant	Yes (Windows® XP ¹)
Color Depth	36 bit color Processing (Input) 24 bit color Processing (Output) (Actual Input: 30 bit color/Actual Output: 24 bit color)
Resolution	Up to 19200 × 19200 dpi (interpolated) ² Up to 600 × 2400 dpi (optical)
Scanning Speed	Black: Up to 3.59 sec. Color: Up to 5.66 sec. (Letter size at 100 × 100 dpi)
Document Size	ADF Width: 5.8 in. to 8.5 in. (148 mm to 215.9 mm) ADF Height: 5.8 in. to 14 in. (148 mm to 355.6 mm) Scanner Glass Width: Max. 8.5 in. (215.9 mm) Scanner Glass Height: Max. 11.7 in. (297 mm)
Scanning Width	8.26 in. (210 mm)
Gray Scale	256 levels

¹ Windows® XP in this User's Guide includes Windows® XP Home Edition, Windows® XP Professional, and Windows® XP Professional x64 Edition.

² Maximum 1200 × 1200 dpi scanning when using the WIA Driver for Windows® XP (resolution up to 19200 × 19200 dpi can be selected by using the Brother scanner utility)

Printer

Printer Driver		Windows® 98/98SE/Me/2000 Professional/XP/ Windows® XP Professional x64 Edition driver supporting Brother Native Compression mode Mac OS® X 10.2.4 or greater : Brother Ink Driver
Resolution		Up to 1200 × 6000 dpi ¹ 1200 × 2400 dpi 1200 × 1200 dpi 600 × 600 dpi 600 × 300 dpi 600 × 150 dpi
Print Speed	MFC-440CN	Up to 25 pages/minute (Black) ² Up to 20 pages/minute (Color) ²
	MFC-665CW, MFC-845CW	Up to 27 pages/minute (Black) ² Up to 22 pages/minute (Color) ²
Printing Width		8.26 in. [8.5 in. (borderless) ³] ⁵ 210 mm [216 mm (borderless) ³] ⁵
Disk-Based Fonts		35 TrueType
Borderless		Letter, A4, A6, Photo 4"×6", Index Card, Photo L 3.5"×5", Photo 2L 5"×7", Post Card ⁴

¹ Output image quality varies based on many factors including, but not limited to input image resolution and quality and print media.

² Based on Brother standard pattern.
Letter size in draft mode.

³ When you set the Borderless feature to On.

⁴ See *Paper type and size for each operation* on page 15.

⁵ When printing on letter size paper.

Interfaces

USB	A USB 2.0 interface cable that is no longer than 6 feet (2.0 m). ^{1 2}
LAN cable ³	Ethernet UTP cable category 5 or greater.
Wireless LAN (MFC-665CW and MFC-845CW only)	Your machine supports IEEE 802.11b/g wireless communication with your wireless LAN using Infrastructure mode or a wireless Peer-to-Peer connection in Ad-hoc Mode. ⁴

- ¹ Your machine has a USB 2.0 Full-speed interface. This interface is compatible with USB 2.0 Hi-Speed; however, the maximum data transfer rate will be 12 Mbits/s. The machine can also be connected to a computer that has a USB 1.1 interface.
- ² Third party USB ports are not supported for Macintosh®.
- ³ See the *Network User's Guide* on the CD-ROM for detailed network specifications.
- ⁴ A wireless network connection is supported only between the machine and an access point for PCs running Windows® XP Professional x64 Edition (Ad-hoc connection is not supported).

Computer requirements

Minimum System Requirements and Supported PC Software Functions								
Computer Platform & Operating System Version		Supported PC Software Functions	Interfaces	Minimum Processor Speed	Minimum RAM	Recommended RAM	Available Hard Disk Space	
							for Drivers	for Applications
Windows® Operating Systems ¹	98, 98SE	Printing, PC Fax ⁴ , Scanning, Removable Disk ³	USB	Intel® Pentium® II or equivalent	32MB	128MB	120MB	130MB
	Me							
	2000 Professional		64MB		256MB	170MB	220MB	
	XP Home		Wireless 802.11 b/g ⁵ (MFC-665CW and MFC-845CW only)		128MB			256MB
	XP Professional x64 Edition				AMD Opteron™, AMD Athlon™64, Intel® Xeon™ with Intel® EM64T, Intel® Pentium® 4 with Intel® EM64T	256MB	512MB	170MB
Apple® Macintosh® Operating Systems	OS X 10.2.4 or greater	Printing, PC Fax Send ⁴ , Scanning, Removable Disk ³	USB ² , Ethernet, Wireless 802.11 b/g (MFC-665CW and MFC-845CW only)	PowerPC G3/G4/G5, Intel® Core™ Solo/Duo 350MHz	128MB	256MB	80MB	200MB
¹ Microsoft® Internet Explorer 5 or greater. ² Third party USB ports are not supported. ³ Removable disk is a function of PhotoCapture Center®. ⁴ PC Fax supports black and white faxing only. ⁵ A wireless network connection is supported only between the machine and an access point for PCs running Windows® XP Professional x64 Edition (Ad-hoc connection is not supported).			For the latest driver updates, access the Brother Solutions Center at http://solutions.brother.com/					

Consumable items

Ink

The machine uses individual Black, Yellow, Cyan and Magenta ink cartridges that are separate from the print head assembly.

Service Life of Ink Cartridge

The first time you install the ink cartridges the machine will use extra ink to fill the ink delivery tubes. This is a one-time process that enables high quality printing. Afterward, replacement ink cartridges will print the specified number of pages.

Replacement Ink Cartridges

Standard Black - Approximately 500 pages at 5% coverage

Yellow, Cyan and Magenta - Approximately 400 pages at 5% coverage

The above figures are based upon the following assumptions:

- Continuous printing at a resolution of 600 × 600 dpi in normal mode after installing new ink cartridge;
- The printing frequency;
- The number of pages printed;
- Periodic, automatic, print head assembly cleaning (Your machine will clean the print head assembly periodically. This process will use a small amount of ink); and,
- Ink remaining in cartridge identified as 'empty' (It is necessary to leave a small amount of ink in the ink cartridge to prevent air from drying out and damaging the print head assembly).

Replacement Consumables

<Black> LC51BK, <Cyan> LC51C,
<Magenta> LC51M, <Yellow> LC51Y

Network (LAN)

LAN	You can connect your machine to a network for Network Printing, Network Scanning and PC Fax Send and PC Fax Receive ¹ (Windows [®] only). Also included is Brother BRAdmin Professional Network Management software.
Support for	Windows [®] 98/98SE/Me/2000/XP/XP Professional x64 Edition Mac OS [®] X 10.2.4 or greater Ethernet 10/100 BASE-TX Auto Negotiation (Wired LAN) IEEE 802.11 b/g (Wireless LAN) (MFC-665CW and MFC-845CW only)
Protocols	TCP/IP ARP, RARP, BOOTP, DHCP, APIPA (Auto IP), NetBIOS Name Resolution, WINS DNS Resolver, LPR/LPD, Custom Raw Port/Port9100, FTP Server, mDNS, TELNET, SNMP
Network Security (MFC-665CW and MFC-845CW only)	SSID/ESSID, 128 (104) / 64 (40) bit WEP, WPA/WPA2-PSK (TKIP/AES)
SecureEasySetup™ (MFC-665CW and MFC-845CW only)	Yes (simple setup with your SecureEasySetup™-capable access point/router)

¹ See the Computer Requirements chart on page 188.

E

Glossary

This is a comprehensive list of features and terms that appear in Brother manuals. Availability of these features depends on the model you purchased.

ADF (automatic document feeder)

The document can be placed in the ADF and scanned one page at a time automatically.

Auto Reduction

Reduces the size of incoming faxes.

Automatic Redial

A feature that enables your machine to redial the last fax number after five minutes if the fax did not go through because the line was busy.

Backup Print

Your machine prints a copy of every fax that is received and stored in memory. This is a safety feature so you will not lose messages during a power failure.

Batch Transmission

(Black and white faxes only) As a cost saving feature, all delayed faxes to the same fax number can be sent as one transmission.

Beeper Volume

Volume setting for the beep when you press a key or make an error.

Brightness

Changing the Brightness makes the whole image lighter or darker.

Broadcasting

The ability to send the same fax message to more than one location.

Caller ID

A service purchased from the telephone company that lets you see the number (or name) of the party calling you.

CNG tones

The special tones (beeps) sent by fax machines during automatic transmission to tell the receiving machine that a fax machine is calling.

Coding method

Method of coding the information contained in the document. All fax machines must use a minimum standard of Modified Huffman (MH). Your machine is capable of greater compression methods, Modified Read (MR), Modified Modified Read (MMR) and JPEG, if the receiving machine has the same capability.

Communication error (Comm. Error)

An error during fax sending or receiving, usually caused by line noise or static.

Compatibility group

The ability of one fax unit to communicate with another. Compatibility is assured between ITU-T Groups.

Contrast

Setting to compensate for dark or light documents, by making faxes or copies of dark documents lighter and light documents darker.

Delayed Fax

Sends your fax at a specified time later.

Distinctive Ring

A subscriber service purchased from the telephone company that gives you another phone number on an existing phone line. The Brother machine uses the new number to simulate a dedicated fax line.

Dual Access

Your machine can scan outgoing faxes or scheduled jobs into memory at the same time it is sending a fax from memory or receiving or printing an incoming fax.

Easy Receive

Enables your machine to respond to CNG tones if you interrupt a fax call by answering it.

ECM (Error Correction Mode)

Detects errors during fax transmission and resends the pages of the fax that had an error.

Extension phone

A telephone using the same line as your fax but plugged into a separate wall jack.

External phone

A telephone that is plugged into the EXT jack of your machine.

F/T Ring Time

The length of time that the Brother machine rings (when the Receive Mode setting is Fax/Tel) to notify you to pick up a voice call that it answered.

Fax Forwarding

Sends a fax received into the memory to another pre-programmed fax number.

Fax Receive Code

Press this code (✕ 5 1) when you answer a fax call on an extension or external phone.

Fax Storage

You can store received faxes in memory.

Fax tones

The signals sent by sending and receiving fax machines while communicating information.

Fax/Tel

You can receive faxes and telephone calls. Do not use this mode if you are using a telephone answering device (TAD).

Fine resolution

Resolution is 203 × 196 dpi. It is used for small print and graphs.

Gray scale

The shades of gray available for copying, scanning and faxing photographs.

Group number

A combination of Speed-Dial numbers that are stored in a Speed-Dial location for Broadcasting.

Help list

A printout of the complete Menu table that you can use to program your machine when you do not have the User's Guide with you.

Fax Journal

Lists information about the last 200 incoming and outgoing faxes. TX means Transmit. RX means Receive.

Journal Period

The pre-programmed time period between automatically printed Fax Journal Reports. You can print the Fax Journal on demand without interrupting the cycle.

LCD (liquid crystal display)

The display screen on the machine that shows interactive messages during On-Screen Programming and shows the date and time when the machine is idle.

Manual fax

Depending on your model, you can lift the handset, cordless handset, or handset of the external telephone or you can press **Hook** or **Speaker Phone** to hear the receiving fax machine answer before you press **Black Start** or **Color Start** to begin sending.

Menu mode

Programming mode for changing your machine's settings.

OCR (optical character recognition)

The bundled ScanSoft® PaperPort® SE with OCR or Presto!® PageManager® software application converts an image of text to text you can edit.

Out of Paper Reception

Receives faxes into the machine's memory when the machine is out of paper.

Overseas Mode

Makes temporary changes to the fax tones to accommodate noise and static on overseas phone lines.

Paging

This feature enables your machine to call your pager when a fax is received into its memory. The machine will also page for voice messages.

Pause

Allows you to place a 3.5 second delay in the dialing sequence stored on Speed-Dial numbers. Press **Redial/Pause** as many times as needed for longer pauses.

PhotoCapture Center®

Allows you to print digital photos from your digital camera at high resolution for photo quality printing.

Photo resolution

A resolution setting that uses varying shades of gray for the best representation of photographs.

PictBridge

Allows you to print photos directly from your digital camera at high resolution for photo quality printing.

Polling

The process of a fax machine calling another fax machine to retrieve waiting fax messages.

Pulse (Canada only)

A form of rotary dialing on a telephone line.

Quick Dial List

A listing of names and numbers stored in Speed-Dial memory, in numerical order.

Real Time Transmission

When memory is full, you can send faxes in real time.

Remaining jobs

You can check which jobs are waiting in memory and cancel jobs individually.

Remote Access Code

Your own four-digit code (---*) that allows you to call and access your machine from a remote location.

Remote Retrieval Access

The ability to access your machine remotely from a touch tone phone.

Resolution

The number of vertical and horizontal lines per inch. See: Standard, Fine, Super Fine and Photo.

Ring Delay

The number of rings before the machine answers in *Fax Only* and *Fax/Tel* modes.

Ring Volume

Volume setting for the machine's ring.

Scanning

The process of sending an electronic image of a paper document into your computer.

Scan to Card

You can scan a black and white or color document into a Media Card. Black and white images can be in TIFF or PDF file format and color images can be in PDF or JPEG file format.

Search

An electronic, alphabetical listing of stored Speed-Dial and Group numbers.

Speed-Dial

A pre-programmed number for easy dialing. You must press **Search/Speed Dial**, the two digit code, and **Black Start** or **Color Start** to start the dialing process.

Standard resolution

203 × 97 dpi. It is used for regular size text and quickest transmission.

Station ID

The stored information that appears on the top of faxed pages. It includes the sender's name and fax number.

Super Fine resolution

392 × 203 dpi. Best for very small print and line art.

TAD (telephone answering device)

You can connect an external device or answering machine to the EXT. jack of your machine.

Telephone Answer Code (For Fax/Tel mode only)

When the machine answers a voice call, it pseudo/double-rings. You can pick up at an extension phone by pressing this code (**# 5 1**).

Temporary settings

You can choose certain options for each fax transmission and copy without changing the default settings.

Tone

A form of dialing on the telephone line used for Touch Tone telephones.

Transmission

The process of sending faxes over the phone lines from your machine to the receiving fax machine.

Transmission Verification Report

A listing for each fax sent, that shows its date, time and number.

True2Life®

Adjusts the color in the image for better print quality by improving sharpness, white balance and color density.

User Settings

A printed report that shows the current settings of the machine.

F

Index

A

Access codes, storing and dialing	70
Accessories and supplies	iii
ADF (automatic document feeder)	11, 38
Answering machine (TAD)	57
connecting	58
Apple® Macintosh®	
See Software User's Guide on the	
CD-ROM.	
Automatic	
fax receive	46
Easy Receive	50

B

Broadcasting	40
setting up Groups for	68
Brother	
accessories and supplies	iii
Brother numbers	i
Customer Service	i
FAQs (frequently asked questions)	i
fax back system	ii
product support	i
Solutions Center	i
warranties	iv, v, vii

C

Caller ID	56
print list	57
view list	56
Canceling	
Fax Forwarding	81, 84
Fax Preview	81, 82
Fax Storage	81
jobs awaiting redial	43
Paging	81, 84
PC Fax Receive	81, 82
Cleaning	
paper pick-up roller	147
print head	148
printer platen	147
scanner	146
Connecting	
external TAD	57

external telephone	61
two-line external TAD or telephone	60
Consumable items	189
Control panel overview	6
ControlCenter	
See Software User's Guide on the	
CD-ROM.	
Copy	
brightness	96
color saturation	96
contrast	96
enlarge/reduce	94
enter Copy mode	92
multiple	93
out of memory	98
page layout (N in 1)	94
paper size	97
paper type	97
quality	93
return to default	97
set new default	97
single	92
sort (ADF only)	95
using ADF	93
using scanner glass	12
Cordless handset (MFC-845CW only)	
See Digital Cordless Handset	
User's Guide	
Cordless phone	62
Custom telephone features on a	
single line	133

D

Dialing	
a pause	66
Caller ID history	65
Groups	40
manual	63
Outgoing Call	64
Speed-Dial	63
Distinctive Ring	54
setting ring pattern	55
turning off	55
Document	
loading	11, 12
Dual Access	42

E

Easy Receive	50
Envelopes	15, 16, 19, 20
Error messages on LCD	136
Comm. Error	136
Ink Empty	136
Near Empty	137
No Paper Fed	137
Not Registered	63
Out of Memory	138
while scanning a document	98
Unable to Change	138
Unable to Clean	138
Unable to Init.	138
Unable to Print	138
Unable to Scan	138
Unable to use Phone	139
Extension telephone, using	62
External telephone, connecting	61

F

Fax codes	
changing	62, 82
Fax Receive Code	50, 61, 62
Remote Access Code	82
Telephone Answer Code	61, 62
using	62
Fax Forwarding	
changing remotely	84, 86
programming a number	76
Fax Storage	78
printing from memory	51
turning off	81
turning on	78
Fax, from PC	
See Software User's Guide on the CD-ROM.	
Fax, stand-alone	
receiving	46
at end of conversation	48, 51
difficulties	130, 132
Easy Receive	50
F/T Ring Time, setting	49
Fax Forwarding	84
Fax Preview	78, 79
from extension phone	61, 62
into PC	80

Paging	77
phone line interference	143
printing from memory	51
Receive Mode, choosing	46
reducing to fit on paper	51
retrieving from a remote site	84, 86
Ring Delay, setting	49
sending	38, 89
at end of conversation	44
Broadcasting	40
canceling from memory	43
color fax	39
contrast	41
delayed batch transmission	43
delayed fax	43
enter Fax mode	38
from memory (Dual Access)	42
from scanner glass	39
manual	44
overseas	43
phone line interference	143
Real Time Transmission	42
Resolution	41
return to factory setting	44
set new default	44
Fax/Tel mode	
Announcement	71
answering at extension phones	61, 62
double-ringing (voice calls)	49
F/T Ring Time	49
Fax Receive Code	61, 62
Ring Delay	49
Telephone Answer Code	61, 62
FCC notices	125

G

Gray scale	178, 185
Groups for Broadcasting	68

H

HELP	
LCD messages	158
using Menu keys	158
Menu Table	159
Hook key	8

I

Ink cartridges	
checking ink volume	150
ink dot counter	143
replacing	143

J

Jams	
document	140
paper	140

L

LCD (liquid crystal display)	158
Brightness	31, 32
Contrast	31
Dim Timer	31
Help List	88
Off Timer	31

M

Macintosh®	
See Software User's Guide on the CD-ROM.	
Maintenance, routine	143
Manual	
dialing	63
receive	46
transmission	44
Memory Security	36
Memory Storage	158
Message Center mode	
erasing messages	73
Fax/Tel announcement (F/T OGM)	72
outgoing message (Msg Ctr OGM)	71
playing voice messages	73
recording a conversation	75
setting toll saver	74
setting up	71, 72
Mode, entering	
Copy	92
Fax	38
PhotoCapture	8
Scan	8
Multi-line connections (PBX)	61

N

Network	
Printing	
See Network User's Guide on the CD-ROM.	
Scanning	
See Software User's Guide on the CD-ROM.	

O

On/Off key	24
Out of Area (Caller ID)	56
Outgoing Message (Msg Ctr OGM)	71

P

Packing the machine	154
Paging	77
Paper	13, 19, 177
capacity	16
loading	17, 19, 21
printable area	23
size	27
size of document	11
type	15, 26
PaperPort® SE with OCR	
See Software User's Guide on the CD-ROM.	
Phone line	
connections	58
difficulties	132
interference	143
multi-line (PBX)	61
roll over lines	59
two-line phone system	59
Photo Bypass Tray (USA)	21
Photo Paper Tray (Canada)	21
PhotoCapture Center®	
Borderless	108
CompactFlash®	100
Cropping	106, 108
DPOF printing	104
from PC	
See Software User's Guide on the CD-ROM.	
Memory Stick Pro™	100
Memory Stick®	100

MultiMediaCard™	100
Preview photos	102
Print settings	
Brightness	106
Contrast	106
Paper & print size	106
Paper type	106
Quality	105, 106
Return to factory setting	108
Set new default	108
True2Life®	107
Printing Index	103
Printing photos	103, 104
Scan to Card	109
SecureDigital™	100
specifications	184
xD-Picture Card™	100
PictBridge	
DPOF Printing	112
Power failure	158
Presto!® PageManager®	
See Help in Presto!® PageManager® to access the User's Guide on the CD-ROM.	
Print	
difficulties	130, 132
drivers	186
fax from memory	51
paper jams	141
report	88
resolution	186
specifications	186
Printing	
index	103
on small paper	22
photos	103, 104
See Software User's Guide on the CD-ROM.	
Programming your machine	158

Q

Quick-Dial	
Access codes and credit card numbers	70
Broadcasting	40
using Groups	40
Group dial	
changing	66, 67
setting up Groups for Broadcasting	68

Search	63
Speed-Dial	
changing	66, 67
setting up by 2-digit location	66
setting up from Caller ID history	67
setting up from outgoing calls	66
using	63

R

Receive Mode	46
External TAD	46
Fax Only	46
Fax/Tel	46
Manual	46
Redial/Pause	64
Reducing	
copies	94
incoming faxes	51
Remote Retrieval	82
access code	82, 83
commands	84
getting your faxes	86
Remote Setup	
See Software User's Guide on the CD-ROM.	
Reports	87
Caller ID List	57
Fax Journal	88
Journal Period	87
Help List	88
how to print	88
Network Configuration	88
Quick-Dial List	88
Transmission Verification	87, 88
User Settings	88
Resolution	
copy	183
fax	178
print	186
scan	185
setting for next fax	41
Ring Delay, setting	49

S

Safety Instructions	119, 123
Scannable area	12
Scanning	
See Software User's Guide on the CD-ROM.	
Serial Number	
how to find	
See inside front cover	
Shipping the machine	154
Speed-Dial	
changing	66, 67
dialing	63
storing	66

T

TAD (telephone answering device), external	46, 57, 60
connecting	57, 58
receive mode	46, 47
recording OGM	59
with two-line jack	60
Text, entering	174
special characters	174
Transferring your faxes or Fax Journal report	139
Transparencies	13, 16, 177
Troubleshooting	130
checking ink volume	150
document jam	140
error messages on LCD	136
if you are having difficulty	
copying	134
document jam	140
incoming calls	133
Network	135
phone line or connections	132
PhotoCapture Center®	134
printing	130
printing received faxes	132
receiving faxes	132
sending faxes	133
software	134
paper jam	141
True2Life®	
PhotoCapture Center®	107
Two-line phone system	59
TX Lock	34

V

Volume, setting	
beeper	27
handset	28
volume amplify (for hearing -impaired)	29
ring	27
speaker	28

W

Warranties	iv
Canada	vii
Notice-Disclaimer	iv
USA	v
Wireless Network	
See Quick Setup Guide and Network User's Guide on the CD-ROM.	
World Wide Web	i

EQUIPMENT ATTACHMENT LIMITATIONS (Canada only)

NOTICE

This product meets the applicable Industry Canada technical specifications.

NOTICE

The Ringer Equivalence Number is an indication of the maximum number of devices allowed to be connected to a telephone interface. The termination on an interface may consist of any combination of devices subject only to the requirement that the sum of the RENs of all the devices does not exceed five.

Brother International Corporation
100 Somerset Corporate Boulevard
P.O. Box 6911
Bridgewater, NJ 08807-0911 USA

Brother International Corporation (Canada) Ltd.
1 rue Hôtel de Ville,
Dollard-des-Ormeaux, QC, Canada H9B 3H6

brother[®]

**Visit us on the World Wide Web
<http://www.brother.com>**

These machines are made for use in the USA and Canada only. We cannot recommend using them overseas because it may violate the Telecommunications Regulations of that country and the power requirements of your multi-function center may not be compatible with the power available in foreign countries. **Using USA or Canada models overseas is at your own risk and may void your warranty.**



LP5196001④
US/CAN
Printed in China

Free Manuals Download Website

<http://myh66.com>

<http://usermanuals.us>

<http://www.somanuals.com>

<http://www.4manuals.cc>

<http://www.manual-lib.com>

<http://www.404manual.com>

<http://www.luxmanual.com>

<http://aubethermostatmanual.com>

Golf course search by state

<http://golfingnear.com>

Email search by domain

<http://emailbydomain.com>

Auto manuals search

<http://auto.somanuals.com>

TV manuals search

<http://tv.somanuals.com>