



# Online User's Guide

**HL-L5000D**

**HL-L5100DN**

**HL-L5200DW**

**HL-L5200DWT**

**HL-L6200DW**

**HL-L6200DWT**

**HL-L6300DW**

## Table of Contents

<b>Before You Use Your Brother Machine .....</b>	<b>1</b>
Applicable Models .....	2
Definitions of Notes .....	3
Notice - Disclaimer of Warranties (USA and Canada) .....	4
Trademarks .....	5
Important Note .....	6
<b>Introduction to Your Brother Machine.....</b>	<b>7</b>
Before Using Your Machine .....	8
Front View and Back View .....	9
Control Panel Overview .....	11
Touchscreen LCD Overview.....	15
How to Navigate the Touchscreen LCD .....	17
Access Brother Utilities (Windows®) .....	19
Uninstall the Brother Software and Drivers (Windows®) .....	21
<b>Paper Handling.....</b>	<b>22</b>
Load Paper.....	23
Load and Print Using the Paper Tray .....	24
Load and Print Using the Multi-purpose Tray (MP Tray) .....	31
Paper Settings.....	38
Change the Paper Size and Paper Type.....	39
Change the Check Paper Size Setting.....	40
Unprintable Area .....	41
Recommended Print Media .....	42
Using Special Paper.....	43
<b>Print.....</b>	<b>44</b>
Print from Your Computer (Windows®) .....	45
Print a Document (Windows®).....	46
Print More Than One Page on a Single Sheet of Paper (N in 1) (Windows®).....	48
Print as a Poster (Windows®).....	49
Print on Both Sides of the Paper (Windows®).....	50
Print as a Booklet (Windows®) .....	53
Secure Print (Windows®).....	55
Use a Macro from Your Computer (Windows®).....	57
Use a Preset Print Profile (Windows®).....	58
Change the Default Print Settings (Windows®).....	61
Print a Document Using the BR-Script3 Printer Driver (PostScript® 3™ Language Emulation) (Windows®) .....	63
Monitor the Status of the Machine from Your Computer (Windows®) .....	64
Print Settings (Windows®).....	65
Print from Your Computer (Macintosh).....	70
Print a Document (Macintosh).....	71
Print on Both Sides of the Paper (Macintosh) .....	72
Print More Than One Page on a Single Sheet of Paper (N in 1) (Macintosh).....	74

Secure Print (Macintosh).....	75
Print a Document Using the BR-Script3 Printer Driver (PostScript® 3™ language emulation) (Macintosh).....	77
Monitor the Status of the Machine from Your Computer (Macintosh).....	78
Print Options (Macintosh).....	79
Print One Page Duplicates on Different Types of Paper .....	85
Cancel a Print Job.....	87
Test Print .....	88
<b>Network .....</b>	<b>89</b>
Get Started.....	90
Supported Basic Network Features.....	91
Network Management Software and Utilities .....	92
Learn about Network Management Software and Utilities .....	93
Additional Methods of Configuring Your Brother Machine for a Wireless Network .....	94
Before Configuring Your Brother Machine for a Wireless Network.....	95
Configure Your Machine for a Wireless Network.....	96
Configure Your Machine for a Wireless Network Using the One Push Method of Wi-Fi Protected Setup™ (WPS).....	97
Configure Your Machine for a Wireless Network Using the PIN Method of Wi-Fi Protected Setup™ (WPS).....	99
Configure Your Machine for a Wireless Network in Ad-Hoc Mode (For IEEE 802.11b/g/n) .....	103
Configure Your Machine for a Wireless Network Using the Machine's Control Panel Setup Wizard .....	109
Configure Your Machine for a Wireless Network When the SSID Is Not Broadcast .....	112
Configure Your Machine for an Enterprise Wireless Network .....	115
Use Wi-Fi Direct® .....	120
Advanced Network Features.....	134
Print the Network Configuration Report.....	135
Print the WLAN Report.....	136
Configure the SNMP Protocol Using Web Based Management .....	139
Technical Information for Advanced Users.....	141
Gigabit Ethernet (Wired Network Only) .....	142
Reset the Network Settings to the Factory Settings.....	144
<b>Security .....</b>	<b>145</b>
Lock the Machine Settings .....	146
About Using Setting Lock .....	147
Network Security Features.....	151
Before Using Network Security Features .....	152
Secure Function Lock 3.0.....	153
Use Active Directory® Authentication .....	159
Use LDAP Authentication.....	163
Manage Your Network Machine Securely Using SSL/TLS.....	167
Manage Your Network Machine Securely Using IPsec .....	200
Send an Email Securely .....	218
Use IEEE 802.1x Authentication for a Wired or a Wireless Network .....	223
Store Print Log to Network .....	228
<b>Mobile/Web Connect.....</b>	<b>233</b>

Use Web Services from Your Brother Machine.....	234
Print with Google Cloud Print™ .....	235
Print with AirPrint.....	236
Print with Mopria™ .....	237
Print from a Mobile Device .....	238
Print Using Near-Field Communication (NFC).....	239
<b>Troubleshooting .....</b>	<b>240</b>
Error and Maintenance Messages .....	241
Paper Jams .....	249
Paper is Jammed in the MP tray .....	250
Paper is Jammed in the Paper Tray .....	251
Paper is Jammed in the Back of the Machine .....	253
Paper is Jammed inside the Machine .....	255
Paper is Jammed in the 2-sided Tray.....	257
Paper is Jammed in the Mailbox Unit.....	259
Printing Problems.....	260
Improve the Print Quality.....	262
Network Problems.....	266
Error Messages .....	267
Use the Network Connection Repair Tool (Windows®) .....	270
Where Can I Find My Brother Machine's Network Settings? .....	272
I Cannot Complete the Wireless Network Setup Configuration.....	273
My Brother Machine Cannot Print over the Network.....	275
I Want to Check that My Network Devices are Working Correctly .....	277
Other Problems .....	278
Check the Machine Information .....	280
Reset Functions .....	282
Network Reset.....	283
Factory Reset.....	284
<b>Routine Maintenance .....</b>	<b>285</b>
Replace Supplies .....	286
Replace the Toner Cartridge .....	288
Replace the Drum Unit.....	291
Reset the Drum Counter .....	294
Clean the Machine .....	295
Clean the Touchscreen LCD .....	297
Clean the Corona Wire.....	298
Clean the Drum Unit.....	299
Clean the Paper Pick-up Rollers .....	305
Check the Remaining Life of Parts.....	306
Pack and Ship Your Machine .....	307
Pack the Machine and the Toner Cartridge Together .....	308
Pack the Machine and the Toner Cartridge Separately.....	310
<b>Machine Settings.....</b>	<b>313</b>
Change Machine Settings from the Control Panel.....	314
General Settings.....	315

Settings and Features Tables .....	325
Change Machine Settings from Your Computer .....	342
Change Machine Settings Using Web Based Management .....	343
<b>Appendix .....</b>	<b>348</b>
Specifications .....	349
How to Enter Text on Your Brother Machine .....	356
Supplies .....	358
Accessories .....	359
Mailbox Unit .....	360
<b>Glossary .....</b>	<b>365</b>

## Before You Use Your Brother Machine

- [Applicable Models](#)
- [Definitions of Notes](#)
- [Notice - Disclaimer of Warranties \(USA and Canada\)](#)
- [Trademarks](#)
- [Important Note](#)

## Applicable Models

This User's Guide applies to the following models:

1 line LCD models: HL-L5000D/HL-L5100DN/HL-L5200DW/HL-L5200DWT/HL-L6200DW/HL-L6200DWT

1.8 inch Touchscreen LCD models: HL-L6300DW









### Related Information

- [Before You Use Your Brother Machine](#)
-

## Definitions of Notes

We use the following symbols and conventions throughout this User's Guide:

 <b>WARNING</b>	WARNING indicates a potentially hazardous situation which, if not avoided, could result in death or serious injuries.
 <b>CAUTION</b>	CAUTION indicates a potentially hazardous situation which, if not avoided, may result in minor or moderate injuries.
<b>IMPORTANT</b>	IMPORTANT indicates a potentially hazardous situation which, if not avoided, may result in damage to property or loss of product functionality.
<b>NOTE</b>	NOTE specifies the operating environment, conditions for installation, or special conditions of use.
	Tips icons indicate helpful hints and supplementary information.
	Electrical Hazard icons alert you to possible electrical shock.
	Fire Hazard icons alert you to the possibility of a fire.
	Hot Surface icons warn you not to touch hot machine parts.
	Prohibition icons indicate actions you must not perform.
<b>Bold</b>	Bold style identifies buttons on the machine's control panel or computer screen.
<i>Italics</i>	Italicized style emphasizes an important point or refers you to a related topic.
Courier New	Courier New font identifies messages shown on the machine's LCD.



### Related Information

- [Before You Use Your Brother Machine](#)



## Notice - Disclaimer of Warranties (USA and Canada)

BROTHER'S LICENSOR(S), AND THEIR DIRECTORS, OFFICERS, EMPLOYEES OR AGENTS (COLLECTIVELY BROTHER'S LICENSOR) MAKE NO WARRANTIES, EXPRESS OR IMPLIED, INCLUDING WITHOUT LIMITATION THE IMPLIED WARRANTIES OF MERCHANTABILITY AND FITNESS FOR A PARTICULAR PURPOSE, REGARDING THE SOFTWARE. BROTHER'S LICENSOR(S) DOES NOT WARRANT, GUARANTEE OR MAKE ANY REPRESENTATIONS REGARDING THE USE OR THE RESULTS OF THE USE OF THE SOFTWARE IN TERMS OF ITS CORRECTNESS, ACCURACY, RELIABILITY, CURRENTNESS OR OTHERWISE. THE ENTIRE RISK AS TO THE RESULTS AND PERFORMANCE OF THE SOFTWARE IS ASSUMED BY YOU. THE EXCLUSION OF IMPLIED WARRANTIES IS NOT PERMITTED BY SOME STATES IN THE USA AND SOME PROVINCES IN CANADA. THE ABOVE EXCLUSION MAY NOT APPLY TO YOU.

IN NO EVENT WILL BROTHER'S LICENSOR(S) BE LIABLE TO YOU FOR ANY CONSEQUENTIAL, INCIDENTAL OR INDIRECT DAMAGES (INCLUDING DAMAGES FOR LOSS OF BUSINESS PROFITS, BUSINESS INTERRUPTION, LOSS OF BUSINESS INFORMATION, AND THE LIKE) ARISING OUT OF THE USE OR INABILITY TO USE THE SOFTWARE EVEN IF BROTHER'S LICENSOR HAS BEEN ADVISED OF THE POSSIBILITY OF SUCH DAMAGES. BECAUSE SOME STATES IN THE USA AND SOME PROVINCES IN CANADA DO NOT ALLOW THE EXCLUSION OR LIMITATION OF LIABILITY FOR CONSEQUENTIAL OR INCIDENTAL DAMAGES, THE ABOVE LIMITATIONS MAY NOT APPLY TO YOU. IN ANY EVENT BROTHER'S LICENSOR'S LIABILITY TO YOU FOR ACTUAL DAMAGES FROM ANY CAUSE WHATSOEVER, AND REGARDLESS OF THE FORM OF THE ACTION (WHETHER IN CONTRACT, TORT (INCLUDING NEGLIGENCE), PRODUCT LIABILITY OR OTHERWISE), WILL BE LIMITED TO \$50.



### Related Information

- [Before You Use Your Brother Machine](#)

## Trademarks

BROTHER is either a trademark or a registered trademark of Brother Industries, Ltd.

Microsoft, Windows, Windows Vista, Windows Server, Internet Explorer, Active Directory, OneNote, Windows phone and OneDrive are either registered trademarks or trademarks of Microsoft Corporation in the United States and/or other countries.

Apple, Macintosh, Mac OS, Safari, iPad, iPhone, iPod touch and OS X are trademarks of Apple Inc., registered in the United States and other countries.

AirPrint is a trademark of Apple Inc.

PostScript and PostScript 3 are either registered trademarks or trademarks of Adobe Systems Incorporated in the United States and/or other countries.

Wi-Fi CERTIFIED, Wi-Fi, Wi-Fi Alliance, Wi-Fi Direct and Wi-Fi Protected Access are registered trademarks of Wi-Fi Alliance®.

WPA, WPA2, Wi-Fi Protected Setup and Wi-Fi Protected Setup logo are trademarks of Wi-Fi Alliance®.

Android, Google Cloud Print, Google Drive, Google Chrome and Google Play are trademarks of Google, Inc. Use of these trademarks is subject to Google Permissions.

Mopria is a trademark of Mopria Alliance, Inc.

Mozilla and Firefox are registered trademarks of the Mozilla Foundation.

UNIX is a registered trademark of The Open Group in the United States and other countries.

Linux is the registered trademark of Linus Torvalds in the U.S. and other countries.

Intel is a trademark of Intel Corporation in the U.S. and/or other countries.

Each company whose software title is mentioned in this manual has a Software License Agreement specific to its proprietary programs.

**Any trade names and product names of companies appearing on Brother products, related documents and any other materials are all trademarks or registered trademarks of those respective companies.**



### Related Information

- [Before You Use Your Brother Machine](#)

## Important Note

- Do not use this product outside the country of purchase as it may violate the wireless telecommunication and power regulations of that country.
- Not all models are available in all countries.
- Windows® XP in this document represents Windows® XP Professional, Windows® XP Professional x64 Edition and Windows® XP Home Edition.
- Windows Server® 2003 in this document represents Windows Server® 2003, Windows Server® 2003 x64 Edition, Windows Server® 2003 R2 and Windows Server® 2003 R2 x64 Edition.
- Windows Server® 2008 in this document represents Windows Server® 2008 and Windows Server® 2008 R2.
- In this User's Guide, the LCD messages of the HL-L5100DN/HL-L5200DW are used unless otherwise specified.
- In this User's Guide, the illustrations of the HL-L6300DW are used unless otherwise specified.
- Unless otherwise specified, the screens in this manual are from Windows® 7 and OS X v10.9.x. Screens on your computer may vary depending on your operating system.
- The contents of this guide and the specifications of this product are subject to change without notice.
- Not all features are available in countries subject to applicable export restrictions.



### Related Information

- [Before You Use Your Brother Machine](#)
-

## Introduction to Your Brother Machine

- [Before Using Your Machine](#)
- [Front View and Back View](#)
- [Control Panel Overview](#)
- [Touchscreen LCD Overview](#)
- [How to Navigate the Touchscreen LCD](#)
- [Access Brother Utilities \(Windows®\)](#)

## Before Using Your Machine

Before attempting any printing operation, confirm the following:

- Make sure you have installed the printer driver.
- For USB or network cable users: Make sure the interface cable is physically secure.

### Firewall (Windows®)

If your computer is protected by a firewall and you are unable to network print, you may need to configure the firewall settings. If you are using the Windows® Firewall and you installed the printer driver from the CD-ROM, the necessary firewall settings have already been set. If you are using any other personal firewall software, see the User's Guide for your software or contact the software manufacturer.



### Related Information

- [Introduction to Your Brother Machine](#)
-

## Front View and Back View

HL-L5000D/HL-L5100DN/HL-L5200DW/HL-L5200DWT/HL-L6200DW/HL-L6200DWT

### Front View

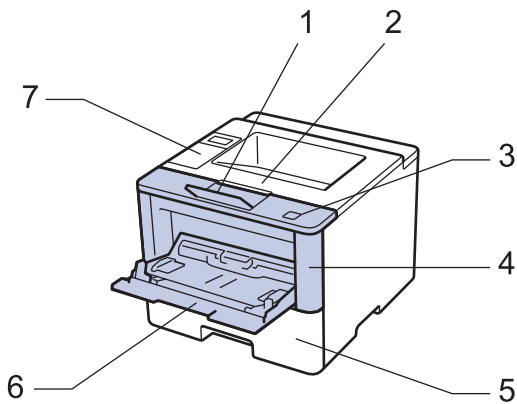

### Back View

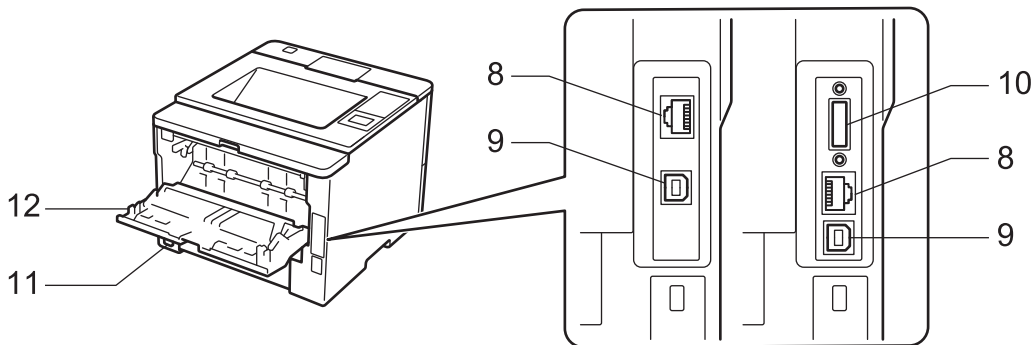

1. Face down output tray support flap (support flap)
2. Face down output tray
3. Front cover release button
4. Front cover
5. Paper tray
6. Multi-purpose tray (MP tray)
7. Control panel with a Liquid Crystal Display (LCD)
8. (For wired network models)  
10BASE-T / 100BASE-TX / 1000BASE-T port (supported models only)
9. USB port
10. Parallel port (supported models only)
11. AC power connector / cord
12. Back cover (Face up output tray)



The machine is equipped with a non-detachable AC power cord depending on the model.

## HL-L6300DW

### Front View

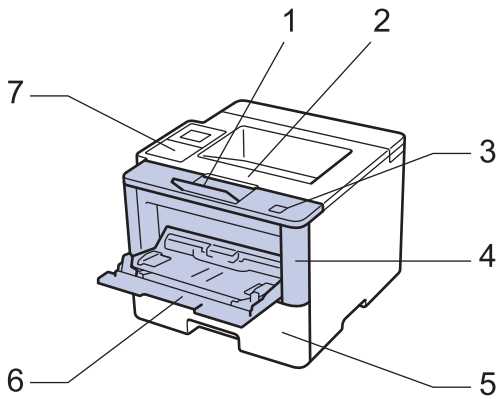

### Back View

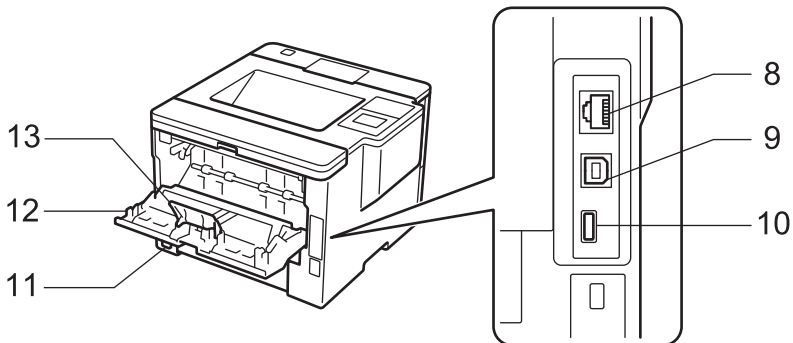

1. Face down output tray support flap (support flap)
2. Face down output tray
3. Front cover release button
4. Front cover
5. Paper tray
6. Multi-purpose tray (MP tray)
7. Touch panel with a tiltable Touchscreen LCD
8. (For wired network models)  
10BASE-T / 100BASE-TX / 1000BASE-T port
9. USB port
10. USB accessory port
11. AC power connector / cord
12. Back cover (Face up output tray)
13. Paper stopper



The machine is equipped with a non-detachable AC power cord depending on the model.

### ✓ Related Information

- [Introduction to Your Brother Machine](#)

## Control Panel Overview

The control panel may vary depending on your model.

### HL-L5000D/HL-L5100DN/HL-L5200DW/HL-L5200DWT/HL-L6200DW/HL-L6200DWT

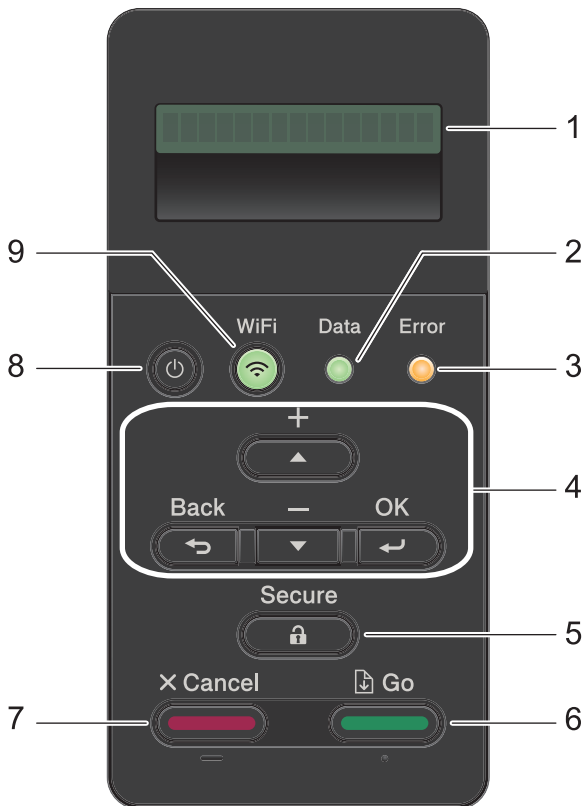

#### 1. Liquid Crystal Display (LCD)

Displays messages to help you set up and use the machine.

Wireless Network Models

A four-level indicator shows the wireless signal strength if you are using a wireless connection.



#### 2. Data LED

The **Data** LED blinks depending on the machine's status.

When the **Data** LED is on, data is in the machine's memory. When the **Data** LED blinks, the machine is receiving or processing data.

#### 3. Error LED

The **Error** LED blinks when the LCD displays an error or an important status message.

#### 4. Menu Buttons

##### OK

Press to store your machine's settings. After you change a setting, the machine returns to the previous menu level.

##### Back

- Press to go back one level in the menu.
- Press to select the previous digit when entering numbers.



---

### ▲ or ▼ (+ or -)

- Press to scroll through menus and options.
- Press to enter a number or to increase or decrease the number. Hold down ▲ or ▼ to scroll faster. When you see the number you want, press **OK**.

### 5. Secure

Press to print jobs saved in the memory when you enter your four-digit password.



### 6. Go

- Press to clear certain error messages. To clear all other errors, follow the LCD instructions.
- Press to print any data remaining in the machine's memory.
- Press to select the displayed option. After you change a setting, the machine returns to Ready Mode.

### 7. Cancel

- Press to cancel the current setting.
- Press to cancel a programmed print job and clear it from the machine's memory. To cancel multiple print jobs, hold down **Cancel** until the LCD displays [Cancel All Jobs].

### 8. Power On/Off

- Turn on the machine by pressing .
- Turn off the machine by pressing and holding down . The LCD displays [Shutting Down] for a few seconds before going off.

### 9. WiFi, Network, or Report buttons

- Non-Network Models:

#### **Report**

Press the **Report** button to print the Printer Settings page.

- Wired Network Models:

#### **Network**

Press the **Network** button to set up wired network settings.

- Wireless Network Models:

#### **WiFi**

Launch the wireless installer on your computer and press the **WiFi** button. Follow the on-screen instructions to set up a wireless connection between your machine and your network.

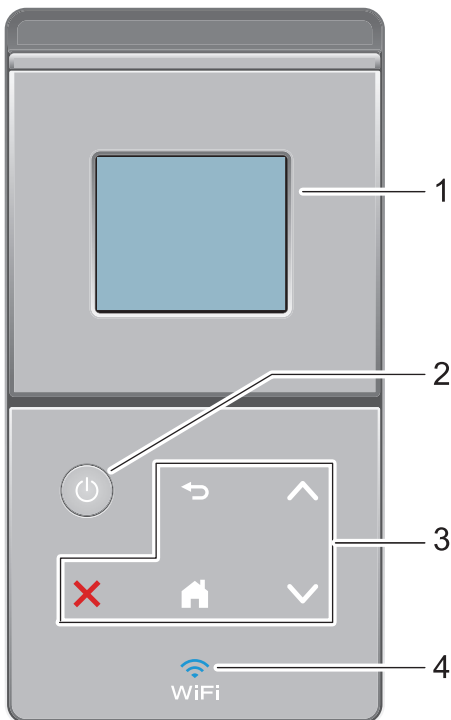

When the **WiFi** light is on, your Brother machine is connected to a wireless access point. When the **WiFi** light blinks, the wireless connection is down, or your machine is in the process of connecting to a wireless access point.



**1. Touchscreen Liquid Crystal Display (LCD)**

Access menus and options by pressing them on the Touchscreen.

**2.  Power On/Off**

- Turn on the machine by pressing .
- Turn off the machine by pressing and holding down . The LCD displays [Shutting Down] for a few seconds before going off.

**3. Touchpanel**



**(Back)**

Press to go back to the previous menu.



**(Home)**

- Press to return to the Home screen.
- While the machine is in Sleep Mode, the Home icon blinks.



**(Cancel)**

- Press to cancel an operation (available when lit).
- Press to cancel a programmed print job and clear it from the machine's memory. To cancel multiple print jobs, hold down  until the LCD displays [Cancel All Jobs].



**or**

Press to display the previous or next page.

**4.  (WiFi)**

(For infrastructure mode)

When the **WiFi** light is on, your Brother machine is connected to a wireless access point. When the **WiFi** light blinks, the wireless connection is down, or your machine is in the process of connecting to a wireless access point.

---

(For Ad-Hoc mode)

The **WiFi** LED is always off.



### **Related Information**

- [Introduction to Your Brother Machine](#)
-

## Touchscreen LCD Overview

**Related Models:** HL-L6300DW

From the Home screen, you can access the Wi-Fi setup, Toner level, Settings, and Functions screen.

The Home screen displays the machine's status when the machine is idle. This screen is also called the Ready Mode screen. When displayed, this screen indicates that your machine is ready for the next command.

If Active Directory® Authentication or LDAP Authentication is enabled, the machine's control panel will be locked. The available features vary depending on your model.

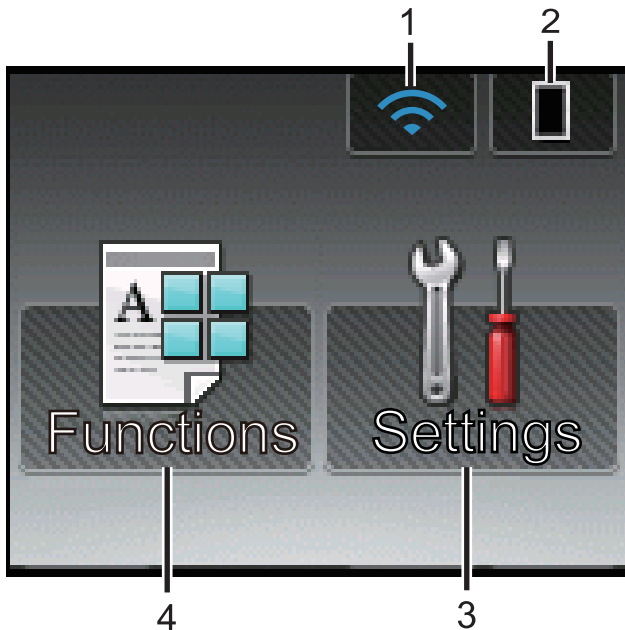

1.  (Wireless Status )

If you are using a wireless connection, a four-level indicator in the Home screen displays the current wireless signal strength.



- If you see  at the top on the screen, press it to configure wireless settings.

2.  (Toner)

Displays the remaining toner life. Press to access the [Toner] menu.

3.  [Settings]

Press to access the [Settings] menu.

Use the Settings menu to access all of your Brother machine's settings.

If Setting Lock has been turned on, a lock icon  appears on the LCD. You must unlock the machine to change settings.

4.  [Functions]

Press to access the Functions screen.

-  [Secure]

Press to access the Secure Print option.

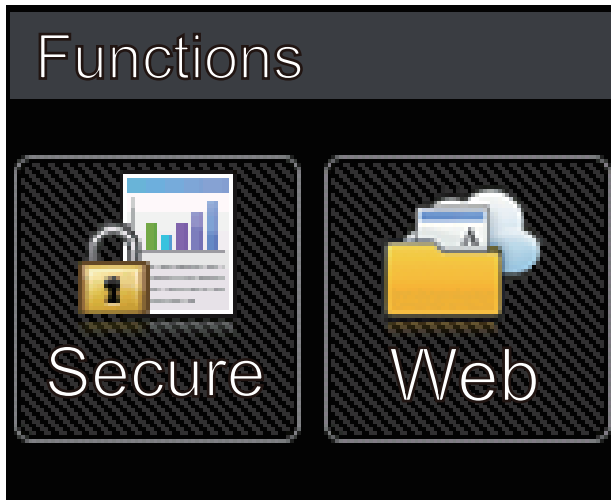

-  [Web]

Press to connect the Brother machine to an Internet service. For more information, see the *Web Connect Guide*. Go to your model's **Manuals** page on the Brother Solutions Center at [support.brother.com](http://support.brother.com) to download the guide.



#### Warning icon



The warning icon  appears when there is an error or maintenance message; press  to view it, and then press  to return to Ready Mode.

#### Related Information

- [Introduction to Your Brother Machine](#)

## How to Navigate the Touchscreen LCD

**Related Models:** HL-L6300DW

Press your finger on the LCD to operate it. To display and access all the options, press ▲ or ▼ on the Touchpanel to scroll through them.

The following steps explain how to navigate through changing the machine's setting. In this example, the LCD Backlight setting is changed from [Light] to [Med].

### IMPORTANT

DO NOT press the LCD with a sharp object such as a pen or stylus. It may damage the machine.

### NOTE

DO NOT touch the LCD immediately after plugging in the power cord or turning on the machine. Doing this may cause an error.

1. Press  [Settings].
2. Press ▲ or ▼ to display the [General Setup] option, and then press [General Setup].

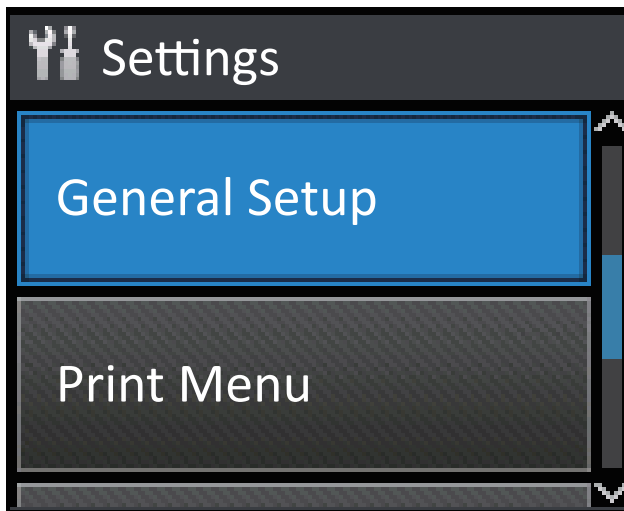

3. Press ▲ or ▼ to display the [Panel Control] option, and then press [Panel Control].

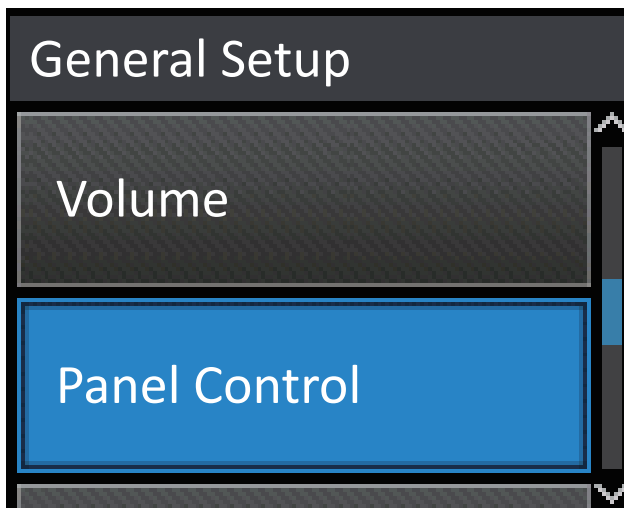

4. Press [LCD Settings].

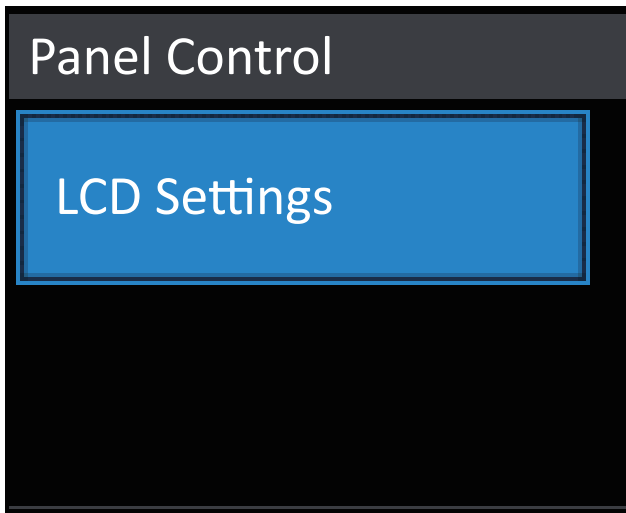

5. Press [Backlight].

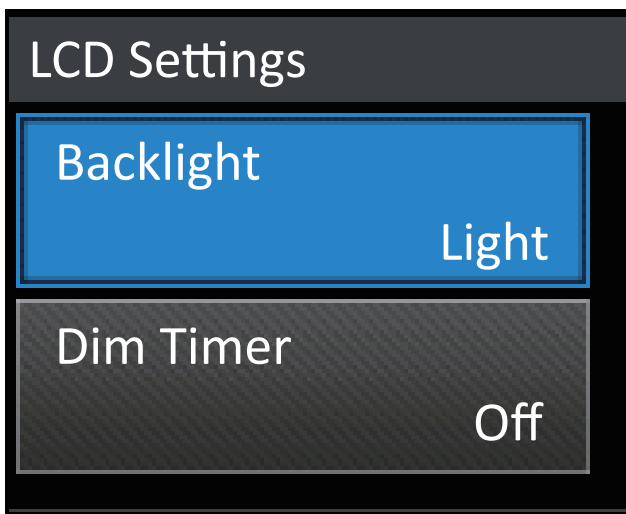

6. Press ▲ or ▼ to display the [Med] option, and then press [Med].

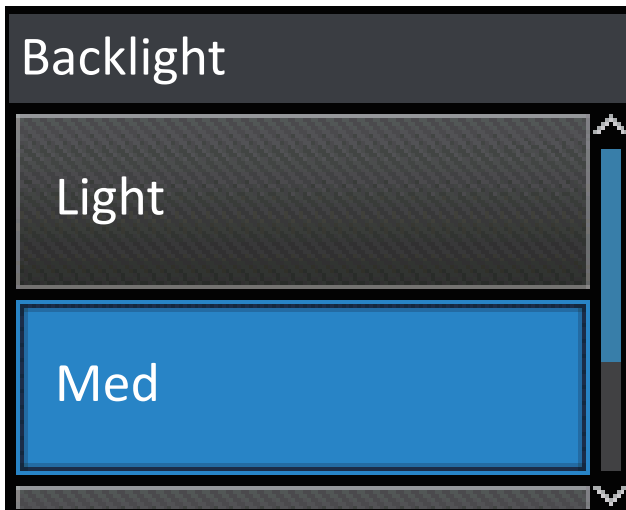

7. Press .

---

 **Related Information**

- [Introduction to Your Brother Machine](#)
-

## Access Brother Utilities (Windows®)

**Brother Utilities** is an application launcher that offers convenient access to all Brother applications installed on your computer.

1. Do one of the following:

- (Windows® XP, Windows Vista®, Windows® 7, Windows Server® 2003, Windows Server® 2008 and Windows Server® 2008 R2)

Click  (**Start**) > **All Programs** > **Brother** > **Brother Utilities**.

- (Windows® 8 and Windows Server® 2012)

Tap or click  (**Brother Utilities**) either on the **Start** screen or the desktop.

- (Windows® 8.1 and Windows Server® 2012 R2)

Move your mouse to the lower left corner of the **Start** screen and click  (if you are using a touch-based device, swipe up from the bottom of the **Start** screen to bring up the **Apps** screen).

When the **Apps** screen appears, tap or click  (**Brother Utilities**).

2. Select your machine (where XXXX is the name of your model).

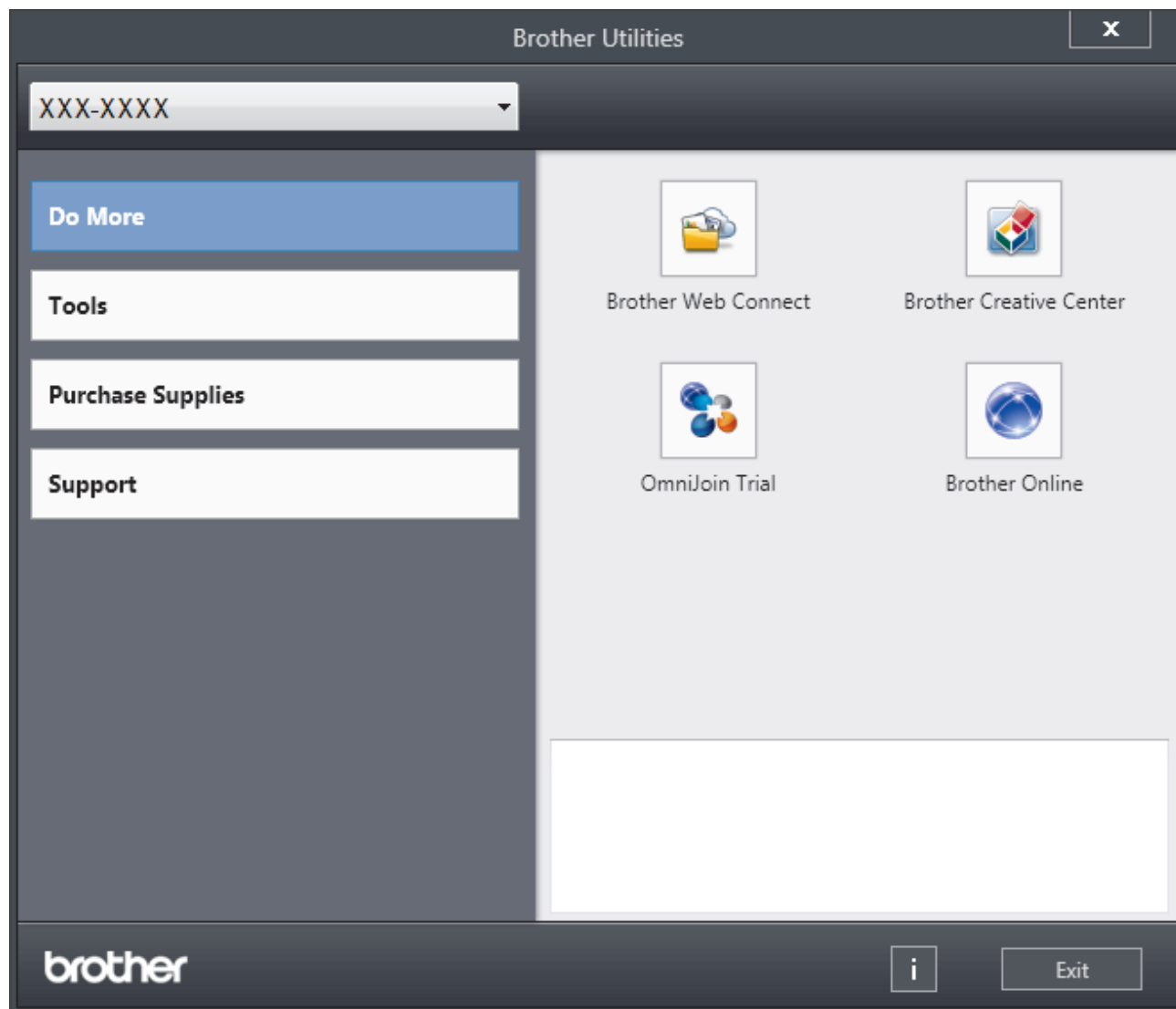

3. Choose the operation you want to use.





## Related Information

- [Introduction to Your Brother Machine](#)
  - [Uninstall the Brother Software and Drivers \(Windows®\)](#)
-

## Uninstall the Brother Software and Drivers (Windows®)

1. Do one of the following:

- (Windows® XP, Windows Vista®, Windows® 7, Windows Server® 2003, Windows Server® 2008 and Windows Server® 2008 R2)

Click  (**Start**) > **All Programs** > **Brother** > **Brother Utilities**.

- (Windows® 8 and Windows Server® 2012)

Tap or click  (**Brother Utilities**) either on the **Start** screen or the desktop.

- (Windows® 8.1 and Windows Server® 2012 R2)

Move your mouse to the lower left corner of the **Start** screen and click  (if you are using a touch-based device, swipe up from the bottom of the **Start** screen to bring up the **Apps** screen).

When the **Apps** screen appears, tap or click  (**Brother Utilities**).

2. Click the drop-down list, and then select your model name (if not already selected). Click **Tools** in the left navigation bar, and then click **Uninstall**.

Follow the instructions in the dialog box to uninstall the software and drivers.

### Related Information

- [Access Brother Utilities \(Windows®\)](#)

## Paper Handling

- [Load Paper](#)
- [Paper Settings](#)
- [Unprintable Area](#)
- [Recommended Print Media](#)
- [Using Special Paper](#)

## Load Paper

- [Load and Print Using the Paper Tray](#)
- [Load and Print Using the Multi-purpose Tray \(MP Tray\)](#)

## Load and Print Using the Paper Tray

- [Load and Print Plain Paper, Letterhead, Colored Paper, Thin Paper and Recycled Paper Using the Paper Tray](#)
- [Load and Print Thick Paper Using the Paper Tray](#)
- [Printing Problems](#)
- [Error and Maintenance Messages](#)

## Load and Print Plain Paper, Letterhead, Colored Paper, Thin Paper and Recycled Paper Using the Paper Tray

- If the Check Size setting is set to On and you pull the paper tray out of the machine, a message appears on the LCD asking if you want to change the paper size and paper type. Change the paper size and paper type settings if needed, following the LCD instructions.
  - When you load a different size and type of paper in the tray, you must change the Paper Size and Paper Type settings in the machine or on your computer, also.
1. Pull the paper tray completely out of the machine.

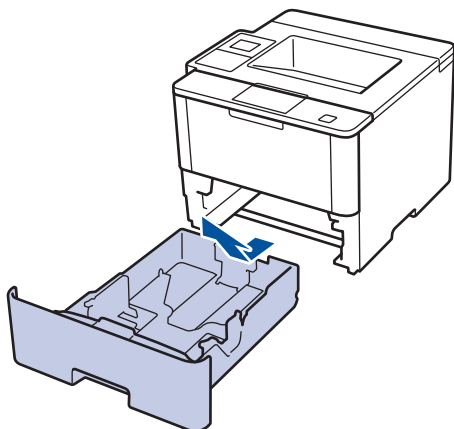

2. Press and slide the paper guides to fit the paper.  
Press the green release levers to slide the paper guides.

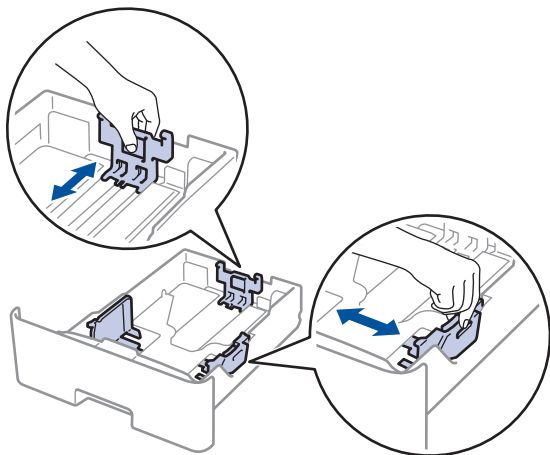



For Legal or Folio size paper, press the release button (1) in the bottom of the paper tray or the release lever (2) in the back of the tray, and then pull out the back of the paper tray. (Legal and Folio size paper are not available in some regions.)

For trays with a release button:

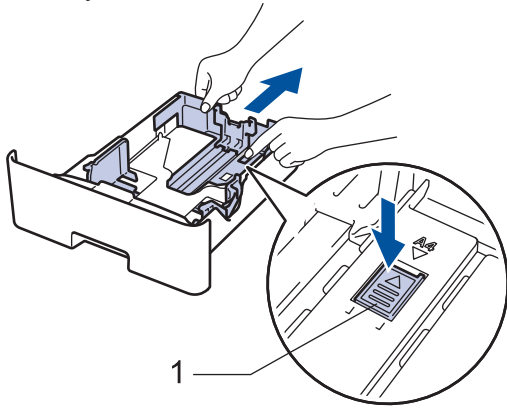

For trays with a release lever:

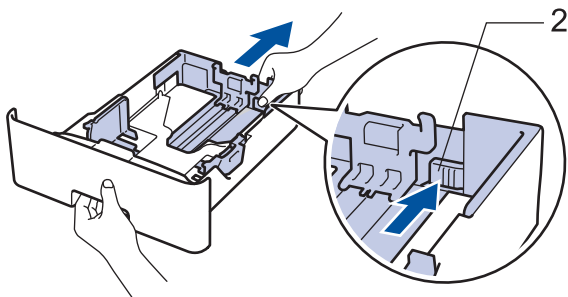

3. Fan the stack of paper well.
4. Load paper in the paper tray with the printing surface *face down*.

When you use Letterhead or Preprinted paper, load the paper in the correct orientation as shown in the illustrations.

### Paper Orientation for Letterhead and Preprinted Paper

For 1-sided printing

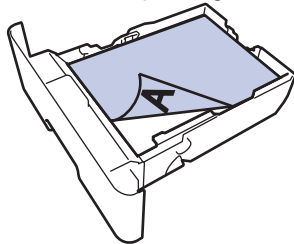

- face down
- top edge toward the front of the paper tray

For automatic 2-sided printing (long edge binding)

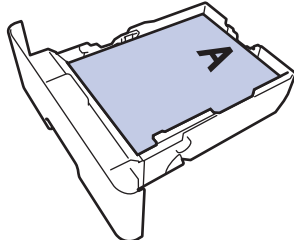

- face up
- bottom edge toward the front of the paper tray



- DO NOT load different sizes and types of paper in the paper tray at the same time. Doing this may cause the paper to jam or misfeed.
- When you use Letterhead or Preprinted paper for 2-sided printing, change the machine's setting by completing the following step:
  - (HL-L5000D/HL-L5100DN/HL-L5200DW/HL-L5200DWT/HL-L6200DW/HL-L6200DWT)  
Press [Paper Tray] > [2-sided] > [Single Image] > [2-sided Feed].
  - (HL-L6300DW)  
Press [Settings] > [Paper Tray] > [2-sided] > [Single Image] > [2-sided Feed].

5. Make sure the paper is below the maximum paper mark (▼▼▼).  
Overfilling the paper tray will cause paper jams.

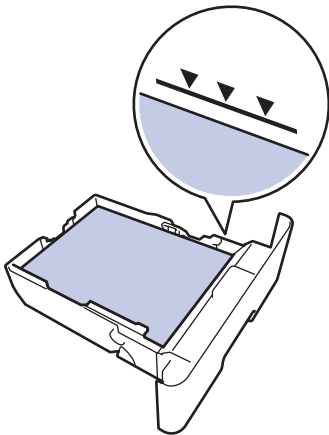

6. Slowly push the paper tray completely into the machine.  
7. Lift the support flap to prevent paper from sliding off the output tray.

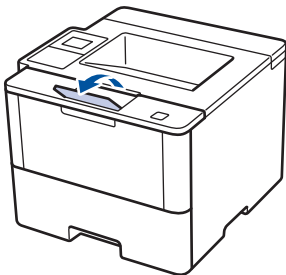

8. Send your print job to the machine.



Change your print preferences in the Print dialog box before sending the print job from your computer.



### Related Information

- [Load and Print Using the Paper Tray](#)



## Load and Print Thick Paper Using the Paper Tray

- If the Check Size setting is set to On and you pull the paper tray out of the machine, a message appears on the LCD asking if you want to change the paper size and paper type. Change the paper size and paper type settings if needed, following the LCD instructions.
  - When you load a different size and type of paper in the tray, you must change the Paper Size and Paper Type settings in the machine or on your computer, also.
1. Pull the paper tray completely out of the machine.

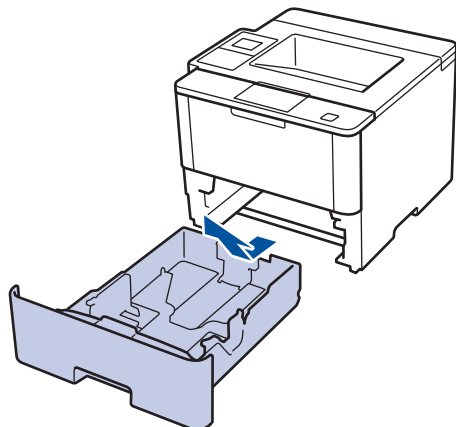

2. Press and slide the paper guides to fit the paper.  
Press the green release levers to slide the paper guides.

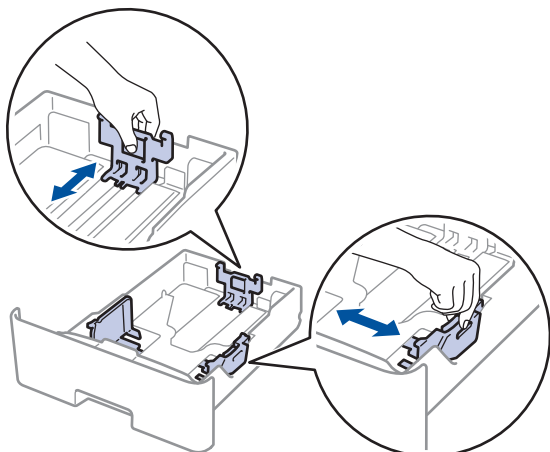



For Legal or Folio size paper, press the release button (1) in the bottom of the paper tray or the release lever (2) in the back of the tray, and then pull out the back of the paper tray. (Legal and Folio size paper are not available in some regions.)

For trays with a release button:

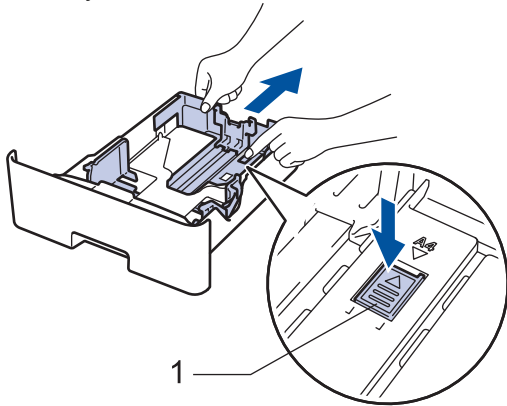

For trays with a release lever:

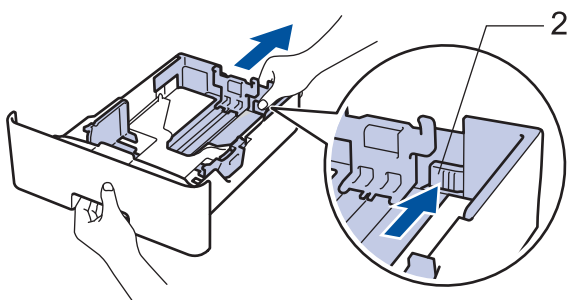

3. Fan the stack of paper well.
4. Load paper in the paper tray with the printing surface *face down*.



**DO NOT** load different sizes and types of paper in the paper tray at the same time. Doing this may cause the paper to jam or misfeed.

5. Make sure the paper is below the maximum paper mark (▼▼▼).  
Overfilling the paper tray will cause paper jams.

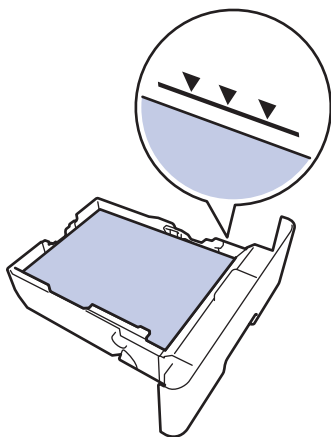

6. Slowly push the paper tray completely into the machine.
7. Open the machine's back cover (the face up output tray).

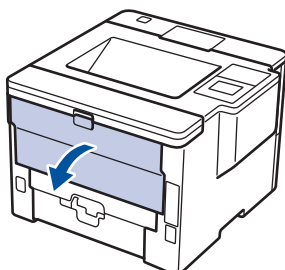

---

8. Open the paper stopper (Available only for certain models).

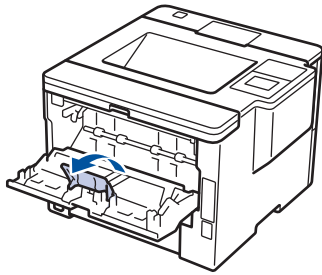

9. Send your print job to the machine.



---

Change your print preferences in the Print dialog box before sending the print job from your computer.

---

10. Close the paper stopper.

11. Close the back cover (the face up output tray) until it locks in the closed position.



### Related Information

- [Load and Print Using the Paper Tray](#)
-

## Load and Print Using the Multi-purpose Tray (MP Tray)

You can load up to ten envelopes, letterhead, colored paper, thin or thick paper, recycled paper, Bond paper, labels, or up to 50 sheets of plain paper in the MP tray.

- [Load and Print Plain Paper, Letterhead, Colored Paper, Thin Paper, Recycled Paper and Bond Paper in the MP Tray](#)
- [Load and Print Thick Paper and Labels Using the MP Tray](#)
- [Load and Print on Envelopes Using the MP Tray](#)
- [Printing Problems](#)
- [Error and Maintenance Messages](#)

## Load and Print Plain Paper, Letterhead, Colored Paper, Thin Paper, Recycled Paper and Bond Paper in the MP Tray

When you load a different size and type of paper in the tray, you must change the Paper Size and Paper Type settings in the machine or on your computer, also.

1. Lift the support flap to prevent paper from sliding off the face down output tray.

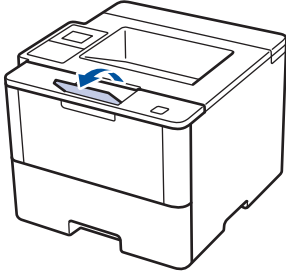

2. Open the MP tray and lower it gently.

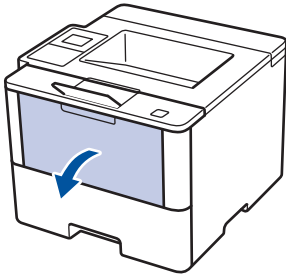

3. Pull out the MP tray support (1) and unfold the flap (2).

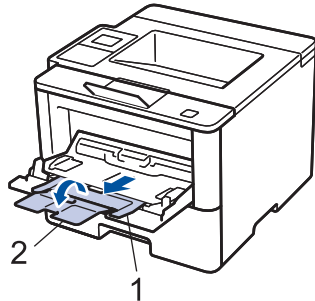

4. Slide the MP tray paper guides to fit the width of the paper you are using. If the paper guide on the right side has a lever, press it and slide the paper guide.

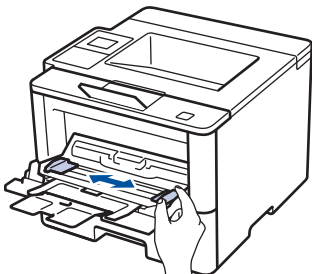

5. Load paper with the printing surface *face up* in the MP tray. When you use Letterhead or Preprinted paper, load the paper in the correct orientation as shown in the illustrations.

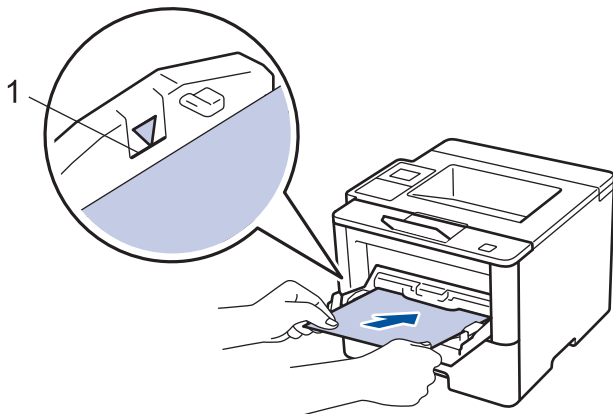

 Make sure the paper is below the maximum paper mark (1).

## Paper Orientation for Letterhead and Preprinted Paper

For 1-sided printing

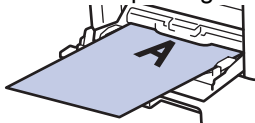

- face up
- top edge first

For automatic 2-sided printing (long edge binding)

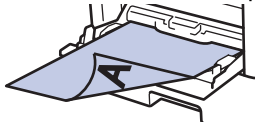

- face down
- bottom edge first

 When you use Letterhead or Preprinted paper for 2-sided printing, change the machine's setting by completing the following step:

- (HL-L5000D/HL-L5100DN/HL-L5200DW/HL-L5200DWT/HL-L6200DW/HL-L6200DWT)  
Press [Paper Tray] > [2-sided] > [Single Image] > [2-sided Feed].
- (HL-L6300DW)  
Press [Settings] > [Paper Tray] > [2-sided] > [Single Image] > [2-sided Feed].

6. Send your print job to the machine.

 Change your print preferences in the Print dialog box before sending the print job from your computer.

### Related Information

- [Load and Print Using the Multi-purpose Tray \(MP Tray\)](#)

## Load and Print Thick Paper and Labels Using the MP Tray

When the back cover (face up output tray) is pulled down, the machine has a straight paper path from the MP tray through to the back of the machine. Use this paper feed and output method when you print on thick paper or labels.

When you load a different size and type of paper in the tray, you must change the Paper Size and Paper Type settings in the machine or on your computer, also.

1. Open the machine's back cover (the face up output tray).

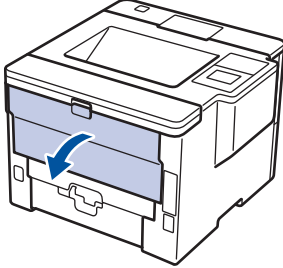

2. Open the paper stopper (Available only for certain models).

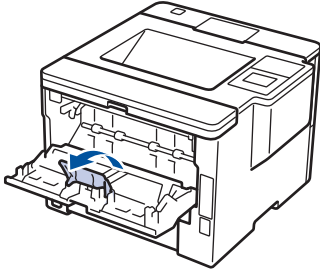

3. On the front of the machine, open the MP tray and lower it gently.

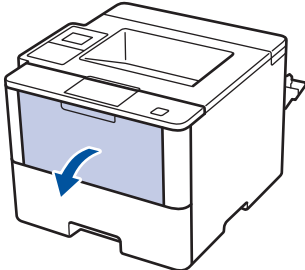

4. Pull out the MP tray support (1) and unfold the flap (2).

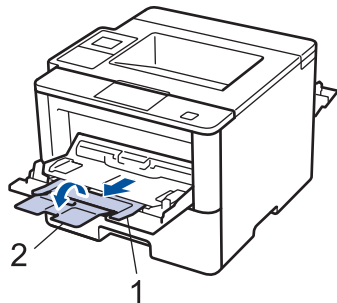

5. Slide the MP tray paper guides to fit the width of the paper that you are using. If the paper guide on the right side has a lever, press it and slide the paper guide.

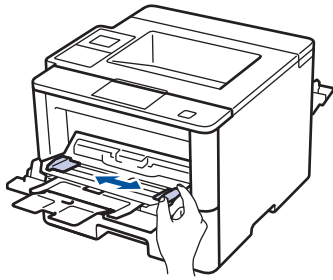

6. Load paper or labels in the MP tray.

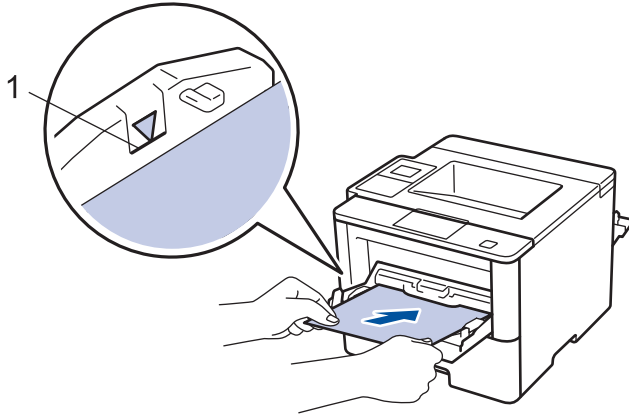

- 
- Make sure the paper is below the maximum paper mark (1).
  - Load paper into the MP tray with the printing surface face up.
- 

7. Send your print job to the machine.



---

Change your print preferences in the Print screen before sending the print job from your computer.

---

8. Close the paper stopper.

9. Close the back cover (the face up output tray) until it locks in the closed position.



### Related Information

- [Load and Print Using the Multi-purpose Tray \(MP Tray\)](#)
-



## Load and Print on Envelopes Using the MP Tray

You can load up to ten envelopes in the MP tray.

Before loading, press the corners and sides of the envelopes to make them as flat as possible.

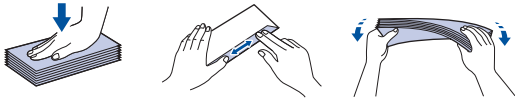

When you load a different size and type of paper in the tray, you must change the Paper Size and Paper Type settings in the machine or on your computer, also.

1. Open the machine's back cover (the face up output tray).

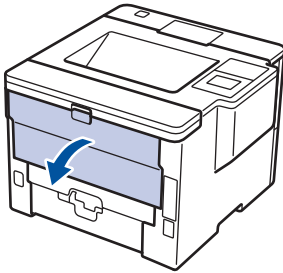

2. Open the paper stopper (Available only for certain models).

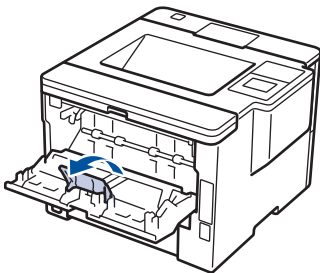

3. On the front of the machine, open the MP tray and lower it gently.

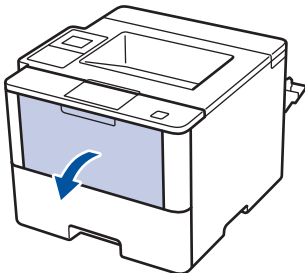

4. Pull out the MP tray support (1) and unfold the flap (2).

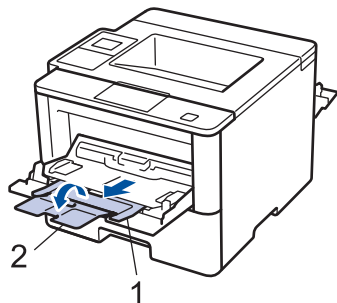

5. Slide the MP tray paper guides to fit the width of the envelopes that you are using. If the paper guide on the right side has a lever, press it and slide the paper guide.

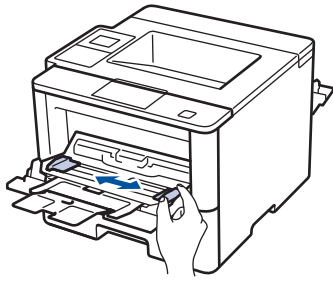

6. Load envelopes in the MP tray.

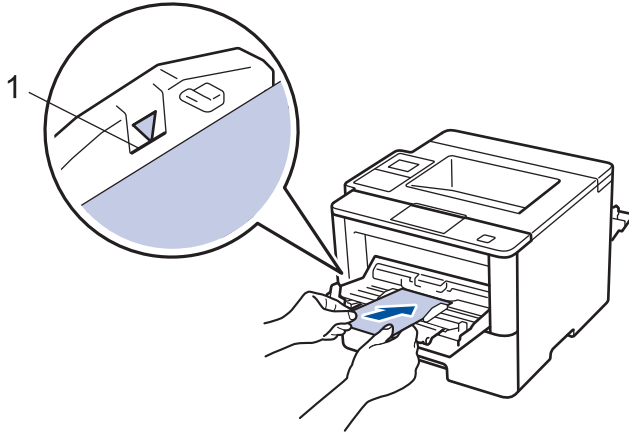

 Load up to 10 envelopes in the MP tray with the printing surface face up. Make sure the envelopes are below the maximum paper mark (1). Loading more than 10 envelopes may cause paper jams.

7. Send your print job to the machine.

 Change your print preferences in the Print dialog box before sending the print job from your computer.

Settings	Options for Envelopes
<b>Paper Size</b>	Com-10 DL C5 Monarch
<b>Media Type</b>	Envelopes Env. Thick Env. Thin

8. Close the paper stopper.

9. Close the back cover (the face up output tray) until it locks in the closed position.

### Related Information

- [Load and Print Using the Multi-purpose Tray \(MP Tray\)](#)

## Paper Settings

- [Change the Paper Size and Paper Type](#)
- [Change the Check Paper Size Setting](#)

## Change the Paper Size and Paper Type

When you change the size and type of the paper you load in the tray, you must change the Paper Size and Paper Type settings on the LCD at the same time.



>> [HL-L5000D/HL-L5100DN/HL-L5200DW/HL-L5200DWT/HL-L6200DW/HL-L6200DWT](#)

>> [HL-L6300DW](#)

### HL-L5000D/HL-L5100DN/HL-L5200DW/HL-L5200DWT/HL-L6200DW/HL-L6200DWT

1. Press ▲ or ▼ to select the [Paper Tray] option, and then press **OK**.
2. Press ▲ or ▼ to select the [Paper Type] option, and then press **OK**.
3. Press ▲ or ▼ to select the paper tray that you want to change, and then press **OK**.
4. Press ▲ or ▼ to select the paper type you want, and then press **OK**.
5. Press **Back**.
6. Press ▲ or ▼ to select the [Paper Size] option, and then press **OK**.
7. Press ▲ or ▼ to select the paper tray that you want to change, and then press **OK**.
8. Press ▲ or ▼ to select the paper size you want, and then press **Go**.

### HL-L6300DW

1. Press  [Settings] > [Paper Tray] > [Paper Type].
2. Press ▲ or ▼ to display the paper tray options, and then press the option you want.
3. Press ▲ or ▼ to display the paper type options, and then press the option you want.
4. Press .
5. Press ▲ or ▼ to display the [Paper Size] option.
6. Press ▲ or ▼ to display the paper tray options, and then press the option you want.
7. Press ▲ or ▼ to display the paper size options, and then press the option you want.
8. Press .

### Related Information

- [Paper Settings](#)

## Change the Check Paper Size Setting

When you turn on your machine's Check Size setting, the machine displays a message when you remove a paper tray or load paper using the MP tray, asking if you changed the paper size and paper type.

The default setting is On.



>> [HL-L5000D/HL-L5100DN/HL-L5200DW/HL-L5200DWT/HL-L6200DW/HL-L6200DWT](#)

>> [HL-L6300DW](#)

### HL-L5000D/HL-L5100DN/HL-L5200DW/HL-L5200DWT/HL-L6200DW/HL-L6200DWT

1. Press ▲ or ▼ to select the [Paper Tray] option, and then press **OK**.
2. Press ▲ or ▼ to select the [Check Size] option, and then press **OK**.
3. Press ▲ or ▼ to select the [On] or [Off] option, and then press **Go**.

### HL-L6300DW

1. Press  [Settings] > [Paper Tray] > [Check Size].
2. Press [On] or [Off].
3. Press .



### Related Information

- [Paper Settings](#)

## Unprintable Area

The figures below show maximum unprintable areas from the edges of the most commonly-used paper sizes. The measurements may vary depending on the paper size or settings in the application you are using.

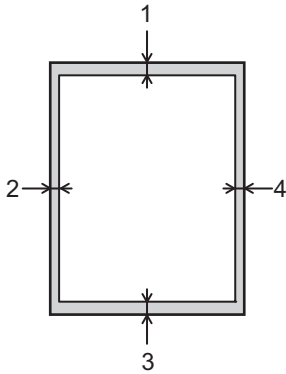

Do not attempt to print into these areas; your output will not reflect anything in these areas.

Usage	Document Size	Top (1) Bottom (3)	Left (2) Right (4)
Print	Letter	0.16 in. (4.23 mm)	0.16 in. (4.23 mm)
	A4	0.16 in. (4.23 mm)	0.16 in. (4.23 mm)
	Legal	0.16 in. (4.23 mm)	0.16 in. (4.23 mm)



### Related Information

- [Paper Handling](#)

## Recommended Print Media

To get the best print quality, we recommend using the paper listed in the table.

Paper Type	Item
Plain Paper	Xerox 4200DP 20 lb
	Hammermill Laser Print (24 lb = 90 g/m <sup>2</sup> )
Recycled Paper	No specific brand recommended
Labels	Avery laser labels white #5160
Envelopes	No specific brand recommended



### Related Information

- [Paper Handling](#)

## Using Special Paper

Always test paper samples before purchasing them to ensure desirable performance.

- DO NOT use inkjet paper; it may cause a paper jam or damage your machine.
- If you use bond paper, paper with a rough surface, or paper that is wrinkled or creased, the paper may exhibit degraded performance.

Store paper in its original packaging and keep it sealed. Keep the paper flat and away from moisture, direct sunlight and heat.

### IMPORTANT

Some types of paper may not perform well or may cause damage to your machine.

DO NOT use paper:

- that is highly textured
- that is extremely smooth or shiny
- that is curled or warped
- that is coated or has a chemical finish
- that is damaged, creased or folded
- that exceeds the recommended weight specification in this guide
- with tabs and staples
- with letterheads using low temperature dyes or thermography
- that is multipart or carbonless
- that is designed for inkjet printing

If you use any of the types of paper listed above, they may damage your machine. This damage is not covered under any Brother warranty or service agreement.



### Related Information

- [Paper Handling](#)



## Print

- [Print from Your Computer \(Windows®\)](#)
- [Print from Your Computer \(Macintosh\)](#)
- [Print One Page Duplicates on Different Types of Paper](#)
- [Cancel a Print Job](#)
- [Test Print](#)

## Print from Your Computer (Windows®)

- [Print a Document \(Windows®\)](#)
- [Print More Than One Page on a Single Sheet of Paper \(N in 1\) \(Windows®\)](#)
- [Print as a Poster \(Windows®\)](#)
- [Print on Both Sides of the Paper \(Windows®\)](#)
- [Print as a Booklet \(Windows®\)](#)
- [Secure Print \(Windows®\)](#)
- [Use a Macro from Your Computer \(Windows®\)](#)
- [Use a Preset Print Profile \(Windows®\)](#)
- [Change the Default Print Settings \(Windows®\)](#)
- [Print a Document Using the BR-Script3 Printer Driver \(PostScript® 3™ Language Emulation\) \(Windows®\)](#)
- [Monitor the Status of the Machine from Your Computer \(Windows®\)](#)
- [Print Settings \(Windows®\)](#)

## Print a Document (Windows®)

1. Select the print command in your application.
2. Select **Brother XXX-XXXX** (where XXXX is the name of your model), and then click the printing properties or preferences button.

The printer driver window appears.

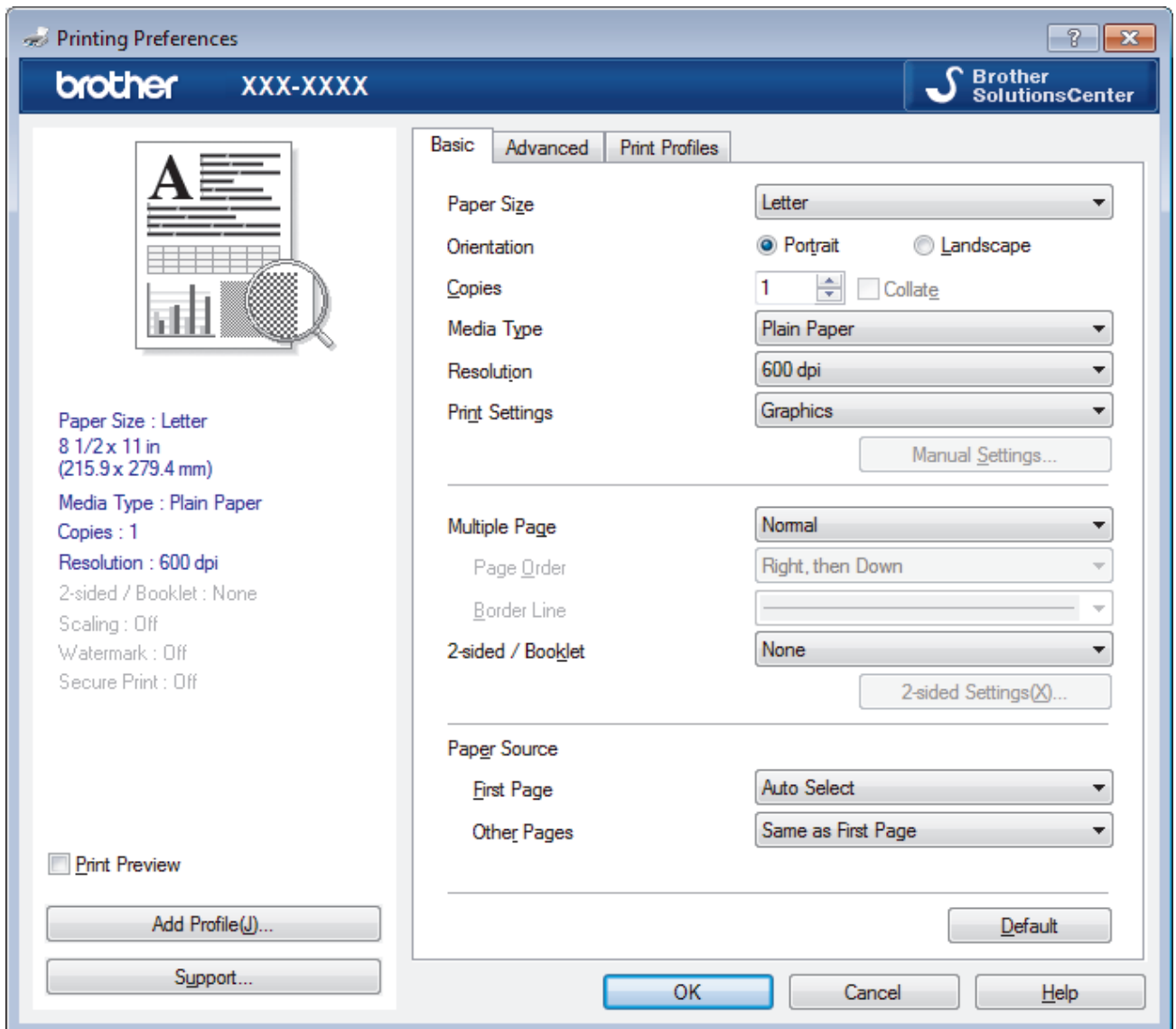

3. Make sure you have loaded the correct size paper in the paper tray.
4. Click the **Paper Size** drop-down list, and then select your paper size.
5. In the **Orientation** field, select the **Portrait** or **Landscape** option to set the orientation of your printout.



If your application contains a similar setting, we recommend that you set the orientation using the application.

6. Type the number of copies (1-999) you want in the **Copies** field.
7. Click the **Media Type** drop-down list, and then select the type of paper you are using.
8. To print multiple pages on a single sheet of paper or print one page of your document on multiple sheets, click the **Multiple Page** drop-down list, and then select your options.
9. Change other printer settings if needed.
10. Click **OK**.
11. Complete your print operation.



---

## Related Information

---

- [Print from Your Computer \(Windows®\)](#)
  - [Print Settings \(Windows®\)](#)
-

## Print More Than One Page on a Single Sheet of Paper (N in 1) (Windows®)



1. Select the print command in your application.
2. Select **Brother XXX-XXXX** (where XXXX is the name of your model), and then click the printing properties or preferences button.  
The printer driver window appears.
3. In the **Orientation** field, select the **Portrait** or **Landscape** option to set the orientation of your printout.



If your application contains a similar setting, we recommend that you set the orientation using the application.

4. Click the **Multiple Page** drop-down list, and then select the **2 in 1**, **4 in 1**, **9 in 1**, **16 in 1**, or **25 in 1** option.
5. Click the **Page Order** drop-down list, and then select your page order.
6. Click the **Border Line** drop-down list, and then select your border line type.
7. Change other printer settings if needed.
8. Click **OK**.
9. Complete your print operation.



### Related Information

- [Print from Your Computer \(Windows®\)](#)
- [Print Settings \(Windows®\)](#)

## Print as a Poster (Windows®)

Enlarge your print size and print the document in poster mode.

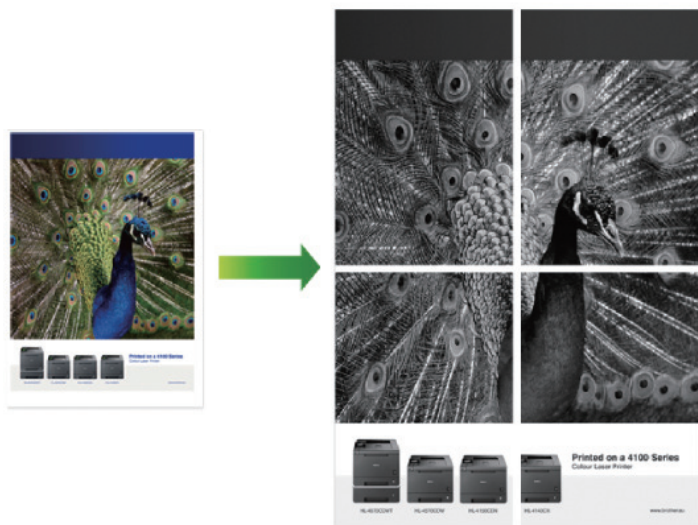

1. Select the print command in your application.
2. Select **Brother XXX-XXXX** (where XXXX is the name of your model), and then click the printing properties or preferences button.  
The printer driver window appears.
3. Click the **Multiple Page** drop-down list, and then select the **1 in 2x2 Pages**, **1 in 3x3 Pages**, **1 in 4x4 Pages**, or **1 in 5x5 Pages** option.
4. Select the **Print cut-out line** check box, if needed.

### Print cut-out line

Prints a faint cut-out line around the printable area so that you can easily cut it out.

5. Change other printer settings if needed.
6. Click **OK**.
7. Complete your print operation.



### Related Information

- [Print from Your Computer \(Windows®\)](#)
- [Print Settings \(Windows®\)](#)

## Print on Both Sides of the Paper (Windows®)

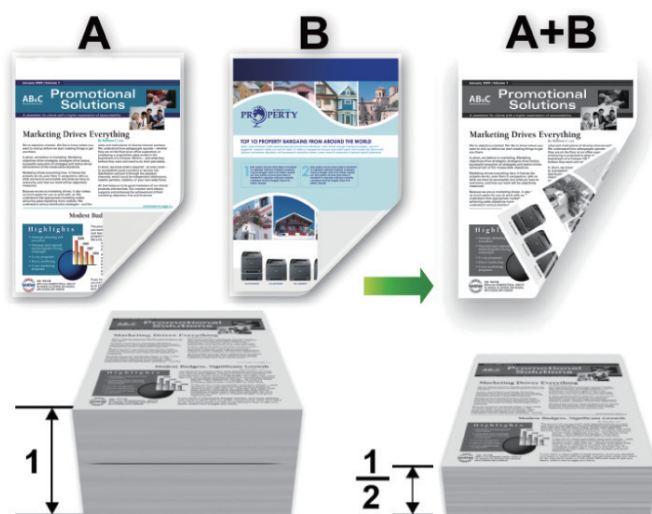

- Select Letter, Legal, Mexico Legal, India Legal or Folio sized paper when using the automatic 2-sided printing function.
  - Make sure the back cover is closed.
  - If paper is curled, straighten it and put it back in the paper tray.
  - Use regular paper or thin paper. DO NOT use bond paper.
  - If the paper is too thin, it may wrinkle.
  - When you use the manual 2-sided printing function, it is possible there may be paper jams or poor print quality.
1. Select the print command in your application.
  2. Select **Brother XXX-XXXX** (where XXXX is the name of your model), and then click the printing properties or preferences button.  
The printer driver window appears.
  3. In the **Orientation** field, select the **Portrait** or **Landscape** option to set the orientation of your printout.



If your application contains a similar setting, we recommend that you set the orientation using the application.

4. Click the **2-sided / Booklet** drop-down list, and then select the **2-sided** or **2-sided (Manual)** option.

Option	Description
<b>2-sided</b> (Available only for certain models)	Automatically prints on both sides of the paper.
<b>2-sided (Manual)</b>	The machine prints all the even-numbered pages on one side of the paper first. Then, the printer driver instructs you (with a pop-up message) to reinsert the paper.

5. Click the **2-sided Settings** button.
6. Select one of the options from the **2-sided Type** menu.  
When 2-sided is selected, four types of 2-sided binding are available for each orientation:

Option for Portrait	Description
---------------------	-------------

Long Edge (Left)

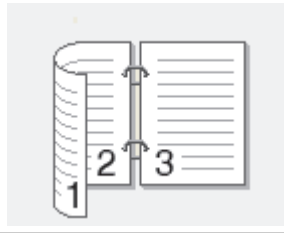

Long Edge (Right)



Short Edge (Top)

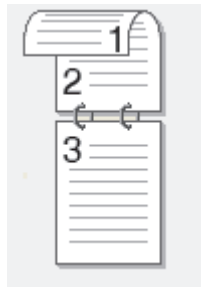

Short Edge (Bottom)

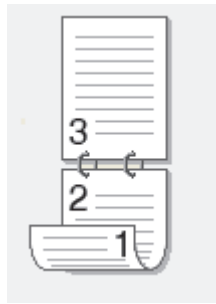

Option for Landscape	Description
----------------------	-------------

Long Edge (Top)

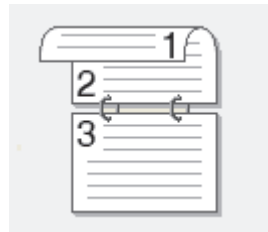

Long Edge (Bottom)

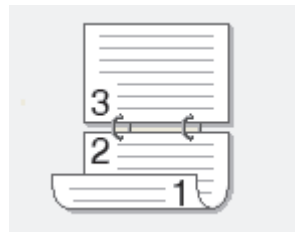

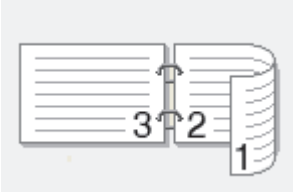
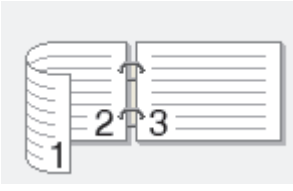

---

Option for Landscape	Description
<b>Short Edge (Right)</b>	
<b>Short Edge (Left)</b>	

7. Select the **Binding Offset** check box if you want to specify the offset for binding in inches or millimeters.
8. Click **OK**.
9. Change other printer settings if needed.
10. Do one of the following:
  - For automatic 2-sided printing, click **OK** again, and then complete your print operation.
  - For manual 2-sided printing, click **OK** again and follow the on-screen instructions.

If the paper is not feeding correctly, it may be curled. Remove the paper, straighten it, and put it back in the paper tray.



### Related Information

- [Print from Your Computer \(Windows®\)](#)
  - [Print Settings \(Windows®\)](#)
-

## Print as a Booklet (Windows®)

Use this option to print a document in booklet format using 2-sided printing. The document's pages will be arranged according to the correct page number and will allow you to fold the print output at the center, without having to change the order of the printed pages.

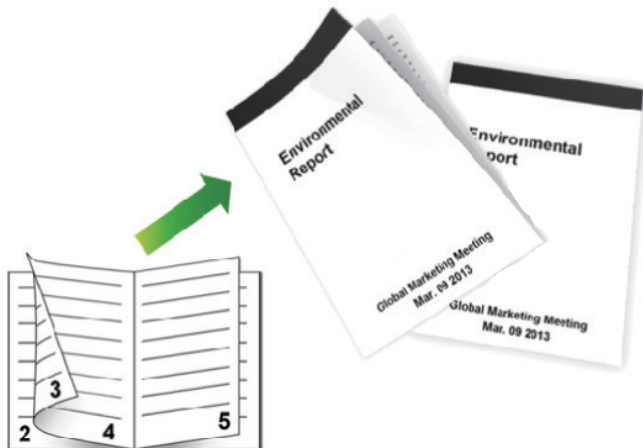

- Select Letter, Legal, Mexico Legal, India Legal or Folio sized paper when using the automatic 2-sided printing function.
  - Make sure the back cover is closed.
  - If paper is curled, straighten it and put it back in the paper tray.
  - Use regular paper or thin paper. DO NOT use bond paper.
  - If the paper is too thin, it may wrinkle.
  - When you use the manual 2-sided printing function, it is possible there may be paper jams or poor print quality.
1. Select the print command in your application.
  2. Select **Brother XXX-XXXX** (where XXXX is the name of your model), and then click the printing properties or preferences button.  
The printer driver window appears.
  3. In the **Orientation** field, select the **Portrait** or **Landscape** option to set the orientation of your printout.



If your application contains a similar setting, we recommend that you set the orientation using the application.

4. Click the **2-sided / Booklet** drop-down list, and then select the **Booklet** or **Booklet (Manual)** option.

Option	Description
<b>Booklet</b> (Available only for certain models)	Automatically prints as a booklet.
<b>Booklet (Manual)</b>	Manually prints as a booklet.

5. Click the **2-sided Settings** button.
6. Select one of the options from the **2-sided Type** menu.  
There are two types of 2-sided binding directions available for each orientation:

Option for Portrait	Description
---------------------	-------------

<b>Left Binding</b>	
---------------------	-----------------------------------------------------------------------------------

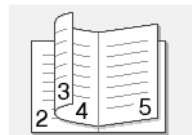

<b>Right Binding</b>	
----------------------	-----------------------------------------------------------------------------------

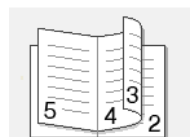

Option for Landscape	Description
----------------------	-------------

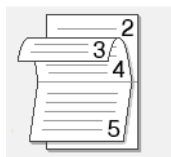

<b>Top Binding</b>	
--------------------	-----------------------------------------------------------------------------------

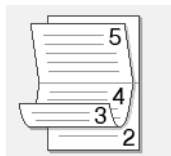

<b>Bottom Binding</b>	
-----------------------	-----------------------------------------------------------------------------------



7. Select one of the options from the **Booklet Printing Method** menu.

Option	Description
<b>All Pages at Once</b>	Every page will be printed in booklet format (four pages to every piece of paper, two pages per side). Fold your printout in the center to create the booklet. 
<b>Divide into Sets</b>	This option prints the whole booklet in smaller individual booklet sets, allowing you to fold at the center of the smaller individual booklet sets without having to change the order of the printed pages. You can specify the number of sheets in each smaller booklet set (from 1-15). This option can be helpful when folding a printed booklet that has a large number of pages. 

8. Select the **Binding Offset** check box if you want to specify the offset for binding in inches or millimeters.
9. Click **OK**.
10. Change other printer settings if needed.
11. Do one of the following:
- For automatic booklet printing, click **OK** again, and then complete your print operation.
  - For manual booklet printing, click **OK** again and follow the on-screen instructions.

### ✓ Related Information

- [Print from Your Computer \(Windows®\)](#)
- [Print Settings \(Windows®\)](#)

## Secure Print (Windows®)

Use Secure Print to ensure that confidential or sensitive documents do not print until you enter a password on the machine's control panel.

- The secure data is deleted from the machine when you turn off the machine.

>> [HL-L5000D/HL-L5100DN/HL-L5200DW/HL-L5200DWT/HL-L6200DW/HL-L6200DWT](#)

>> [HL-L6300DW](#)

### HL-L5000D/HL-L5100DN/HL-L5200DW/HL-L5200DWT/HL-L6200DW/HL-L6200DWT

1. Select the print command in your application.
2. Select **Brother XXX-XXXX** (where XXXX is the name of your model), and then click the printing properties or preferences button.  
The printer driver window appears.
3. Click the **Advanced** tab.
4. Click the **Settings** button in the **Secure Print** field.
5. Select the **Secure Print** check box.
6. Type your four-digit password in the **Password** field, and then click **OK**.



You must set a separate password for each document.

7. Click **OK**.
8. Complete your print operation.
9. On the machine's control panel, press **Secure**.
10. Press **▲** or **▼** to display your user name, and then press **OK**.  
The LCD displays the list of secured jobs for that name.
11. Press **▲** or **▼** to display the job, and then press **OK**.
12. Enter your four-digit password.  
To enter each digit, press **▲** or **▼** to select a number, and then press **OK**.
13. Press **▲** or **▼** to select the [Print] option, and then press **OK**.
14. Press **▲** or **▼** to enter the number of copies you want.
15. Press **OK**.

The machine prints the data.

After you print the secured data, it will be cleared from the machine's memory.

### HL-L6300DW

1. Select the print command in your application.
2. Select **Brother XXX-XXXX** (where XXXX is the name of your model), and then click the printing properties or preferences button.  
The printer driver window appears.
3. Click the **Advanced** tab.
4. Click the **Settings** button in the **Secure Print** field.
5. Select the **Secure Print** check box.
6. Type your four-digit password in the **Password** field, and then click **OK**.



You must set a separate password for each document.

7. Click **OK**.

---

8. Complete your print operation.

9. On the machine's control panel, press  [Functions].

10. Press [Secure].

11. Press ▲ or ▼ to display user names, and then press your user name.

The LCD displays the list of secured jobs for that name.

12. Press ▲ or ▼ to display the print job you want to print, and then press it.

13. Enter your four-digit password, and then press [OK].

14. Enter the number of copies you want.

15. Press [Start].

The machine prints the data.

After you print the secured data, it will be cleared from the machine's memory.



### Related Information

- [Print from Your Computer \(Windows®\)](#)

## Use a Macro from Your Computer (Windows®)

If you have stored the electronic forms (macros) in your machine's memory, you can use the macro to print the data as an overlay on the print job you want.

1. Select the print command in your application.
2. Select **Brother XXX-XXXX** (where XXXX is the name of your model), and then click the printing properties or preferences button.  
The printer driver window appears.
3. Click the **Advanced** tab.
4. Click the **Other Print Options** button.
5. Select **Macro**.
6. Click the **Macro Settings** button.
7. Enter **Macro ID** and **Macro Name** you want to use.
8. Select **Insert Macro Command**.
9. Select the page to overlay the macro data.

Option	Description
<b>All Pages</b>	Lets you insert the macro onto all pages.
<b>Page</b>	Lets you insert the macro onto a specific page. Select this option, and then enter a page number within the range 1 to 255.
<b>Add to Top of Page</b>	Send the macro data to the top of the page.
<b>Add to End of Page</b>	Send the macro data to the bottom of the page.



When **Booklet** has been selected, the **Page** setting in **Insert Macro Command** is disabled.

10. Click **OK**.
11. Click **OK** to return to the printer driver window.
12. Click **OK**.
13. Complete your print operation.  
The macro data is printed as an overlay.



### Related Information

- [Print from Your Computer \(Windows®\)](#)
- [Print One Page Duplicates on Different Types of Paper](#)

## Use a Preset Print Profile (Windows®)

**Print Profiles** are presets designed to give you quick access to frequently-used printing configurations.

1. Select the print command in your application.
2. Select **Brother XXX-XXXX** (where XXXX is the name of your model), and then click the printing properties or preferences button.

The printer driver window appears.

3. Click the **Print Profiles** tab.

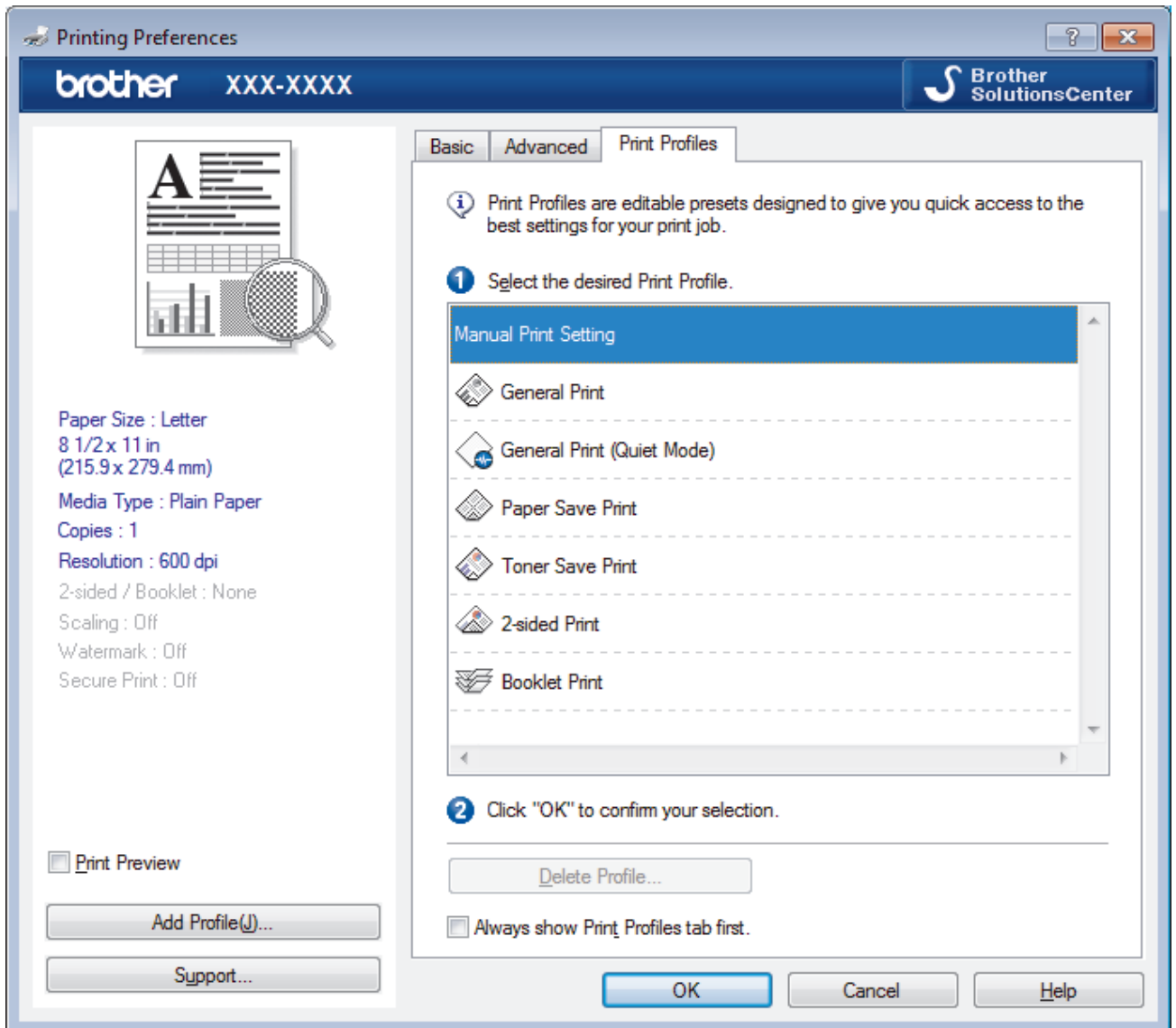

4. Select your profile from the print profile list.  
The profile settings are shown on the left side of the printer driver window.
5. Do one of the following:
  - If the settings are correct for your print job, click **OK**.
  - To change the settings, go back to the **Basic** or **Advanced** tab, change settings, and then click **OK**.



To display the **Print Profiles** tab at the front of the window the next time you print, select the **Always show Print Profiles tab first.** check box.



### Related Information

- [Print from Your Computer \(Windows®\)](#)

- 
- [Create or Delete Your Print Profile \(Windows®\)](#)
  - [Print Settings \(Windows®\)](#)
-



## Create or Delete Your Print Profile (Windows®)

Add up to 20 new print profiles with customized settings.

1. Select the print command in your application.
2. Select **Brother XXX-XXXX** (where XXXX is the name of your model), and then click the printing properties or preferences button.  
The printer driver window appears.
3. Click the **Basic** tab and the **Advanced** tab, and configure the print settings you want for the new Print Profile.
4. Click the **Print Profiles** tab.
5. Do one of the following:

### To create a new print profile:

- a. Click **Add Profile**.  
The **Add Profile** dialog box appears.
- b. Type the new profile name in the **Name** field.
- c. Click the icon you want to use to represent this profile from the icon list.
- d. Click **OK**.

The new Print Profile name is added to the list in the **Print Profiles** tab.

### To delete a print profile that you created:

- a. Click **Delete Profile**.  
The **Delete Profile** dialog box appears.
- b. Select the profile you want to delete.
- c. Click **Delete**.
- d. Click **Yes**.
- e. Click **Close**.





### Related Information

- [Use a Preset Print Profile \(Windows®\)](#)

## Change the Default Print Settings (Windows®)

When you change print settings from within a program, the changes apply only to the items you are printing in that program, at that time. To select print settings to use for all of your Windows® programs, all the time, use these steps to change the default print settings.

1. Do one of the following:
  - (For Windows® XP and Windows Server® 2003)  
Click **Start > Printers and Faxes**.
  - (For Windows Vista® and Windows Server® 2008)  
Click  (**Start**) > **Control Panel > Hardware and Sound > Printers**.
  - (For Windows® 7 and Windows Server® 2008 R2)  
Click  (**Start**) > **Devices and Printers**.
  - (For Windows® 8)  
Move your mouse to the lower right corner of your desktop. When the menu bar appears, click **Settings**, and then click **Control Panel**. In the **Hardware and Sound** group, click **View devices and printers**.
  - (For Windows Server® 2012)  
Move your mouse to the lower right corner of your desktop. When the menu bar appears, click **Settings**, and then click **Control Panel**. In the **Hardware** group, click **View devices and printers**.
  - (For Windows Server® 2012 R2)  
Click **Control Panel** on the **Start** screen. In the **Hardware** group, click **View devices and printers**.
2. Right-click the **Brother XXX-XXXX** icon (where XXXX is your model name), and then select **Printer properties**. If printer driver options appear, select your printer driver.
3. Click the **General** tab, and then click the **Printing Preferences...** or **Preferences...** button.  
The printer driver dialog box appears.  

---

  - To configure the tray settings, click the **Device Settings** tab.
  - To change the printer port, click the **Ports** tab.

---
4. Select the print settings you want to use as defaults for all of your Windows® programs.
5. Click **OK**.
6. Close the printer properties dialog box.



### Related Information

- [Print from Your Computer \(Windows®\)](#)
- [Configure the Optional Tray Settings \(Windows®\)](#)
- [Print Settings \(Windows®\)](#)

## Configure the Optional Tray Settings (Windows®)

Access your machine's Properties to auto-detect your machine's Optional Tray and serial number.

The printer driver automatically detects the Optional Tray during the driver installation. If you added the Optional Tray after the driver installation, follow these steps.

1. Do one of the following:
  - (For Windows® XP and Windows Server® 2003)  
Click **Start > Printers and Faxes**.
  - (For Windows Vista® and Windows Server® 2008)  
Click  (**Start**) > **Control Panel > Hardware and Sound > Printers**.
  - (For Windows® 7 and Windows Server® 2008 R2)  
Click  (**Start**) > **Devices and Printers**.
  - (For Windows® 8)  
Move your mouse to the lower right corner of your desktop. When the menu bar appears, click **Settings**, and then click **Control Panel**. In the **Hardware and Sound** group, click **View devices and printers**.
  - (For Windows Server® 2012)  
Move your mouse to the lower right corner of your desktop. When the menu bar appears, click **Settings**, and then click **Control Panel**. In the **Hardware** group, click **View devices and printers**.
  - (For Windows Server® 2012 R2)  
Click **Control Panel** on the **Start** screen. In the **Hardware** group, click **View devices and printers**.
2. Right-click the **Brother XXX-XXXX** icon (where XXXX is your model name), and then select **Printer properties**. If printer driver options appear, select your printer driver.
3. Select the **Device Settings** tab.
4. Click the **Auto Detect** button.  
The Optional Tray and the machine's serial number are automatically detected.
5. Click the **Apply** button.

The **Auto Detect** function is not available under the following machine conditions:

- The machine power switch is off.
- The machine is in an error state.
- The machine is in a network shared environment.
- The cable is not connected to the machine correctly.



### Related Information

- [Change the Default Print Settings \(Windows®\)](#)

## Print a Document Using the BR-Script3 Printer Driver (PostScript® 3™ Language Emulation) (Windows®)

The BR-Script3 printer driver lets you print PostScript® data more clearly.

To install the PS driver (BR-Script3 printer driver), launch Brother's installation CD-ROM, select **Custom** in Select Machine section, and then check **PS Driver** check box.

1. Select the print command in your application.
2. Select **Brother XXX-XXXX BR-Script3** (where XXXX is the name of your model), and then click the printing properties or preferences button.

The printer driver window appears.

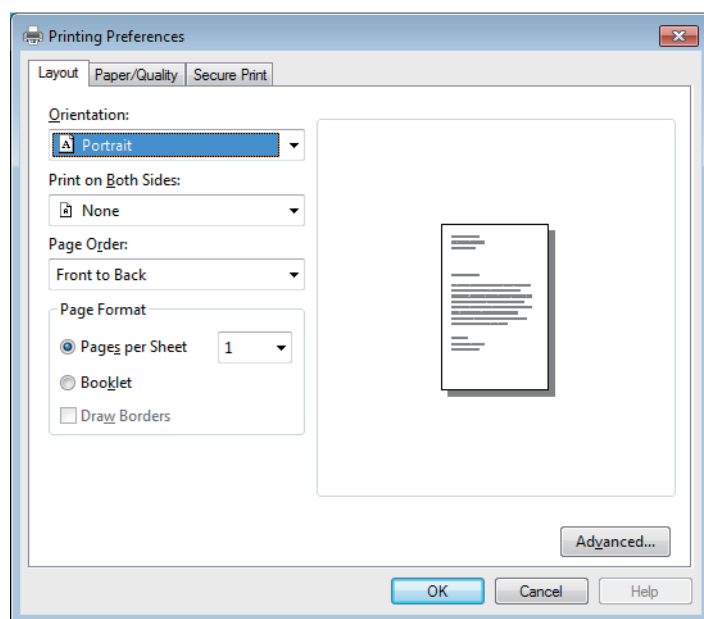



3. Click the **Layout**, **Paper/Quality**, or **Secure Print** tab to change basic print settings.  
Click the **Layout** or **Paper/Quality** tab, and then click the **Advanced...** button to change advanced print settings.
4. Click **OK**.
5. Complete your print operation.

### ✓ Related Information

- [Print from Your Computer \(Windows®\)](#)

## Monitor the Status of the Machine from Your Computer (Windows®)

The Status Monitor utility is a configurable software tool for monitoring the status of one or more devices, allowing you to get immediate notification of errors.

- To display the **Status Monitor** icon on your task tray, click the  button. The  (**Status Monitor**) icon will appear in the small window. Drag the  icon to the task tray.





- Do one of the following:
  - Double-click the  icon in the task tray.
  - (Windows® XP, Windows Vista®, Windows® 7, Windows Server® 2003, Windows Server® 2008 and Windows Server® 2008 R2)

Click  (**Start**) > **All Programs** > **Brother** > **Brother Utilities**.

Click the drop-down list and select your model name (if not already selected). Click **Tools** in the left navigation bar, and then click **Status Monitor**.

- (Windows® 8 and Windows Server® 2012)  
Click  (**Brother Utilities**), and then click the drop-down list and select your model name (if not already selected). Click **Tools** in the left navigation bar, and then click **Status Monitor**.
- (Windows® 8.1 and Windows Server® 2012 R2)

Move your mouse to the lower left corner of the **Start** screen and click  (if you are using a touch-based device, swipe up from bottom of the **Start** screen to bring up the **Apps** screen). When the **Apps** screen appears, tap or click  (**Brother Utilities**), and then click the drop-down list and select your model name (if not already selected). Click **Tools** in the left navigation bar, and then click **Status Monitor**.

### Troubleshooting

Click the **Troubleshooting** button to access the troubleshooting website.

### Visit the Genuine Supplies website

Click the **Visit the Genuine Supplies website** button for more information on Brother genuine supplies.



When you enable Status Monitor, if you selected Automatic Firmware Update during installation, this feature will detect and download any updates for your machine.

### ✓ Related Information

- [Print from Your Computer \(Windows®\)](#)
- [Printing Problems](#)

## Print Settings (Windows®)

### Basic Tab

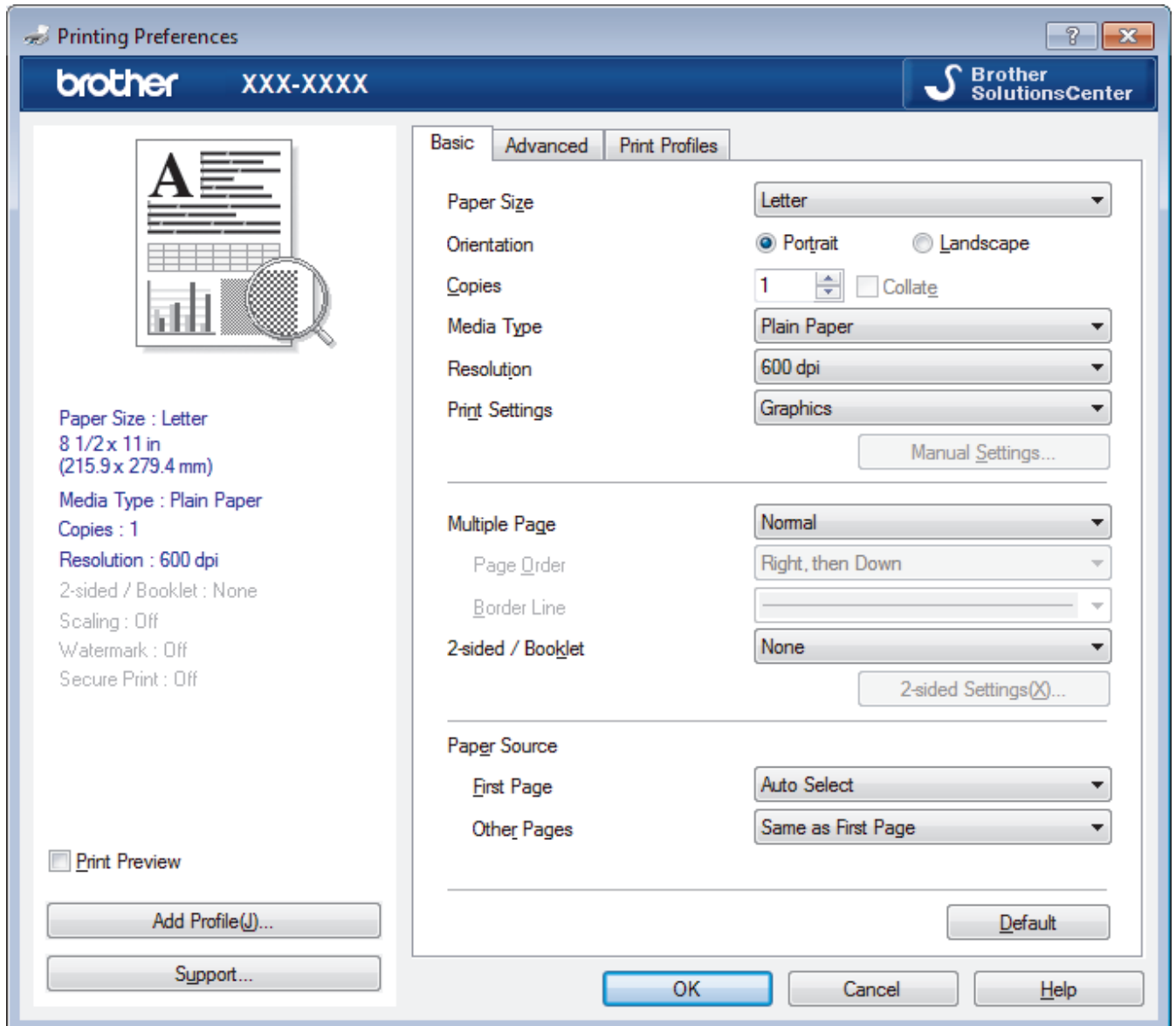

#### 1. Paper Size

Select the size of the paper you want to use. You can either choose from standard paper sizes or create a custom paper size.

#### 2. Orientation

Select the orientation (portrait or landscape) of your printout.

If your application contains a similar setting, we recommend that you set the orientation using the application.

#### 3. Copies

Type the number of copies (1-999) that you want to print in this field.

#### Collate

Select this option to print sets of multi-page documents in the original page order. When this option is selected, one complete copy of your document will print, and then reprint according to the number of copies you choose. If this option is not selected, then each page will print according to the number of copies chosen before the next page of the document is printed.

#### 4. Media Type

Select the type of media you want to use. To achieve the best print results, the machine automatically adjusts its print settings according to the selected media type.

---

## 5. Resolution

Select the print resolution. As print resolution and speed are related, the higher the resolution, the longer it will take to print the document.

## 6. Print Settings

Select the type of document you want to print.

### Manual Settings...

Specify advanced settings such as brightness, contrast, and other settings.

### Graphics

#### Use Printer Halftone

Select this option to use the printer driver to express halftones.

#### Brightness

Specify the brightness.

#### Contrast

Specify the contrast.

#### Graphics Quality

Select either Graphics or Text for the best print quality, based on the type of document you are printing.

#### Improve Gray Printing

Select this option to improve the image quality of shaded areas.

#### Improve Pattern Printing

Select this option to improve the pattern printing if printed fills and patterns are different from the fills and patterns you see on your computer screen.

#### Improve Thin Line

Select this option to improve the image quality of thin lines.

#### Use System Halftone

Select this option to use Windows® to express halftones.

### TrueType Mode

#### Mode

Select how the fonts are processed for printing.

#### Use Printer TrueType Fonts

Select whether to use built-in fonts for the font processing.

## 7. Multiple Page

Select this option to print multiple pages on a single sheet of paper or print one page of your document on multiple sheets.

### Page Order

Select the page order when printing multiple pages on a single sheet of paper.

### Border Line

Select the type of border to use when printing multiple pages on a single sheet of paper.

## 8. 2-sided / Booklet

Select this option to print on both sides of the paper or print a document in booklet format using 2-sided printing.

### 2-sided Settings button

Click this button to select the type of 2-sided binding. Four types of 2-sided bindings are available for each orientation.

## 9. Paper Source

Select the paper source setting according to your print conditions or purpose.

### First Page

Select the paper source to use for printing the first page.

### Other Pages

Select the paper source to use for printing the second and subsequent pages.

## Advanced Tab

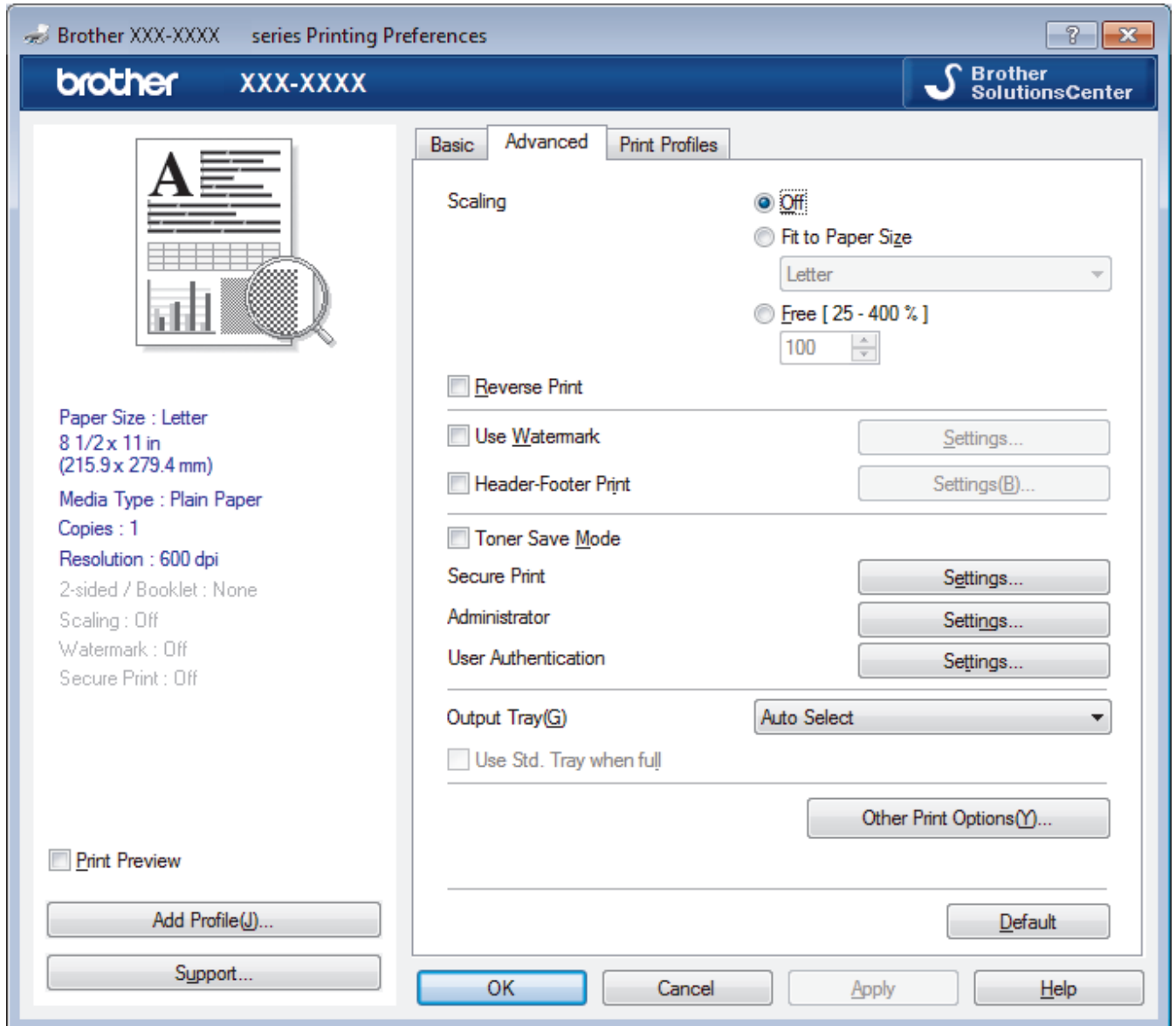

### 1. Scaling

Select these options to enlarge or reduce the size of the pages in your document.

#### Fit to Paper Size

Select this option to enlarge or reduce the document pages to fit a specified paper size. When you select this option, select the paper size you want from the drop-down list.

#### Free

Select this option to enlarge or reduce the document pages manually. When you select this option, type a value into the field.

### 2. Reverse Print

Select this option to rotate the printed image 180 degrees.



---

### 3. Use Watermark

Select this option to print a logo or text on your document as a watermark. Select one of the preset watermarks, add a new watermark, or use an image file you have created.

### 4. Header-Footer Print

Select this option to print the date, time and PC login user name on the document.

### 5. Toner Save Mode

Select this feature to conserve toner by using less toner to print documents; printouts appear lighter, but are still legible.

### 6. Secure Print

This feature ensures that confidential or sensitive documents do not print until you enter a password on the machine's control panel.

### 7. Administrator

This feature allows you to change the administrator password and restrict various printing functions.

### 8. User Authentication

This feature allows you to confirm the restrictions for each user.

### 9. Output Tray (Available only for certain models)

Select the output tray for printed pages.

#### MX Stacker

Ejects paper into the standard output tray. When the standard output tray becomes full the printer automatically selects the next available bin.

#### MX Sorter

When you print multiple copies, each copy is ejected onto a different bin from 1 to 4.

#### Use Std. Tray when full

Select this option to continue printing, even if the Mailbox bin is full. When you select this option, the machine continues the print job, ejecting the remaining pages onto the machine's main output tray when the Mailbox bin is full.

### 10. Other Print Options button

#### Sleep Time

Specify the amount of time that passes before the machine enters Sleep Mode.

#### Macro

Select this feature to print an electronic form (macro), which you have stored in your machine's memory, as an overlay on the print job.

#### Density Adjustment

Specify the print density.

#### Improve Print Output

Select this option to reduce the amount of paper curling and improve the toner fixing.

#### Skip Blank Page

Select this option to allow the printer driver to automatically detect blank pages and exclude them from printing.

#### Print Text in Black

Select this option when you want to print color text in black.

#### Print Archive

Select this option to save the print data as a PDF file to your computer.

#### Eco settings

Select this option to reduce printing noise.



## Related Information

- [Print from Your Computer \(Windows®\)](#)
- [Print a Document \(Windows®\)](#)
- [Print More Than One Page on a Single Sheet of Paper \(N in 1\) \(Windows®\)](#)
- [Print as a Poster \(Windows®\)](#)
- [Print on Both Sides of the Paper \(Windows®\)](#)
- [Print as a Booklet \(Windows®\)](#)
- [Use a Preset Print Profile \(Windows®\)](#)
- [Change the Default Print Settings \(Windows®\)](#)
- [Use Standard Tray When Full](#)
- [Assign a Mailbox Bin to a User or Group](#)
- [Mailbox Unit](#)

## Print from Your Computer (Macintosh)

- [Print a Document \(Macintosh\)](#)
- [Print on Both Sides of the Paper \(Macintosh\)](#)
- [Print More Than One Page on a Single Sheet of Paper \(N in 1\) \(Macintosh\)](#)
- [Secure Print \(Macintosh\)](#)
- [Print a Document Using the BR-Script3 Printer Driver \(PostScript® 3™ language emulation\) \(Macintosh\)](#)
- [Monitor the Status of the Machine from Your Computer \(Macintosh\)](#)
- [Print Options \(Macintosh\)](#)

## Print a Document (Macintosh)

1. Make sure you have loaded the correct size paper in the paper tray.
2. From an application, such as Apple TextEdit, click the **File** menu, and then select **Print**.
3. Select **Brother XXX-XXXX** (where XXXX is your model name).
4. Type the number of copies you want in the **Copies** field.
5. Click the **Paper Size** pop-up menu, and then select your paper size.
6. Select the **Orientation** option that matches the way you want the document to print.
7. Click the application pop-up menu, and then select **Print Settings**.  
The **Print Settings** options appear.
8. Click the **Media Type** pop-up menu, and then select the type of paper you are using.
9. Change other printer settings, if needed.
10. Click **Print**.



### Related Information

- [Print from Your Computer \(Macintosh\)](#)
  - [Print Options \(Macintosh\)](#)
-

## Print on Both Sides of the Paper (Macintosh)

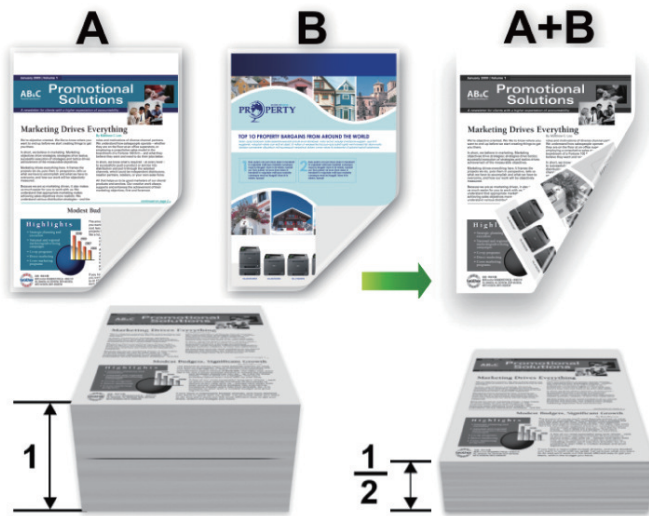

- Select Letter, Legal, Mexico Legal, India Legal or Folio sized paper when using the automatic 2-sided printing function.
  - Make sure the back cover is closed.
  - If paper is curled, straighten it and put it back in the paper tray.
  - Use regular paper or thin paper. DO NOT use bond paper.
  - If the paper is too thin, it may wrinkle.
  - When you use the manual 2-sided printing function, it is possible there may be paper jams or poor print quality.
1. From an application, such as Apple TextEdit, click the **File** menu, and then select **Print**.
  2. Select **Brother XXX-XXXX** (where XXXX is your model name).
  3. Select the **Orientation** option that matches the way you want the document to print.
  4. For automatic 2-sided printing, do the following:
    - a. Click the application pop-up menu, and then select **Layout**.  
The **Layout** setting options appear.
    - b. In the **Two-Sided** section, select the **Short-Edge binding** or **Long-Edge binding** option.
    - c. Change other printer settings, if needed.
    - d. Click **Print**.
  5. For manual 2-sided printing, do the following:
    - a. Click the application pop-up menu, and then select **Paper Handling**.  
The **Paper Handling** options appear.
    - b. In the **Pages to Print** pop-up menu, select **Even Only**.
    - c. Change other print settings, if needed.
    - d. Click the **Print** button.
    - e. After the machine prints the even-numbered pages, remove the printed pages from the output paper tray.
    - f. Make sure the pages are completely flat, and put the paper back in the tray, blank side facing down.
    - g. Repeat steps 1-3, selecting the same printer and settings you used to print the even-numbered pages.
    - h. Click the application pop-up menu, and then select **Paper Handling**. The **Paper Handling** options appear.
    - i. In the **Pages to Print** pop-up menu, select **Odd Only**.
    - j. Click **Print**.



## Related Information

- [Print from Your Computer \(Macintosh\)](#)
  - [Print Options \(Macintosh\)](#)
-

## Print More Than One Page on a Single Sheet of Paper (N in 1) (Macintosh)



1. From an application, such as Apple TextEdit, click the **File** menu, and then select **Print**.
2. Select **Brother XXX-XXXX** (where XXXX is your model name).
3. Click the application pop-up menu, and then select **Layout**.  
The **Layout** setting options appear.
4. Click the **Pages per Sheet** pop-up menu, and then select the number of pages to print on each sheet.
5. Select the **Layout Direction** option.
6. Click the **Border** pop-up menu, and then select your border line type.
7. Change other printer settings if needed.
8. Click **Print**.

### ✓ Related Information

- [Print from Your Computer \(Macintosh\)](#)
- [Print Options \(Macintosh\)](#)

## Secure Print (Macintosh)

Use Secure Print to ensure that confidential or sensitive documents do not print until you enter a password on the machine's control panel.

- The secure data is deleted from the machine when you turn off the machine.

>> [HL-L5000D/HL-L5100DN/HL-L5200DW/HL-L5200DWT/HL-L6200DW/HL-L6200DWT](#)

>> [HL-L6300DW](#)

### HL-L5000D/HL-L5100DN/HL-L5200DW/HL-L5200DWT/HL-L6200DW/HL-L6200DWT

1. From an application, such as Apple TextEdit, click the **File** menu, and then select **Print**.
2. Select **Brother XXX-XXXX** (where XXXX is your model name).
3. Click the application pop-up menu, and then select the **Secure Print** option. The **Secure Print** options appear.
4. Select the **Secure Print** check box.
5. Type your user name, job name and a four-digit password.
6. Click **Print**.
7. On the machine's control panel, press **Secure**.
8. Press **▲** or **▼** to display your user name, and then press **OK**.  
The LCD displays the list of secured jobs for that name.
9. Press **▲** or **▼** to display the job, and then press **OK**.
10. Enter your four-digit password.  
To enter each digit, press **▲** or **▼** to select a number, and then press **OK**.
11. Press **▲** or **▼** to select the [Print] option, and then press **OK**.
12. Press **▲** or **▼** to enter the number of copies you want.
13. Press **OK**.  
The machine prints the data.

After you print the secured data, it will be cleared from the machine's memory.

### HL-L6300DW

1. From an application, such as Apple TextEdit, click the **File** menu, and then select **Print**.
2. Select **Brother XXX-XXXX** (where XXXX is your model name).
3. Click the application pop-up menu, and then select the **Secure Print** option. The **Secure Print** options appear.
4. Select the **Secure Print** check box.
5. Type your user name, job name and a four-digit password.
6. Click **Print**.
7. On the machine's control panel, press  [Functions].
8. Press [Secure].
9. Press **▲** or **▼** to display user names, and then press your user name.  
The LCD displays the list of secured jobs for that name.
10. Press **▲** or **▼** to display the print job you want to print, and then press it.
11. Enter your four-digit password, and then press [OK].
12. Enter the number of copies you want.
13. Press [Start].  
The machine prints the data.



---

After you print the secured data, it will be cleared from the machine's memory.



### **Related Information**

- [Print from Your Computer \(Macintosh\)](#)
-

## Print a Document Using the BR-Script3 Printer Driver (PostScript® 3™ language emulation) (Macintosh)

The BR-Script3 printer driver lets you print PostScript® data more clearly.

- Go to your model's **Downloads** page on the Brother Solutions Center at [support.brother.com](http://support.brother.com) to download the PS driver (BR-Script3 printer driver).
- Make sure you have added the BR-Script3 printer driver from **Print & Scan** or **Printers & Scanners** in the **System Preferences** list on your Macintosh.
  1. Make sure you have loaded the correct size paper in the paper tray.
  2. From an application, such as Apple TextEdit, click the **File** menu, and then select **Print**.
  3. Select **Brother XXX-XXXX** (where XXXX is your model name).
  4. Type the number of copies you want in the **Copies** field.
  5. Click the **Paper Size** pop-up menu, and then select your paper size.
  6. Select the **Orientation** option that matches the way you want the document to print.
  7. Click the print options pop-up menu, and then click **Printer Features**.

The **Printer Features** options appear.
  8. Click the **Print Quality** pop-up menu, and then select the resolution.
  9. Click the **Media Type** pop-up menu, and then select the type of paper you are using.
  10. Change other printer settings, if needed.
  11. Click **Print**.



### Related Information

- [Print from Your Computer \(Macintosh\)](#)

## Monitor the Status of the Machine from Your Computer (Macintosh)

The Status Monitor utility is a configurable software tool for monitoring the status of a device, allowing you to get immediate notification of error messages, such as paper empty or paper jam, at preset update intervals. You can also access Web Based Management.

1. Click the **System Preferences** menu, select **Print & Scan** or **Printers & Scanners**, and then select your machine.
2. Click the **Options & Supplies** button.
3. Click the **Utility** tab, and then click the **Open Printer Utility** button.

Status Monitor starts.

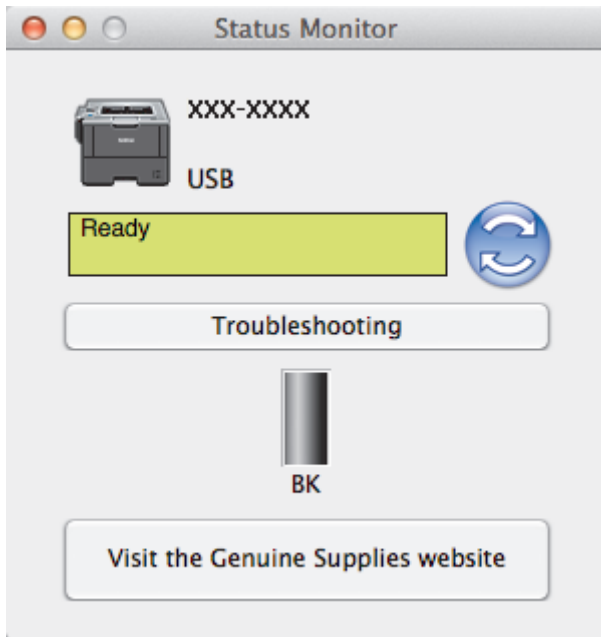

### Troubleshooting

Click the **Troubleshooting** button to access the troubleshooting website.

### Visit the Genuine Supplies website

Click the **Visit the Genuine Supplies website** button for more information on Brother genuine supplies.

### Updating the machine's status

To view the latest machine status while the **Status Monitor** window is open, click the  icon. You can set the interval at which the software updates machine status information. Click **Brother Status Monitor** in the menu bar, and then select **Preferences**.

### Web Based Management (Network Connection Only)

Access the Web Based Management System by clicking the machine icon on the **Status Monitor** screen. You can use a standard Web Browser to manage your machine using HTTP (Hyper Text Transfer Protocol).



### Related Information

- [Print from Your Computer \(Macintosh\)](#)
- [Printing Problems](#)

## Print Options (Macintosh)

### Page Setup

Settings: **Page Attributes**

Format For: **XXX-XXXX**  
Brother XXX-XXXX CUPS

Paper Size: **US Letter**  
8.50 by 11.00 inches

Orientation:  Portrait  Landscape

Scale: **100** %

Buttons: ? (Help), Cancel, OK

#### 1. Paper Size

Select the size of the paper you want to use. You can either choose from standard paper sizes or create a custom paper size.

#### 2. Orientation

Select the orientation (portrait or landscape) of your printout.

If your application contains a similar setting, we recommend that you set the orientation using the application.

#### 3. Scale

Type a value into the field to enlarge or reduce the pages in your document to fit the selected paper size.

## Layout



Printer: XXX-XXXX

Presets: Default Settings

Copies: 1  Two-Sided





Pages:  All  
 From: 1 to: 1

Paper Size: US Letter 8.50 by 11.00 inches

Orientation:  

Layout

Pages per Sheet: 1

Layout Direction:    

Border: None

Two-Sided: Off

Reverse page orientation  
 Flip horizontally

Cancel Print

### 1. Pages per Sheet

Select the number of pages to print on a single sheet of paper.

### 2. Layout Direction

Select the page order when printing multiple pages on a single sheet of paper.

### 3. Border

Select the type of border to use when printing multiple pages on a single sheet of paper.

### 4. Two-Sided (Available only for certain models)

Select whether to print on both sides of the paper.

### 5. Reverse page orientation

Select this option to rotate the printed image 180 degrees.

### 6. Flip horizontally

Select this option to reverse the printed image on the page horizontally from left to right.

## Paper Handling



Printer: XXX-XXXX

Presets: Default Settings

Copies: 1  Two-Sided

Pages:  All  
 From: 1 to: 1

Paper Size: US Letter 8.50 by 11.00 inches

Orientation:  

Paper Handling

Collate pages

Pages to Print: All pages

Page Order: Automatic

Scale to fit paper size

Destination Paper Size: Suggested Paper: US Letter

Scale down only

Cancel Print

### 1. Collate pages

Select this option to print sets of multi-page documents in the original page order. When this option is selected, one complete copy of your document will print, and then reprint according to the number of copies you choose. If this option is not selected, then each page will print according to the number of copies chosen before the next page of the document is printed.

### 2. Pages to Print

Select which pages you want to print (even pages or odd pages).

### 3. Page Order

Select the page order.

### 4. Scale to fit paper size

Select this option to enlarge or reduce the pages in your document to fit the selected paper size.

### 5. Destination Paper Size

Select the paper size to print on.

### 6. Scale down only

Select this option if you want to reduce the pages in your document when they are too large for the selected paper size. If this option is selected and the document is formatted for a paper size that is smaller than the paper size you are using, the document will be printed at its original size.

## Print Settings

The screenshot shows a 'Print Settings' dialog box with the following configuration:

- Media Type: Plain Paper
- Print Quality: 600 dpi
- Paper Source: Auto Select
- Output Tray: Auto Select
- Use Std. Tray when full

There is a link for 'Advanced' settings and 'Cancel' and 'Print' buttons at the bottom.

### 1. Media Type

Select the type of media you want to use. To achieve the best print results, the machine automatically adjusts its print settings according to the selected media type.

### 2. Print Quality

Select the print resolution you want. Because print quality and speed are related, the higher the quality, the longer it will take to print the document.

### 3. Paper Source

Select the paper source setting according to your print conditions or purpose.

### 4. Output Tray (Available only for certain models)

Select the output tray for printed pages.

### MX Stacker

Ejects paper into the standard output tray. When the standard output tray becomes full the printer automatically selects the next available bin.

### MX Sorter

When you print multiple copies, each copy is ejected onto a different bin from 1 to 4.

### Use Std. Tray when full

Select this option to continue printing, even if the Mailbox bin is full. When you select this option, the machine continues the print job, ejecting the remaining pages onto the machine's main output tray when the Mailbox bin is full.

### 5. Advanced

#### Toner Save Mode

Select this feature to conserve toner by using less toner to print documents; printouts appear lighter, but are still legible.

#### Graphics Quality

Select either Graphics or Text for the best print quality, based on the type of document you are printing.

#### Improve Print Output

Select this option to reduce the amount of paper curling and improve the toner fixing.

#### Density Adjustment

Specify the print density.

## Sleep Time

Specify the amount of time that passes before the machine enters Sleep Mode.

## Quiet Mode

Select this option to reduce printing noise.

## Other Print Options

### Skip Blank Page

Select this option to allow the printer driver to automatically detect blank pages and exclude them from printing.

## Secure Print

Printer: XXX-XXXX

Presets: Default Settings

Copies: 1  Two-Sided

Pages:  All  
 From: 1 to: 1

Paper Size: US Letter 8.50 by 11.00 inches

Orientation:  Portrait  Landscape

Secure Print

Secure Print

User Name : brother

Job Name : Untitled

Password :

Cancel Print

### 1. Secure Print

This feature ensures that confidential or sensitive documents do not print until you enter a password on the machine's control panel.

## ✓ Related Information

- [Print from Your Computer \(Macintosh\)](#)
- [Print a Document \(Macintosh\)](#)



- 
- Print on Both Sides of the Paper (Macintosh)
  - Print More Than One Page on a Single Sheet of Paper (N in 1) (Macintosh)
  - Use Standard Tray When Full
  - Assign a Mailbox Bin to a User or Group
  - Mailbox Unit
-

## Print One Page Duplicates on Different Types of Paper

Use the Carbon Copy function to make multiple copies of the same print data, as if printing on carbon paper. Send the data to individual paper trays that you pre-loaded with different paper types or colors.

For example, you may want to set the machine to send your print data to Tray1, which you have pre-loaded with blue colored paper, and then reprint the data in a certain location on the page from the MP Tray, which you have pre-loaded with yellow colored paper that already contains text.

If you load blue paper in Tray 1 and yellow paper in the MP tray, the printer will automatically feed paper for Sheet 1 from Tray 1 and Sheet 2 from the MP Tray.

If you enable the Carbon Copy function, the machine will always make copies automatically.



(Windows®)

The carbon copy function also allows you to select a different printing macro for each page.

>> [HL-L5000D/HL-L5100DN/HL-L5200DW/HL-L5200DWT/HL-L6200DW/HL-L6200DWT](#)  
>> [HL-L6300DW](#)

### HL-L5000D/HL-L5100DN/HL-L5200DW/HL-L5200DWT/HL-L6200DW/HL-L6200DWT

1. Press ▲ or ▼ to display the [Print Menu] option, and then press **OK**.
2. Press ▲ or ▼ to display the [Carbon Menu] option, and then press **OK**.
3. Press ▲ or ▼ to display the [Carbon Copy] option, and then press **OK**.
4. Press ▲ or ▼ to display the [On] option, and then press **OK**.
5. Press ▲ or ▼ to display the [Copies] option, and then press **OK**.
6. Press ▲ or ▼ to enter the number of copies you want, and then press **OK**.
7. Press ▲ or ▼ to display the [Copy1 Tray] option, and then press **OK**.
8. Press ▲ or ▼ to display the paper tray you want to configure as [Copy1 Tray], and then press **OK**.



(Windows®)

- a. Press ▲ or ▼ to display the [Copy1 Macro] option, and then press **OK**.
- b. Press ▲ or ▼ to display the ID number of the macro you want to use, and then press **OK**.

9. Repeat these steps until you have selected all the tray settings for each copy.
10. Send your print job to the machine.

### HL-L6300DW

1. Press  [Settings] > [Print Menu] > [Carbon Menu] > [Carbon Copy] > [On].
2. Press ▲ or ▼ to display the [Copies] option, and then press the [Copies] option.
3. Enter the number of copies you want, and then press [OK].
4. Press ▲ or ▼ to display the [Copy1 Tray] option, and then press the [Copy1 Tray] option.
5. Press ▲ or ▼ to display the paper tray you want to configure as [Copy1 Tray], and then press the paper tray.



(Windows®)

- a. Press ▲ or ▼ to display the [Copy1 Macro] option, and then press the [Copy1 Macro] option.
- b. Press ▲ or ▼ to display the ID number of the macro you want to use, and then press it.

6. Repeat these steps until you have selected all the tray settings for each copy.
7. Send your print job to the machine.



---

## Related Information

---

- [Print](#)
  - [Use a Macro from Your Computer \(Windows®\)](#)
-

## Cancel a Print Job

>> [HL-L5000D/HL-L5100DN/HL-L5200DW/HL-L5200DWT/HL-L6200DW/HL-L6200DWT](#)  
>> [HL-L6300DW](#)

### HL-L5000D/HL-L5100DN/HL-L5200DW/HL-L5200DWT/HL-L6200DW/HL-L6200DWT

1. Press **Cancel**.



To cancel multiple print jobs, press and hold **Cancel** for four seconds.

### HL-L6300DW

1. Press .



To cancel multiple print jobs, press and hold  for four seconds.

### Related Information

- [Print](#)
- [Printing Problems](#)

## Test Print

If there are problems with print quality, follow these instructions to do a test print.

>> [HL-L5000D/HL-L5100DN/HL-L5200DW/HL-L5200DWT/HL-L6200DW/HL-L6200DWT](#)



>> [HL-L6300DW](#)

### HL-L5000D/HL-L5100DN/HL-L5200DW/HL-L5200DWT/HL-L6200DW/HL-L6200DWT

1. Press ▲ or ▼ to display the [Machine Info.] option, and then press **OK**.
2. Press ▲ or ▼ to display the [Test Print] option, and then press **OK**.

The machine prints the test page.

### HL-L6300DW

1. Press  [Settings] > [Machine Information] > [Test Print].
2. Press [OK].
3. Press .



### Related Information

- [Print](#)
- [Improve the Print Quality](#)

## Network

- [Get Started](#)
- [Network Management Software and Utilities](#)
- [Additional Methods of Configuring Your Brother Machine for a Wireless Network](#)
- [Advanced Network Features](#)
- [Technical Information for Advanced Users](#)

## Get Started

We recommend setting up and connecting to your network using the Brother installation CD-ROM. This section provides more information about network connection types, introduces various methods to manage your network and explains some useful network features of your Brother machine.

- [Supported Basic Network Features](#)

## Supported Basic Network Features

**Related Models:** HL-L5100DN/HL-L5200DW/HL-L5200DWT/HL-L6200DW/HL-L6200DWT/HL-L6300DW

The print server supports various features depending on the operating system. Use this table to see which network features and connections are supported by each operating system.

Operating Systems	Windows® XP Windows Vista® Windows® 7 Windows® 8	Windows Server® 2003/2008/2012/2012 R2	OS X v10.8.5 OS X v10.9.x OS X v10.10.x
Printing	Yes	Yes	Yes
BRAdmin Light	Yes	Yes	
BRAdmin Professional 3	Yes	Yes	
Web Based Management	Yes	Yes	Yes
Status Monitor	Yes		Yes
Driver Deployment Wizard	Yes	Yes	
Vertical Pairing (Windows® 7 and Windows® 8 only)	Yes		



- Go to your model's **Downloads** page on the Brother Solutions Center at [support.brother.com](http://support.brother.com) to download the latest version of Brother's BRAdmin Light.
- Go to your model's **Downloads** page on the Brother Solutions Center at [support.brother.com](http://support.brother.com) to download the latest version of Brother's BRAdmin Professional 3 utility.



### Related Information

- [Get Started](#)



## Network Management Software and Utilities

Configure and change your Brother machine's network settings using a management utility.

- [Learn about Network Management Software and Utilities](#)
- [Change Machine Settings from Your Computer](#)
- [Change Machine Settings Using Web Based Management](#)

## Learn about Network Management Software and Utilities

**Related Models:** HL-L5100DN/HL-L5200DW/HL-L5200DWT/HL-L6200DW/HL-L6200DWT/HL-L6300DW

### Web Based Management

Web Based Management is a utility that uses a standard web browser to manage your machine using the Hyper Text Transfer Protocol (HTTP) or Hyper Text Transfer Protocol over Secure Socket Layer (HTTPS). Type your machine's IP address into your web browser to access and change your print server settings.

### BRAdmin Light (Windows®)

BRAdmin Light is a utility for the initial setup of Brother network-connected devices. This utility can search for Brother products on your network, view the status and configure the basic network settings, such as IP address.

Go to your model's **Downloads** page on the Brother Solutions Center at [support.brother.com](http://support.brother.com) to download BRAdmin Light.



- If you are using Windows® Firewall, or the firewall function of an anti-spyware or antivirus application, temporarily disable them. When you are sure you can print, configure the software settings following the instructions.

### BRAdmin Professional 3 (Windows®)

BRAdmin Professional 3 is a utility for more advanced management of network-connected Brother devices. This utility can search for Brother products on your network and view the device status from an easy-to-read Windows® Explorer-style screen that changes color to identify the status of each device. You can configure network and device settings, and update device firmware from a Windows® computer on your LAN. BRAdmin Professional 3 can also log activity of Brother devices on your network and export the log data in an HTML, CSV, TXT, or SQL format. For users who want to monitor locally-connected machines, install the Print Auditor Client software on the client computer. This utility allows you to use BRAdmin Professional 3 to monitor machines that are connected to a client computer via the USB interface.



- Go to your model's **Downloads** page on the Brother Solutions Center at [support.brother.com](http://support.brother.com) to download the latest version of Brother's BRAdmin Professional 3 utility.
- Node name: The node name appears in the current BRAdmin Professional 3 window. The default node name is "BRNxxxxxxxxxxxx" for a wired network or "BRWxxxxxxxxxxxx" for a wireless network (where "xxxxxxxxxxxx" is your machine's MAC Address / Ethernet address).
- If you are using Windows® Firewall, or the firewall function of an anti-spyware or antivirus application, temporarily disable them. When you are sure you can print, configure the software settings following the instructions.



### Related Information

- [Network Management Software and Utilities](#)

## Additional Methods of Configuring Your Brother Machine for a Wireless Network

To connect your machine to your wireless network, we recommend using the Installation CD-ROM.

- [Before Configuring Your Brother Machine for a Wireless Network](#)
- [Configure Your Machine for a Wireless Network](#)
- [Configure Your Machine for a Wireless Network Using the One Push Method of Wi-Fi Protected Setup™ \(WPS\)](#)
- [Configure Your Machine for a Wireless Network Using the PIN Method of Wi-Fi Protected Setup™ \(WPS\)](#)
- [Configure Your Machine for a Wireless Network in Ad-Hoc Mode \(For IEEE 802.11b/g/n\)](#)
- [Configure Your Machine for a Wireless Network Using the Machine's Control Panel Setup Wizard](#)
- [Configure Your Machine for a Wireless Network When the SSID Is Not Broadcast](#)
- [Configure Your Machine for an Enterprise Wireless Network](#)
- [Use Wi-Fi Direct®](#)

## Before Configuring Your Brother Machine for a Wireless Network

**Related Models:** HL-L5200DW/HL-L5200DWT/HL-L6200DW/HL-L6200DWT/HL-L6300DW

Before attempting to configure a wireless network, confirm the following:

- Before configuring wireless settings, you must know your Network name (SSID) and Network Key. If you are using an enterprise wireless network, you must know the User ID and Password.



If you do not know the security information, please consult the router manufacture, your system administrator, or your Internet provider.

- To achieve optimum results with normal everyday document printing, place the Brother machine as close to the wireless LAN access point/router as possible with minimal obstructions. Large objects and walls between the two devices and interference from other electronic devices can affect the data transfer speed of your documents.

Due to these factors, wireless may not be the best method of connection for all types of documents and applications. If you are printing large files, such as multi-page documents with mixed text and large graphics, you may want to consider selecting wired Ethernet for faster data transfer (supported models only), or USB for the fastest throughput speed.

- Although the Brother machine can be used in both a wired and wireless network (supported models only), only one connection method can be used at a time. However, a wireless network connection and Wi-Fi Direct connection, or a wired network connection (supported models only) and Wi-Fi Direct connection can be used at the same time.



### Related Information

- [Additional Methods of Configuring Your Brother Machine for a Wireless Network](#)

## Configure Your Machine for a Wireless Network

**Related Models:** HL-L5200DW/HL-L5200DWT/HL-L6200DW/HL-L6200DWT/HL-L6300DW

1. Turn on your computer and put the Brother Installation CD-ROM into your CD-ROM drive.
  - For Windows®, follow these instructions.
  - For Macintosh, click **Driver Download** to go to the Brother Solutions Center. Follow the on-screen instructions to install printer drivers.
2. The opening screen appears automatically.  
Choose your language, and then follow the on-screen instructions.



- (Windows® XP)  
If the Brother screen does not appear automatically, go to **My Computer**. Double-click the CD-ROM icon, and then double-click **start.exe**.
- (Windows Vista® and Windows®7)  
If the Brother screen does not appear automatically, go to **Computer**. Double-click the CD-ROM icon, and then double-click **start.exe**.
- (Windows® 8)  
Click the  (**File Explorer**) icon on the taskbar, and then go to **Computer (This PC)**. Double-click the CD-ROM icon, and then double-click **start.exe**.
- If the **User Account Control** screen appears, do one of the following:
  - (Windows Vista®) Click **Allow**.
  - (Windows® 7/Windows® 8) Click **Yes**.

3. Choose **Wireless Network Connection (Wi-Fi)**, and then click **Next**.
4. Follow the on-screen instructions.

After you have completed the wireless setup, the installer program walks you through installing the drivers. Click **Next** in the installation dialog box and follow the on-screen instructions.



### Related Information

- [Additional Methods of Configuring Your Brother Machine for a Wireless Network](#)

## Configure Your Machine for a Wireless Network Using the One Push Method of Wi-Fi Protected Setup™ (WPS)

**Related Models:** HL-L5200DW/HL-L5200DWT/HL-L6200DW/HL-L6200DWT/HL-L6300DW

If your wireless access point/router supports WPS (Push Button Configuration), you can use WPS from your machine's control panel menu to configure your wireless network settings.



Routers or access points that support WPS are marked with this symbol:



>> HL-L5200DW/HL-L5200DWT/HL-L6200DW/HL-L6200DWT  
>> HL-L6300DW

### HL-L5200DW/HL-L5200DWT/HL-L6200DW/HL-L6200DWT

1. Press ▲ or ▼ to select the [Network] option, and then press **OK**.
2. Press ▲ or ▼ to select the [WLAN] option, and then press **OK**.
3. Press ▲ or ▼ to select the [WPS] option, and then press **OK**.
4. When [WLAN Enable?] appears, press ▲ to select On.  
This will start the wireless setup wizard. To cancel, press **Cancel**.
5. When the LCD displays [Press Key on rtr], press the WPS button on your wireless access point/router. Press ▲ on the machine's control panel. Your machine will automatically detect your wireless access point/router and try to connect to your wireless network.

If your wireless device is connected successfully, the machine's LCD displays [Connected].

You have completed the wireless network setup. To install drivers and software necessary for operating your device, insert the Brother Installation CD-ROM to your computer or go to your model's **Downloads** page on the Brother Solutions Center at [support.brother.com](http://support.brother.com) to install drivers and software necessary for operating your device.

### HL-L6300DW

1. Press  [Settings] > [Network] > [WLAN] > [WPS].
2. When [Switch network interface to wireless?] appears, press [Yes].  
This will start the wireless setup wizard. To cancel, press [No].
3. When the Touchscreen displays [Start WPS on your wireless access point/router, then press [OK]], press the WPS button on your wireless access point/router. Then press [OK] on your machine. Your machine will automatically detect your wireless access point/router and try to connect to your wireless network.

If your wireless device is connected successfully, the machine's LCD displays [Connected].

---

You have completed the wireless network setup. To install drivers and software necessary for operating your device, insert the Brother Installation CD-ROM to your computer or go to your model's **Downloads** page on the Brother Solutions Center at [support.brother.com](http://support.brother.com) to install drivers and software necessary for operating your device.



### Related Information

- [Additional Methods of Configuring Your Brother Machine for a Wireless Network](#)
  - [Wireless LAN Report Error Codes](#)
-

## Configure Your Machine for a Wireless Network Using the PIN Method of Wi-Fi Protected Setup™ (WPS)

**Related Models:** HL-L5200DW/HL-L5200DWT/HL-L6200DW/HL-L6200DWT/HL-L6300DW

If your wireless LAN access point/router supports WPS, you can use the Personal Identification Number (PIN) Method to configure your wireless network settings.

The PIN Method is one of the connection methods developed by the Wi-Fi Alliance®. By submitting a PIN created by an Enrollee (your machine) to the Registrar (a device that manages the wireless LAN), you can set up the wireless network and security settings. For more information on how to access WPS mode, see the instructions provided with your wireless access point/router.

### Type A

Connection when the wireless LAN access point/router (1) doubles as Registrar.

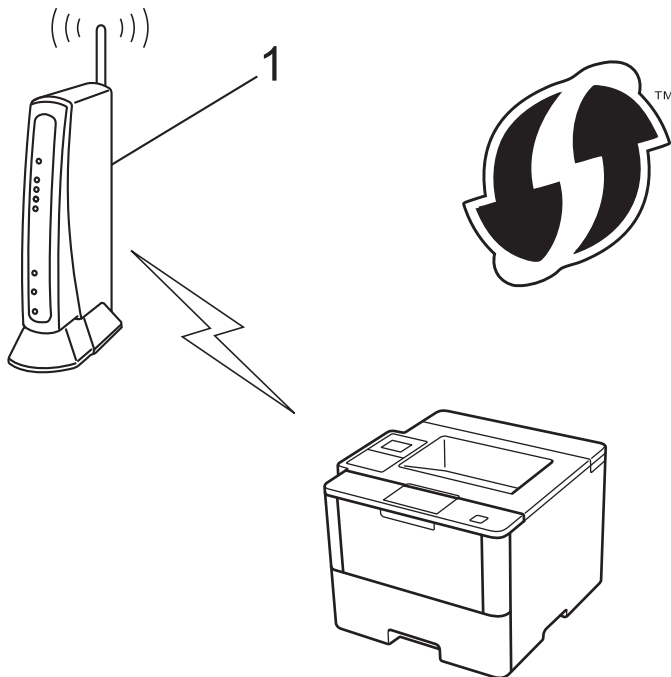

### Type B

Connection when another device (2), such as a computer, is used as Registrar.



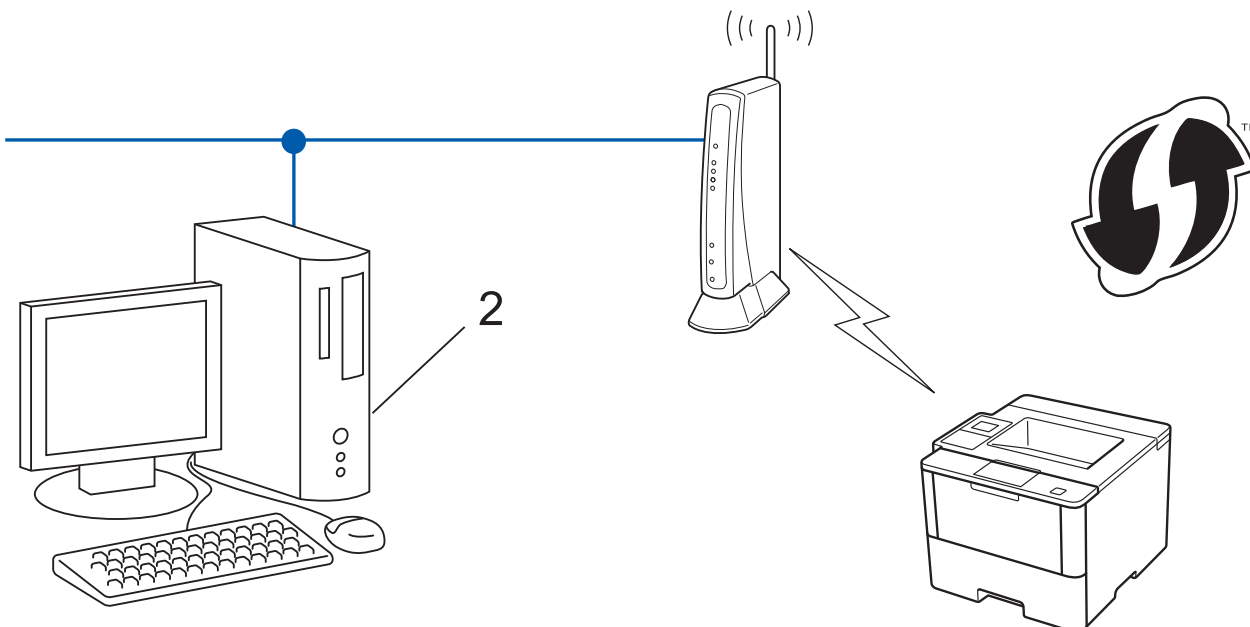

 Routers or access points that support WPS are marked with this symbol:



>> HL-L5200DW/HL-L5200DWT/HL-L6200DW/HL-L6200DWT  
>> HL-L6300DW

### HL-L5200DW/HL-L5200DWT/HL-L6200DW/HL-L6200DWT

1. Press ▲ or ▼ to select the [Network] option, and then press **OK**.
2. Press ▲ or ▼ to select the [WLAN] option, and then press **OK**.
3. Press ▲ or ▼ to select the [WPS w/PIN Code] option, and then press **OK**.
4. When [WLAN Enable?] appears, press ▲ to select On.  
This will start the wireless setup wizard. To cancel, press **Cancel**.
5. The LCD displays an eight-digit PIN and the machine starts searching for a wireless LAN access point/router.
6. Using a computer that is on the network, type "http://access point's IP address" in your browser (where "access point's IP address" is the IP address of the device that is being used as the Registrar).
7. Go to the WPS settings page and type the PIN, and then follow the on-screen instructions.

-  The Registrar is usually the wireless LAN access point/router.
- The settings page will differ depending on the brand of wireless LAN access point/router. For more information, see the instructions supplied with your wireless LAN access point/router.

**If you are using a Windows Vista®, Windows® 7, or Windows® 8 computer as a Registrar, complete the following steps:**

8. Do one of the following:
  - (Windows Vista®)

---

Click  (**Start**) > **Network** > **Add a wireless device**.

- (Windows® 7)

Click  (**Start**) > **Devices and Printers** > **Add a device**.

- (Windows® 8)

Move your mouse to the lower right corner of your desktop. When the menu bar appears, click **Settings** > **Control Panel** > **Hardware and Sound** > **Devices and Printers** > **Add a device**.



- To use a Windows Vista®, Windows® 7, or Windows® 8 computer as a Registrar, you must register it to your network in advance. For more information, see the instructions supplied with your wireless LAN access point/router.
- If you use Windows® 7 or Windows® 8 as a Registrar, you can install the printer driver after the wireless configuration by following the on-screen instructions. To install the full driver and software package, use the Brother Installation CD-ROM.

9. Select your machine and click **Next**.

10. Type the PIN displayed on the machine's LCD, and then click **Next**.

11. Select your network, and then click **Next**.

12. Click **Close**.

If your wireless device is connected successfully, the machine's LCD displays [Connected].

You have completed the wireless network setup. To install drivers and software necessary for operating your device, insert the Brother Installation CD-ROM to your computer or go to your model's **Downloads** page on the Brother Solutions Center at [support.brother.com](http://support.brother.com) to install drivers and software necessary for operating your device.

## HL-L6300DW

1. Press  [Settings] > [Network] > [WLAN] > [WPS w/PIN Code].

2. When [Switch network interface to wireless?] appears, press [Yes].

This will start the wireless setup wizard. To cancel, press [No].

3. The LCD displays an eight-digit PIN and the machine starts searching for a wireless LAN access point/router.

4. Using a computer that is on the network, type "http://access point's IP address" in your browser (where "access point's IP address" is the IP address of the device that is being used as the Registrar).

5. Go to the WPS settings page and type the PIN, and then follow the on-screen instructions.



- The Registrar is usually the wireless LAN access point/router.
- The settings page will differ depending on the brand of wireless LAN access point/router. For more information, see the instructions supplied with your wireless LAN access point/router.

---

**If you are using a Windows Vista®, Windows® 7, or Windows® 8 computer as a Registrar, complete the following steps:**

6. Do one of the following:

- (Windows Vista®)

Click  (**Start**) > **Network** > **Add a wireless device**.

- (Windows® 7)

Click  (**Start**) > **Devices and Printers** > **Add a device**.

- (Windows® 8)

Move your mouse to the lower right corner of your desktop. When the menu bar appears, click **Settings** > **Control Panel** > **Hardware and Sound** > **Devices and Printers** > **Add a device**.



- To use a Windows Vista<sup>®</sup>, Windows<sup>®</sup> 7, or Windows<sup>®</sup> 8 computer as a Registrar, you must register it to your network in advance. For more information, see the instructions supplied with your wireless LAN access point/router.
- If you use Windows<sup>®</sup> 7 or Windows<sup>®</sup> 8 as a Registrar, you can install the printer driver after the wireless configuration by following the on-screen instructions. To install the full driver and software package, use the Brother Installation CD-ROM.

7. Select your machine and click **Next**.
8. Type the PIN displayed on the machine's LCD, and then click **Next**.
9. Select your network, and then click **Next**.
10. Click **Close**.

If your wireless device is connected successfully, the machine's LCD displays [Connected].

You have completed the wireless network setup. To install drivers and software necessary for operating your device, insert the Brother Installation CD-ROM to your computer or go to your model's **Downloads** page on the Brother Solutions Center at [support.brother.com](http://support.brother.com) to install drivers and software necessary for operating your device.



### Related Information

- [Additional Methods of Configuring Your Brother Machine for a Wireless Network](#)
- [Wireless LAN Report Error Codes](#)

## Configure Your Machine for a Wireless Network in Ad-Hoc Mode (For IEEE 802.11b/g/n)

- [Configure Your Machine for a Wireless Network in Ad-Hoc Mode Using a New SSID](#)
- [Configure Your Machine for a Wireless Network in Ad-Hoc Mode Using an Existing SSID](#)

## Configure Your Machine for a Wireless Network in Ad-Hoc Mode Using a New SSID

**Related Models:** HL-L5200DW/HL-L5200DWT/HL-L6200DW/HL-L6200DWT/HL-L6300DW

You must connect to a new SSID from your computer when it is configured for Ad-Hoc mode.

>> [HL-L5200DW/HL-L5200DWT/HL-L6200DW/HL-L6200DWT](#)

>> [HL-L6300DW](#)

### HL-L5200DW/HL-L5200DWT/HL-L6200DW/HL-L6200DWT

1. Press ▲ or ▼ to select the [Network] option, and then press **OK**.
2. Press ▲ or ▼ to select the [WLAN] option, and then press **OK**.
3. Press ▲ or ▼ to select the [Setup Wizard] option, and then press **OK**.
4. When [WLAN Enable?] appears, press ▲ to select On.  
This will start the wireless setup wizard. To cancel, press **Cancel**.
5. The machine will search for your network and display a list of available SSIDs. Press ▲ or ▼ to select the [<New SSID>] option, and then press **OK**.
6. Enter the SSID name, and then press **OK**.
7. Press ▲ or ▼ to select the [Ad-hoc] option, and then press **OK**.
8. Press ▲ or ▼ to select the Encryption Type [None] or [WEP], and then press **OK**.
9. If you selected the [WEP] option for Encryption Type, enter the WEP key, and then press **OK**.



Your Brother machine supports the use of the first WEP key only.

10. To apply the settings, press ▲. To cancel, press ▼.
11. The machine will attempt to connect to the wireless device you have selected.

If your wireless device is connected successfully, the machine's LCD displays [Connected].

You have completed the wireless network setup. To install drivers and software necessary for operating your device, insert the Brother Installation CD-ROM to your computer or go to your model's **Downloads** page on the Brother Solutions Center at [support.brother.com](http://support.brother.com) to install drivers and software necessary for operating your device.

### HL-L6300DW

1. Press  [Settings] > [Network] > [WLAN] > [Setup Wizard].
2. When [Switch network interface to wireless?] appears, press [Yes].  
This will start the wireless setup wizard. To cancel, press [No].
3. The machine will search for your network and display a list of available SSIDs. Press ▲ or ▼ to display the [<New SSID>] option.
4. Press [<New SSID>].
5. Enter the SSID name, and then press [OK].



For more information about how to enter text, see the *User's Guide*.

6. Press [Ad-hoc].
7. Press either [None] or [WEP] to select Encryption Type.

---

8. If you selected [WEP] for Encryption Type, enter the WEP key, and then press [OK].



- For more information about how to enter text, see the *User's Guide*.
- Your Brother machine supports the use of the first WEP key only.

9. To apply the settings, press [Yes]. To cancel, press [No].

10. The machine will attempt to connect to the wireless device you have selected.

If your wireless device is connected successfully, the machine's LCD displays [Connected].

You have completed the wireless network setup. To install drivers and software necessary for operating your device, insert the Brother Installation CD-ROM to your computer or go to your model's **Downloads** page on the Brother Solutions Center at [support.brother.com](http://support.brother.com) to install drivers and software necessary for operating your device.



### Related Information

- [Configure Your Machine for a Wireless Network in Ad-Hoc Mode \(For IEEE 802.11b/g/n\)](#)
  - [How to Enter Text on Your Brother Machine](#)
  - [Wireless LAN Report Error Codes](#)
-

## Configure Your Machine for a Wireless Network in Ad-Hoc Mode Using an Existing SSID

**Related Models:** HL-L5200DW/HL-L5200DWT/HL-L6200DW/HL-L6200DWT/HL-L6300DW

If you are trying to pair your Brother machine to a computer that is already in Ad-Hoc mode and has a configured SSID, use these instructions.

>> [HL-L5200DW/HL-L5200DWT/HL-L6200DW/HL-L6200DWT](#)

>> [HL-L6300DW](#)

### HL-L5200DW/HL-L5200DWT/HL-L6200DW/HL-L6200DWT

Before configuring your machine, we recommend writing down your wireless network settings. You will need this information before you continue with the configuration.

1. Check and record the current wireless network settings of the computer to which you are connecting.



The wireless network settings of the computer you are connecting with must be set to Ad-Hoc mode with an SSID already configured. For more information on how to configure your computer in Ad-Hoc mode, see the instructions included with your computer or contact your network administrator.

Network Name (SSID)		

Communication Mode	Encryption Mode	Network Key
Ad-Hoc	NONE	-
	WEP	

For example:

Network Name (SSID)		
HELLO		

Communication Mode	Encryption Mode	Network Key
Ad-Hoc	WEP	12345



Your Brother machine supports the use of the first WEP key only.

2. Press ▲ or ▼ to select the [Network] option, and then press **OK**.
3. Press ▲ or ▼ to select the [WLAN] option, and then press **OK**.
4. Press ▲ or ▼ to select the [Setup Wizard] option, and then press **OK**.
5. When [WLAN Enable?] appears, press ▲ to select On.  
This will start the wireless setup wizard. To cancel, press **Cancel**.
6. The machine will search for your network and display a list of available SSIDs. When a list of SSIDs appears, press ▲ or ▼ to select the SSID you want.
7. Press **OK**.
8. Enter the WEP key, and then press **OK**.  
To apply the settings, press ▲. To cancel, press ▼.



Your Brother machine supports the use of the first WEP key only.

9. The machine will attempt to connect to the wireless device you have selected.

If your wireless device is connected successfully, the machine's LCD displays [Connected].

You have completed the wireless network setup. To install drivers and software necessary for operating your device, insert the Brother Installation CD-ROM to your computer or go to your model's **Downloads** page on the Brother Solutions Center at [support.brother.com](http://support.brother.com) to install drivers and software necessary for operating your device.

## HL-L6300DW

Before configuring your machine, we recommend writing down your wireless network settings. You will need this information before you continue with the configuration.

1. Check and record the current wireless network settings of the computer to which you are connecting.



The wireless network settings of the computer you are connecting with must be set to Ad-Hoc mode with an SSID already configured. For more information on how to configure your computer in Ad-Hoc mode, see the instructions included with your computer or contact your network administrator.

Network Name (SSID)		
Communication Mode	Encryption Mode	Network Key
Ad-Hoc	NONE	-
	WEP	

For example:

Network Name (SSID)		
HELLO		
Communication Mode	Encryption Mode	Network Key
Ad-Hoc	WEP	12345



Your Brother machine supports the use of the first WEP key only.

- Press  [Settings] > [Network] > [WLAN] > [Setup Wizard].
- When [Switch network interface to wireless?] appears, press [Yes].  
This will start the wireless setup wizard. To cancel, press [No].
- The machine will search for your network and display a list of available SSIDs. When a list of SSIDs appears, press ▲ or ▼ to select the SSID you want, and then press the SSID.  
Enter the WEP key, and then press [OK].  
To apply the settings, press [Yes]. To cancel, press [No].



- For more information about how to enter text, see the *User's Guide*.
- Your Brother machine supports the use of the first WEP key only.

5. The machine attempts to connect to the wireless device you have selected.

If your wireless device is connected successfully, the machine's LCD displays [Connected].

You have completed the wireless network setup. To install drivers and software necessary for operating your device, insert the Brother Installation CD-ROM to your computer or go to your model's **Downloads** page on the Brother Solutions Center at [support.brother.com](http://support.brother.com) to install drivers and software necessary for operating your device.





---

## Related Information

---

- [Configure Your Machine for a Wireless Network in Ad-Hoc Mode \(For IEEE 802.11b/g/n\)](#)
  - [How to Enter Text on Your Brother Machine](#)
  - [Wireless LAN Report Error Codes](#)
-

## Configure Your Machine for a Wireless Network Using the Machine's Control Panel Setup Wizard

**Related Models:** HL-L5200DW/HL-L5200DWT/HL-L6200DW/HL-L6200DWT/HL-L6300DW

>> [HL-L5200DW/HL-L5200DWT/HL-L6200DW/HL-L6200DWT](#)  
>> [HL-L6300DW](#)

### HL-L5200DW/HL-L5200DWT/HL-L6200DW/HL-L6200DWT

Before configuring your machine, we recommend writing down your wireless network settings. You will need this information before you continue with the configuration.

1. Check and record the current wireless network settings of the computer to which you are connecting.

Network Name (SSID)

Network Key

For example:

Network Name (SSID)
HELLO

Network Key
12345



- Your access point/router may support the use of multiple WEP keys, however your Brother machine supports the use of the first WEP key only.
- If you need assistance during setup and want to contact Brother Customer Service, make sure you have your SSID (Network Name) and Network Key ready. We cannot assist you in locating this information.
- If you do not know this information (SSID and Network Key), you cannot continue the wireless setup.

#### How can I find this information?

- Check the documentation provided with your wireless access point/router.
- The initial SSID could be the manufacturer's name or the model name.
- If you do not know the security information, please consult the router manufacture, your system administrator, or your Internet provider.

2. Press **▲** or **▼** to select the [Network] option, and then press **OK**.
3. Press **▲** or **▼** to select the [WLAN] option, and then press **OK**.
4. Press **▲** or **▼** to select the [Setup Wizard] option, and then press **OK**.
5. When [WLAN Enable?] appears, press **▲** to select On.  
This will start the wireless setup wizard. To cancel, press **Cancel**.
6. The machine will search for your network and display a list of available SSIDs. When a list of SSIDs appears, press **▲** or **▼** to select the SSID you want.
7. Press **OK**.
8. Do one of the following:

- If you are using an authentication and encryption method that requires a Network Key, enter the Network Key you wrote down in the first step.

Enter the key, and then press **OK** to apply your settings.

To apply the settings, press **▲**. To cancel, press **▼**.

- If your authentication method is Open System and your encryption mode is None, go to the next step.

9. The machine attempts to connect to the wireless device you have selected.

If your wireless device is connected successfully, the machine's LCD displays [Connected].

You have completed the wireless network setup. To install drivers and software necessary for operating your device, insert the Brother Installation CD-ROM to your computer or go to your model's **Downloads** page on the Brother Solutions Center at [support.brother.com](http://support.brother.com) to install drivers and software necessary for operating your device.

## HL-L6300DW

Before configuring your machine, we recommend writing down your wireless network settings. You will need this information before you continue with the configuration.

1. Check and record the current wireless network settings of the computer to which you are connecting.

<b>Network Name (SSID)</b>
<b>Network Key</b>

For example:

<b>Network Name (SSID)</b>
HELLO
<b>Network Key</b>
12345



- Your access point/router may support the use of multiple WEP keys, however your Brother machine supports the use of the first WEP key only.
- If you need assistance during setup and want to contact Brother Customer Service, make sure you have your SSID (Network Name) and Network Key ready. We cannot assist you in locating this information.
- If you do not know this information (SSID and Network Key), you cannot continue the wireless setup.

### How can I find this information?

- Check the documentation provided with your wireless access point/router.
- The initial SSID could be the manufacturer's name or the model name.
- If you do not know the security information, please consult the router manufacture, your system administrator, or your Internet provider.

2. Press  [Settings] > [Network] > [WLAN] > [Setup Wizard].

3. When [Switch network interface to wireless?] appears, press [Yes].

This will start the wireless setup wizard. To cancel, press [No].

4. The machine will search for your network and display a list of available SSIDs.

If a list of SSIDs is displayed, press **▲** or **▼** to display the SSID to which you want to connect, and then press the SSID.

5. Do one of the following:

- 
- If you are using an authentication and encryption method that requires a Network Key, enter the Network Key you wrote down in the first step.

When you have entered all the characters, press [OK] and then press [Yes] to apply your settings.

- If your authentication method is Open System and your encryption mode is None, go to the next step.

6. The machine attempts to connect to the wireless device you have selected.

If your wireless device is connected successfully, the machine's LCD displays [Connected].

You have completed the wireless network setup. To install drivers and software necessary for operating your device, insert the Brother Installation CD-ROM to your computer or go to your model's **Downloads** page on the Brother Solutions Center at [support.brother.com](http://support.brother.com) to install drivers and software necessary for operating your device.



### Related Information

- [Additional Methods of Configuring Your Brother Machine for a Wireless Network](#)
  - [How to Enter Text on Your Brother Machine](#)
  - [Wireless LAN Report Error Codes](#)
-

## Configure Your Machine for a Wireless Network When the SSID Is Not Broadcast

**Related Models:** HL-L5200DW/HL-L5200DWT/HL-L6200DW/HL-L6200DWT/HL-L6300DW

>> [HL-L5200DW/HL-L5200DWT/HL-L6200DW/HL-L6200DWT](#)  
>> [HL-L6300DW](#)

### HL-L5200DW/HL-L5200DWT/HL-L6200DW/HL-L6200DWT

Before configuring your machine, we recommend writing down your wireless network settings. You will need this information before you continue with the configuration.

1. Check and record the current wireless network settings.

Network Name (SSID)			
Communication Mode	Authentication Method	Encryption Mode	Network Key
Infrastructure	Open System	NONE	-
		WEP	
	Shared Key	WEP	
		WPA/WPA2-PSK	AES
	TKIP (TKIP is supported for WPA-PSK only.)		

For example:

Network Name (SSID)			
HELLO			
Communication Mode	Authentication Method	Encryption Mode	Network Key
Infrastructure	WPA2-PSK	AES	12345678



If your router uses WEP encryption, enter the key used as the first WEP key. Your Brother machine supports the use of the first WEP key only.

2. Press **▲** or **▼** to select the [Network] option, and then press **OK**.
3. Press **▲** or **▼** to select the [WLAN] option, and then press **OK**.
4. Press **▲** or **▼** to select the [Setup Wizard] option, and then press **OK**.
5. When [WLAN Enable?] appears, press **▲** to select On.  
This will start the wireless setup wizard. To cancel, press **Cancel**.
6. The machine will search for your network and display a list of available SSIDs. Press **▲** or **▼** to select the [<New SSID>] option, and then press **OK**.
7. Enter the SSID name, and then press **OK**.
8. Press **▲** or **▼** to select the [Infrastructure] option, and then press **OK**.
9. Press **▲** or **▼** to select the Authentication Method you want, and then press **OK**.
10. Do one of the following:
  - If you selected the [Open System] option, press **▲** or **▼** to select the Encryption Type [None] or [WEP], and then press **OK**.

If you selected the [WEP] option for Encryption Type, enter the WEP key, and then press **OK**.

- If you selected the [Shared Key] option, enter the WEP key, and then press **OK**.
- If you selected the [WPA/WPA2-PSK] option, press ▲ or ▼ to select the Encryption Type [TKIP+AES] or [AES], and then press **OK**.

Enter the WPA key, and then press **OK**.



Your Brother machine supports the use of the first WEP key only.

11. To apply the settings, press ▲. To cancel, press ▼.
12. The machine will attempt to connect to the wireless device you have selected.

If your wireless device is connected successfully, the machine's LCD displays [Connected].

You have completed the wireless network setup. To install drivers and software necessary for operating your device, insert the Brother Installation CD-ROM to your computer or go to your model's **Downloads** page on the Brother Solutions Center at [support.brother.com](http://support.brother.com) to install drivers and software necessary for operating your device.

## HL-L6300DW

Before configuring your machine, we recommend writing down your wireless network settings. You will need this information before you continue with the configuration.

1. Check and record the current wireless network settings.

Network Name (SSID)			
Communication Mode	Authentication Method	Encryption Mode	Network Key
Infrastructure	Open System	NONE	-
		WEP	
	Shared Key	WEP	
		WPA/WPA2-PSK	AES
		TKIP (TKIP is supported for WPA-PSK only.)	

For example:

Network Name (SSID)			
HELLO			
Communication Mode	Authentication Method	Encryption Mode	Network Key
Infrastructure	WPA2-PSK	AES	12345678



If your router uses WEP encryption, enter the key used as the first WEP key. Your Brother machine supports the use of the first WEP key only.

2. Press  [Settings] > [Network] > [WLAN] > [Setup Wizard].
3. When [Switch network interface to wireless?] appears, press [Yes].  
This will start the wireless setup wizard. To cancel, press [No].
4. The machine will search for your network and display a list of available SSIDs. Press ▲ or ▼ to display the [<New SSID>] option.
5. Press [<New SSID>].
6. Enter the SSID name, and then press [OK].



---

For more information about how to enter text, see the *User's Guide*.

---

7. Press [Infrastructure].
8. Press ▲ or ▼ to display the Authentication Method you want.
9. Press the Authentication Method you want.
10. Do one of the following:
  - If you selected the [Open System] option, press either [None] or [WEP].  
If you selected the [WEP] option for Encryption Type, enter the WEP key, and then press [OK].
  - If you selected the [Shared Key] option, enter the WEP key, and then press [OK].
  - If you selected the [WPA/WPA2-PSK] option, press either [TKIP+AES] or [AES] for Encryption Type.  
Enter the WPA key, and then press [OK].



- 
- For more information about how to enter text, see the *User's Guide*.
  - Your Brother machine supports the use of the first WEP key only.
- 

11. To apply the settings, press [Yes]. To cancel, press [No].
12. The machine will attempt to connect to the wireless device you have selected.

If your wireless device is connected successfully, the machine's LCD displays [Connected].

You have completed the wireless network setup. To install drivers and software necessary for operating your device, insert the Brother Installation CD-ROM to your computer or go to your model's **Downloads** page on the Brother Solutions Center at [support.brother.com](http://support.brother.com) to install drivers and software necessary for operating your device.



## Related Information

- [Additional Methods of Configuring Your Brother Machine for a Wireless Network](#)
  - [I Cannot Complete the Wireless Network Setup Configuration](#)
  - [How to Enter Text on Your Brother Machine](#)
  - [Wireless LAN Report Error Codes](#)
-

## Configure Your Machine for an Enterprise Wireless Network

**Related Models:** HL-L5200DW/HL-L5200DWT/HL-L6200DW/HL-L6200DWT/HL-L6300DW

>> [HL-L5200DW/HL-L5200DWT/HL-L6200DW/HL-L6200DWT](#)  
 >> [HL-L6300DW](#)

### HL-L5200DW/HL-L5200DWT/HL-L6200DW/HL-L6200DWT

Before configuring your machine, we recommend writing down your wireless network settings. You will need this information before you continue with the configuration.

1. Check and record the current wireless network settings.

Network Name (SSID)

Communication Mode	Authentication Method	Encryption Mode	User ID	Password
Infrastructure	LEAP	CKIP		
		AES		
	EAP-FAST/NONE	TKIP		
		AES		
	EAP-FAST/MS-CHAPv2	TKIP		
		AES		
	EAP-FAST/GTC	TKIP		
		AES		
	PEAP/MS-CHAPv2	TKIP		
		AES		
	PEAP/GTC	TKIP		
		AES		
	EAP-TTLS/CHAP	TKIP		
		AES		
	EAP-TTLS/MS-CHAP	TKIP		
		AES		
	EAP-TTLS/MS-CHAPv2	TKIP		
		AES		
	EAP-TTLS/PAP	TKIP		
		AES		
EAP-TLS	TKIP		-	
	AES		-	

For example:

Network Name (SSID)
HELLO



Communication Mode	Authentication Method	Encryption Mode	User ID	Password
Infrastructure	EAP-FAST/MS-CHAPv2	AES	Brother	12345678



- If you configure your machine using EAP-TLS authentication, you must install the client certificate issued by a CA before you start configuration. Contact your network administrator about the client certificate. If you have installed more than one certificate, we recommend writing down the certificate name you want to use.
- If you verify your machine using the common name of the server certificate, we recommend writing down the common name before you start configuration. Contact your network administrator about the common name of the server certificate.

2. Press ▲ or ▼ to select the [Network] option, and then press **OK**.
3. Press ▲ or ▼ to select the [WLAN] option, and then press **OK**.
4. Press ▲ or ▼ to select the [Setup Wizard] option, and then press **OK**.
5. When [WLAN Enable?] appears, press ▲ to select On.  
This will start the wireless setup wizard. To cancel, press **Cancel**.
6. The machine will search for your network and display a list of available SSIDs. Press ▲ or ▼ to select the [<New SSID>] option, and then press **OK**.
7. Enter the SSID name, and then press **OK**.
8. Press ▲ or ▼ to select the [Infrastructure] option, and then press **OK**.
9. Press ▲ or ▼ to select the Authentication Method you want, and then press **OK**.
10. Do one of the following:
  - If you selected the [LEAP] option, enter the user ID, and then press **OK**.  
Enter the Password, and then press **OK**.
  - If you selected the [EAP-FAST], [PEAP] or [EAP-TTLS] option, press ▲ or ▼ to select the Inner Authentication Method [NONE], [CHAP], [MS-CHAP], [MS-CHAPv2], [PAP] or [GTC], and then press **OK**.



Depending on your Authentication Method, the Inner Authentication Method selections differ.

Press ▲ or ▼ to select the Encryption Type [TKIP + AES] or [AES], and then press **OK**.

Press ▲ or ▼ to select the Verification Method [No Verification], [CA] or [CA+Server ID], and then press **OK**.

- If you selected the [CA+Server ID] option, enter the server ID, user ID and password (if required), and then press **OK** for each option.
- For other selections, enter the user ID and the Password, and then press **OK** for each option.



If you have not imported a CA certificate into your machine, the machine will display the message [No Verification].

- If you selected the [EAP-TLS] option, press ▲ or ▼ to select the Encryption Type [TKIP + AES] or [AES], and then press **OK**.  
When the machine displays a list of available Client Certificates, select the certificate you want.  
Press ▲ or ▼ to select the Verification Method [No Verification], [CA] or [CA+Server ID], and then press **OK**.
  - If you selected the [CA+Server ID] option, enter the server ID and user ID, and then press **OK** for each option.
  - For other selections, enter the user ID, and then press **OK**.



If you have not imported a CA certificate into your machine, the machine will display the message [No Verification].

11. To apply the settings, press ▲. To cancel, press ▼.
12. The machine will attempt to connect to the wireless device you have selected.

If your wireless device is connected successfully, the machine's LCD displays [Connected].

You have completed the wireless network setup. To install drivers and software necessary for operating your device, insert the Brother Installation CD-ROM to your computer or go to your model's **Downloads** page on the Brother Solutions Center at [support.brother.com](http://support.brother.com) to install drivers and software necessary for operating your device.

## HL-L6300DW

Before configuring your machine, we recommend writing down your wireless network settings. You will need this information before you continue with the configuration.

1. Check and record the current wireless network settings.

Network Name (SSID)

Communication Mode	Authentication Method	Encryption Mode	User ID	Password
Infrastructure	LEAP	CKIP		
		AES		
	EAP-FAST/NONE	TKIP		
		AES		
	EAP-FAST/MS-CHOPv2	TKIP		
		AES		
	EAP-FAST/GTC	TKIP		
		AES		
	PEAP/MS-CHAPv2	TKIP		
		AES		
	PEAP/GTC	TKIP		
		AES		
	EAP-TTLS/CHAP	TKIP		
		AES		
	EAP-TTLS/MS-CHAP	TKIP		
		AES		
	EAP-TTLS/MS-CHAPv2	TKIP		
		AES		
	EAP-TTLS/PAP	TKIP		
		AES		
EAP-TLS	TKIP			-
	AES			-

For example:

Network Name (SSID)
HELLO

Communication Mode	Authentication Method	Encryption Mode	User ID	Password
Infrastructure	EAP-FAST/MS-CHOPv2	AES	Brother	12345678



- If you configure your machine using EAP-TLS authentication, you must install the client certificate issued by a CA before you start configuration. Contact your network administrator about the client certificate. If you have installed more than one certificate, we recommend writing down the certificate name you want to use.
- If you verify your machine using the common name of the server certificate, we recommend writing down the common name before you start configuration. Contact your network administrator about the common name of the server certificate.

2. Press  [Settings] > [Network] > [WLAN] > [Setup Wizard].
3. When [Switch network interface to wireless?] appears, press [Yes].  
This will start the wireless setup wizard. To cancel, press [No].
4. The machine will search for your network and display a list of available SSIDs. Press ▲ or ▼ to display the [<New SSID>] option.
5. Press [<New SSID>].
6. Enter the SSID name, and then press [OK].



For more information about how to enter text, see the *User's Guide*.

7. Press [Infrastructure].
8. Press ▲ or ▼ to display the Authentication Method you want.
9. Press the Authentication Method you want.
10. Do one of the following:
  - If you selected the [LEAP] option, enter the user ID, and then press [OK]. Enter the Password, and then press [OK].
  - If you selected the [EAP-FAST], [PEAP] or [EAP-TTLS] option, press ▲ or ▼ to select the Inner Authentication Method [NONE], [CHAP], [MS-CHAP], [MS-CHAPv2], [GTC] or [PAP].



Depending on your Authentication Method, the Inner Authentication Method selections differ.

Press ▲ or ▼ to select the Encryption Type [TKIP+AES] or [AES].

Press ▲ or ▼ to select the Verification Method [No Verification], [CA] or [CA + Server ID].

- If you selected the [CA + Server ID] option, enter the server ID, user ID and password (if required), and then press [OK] for each option.
- For other selections, enter the user ID and Password, and then press [OK] for each option.



If you have not imported a CA certificate into your machine, the machine will display the message [No Verification].

- If you selected the [EAP-TLS] option, press ▲ or ▼ to select the Encryption Type [TKIP+AES] or [AES].  
When the machine displays a list of available Client Certificates, select the certificate you want.  
Press ▲ or ▼ to select the Verification Method [No Verification], [CA] or [CA + Server ID].
  - If you selected the [CA + Server ID] option, enter the server ID and user ID, and then press [OK] for each option.
  - For other selections, enter the user ID, and then press [OK].



If you have not imported a CA certificate into your machine, the machine will display the message [No Verification].

---

11. To apply the settings, press [Yes]. To cancel, press [No].

12. The machine attempts to connect to the wireless device you have selected.

If your wireless device is connected successfully, the machine's LCD displays [Connected].

You have completed the wireless network setup. To install drivers and software necessary for operating your device, insert the Brother Installation CD-ROM to your computer or go to your model's **Downloads** page on the Brother Solutions Center at [support.brother.com](http://support.brother.com) to install drivers and software necessary for operating your device.



### Related Information

- [Additional Methods of Configuring Your Brother Machine for a Wireless Network](#)
- [Wireless LAN Report Error Codes](#)

## Use Wi-Fi Direct®

- [Print from Your Mobile Device Using Wi-Fi Direct](#)
- [Configure Your Wi-Fi Direct Network](#)
- [I Cannot Complete the Wireless Network Setup Configuration](#)

## Print from Your Mobile Device Using Wi-Fi Direct

**Related Models:** HL-L5200DW/HL-L5200DWT/HL-L6200DW/HL-L6200DWT/HL-L6300DW

Wi-Fi Direct is one of the wireless configuration methods developed by the Wi-Fi Alliance®. It allows you to configure a secured wireless network between your Brother machine and a mobile device, such as an Android™ device, Windows Phone® device, iPhone, iPod touch, or iPad, without using an access point. Wi-Fi Direct supports wireless network configuration using the one-push or PIN Method of Wi-Fi Protected Setup™ (WPS). You can also configure a wireless network by manually setting an SSID and password. Your Brother machine's Wi-Fi Direct feature supports WPA2™ security with AES encryption.

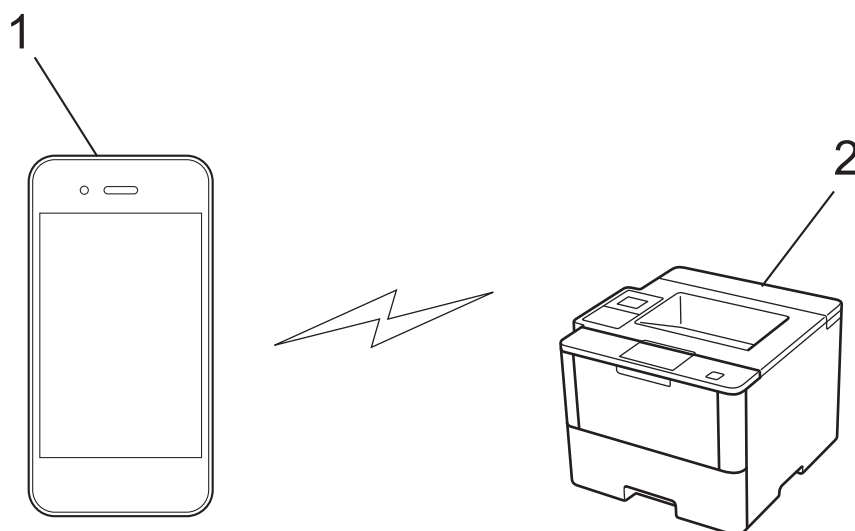

1. Mobile device
2. Your Brother machine



- Although the Brother machine can be used in both a wired and wireless network, only one connection method can be used at a time. However, a wireless network connection and Wi-Fi Direct connection, or a wired network connection (supported models only) and Wi-Fi Direct connection can be used at the same time.
- The Wi-Fi Direct-supported device can become a Group Owner (G/O). When configuring the Wi-Fi Direct network, the G/O serves as an access point.
- Ad-hoc mode and Wi-Fi Direct cannot be used at the same time. Disable one function to enable the other. If you want to use Wi-Fi Direct while you are using Ad-hoc mode, set Network I/F to Wired LAN or disable Ad-hoc mode and connect your Brother machine to the access point.



### Related Information

- [Use Wi-Fi Direct®](#)

## Configure Your Wi-Fi Direct Network

Configure your Wi-Fi Direct network settings from your machine's control panel.

- [Wi-Fi Direct Network Configuration Overview](#)
- [Configure Your Wi-Fi Direct Network Using the One-Push Method](#)
- [Configure Your Wi-Fi Direct Network Using the One-Push Method and Wi-Fi Protected Setup™ \(WPS\)](#)
- [Configure Your Wi-Fi Direct Network Using the PIN Method](#)
- [Configure Your Wi-Fi Direct Network Using the PIN Method of Wi-Fi Protected Setup™ \(WPS\)](#)
- [Configure Your Wi-Fi Direct Network Manually](#)

## Wi-Fi Direct Network Configuration Overview

**Related Models:** HL-L5200DW/HL-L5200DWT/HL-L6200DW/HL-L6200DWT/HL-L6300DW

The following instructions offer five methods for configuring your Brother machine in a wireless network environment. Select the method you prefer for your environment.

Check your mobile device for configuration.

1. Does your mobile device support Wi-Fi Direct?

Option	Description
Yes	Go to Step 2
No	Go to Step 3

2. Does your mobile device support one-push configuration for Wi-Fi Direct?

Option	Description
Yes	See <i>Related Information</i> : Configure Your Wi-Fi Direct Network Using the One-Push Method.
No	See <i>Related Information</i> : Configure Your Wi-Fi Direct Network Using the PIN Method.

3. Does your mobile device support Wi-Fi Protected Setup™ (WPS)?

Option	Description
Yes	Go to Step 4
No	See <i>Related Information</i> : Configure Your Wi-Fi Direct Network Manually.

4. Does your mobile device support one-push configuration for Wi-Fi Protected Setup™ (WPS)?

Option	Description
Yes	See <i>Related Information</i> : Configure Your Wi-Fi Direct Network Using the One-Push Method and Wi-Fi Protected Setup™ (WPS).
No	See <i>Related Information</i> : Configure Your Wi-Fi Direct Network Using the PIN Method of Wi-Fi Protected Setup™ (WPS).

To use Brother iPrint&Scan functionality in a Wi-Fi Direct network configured by one-push configuration using Wi-Fi Direct or by PIN Method configuration using Wi-Fi Direct, the device you use to configure Wi-Fi Direct must be running Android™ 4.0 or greater.



### Related Information

- [Configure Your Wi-Fi Direct Network](#)
- [Configure Your Wi-Fi Direct Network Using the One-Push Method](#)
- [Configure Your Wi-Fi Direct Network Using the One-Push Method and Wi-Fi Protected Setup™ \(WPS\)](#)
- [Configure Your Wi-Fi Direct Network Using the PIN Method](#)
- [Configure Your Wi-Fi Direct Network Using the PIN Method of Wi-Fi Protected Setup™ \(WPS\)](#)



- 
- [Configure Your Wi-Fi Direct Network Manually](#)
-

## Configure Your Wi-Fi Direct Network Using the One-Push Method

**Related Models:** HL-L5200DW/HL-L5200DWT/HL-L6200DW/HL-L6200DWT/HL-L6300DW

>> [HL-L5200DW/HL-L5200DWT/HL-L6200DW/HL-L6200DWT](#)  
>> [HL-L6300DW](#)

### HL-L5200DW/HL-L5200DWT/HL-L6200DW/HL-L6200DWT

If your mobile device supports Wi-Fi Direct, follow these steps to configure a Wi-Fi Direct network:

1. Press ▲ or ▼ to select the [Network] option, and then press **OK**.
2. Press ▲ or ▼ to select the [Wi-Fi Direct] option, and then press **OK**.
3. Press ▲ or ▼ to select the [Push Button] option, and then press **OK**.
4. When [Wi-Fi Direct On?] appears, press ▲ to accept. To cancel, press ▼.
5. Activate Wi-Fi Direct on your mobile device (see your mobile device's user's guide for instructions) when [Activate Wi-Fi Direct on other device and press OK.] appears on the machine's LCD. Press **OK** on your machine.

This will start the Wi-Fi Direct setup. To cancel, press **Cancel**.

6. Do one of the following:
  - When your Brother machine is the Group Owner (G/O), connect your mobile device to the machine directly.
  - When your Brother machine is not the G/O, it will display available device names with which to configure a Wi-Fi Direct network. Press ▲ or ▼ to select the mobile device you want to connect to and press **OK**. Search for available devices again by pressing [Rescan].
7. If your mobile device connects successfully, the machine's LCD displays [Connected]. You have completed the Wi-Fi Direct network setup. For information on printing from your mobile device, go to your model's **Manuals** page on the Brother Solutions Center at [support.brother.com](http://support.brother.com) to see the Mobile Print/Scan Guide for Brother iPrint&Scan.

### HL-L6300DW

If your mobile device supports Wi-Fi Direct, follow these steps to configure a Wi-Fi Direct network:

1. Press  [Settings] > [Network] > [Wi-Fi Direct] > [Push Button].
2. When [Wi-Fi Direct on?] appears, press [On] to accept. To cancel, press [Off].
3. Activate Wi-Fi Direct on your mobile device (see your mobile device's user's guide for instructions) when [Activate Wi-Fi Direct on other device. Then press [OK].] appears on the machine's LCD. Press [OK] on your Brother machine.

This will start the Wi-Fi Direct setup. To cancel, press .

4. Do one of the following:
  - When your Brother machine is the Group Owner (G/O), connect your mobile device to the machine directly.
  - When your Brother machine is not the G/O, it will display available device names with which to configure a Wi-Fi Direct network. Select the mobile device you want to connect to and press [OK]. Search for available devices again by pressing [Rescan].
5. If your mobile device connects successfully, the machine's LCD displays [Connected]. You have completed the Wi-Fi Direct network setup. For details on printing from your mobile device, go to your model's **Manuals** page on the Brother Solutions Center at [support.brother.com](http://support.brother.com) to see the Mobile Print/Scan Guide for Brother iPrint&Scan.



## Related Information

- [Configure Your Wi-Fi Direct Network](#)
  - [Wi-Fi Direct Network Configuration Overview](#)
-

## Configure Your Wi-Fi Direct Network Using the One-Push Method and Wi-Fi Protected Setup™ (WPS)

**Related Models:** HL-L5200DW/HL-L5200DWT/HL-L6200DW/HL-L6200DWT/HL-L6300DW

>> HL-L5200DW/HL-L5200DWT/HL-L6200DW/HL-L6200DWT  
>> HL-L6300DW

### HL-L5200DW/HL-L5200DWT/HL-L6200DW/HL-L6200DWT

If your mobile device supports WPS (PBC; Push Button Configuration), follow these steps to configure a Wi-Fi Direct network:

1. Press ▲ or ▼ to select the [Network] option, and then press **OK**.
2. Press ▲ or ▼ to select the [Wi-Fi Direct] option, and then press **OK**.
3. Press ▲ or ▼ to select the [Group Owner] option, and then press **OK**.
4. Press ▲ or ▼ to select the [On] option, and then press **OK**.
5. Press ▲ or ▼ to select the [Push Button] option, and then press **OK**.
6. When [Wi-Fi Direct On?] appears, press ▲ to accept. To cancel, press ▼.
7. Activate your mobile device's WPS one-push configuration method (see your mobile device's user's guide for instructions) when [Activate Wi-Fi Direct on other device and press OK.] appears on the machine's LCD. Press **OK** on your machine.

This will start the Wi-Fi Direct setup. To cancel, press **Cancel**.

8. If your mobile device connects successfully, the machine's LCD displays [Connected]. You have completed the Wi-Fi Direct network setup. For information on printing from your mobile device, go to your model's **Manuals** page on the Brother Solutions Center at [support.brother.com](http://support.brother.com) to see the Mobile Print/Scan Guide for Brother iPrint&Scan.

### HL-L6300DW

If your mobile device supports WPS (PBC; Push Button Configuration), follow these steps to configure a Wi-Fi Direct network.

1. Press  [Settings] > [Network] > [Wi-Fi Direct] > [Group Owner].
2. Press [On].
3. Press ▲ or ▼ to select the [Push Button] option. Press [Push Button].
4. When [Wi-Fi Direct on?] appears, press [On] to accept. To cancel, press [Off].
5. Activate your mobile device's WPS one-push configuration method (see your mobile device's user's guide for instructions) when [Activate Wi-Fi Direct on other device. Then press [OK].] appears on the machine's LCD. Press [OK] on your Brother machine.

This will start the Wi-Fi Direct setup. To cancel, press .

6. If your mobile device connects successfully, the machine's LCD displays [Connected]. You have completed the Wi-Fi Direct network setup. For details on printing from your mobile device, go to your model's **Manuals** page on the Brother Solutions Center at [support.brother.com](http://support.brother.com) to see the Mobile Print/Scan Guide for Brother iPrint&Scan.

### Related Information

- [Configure Your Wi-Fi Direct Network](#)



## Configure Your Wi-Fi Direct Network Using the PIN Method

**Related Models:** HL-L5200DW/HL-L5200DWT/HL-L6200DW/HL-L6200DWT/HL-L6300DW

>> HL-L5200DW/HL-L5200DWT/HL-L6200DW/HL-L6200DWT  
>> HL-L6300DW

### HL-L5200DW/HL-L5200DWT/HL-L6200DW/HL-L6200DWT

If your mobile device supports the PIN Method of Wi-Fi Direct, follow these steps to configure a Wi-Fi Direct network:

1. Press ▲ or ▼ to select the [Network] option, and then press **OK**.
2. Press ▲ or ▼ to select the [Wi-Fi Direct] option, and then press **OK**.
3. Press ▲ or ▼ to select the [PIN Code] option, and then press **OK**.
4. When [Wi-Fi Direct On?] appears, press ▲ to accept. To cancel, press ▼.
5. Activate Wi-Fi Direct on your mobile device (see your mobile device's user's guide for instructions) when [Activate Wi-Fi Direct on other device and press OK.] appears on the machine's LCD. Press **OK** on your machine.  
This will start the Wi-Fi Direct setup. To cancel, press **Cancel**.
6. Do one of the following:
  - When your Brother machine is the Group Owner (G/O), it will wait for a connection request from your mobile device. When [Input PIN Code] appears, enter the PIN displayed on your mobile device in your Brother machine. Press **OK** to complete the setup.  
If the PIN is displayed on your Brother machine, enter the PIN in your mobile device.
  - When your Brother machine is not the G/O, it will display available device names with which to configure a Wi-Fi Direct network. Press ▲ or ▼ to select the mobile device you want to connect to and press **OK**. Search for available devices again by pressing [Rescan], and then go to the next step.
7. Do one of the following:
  - Press ▲ to display the PIN on your Brother machine, enter the PIN in your mobile device, and then go to the next step.
  - Press ▼ to enter the PIN displayed by your mobile device in your Brother machine. Press **OK**, and then go to the next step.  
If your mobile device does not display a PIN, press **Cancel** on your Brother machine. Go back to the first step and try again.
8. If your mobile device connects successfully, the machine's LCD displays [Connected]. You have completed the Wi-Fi Direct network setup. For information on printing from your mobile device, go to your model's **Manuals** page on the Brother Solutions Center at [support.brother.com](http://support.brother.com) to see the Mobile Print/Scan Guide for Brother iPrint&Scan.

### HL-L6300DW

If your mobile device supports the PIN Method of Wi-Fi Direct, follow these steps to configure a Wi-Fi Direct network:

1. Press  [Settings] > [Network] > [Wi-Fi Direct] > [PIN Code].
2. When [Wi-Fi Direct on?] appears, press [On] to accept. To cancel, press [Off].
3. Activate Wi-Fi Direct on your mobile device (see your mobile device's user's guide for instructions) when [Activate Wi-Fi Direct on other device. Then press [OK].] appears on the machine's LCD. Press [OK] on your Brother machine.

---

This will start the Wi-Fi Direct setup. To cancel, press .

4. Do one of the following:

- When your Brother machine is the Group Owner (G/O), it will wait for a connection request from your mobile device. When [PIN Code] appears, enter the PIN displayed on your mobile device in the machine. Press [OK] to complete the setup.  
If the PIN is displayed on your Brother machine, enter the PIN in your mobile device.
- When your Brother machine is not the G/O, it will display available device names with which to configure a Wi-Fi Direct network. Select the mobile device to which you want to connect and press [OK]. Search for available devices again by pressing [Rescan], and then go to the next step.

5. Do one of the following:

- Press [Display PIN Code] to display the PIN on your machine and enter the PIN in your mobile device. Go to the next step.
- Press [Input PIN Code] to enter a PIN displayed by your mobile device in the machine, and then press [OK]. Go to the next step.

If your mobile device does not display a PIN, press  on your Brother machine. Go back to the first step and try again.

6. If your mobile device connects successfully, the machine's LCD displays [Connected]. You have completed the Wi-Fi Direct network setup. For details on printing from your mobile device, go to your model's **Manuals** page on the Brother Solutions Center at [support.brother.com](http://support.brother.com) to see the Mobile Print/Scan Guide for Brother iPrint&Scan.



## Related Information

- [Configure Your Wi-Fi Direct Network](#)
  - [Wi-Fi Direct Network Configuration Overview](#)
-

## Configure Your Wi-Fi Direct Network Using the PIN Method of Wi-Fi Protected Setup™ (WPS)

**Related Models:** HL-L5200DW/HL-L5200DWT/HL-L6200DW/HL-L6200DWT/HL-L6300DW

>> HL-L5200DW/HL-L5200DWT/HL-L6200DW/HL-L6200DWT  
>> HL-L6300DW

### HL-L5200DW/HL-L5200DWT/HL-L6200DW/HL-L6200DWT

If your mobile device supports the PIN Method of Wi-Fi Protected Setup™ (WPS), follow these steps to configure a Wi-Fi Direct network.

1. Press ▲ or ▼ to select the [Network] option, and then press **OK**.
2. Press ▲ or ▼ to select the [Wi-Fi Direct] option, and then press **OK**.
3. Press ▲ or ▼ to select the [Group Owner] option, and then press **OK**.
4. Press ▲ or ▼ to select the [On] option, and then press **OK**.
5. Press ▲ or ▼ to select the [PIN Code] option, and then press **OK**.
6. When [Wi-Fi Direct On?] appears, press ▲ to accept. To cancel, press ▼.
7. Activate your mobile device's WPS PIN configuration method (see your mobile device's user's guide for instructions) when [Activate Wi-Fi Direct on other device and press OK.] appears on the machine's LCD. Press **OK** on your machine.  
This will start the Wi-Fi Direct setup. To cancel, press **Cancel**.
8. The machine will wait for a connection request from your mobile device. When [Input PIN Code] appears, enter the PIN displayed on your mobile device in the machine.
9. Press **OK**.
10. If your mobile device connects successfully, the machine's LCD displays [Connected]. You have completed the Wi-Fi Direct network setup. For information on printing from your mobile device, go to your model's **Manuals** page on the Brother Solutions Center at [support.brother.com](http://support.brother.com) to see the Mobile Print/Scan Guide for Brother iPrint&Scan.

### HL-L6300DW

If your mobile device supports the PIN Method of Wi-Fi Protected Setup™ (WPS), follow these steps to configure a Wi-Fi Direct network.

1. Press  [Settings] > [Network] > [Wi-Fi Direct] > [Group Owner].
2. Press [On].
3. Press ▲ or ▼ to select the [PIN Code], and then press [OK].
4. When [Wi-Fi Direct on?] appears, press [On] to accept. To cancel, press [Off].
5. Activate your mobile device's WPS PIN configuration method (see your mobile device's user's guide for instructions) when [Activate Wi-Fi Direct on other device. Then press [OK].] appears on the machine's LCD.
6. Press [OK] on your Brother machine.

This will start the Wi-Fi Direct setup. To cancel, press .

7. The machine will wait for a connection request from your mobile device. When [PIN Code] appears, enter the PIN displayed on your mobile device in to the machine. Press [OK].
8. If your mobile device connects successfully, the machine's LCD displays [Connected]. You have completed the Wi-Fi Direct network setup. For details on printing from your mobile device, go to your model's **Manuals**



---

page on the Brother Solutions Center at [support.brother.com](http://support.brother.com) to see the Mobile Print/Scan Guide for Brother iPrint&Scan.



### **Related Information**

- [Configure Your Wi-Fi Direct Network](#)
  - [Wi-Fi Direct Network Configuration Overview](#)
-

## Configure Your Wi-Fi Direct Network Manually

**Related Models:** HL-L5200DW/HL-L5200DWT/HL-L6200DW/HL-L6200DWT/HL-L6300DW

>> [HL-L5200DW/HL-L5200DWT/HL-L6200DW/HL-L6200DWT](#)  
>> [HL-L6300DW](#)

### HL-L5200DW/HL-L5200DWT/HL-L6200DW/HL-L6200DWT

If your mobile device does not support Wi-Fi Direct or WPS, you must configure a Wi-Fi Direct network manually.

1. Press ▲ or ▼ to select the [Network] option, and then press **OK**.
2. Press ▲ or ▼ to select the [Wi-Fi Direct] option, and then press **OK**.
3. Press ▲ or ▼ to select the [Manual] option, and then press **OK**.
4. When [Wi-Fi Direct On?] appears, press ▲ to accept. To cancel, press ▼.
5. The machine will display the SSID name and Password for two minutes. Go to your mobile device's wireless network settings screen, select the SSID name, and then enter the password.
6. If your mobile device connects successfully, the machine's LCD displays [Connected]. You have completed the Wi-Fi Direct network setup. For information on printing from your mobile device, go to your model's **Manuals** page on the Brother Solutions Center at [support.brother.com](http://support.brother.com) to see the Mobile Print/Scan Guide for Brother iPrint&Scan or the AirPrint Guide.

### HL-L6300DW

If your mobile device does not support Wi-Fi Direct or WPS, you must configure a Wi-Fi Direct network manually.

1. Press  [Settings] > [Network] > [Wi-Fi Direct] > [Manual].
2. When [Wi-Fi Direct on?] appears, press [On] to accept. To cancel, press [Off].
3. The machine will display the SSID name and Password for two minutes. Go to your mobile device's wireless network settings screen, select the SSID name, and then enter the password.
4. If your mobile device connects successfully, the machine's LCD displays [Connected]. You have completed the Wi-Fi Direct network setup. For details on printing from your mobile device, go to your model's **Manuals** page on the Brother Solutions Center at [support.brother.com](http://support.brother.com) to see the Mobile Print/Scan Guide for Brother iPrint&Scan or the AirPrint Guide.

### Related Information

- [Configure Your Wi-Fi Direct Network](#)
- [Wi-Fi Direct Network Configuration Overview](#)

## Advanced Network Features

- [Print the Network Configuration Report](#)
- [Print the WLAN Report](#)
- [Configure the SNTP Protocol Using Web Based Management](#)

## Print the Network Configuration Report

**Related Models:** HL-L5100DN/HL-L5200DW/HL-L5200DWT/HL-L6200DW/HL-L6200DWT/HL-L6300DW

The Network Configuration Report lists the network configuration, including the network print server settings.





- **Node Name:** The Node Name appears on the current Network Configuration Report. The default Node Name is "BRNxxxxxxxxxxxx" for a wired network or "BRWxxxxxxxxxxxx" for a wireless network (where "xxxxxxxxxxxx" is your machine's MAC Address / Ethernet Address.)
- If the [IP Address] on the Network Configuration Report shows 0.0.0.0, wait for one minute and try printing it again.
- You can find your machine's settings, such as the IP address, subnet mask, node name, and MAC Address on the report, for example:
  - IP address: 192.168.0.5
  - Subnet mask: 255.255.255.0
  - Node name: BRN000ca0000499
  - MAC Address: 00-0c-a0-00-04-99

>> HL-L5100DN/HL-L5200DW/HL-L5200DWT/HL-L6200DW/HL-L6200DWT  
>> HL-L6300DW

### HL-L5100DN/HL-L5200DW/HL-L5200DWT/HL-L6200DW/HL-L6200DWT

1. Press ▲ or ▼ to select the [Machine Info.] option, and then press **OK**.
2. Press ▲ or ▼ to select [Print NetSetting].
3. Press **OK**.

### HL-L6300DW

1. Press  [Settings] > [Machine Information] > [Print NetSetting].
2. Press [OK].
3. Press .

### ✓ Related Information

- [Advanced Network Features](#)
- [Where Can I Find My Brother Machine's Network Settings?](#)
- [Use the Network Connection Repair Tool \(Windows®\)](#)
- [I Want to Check that My Network Devices are Working Correctly](#)
- [Access Web Based Management](#)
- [Configure the Gigabit Ethernet Settings Using Web Based Management](#)

## Print the WLAN Report

**Related Models:** HL-L5200DW/HL-L5200DWT/HL-L6200DW/HL-L6200DWT/HL-L6300DW

The WLAN Report reflects your machine's wireless status. If the wireless connection fails, check the error code on the printed report.

>> [HL-L5200DW/HL-L5200DWT/HL-L6200DW/HL-L6200DWT](#)



>> [HL-L6300DW](#)

### HL-L5200DW/HL-L5200DWT/HL-L6200DW/HL-L6200DWT

1. Press ▲ or ▼ to select the [Machine Info.] option, and then press **OK**.
2. Press ▲ or ▼ to select the [Print WLANReport] option, and then press **OK**.

The machine will print the WLAN Report.

### HL-L6300DW

1. Press  [Settings] > [Machine Information] > [Print WLANReport].
2. Press [OK].  
The machine will print the WLAN Report.
3. Press .

If the WLAN Report does not print, check your machine for errors. If there are no visible errors, wait for one minute and then try to print the report again.

### Related Information

- [Advanced Network Features](#)
- [Wireless LAN Report Error Codes](#)
- [My Brother Machine Cannot Print over the Network](#)
- [I Want to Check that My Network Devices are Working Correctly](#)

## Wireless LAN Report Error Codes

**Related Models:** HL-L5200DW/HL-L5200DWT/HL-L6200DW/HL-L6200DWT/HL-L6300DW

If the Wireless LAN Report shows that the connection failed, check the error code on the printed report and see the corresponding instructions in the table:

Error Code	Problem and Recommended Solutions
TS-01	<p>The wireless setting is not activated, change the wireless setting to ON.</p> <p>If a network cable is connected to your machine, disconnect it and change the wireless setting of your machine to ON.</p>
TS-02	<p>The wireless access point/router cannot be detected.</p> <ol style="list-style-type: none"><li>1. Check the following two points:<ul style="list-style-type: none"><li>• Unplug the power to your wireless access point/router, wait for 10 seconds, and then plug it back in.</li><li>• If your WLAN access point/router is using MAC address filtering, confirm that the MAC address of the Brother machine is allowed in the filter.</li></ul></li><li>2. If you manually entered the SSID and security information (SSID/authentication method/encryption method/Network Key), the information may be incorrect. Reconfirm the SSID and security information and re-enter the correct information as necessary. How to confirm wireless security information (SSID/authentication method/encryption method/Network Key)<ol style="list-style-type: none"><li>a. The Default security settings may be provided on a label attached to the WLAN access point/router. Or the manufacturer's name or model no. of the WLAN access point/router may be used as the default security settings.</li><li>b. See the documentation provided with your WLAN access point/router for information on how to find the security settings.</li></ol><ul style="list-style-type: none"><li>• If WLAN access point/router is set to not broadcast the SSID, the SSID will not automatically be detected. You will have to manually enter the SSID name.</li><li>• The Network key may also be described as the Password, Security Key or Encryption Key.</li></ul><p>This device does not support a 5GHz SSID/ESSID and you must select a 2.4 GHz SSID/ESSID. Make sure the access point/router is set to 2.4 GHz or 2.4 GHz/5 GHz mixed mode.</p><p>If you do not know the SSID and wireless security settings of your WLAN access point/router or how to change the configuration, see the documentation provided with your WLAN access point/router, ask the manufacturer of your access point/router or ask to your Internet provider or network administrator.</p></li></ol>
TS-03	<p>The wireless network and security setting you entered may be incorrect. Reconfirm the wireless network settings.</p> <p>If you do not know this information, ask your network administrator.</p>

Error Code	Problem and Recommended Solutions
TS-04	<p>The Authentication/Encryption methods used by the selected wireless access point/router are not supported by your machine.</p> <p>For infrastructure mode, change the authentication and encryption methods of the wireless access point/router. Your machine supports the following authentication methods:</p> <ul style="list-style-type: none"> <li>• WPA-Personal TKIP or AES</li> <li>• WPA2-Personal AES</li> <li>• Open WEP or None (without encryption)</li> <li>• Shared key WEP</li> </ul> <p>If your problem is not solved, the SSID or network settings you entered may be incorrect. Confirm the wireless network settings.</p> <p>For Ad-Hoc Mode, change the authentication and encryption methods of your computer for the wireless setting. Your machine supports Open authentication only, with optional WEP encryption.</p>
TS-05	<p>The security information (SSID/Network Key) is incorrect.</p> <p>Confirm the SSID and Network Key. If your router uses WEP encryption, enter the key used as the first WEP key. Your Brother machine supports the use of the first WEP key only.</p>
TS-06	<p>The wireless security information (Authentication method/Encryption method/Network Key) is incorrect.</p> <p>Confirm the wireless security information (Authentication method/Encryption method/Network Key) listed in TS-04. If your router uses WEP encryption, enter the key used as the first WEP key. Your Brother machine supports the use of the first WEP key only.</p>
TS-07	<p>The machine cannot detect a WLAN access point/router that has WPS enabled.</p> <p>If you would like to connect with WPS, you must operate both your machine and the WLAN access point/router. Confirm the connection method for WPS on WLAN access point/router and try starting again.</p> <p>If you do not know how to operate your WLAN access point/router using WPS, see the documentation provided with your WLAN access point/router, ask the manufacturer of your WLAN access point/router or ask your network administrator.</p>
TS-08	<p>Two or more WLAN access points that have WPS enabled are detected.</p> <ul style="list-style-type: none"> <li>• Confirm that only one WLAN access point/router within range has the WPS method active and try again.</li> <li>• Try starting again after few minutes in order to avoid effects from other access points.</li> </ul>



## Related Information

- [Print the WLAN Report](#)
- [My Brother Machine Cannot Print over the Network](#)
- [I Want to Check that My Network Devices are Working Correctly](#)
- [Configure Your Machine for a Wireless Network Using the One Push Method of Wi-Fi Protected Setup™ \(WPS\)](#)
- [Configure Your Machine for a Wireless Network Using the PIN Method of Wi-Fi Protected Setup™ \(WPS\)](#)
- [Configure Your Machine for a Wireless Network in Ad-Hoc Mode Using an Existing SSID](#)
- [Configure Your Machine for a Wireless Network in Ad-Hoc Mode Using a New SSID](#)
- [Configure Your Machine for a Wireless Network Using the Machine's Control Panel Setup Wizard](#)
- [Configure Your Machine for a Wireless Network When the SSID Is Not Broadcast](#)
- [Configure Your Machine for an Enterprise Wireless Network](#)

## Configure the SNTP Protocol Using Web Based Management

**Related Models:** HL-L5100DN/HL-L5200DW/HL-L5200DWT/HL-L6200DW/HL-L6200DWT/HL-L6300DW

Configure the SNTP protocol to synchronize the time the machine uses for authentication with the time kept by the SNTP time server.

1. Start your web browser.
2. Type "http://machine's IP address" in your browser's address bar (where "machine's IP address" is the machine's IP address).

For example:

http://192.168.1.2

3. No password is required by default. Type a password if you have set one, and then click .
4. Click the **Network** tab.
5. Click **Protocol** in the left navigation bar.
6. Select the **SNTP** check box to activate the settings.
7. Next to the SNTP check box, click **Advanced Settings** and follow the instructions below:

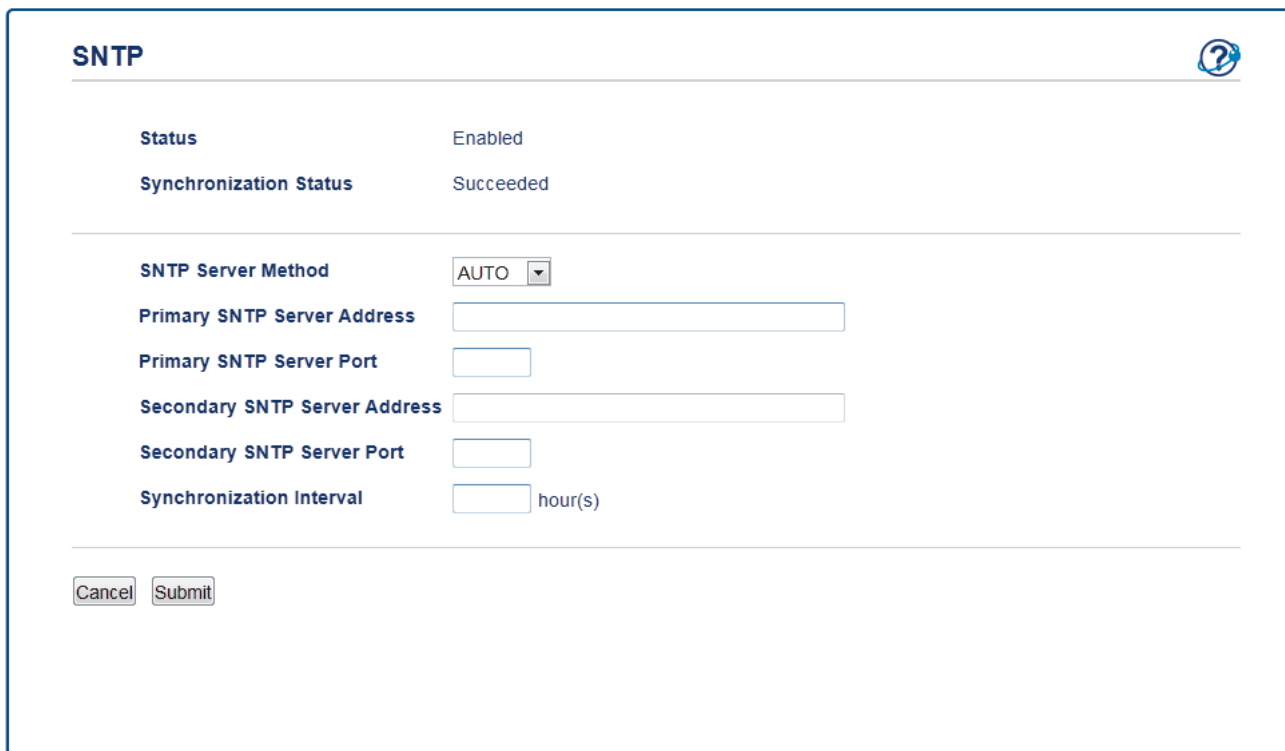

Option	Description
<b>Status</b>	Displays whether the SNTP protocol is enabled or disabled.
<b>Synchronization Status</b>	Confirm the latest synchronization status.
<b>SNTP Server Method</b>	Select <b>AUTO</b> or <b>STATIC</b> . <ul style="list-style-type: none"><li>• <b>AUTO</b> If you have a DHCP server in your network, the SNTP server will obtain the address from that server automatically.</li><li>• <b>STATIC</b> Type the address you want to use.</li></ul>



---

Option	Description
<b>Primary SNTP Server Address</b>	Type the server address (up to 64 characters).
<b>Secondary SNTP Server Address</b>	The secondary SNTP server address is used as a backup to the primary SNTP server address. If the primary server is unavailable, the machine will contact the secondary SNTP server.
<b>Primary SNTP Server Port</b>	Type the port number (1-65535).
<b>Secondary SNTP Server Port</b>	The secondary SNTP server port is used as a backup to the primary SNTP server port. If the primary port is unavailable, the machine will contact the secondary SNTP port.
<b>Synchronization Interval</b>	Type the number of hours between server synchronization attempts (1-168 hours).

8. Click **Submit**.



### Related Information

- [Advanced Network Features](#)
-

## Technical Information for Advanced Users

- [Gigabit Ethernet \(Wired Network Only\)](#)
- [Reset the Network Settings to the Factory Settings](#)

## Gigabit Ethernet (Wired Network Only)

**Related Models:** HL-L6200DW/HL-L6200DWT/HL-L6300DW

Your machine supports 1000BASE-T Gigabit Ethernet. To connect to a 1000BASE-T Gigabit Ethernet Network, you must set the machine's Ethernet link mode to Auto from the machine's control panel or Auto from Web Based Management (web browser).



- Use a straight-through Category 5 (or greater) twisted-pair cable for 10BASE-T, 100BASE-TX Fast Ethernet Network, or 1000BASE-T Gigabit Ethernet Network. When you connect the machine to a Gigabit Ethernet Network, use the network devices complying with 1000BASE-T.



### Related Information

- [Technical Information for Advanced Users](#)
- [Configure the Gigabit Ethernet Settings Using Web Based Management](#)

## Configure the Gigabit Ethernet Settings Using Web Based Management

**Related Models:** HL-L6200DW/HL-L6200DWT/HL-L6300DW

1. Start your web browser.
2. Type "http://machine's IP address" in your browser's address bar (where "machine's IP address" is the machine's IP address).  
For example:  
http://192.168.1.2
3. No password is required by default. Type a password if you have set one, and then click .
4. Click the **Network** tab.
5. Click **Wired**.
6. Click **Ethernet** in the left navigation bar.
7. Select **Auto** from the **Ethernet Mode** drop-down list.
8. Click **Submit**.
9. To enable the settings, restart your machine.

You can confirm your settings by printing the Network Configuration Report.

### Related Information

- [Gigabit Ethernet \(Wired Network Only\)](#)
- [Print the Network Configuration Report](#)

## Reset the Network Settings to the Factory Settings

**Related Models:** HL-L5100DN/HL-L5200DW/HL-L5200DWT/HL-L6200DW/HL-L6200DWT/HL-L6300DW

You can use your machine's control panel to reset the print server to its default factory settings. This resets all information, such as the password and IP address.



- This feature restores all wired (supported models only) and wireless network settings to the factory settings.
- You can also reset the print server to its factory settings using BRAdmin Light, BRAdmin Professional 3, or Web Based Management.

>> [HL-L5100DN/HL-L5200DW/HL-L5200DWT/HL-L6200DW/HL-L6200DWT](#)  
>> [HL-L6300DW](#)

### HL-L5100DN/HL-L5200DW/HL-L5200DWT/HL-L6200DW/HL-L6200DWT

1. Press ▲ or ▼ to select the [Network] option, and then press **OK**.
2. Press ▲ or ▼ to select the [Network Reset] option, and then press **OK**.
3. Press ▲ for [Yes].  
The machine will restart.

### HL-L6300DW

1. Press  [Settings] > [Network] > [Network Reset] > [Yes].
2. Press [Yes] for two seconds to confirm.  
The machine will restart.



### Related Information

- [Technical Information for Advanced Users](#)

## Security

- [Lock the Machine Settings](#)
- [Network Security Features](#)

## Lock the Machine Settings

Before turning on the machine's Access Lock, make a careful note of your password. If you forget the password, you must reset all passwords stored in the machine by contacting your administrator or Brother Customer Service.

- [About Using Setting Lock](#)

## About Using Setting Lock

Use the Setting Lock feature to block unauthorized access to machine settings.

When Setting Lock is set to [On], you cannot access the machine settings without entering the password.

- [Set the Setting Lock Password](#)
- [Change the Setting Lock Password](#)
- [Turn On Setting Lock](#)





## Set the Setting Lock Password

>> HL-L5000D/HL-L5100DN/HL-L5200DW/HL-L5200DWT/HL-L6200DW/HL-L6200DWT  
>> HL-L6300DW

### HL-L5000D/HL-L5100DN/HL-L5200DW/HL-L5200DWT/HL-L6200DW/HL-L6200DWT

1. Press ▲ or ▼ to display the [General Setup] option, and then press **OK**.
2. Press ▲ or ▼ to display the [Setting Lock] option, and then press **OK**.
3. Enter a four-digit number for the password.  
To enter each digit, press ▲ or ▼ to select a number, and then press **OK**.
4. When the LCD displays [Verify], re-enter the new password.
5. Press **Go**.

### HL-L6300DW

1. Press  [Settings] > [General Setup] > [Setting Lock].
2. Enter a four-digit number for the password.
3. Press [OK].
4. When the LCD displays [Verify], re-enter the new password.
5. Press [OK].
6. Press .

### Related Information

- [About Using Setting Lock](#)



## Change the Setting Lock Password

>> [HL-L5000D/HL-L5100DN/HL-L5200DW/HL-L5200DWT/HL-L6200DW/HL-L6200DWT](#)  
>> [HL-L6300DW](#)

### HL-L5000D/HL-L5100DN/HL-L5200DW/HL-L5200DWT/HL-L6200DW/HL-L6200DWT

1. Press ▲ or ▼ to display the [General Setup] option, and then press **OK**.
2. Press ▲ or ▼ to display the [Setting Lock] option, and then press **OK**.
3. Press ▲ or ▼ to select the [Set Password] option, and then press **OK**.
4. Enter the current four-digit password.  
To enter each digit, press ▲ or ▼ to select a number, and then press **OK**.
5. Enter a new four-digit password.  
To enter each digit, press ▲ or ▼ to select a number, and then press **OK**.
6. When the LCD displays [Verify], re-enter the new password.
7. Press **Go**.

### HL-L6300DW

1. Press  [Settings] > [General Setup] > [Setting Lock] > [Set Password].
2. Enter the current four-digit password.
3. Press [OK].
4. Enter a new four-digit password.
5. Press [OK].
6. When the LCD displays [Verify], re-enter the new password.
7. Press [OK].
8. Press .

### Related Information

- [About Using Setting Lock](#)

## Turn On Setting Lock

>> HL-L5000D/HL-L5100DN/HL-L5200DW/HL-L5200DWT/HL-L6200DW/HL-L6200DWT  
>> HL-L6300DW

### HL-L5000D/HL-L5100DN/HL-L5200DW/HL-L5200DWT/HL-L6200DW/HL-L6200DWT

1. Press ▲ or ▼ to display the [General Setup] option, and then press **OK**.
2. Press ▲ or ▼ to display the [Setting Lock] option, and then press **OK**.
3. Press **OK** when the LCD displays [On].
4. Enter the current four-digit password.  
To enter each digit, press ▲ or ▼ to select a number, and then press **OK**.



To turn [Off] Setting Lock, press **OK**. Press ▲ to select [Yes] when the LCD displays [Unlock?], enter the current four-digit password, and then press **OK**.

### HL-L6300DW

1. Press  [Settings] > [General Setup] > [Setting Lock] > [Lock Off⇒On].
2. Enter the current four-digit password.
3. Press [OK].



To turn [Off] Setting Lock, press  on the LCD, enter the current four-digit password, and then press [OK].

### Related Information

- [About Using Setting Lock](#)

## Network Security Features

- [Before Using Network Security Features](#)
- [Secure Function Lock 3.0](#)
- [Use Active Directory® Authentication](#)
- [Use LDAP Authentication](#)
- [Manage Your Network Machine Securely Using SSL/TLS](#)
- [Manage Your Network Machine Securely Using IPsec](#)
- [Send an Email Securely](#)
- [Use IEEE 802.1x Authentication for a Wired or a Wireless Network](#)
- [Store Print Log to Network](#)

## Before Using Network Security Features

**Related Models:** HL-L5100DN/HL-L5200DW/HL-L5200DWT/HL-L6200DW/HL-L6200DWT/HL-L6300DW

Your Brother machine employs some of the latest network security and encryption protocols available today. These network features can be integrated into your overall network security plan to help protect your data and prevent unauthorized access to the machine.



We recommend disabling the Telnet, FTP server and TFTP protocols. Accessing the machine using these protocols is not secure.



### Related Information

- [Network Security Features](#)

## Secure Function Lock 3.0

Brother's Secure Function Lock 3.0 increases security by restricting the functions available on your Brother machine.

- [Before Using Secure Function Lock 3.0](#)
- [Configure Secure Function Lock 3.0 Using Web Based Management](#)
- [Configure Public Mode for Secure Function Lock 3.0](#)
- [Additional Secure Function Lock 3.0 Features](#)
- [Register a new ID Card Using Machine's Control Panel](#)

## Before Using Secure Function Lock 3.0

**Related Models:** HL-L5100DN/HL-L5200DW/HL-L5200DWT/HL-L6200DW/HL-L6200DWT/HL-L6300DW

Use Secure Function Lock to configure passwords, set specific user page limits, and grant access to some or all of the functions listed here.

You can configure and change the following Secure Function Lock 3.0 settings using Web Based Management or BRAdmin Professional 3 (Windows®):

- **Print**

Print includes print jobs sent via AirPrint, Google Cloud Print™ and Brother iPrint&Scan.

If you register users' login names in advance, the users will not need to enter their passwords when they use the print function.

- **Page Limits**

- **Web Connect** (supported models only)

- **Apps** (supported models only)

- **Page Counters**

- **Card ID (NFC ID)** (supported models only)

If you register users' Card IDs in advance, a registered user can activate the machine by touching his registered card to the machine's NFC logo.



### Related Information

- [Secure Function Lock 3.0](#)

## Configure Secure Function Lock 3.0 Using Web Based Management

**Related Models:** HL-L5100DN/HL-L5200DW/HL-L5200DWT/HL-L6200DW/HL-L6200DWT/HL-L6300DW

1. Start your web browser.
2. Type "http://machine's IP address" in your browser's address bar (where "machine's IP address" is the machine's IP address).  
For example:  
http://192.168.1.2
3. Click the **Administrator** tab.
4. Click the **User Restriction Function** menu in the left navigation bar.
5. Select **Secure Function Lock**.
6. Click **Submit**.
7. Click the **Restricted Functions** menu in the left navigation bar.
8. In the **User List / Restricted Functions** field, type a group name or user name (alphanumeric, up to 15 digits).
9. In the **Print** and the other columns, select a check box to allow or clear a check box to restrict the function listed.
10. To configure the maximum page count, select the **On** check box in the **Page Limits** column, and then type the maximum number in the **Max. Pages** field.
11. Click **Submit**.
12. Click the **User List** menu in the left navigation bar.
13. In the **User List** field, type the user name.
14. In the **PIN Number** field, type a four-digit password.
15. To register the user's Card ID, type the card number in the **Card ID (NFC ID)** field (Available only for certain models).
16. Click the **Output** drop-down list, and then select the output tray for each user (Available only for certain models).
17. Select **User List / Restricted Functions** from the drop-down list for each user.
18. Click **Submit**.



### Related Information

- [Secure Function Lock 3.0](#)
- [Assign a Mailbox Bin to a User or Group](#)



## Configure Public Mode for Secure Function Lock 3.0

**Related Models:** HL-L5100DN/HL-L5200DW/HL-L5200DWT/HL-L6200DW/HL-L6200DWT/HL-L6300DW

Use the Secure Function Lock screen to set up Public Mode, which limits the functions available to public users. Public users will not need to enter a password to access the features made available through Public Mode settings.



Public Mode includes print jobs sent via AirPrint, Google Cloud Print™ and Brother iPrint&Scan.

1. Start your web browser.
2. Type "http://machine's IP address" in your browser's address bar (where "machine's IP address" is the machine's IP address).  
For example:  
http://192.168.1.2
3. Click the **Administrator** tab.
4. Click the **User Restriction Function** menu in the left navigation bar.
5. Select **Secure Function Lock**.
6. Click **Submit**.
7. Click the **Restricted Functions** menu.
8. In the **Public Mode** row, select a check box to allow or clear a check box to restrict the function listed.
9. Click **Submit**.



### Related Information

- [Secure Function Lock 3.0](#)

## Additional Secure Function Lock 3.0 Features

**Related Models:** HL-L5100DN/HL-L5200DW/HL-L5200DWT/HL-L6200DW/HL-L6200DWT/HL-L6300DW

Configure the following features in the Secure Function Lock screen:

### All Counter Reset

Click **All Counter Reset**, in the **Page Counters** column, to reset the page counter.

### Export to CSV file

Click **Export to CSV file**, to export the current page counter including **User List / Restricted Functions** information as a CSV file.

### Card ID (NFC ID) (supported models only)

Click the **User List** menu, and then type a users' Card ID in the **Card ID (NFC ID)** field. You can use your ID card for authentication.

### Output (available models only)

When the Mailbox unit is installed on your machine, select the output tray for each user from the drop-down list.

### Last Counter Record

Click **Last Counter Record** if you want the machine to retain the page count after the counter has been reset.



### Related Information

- [Secure Function Lock 3.0](#)

## Register a new ID Card Using Machine's Control Panel

Related Models: HL-L6300DW

1. Touch the NFC logo on the machine's control panel with a registered ID Card.
2. Press [Register Card].
3. Touch a new ID Card to the NFC logo.

The new ID Card's number is registered to the machine.



For the supported ID Card types, go to the Brother Solutions Center at [support.brother.com](https://support.brother.com) to see **FAQs & Troubleshooting**.



### Related Information

- [Secure Function Lock 3.0](#)

## Use Active Directory® Authentication

- [Introduction to Active Directory® Authentication](#)
- [Configure Active Directory® Authentication Using Web Based Management](#)
- [Log On to Change the Machine Settings Using the Machine's Control Panel \(Active Directory® Authentication\)](#)

## Introduction to Active Directory® Authentication

**Related Models:** HL-L6300DW

Active Directory® Authentication restricts the use of your Brother machine. If Active Directory® Authentication is enabled, the machine's control panel will be locked. You cannot change the machine's settings until you enter a User ID and password.

Active Directory® Authentication offers the following feature:

- Stores incoming print data

You can change the Active Directory® Authentication settings using Web Based Management or BRAdmin Professional 3 (Windows®).

### Related Information

- [Use Active Directory® Authentication](#)

## Configure Active Directory® Authentication Using Web Based Management

Related Models: HL-L6300DW

Active Directory® authentication supports Kerberos authentication and NTLMv2 authentication. You must configure the SNTP protocol (network time server) and DNS server configuration for authentication.

1. Start your web browser.
2. Type "http://machine's IP address" in your browser's address bar (where "machine's IP address" is the machine's IP address).

For example:

http://192.168.1.2

3. Click the **Administrator** tab.
4. Click the **User Restriction Function** menu in the left navigation bar.
5. Select **Active Directory Authentication**.
6. Click **Submit**.
7. Select **Active Directory Authentication** in the left navigation bar.
8. Configure the following settings:

Option	Description
<b>Storage PC Print Data</b>	Select this option to store incoming print data. After you log on to the machine, your PC print jobs will be printed automatically. This feature is available only for print data created by a Brother native printer driver.
<b>Remember User ID</b>	Select this option to save your User ID.
<b>Active Directory Server Address</b>	Type the IP address or the server name (for example: ad.example.com) of the Active Directory® Server.
<b>Active Directory Domain Name</b>	Type the Active Directory® domain name.
<b>Protocol &amp; Authentication Method</b>	Select the protocol and authentication method.
<b>LDAP Server Port</b>	Type the LDAP server port number (available only for <b>LDAP + kerberos</b> authentication method).

9. Click **Submit**.



### Related Information

- [Use Active Directory® Authentication](#)

## Log On to Change the Machine Settings Using the Machine's Control Panel (Active Directory® Authentication)

**Related Models:** HL-L6300DW

When Active Directory® Authentication is enabled, the machine's control panel will be locked until you enter your User ID and password on the machine's control panel.

1. On the machine's control panel, enter your User ID.
2. Press [Login].
3. Enter your password.
4. Press [OK].
5. When authentication is successful, the machine's control panel will be unlocked.



### Related Information

- [Use Active Directory® Authentication](#)

## Use LDAP Authentication

- [Introduction to LDAP Authentication](#)
- [Configure LDAP Authentication Using Web Based Management](#)
- [Log On to Change the Machine Settings Using the Machine's Control Panel \(LDAP Authentication\)](#)



## Introduction to LDAP Authentication

**Related Models:** HL-L6300DW

LDAP Authentication restricts the use of your Brother machine. If LDAP Authentication is enabled, the machine's control panel will be locked. You cannot change the machine's settings until you enter a User ID and password.

LDAP Authentication offers the following feature:

- Stores incoming print data

You can change the LDAP Authentication settings using Web Based Management or BRAdmin Professional 3 (Windows®).



### Related Information

- [Use LDAP Authentication](#)

## Configure LDAP Authentication Using Web Based Management

Related Models: HL-L6300DW

1. Start your web browser.
2. Type "http://machine's IP address" in your browser's address bar (where "machine's IP address" is the machine's IP address).  
For example:  
http://192.168.1.2
3. Click the **Administrator** tab.
4. Click the **User Restriction Function** menu in the left navigation bar.
5. Select **LDAP Authentication**.
6. Click **Submit**.
7. Click **LDAP Authentication** in the left navigation bar.
8. Configure the following settings:

Option	Description
<b>Storage PC Print Data</b>	Select this option to store incoming print data. After you log on to the machine, your PC print jobs will be printed automatically. This feature is available only for print data created by a Brother native printer driver.
<b>Remember User ID</b>	Select this option to save your User ID.
<b>LDAP Server Address</b>	Type the IP address or the server name (for example: ad.example.com) of the LDAP server.
<b>LDAP Server Port</b>	Type the LDAP server port number.

9. Click **Submit**.



### Related Information

- [Use LDAP Authentication](#)

## Log On to Change the Machine Settings Using the Machine's Control Panel (LDAP Authentication)

**Related Models:** HL-L6300DW

When LDAP Authentication is enabled, the machine's control panel will be locked until you enter your User ID and password on the machine's control panel.

1. On the machine's control panel, enter your User ID and Password.
2. Press [Login].
3. When authentication is successful, the machine's control panel will be unlocked.



### Related Information

- [Use LDAP Authentication](#)

## Manage Your Network Machine Securely Using SSL/TLS

- [Introduction to SSL/TLS](#)
- [Certificates and Web Based Management](#)
- [Manage Your Network Machine Securely Using Web Based Management](#)
- [Manage Your Network Machine Securely Using BRAdmin Professional 3 \(Windows®\)](#)
- [Print Documents Securely Using SSL/TLS](#)

## Introduction to SSL/TLS

**Related Models:** HL-L5100DN/HL-L5200DW/HL-L5200DWT/HL-L6200DW/HL-L6200DWT/HL-L6300DW

Secure Socket Layer (SSL) or Transport Layer Security (TLS) is an effective method of protecting data sent over a local or wide area network (LAN or WAN). It works by encrypting data, such as a print job, sent over a network, so anyone trying to capture it will not be able to read it.

SSL/TLS can be configured on both wired and wireless networks and will work with other forms of security such as WPA keys and firewalls.



### Related Information

- [Manage Your Network Machine Securely Using SSL/TLS](#)
- [Brief History of SSL/TLS](#)
- [Benefits of Using SSL/TLS](#)

## Brief History of SSL/TLS

**Related Models:** HL-L5100DN/HL-L5200DW/HL-L5200DWT/HL-L6200DW/HL-L6200DWT/HL-L6300DW

SSL/TLS was originally created to secure web traffic information, particularly data sent between web browsers and servers. For example, when you use Internet Explorer® for Internet Banking and you see https:// and the little padlock icon in the web browser, you are using SSL. SSL grew to work with additional applications, such as Telnet, printer, and FTP software, in order to become a universal solution for online security. Its original design intentions are still being used today by many online retailers and banks to secure sensitive data, such as credit card numbers, customer records, etc.

SSL/TLS uses extremely high levels of encryption and is trusted by banks all over the world.



### Related Information

- [Introduction to SSL/TLS](#)

## Benefits of Using SSL/TLS

**Related Models:** HL-L5100DN/HL-L5200DW/HL-L5200DWT/HL-L6200DW/HL-L6200DWT/HL-L6300DW

The primary benefit of using SSL/TLS on Brother machines is to guarantee secure printing over an IP network by restricting unauthorized users from reading data sent to the machine. SSL's key selling point is that it can be used to print confidential data securely. For example, an HR department in a large company may be printing wage slips on a regular basis. Without encryption, the data contained on these wages slips can be read by other network users. However, with SSL/TLS, anyone trying to capture the data will see a confusing page of code and not the actual wage slip.



### Related Information

- [Introduction to SSL/TLS](#)

## Certificates and Web Based Management

You must configure a certificate to manage your networked Brother machine securely using SSL/TLS. You must use Web Based Management to configure a certificate.

- [Supported Security Certificate Features](#)
- [Create and Install a Certificate](#)
- [Manage Multiple Certificates](#)



## Supported Security Certificate Features

**Related Models:** HL-L5100DN/HL-L5200DW/HL-L5200DWT/HL-L6200DW/HL-L6200DWT/HL-L6300DW

Your Brother machine supports the use of multiple security certificates, which allows secure management, authentication, and communication with the machine. The following security certificate features can be used with the machine:

- SSL/TLS communication
- SSL communication for SMTP
- IEEE 802.1x authentication
- IPsec

The Brother machine supports the following:

- Pre-installed certificate

Your machine has a pre-installed self-signed certificate. This certificate enables you to use SSL/TLS communication without creating or installing a different certificate.



The pre-installed self-signed certificate cannot protect your communication from being compromised. We recommend using a certificate that is issued by a trusted organization for better security.

- Self-signed certificate

This print server issues its own certificate. Using this certificate, you can easily use the SSL/TLS communication without creating or installing a different certificate from a CA.

- Certificate from a Certificate Authority (CA)

There are two methods for installing a certificate from a CA. If you already have a certificate from a CA or if you want to use a certificate from an external trusted CA:

- When using a Certificates Signing Request (CSR) from this print server.
- When importing a certificate and a private key.

- Certificate Authority (CA) Certificate

To use a CA certificate that identifies the CA and owns its private key, you must import that CA certificate from the CA before configuring the security features of the Network.



- If you are going to use SSL/TLS communication, we recommend contacting your system administrator first.
- When you reset the print server back to its default factory settings, the certificate and the private key that are installed will be deleted. If you want to keep the same certificate and the private key after resetting the print server, export them before resetting, and then reinstall them.



### Related Information

- [Certificates and Web Based Management](#)

## **Create and Install a Certificate**

- [Step by Step Guide for Creating and Installing a Certificate](#)
- [Create and Install a Self-signed Certificate](#)
- [Create and Install a Certificate from a Certificate Authority \(CA\)](#)
- [Import and Export a CA Certificate](#)

## Step by Step Guide for Creating and Installing a Certificate

**Related Models:** HL-L5100DN/HL-L5200DW/HL-L5200DWT/HL-L6200DW/HL-L6200DWT/HL-L6300DW

There are two options when choosing a security certificate: use a self-signed certificate or use a certificate from a Certificate Authority (CA).

These are a brief summary of the actions required, based on the option you choose.

### Option 1

#### Self-Signed Certificate

1. Create a self-signed certificate using Web Based Management.
2. Install the self-signed certificate on your computer.

### Option 2

#### Certificate from a CA

1. Create a Certificate Signing Request (CSR) using Web Based Management.
2. Install the certificate issued by the CA on your Brother machine using Web Based Management.
3. Install the certificate on your computer.



#### Related Information

- [Create and Install a Certificate](#)

## Create and Install a Self-signed Certificate

- [Create a Self-signed Certificate](#)
- [Install the Self-signed Certificate for Windows® users with Administrator Rights](#)
- [Import and Export the Self-signed Certificate on your Brother Machine](#)

## Create a Self-signed Certificate

**Related Models:** HL-L5100DN/HL-L5200DW/HL-L5200DWT/HL-L6200DW/HL-L6200DWT/HL-L6300DW

1. Start your web browser.
2. Type "http://machine's IP address" in your browser's address bar (where "machine's IP address" is the machine's IP address).

For example:

http://192.168.1.2



- If you are using a Domain Name System or enable a NetBIOS name, you can type another name, such as "SharedPrinter" instead of the IP address.

- For example:

http://SharedPrinter

If you enable a NetBIOS name, you can also use the node name.

- For example:

http://brnxxxxxxxxxxxx

The NetBIOS name can be found in the Network Configuration Report.

- For Macintosh, access Web Based Management by clicking the machine's icon on the **Status Monitor** screen.

3. No password is required by default. Type a password if you have set one, and then click .
4. Click the **Network** tab.
5. Click **Security**.
6. Click **Certificate**.
7. Click **Create Self-Signed Certificate**.
8. Enter a **Common Name** and a **Valid Date**.
  - The length of the **Common Name** is less than 64 bytes. Enter an identifier, such as an IP address, node name, or domain name to use when accessing this machine through SSL/TLS communication. The node name is displayed by default.
  - A warning will appear if you use the IPPS or HTTPS protocol and enter a different name in the URL than the **Common Name** that was used for the self-signed certificate.
9. Select your setting from the **Public Key Algorithm** drop-down list. The default setting is **RSA(2048bit)**.
10. Select your setting from the **Digest Algorithm** drop-down list. The default setting is **SHA256**.
11. Click **Submit**.
12. Click **Network**.
13. Click **Protocol**.
14. Click **HTTP Server Settings**.
15. Select the certificate you want to configure from the **Select the Certificate** drop-down list.
16. Click **Submit**.

The following screen appears.

## HTTP Server Settings

---

The setting for high security in communication was done.

---

To activate your new settings, this Device needs to restart.

Note: Any jobs in progress will be aborted.

To activate other protocols that have secure settings after restarting, check the box below.

Activate other protocols that have secure settings.

Would you like to restart immediately?

---

Yes

No

17. Click **Yes** to restart your print server.

The self-signed certificate is created and saved in your machine's memory.

To use SSL/TLS communication, the self-signed certificate must be installed on your computer.







### Related Information

- [Create and Install a Self-signed Certificate](#)

## Install the Self-signed Certificate for Windows® users with Administrator Rights

**Related Models:** HL-L5100DN/HL-L5200DW/HL-L5200DWT/HL-L6200DW/HL-L6200DWT/HL-L6300DW

The following steps are for Microsoft® Internet Explorer®. If you use another web browser, consult the documentation for your web browser to get help with installing certificates.

1. Do one of the following:
  - (Windows® XP and Windows Server® 2003)  
Start your web browser, and then go to step 3.
  - (Windows Vista®, Windows® 7, Windows Server® 2008)  
Click  (**Start**) > **All Programs**.
  - (Windows® 8)  
Right-click the  (**Internet Explorer**) icon on the taskbar.
  - (Windows Server® 2012 and Windows Server® 2012 R2)  
Click  (**Internet Explorer**), and then right-click the  (**Internet Explorer**) icon that appears on the taskbar.
2. Right-click **Internet Explorer**, and then click **Run as administrator**.

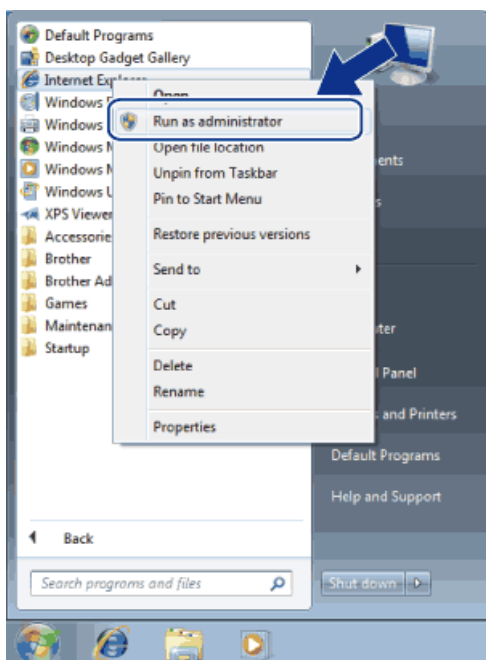

If the **User Account Control** screen appears,

- (Windows Vista®) Click **Continue (Allow)**.
  - (Windows® 7/Windows® 8) Click **Yes**.
3. Type "https://machine's IP address/" in your browser's address bar to access your machine (where "machine's IP address" is the machine's IP address or the node name that you assigned for the certificate).

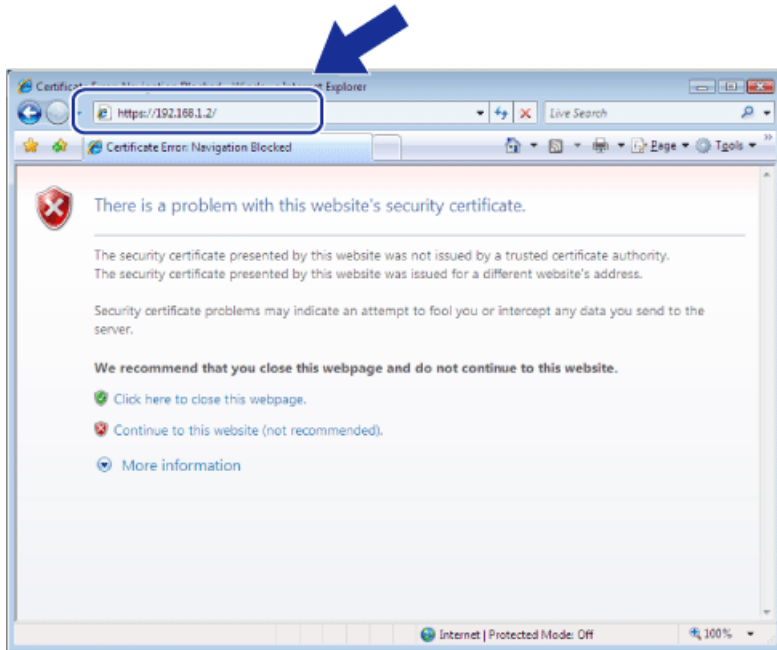

4. Click **Continue to this website (not recommended)**.

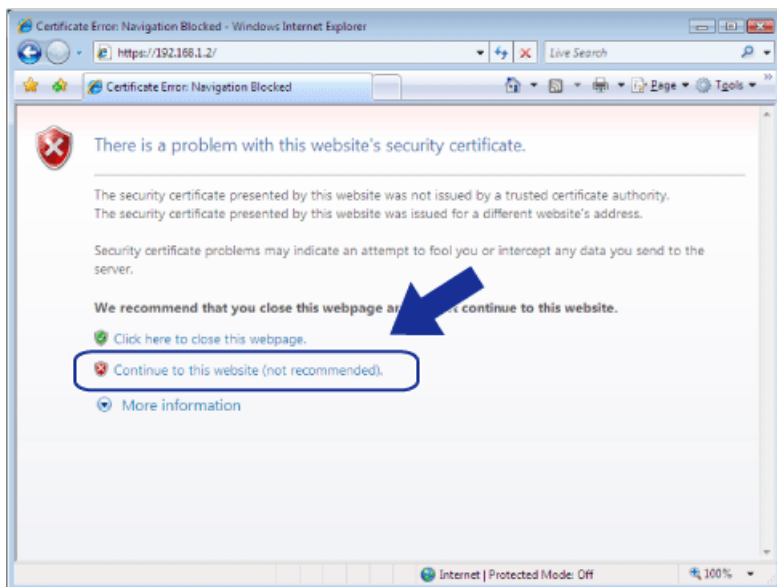

(Windows® XP and Windows Server® 2003)

When the following dialog box appears, click **View Certificate**, and then go to step 6.



5. Click **Certificate Error**, and then click **View certificates**.



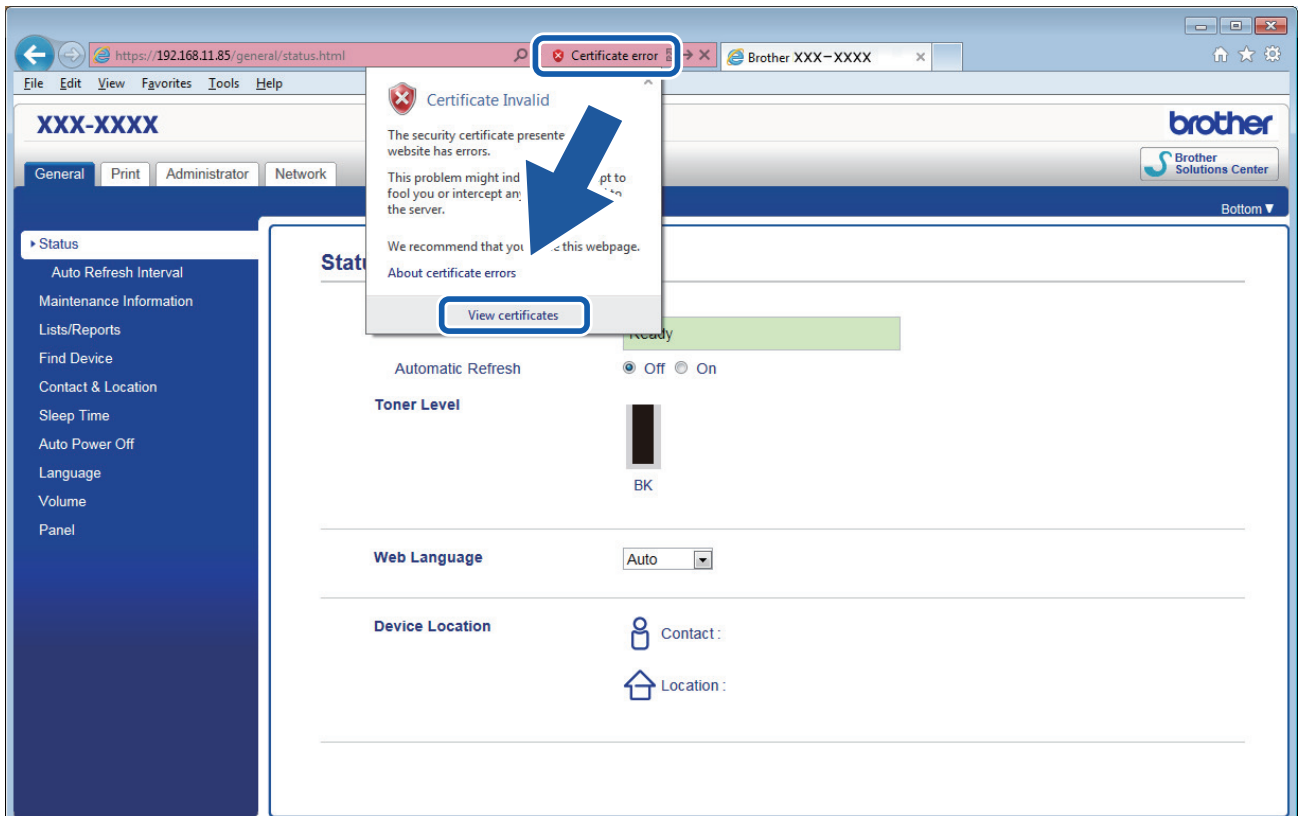

6. Click **Install Certificate...**

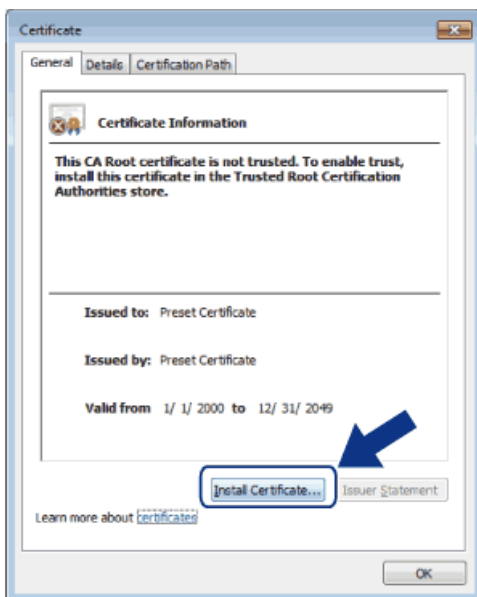

7. When the **Certificate Import Wizard** appears, click **Next**.

8. Select **Place all certificates in the following store**, and then click **Browse...**

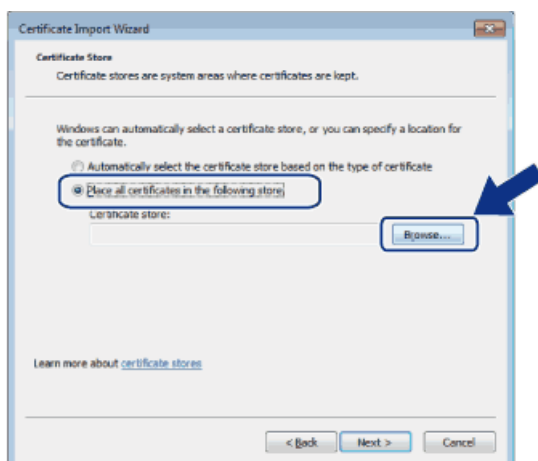

9. Select **Trusted Root Certification Authorities**, and then click **OK**.



10. Click **Next**.

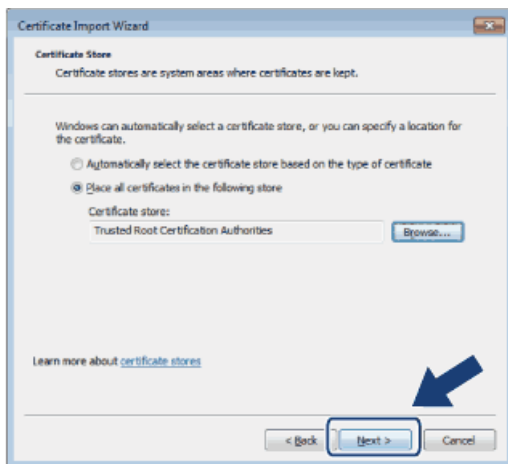

11. Click **Finish**.

12. Click **Yes**, if the fingerprint (thumbprint) is correct.

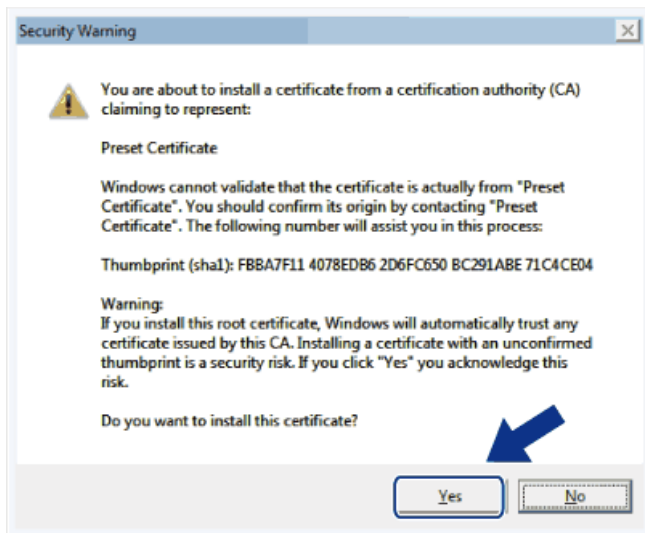

The fingerprint (thumbprint) is printed on the Network Configuration Report.

13. Click **OK**.

The self-signed certificate is now installed on your computer, and SSL/TLS communication is available.



## Related Information

- [Create and Install a Self-signed Certificate](#)

## **Import and Export the Self-signed Certificate on your Brother Machine**

You can store the self-signed certificates on your Brother machine and manage them by importing and exporting.

- [Import the Self-signed Certificate](#)
- [Export the Self-signed Certificate](#)

## Import the Self-signed Certificate

**Related Models:** HL-L5100DN/HL-L5200DW/HL-L5200DWT/HL-L6200DW/HL-L6200DWT/HL-L6300DW

1. Start your web browser.
2. Type "http://machine's IP address" in your browser's address bar (where "machine's IP address" is the machine's IP address).

For example:

http://192.168.1.2



- If you are using a Domain Name System or enable a NetBIOS name, you can type another name, such as "SharedPrinter" instead of the IP address.

- For example:

http://SharedPrinter

If you enable a NetBIOS name, you can also use the node name.

- For example:

http://brnxxxxxxxxxxxx

The NetBIOS name can be found in the Network Configuration Report.

- For Macintosh, access Web Based Management by clicking the machine's icon on the **Status Monitor** screen.

3. No password is required by default. Type a password if you have set one, and then click .
4. Click the **Network** tab.
5. Click **Security**.
6. Click **Certificate**.
7. Click **Import Certificate and Private Key**.
8. Browse to the file you want to import.
9. Type the password if the file is encrypted, and then click **Submit**.

The self-signed certificate is imported to your machine.

To use SSL/TLS communication, the self-signed certificate must also be installed on your computer. Contact your network administrator.



### Related Information

- [Import and Export the Self-signed Certificate on your Brother Machine](#)

## Export the Self-signed Certificate

**Related Models:** HL-L5100DN/HL-L5200DW/HL-L5200DWT/HL-L6200DW/HL-L6200DWT/HL-L6300DW

1. Start your web browser.
2. Type "http://machine's IP address" in your browser's address bar (where "machine's IP address" is the machine's IP address).

For example:

http://192.168.1.2



- If you are using a Domain Name System or enable a NetBIOS name, you can type another name, such as "SharedPrinter" instead of the IP address.

- For example:

http://SharedPrinter

If you enable a NetBIOS name, you can also use the node name.

- For example:

http://brnxxxxxxxxxxxx

The NetBIOS name can be found in the Network Configuration Report.

- For Macintosh, access Web Based Management by clicking the machine's icon on the **Status Monitor** screen.

3. No password is required by default. Type a password if you have set one, and then click .
4. Click the **Network** tab.
5. Click **Security**.
6. Click **Certificate**.
7. Click **Export**.
8. If you want to encrypt the file, type a password in the **Enter Password** field.  
If the **Enter Password** field is blank, your output file will not be encrypted.
9. Type the password again in the **Retype Password** field, and then click **Submit**.
10. Specify the location where you want to save the file.

The self-signed certificate is exported to your computer.

You can also import the self-signed certificate to your computer.



### Related Information

- [Import and Export the Self-signed Certificate on your Brother Machine](#)

## Create and Install a Certificate from a Certificate Authority (CA)

If you already have a certificate from an external trusted CA, you can store the certificate and private key on the machine and manage them by importing and exporting. If you do not have a certificate from an external trusted CA, create a Certificate Signing Request (CSR), send it to a CA for authentication, and install the returned certificate on your machine.

- [Create a Certificate Signing Request \(CSR\)](#)
- [Install a Certificate on Your Brother Machine](#)
- [Import and Export the Certificate and Private Key](#)

## Create a Certificate Signing Request (CSR)

**Related Models:** HL-L5100DN/HL-L5200DW/HL-L5200DWT/HL-L6200DW/HL-L6200DWT/HL-L6300DW

A Certificate Signing Request (CSR) is a request sent to a Certificate Authority (CA) to authenticate the credentials contained within the certificate.

We recommend installing a Root Certificate from the CA on your computer before creating the CSR.

1. Start your web browser.
2. Type "http://machine's IP address" in your browser's address bar (where "machine's IP address" is the machine's IP address).

For example:

http://192.168.1.2



- If you are using a Domain Name System or enable a NetBIOS name, you can type another name, such as "SharedPrinter" instead of the IP address.

- For example:

http://SharedPrinter

If you enable a NetBIOS name, you can also use the node name.

- For example:

http://brnxxxxxxxxxxxx

The NetBIOS name can be found in the Network Configuration Report.

- For Macintosh, access Web Based Management by clicking the machine's icon on the **Status Monitor** screen.

3. No password is required by default. Type a password if you have set one, and then click .
4. Click the **Network** tab.
5. Click **Security**.
6. Click **Certificate**.
7. Click **Create CSR**.
8. Type a **Common Name** (required) and add other information about your **Organization** (optional).



- Your company details are required so that a CA can confirm your identity and verify it to the outside world.
- The length of the **Common Name** must be less than 64 bytes. Enter an identifier, such as an IP address, node name, or domain name to use when accessing this printer through SSL/TLS communication. The node name is displayed by default. The **Common Name** is required.
- A warning will appear if you type a different name in the URL than the Common Name that was used for the certificate.
- The length of the **Organization**, the **Organization Unit**, the **City/Locality** and the **State/Province** must be less than 64 bytes.
- The **Country/Region** should be a two character ISO 3166 country code.
- If you are configuring an X.509v3 certificate extension, select the **Configure extended partition** check box, and then select **Auto (Register IPv4)** or **Manual**.

9. Select your setting from the **Public Key Algorithm** drop-down list. The default setting is **RSA(2048bit)**.
10. Select your setting from the **Digest Algorithm** drop-down list. The default setting is **SHA256**.
11. Click **Submit**.

---

The CSR appears on your screen. Save the CSR as a file or copy and paste it into an online CSR form offered by a Certificate Authority.

12. Click **Save**.



- 
- Follow your CA's policy regarding the method to send a CSR to your CA.
  - If you are using the Enterprise root CA of Windows Server® 2003/2008/2012/2012 R2, we recommend using the Web Server for the certificate template to securely create the Client Certificate. If you are creating a Client Certificate for an IEEE 802.1x environment with EAP-TLS authentication, we recommend using User for the certificate template. For more information, go to your model's page on the Brother Solutions Center at [support.brother.com](http://support.brother.com).
- 



### Related Information

- [Create and Install a Certificate from a Certificate Authority \(CA\)](#)
-



## Install a Certificate on Your Brother Machine

**Related Models:** HL-L5100DN/HL-L5200DW/HL-L5200DWT/HL-L6200DW/HL-L6200DWT/HL-L6300DW

When you receive a certificate from a CA, follow the steps below to install it into the print server:

Only a certificate issued with your machine's CSR can be installed onto the machine. When you want to create another CSR, make sure that the certificate is installed before creating another CSR. Create another CSR only after installing the certificate on the machine. If you do not, the CSR you create before installing will be invalid.

1. Start your web browser.
2. Type "http://machine's IP address" in your browser's address bar (where "machine's IP address" is the machine's IP address).

For example:

http://192.168.1.2



- If you are using a Domain Name System or enable a NetBIOS name, you can type another name, such as "SharedPrinter" instead of the IP address.

- For example:

http://SharedPrinter

If you enable a NetBIOS name, you can also use the node name.

- For example:

http://brnxxxxxxxxxxxx

The NetBIOS name can be found in the Network Configuration Report.

- For Macintosh, access Web Based Management by clicking the machine's icon on the **Status Monitor** screen.

3. No password is required by default. Type a password if you have set one, and then click .
4. Click the **Network** tab.
5. Click **Security**.
6. Click **Certificate**.
7. Click **Install Certificate**.
8. Browse to the file that contains the certificate issued by the CA, and then click **Submit**.

The certificate has been created successfully and saved in your machine's memory successfully.

To use SSL/TLS communication, the Root Certificate from the CA must be installed on your computer. Contact your network administrator.



### Related Information

- [Create and Install a Certificate from a Certificate Authority \(CA\)](#)

## **Import and Export the Certificate and Private Key**

Store the certificate and private key on your machine and manage them by importing and exporting them.

- [Import a Certificate and Private Key](#)
- [Export the Certificate and Private Key](#)

## Import a Certificate and Private Key

**Related Models:** HL-L5100DN/HL-L5200DW/HL-L5200DWT/HL-L6200DW/HL-L6200DWT/HL-L6300DW

1. Start your web browser.
2. Type "http://machine's IP address" in your browser's address bar (where "machine's IP address" is the machine's IP address).

For example:

http://192.168.1.2



- If you are using a Domain Name System or enable a NetBIOS name, you can type another name, such as "SharedPrinter" instead of the IP address.

- For example:

http://SharedPrinter

If you enable a NetBIOS name, you can also use the node name.

- For example:

http://brnxxxxxxxxxxxx

The NetBIOS name can be found in the Network Configuration Report.

- For Macintosh, access Web Based Management by clicking the machine's icon on the **Status Monitor** screen.

3. No password is required by default. Type a password if you have set one, and then click .
4. Click the **Network** tab.
5. Click **Security**.
6. Click **Certificate**.
7. Click **Import Certificate and Private Key**.
8. Browse to the file you want to import.
9. Type the password if the file is encrypted, and then click **Submit**.

The certificate and private key are imported to your machine.

To use SSL/TLS communication, the Root Certificate from the CA must also be installed on your computer. Contact your network administrator.



### Related Information

- [Import and Export the Certificate and Private Key](#)

## Export the Certificate and Private Key

**Related Models:** HL-L5100DN/HL-L5200DW/HL-L5200DWT/HL-L6200DW/HL-L6200DWT/HL-L6300DW

1. Start your web browser.
2. Type "http://machine's IP address" in your browser's address bar (where "machine's IP address" is the machine's IP address).

For example:

http://192.168.1.2



- If you are using a Domain Name System or enable a NetBIOS name, you can type another name, such as "SharedPrinter" instead of the IP address.

- For example:

http://SharedPrinter

If you enable a NetBIOS name, you can also use the node name.

- For example:

http://brnxxxxxxxxxxxx

The NetBIOS name can be found in the Network Configuration Report.

- For Macintosh, access Web Based Management by clicking the machine's icon on the **Status Monitor** screen.

3. No password is required by default. Type a password if you have set one, and then click .
4. Click the **Network** tab.
5. Click **Security**.
6. Click **Certificate**.
7. Click **Export** shown with **Certificate List**.
8. Enter the password if you want to encrypt the file.  
If a blank password is used, the output is not encrypted.
9. Enter the password again for confirmation, and then click **Submit**.
10. Specify the location where you want to save the file.

The certificate and private key are exported to your computer.

You can also import the certificate to your computer.



### Related Information

- [Import and Export the Certificate and Private Key](#)

## Import and Export a CA Certificate

You can import, export and store CA certificates on your Brother machine.

- [Import a CA Certificate](#)
- [Export a CA Certificate](#)

## Import a CA Certificate

**Related Models:** HL-L5100DN/HL-L5200DW/HL-L5200DWT/HL-L6200DW/HL-L6200DWT/HL-L6300DW

1. Start your web browser.
2. Type "http://machine's IP address" in your browser's address bar (where "machine's IP address" is the machine's IP address).

For example:

http://192.168.1.2



- If you are using a Domain Name System or enable a NetBIOS name, you can type another name, such as "SharedPrinter" instead of the IP address.

- For example:

http://SharedPrinter

If you enable a NetBIOS name, you can also use the node name.

- For example:

http://brnxxxxxxxxxxxx

The NetBIOS name can be found in the Network Configuration Report.

- For Macintosh, access Web Based Management by clicking the machine's icon on the **Status Monitor** screen.

3. No password is required by default. Type a password if you have set one, and then click .
4. Click the **Network** tab.
5. Click **Security**.
6. Click **CA Certificate**.
7. Click **Import CA Certificate** and select the certificate.
8. Click **Submit**.



### Related Information

- [Import and Export a CA Certificate](#)

## Export a CA Certificate

**Related Models:** HL-L5100DN/HL-L5200DW/HL-L5200DWT/HL-L6200DW/HL-L6200DWT/HL-L6300DW

1. Start your web browser.
2. Type "http://machine's IP address" in your browser's address bar (where "machine's IP address" is the machine's IP address).

For example:

http://192.168.1.2



- If you are using a Domain Name System or enable a NetBIOS name, you can type another name, such as "SharedPrinter" instead of the IP address.

- For example:

http://SharedPrinter

If you enable a NetBIOS name, you can also use the node name.

- For example:

http://brnxxxxxxxxxxxx

The NetBIOS name can be found in the Network Configuration Report.

- For Macintosh, access Web Based Management by clicking the machine's icon on the **Status Monitor** screen.

3. No password is required by default. Type a password if you have set one, and then click .
4. Click the **Network** tab.
5. Click **Security**.
6. Click **CA Certificate**.
7. Select the certificate you want to export and click **Export**.
8. Click **Submit**.
9. Click **Save**.
10. Specify where on your computer you want to save the exported certificate, and save it.



### Related Information

- [Import and Export a CA Certificate](#)

## Manage Multiple Certificates

**Related Models:** HL-L5100DN/HL-L5200DW/HL-L5200DWT/HL-L6200DW/HL-L6200DWT/HL-L6300DW

The multiple certificate feature allows you to use Web Based Management to manage each certificate installed on your machine. In Web Based Management, navigate to the **Certificate** or **CA Certificate** screen to view certificate content, delete, or export your certificates.

	Maximum Number of Certificates Stored UP on Brother Machine
Self-signed Certificate or Certificate Issued by a CA	5
CA Certificate	6

We recommend storing one less certificate than allowed, reserving an empty spot in case of certificate expiration. When a certificate expires, import a new certificate into the reserved spot, and then delete the expired certificate. This ensures that you avoid configuration failure.



- When you use HTTPS/IPPS, or IEEE 802.1x, you must select which certificate you are using.
- When you use SSL for SMTP communications, you do not have to choose the certificate. The necessary certificate will be chosen automatically.



### Related Information

- [Certificates and Web Based Management](#)



## Manage Your Network Machine Securely Using Web Based Management

**Related Models:** HL-L5100DN/HL-L5200DW/HL-L5200DWT/HL-L6200DW/HL-L6200DWT/HL-L6300DW

To manage your network machine securely, you must use management utilities with security protocols.

We recommend using the HTTPS protocol for secure management. To use this protocol, HTTPS must be enabled on your machine.





- The HTTPS protocol is enabled by default.
- You can change the HTTPS protocol settings using the Web Based Management screen.
  1. Click the **Network** tab.
  2. Click the **Protocol** menu in the left navigation bar.
  3. Click **HTTP Server Settings**.

1. Start your web browser.
2. Type "https://Common Name" in your browser's address bar (where "Common Name" is the Common Name that you assigned to the certificate; this could be your IP address, node name, or domain name).
3. No password is required by default. Type a password if you have set one, and then click .
4. You can now access the machine using HTTPS.

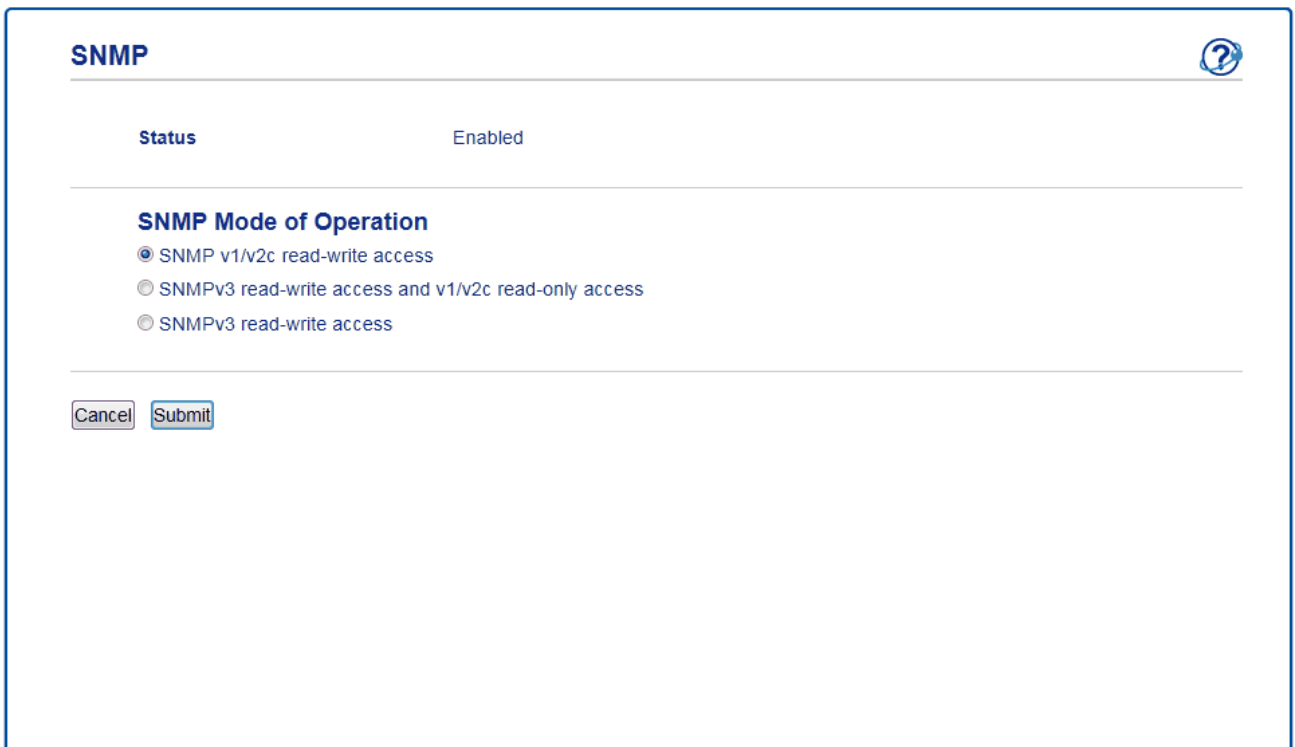

- If you use the SNMPv3 protocol, follow the steps below.
  - You can also change the SNMP settings by using BRAdmin Professional 3.
5. Click the **Network** tab.
  6. Click **Protocol**.
  7. Make sure the **SNMP** setting is enabled, and then click **Advanced Settings**.
  8. Configure the SNMP settings.



**SNMP** 

**Status** Enabled

**SNMP Mode of Operation**

SNMP v1/v2c read-write access

SNMPv3 read-write access and v1/v2c read-only access

SNMPv3 read-write access

There are three options for **SNMP Mode of Operation**.

---

- **SNMP v1/v2c read-write access**

In this mode, the print server uses version 1 and version 2c of the SNMP protocol. You can use all Brother applications in this mode. However, it is not secure since it will not authenticate the user, and data will not be encrypted.

- **SNMPv3 read-write access and v1/v2c read-only access**

In this mode, the print server uses the read-write access of version 3 and the read-only access of version 1 and version 2c of the SNMP protocol.



---

When you use **SNMPv3 read-write access and v1/v2c read-only access** mode, some Brother applications (such as BRAdmin Light) that access the print server do not work correctly since they authorize the read-only access of version 1 and version 2c. If you want to use all applications, we recommend using **SNMP v1/v2c read-write access** mode.

---

- **SNMPv3 read-write access**

In this mode, the print server uses version 3 of the SNMP protocol. If you want to manage the print server securely, use this mode.



---

When you use **SNMPv3 read-write access** mode, note the following:

- You can use only BRAdmin Professional 3 or Web Based Management to manage the print server.
  - Except for BRAdmin Professional 3, all applications that use SNMPv1/v2c will be restricted. To allow the use of SNMPv1/v2c applications, use **SNMPv3 read-write access and v1/v2c read-only access** or **SNMP v1/v2c read-write access** mode.
- 



## Related Information

- [Manage Your Network Machine Securely Using SSL/TLS](#)
-

## Manage Your Network Machine Securely Using BRAdmin Professional 3 (Windows®)

**Related Models:** HL-L5100DN/HL-L5200DW/HL-L5200DWT/HL-L6200DW/HL-L6200DWT/HL-L6300DW

To use BRAdmin Professional 3 utility, you must:

- Use the latest version of BRAdmin Professional 3. Go to your model's **Downloads** page on the Brother Solutions Center at [support.brother.com](http://support.brother.com). If you use an older version of BRAdmin to manage your Brother machines, the user authentication will not be secure.
- Use Web Based Management with the HTTPS protocol if you use BRAdmin Professional 3 and Web Based Management together.
- Use a different password in each group if you are managing a mixed group of older and newer print servers with BRAdmin Professional 3. This will ensure security is maintained on the newer print servers.



- "Older versions of BRAdmin" refer to BRAdmin Professional older than Ver. 2.80 and BRAdmin Light for Macintosh older than Ver. 1.10.
- "Older print servers" refer to NC-2000 series, NC-2100p, NC-3100h, NC-3100s, NC-4100h, NC-5100h, NC-5200h, NC-6100h, NC-6200h, NC-6300h, NC-6400h, NC-8000, NC-100h, NC-110h, NC-120w, NC-130h, NC-140w, NC-8100h, NC-9100h, NC-7100w, NC-7200w and NC-2200w.



### Related Information

- [Manage Your Network Machine Securely Using SSL/TLS](#)

## Print Documents Securely Using SSL/TLS

**Related Models:** HL-L5100DN/HL-L5200DW/HL-L5200DWT/HL-L6200DW/HL-L6200DWT/HL-L6300DW

To print documents securely with IPP protocol, use the IPPS protocol.

1. Start your web browser.
2. Type "http://machine's IP address" in your browser's address bar (where "machine's IP address" is the machine's IP address).

For example:

http://192.168.1.2



- If you are using a Domain Name System or enable a NetBIOS name, you can type another name, such as "SharedPrinter" instead of the IP address.

- For example:

http://SharedPrinter

If you enable a NetBIOS name, you can also use the node name.

- For example:

http://brnxxxxxxxxxxxx

The NetBIOS name can be found in the Network Configuration Report.

- For Macintosh, access Web Based Management by clicking the machine's icon on the **Status Monitor** screen.

3. No password is required by default. Type a password if you have set one, and then click .
4. Click the **Network** tab.
5. Click **Protocol**. Make sure the **IPP** check box is selected.



If the **IPP** check box is not selected, select the **IPP** check box, and then click **Submit**.

Restart your machine to activate the configuration.

After the machine restarts, return to the machine's web page, click the **Network** tab, and then click **Protocol**.

6. Click **HTTP Server Settings**.
7. Select the **HTTPS(Port443)** check box, and then click **Submit**.
8. Restart your machine to activate the configuration.

Communication using IPPS cannot prevent unauthorized access to the print server.



### Related Information

- [Manage Your Network Machine Securely Using SSL/TLS](#)

## Manage Your Network Machine Securely Using IPsec

- [Introduction to IPsec](#)
- [Configure IPsec Using Web Based Management](#)
- [Configure an IPsec Address Template Using Web Based Management](#)
- [Configure an IPsec Template Using Web Based Management](#)

## Introduction to IPsec

**Related Models:** HL-L5100DN/HL-L5200DW/HL-L5200DWT/HL-L6200DW/HL-L6200DWT/HL-L6300DW

IPsec (Internet Protocol Security) is a security protocol that uses an optional Internet Protocol function to prevent manipulation and ensure the confidentiality of data transmitted as IP packets. IPsec encrypts data carried over the network, such as print data sent from computers to a printer. Because the data is encrypted at the network layer, applications that employ a higher-level protocol use IPsec even if the user is not aware of its use.

IPsec supports the following functions:

- IPsec transmissions

According to the IPsec setting conditions, the network-connected computer sends data to and receives data from the specified device using IPsec. When the devices start communicating using IPsec, keys are exchanged using Internet Key Exchange (IKE) first, and then the encrypted data is transmitted using the keys.

In addition, IPsec has two operation modes: the Transport mode and Tunnel mode. The Transport mode is used mainly for communication between devices and the Tunnel mode is used in environments such as a Virtual Private Network (VPN).



---

For IPsec transmissions, the following conditions are necessary:

- A computer that can communicate using IPsec is connected to the network.
  - Your Brother machine is configured for IPsec communication.
  - The computer connected to your Brother machine is configured for IPsec connections.
- 

- IPsec settings

The settings that are necessary for connections using IPsec. These settings can be configured using Web Based Management.



---

To configure the IPsec settings, you must use the browser on a computer that is connected to the network.

---



### Related Information

- [Manage Your Network Machine Securely Using IPsec](#)
-

## Configure IPsec Using Web Based Management

**Related Models:** HL-L5100DN/HL-L5200DW/HL-L5200DWT/HL-L6200DW/HL-L6200DWT/HL-L6300DW

The IPsec connection conditions are comprised of two **Template** types: **Address** and **IPsec**. You can configure up to 10 connection conditions.

1. Start your web browser.
2. Type "http://machine's IP address" in your browser's address bar (where "machine's IP address" is the machine's IP address).

For example:

http://192.168.1.2

3. No password is required by default. Type a password if you have set one, and then click .
4. Click the **Network** tab.
5. Click **Security**.
6. Click the **IPsec** menu in the left navigation bar.

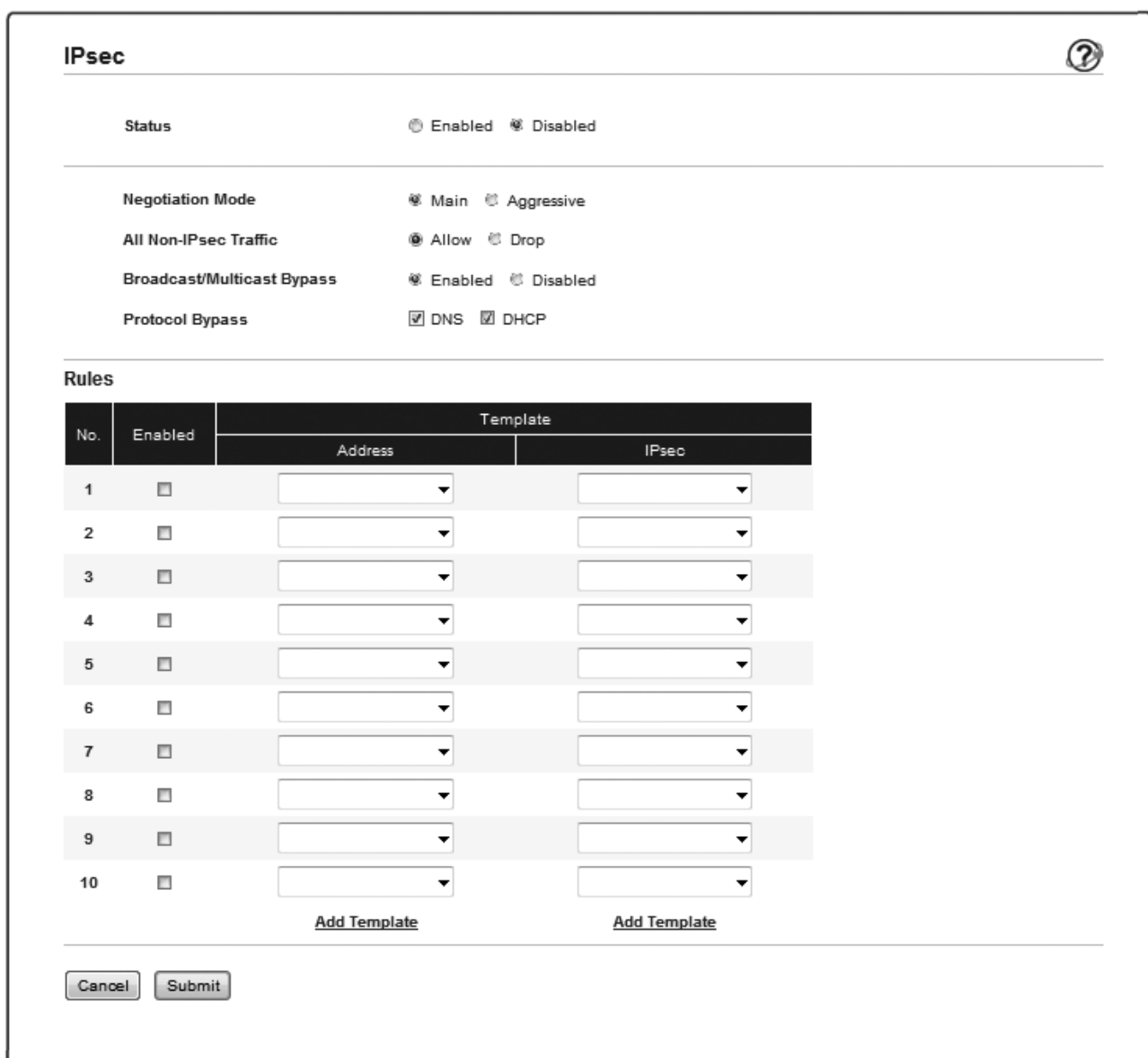

**IPsec** ?

Status  Enabled  Disabled

---

Negotiation Mode  Main  Aggressive

All Non-IPsec Traffic  Allow  Drop

Broadcast/Multicast Bypass  Enabled  Disabled

Protocol Bypass  DNS  DHCP

---

**Rules**

No.	Enabled	Template	
		Address	IPsec
1	<input type="checkbox"/>	<input type="text"/>	<input type="text"/>
2	<input type="checkbox"/>	<input type="text"/>	<input type="text"/>
3	<input type="checkbox"/>	<input type="text"/>	<input type="text"/>
4	<input type="checkbox"/>	<input type="text"/>	<input type="text"/>
5	<input type="checkbox"/>	<input type="text"/>	<input type="text"/>
6	<input type="checkbox"/>	<input type="text"/>	<input type="text"/>
7	<input type="checkbox"/>	<input type="text"/>	<input type="text"/>
8	<input type="checkbox"/>	<input type="text"/>	<input type="text"/>
9	<input type="checkbox"/>	<input type="text"/>	<input type="text"/>
10	<input type="checkbox"/>	<input type="text"/>	<input type="text"/>

[Add Template](#) [Add Template](#)

7. In the **Status** field, enable or disable IPsec.
8. Select **Negotiation Mode** for IKE Phase 1.

---

IKE is a protocol that is used to exchange encryption keys in order to carry out encrypted communication using IPsec.

In **Main** mode, the processing speed is slow, but the security is high. In **Aggressive** mode, the processing speed is faster than **Main** mode, but the security is lower.

9. In the **All Non-IPsec Traffic** field, select the action to be taken for non-IPsec packets.

When using Web Services, you must select **Allow** for **All Non-IPsec Traffic**. If you select **Drop**, Web Services cannot be used.

10. In the **Broadcast/Multicast Bypass** field, select **Enabled** or **Disabled**.

11. In the **Protocol Bypass** field, select the check box for the option or options you want.

12. In the **Rules** table, select the **Enabled** check box to activate the template.

When you select multiple check boxes, the lower numbered check boxes have priority if the settings for the selected check boxes conflict.

13. Click on the corresponding drop-down list to select the **Address Template** that is used for the IPsec connection conditions.

To add an **Address Template**, click **Add Template**.

14. Click on the corresponding drop-down list to select the **IPsec Template** that is used for the IPsec connection conditions.

To add an **IPsec Template**, click **Add Template**.

15. Click **Submit**.

If the computer must be restarted to register the new settings, the restart confirmation screen will appear.

If there is a blank item in the template you enabled in the **Rules** table, an error message appears. Confirm your choices and submit again.



## Related Information

- [Manage Your Network Machine Securely Using IPsec](#)
-



## Configure an IPsec Address Template Using Web Based Management

**Related Models:** HL-L5100DN/HL-L5200DW/HL-L5200DWT/HL-L6200DW/HL-L6200DWT/HL-L6300DW

1. Start your web browser.
2. Type "http://machine's IP address" in your browser's address bar (where "machine's IP address" is the machine's IP address).  
For example:  
http://192.168.1.2
3. No password is required by default. Type a password if you have set one, and then click .
4. Click the **Network** tab.
5. Click **Security**.
6. Click the **IPsec Address Template** menu in the left navigation bar.  
The Template List appears, displaying 10 Address Templates.  
Click the **Delete** button to delete an **Address Template**. When an **Address Template** is in use, it cannot be deleted.
7. Click the **Address Template** that you want to create. The **IPsec Address Template** appears.

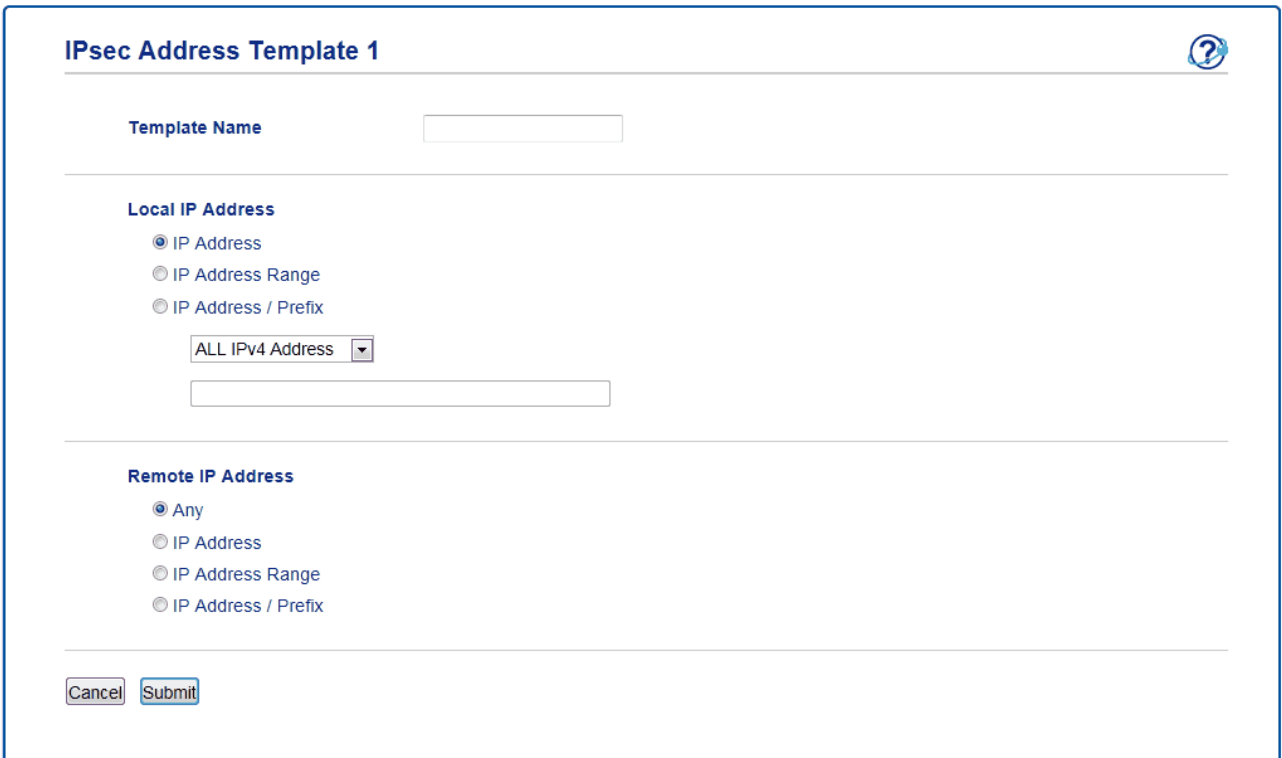

**IPsec Address Template 1** 

**Template Name**

---

**Local IP Address**

IP Address  
 IP Address Range  
 IP Address / Prefix

ALL IPv4 Address

---

**Remote IP Address**

Any  
 IP Address  
 IP Address Range  
 IP Address / Prefix

8. In the **Template Name** field, type a name for the template (up to 16 characters).
9. Select a **Local IP Address** option to specify the IP address conditions for the sender:
  - **IP Address**  
Specify the IP address. Select **ALL IPv4 Address**, **ALL IPv6 Address**, **All Link Local IPv6**, or **Custom** from the drop-down list.  
If you select **Custom** from the drop-down list, type the IP address (IPv4 or IPv6) in the text box.
  - **IP Address Range**  
Type the starting and ending IP addresses for the IP address range in the text boxes. If the starting and ending IP addresses are not standardized to IPv4 or IPv6, or the ending IP address is smaller than the starting address, an error will occur.

---

- **IP Address / Prefix**

Specify the IP address using CIDR notation.

For example: 192.168.1.1/24

Because the prefix is specified in the form of a 24-bit subnet mask (255.255.255.0) for 192.168.1.1, the addresses 192.168.1.xxx are valid.

10. Select a **Remote IP Address** option to specify the IP address conditions for the recipient:

- **Any**

If you select **Any**, all IP addresses are enabled.

- **IP Address**

Type the specified IP address (IPv4 or IPv6) in the text box.

- **IP Address Range**

Type the starting and ending IP addresses for the IP address range. If the starting and ending IP addresses are not standardized to IPv4 or IPv6, or the ending IP address is smaller than the starting address, an error will occur.

- **IP Address / Prefix**

Specify the IP address using CIDR notation.

For example: 192.168.1.1/24

Because the prefix is specified in the form of a 24-bit subnet mask (255.255.255.0) for 192.168.1.1, the addresses 192.168.1.xxx are valid.

11. Click **Submit**.



When you change the settings for the template currently in use, the IPsec screen in Web Based Management will close and open again.

---



## Related Information

- [Manage Your Network Machine Securely Using IPsec](#)
-

## Configure an IPsec Template Using Web Based Management

**Related Models:** HL-L5100DN/HL-L5200DW/HL-L5200DWT/HL-L6200DW/HL-L6200DWT/HL-L6300DW

1. Start your web browser.
2. Type "http://machine's IP address" in your browser's address bar (where "machine's IP address" is the machine's IP address).  
For example:  
http://192.168.1.2
3. No password is required by default. Type a password if you have set one, and then click .
4. Click the **Network** tab.
5. Click **Security**.
6. Click **IPsec Template** in the left navigation bar.  
The Template List appears, displaying 10 IPsec Templates.  
Click the **Delete** button to delete an **IPsec Template**. When an **IPsec Template** is in use, it cannot be deleted.
7. Click **IPsec Template** that you want to create. The **IPsec Template** screen appears. The configuration fields differ based on the **Use Prefixed Template** and **Internet Key Exchange (IKE)** you select.
8. In the **Template Name** field, type a name for the template (up to 16 characters).
9. Select the **Internet Key Exchange (IKE)** options.
10. Click **Submit**.

## IPsec Template 1



Template Name   
Use Prefixed Template

Internet Key Exchange (IKE) IKEv1

### Authentication Type

Diffie-Hellman Group   
Group14  
Encryption   
AES-CBC 256  
Hash   
SHA256  
SHA512  
SA Lifetime   
(240 – 63072000)  
  
(10 – 2097152)

### Encapsulating Security

Protocol   
Encryption   
AES-CBC 256  
Hash   
SHA256  
SHA512  
SA Lifetime   
(240 – 63072000)  
  
(10 – 2097152)  
Encapsulation Mode  Transport  Tunnel  
Remote Router IP-Address

Perfect Forward Secrecy (PFS)  Enabled  Disabled

Authentication Method  Pre-Shared Key  
 Certificates

Pre-Shared Key

### Local

ID Type   
ID

### Remote

ID Type   
ID

[Certificate>>](#)



## Related Information

- [Manage Your Network Machine Securely Using IPsec](#)
- [IKEv1 Settings for an IPsec Template](#)
- [IKEv2 Settings for an IPsec Template](#)
- [Manual Settings for an IPsec Template](#)

## IKEv1 Settings for an IPsec Template

Related Models: HL-L5100DN/HL-L5200DW/HL-L5200DWT/HL-L6200DW/HL-L6200DWT/HL-L6300DW

### IPsec Template 1 ?

---

Template Name

Use Prefixed Template

---

Internet Key Exchange (IKE)  IKEv1  IKEv2  Manual

---

**Authentication Type**

Diffie-Hellman Group

Encryption

Hash

SA Lifetime  second(s)  
(240 – 63072000)

KByte  
(10 – 2097152)

---

**Encapsulating Security**

Protocol  ESP  AH  AH+ESP

Encryption

Hash

SA Lifetime  second(s)  
(120 – 4233600)

KByte  
(10 – 4194304)

Encapsulation Mode  Transport  Tunnel

Remote Router IP-Address

---

Perfect Forward Secrecy (PFS)  Enabled  Disabled

---

**Authentication Method**  Pre-Shared Key  Certificates

Pre-Shared Key

**Local**

ID Type

ID

**Remote**

ID Type

ID

---

[Certificate>>](#)

---

---

## Template Name

Type a name for the template (up to 16 characters).

## Use Prefixed Template

Select **Custom**, **IKEv1 High Security** or **IKEv1 Medium Security**. The setting items are different depending on the selected template.



---

The default template differs depending on whether you chose **Main** or **Aggressive** for **Negotiation Mode** on the **IPsec** configuration screen.

---

## Internet Key Exchange (IKE)

IKE is a communication protocol that is used to exchange encryption keys in order to carry out encrypted communication using IPsec. To carry out encrypted communication for that time only, the encryption algorithm that is necessary for IPsec is determined and the encryption keys are shared. For IKE, the encryption keys are exchanged using the Diffie-Hellman key exchange method, and encrypted communication that is limited to IKE is carried out.

If you selected **Custom** in **Use Prefixed Template**, select **IKEv1**.

## Authentication Type

Configure the IKE authentication and encryption.

- **Diffie-Hellman Group**

This key exchange method allows secret keys to be securely exchanged over an unprotected network. The Diffie-Hellman key exchange method uses a discrete logarithm problem, not the secret key, to send and receive open information that was generated using a random number and the secret key.

Select **Group1**, **Group2**, **Group5**, or **Group14**.

- **Encryption**

Select **DES**, **3DES**, **AES-CBC 128**, or **AES-CBC 256**.

- **Hash**

Select **MD5**, **SHA1**, **SHA256**, **SHA384** or **SHA512**.

- **SA Lifetime**

Specify the IKE SA lifetime.

Type the time (seconds) and number of kilobytes (KByte).

## Encapsulating Security

- **Protocol**

Select **ESP**, **AH+ESP** or **AH**.



---

- ESP is a protocol for carrying out encrypted communication using IPsec. ESP encrypts the payload (communicated contents) and adds additional information. The IP packet is comprised of the header and the encrypted payload, which follows the header. In addition to the encrypted data, the IP packet also includes information regarding the encryption method and encryption key, the authentication data, and so on.

- AH is part of the IPsec protocol that authenticates the sender and prevents manipulation (ensures the completeness) of the data. In the IP packet, the data is inserted immediately after the header. In addition, the packets include hash values, which are calculated using an equation from the communicated contents, secret key, and so on, in order to prevent the falsification of the sender and manipulation of the data. Unlike ESP, the communicated contents are not encrypted, and the data is sent and received as plain text.

---

- **Encryption**

Select **DES**, **3DES**, **AES-CBC 128**, or **AES-CBC 256**. The encryption can be selected only when **ESP** is selected in **Protocol**.

- **Hash**

Select **None**, **MD5**, **SHA1**, **SHA256**, **SHA384**, or **SHA512**. **None** can be selected only when **ESP** is selected in **Protocol**.

---

When **AH+ESP** is selected in **Protocol**, select each protocol for **Hash(AH)** and **Hash(ESP)**.

- **SA Lifetime**

Specify the IPsec SA lifetime.

Type the time (seconds) and number of kilobytes (KByte) before the IPsec SA will expire.

- **Encapsulation Mode**

Select **Transport** or **Tunnel**.

- **Remote Router IP-Address**

Type the IP address (IPv4 or IPv6) of the remote router. Enter this information only when the **Tunnel** mode is selected.



---

SA (Security Association) is an encrypted communication method using IPsec or IPv6 that exchanges and shares information, such as the encryption method and encryption key, in order to establish a secure communication channel before communication begins. SA may also refer to a virtual encrypted communication channel that has been established. The SA used for IPsec establishes the encryption method, exchanges the keys, and carries out mutual authentication according to the IKE (Internet Key Exchange) standard procedure. In addition, the SA is updated periodically.

---

### Perfect Forward Secrecy (PFS)

PFS does not derive keys from previous keys that were used to encrypt messages. In addition, if a key that is used to encrypt a message was derived from a parent key, that parent key is not used to derive other keys. Therefore, even if a key is compromised, the damage will be limited only to the messages that were encrypted using that key.

Select **Enabled** or **Disabled**.

### Authentication Method

Select the authentication method. Select **Pre-Shared Key** or **Certificates**.

#### Pre-Shared Key

When encrypting communication, the encryption key is exchanged and shared beforehand using another channel.

If you selected **Pre-Shared Key** for the **Authentication Method**, type the **Pre-Shared Key** (up to 32 characters).

- **Local/ID Type/ID**

Select the sender's ID type, and then type the ID.

Select **IPv4 Address**, **IPv6 Address**, **FQDN**, **E-mail Address**, or **Certificate** for the type.

If you select **Certificate**, type the common name of the certificate in the **ID** field.

- **Remote/ID Type/ID**

Select the recipient's ID type, and then type the ID.

Select **IPv4 Address**, **IPv6 Address**, **FQDN**, **E-mail Address**, or **Certificate** for the type.

If you select **Certificate**, type the common name of the certificate in the **ID** field.

### Certificates

If you selected **Certificates** for **Authentication Method**, select the certificate.



---

You can select only the certificates that were created using the **Certificate** page of Web Based Management's Security configuration screen.

---



### Related Information

- [Configure an IPsec Template Using Web Based Management](#)
-

## IKEv2 Settings for an IPsec Template

Related Models: HL-L5100DN/HL-L5200DW/HL-L5200DWT/HL-L6200DW/HL-L6200DWT/HL-L6300DW

### IPsec Template 1 ?

---

Template Name

Use Prefixed Template

---

Internet Key Exchange (IKE)  IKEv1  IKEv2  Manual

---

**Authentication Type**

Diffie-Hellman Group  Group1  Group2  Group5  Group14

Encryption  DES  3DES  AES-CBC 128  
 AES-CBC 256

Hash  MD5  SHA1  SHA256  SHA384  
 SHA512

SA Lifetime  second(s)  
(240 – 83072000)

KByte  
(10 – 2097152)

---

**Encapsulating Security**

Protocol  ESP

Encryption  DES  3DES  AES-CBC 128  
 AES-CBC 256

Hash  MD5  SHA1  SHA256  SHA384  
 SHA512

SA Lifetime  second(s)  
(120 – 4233600)

KByte  
(10 – 4194304)

Encapsulation Mode  Transport  Tunnel

Remote Router IP-Address

---

Perfect Forward Secrecy (PFS)  Enabled  Disabled

---

**Authentication Method**  Pre-Shared Key  
 Certificates  
 EAP - MD5  
 EAP - MS-CHAPv2

**Pre-Shared Key**

**Local**

ID Type

ID

**Remote**

ID Type

ID

---

[Certificate>>](#)

---



---

## Template Name

Type a name for the template (up to 16 characters).

## Use Prefixed Template

Select **Custom**, **IKEv2 High Security**, or **IKEv2 Medium Security**. The setting items are different depending on the selected template.

## Internet Key Exchange (IKE)

IKE is a communication protocol that is used to exchange encryption keys in order to carry out encrypted communication using IPsec. To carry out encrypted communication for that time only, the encryption algorithm that is necessary for IPsec is determined and the encryption keys are shared. For IKE, the encryption keys are exchanged using the Diffie-Hellman key exchange method, and encrypted communication that is limited to IKE is carried out.

If you selected **Custom** in **Use Prefixed Template**, select **IKEv2**.

## Authentication Type

Configure the IKE authentication and encryption.

- **Diffie-Hellman Group**

This key exchange method allows secret keys to be securely exchanged over an unprotected network. The Diffie-Hellman key exchange method uses a discrete logarithm problem, not the secret key, to send and receive open information that was generated using a random number and the secret key.

Select **Group1**, **Group2**, **Group5**, or **Group14**.

- **Encryption**

Select **DES**, **3DES**, **AES-CBC 128**, or **AES-CBC 256**.

- **Hash**

Select **MD5**, **SHA1**, **SHA256**, **SHA384** or **SHA512**.

- **SA Lifetime**

Specify the IKE SA lifetime.

Type the time (seconds) and number of kilobytes (KByte).

## Encapsulating Security

- **Protocol**

Select **ESP**.



ESP is a protocol for carrying out encrypted communication using IPsec. ESP encrypts the payload (communicated contents) and adds additional information. The IP packet is comprised of the header and the encrypted payload, which follows the header. In addition to the encrypted data, the IP packet also includes information regarding the encryption method and encryption key, the authentication data, and so on.

---

- **Encryption**

Select **DES**, **3DES**, **AES-CBC 128**, or **AES-CBC 256**.

- **Hash**

Select **MD5**, **SHA1**, **SHA256**, **SHA384**, or **SHA512**.

- **SA Lifetime**

Specify the IPsec SA lifetime.

Type the time (seconds) and number of kilobytes (KByte) before the IPsec SA will expire.

- **Encapsulation Mode**

Select **Transport** or **Tunnel**.

- **Remote Router IP-Address**

Type the IP address (IPv4 or IPv6) of the remote router. Enter this information only when the **Tunnel** mode is selected.



---

SA (Security Association) is an encrypted communication method using IPsec or IPv6 that exchanges and shares information, such as the encryption method and encryption key, in order to establish a secure communication channel before communication begins. SA may also refer to a virtual encrypted communication channel that has been established. The SA used for IPsec establishes the encryption method, exchanges the keys, and carries out mutual authentication according to the IKE (Internet Key Exchange) standard procedure. In addition, the SA is updated periodically.

---

### Perfect Forward Secrecy (PFS)

PFS does not derive keys from previous keys that were used to encrypt messages. In addition, if a key that is used to encrypt a message was derived from a parent key, that parent key is not used to derive other keys. Therefore, even if a key is compromised, the damage will be limited only to the messages that were encrypted using that key.

Select **Enabled** or **Disabled**.

### Authentication Method

Select the authentication method. Select **Pre-Shared Key**, **Certificates**, **EAP - MD5**, or **EAP - MS-CHAPv2**.

#### Pre-Shared Key

When encrypting communication, the encryption key is exchanged and shared beforehand using another channel.

If you selected **Pre-Shared Key** for the **Authentication Method**, type the **Pre-Shared Key** (up to 32 characters).

- **Local/ID Type/ID**

Select the sender's ID type, and then type the ID.

Select **IPv4 Address**, **IPv6 Address**, **FQDN**, **E-mail Address**, or **Certificate** for the type.

If you select **Certificate**, type the common name of the certificate in the **ID** field.

- **Remote/ID Type/ID**

Select the recipient's ID type, and then type the ID.

Select **IPv4 Address**, **IPv6 Address**, **FQDN**, **E-mail Address**, or **Certificate** for the type.

If you select **Certificate**, type the common name of the certificate in the **ID** field.

### Certificates

If you selected **Certificates** for **Authentication Method**, select the certificate.



---

You can select only the certificates that were created using the **Certificate** page of Web Based Management's Security configuration screen.

---

### EAP

EAP is an authentication protocol that is an extension of PPP. By using EAP with IEEE802.1x, a different key is used for user authentication during each session.

The following settings are necessary only when **EAP - MD5** or **EAP - MS-CHAPv2** is selected in **Authentication Method**:

- **Mode**

Select **Server-Mode** or **Client-Mode**.

- **Certificate**

Select the certificate.

- **User Name**

Type the user name (up to 32 characters).

- **Password**

Type the password (up to 32 characters). The password must be entered two times for confirmation.

- **Certificate**

Click this button to move to the **Certificate** configuration screen.



## Related Information

- [Configure an IPsec Template Using Web Based Management](#)
-

## Manual Settings for an IPsec Template

Related Models: HL-L5100DN/HL-L5200DW/HL-L5200DWT/HL-L6200DW/HL-L6200DWT/HL-L6300DW

### IPsec Template 1 ?

---

Template Name

Use Prefixed Template

---

Internet Key Exchange (IKE)  IKEv1  IKEv2  Manual

---

Authentication Key (ESP, AH)

In

Out

Code key (ESP)

In

Out

SPI

In

Out

---

Encapsulating Security

Protocol  ESP  AH

Encryption

Hash

SA Lifetime  second(s)  
(120 - 4233600)

KByte  
(10 - 4194304)

Encapsulation Mode  Transport  Tunnel

Remote Router IP-Address

---

[Certificate](#)

---

### Template Name

Type a name for the template (up to 16 characters).

### Use Prefixed Template

Select **Custom**.

### Internet Key Exchange (IKE)

IKE is a communication protocol that is used to exchange encryption keys in order to carry out encrypted communication using IPsec. To carry out encrypted communication for that time only, the encryption algorithm

---

that is necessary for IPsec is determined and the encryption keys are shared. For IKE, the encryption keys are exchanged using the Diffie-Hellman key exchange method, and encrypted communication that is limited to IKE is carried out.

Select **Manual**.

### Authentication Key (ESP,AH)

Specify the key to use for authentication. Type the **In/Out** values.

These settings are necessary when **Custom** is selected for **Use Prefixed Template**, **Manual** is selected for **IKE**, and a setting other than **None** is selected for **Hash** for **Encapsulating Security** section.



---

The number of characters you can set differs depending on the setting you chose for **Hash** in the **Encapsulating Security** section.

If the length of the specified authentication key is different than the selected hash algorithm, an error will occur.

- **MD5**: 128 bits (16 bytes)
- **SHA1**: 160 bits (20 bytes)
- **SHA256**: 256 bits (32 bytes)
- **SHA384**: 384 bits (48 bytes)
- **SHA512**: 512 bits (64 bytes)

When you specify the key in ASCII Code, enclose the characters in double quotation marks ("").

---

### Code key (ESP)

Specify the key to use for encryption. Type the **In/Out** values.

These settings are necessary when **Custom** is selected in **Use Prefixed Template**, **Manual** is selected in **IKE**, and **ESP** is selected in **Protocol** in **Encapsulating Security**.



---

The number of characters you can set differs depending on the setting you chose for **Encryption** in the **Encapsulating Security** section.

If the length of the specified code key is different than the selected encryption algorithm, an error will occur.

- **DES**: 64 bits (8 bytes)
- **3DES**: 192 bits (24 bytes)
- **AES-CBC 128**: 128 bits (16 bytes)
- **AES-CBC 256**: 256 bits (32 bytes)

When you specify the key in ASCII Code, enclose the characters in double quotation marks ("").

---

### SPI

These parameters are used to identify security information. Generally, a host has multiple Security Associations (SAs) for several types of IPsec communication. Therefore, it is necessary to identify the applicable SA when an IPsec packet is received. The SPI parameter, which identifies the SA, is included in the Authentication Header (AH) and Encapsulating Security Payload (ESP) header.

These settings are necessary when **Custom** is selected for **Use Prefixed Template**, and **Manual** is selected for **IKE**.

Enter the **In/Out** values. (3-10 characters)

### Encapsulating Security

- **Protocol**  
Select **ESP** or **AH**.



- ESP is a protocol for carrying out encrypted communication using IPsec. ESP encrypts the payload (communicated contents) and adds additional information. The IP packet is comprised of the header and the encrypted payload, which follows the header. In addition to the encrypted data, the IP packet also includes information regarding the encryption method and encryption key, the authentication data, and so on.
- AH is part of the IPsec protocol that authenticates the sender and prevents manipulation of the data (ensures the completeness of the data). In the IP packet, the data is inserted immediately after the header. In addition, the packets include hash values, which are calculated using an equation from the communicated contents, secret key, and so on, in order to prevent the falsification of the sender and manipulation of the data. Unlike ESP, the communicated contents are not encrypted, and the data is sent and received as plain text.

---

- **Encryption**

Select **DES**, **3DES**, **AES-CBC 128**, or **AES-CBC 256**. The encryption can be selected only when **ESP** is selected in **Protocol**.

- **Hash**

Select **None**, **MD5**, **SHA1**, **SHA256**, **SHA384**, or **SHA512**. **None** can be selected only when **ESP** is selected in **Protocol**.

- **SA Lifetime**

Specify the IKE SA lifetime.

Type the time (seconds) and number of kilobytes (KByte) before the IPsec SA will expire.

- **Encapsulation Mode**

Select **Transport** or **Tunnel**.

- **Remote Router IP-Address**

Specify the IP address (IPv4 or IPv6) of the connection destination. Enter this information only when the **Tunnel** mode is selected.



SA (Security Association) is an encrypted communication method using IPsec or IPv6 that exchanges and shares information, such as the encryption method and encryption key, in order to establish a secure communication channel before communication begins. SA may also refer to a virtual encrypted communication channel that has been established. The SA used for IPsec establishes the encryption method, exchanges the keys, and carries out mutual authentication according to the IKE (Internet Key Exchange) standard procedure. In addition, the SA is updated periodically.

---

### Submit

Click this button to register the settings.



When you change the settings for the template currently in use, the IPsec screen in Web Based Management will close and open again.

---



### Related Information

- [Configure an IPsec Template Using Web Based Management](#)
-

## Send an Email Securely

- [Configure Email Sending Using Web Based Management](#)
- [Send an Email with User Authentication](#)
- [Send an Email Securely Using SSL TLS](#)

## Configure Email Sending Using Web Based Management

**Related Models:** HL-L5100DN/HL-L5200DW/HL-L5200DWT/HL-L6200DW/HL-L6200DWT/HL-L6300DW

We recommend using Web Based Management to configure secured email sending with user authentication, or email sending using SSL/TLS.

1. Start your web browser.
2. Type "http://machine's IP address" in your browser's address bar (where "machine's IP address" is the machine's IP address).

For example:

http://192.168.1.2



- If you are using a Domain Name System or enable a NetBIOS name, you can type another name, such as "SharedPrinter" instead of the IP address.

- For example:

http://SharedPrinter

If you enable a NetBIOS name, you can also use the node name.

- For example:

http://brnxxxxxxxxxxxx

The NetBIOS name can be found in the Network Configuration Report.

- For Macintosh, access Web Based Management by clicking the machine's icon on the **Status Monitor** screen.

3. No password is required by default. Type a password if you have set one, and then click .
4. Click the **Network** tab.
5. Click **Protocol** in the left navigation bar.
6. In the **SMTP** field, click **Advanced Settings** and make sure the status of **SMTP** is **Enabled**.
7. Configure the **SMTP** settings.
  - Confirm that the email settings are correct after configuration by sending a test email.
  - If you do not know the SMTP server settings, contact your network administrator or Internet Service Provider (ISP).
8. When finished, click **Submit**.

The **Test Send E-mail Configuration** dialog box appears.
9. Follow the instructions in the dialog box to test the current settings.



### Related Information

- [Send an Email Securely](#)



## Send an Email with User Authentication

**Related Models:** HL-L5100DN/HL-L5200DW/HL-L5200DWT/HL-L6200DW/HL-L6200DWT/HL-L6300DW

Your Brother machine supports the SMTP-AUTH method to send email via an email server that requires user authentication. This method prevents unauthorized users from accessing the email server.

You can use the SMTP-AUTH method for email notification and email reports (available for certain models).



We recommend using Web Based Management to configure the SMTP authentication.

### Email Server Settings

You must configure your machine's SMTP authentication method to match the method used by your email server. For details about your email server settings, contact your network administrator or Internet Service Provider (ISP).



To enable SMTP server authentication, in the Web Based Management **SMTP** screen, under **Server Authentication Method**, you must select **SMTP-AUTH**.



### Related Information

- [Send an Email Securely](#)

## Send an Email Securely Using SSL TLS

**Related Models:** HL-L5100DN/HL-L5200DW/HL-L5200DWT/HL-L6200DW/HL-L6200DWT/HL-L6300DW

Your Brother machine supports SSL/TLS methods to send an email via an email server that requires secure SSL/TLS communication. To send email via an email server that is using SSL/TLS communication, you must configure SMTP over SSL/TLS.



We recommend using Web Based Management to configure SSL/TLS.

### Verify Server Certificate

Under **SSL/TLS**, if you choose **SSL** or **TLS**, the **Verify Server Certificate** check box will be selected automatically.

#### SMTP

Status Enabled

---

#### Send E-mail Settings(SMTP)

**Server Address**

**Port**

**Server Authentication Method**  None  SMTP-AUTH

**SMTP-AUTH Account Name**

**SMTP-AUTH Account Password**

Enter password

Retype password

**SSL/TLS**  None  SSL  TLS  Verify Server Certificate

**Device E-mail Address**

---

[CA Certificate>>](#)

[E-mail report>>](#)

[Notification>>](#)

---



- Before you verify the server certificate, you must import the CA certificate issued by the CA that signed the server certificate. Contact your network administrator or your Internet Service Provider (ISP) to confirm if importing a CA certificate is necessary.
- If you do not need to verify the server certificate, clear the **Verify Server Certificate** check box.

---

## Port Number

If you select **SSL**, the **Port** value will be changed to match the protocol. To change the port number manually, type the port number after you choose **SSL/TLS**.

You must configure your machine's SMTP communication method to match the method used by your email server. For details about your email server settings, contact your network administrator or your ISP.

In most cases, the secured webmail services require the following settings:

SMTP	<b>Port</b>	587
	<b>Server Authentication Method</b>	<b>SMTP-AUTH</b>
	<b>SSL/TLS</b>	<b>TLS</b>



### Related Information

- [Send an Email Securely](#)
-

## Use IEEE 802.1x Authentication for a Wired or a Wireless Network

- [What Is IEEE 802.1x Authentication?](#)
- [Configure IEEE 802.1x Authentication for a Wired or a Wireless Network Using Web Based Management \(Web Browser\)](#)
- [IEEE 802.1x Authentication Methods](#)

## What Is IEEE 802.1x Authentication?

**Related Models:** HL-L5100DN/HL-L5200DW/HL-L5200DWT/HL-L6200DW/HL-L6200DWT/HL-L6300DW

IEEE 802.1x is an IEEE standard for wired and wireless networks that limits access from unauthorized network devices. Your Brother machine (supplicant) sends an authentication request to a RADIUS server (Authentication server) through your access point or HUB. After your request has been verified by the RADIUS server, your machine can access the network.

### Related Information

- [Use IEEE 802.1x Authentication for a Wired or a Wireless Network](#)

## Configure IEEE 802.1x Authentication for a Wired or a Wireless Network Using Web Based Management (Web Browser)

**Related Models:** HL-L5100DN/HL-L5200DW/HL-L5200DWT/HL-L6200DW/HL-L6200DWT/HL-L6300DW

- If you configure your machine using EAP-TLS authentication, you must install the client certificate issued by a CA before you start configuration. Contact your network administrator about the client certificate. If you have installed more than one certificate, we recommend writing down the certificate name you want to use.
- Before you verify the server certificate, you must import the CA certificate that has been issued by the CA that signed the server certificate. Contact your network administrator or your Internet Service Provider (ISP) to confirm whether a CA certificate import is necessary.



You can also configure IEEE 802.1x authentication using:

- BRAdmin Professional 3 (Wired and wireless network)
- Wireless setup wizard from the control panel (Wireless network)
- Wireless setup wizard on the CD-ROM (Wireless network)

1. Start your web browser.
2. Type "http://machine's IP address" in your browser's address bar (where "machine's IP address" is the machine's IP address).

For example:

http://192.168.1.2



- If you are using a Domain Name System or enable a NetBIOS name, you can type another name, such as "SharedPrinter" instead of the IP address.

- For example:

http://SharedPrinter

If you enable a NetBIOS name, you can also use the node name.

- For example:

http://brnxxxxxxxxxxxx

The NetBIOS name can be found in the Network Configuration Report.

- For Macintosh, access Web Based Management by clicking the machine's icon on the **Status Monitor** screen.

3. No password is required by default. Type a password if you have set one, and then click .
4. Click the **Network** tab.
5. Do one of the following:

Option	Description
Wired network	Click <b>Wired</b> , and then select <b>Wired 802.1x Authentication</b> .
Wireless network	Click <b>Wireless</b> , and then select <b>Wireless (Enterprise)</b> .

6. Configure the IEEE 802.1x authentication settings.



- To enable IEEE 802.1x authentication for wired networks, select **Enabled** for **Wired 802.1x status** on the **Wired 802.1x Authentication** page.
- If you are using **EAP-TLS** authentication, you must select the client certificate that has been installed (shown with certificate name) for verification from the **Client Certificate** drop-down list.
- If you select **EAP-FAST**, **PEAP**, **EAP-TTLS**, or **EAP-TLS** authentication, select the verification method from the **Server Certificate Verification** drop-down list. Verify the server certificate using the CA certificate, imported to the machine in advance, that has been issued by the CA that signed the server certificate.

Select one of the following verification methods from the **Server Certificate Verification** drop-down list:

Option	Description
<b>No Verification</b>	The server certificate can always be trusted. The verification is not performed.
<b>CA Cert.</b>	The verification method to check the CA reliability of the server certificate, using the CA certificate that has been issued by the CA that signed the server certificate.
<b>CA Cert. + ServerID</b>	The verification method to check the common name <sup>1</sup> value of the server certificate, in addition to the CA reliability of the server certificate.

7. When finished with configuration, click **Submit**.

For wired networks: After configuring, connect your machine to the IEEE 802.1x supported network. After a few minutes, print the Network Configuration Report to check the **<Wired IEEE 802.1x>** Status.

Option	Description
<b>Success</b>	The wired IEEE 802.1x function is enabled and the authentication was successful.
<b>Failed</b>	The wired IEEE 802.1x function is enabled; however, the authentication failed.
<b>Off</b>	The wired IEEE 802.1x function is not available.



## Related Information

- [Use IEEE 802.1x Authentication for a Wired or a Wireless Network](#)

<sup>1</sup> The common name verification compares the common name of the server certificate to the character string configured for the **Server ID**. Before you use this method, contact your system administrator about the server certificate's common name and then configure **Server ID**.

## IEEE 802.1x Authentication Methods

**Related Models:** HL-L5100DN/HL-L5200DW/HL-L5200DWT/HL-L6200DW/HL-L6200DWT/HL-L6300DW

### LEAP (Wireless network)

Lightweight Extensible Authentication Protocol (LEAP) is a proprietary EAP method developed by Cisco Systems, Inc., which uses a user ID and password for authentication.

### EAP-FAST

Extensible Authentication Protocol-Flexible Authentication via Secured Tunneling (EAP-FAST) has been developed by Cisco Systems, Inc., which uses a user ID and password for authentication, and symmetric key algorithms to achieve a tunneled authentication process.

The Brother machine supports the following inner authentication methods:

- EAP-FAST/NONE
- EAP-FAST/MS-CHAPv2
- EAP-FAST/GTC

### EAP-MD5 (Wired network)

Extensible Authentication Protocol-Message Digest Algorithm 5 (EAP-MD5) uses a user ID and password for challenge-response authentication.

### PEAP

Protected Extensible Authentication Protocol (PEAP) is a version of EAP method developed by Cisco Systems, Inc., Microsoft® Corporation and RSA Security. PEAP creates an encrypted Secure Sockets Layer (SSL)/Transport Layer Security (TLS) tunnel between a client and an authentication server, for sending a user ID and password. PEAP provides mutual authentication between the server and the client.

The Brother machine supports the following inner authentications:

- PEAP/MS-CHAPv2
- PEAP/GTC

### EAP-TTLS

Extensible Authentication Protocol-Tunneled Transport Layer Security (EAP-TTLS) has been developed by Funk Software and Certicom. EAP-TTLS creates a similar encrypted SSL tunnel to PEAP, between a client and an authentication server, for sending a user ID and password. EAP-TTLS provides mutual authentication between the server and the client.

The Brother machine supports the following inner authentications:

- EAP-TTLS/CHAP
- EAP-TTLS/MS-CHAP
- EAP-TTLS/MS-CHAPv2
- EAP-TTLS/PAP

### EAP-TLS

Extensible Authentication Protocol-Transport Layer Security (EAP-TLS) requires digital certificate authentication both at a client and an authentication server.



### Related Information

- [Use IEEE 802.1x Authentication for a Wired or a Wireless Network](#)



## Store Print Log to Network

- [Store Log to Network Overview](#)
- [Configure the Store Print Log to Network Settings Using Web Based Management](#)
- [Use the Store Print Log to Network's Error Detection Setting](#)

## Store Log to Network Overview

**Related Models:** HL-L5100DN/HL-L5200DW/HL-L5200DWT/HL-L6200DW/HL-L6200DWT/HL-L6300DW

The Store Print Log to Network feature allows you to save the print log file from your Brother machine to a network server using the Common Internet File System (CIFS) protocol. You can record the ID, type of print job, job name, user name, date, time and the number of printed pages for every print job. CIFS is a protocol that runs over TCP/IP, allowing computers on a network to share files over an intranet or the Internet.

The following print functions are recorded in the print log:

- Print jobs from your computer
- Web Connect Print



- The Store Print Log to Network feature supports Kerberos authentication and NTLMv2 authentication. You must configure the SNTP protocol (network time server) for Authentication.
- You can set the file type to TXT or CSV when storing a file to the server.



### Related Information

- [Store Print Log to Network](#)

## Configure the Store Print Log to Network Settings Using Web Based Management



**Related Models:** HL-L5100DN/HL-L5200DW/HL-L5200DWT/HL-L6200DW/HL-L6200DWT/HL-L6300DW

1. Start your web browser.
2. Type "http://machine's IP address" in your browser's address bar (where "machine's IP address" is the machine's IP address).

For example:

http://192.168.1.2

3. No password is required by default. Type a password if you have set one, and then click .
4. Click the **Administrator** tab.
5. Click the **Store Print Log to Network** menu.
6. In the **Print Log** field, click **On**.
7. Configure the following settings:

Option	Description
<b>Network Folder Path</b>	Type the destination folder where your log will be stored on the CIFS server (for example: brother\abc).
<b>File Name</b>	Type the file name you want to use for the print log (up to 32 characters).
<b>File Type</b>	Select the <b>TXT</b> or <b>CSV</b> option for the Print Log file type.
<b>Auth. Method</b>	Select the authentication method required for access to the CIFS server: <b>Auto</b> , <b>Kerberos</b> , or <b>NTLMv2</b> . Kerberos is an authentication protocol which allows devices or individuals to securely prove their identity to network servers using a single sign-on. NTLMv2 is the authentication method used by Windows® to log into servers. <ul style="list-style-type: none"><li>• <b>Auto</b>: If you select <b>Auto</b>, NTLMv2 will be used to the authentication method.</li><li>• <b>Kerberos</b>: Select the <b>Kerberos</b> option to use Kerberos authentication only.</li><li>• <b>NTLMv2</b>: Select the <b>NTLMv2</b> option to use NTLMv2 authentication only.</li></ul>  <ul style="list-style-type: none"><li>• For the <b>Kerberos</b> and <b>NTLMv2</b> authentication, you must also configure the SNTP protocol (network time server) and DNS server.</li></ul>
<b>Username</b>	Type the user name for the authentication (up to 96 characters).  If the user name is part of a domain, enter the user name in one of the following styles: user@domain or domain\user.
<b>Password</b>	Type the password for the authentication (up to 32 characters).
<b>Kerberos Server Address</b> (if needed)	Type the KDC host address (for example: kerberos.example.com; up to 64 characters) or the IP address (for example: 192.168.56.189).
<b>Error Detection Setting</b>	Choose what action should be taken when the Print Log cannot be stored to the server due to a network error.

8. In the **Connection Status** field, confirm the last log status.



You can also confirm the error status on the LCD of your machine.

9. Click **Submit** to display the **Test Print Log to Network** page.  
To test your settings, click **Yes** and then go to the next step.  
To skip the test, click **No**. Your settings will be submitted automatically.
10. The machine will test your settings.
11. If your settings are accepted, **Test OK** appears on the screen.  
If **Test Error** appears, check all settings, and then click **Submit** to display the Test page again.



### Related Information

- [Store Print Log to Network](#)
-

## Use the Store Print Log to Network's Error Detection Setting

**Related Models:** HL-L5100DN/HL-L5200DW/HL-L5200DWT/HL-L6200DW/HL-L6200DWT/HL-L6300DW

Use Error Detection Settings to determine the action that is taken when the print log cannot be stored to the server due to a network error.

1. Start your web browser.
2. Type "http://machine's IP address" in your browser's address bar (where "machine's IP address" is the machine's IP address).

For example:

http://192.168.1.2

3. Click the **Administrator** tab.
4. Click the **Store Print Log to Network** menu in the left navigation bar.
5. In the **Error Detection Setting** section, select the **Cancel Print** or **Ignore Log & Print** option.

Option	Description
<b>Cancel Print</b>	If you select the <b>Cancel Print</b> option, the print jobs are canceled when the print log cannot be stored to the server.
<b>Ignore Log &amp; Print</b>	If you select the <b>Ignore Log &amp; Print</b> option, the machine prints the documentation even if the print log cannot be stored to the server.

When the store print log function has recovered, the print log is recorded as follows:

```
Id, Type, Job Name, User Name, Date, Time, Print Pages
```

```
1, Print(xxxxxxxx), "Document01.doc", "user01", 03/03/20xx, 14:01:32, 52
```

```
2, Print(xxxxxxxx), "Document02.doc", "user01", 03/03/20xx, 14:45:30, ?
```

```
3, <Error>, ?, ?, ?, ?, ?
```

```
4, Print(xxxxxxxx), "Report01.xls", "user02", 03/03/20xx, 19:30:40, 4
```

- a. If the log cannot be stored at the end of printing, the print log except the number of printed pages will be recorded.
- b. If the print log cannot be stored at the beginning and the end of printing, the print log of the job will not be recorded. When the function has recovered, the error is reflected in the log.

6. Click **Submit** to display the **Test Print Log to Network** page.  
To test your settings, click **Yes** and then go to the next step.  
To skip the test, click **No**. Your settings will be submitted automatically.
7. The machine will test your settings.
8. If your settings are accepted, **Test OK** appears on the screen.  
If **Test Error** appears, check all settings, and then click **Submit** to display the Test page again.

### ✓ Related Information

- [Store Print Log to Network](#)

## Mobile/Web Connect

- [Use Web Services from Your Brother Machine](#)
- [Print with Google Cloud Print™](#)
- [Print with AirPrint](#)
- [Print with Mopria™](#)
- [Print from a Mobile Device](#)
- [Print Using Near-Field Communication \(NFC\)](#)

## Use Web Services from Your Brother Machine

Related Models: HL-L6300DW

Certain websites provide services that allow users to upload and view images and files on the website. Your Brother machine can download and print images that are already uploaded to these services.

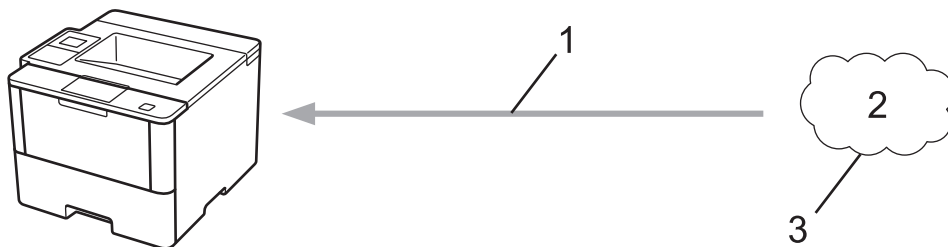

1. Printing
2. Photos, images, documents and other files
3. Web Service

The following services can be accessed from your Brother machine: Google Drive™, Dropbox, OneDrive® and Box.

For more information, see the *Web Connect Guide*. Go to your model's **Manuals** page on the Brother Solutions Center at [support.brother.com](http://support.brother.com).



### Related Information

- [Mobile/Web Connect](#)

## Print with Google Cloud Print™

**Related Models:** HL-L5100DN/HL-L5200DW/HL-L5200DWT/HL-L6200DW/HL-L6200DWT/HL-L6300DW

Google Cloud Print™ is a Google-provided service that allows you to print to a printer registered to your Google account using a network-compatible device (such as a mobile phone or computer) without installing the printer driver on the device.

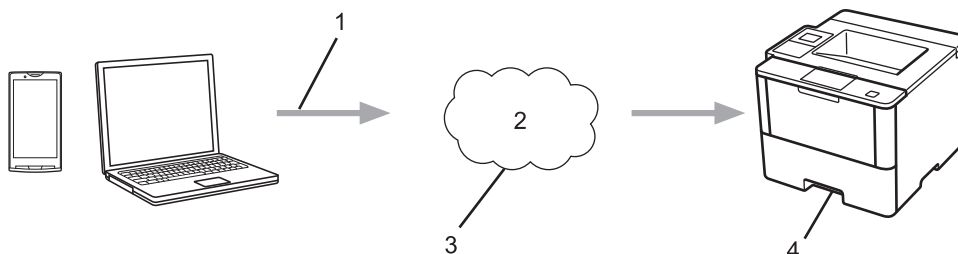

1. Print request
2. Internet
3. Google Cloud Print™
4. Printing

For more information, see the *Google Cloud Print Guide*. Go to your model's **Manuals** page on the Brother Solutions Center at [support.brother.com](http://support.brother.com).



### Related Information

- [Mobile/Web Connect](#)



## Print with AirPrint

**Related Models:** HL-L5100DN/HL-L5200DW/HL-L5200DWT/HL-L6200DW/HL-L6200DWT/HL-L6300DW

Use Brother AirPrint to wirelessly print photos, emails, web pages, and documents from your iPad, iPhone and iPod touch without installing a printer driver on the device.

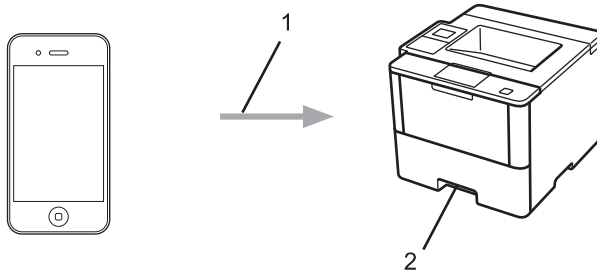

1. Print request
2. Printed photos, emails, web pages, and documents

For more information, see the *AirPrint Guide*. Go to your model's **Manuals** page on the Brother Solutions Center at [support.brother.com](http://support.brother.com).



### Related Information

- [Mobile/Web Connect](#)

## Print with Mopria™

**Related Models:** HL-L5100DN/HL-L5200DW/HL-L5200DWT/HL-L6200DW/HL-L6200DWT/HL-L6300DW

Mopria™ Print Service is a print feature on Android™ mobile devices (Android™ version 4.4 or later) developed by the Mopria™ Alliance. With this service, you can connect to the same network as your machine and print without additional setup. Many native Android™ apps, including Google Chrome™, Gmail, and Gallery, support printing.

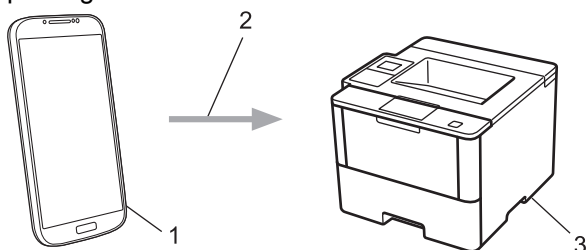

1. Android™ 4.4 or later
2. Wi-Fi® Connection
3. Your Brother machine

You must download the Mopria™ Print Service from the Google Play™ Store and install it on your Android™ device. Be sure to turn the service on before using this feature.



### Related Information

- [Mobile/Web Connect](#)

## Print from a Mobile Device

**Related Models:** HL-L5100DN/HL-L5200DW/HL-L5200DWT/HL-L6200DW/HL-L6200DWT/HL-L6300DW

Use Brother iPrint&Scan to print from various mobile devices.

- For Android™ Devices

Brother iPrint&Scan allows you to use features of your Brother machine directly from your Android™ device, without using a computer.

Download and install Brother iPrint&Scan from the Google Play™ Store.

- For iOS Devices

Brother iPrint&Scan allows you to use features of your Brother machine directly from your iPhone, iPod touch, iPad, and iPad mini.

Download and install Brother iPrint&Scan from the App Store.

- For Windows Phone® Devices

Brother iPrint&Scan allows you to use features of your Brother machine directly from your Windows Phone®, without using a computer.

Download and install Brother iPrint&Scan from the Windows Phone® Store (Windows Phone® Marketplace).

For more information, see the *Mobile Print/Scan Guide for Brother iPrint&Scan*. Go to your model's **Manuals** page on the Brother Solutions Center at [support.brother.com](http://support.brother.com).



### Related Information

- [Mobile/Web Connect](#)

## Print Using Near-Field Communication (NFC)

**Related Models:** HL-L6300DW

Near-Field Communication (NFC) allows for simple transactions, data exchange, and wireless connections between two devices that are in close range of each other.

If your Android™ device is NFC-enabled, you can print data (photos, PDF files, text files, web pages and email messages) from the device by touching it to the NFC logo on the right side of your machine's control panel.

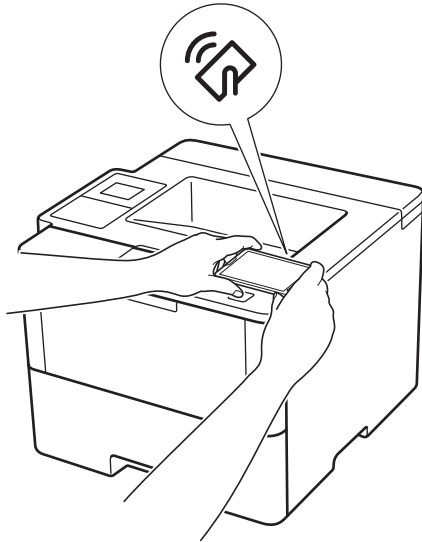

You must download and install Brother iPrint&Scan on your Android™ device to use this feature. For more information, see the *Mobile Print/Scan Guide for Brother iPrint&Scan*. Go to your model's **Manuals** page on the Brother Solutions Center at [support.brother.com](http://support.brother.com).

### ✓ Related Information

- [Mobile/Web Connect](#)

## Troubleshooting

Use this section to resolve typical problems you may encounter when using your Brother machine. You can correct most problems yourself.

### IMPORTANT

For technical help, you must call the country where you bought the machine. Calls must be made from within that country.

Using non-Brother supplies may affect the print quality, hardware performance, and machine reliability.



If you need additional help, go to the Brother Solutions Center at [support.brother.com](http://support.brother.com).

First, check the following:

- The machine's power cord is connected correctly and the machine's power is on. See the *Quick Setup Guide*.
- All of the protective materials have been removed. See the *Quick Setup Guide*.
- Paper is loaded correctly in the paper tray.
- The interface cables are securely connected to the machine and the computer, or the wireless connection is set up on both the machine and your computer.
- Error and maintenance messages

If you did not solve the problem with the checks, identify the problem and then see *Related Information*.



### Related Information

- [Error and Maintenance Messages](#)
- [Paper Jams](#)
- [Printing Problems](#)
- [Improve the Print Quality](#)
- [Network Problems](#)
- [Other Problems](#)
- [Check the Machine Information](#)
- [Reset Functions](#)

## Error and Maintenance Messages



(HL-L6300DW)

If the LCD displays errors and your Android™ device supports the NFC feature, touch your device to the NFC logo on your Brother machine to access the Brother Solutions Center and browse the latest FAQs from your device. (Your mobile telephone provider's message and data rates may apply.)

Make sure the NFC settings of both your Brother machine and your Android™ device are set to On.

As with any sophisticated office product, errors may occur and supply items may have to be replaced. If this happens, your machine identifies the error or required routine maintenance and shows the appropriate message. The most common error and maintenance messages are shown in the table.

Follow the instructions in the **Action** column to solve the error and remove the message.

You can correct most errors and perform routine maintenance by yourself. If you need more tips: Visit [support.brother.com](http://support.brother.com), and click **FAQs & Troubleshooting**.

### HL-L5000D/HL-L5100DN/HL-L5200DW/HL-L5200DWT/HL-L6200DW/HL-L6200DWT

Error Message	Cause	Action
2-sided Disabled	The back cover of the machine is not closed completely.	Close the back cover of the machine until it locks in the closed position.
	The 2-sided tray is not installed completely.	Install the 2-sided tray firmly in the machine.
Access Denied	The function you want to use is restricted by Secure Function Lock 3.0.	Call your administrator to check your Secure Function Lock Settings.
Cartridge Error	The toner cartridge is not installed correctly.	Remove the toner cartridge and drum unit assembly. Take out the toner cartridge, and put it back in the drum unit again. Reinstall the toner cartridge and drum unit assembly in the machine.  If the problem continues, contact Brother Customer Service or your local Brother dealer.
Cooling Down	The temperature of the inside of the machine is too hot. The machine will pause its current print job and go into cooling down mode.	Make sure you can hear the fan in the machine spinning and that the exhaust outlet is not blocked.  If the fan is spinning, remove any obstacles that surround the exhaust outlet, and then leave the machine turned on but do not use it for several minutes.  If the fan is not spinning, disconnect the machine from the power for several minutes, then reconnect it.
Cover is Open	The front cover is not completely closed.	Open and then firmly close the front cover of the machine.
Cover is Open	The fuser cover is not completely closed.	Close the fuser cover located inside the back cover of the machine.

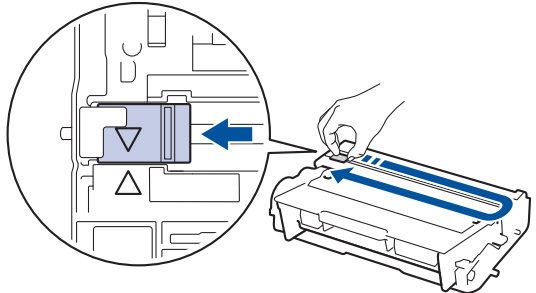
Error Message	Cause	Action
Drum !	The corona wire on the drum unit must be cleaned.	Clean the corona wire on the drum unit.  <p>See <i>Related Information: Clean the Corona Wire.</i></p> If the problem continues, replace the drum unit with a new one.
	The drum unit or the toner cartridge and drum unit assembly is not installed correctly.	Remove the drum unit, remove the toner cartridge from the drum unit, and put the toner cartridge back into the drum unit. Reinstall the drum unit in the machine.
Drum End Soon	The drum unit is near the end of its life.	Order a new drum unit before the LCD displays <code>Replace Drum</code> .
Jam 2-sided	The paper is jammed in the 2-sided tray or inside the back cover.	Remove the 2-sided tray and open the back cover to pull out all jammed paper.
Jam Inside	The paper is jammed inside the machine.	Open the front cover, remove the toner cartridge and drum unit assembly, and pull out all jammed paper. Close the front cover.
Jam MP Tray	The paper is jammed in the MP tray.	Remove all jammed paper from in and around the MP tray. Press <b>Go</b> .
Jam Rear	The paper is jammed in the back of the machine.	Open the fuser cover and remove all jammed paper. Close the fuser cover.
Jam Tray 1 Jam Tray 2 Jam Tray 3 Jam Tray 4	The paper is jammed in the indicated paper tray.	Pull out the paper tray indicated on the LCD and remove all jammed paper.
Limit Exceeded	The print limit set in Secure Function Lock 3.0 was reached.	Call your administrator to check your Secure Function Lock Settings.
Media Mismatch	The media type specified in the printer driver differs from the paper type specified in the machine's menu.	Load the correct type of paper in the tray indicated on the LCD, and then select the correct media type in the Paper Type setting on the machine.
No Drum Unit	The drum unit is not installed correctly.	Reinstall the toner cartridge and drum unit assembly.
No Paper	The machine is out of paper, or paper is not loaded correctly in the paper tray.	<ul style="list-style-type: none"> <li>• Refill paper in the paper tray. Make sure the paper guides are set to the correct size.</li> <li>• If paper is in the tray, remove it and load it again. Make sure the paper guides are set to the correct size.</li> <li>• Do not overfill the paper tray.</li> </ul>
No Paper Fed T2 No Paper Fed T3 No Paper Fed T4	The machine failed to feed paper from the indicated paper tray.	Pull out the paper tray indicated on the LCD and remove all jammed paper.

Error Message	Cause	Action
No Paper MP	The MP tray is out of paper, or paper is not loaded correctly in the MP tray.	Do one of the following: <ul style="list-style-type: none"> <li>• Refill paper in the MP tray. Make sure the paper guides are set to the correct size.</li> <li>• If paper is in the tray, remove it and load it again. Make sure the paper guides are set to the correct size.</li> </ul>
No Paper T1 No Paper T2 No Paper T3 No Paper T4	The machine failed to feed paper from the indicated paper tray.	Do one of the following: <ul style="list-style-type: none"> <li>• Refill paper in the paper tray indicated on the LCD. Make sure the paper guides are set to the correct size.</li> <li>• If paper is in the tray, remove it and load it again. Make sure the paper guides are set to the correct size.</li> <li>• Do not overfill the paper tray.</li> </ul>
No Toner	The toner cartridge or the toner cartridge and drum unit assembly is not installed correctly.	Remove the toner cartridge and drum unit assembly. Remove the toner cartridge from the drum unit, and reinstall the toner cartridge back in the drum unit. Reinstall the toner cartridge and drum unit assembly back in the machine. If the problem continues, replace the toner cartridge with a new one.
No Tray T1 No Tray T2 No Tray T3 No Tray T4	The paper tray is not installed or not installed correctly.	Reinstall the paper tray indicated on the LCD.
Out of Memory	The machine's memory is full.	Press <b>Cancel</b> and reduce the print resolution.
Print Data Full	The machine's memory is full.	Press <b>Cancel</b> and delete the previously stored secure print data.
Print Unable ##	The machine has a mechanical problem.	<ul style="list-style-type: none"> <li>• Press and hold  to turn off the machine, wait a few minutes, and then turn it on again.</li> <li>• If the problem continues, contact Brother Customer Service. Contact Brother Customer Service at: 1-877-BROTHER (1-877-276-8437) (in USA) <a href="http://www.brother.ca/support">www.brother.ca/support</a> (in Canada) or to locate a Brother Authorized Service Center, visit: <a href="http://www.brother-usa.com/service">http://www.brother-usa.com/service</a></li> </ul>
Replace Drum	It is time to replace the drum unit.	Replace the drum unit with a new one. <i>See Related Information: Replace the Drum Unit.</i>
	The drum unit counter was not reset when a new drum was installed.	Reset the drum unit counter. See the instructions included with the new drum unit.
Replace Toner	The toner cartridge is at the end of its life. The machine stops all print operations.	Replace the toner cartridge with a new one.





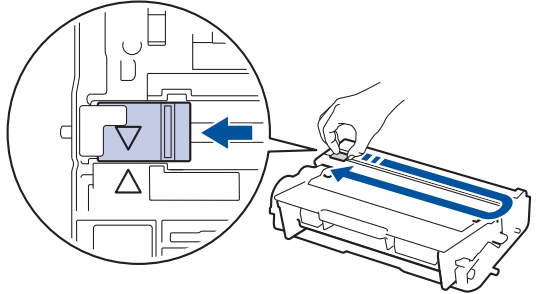

Error Message	Cause	Action
Self-Diagnostic	The temperature of the fuser unit does not rise to a specified temperature within the specified time.	Press and hold  to turn off the machine, wait a few seconds, and then turn it on again. Leave the machine idle for 15 minutes with the power on.
	The fuser unit is too hot.	
Size Error	The paper size defined in the printer driver is not supported by the defined tray.	Choose a paper size supported by the defined tray.
Size Error DX	The paper size specified in the machine's paper size setting is not available for automatic 2-sided printing.	Press <b>Cancel</b> (if required). Load the correct size of paper in the tray and set the tray for that paper size. Choose a paper size supported by 2-sided printing. Paper sizes available for automatic 2-sided printing are Letter, Legal, Mexico Legal, India Legal and Folio.
	The paper in the tray is not the correct size and is not available for automatic 2-sided printing.	
Size Mismatch	The paper in the tray is not the correct size.	Load the correct size of paper in the tray indicated on the LCD and set the size of paper for the tray. Press <b>Go</b> .
Toner Low	If the LCD displays this message, you can still print. The toner cartridge is near the end of its life.	Order a new toner cartridge now so you have it ready when the LCD displays <i>Replace Toner</i> .
Too Many Trays	The number of installed Optional Trays exceeds the maximum number.	Reduce the number of Optional Trays.

## HL-L6300DW

Error Message	Cause	Action
2-sided Disabled	The back cover of the machine is not closed completely.	Close the back cover of the machine until it locks in the closed position.
	The 2-sided tray is not installed completely.	Install the 2-sided tray firmly in the machine.
Access Denied	The function you want to use is restricted by Secure Function Lock 3.0.	Call your administrator to check your Secure Function Lock Settings.
Cartridge Error	The toner cartridge is not installed correctly.	Remove the toner cartridge and drum unit assembly. Take out the toner cartridge, and put it back in the drum unit again. Reinstall the toner cartridge and drum unit assembly in the machine.  If the problem continues, contact Brother Customer Service or your local Brother dealer.
Cooling Down	The temperature of the inside of the machine is too hot. The machine will pause its current print job and go into cooling down mode.	Make sure you can hear the fan in the machine spinning and that the exhaust outlet is not blocked.  If the fan is spinning, remove any obstacles that surround the exhaust outlet, and then leave the machine turned on but do not use it for several minutes.  If the fan is not spinning, disconnect the machine from the power for several minutes, then reconnect it.
Cover is Open	The front cover is not completely closed.	Open and then firmly close the front cover of the machine.

Error Message	Cause	Action
Cover is Open	The fuser cover is not completely closed.	Close the fuser cover located inside the back cover of the machine.
Cover is Open	The Mailbox back cover is not completely closed.	Close the Mailbox back cover.
Drum !	The corona wire on the drum unit must be cleaned.	<p>Clean the corona wire on the drum unit.</p>  <p>See <i>Related Information: Clean the Corona Wire.</i></p> <p>If the problem continues, replace the drum unit with a new one.</p>
	The drum unit or the toner cartridge and drum unit assembly is not installed correctly.	Remove the drum unit, remove the toner cartridge from the drum unit, and put the toner cartridge back into the drum unit. Reinstall the drum unit in the machine.
Jam 2-sided	The paper is jammed in the 2-sided tray or inside the back cover.	Remove the 2-sided tray and open the back cover to pull out all jammed paper.
Jam Inside	The paper is jammed inside the machine.	Open the front cover, remove the toner cartridge and drum unit assembly, and pull out all jammed paper. Close the front cover.
Jam Mailbox	The paper is jammed in the Mailbox unit.	Remove all jammed paper from the Mailbox unit as shown on the LCD.
Jam MP Tray	The paper is jammed in the MP tray.	Remove all jammed paper from in and around the MP tray. Press <code>Retry</code> .
Jam Rear	The paper is jammed in the back of the machine.	Open the fuser cover and remove all jammed paper. Close the fuser cover.
Jam Tray Jam Tray1 Jam Tray2 Jam Tray3 Jam Tray4	The paper is jammed in the indicated paper tray.	Pull out the paper tray and remove all jammed paper as shown in the animation on the LCD.
Limit Exceeded	The print limit set in Secure Function Lock 3.0 was reached.	Call your administrator to check your Secure Function Lock Settings.
Media Type Mismatch	The media type specified in the printer driver differs from the paper type specified in the machine's menu.	Load the correct type of paper in the tray indicated on the LCD, and then select the correct media type in the Paper Type setting on the machine.
No Drum Unit	The drum unit is not installed correctly.	Reinstall the toner cartridge and drum unit assembly.
No HUB Support	A USB hub device is connected to the USB host connector.	Disconnect the USB hub device from the USB host connector.

Error Message	Cause	Action
No Paper	The machine is out of paper, or paper is not loaded correctly in the paper tray.	<ul style="list-style-type: none"> <li>• Refill paper in the paper tray. Make sure the paper guides are set to the correct size.</li> <li>• If paper is in the tray, remove it and load it again. Make sure the paper guides are set to the correct size.</li> <li>• Do not overfill the paper tray.</li> </ul>
No Paper Fed T1 No Paper Fed T2 No Paper Fed T3 No Paper Fed T4	The machine failed to feed paper from the indicated paper tray.	Pull out the paper tray indicated on the LCD and remove all jammed paper.
No Paper MP	The MP tray is out of paper, or paper is not loaded correctly in the MP tray.	<p>Do one of the following:</p> <ul style="list-style-type: none"> <li>• Refill paper in the MP tray. Make sure the paper guides are set to the correct size.</li> <li>• If paper is in the tray, remove it and load it again. Make sure the paper guides are set to the correct size.</li> </ul>
No Paper T1 No Paper T2 No Paper T3 No Paper T4	The machine failed to feed paper from the indicated paper tray.	<p>Do one of the following:</p> <ul style="list-style-type: none"> <li>• Refill paper in the paper tray indicated on the LCD. Make sure the paper guides are set to the correct size.</li> <li>• If paper is in the tray, remove it and load it again. Make sure the paper guides are set to the correct size.</li> <li>• Do not overfill the paper tray.</li> </ul>
No Toner	The toner cartridge or the toner cartridge and drum unit assembly is not installed correctly.	Remove the toner cartridge and drum unit assembly. Remove the toner cartridge from the drum unit, and reinstall the toner cartridge back in the drum unit. Reinstall the toner cartridge and drum unit assembly back in the machine. If the problem continues, replace the toner cartridge with a new one.
No Tray T1 No Tray T2 No Tray T3 No Tray T4	The paper tray is not installed or not installed correctly.	Reinstall the paper tray indicated on the LCD.
Out of Memory	The machine's memory is full.	Press  and reduce the print resolution.
Output Tray Full	The output paper tray is full.	Remove printed paper from output tray indicated on the LCD.
Paper Low Paper Low Tray 1 Paper Low Tray 2 Paper Low Tray 3 Paper Low Tray 4	The paper tray is nearly empty.	Refill the paper in the paper tray indicated on the LCD.
Print Data Full	The machine's memory is full.	Press  and delete the previously stored secure print data.

Error Message	Cause	Action
Print Unable ##	The machine has a mechanical problem.	<ul style="list-style-type: none"> <li>Press and hold  to turn off the machine, wait a few minutes, and then turn it on again.</li> <li>If the problem continues, contact Brother Customer Service. Contact Brother Customer Service at: 1-877-BROTHER (1-877-276-8437) (in USA) <a href="http://www.brother.ca/support">www.brother.ca/support</a> (in Canada) or to locate a Brother Authorized Service Center, visit: <a href="http://www.brother-usa.com/service">http://www.brother-usa.com/service</a></li> </ul>
Replace Toner	The toner cartridge is at the end of its life. The machine stops all print operations.	Replace the toner cartridge with a new one.
Screen Init. Fail	The Touchscreen was pressed before the power on initialization was completed.	Make sure nothing is touching the Touchscreen.
	Debris may be stuck between the lower part of the Touchscreen and its frame.	Insert a piece of stiff paper between the lower part of the Touchscreen and its frame and slide it back and forth to push out any debris.
Self-Diagnostic	The temperature of the fuser unit does not rise to a specified temperature within the specified time.	Press and hold  to turn off the machine, wait a few seconds, and then turn it on again. Leave the machine idle for 15 minutes with the power on.
	The fuser unit is too hot.	
Size Error	The paper size defined in the printer driver is not supported by the defined tray.	Choose a paper size supported by the defined tray.
Size Error 2-sided	The paper size specified in the machine's paper size setting is not available for automatic 2-sided printing.	Press  (if required). Load the correct size of paper in the tray and set the tray for that paper size.
	The paper in the tray is not the correct size and is not available for automatic 2-sided printing.	Choose a paper size supported by 2-sided printing. Paper sizes available for automatic 2-sided printing are Letter, Legal, Mexico Legal, India Legal and Folio.
Size Mismatch	The paper in the tray is not the correct size.	Load the correct size of paper in the tray indicated on the LCD and set the size of paper for the tray. Press <code>Retry</code> .
Supplies Drum End Soon	The drum unit is near the end of its life.	Order a new drum unit before the LCD displays <code>Replace Drum</code> .
Supplies Replace Drum	It is time to replace the drum unit.	Replace the drum unit with a new one. <i>See Related Information: Replace the Drum Unit.</i>
	The drum unit counter was not reset when a new drum was installed.	Reset the drum unit counter. See the instructions included with the new drum unit.
Supplies Toner Low	If the LCD displays this message, you can still print. The toner cartridge is near the end of its life.	Order a new toner cartridge now so you have it ready when the LCD displays <code>Replace Toner</code> .

Error Message	Cause	Action
Too many bins	Either bin 2 tray or bin 4 tray was removed from the Mailbox unit.	To use the Mailbox unit in 2-bin mode, remove both bin 2 tray and bin 4 tray. To use the Mailbox unit in 4-bin mode, install both bin 2 tray and bin 4 tray.
Too Many Trays	The number of installed Optional Trays exceeds the maximum number.	Reduce the number of Optional Trays.
Unusable Device	An unsupported USB device has been connected to the USB host connector.	Unplug the device from the USB host connector.



## Related Information

- [Troubleshooting](#)
- [Replace Supplies](#)
- [Load and Print Using the Paper Tray](#)
- [Load and Print Using the Multi-purpose Tray \(MP Tray\)](#)
- [Replace the Drum Unit](#)
- [Clean the Corona Wire](#)

## Paper Jams

Always remove the remaining paper from the paper tray and straighten the stack when you are adding new paper. This helps prevent multiple sheets of paper from feeding through the machine at one time and prevents paper jams.

- [Paper is Jammed in the MP tray](#)
- [Paper is Jammed in the Paper Tray](#)
- [Paper is Jammed in the Back of the Machine](#)
- [Paper is Jammed inside the Machine](#)
- [Paper is Jammed in the 2-sided Tray](#)
- [Paper is Jammed in the Mailbox Unit](#)

## Paper is Jammed in the MP tray

If the machine's control panel or the Status Monitor indicates that there is a jam in the machine's MP tray, follow these steps:

1. Remove the paper from the MP tray.
2. Remove any jammed paper from in and around the MP tray.

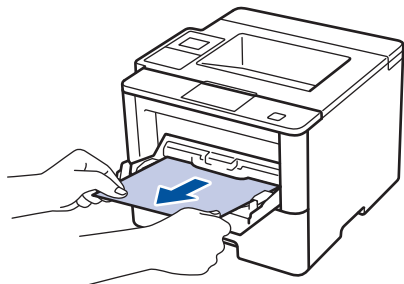

3. Fan the paper stack, and then put it back in the MP tray.
4. Reload paper in the MP tray and make sure the paper stays under the maximum paper height guides (1) on both sides of the tray.

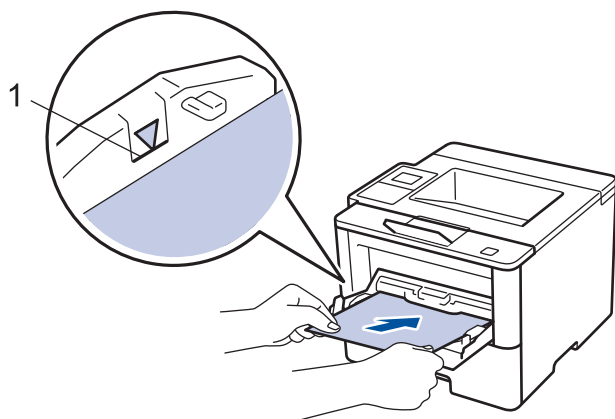

5. Do one of the following:
  - (HL-L5000D/HL-L5100DN/HL-L5200DW/HL-L5200DWT/HL-L6200DW/HL-L6200DWT)  
Press **Go** to resume printing.
  - (HL-L6300DW)  
Press **[Retry]** to resume printing.



### Related Information

- [Paper Jams](#)

## Paper is Jammed in the Paper Tray

If the machine's control panel or the Status Monitor indicates that there is a jam in the paper tray, follow these steps:

1. Pull the paper tray completely out of the machine.

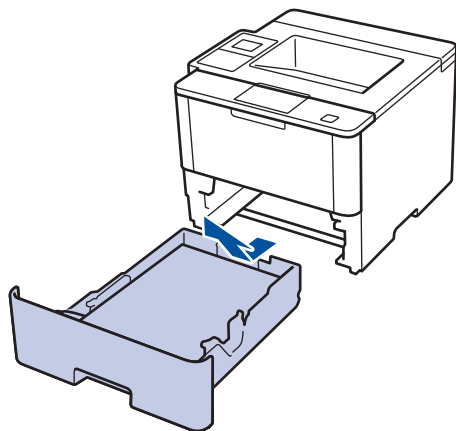

2. Slowly pull out the jammed paper.

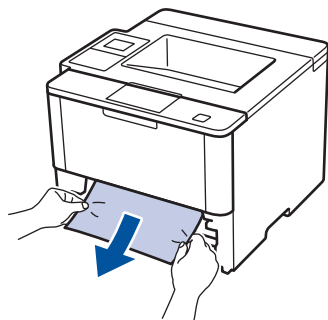

Pulling the jammed paper downward using both hands allows you to remove the paper more easily.

3. Fan the stack of paper to prevent further jams, and slide the paper guides to fit the paper size.

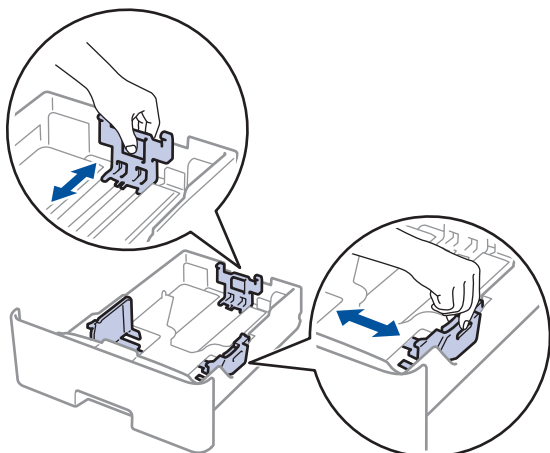

4. Make sure the paper is below the maximum paper mark (▼▼▼).



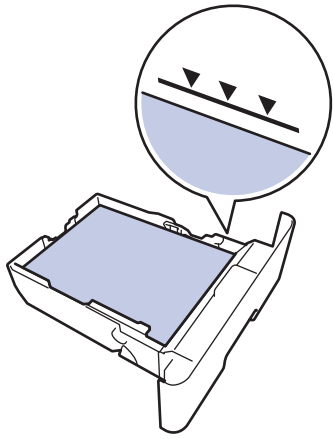

5. Put the paper tray firmly back in the machine.



### Related Information

- [Paper Jams](#)
-

## Paper is Jammed in the Back of the Machine

If the machine's control panel or the Status Monitor indicates that there is a jam in the back (Rear) of the machine, follow these steps:

1. Leave the machine turned on for 10 minutes for the internal fan to cool the extremely hot parts inside the machine.
2. Open the back cover.

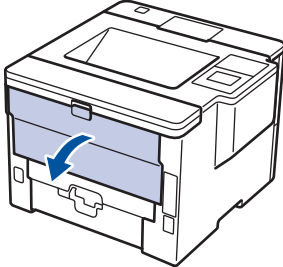

3. Pull the green levers at the left and right sides toward you to release the fuser cover.

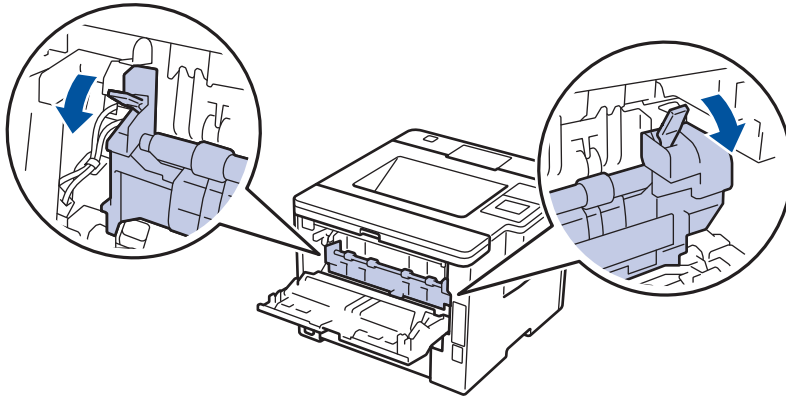

### WARNING

#### HOT SURFACE

The machine's internal parts will be extremely hot. Wait for the machine to cool down before touching them.

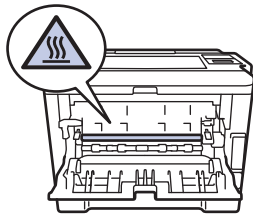

4. Use both hands to gently pull the jammed paper out of the fuser unit.

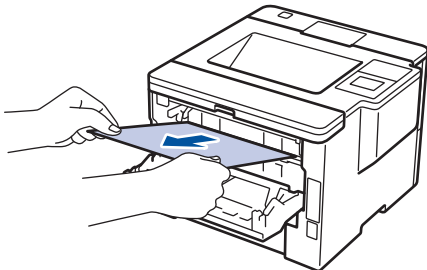

---

5. Close the fuser cover.

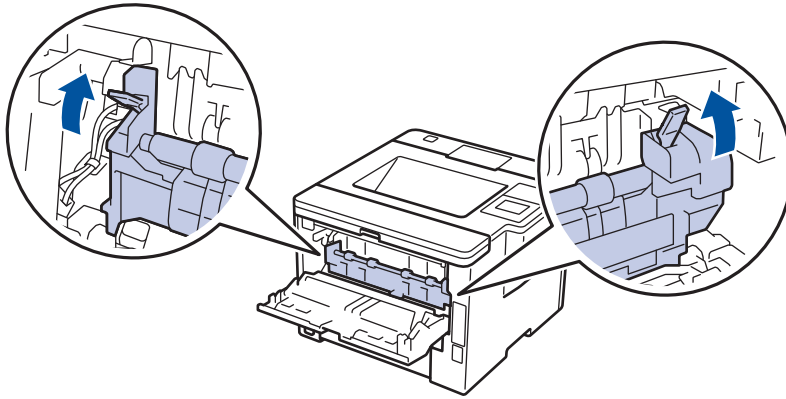

6. Close the back cover until it locks in the closed position.

### Related Information

- [Paper Jams](#)

## Paper is Jammed inside the Machine

If the machine's control panel or the Status Monitor indicates that there is a jam inside the machine, follow these steps:

1. Leave the machine turned on for 10 minutes for the internal fan to cool the extremely hot parts inside the machine.
2. Open the front cover.

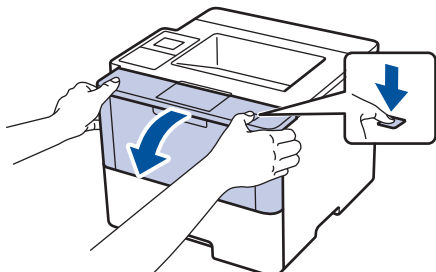

3. Remove the toner cartridge and drum unit assembly.

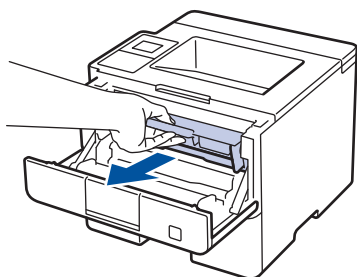

### **WARNING**

#### HOT SURFACE

The machine's internal parts will be extremely hot. Wait for the machine to cool down before touching them.

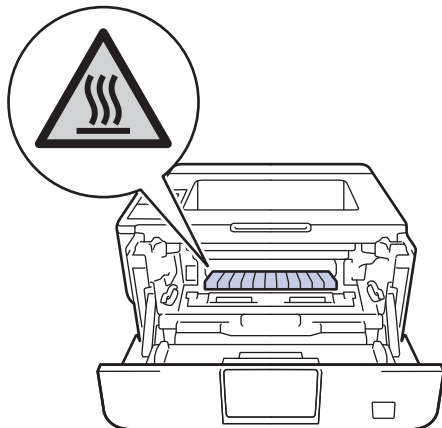

4. Pull out the jammed paper slowly.

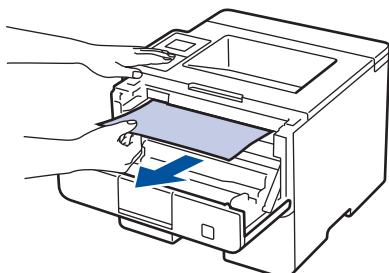

5. Install the toner cartridge and drum unit assembly into the machine.

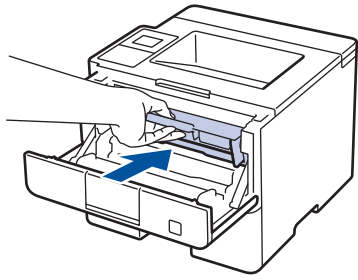

6. Close the front cover.

### **Related Information**

- [Paper Jams](#)

## Paper is Jammed in the 2-sided Tray

If the machine's control panel or the Status Monitor indicates that there is a jam in the 2-sided paper tray, follow these steps:

1. Leave the machine turned on for 10 minutes for the internal fan to cool the extremely hot parts inside the machine.
2. Pull the paper tray completely out of the machine.

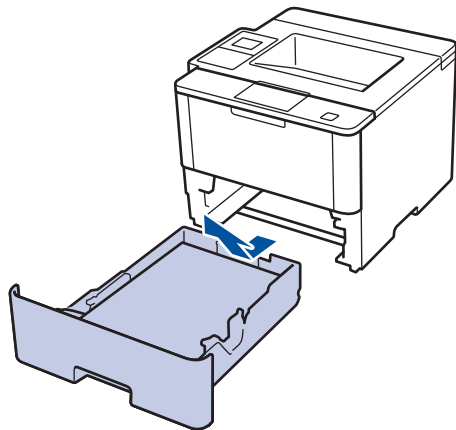

3. At the back of the machine, pull the 2-sided tray completely out of the machine.

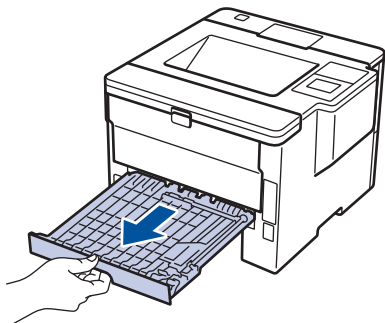

4. Pull the jammed paper out of the machine or out of the 2-sided tray.

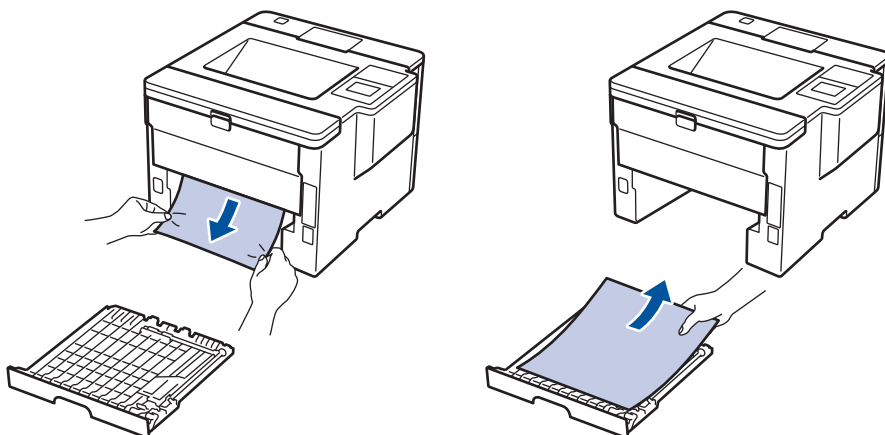

5. Remove paper that may have jammed under the machine due to static electricity.

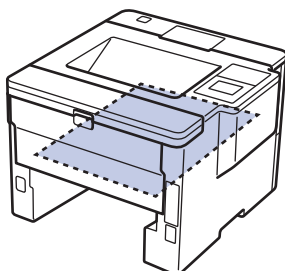

- 
6. If paper is not caught inside the 2-sided tray, open the back cover.

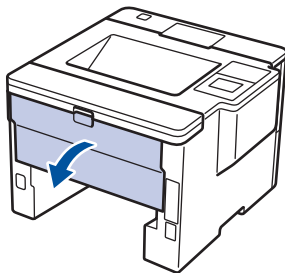

## **WARNING**

### HOT SURFACE

The machine's internal parts will be extremely hot. Wait for the machine to cool down before touching them.

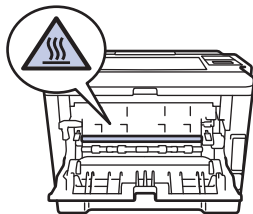

- 
7. Use both hands to gently pull the jammed paper out of the back of the machine.

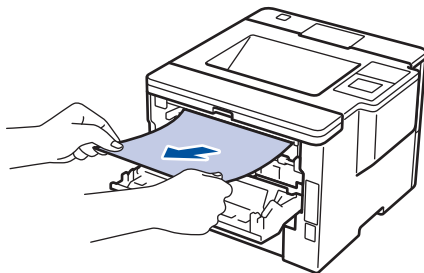

8. Close the back cover until it locks in the closed position.  
9. Put the 2-sided tray firmly back in the rear of the machine.  
10. Put the paper tray firmly back in the front of the machine.

## **Related Information**

- [Paper Jams](#)

## Paper is Jammed in the Mailbox Unit

**Related Models:** HL-L6300DW

If the machine's control panel or the Status Monitor indicates that there is a jam in the Mailbox unit, follow these steps:

1. Pull the jammed paper out of the Mailbox bin indicated on the LCD.

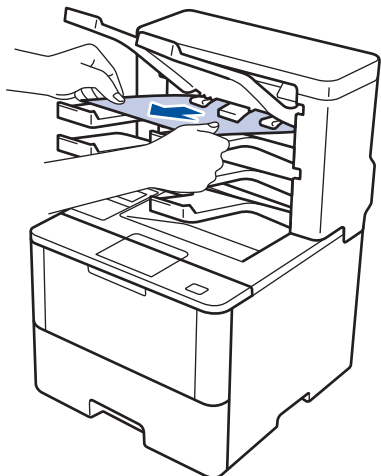

2. If the error continues, open the Mailbox's back cover.

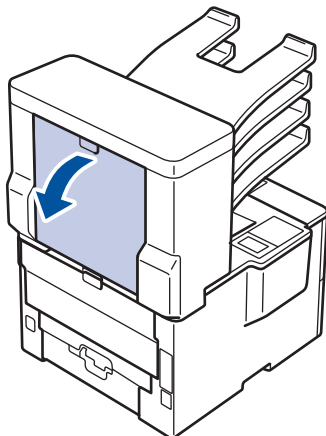

3. Pull the jammed paper out of the Mailbox unit.

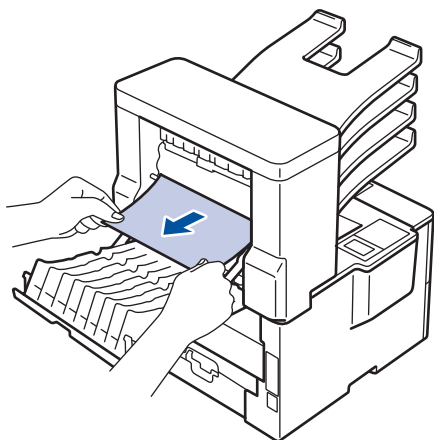

4. Close the Mailbox's back cover until it locks in the closed position.







### Related Information

- [Paper Jams](#)



## Printing Problems

Difficulties	Suggestions
No printout	<p>Check that the correct printer driver has been installed and selected.</p> <p>Check to see if the Status Monitor or the machine's control panel displays an error status.</p> <p>Check that the machine is online:</p> <ul style="list-style-type: none"> <li>• Windows® 7 and Windows Server® 2008 R2 Click /Start &gt; <b>Devices and Printers</b> . Right-click <b>Brother XXX-XXXX</b> and click <b>See what's printing</b>. Click <b>Printer</b> in the menu bar. Make sure <b>Use Printer Offline</b> is not selected.</li> <li>• Windows Vista® and Windows Server® 2008 Click /Start &gt; <b>Control Panel &gt; Hardware and Sound &gt; Printers</b>. Right-click <b>Brother XXX-XXXX</b>. Make sure <b>Use Printer Online</b> is not listed. If it is listed, click this option to set the driver Online.</li> <li>• Windows® XP and Windows Server® 2003 Click the <b>Start &gt; Printers and Faxes</b>. Right-click <b>Brother XXX-XXXX</b>. Make sure <b>Use Printer Online</b> is not listed. If it is listed, click this option to set the driver Online.</li> <li>• Windows® 8 and Windows Server® 2012 Move your mouse to the lower right corner of your desktop. When the menu bar appears, click <b>Settings &gt; Control Panel &gt; Hardware and Sound &gt; View devices and printers</b>. Right-click the <b>Brother XXX-XXXX</b>. Click <b>See what's printing</b>. If printer driver options appear, select your printer driver. Click <b>Printer</b> in the menu bar and make sure that <b>Use Printer Offline</b> is not selected.</li> <li>• Windows Server® 2012 R2 Click <b>Control Panel</b> on the <b>Start</b> screen. In the <b>Hardware</b> group, click <b>View devices and printers</b>. Right-click the <b>Brother XXX-XXXX</b>. Click <b>See what's printing</b>. If printer driver options appear, select your printer driver. Click <b>Printer</b> in the menu bar and make sure <b>Use Printer Offline</b> is not selected.</li> </ul> <p>Check the machine is not in Power Off mode.</p> <p>If the machine is in Power Off mode, press  on the control panel, and then send the print data again.</p>
The machine is not printing or has stopped printing.	<p>(HL-L5000D/HL-L5100DN/HL-L5200DW/HL-L5200DWT/HL-L6200DW/HL-L6200DWT) Press <b>Cancel</b>.</p> <p>(HL-L6300DW) Press .</p> <p>The machine will cancel the print job and clear it from the machine's memory. The printout may be incomplete. Send the print data again.</p>
The machine prints unexpectedly or it prints garbage. The headers or footers appear when the document displays on the screen but they do not show up when it is printed.	<p>There is an unprintable area on the top and bottom of the page. Adjust the top and bottom margins in your document to allow for this.</p>

Difficulties	Suggestions
	<p>(HL-L5000D/HL-L5100DN/HL-L5200DW/HL-L5200DWT/HL-L6200DW/HL-L6200DWT) Press <b>Cancel</b>.</p> <p>(HL-L6300DW) Press .</p>
	<p>Check the settings in your application to make sure they are set up to work with your machine.</p>
	<p>Confirm that the Brother printer driver is selected in your application's Print window.</p>
The machine prints the first couple of pages correctly, then some pages have missing text.	<p>Check the settings in your application to make sure they are set up to work with your machine.</p>
	<p>Your computer is not recognizing the full signal of the machine's input buffer. Make sure you connected the interface cable correctly.</p>
The machine does not print on both sides of the paper even though the printer driver setting is 2-sided and the machine supports automatic 2-sided printing.	<p>Check the paper size setting in the printer driver. You must select Letter, Legal, Folio, Mexico Legal and India Legal paper that is 16 to 28 lb (60 to 105 g/m<sup>2</sup>)</p>
Print speed is too slow.	<p>Try changing the printer driver setting. The highest resolution needs longer data processing, sending and printing time.</p>
The machine does not feed paper.	<p>If there is paper in the paper tray, make sure it is straight. If the paper is curled, straighten it. Sometimes it is helpful to remove the paper, turn the stack over and put it back in the paper tray.</p>
	<p>Reduce the amount of paper in the paper tray, and then try again.</p>
	<p>Make sure <b>MP Tray</b> is not selected for <b>Paper Source</b> in the printer driver.</p>
	<p>Clean the paper pick-up rollers.</p>
The machine does not feed paper from the MP tray.	<p>Fan the paper well and put it back in the MP tray firmly.</p>
	<p>Make sure <b>MP Tray</b> is selected as <b>Paper Source</b> in the printer driver.</p>
The machine does not feed envelopes.	<p>Load envelopes in the MP tray. Your application must be set to print the envelope size you are using. This is usually done in the Page Setup or Document Setup menu of your application.</p>



## Related Information

- [Troubleshooting](#)
- [Monitor the Status of the Machine from Your Computer \(Windows®\)](#)
- [Monitor the Status of the Machine from Your Computer \(Macintosh\)](#)
- [Cancel a Print Job](#)
- [Load and Print Using the Paper Tray](#)
- [Clean the Paper Pick-up Rollers](#)
- [Load and Print Using the Multi-purpose Tray \(MP Tray\)](#)



## Improve the Print Quality







If you have a print quality problem, print a test page first. If the printout looks good, the problem is probably not the machine. Check the interface cable connections and try printing a different document. If the printout or test page printed from the machine has a quality problem, check the examples of poor print quality in the table and follow the recommendations.





### IMPORTANT



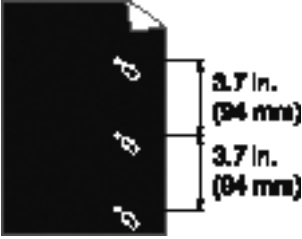
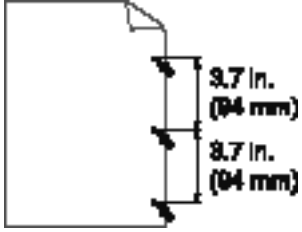

Using non-Brother supplies may affect the print quality, hardware performance, and machine reliability.

1. To get the best print quality, we suggest using recommended print media. Make sure you use paper that meets our specifications.
2. Check that the toner cartridge and drum unit are installed correctly.

Examples of poor print quality	Recommendation
 <p>Faint</p>	<ul style="list-style-type: none"> <li>• If the machine indicates Replace Toner status, install a new toner cartridge.</li> <li>• Check the machine's environment. Conditions such as humidity, high temperatures, and so on, may cause this print fault.</li> <li>• If the whole page is too light, Toner Save may be turned on. Turn off Toner Save mode in the machine's menu settings or the printer driver.</li> <li>• Clean the drum unit.</li> <li>• Clean the corona wire on the drum unit.</li> <li>• Replace the toner cartridge with a new toner cartridge.</li> <li>• Replace the drum unit with a new drum unit.</li> </ul>
 <p>Gray background</p>	<ul style="list-style-type: none"> <li>• Check the machine's environment. Conditions such as high temperatures and high humidity can increase the amount of background shading.</li> <li>• Clean the drum unit.</li> <li>• Replace the toner cartridge with a new toner cartridge.</li> <li>• Replace the drum unit with a new drum unit.</li> </ul>
 <p>Ghost</p>	<ul style="list-style-type: none"> <li>• Check the machine's environment. Conditions such as low humidity and low temperatures may cause this print quality problem.</li> <li>• Select the appropriate media type in the printer driver.</li> <li>• Select the appropriate media type in the menu setting.</li> <li>• Clean the drum unit.</li> <li>• Replace the drum unit with a new drum unit.</li> <li>• Replace the toner cartridge with a new toner cartridge.</li> <li>• The fuser unit may be contaminated. Contact Brother Customer Service. In USA: 1-877-BROTHER (1-877-276-8437) In Canada: <a href="http://www.brother.ca/support">www.brother.ca/support</a></li> </ul>

Examples of poor print quality	Recommendation
 <p>Toner specks</p>	<ul style="list-style-type: none"> <li>• Make sure the media type setting in the driver matches the type of paper you are using.</li> <li>• Clean the drum unit.</li> <li>• The toner cartridge may be damaged. Replace the toner cartridge with a new toner cartridge.</li> <li>• The drum unit may be damaged. Replace the drum unit with a new drum unit.</li> <li>• The fuser unit may be contaminated. Contact Brother Customer Service. In USA: 1-877-BROTHER (1-877-276-8437) In Canada: <a href="http://www.brother.ca/support">www.brother.ca/support</a></li> </ul>
 <p>Hollow print</p>	<ul style="list-style-type: none"> <li>• Select <b>Thick Paper</b> mode in the printer driver or use thinner paper than you are currently using.</li> <li>• Select the appropriate media type in the menu setting.</li> <li>• Check the machine's environment. Conditions such as high humidity can cause hollow print.</li> <li>• The drum unit may be damaged. Replace the drum unit with a new drum unit.</li> </ul>
 <p>All black</p>	<ul style="list-style-type: none"> <li>• Clean the corona wire inside the drum unit.</li> <li>• The drum unit may be damaged. Replace the drum unit with a new drum unit.</li> </ul>
 <p>White lines across the page</p>	<ul style="list-style-type: none"> <li>• Select the appropriate media type in the printer driver.</li> <li>• Select the appropriate media type in the menu setting.</li> <li>• The problem may disappear by itself. Print multiple blank pages to clear this problem, especially if the machine has not been used for a long time.</li> <li>• Clean the drum unit.</li> <li>• The drum unit may be damaged. Replace the drum unit with a new drum unit.</li> </ul>
 <p>Lines across the page</p>	<ul style="list-style-type: none"> <li>• Clean the drum unit.</li> <li>• The drum unit may be damaged. Replace the drum unit with a new drum unit.</li> </ul>
 <p>White lines, bands or ribbing across the page</p>	<ul style="list-style-type: none"> <li>• Check the machine's environment. Conditions such as high humidity and high temperatures may cause this print quality problem.</li> <li>• Clean the drum unit.</li> <li>• If the problem is not solved after printing a few pages, replace the drum unit with a new drum unit.</li> </ul>

Examples of poor print quality	Recommendation
 <p>White Spots on black text and graphics at 3.7 in. (94 mm) intervals</p>  <p>Black spots at 3.7 in. (94 mm) intervals</p>	<ul style="list-style-type: none"> <li>• If the problem is not solved after printing a few pages, the drum unit may have foreign material, such as glue from a label, stuck on the drum. Clean the drum unit. See <i>Related Information: Clean the Drum Unit.</i></li> <li>• The drum unit may be damaged. Replace the drum unit with a new drum unit.</li> </ul>
 <p>Black toner marks across the page</p>	<ul style="list-style-type: none"> <li>• If you use label sheets for laser printers, the glue from the sheets may sometimes stick to the drum surface. Clean the drum unit. See <i>Related Information: Clean the Drum Unit.</i></li> <li>• If you used paper that has clips or staples, the drum unit may be damaged.</li> <li>• If the unpacked drum unit is in direct sunlight (or room light for long periods of time), the unit may be damaged.</li> <li>• Clean the drum unit.</li> <li>• The toner cartridge may be damaged. Replace the toner cartridge with a new toner cartridge.</li> <li>• The drum unit may be damaged. Replace the drum unit with a new drum unit.</li> </ul>
 <p>Black lines down the page Printed pages have toner stains down the page</p>	<ul style="list-style-type: none"> <li>• Clean the corona wire inside the drum unit by sliding the green tab. Make sure that the green tab on the drum unit is in the Home position.</li> <li>• The toner cartridge may be damaged. Replace the toner cartridge with a new toner cartridge.</li> <li>• The drum unit may be damaged. Replace the drum unit with a new drum unit.</li> <li>• The fuser unit may be contaminated. Contact Brother Customer Service. In USA: 1-877-BROTHER (1-877-276-8437) In Canada: <a href="http://www.brother.ca/support">www.brother.ca/support</a></li> </ul>
 <p>White lines down the page</p>	<ul style="list-style-type: none"> <li>• Make sure foreign material such as a torn piece of paper, sticky notes or dust is not inside the machine and around the toner cartridge and drum unit.</li> <li>• The toner cartridge may be damaged. Replace the toner cartridge with a new toner cartridge.</li> <li>• The drum unit may be damaged. Replace the drum unit with a new drum unit.</li> </ul>

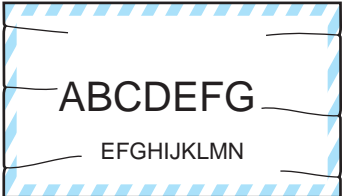
Examples of poor print quality	Recommendation
 <p data-bbox="392 398 560 427">Image skewed</p>	<ul data-bbox="818 168 1474 573" style="list-style-type: none"> <li>• Make sure the paper or other print media is loaded correctly in the paper tray and the guides are not too tight or too loose against the paper stack.</li> <li>• Set the paper guides correctly.</li> <li>• The paper tray may be too full.</li> <li>• Check the paper type and quality.</li> <li>• Check for loose objects such as torn paper inside the machine.</li> <li>• If the problem only occurs during automatic 2-sided printing, check for torn paper in the 2-sided tray. Verify the 2-sided tray is inserted completely and the back cover is closed completely.</li> </ul>
 <p data-bbox="392 840 560 869">Curled or wavy</p>	<ul data-bbox="818 593 1474 952" style="list-style-type: none"> <li>• Check the paper type and quality. High temperatures and high humidity will cause paper to curl.</li> <li>• If you do not use the machine often, the paper may have been in the paper tray too long. Turn over the stack of paper in the paper tray. Also, fan the paper stack, and then rotate the paper 180° in the paper tray.</li> <li>• Open the back cover (face up output tray) to let the printed paper exit onto the face up output tray.</li> <li>• Choose <b>Reduce Paper Curl</b> mode in the printer driver when you do not use our recommended print media.</li> </ul>
 <p data-bbox="360 1205 592 1234">Wrinkles or creases</p>	<ul data-bbox="818 969 1442 1108" style="list-style-type: none"> <li>• Make sure paper is loaded correctly.</li> <li>• Check the paper type and quality.</li> <li>• Turn over the stack of paper in the tray or rotate the paper 180° in the input tray.</li> </ul>
 <p data-bbox="411 1485 541 1514">Poor fixing</p>	<ul data-bbox="818 1249 1433 1377" style="list-style-type: none"> <li>• Make sure the media type setting in the driver matches the type of paper you are using.</li> <li>• Choose <b>Improve Toner Fixing</b> mode in the printer driver.</li> </ul> <p data-bbox="855 1391 1433 1541">If this selection does not provide enough improvement, change the printer driver setting in <b>Media Type</b> to a thick setting. If you are printing an envelope, choose <b>Env. Thick</b> in the media type setting.</p>
 <p data-bbox="371 1753 580 1783">Envelope creases</p>	<ul data-bbox="818 1559 1458 1657" style="list-style-type: none"> <li>• Make sure envelopes are printed with the back cover (face up output tray) opened.</li> <li>• Make sure envelopes are fed only from the MP tray.</li> </ul>

## ✓ Related Information

- [Troubleshooting](#)
- [Test Print](#)
- [Clean the Drum Unit](#)

## Network Problems

- [Error Messages](#)
- [Use the Network Connection Repair Tool \(Windows®\)](#)
- [Where Can I Find My Brother Machine's Network Settings?](#)
- [I Cannot Complete the Wireless Network Setup Configuration](#)
- [My Brother Machine Cannot Print over the Network](#)
- [I Want to Check that My Network Devices are Working Correctly](#)

## Error Messages

**Related Models:** HL-L5100DN/HL-L5200DW/HL-L5200DWT/HL-L6200DW/HL-L6200DWT/HL-L6300DW

Your Brother machine will display an error message if an error occurs. The most common error messages are shown in the table.

### HL-L5100DN/HL-L5200DW/HL-L5200DWT/HL-L6200DW/HL-L6200DWT

Error Messages	Cause	Action
Authentication Error, contact your administrator.	Your authentication setting for the Store Print Log to Network feature is not correct.	<ul style="list-style-type: none"> <li>Make sure the <b>Username</b> and <b>Password</b> in <b>Authentication Setting</b> are correct. If the username is part of a domain, enter the username in one of the following styles: user@domain or domain\user.</li> <li>Make sure the SNTP time server settings are configured correctly so the time matches the time used for authentication by Kerberos or NTLMv2.</li> </ul>
Connection Error	Other devices are trying to connect to the Wi-Fi Direct network at the same time.	Make sure there are no other devices trying to connect to the Wi-Fi Direct network, and then try to configure the Wi-Fi Direct settings again.
Connection Fail	The Brother machine and your mobile device cannot communicate during the Wi-Fi Direct network configuration.	<ul style="list-style-type: none"> <li>Move the mobile device closer to your Brother machine.</li> <li>Move your Brother machine and the mobile device to an obstruction-free area.</li> <li>If you are using the PIN Method of WPS, make sure you have entered the correct PIN.</li> </ul>
File Access Error, contact your administrator.	The Brother machine cannot access the destination folder for the Store Print Log to Network feature.	<ul style="list-style-type: none"> <li>Make sure the stored directory name is correct.</li> <li>Make sure the stored directory is write-enabled.</li> <li>Make sure the file is not locked.</li> </ul>
Log Access Error	In Web Based Management, you have selected the <b>Cancel Print</b> option in the <b>Error Detection Setting</b> of <b>Store Print Log to Network</b> .	Wait for about 60 seconds until this message disappears from the LCD.
No Device	When configuring the Wi-Fi Direct network, the Brother machine cannot find your mobile device.	<ul style="list-style-type: none"> <li>Make sure your machine and mobile device are in the Wi-Fi Direct mode.</li> <li>Move the mobile device closer to your Brother machine.</li> <li>Move your Brother machine and the mobile device to an obstruction-free area.</li> <li>If you are manually configuring the Wi-Fi Direct network, make sure you have entered the correct password.</li> <li>If your mobile device has a configuration page for how to obtain an IP address, make sure the IP address of your mobile device has been configured via DHCP.</li> </ul>
Server Timeout, contact your administrator.	The Brother machine cannot connect to the server for the Store Print Log to Network feature.	<ul style="list-style-type: none"> <li>Make sure your server address is correct.</li> <li>Make sure your server is connected to the network.</li> <li>Make sure the machine is connected to the network.</li> </ul>
Wrong Date&Time, contact your administrator.	The Brother machine does not obtain the time from the SNTP time server.	<ul style="list-style-type: none"> <li>Make sure the settings to access the SNTP time server are configured correctly in Web Based Management.</li> </ul>



Error Messages	Cause	Action
A device is already connected. Press [OK].	Two mobile devices are already connected to the Wi-Fi Direct network when the Brother machine is the Group Owner (G/O).	After the current connection between your Brother machine and another mobile device has shut down, try to configure the Wi-Fi Direct settings again. You can confirm the connection status by printing the Network Configuration Report.
Authentication error, contact your administrator.	Your authentication setting for the Store Print Log to Network feature is not correct.	<ul style="list-style-type: none"> <li>Make sure the <b>Username</b> and <b>Password</b> in <b>Authentication Setting</b> are correct. If the username is part of a domain, enter the username in one of the following styles: user@domain or domain\user.</li> <li>Make sure the SNTP time server settings are configured correctly so the time matches the time used for authentication by Kerberos or NTLmv2.</li> </ul>
Check User ID and Password.	The Kerberos Authentication error.	Make sure you have entered a correct user name and a password for the Kerberos server. For more information on the Kerberos server settings, contact your network administrator.
	The date, time and time zone settings of the Brother machine are not correct.	Confirm your machine's date, time and time zone settings.
	The DNS server configuration is not correct.	Contact your network administrator for the information on the DNS server settings.
	The Brother machine cannot connect to the Kerberos server.	Contact your network administrator for the information on the Kerberos server settings.
Connection Error	Other devices are trying to connect to the Wi-Fi Direct network at the same time.	Make sure there are no other devices trying to connect to the Wi-Fi Direct network, and then try to configure the Wi-Fi Direct settings again.
Connection Failed	The Brother machine and your mobile device cannot communicate during the Wi-Fi Direct network configuration.	<ul style="list-style-type: none"> <li>Move the mobile device closer to your Brother machine.</li> <li>Move your Brother machine and the mobile device to an obstruction-free area.</li> <li>If you are using the PIN Method of WPS, make sure you have entered the correct PIN.</li> </ul>
File access error, contact your administrator.	The Brother machine cannot access the destination folder for the Store Print Log to Network feature.	<ul style="list-style-type: none"> <li>Make sure the stored directory name is correct.</li> <li>Make sure the stored directory is write-enabled.</li> <li>Make sure the file is not locked.</li> </ul>
Log Access Error	In Web Based Management, you have selected the <b>Cancel Print</b> option in the <b>Error Detection Setting of Store Print Log to Network</b> .	Wait for about 60 seconds until this message disappears from the LCD.
No Device	When configuring the Wi-Fi Direct network, the Brother machine cannot find your mobile device.	<ul style="list-style-type: none"> <li>Make sure your machine and mobile device are in the Wi-Fi Direct mode.</li> <li>Move the mobile device closer to your Brother machine.</li> <li>Move your Brother machine and the mobile device to an obstruction-free area.</li> <li>If you are manually configuring the Wi-Fi Direct network, make sure you have entered the correct password.</li> <li>If your mobile device has a configuration page for how to obtain an IP address, make sure the IP address of your mobile device has been configured via DHCP.</li> </ul>

Error Messages	Cause	Action
Server timeout, contact your administrator.	The Brother machine cannot connect to the server for the Store Print Log to Network feature.	<ul style="list-style-type: none"> <li>• Make sure your server address is correct.</li> <li>• Make sure your server is connected to the network.</li> <li>• Make sure the machine is connected to the network.</li> </ul>
	The Brother machine cannot connect to the LDAP server.	<ul style="list-style-type: none"> <li>• Make sure your server address is correct.</li> <li>• Make sure your server is connected to the network.</li> <li>• Make sure the machine is connected to the network.</li> </ul>
	The Brother machine cannot connect to the Active Directory® server.	<ul style="list-style-type: none"> <li>• Make sure your server address is correct.</li> <li>• Make sure your server is connected to the network.</li> <li>• Make sure the machine is connected to the network.</li> </ul>
Wrong Date & Time, contact your administrator.	The Brother machine does not obtain the time from the SNTP time server.	<ul style="list-style-type: none"> <li>• Make sure the settings to access the SNTP time server are configured correctly in Web Based Management.</li> </ul>
Internal Error.	The Brother machine's LDAP protocol is disabled.	Confirm your authentication method, and then enable the necessary protocol setting in the Web Based Management.
	The Brother machine's CIFS protocol is disabled.	



## Related Information



- [Network Problems](#)

## Use the Network Connection Repair Tool (Windows®)

**Related Models:** HL-L5100DN/HL-L5200DW/HL-L5200DWT/HL-L6200DW/HL-L6200DWT/HL-L6300DW

Use the Network Connection Repair Tool to fix the Brother machine's network settings. It will assign the correct IP address and Subnet Mask.

- (Windows® XP/XP Professional x64 Edition/Windows Vista®/Windows® 7/Windows® 8)  
You must log on with Administrator rights.
  - Make sure the Brother machine is turned on and is connected to the same network as your computer.
1. Do one of the following:

Option	Description
Windows® XP	Click <b>Start &gt; All Programs &gt; Accessories &gt; Windows Explorer &gt; My Computer</b> .
Windows Server® 2003/2008	Click <b>Start &gt; All Programs &gt; Accessories &gt; Windows Explorer &gt; Computer</b> .
Windows Vista®/Windows® 7	Click  ( <b>Start</b> ) > <b>Computer</b> .
Windows® 8	Click the  ( <b>File Explorer</b> ) icon on the taskbar, and then click <b>Computer (This PC)</b> in the left navigation bar.
Windows Server® 2012 / 2012 R2	Click <b>Computer (This PC)</b> on the <b>Start</b> screen.

2. Double-click **XXX(C:)** (where XXX is the name of your local disk drive) > **Program Files > Brown02 > Brother > BrotherNetTool.exe**.



- For 64-bit OS users, double-click **XXX(C:)** (where XXX is the name of your local disk drive) > **Program Files (x86) > Brown02 > Brother > BrotherNetTool.exe**.
- If the **User Account Control** screen appears, do one of the following:
  - (Windows Vista®) Click **Allow**.
  - (Windows® 7/Windows® 8) Click **Yes**.

3. Follow the on-screen instructions.
4. Check the diagnosis by printing the Network Configuration Report.



The Network Connection Repair Tool will start automatically if you select the **Enable Connection Repair Tool** option in the Status Monitor. Right-click the Status Monitor screen, and then click **Other Settings > Enable Connection Repair Tool**. This is not recommended when your network administrator has set the IP address to Static, since it will automatically change the IP address.

If the correct IP address and the Subnet Mask are still not assigned even after using the Network Connection Repair Tool, ask your network administrator for this information.



### Related Information

- [Network Problems](#)
- [Print the Network Configuration Report](#)
- [My Brother Machine Cannot Print over the Network](#)

- 
- I Want to Check that My Network Devices are Working Correctly
-

## Where Can I Find My Brother Machine's Network Settings?

- [Print the Network Configuration Report](#)
- [Change Machine Settings from Your Computer](#)

## I Cannot Complete the Wireless Network Setup Configuration

**Related Models:** HL-L5200DW/HL-L5200DWT/HL-L6200DW/HL-L6200DWT/HL-L6300DW

Turn your wireless router off and back on. Then try to configure the wireless settings again. If you are unable to resolve the problem, follow the instructions below:

Investigate the problem using the WLAN Report.

Cause	Action	Interface
Your security settings (SSID/ Network Key) are not correct.	<ul style="list-style-type: none"> <li>• Confirm the security settings using the Wireless Setup Helper utility. For more information and to download the utility, go to your model's <b>Downloads</b> page on the Brother Solutions Center at <a href="http://support.brother.com">support.brother.com</a>.</li> <li>• Select and confirm that you are using the correct security settings.                             <ul style="list-style-type: none"> <li>- See the instructions supplied with your wireless LAN access point/router for information on how to find the security settings.</li> <li>- The manufacturer's name or model number of the wireless LAN access point/router may be used as the default security settings.</li> <li>- Consult with the access point/router manufacturer, your Internet provider, or network administrator.</li> </ul> </li> <li>• For definitions of SSID and Network Key, see the entries SSID, Network Key and Channels in the Glossary.</li> </ul>	Wireless
Your Brother machine's MAC address is not allowed.	Confirm that the Brother machine's MAC Address is allowed in the filter. You can find the MAC Address on your Brother machine's control panel.	Wireless
Your wireless LAN access point/router is in stealth mode (not broadcasting the SSID).	<ul style="list-style-type: none"> <li>• Enter the correct SSID name or Network Key manually.</li> <li>• Check the SSID name or the Network Key in the instructions supplied with your wireless LAN access point/router and reconfigure the wireless network setup.</li> </ul>	Wireless
Your security settings (SSID/ password) are not correct.	<ul style="list-style-type: none"> <li>• Confirm the SSID and password.                             <ul style="list-style-type: none"> <li>- When you are configuring the network manually, the SSID and password are displayed on your Brother machine. If your mobile device supports the manual configuration, the SSID and password will be displayed on your mobile device's screen.</li> </ul> </li> <li>• For the definition of SSID, see the Glossary.</li> </ul>	Wi-Fi Direct
You are using Android™ 4.0.	If your mobile device disconnects (approximately six minutes after using Wi-Fi Direct), try the one-push configuration using WPS (recommended) and set the Brother machine as a G/O.	Wi-Fi Direct
Your Brother machine is placed too far from your mobile device.	Move your Brother machine within about 3.3 feet (1 meter) of the mobile device when you configure the Wi-Fi Direct network settings.	Wi-Fi Direct
There are some obstructions (walls or furniture, for example) between your machine and the mobile device.	Move your Brother machine to an obstruction-free area.	Wi-Fi Direct
There is a wireless computer, Bluetooth-supported device, microwave oven, or digital	Move other devices away from the Brother machine or the mobile device.	Wi-Fi Direct

Cause	Action	Interface
cordless phone near the Brother machine or the mobile device.		
If you have checked and tried all of the above, but still cannot complete the Wi-Fi Direct configuration, do the following:	<ul style="list-style-type: none"> <li>• Turn your Brother machine off and back on. Then try to configure the Wi-Fi Direct settings again.</li> <li>• If you are using your Brother machine as a client, confirm how many devices are allowed in the current Wi-Fi Direct network, and then check how many devices are connected.</li> </ul>	Wi-Fi Direct

### For Windows®

If your wireless connection has been interrupted, and you have checked and tried all of the above, we recommend using the Network Connection Repair Tool.





### Related Information

- [Network Problems](#)
- [Configure Your Machine for a Wireless Network When the SSID Is Not Broadcast](#)
- [Use Wi-Fi Direct®](#)

## My Brother Machine Cannot Print over the Network

**Related Models:** HL-L5100DN/HL-L5200DW/HL-L5200DWT/HL-L6200DW/HL-L6200DWT/HL-L6300DW

Cause	Action	Interface
Your security software blocks your machine's access to the network.	Some security software might block access without showing a security alert dialog box even after successful installation. To allow access, see the instructions for your security software or ask the software manufacturer.	Wired/Wireless
Your Brother machine was not assigned an available IP address.	<ul style="list-style-type: none"> <li>• Confirm the IP address and the Subnet Mask. Verify that both the IP addresses and Subnet Masks of your computer and the Brother machine are correct and located on the same network. For more information about how to verify the IP address and the Subnet Mask, ask your network administrator.</li> <li>• (Windows®) Confirm the IP address and the Subnet Mask using the Network Connection Repair Tool.</li> </ul>	Wired/Wireless
The failed print job is still in your computer's print queue.	<ul style="list-style-type: none"> <li>• If the failed print job is still in your computer's print queue, delete it.</li> <li>• Otherwise, double-click the printer icon in the following folder and cancel all documents:                             <ul style="list-style-type: none"> <li>- (Windows® XP/Windows Server® 2003) Click <b>Start &gt; Printers and Faxes.</b></li> <li>- (Windows Vista®) Click  (<b>Start</b>) &gt; <b>Control Panel &gt; Hardware and Sound &gt; Printers.</b></li> <li>- (Windows® 7) Click  (<b>Start</b>) &gt; <b>Devices and Printers &gt; Printers and Faxes.</b></li> <li>- (Windows® 8) Move your mouse to the lower right corner of your desktop. When the menu bar appears, click <b>Settings &gt; Control Panel.</b> In the <b>Hardware and Sound</b> group, click <b>View devices and printers &gt; Printers.</b></li> <li>- (Windows Server® 2008) Click <b>Start &gt; Control Panel &gt; Printers.</b></li> <li>- (Windows Server® 2012) Move your mouse to the lower right corner of your desktop. When the menu bar appears, click <b>Settings &gt; Control Panel.</b> In the <b>Hardware</b> group, click <b>View devices and printers &gt; Printers.</b></li> <li>- (Windows Server® 2012 R2) Click <b>Control Panel</b> on the <b>Start</b> screen. In the <b>Hardware</b> group, click <b>View devices and printers.</b></li> <li>- (OS X v10.8.5) Click <b>System Preferences &gt; Print &amp; Scan.</b></li> <li>- (OS X v10.9.x, 10.10.x) Click <b>System Preferences &gt; Printers &amp; Scanners.</b></li> </ul> </li> </ul>	Wired/Wireless



---

Cause	Action	Interface
Your Brother machine is not connected to the wireless network.	Print the WLAN Report to check the error code on the printed report.	Wireless

If you have checked and tried all of the above, but your Brother machine still cannot print, uninstall the printer driver and reinstall it.



### Related Information

- [Network Problems](#)
  - [Print the WLAN Report](#)
  - [Wireless LAN Report Error Codes](#)
  - [Use the Network Connection Repair Tool \(Windows®\)](#)
  - [I Want to Check that My Network Devices are Working Correctly](#)
-

## I Want to Check that My Network Devices are Working Correctly

**Related Models:** HL-L5100DN/HL-L5200DW/HL-L5200DWT/HL-L6200DW/HL-L6200DWT/HL-L6300DW

Check	Action	Interface
Check that your Brother machine, access point/router, or network hub is turned on.	<p><b>Check the following:</b></p> <ul style="list-style-type: none"> <li>The power cord is connected correctly and the Brother machine is turned on.</li> <li>The access point/router or hub is turned on and its link button is blinking.</li> <li>All protective packaging has been removed from the machine.</li> <li>The toner cartridge and drum unit are installed correctly.</li> <li>The front and back covers are fully closed.</li> <li>Paper is inserted correctly in the paper tray.</li> <li>(For wired networks) A network cable is securely connected to the Brother machine and to the router or hub.</li> </ul>	Wired/Wireless
Check the <b>Link Status</b> in the Network Configuration Report.	Print the Network Configuration Report and check that <b>Ethernet Link Status</b> or <b>Wireless Link Status</b> is <b>Link OK</b> .	Wired/Wireless
Check that you can "ping" the Brother machine from your computer.	<p>Ping the Brother machine from your computer using the IP address or the node name in the Windows® command prompt or Macintosh Terminal application:</p> <p>ping &lt;ipaddress&gt; or &lt;nodename&gt;.</p> <ul style="list-style-type: none"> <li>Successful: Your Brother machine is working correctly and connected to the same network as your computer.</li> <li>Unsuccessful: Your Brother machine is not connected to the same network as your computer.</li> </ul> <p>(Windows®) Ask the network administrator and use the Network Connection Repair Tool to fix the IP address and the subnet mask.</p> <p>(Macintosh) Confirm that the IP address and the Subnet Mask are set correctly.</p>	Wired/Wireless
Check that your Brother machine is connected to the wireless network.	Print the WLAN Report to check the error code on the printed report.	Wireless





If you have checked and tried all of the above but you are still having problems, see the instructions supplied with your wireless LAN access point/router to find the SSID and the Network Key information and set them correctly.



### Related Information

- [Network Problems](#)
- [Print the Network Configuration Report](#)
- [Print the WLAN Report](#)
- [Wireless LAN Report Error Codes](#)
- [Use the Network Connection Repair Tool \(Windows®\)](#)
- [My Brother Machine Cannot Print over the Network](#)

## Other Problems

Difficulties	Suggestions
<p>The machine will not turn on.</p>	<p>Adverse conditions on the power connection (such as lightning or a power surge) may have triggered the machine's internal safety mechanisms. Unplug the power cord. Wait for ten minutes, then plug in the power cord and press  to turn on the machine.</p> <p>If the problem is not solved, press and hold  to turn off the machine. If you are using a backup battery or surge suppressor device, disconnect it to make sure it is not the problem. Plug the machine's power cord directly into a different known working wall outlet and press  to turn on the machine.</p>
<p>The machine cannot print EPS data that includes binary with the BR-Script3 printer driver.</p>	<p><b>(Windows®)</b></p> <p>To print EPS data, do the following:</p> <ol style="list-style-type: none"> <li>For Windows® 7 and Windows Server® 2008 R2: Click the  (<b>Start</b>) button &gt; <b>Devices and Printers</b>. For Windows Vista® and Windows Server® 2008: Click the  (<b>Start</b>) button &gt; <b>Control Panel</b> &gt; <b>Hardware and Sound</b> &gt; <b>Printers</b>. For Windows® XP and Windows Server® 2003: Click the <b>Start</b> button &gt; <b>Printers and Faxes</b>. For Windows® 8 and Windows Server® 2012: Move your mouse to the lower right corner of your desktop. When the menu bar appears, click <b>Settings</b> &gt; <b>Control Panel</b>. In the <b>Hardware and Sound</b><sup>1</sup> group, click <b>View devices and printers</b>. For Windows Server® 2012 R2: Click <b>Control Panel</b> on the <b>Start</b> screen. In the <b>Hardware</b> group, click <b>View devices and printers</b>.</li> <li>Right-click the <b>Brother XXX-XXXX BR-Script3</b> icon, select <b>Printer properties</b>.</li> <li>From the <b>Device Settings</b> tab, choose TBCP (Tagged binary communication protocol) in <b>Output Protocol</b>.</li> </ol> <p><b>(Macintosh)</b></p> <p>If your machine is connected to a computer with a USB interface, you cannot print EPS data that includes binary. You can print the EPS data at the machine through a network. For help installing the BR-Script3 printer driver through the network, go to the Brother Solutions Center at <a href="http://support.brother.com">support.brother.com</a>.</p>
<p>The Brother software cannot be installed.</p>	<p><b>(Windows®)</b></p> <p>If the Security Software warning appears on the computer screen during the installation, change the Security Software settings to permit the Brother product setup program or other program to run.</p> <p><b>(Macintosh)</b></p> <p>If you are using a firewall function of anti-spyware or antivirus security software, temporarily disable it and then install the Brother software.</p>



## Related Information

- [Troubleshooting](#)
-

## Check the Machine Information

Follow these instructions to check your Brother machine's serial number and firmware version.

>> [HL-L5000D/HL-L5100DN/HL-L5200DW/HL-L5200DWT/HL-L6200DW/HL-L6200DWT](#)

>> [HL-L6300DW](#)

### HL-L5000D/HL-L5100DN/HL-L5200DW/HL-L5200DWT/HL-L6200DW/HL-L6200DWT

1. Press ▲ or ▼ to select the [Machine Info.] option, and then press **OK**.
2. Press ▲ or ▼ to select one of the following options:

Option	Description
Print Settings	Print a list of your settings.
Print NetSetting (For network models)	Print a list of your Network settings.
Print WLANReport (For wireless models)	Print the wireless LAN connection results.
Print File List	Print a list of data saved in the memory.
Test Print	Print a test page.
Drum Dot Print	Print the Drum Dot Check Sheet.
Print Font	Print a list of the machine's internal fonts.
Serial No.	Check your machine's serial number.
Version	Check your machine's firmware version.
Page Count	Check the number of total pages the machine has printed.
Parts Life	Check the percentage of the supplies' life that remains available.

3. Press **OK**.

### HL-L6300DW

1. Press  [Settings] > [Machine Information].
2. Press one of the following options:

Option	Description
Print Settings	Print a list of your settings.
Print NetSetting (For network models)	Print a list of your Network settings.
Print WLANReport (For wireless models)	Print the wireless LAN connection results.
Print File List	Print a list of data saved in the memory.
Test Print	Print a test page.
Drum Dot Print	Print the Drum Dot Check Sheet.

---

Option	Description
Print Font	Print a list of the machine's internal fonts.
Serial No.	Check your machine's serial number.
Version	Check your machine's firmware version.
Page Count	Check the number of total pages the machine has printed.
Parts Life	Check the percentage of the supplies' life that remains available.

3. Press .

### Related Information

- [Troubleshooting](#)
-

## Reset Functions

- [Network Reset](#)
- [Factory Reset](#)

## Network Reset

**Related Models:** HL-L5100DN/HL-L5200DW/HL-L5200DWT/HL-L6200DW/HL-L6200DWT/HL-L6300DW

Use the Network Reset function to restore the print server's network settings, such as password and IP address, back to its default factory settings.

- Unplug all the interface cables before you perform a Network Reset.

>> [HL-L5100DN/HL-L5200DW/HL-L5200DWT/HL-L6200DW/HL-L6200DWT](#)

>> [HL-L6300DW](#)

### HL-L5100DN/HL-L5200DW/HL-L5200DWT/HL-L6200DW/HL-L6200DWT

1. Press ▲ or ▼ to select the [Reset Menu] option, and then press **OK**.
2. Press ▲ or ▼ to select the [Network] option, and then press **OK**.
3. Press ▲ to select [Yes].

The machine will restart automatically.

### HL-L6300DW

1. Press  [Settings] > [Reset Menu] > [Network].
2. Press the option in the table to reset the machine or to exit the process.

Option	Description
Yes	Reset the machine.
No	The machine will exit and cancel the reset menu.

3. You will be asked to reboot the machine. Press the option in the table to reboot the machine or to exit the process.

Option	Description
Press Yes for 2 seconds	Reboot the machine. The machine will begin the reset.
No	The machine will exit without rebooting.



If you do not reboot your machine, the reset process will not finish and your settings will remain unchanged.

4. Press .



You can also reset the Network settings by pressing  [Settings] > [Network] > [Network Reset].

### Related Information

- [Reset Functions](#)



## Factory Reset

Use the Factory Reset function to restore all settings back to the factory settings.

Unplug all the interface cables before you perform a Factory Reset.

>> [HL-L5000D/HL-L5100DN/HL-L5200DW/HL-L5200DWT/HL-L6200DW/HL-L6200DWT](#)  
>> [HL-L6300DW](#)

### HL-L5000D/HL-L5100DN/HL-L5200DW/HL-L5200DWT/HL-L6200DW/HL-L6200DWT

1. Press ▲ or ▼ to select the [Reset Menu] option, and then press **OK**.
2. Press ▲ or ▼ to select the [Factory Reset] option, and then press **OK**.
3. Press ▲ to select [Reset].

### HL-L6300DW

1. Press  [Settings] > [Reset Menu] > [Factory Reset].
2. Press the option in the table to reset the machine or to exit the process.

Option	Description
Yes	Reset the machine.
No	The machine will exit and cancel the reset menu.

3. You will be asked to reboot the machine. Press the option in the table to reboot the machine or to exit the process.

Option	Description
Press Yes for 2 seconds	Reboot the machine. The machine will begin the reset.
No	The machine will exit without rebooting.



If you do not reboot your machine, the reset process will not finish and your settings will remain unchanged.

4. Press .

### ✓ Related Information

- [Reset Functions](#)

## **Routine Maintenance**

- [Replace Supplies](#)
- [Clean the Machine](#)
- [Check the Remaining Life of Parts](#)
- [Pack and Ship Your Machine](#)

## Replace Supplies

You must replace supplies when the machine indicates that the life of the supply is over.

Using non-Brother supplies may affect the print quality, hardware performance, and machine reliability.



- The toner cartridge and drum unit are two separate supplies. Make sure both are installed as an assembly.
- The order number of supplies may vary depending on the country.

This table lists the messages to replace supplies when they reach their end of life. To avoid any inconvenience, you may want to buy spare supplies to keep as replacements before the machine stops printing.

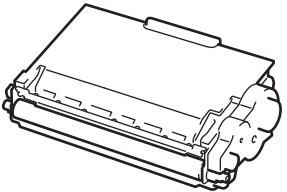
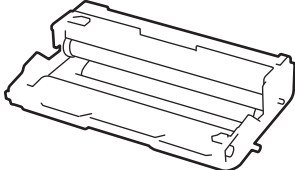
Indication	Supply	Order No.	Approximate Life (page yield)
Toner Low Replace Toner	Toner cartridge 	TN-820 <sup>1</sup> TN-850 <sup>2</sup> TN-880 <sup>3</sup>	Approximately 3,000 pages <sup>1 4 5</sup> Approximately 8,000 pages <sup>2 4 5</sup> Approximately 12,000 pages <sup>3 4 5</sup>
Drum ! Drum End Soon Replace Drum	Drum unit 	DR-820	Approximately 30,000 pages <sup>6</sup>

<sup>1</sup> Standard toner cartridge

<sup>2</sup> High yield toner cartridge

<sup>3</sup> Super high yield toner cartridge(Available only for certain models)

<sup>4</sup> Letter or A4 size 1-sided pages.

<sup>5</sup> Approximate cartridge yield is declared in accordance with ISO/IEC 19752.

<sup>6</sup> Approximately 30,000 pages based on 1 page per job and 50,000 pages based on 3 pages per job [A4/letter simplex pages]. The number of pages may be affected due to a variety of factors including but not limited to media type and media size.

### NOTE

- Be sure to seal up the used supplies tightly in a bag so that toner powder does not spill out of the cartridge.
- Visit <http://www.brother.com/original/index.html> for instructions on how to return your used supplies to the Brother collection program. If you choose not to return your used supply, discard the used supply according to local regulations, keeping it separate from domestic waste. If you have questions, contact your local waste disposal office.
- We recommend placing used supplies on a piece of paper to prevent accidentally spilling or scattering the material inside.
- If you use paper that is not a direct equivalent for the recommended print media, the life of supplies and machine parts may be reduced.
- The projected life for each of the toner cartridges is based on ISO/IEC 19752. Frequency of replacement will vary depending on the print volume, percentage of coverage, types of media used, and powering on/off the machine.
- Frequency of replacing supplies except toner cartridges will vary depending on the print volume, types of media used, and powering on/off the machine.

- 
- Handle the toner cartridge carefully. If toner scatters on your hands or clothes, immediately wipe or wash it off with cold water.
  - To avoid print quality problems, DO NOT touch the shaded parts shown in the illustrations.

**Toner cartridge**

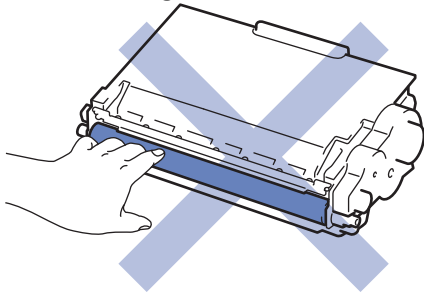

**Drum unit**

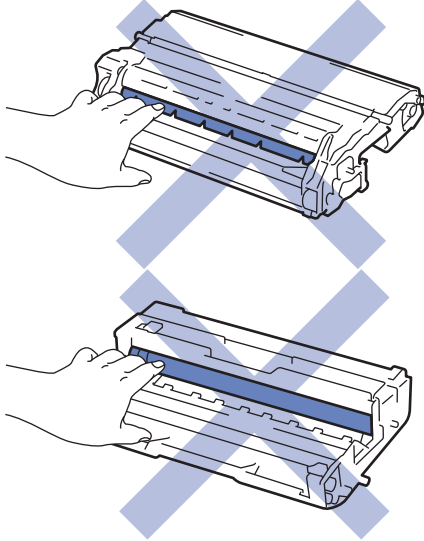

**Related Information**

- [Routine Maintenance](#)
  - [Replace the Toner Cartridge](#)
  - [Replace the Drum Unit](#)
  - [Reset the Drum Counter](#)
  - [Error and Maintenance Messages](#)
  - [Supplies](#)
-

## Replace the Toner Cartridge

1. Make sure the machine is turned on.
2. Open the front cover.

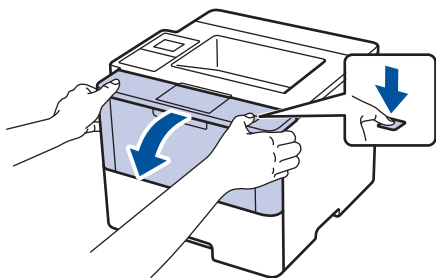

3. Remove the toner cartridge and drum unit assembly from the machine.

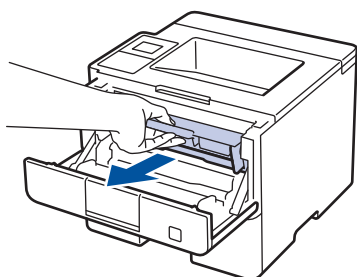

4. Push down the green lock lever and take the toner cartridge out of the drum unit.

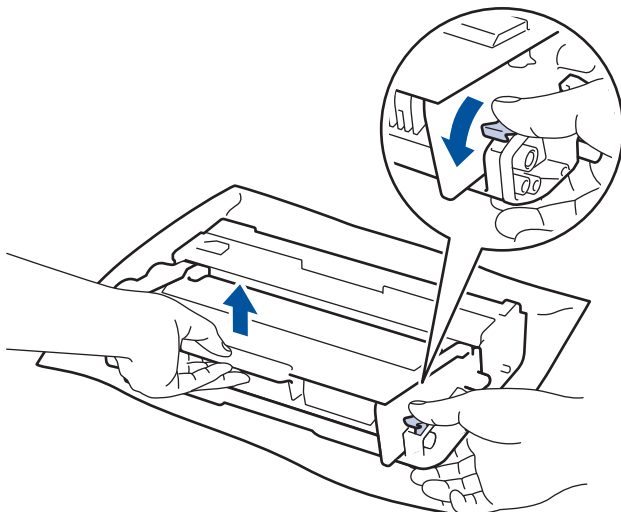

5. Unpack the new toner cartridge.
6. Remove the protective cover.

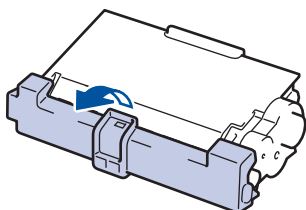

7. Put the new toner cartridge firmly into the drum unit until you hear it lock into place.

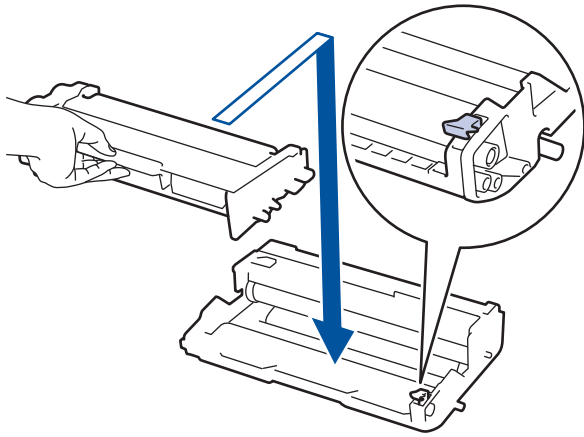

---

 Make sure you put the toner cartridge in correctly or it may separate from the drum unit.

---

8. Clean the corona wire inside the drum unit by gently sliding the green tab from left to right and right to left several times.

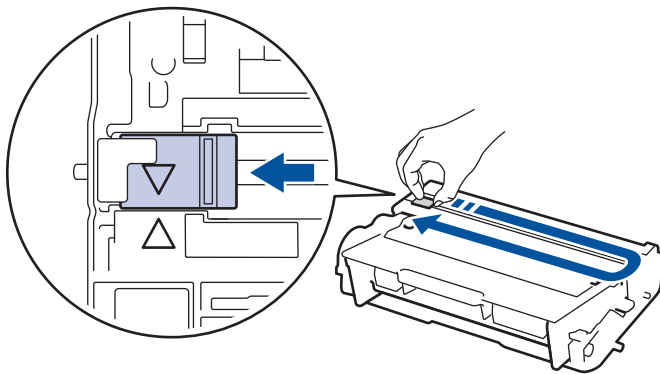

---

 Be sure to return the tab to the Home position (▲). The arrow on the tab must be aligned with the arrow on the drum unit. If it is not, printed pages may have a vertical stripe.

---

9. Install the toner cartridge and drum unit assembly back into the machine.

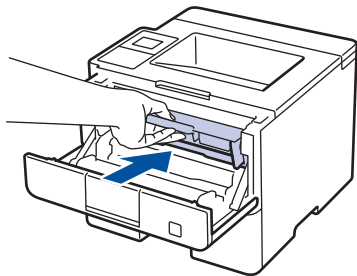

10. Close the front cover of the machine.

---

 Do not turn off the machine or open the front cover until the machine returns to Ready Mode.

- The toner cartridge that comes with your Brother machine is a Starter toner cartridge.
- It is a good idea to keep a new toner cartridge ready for use when you see the Toner Low warning.
- To ensure high quality printing, we recommend using only Genuine Brother Brand toner cartridges. When you want to buy toner cartridges, contact Brother Customer Service.
- DO NOT unpack the new toner cartridge until you are ready to install it.
- If a toner cartridge is left unpacked for a long time, the toner life will be shortened.
- Brother strongly recommends you DO NOT refill the toner cartridge provided with your machine. We also strongly recommend you continue to use only Genuine Brother Brand replacement toner cartridges. Use or attempted use of third party toner and/or cartridges in the Brother machine may cause damage to the machine and/or may result in unsatisfactory print quality. Our limited warranty coverage does not apply to any problem that is caused by the use of third party toner and/or cartridges. To protect your investment and obtain premium performance from the Brother machine, we strongly recommend the use of Genuine Brother Supplies.

---



## Related Information

- [Replace Supplies](#)

## Replace the Drum Unit

1. Make sure the machine is turned on.
2. Open the front cover.

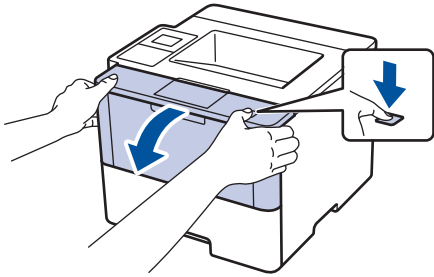

3. Remove the toner cartridge and drum unit assembly from the machine.

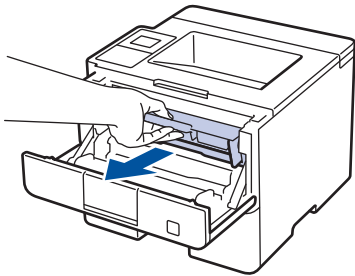

4. Push down the green lock lever and take the toner cartridge out of the drum unit.

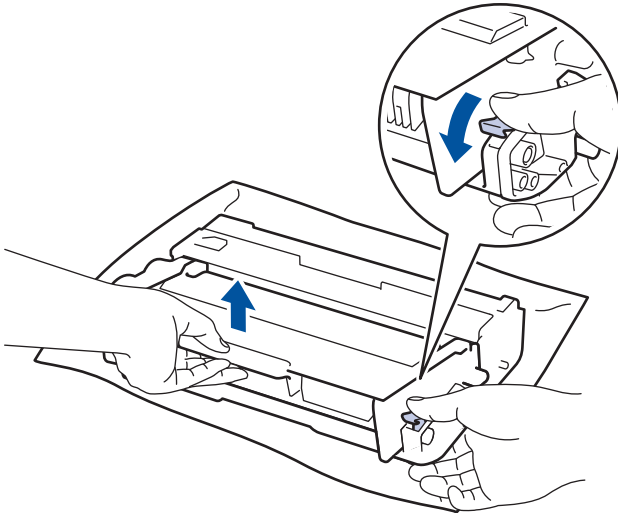

5. Unpack the new drum unit.
6. Put the toner cartridge firmly into the new drum unit until you hear it lock into place.

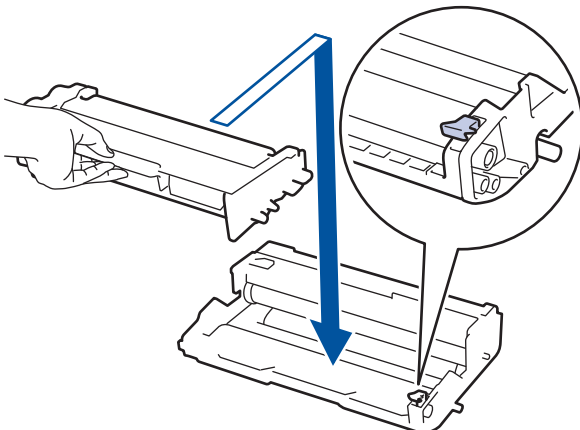

Make sure you put the toner cartridge in correctly or it may separate from the drum unit.



7. Clean the corona wire inside the drum unit by gently sliding the green tab from left to right and right to left several times.

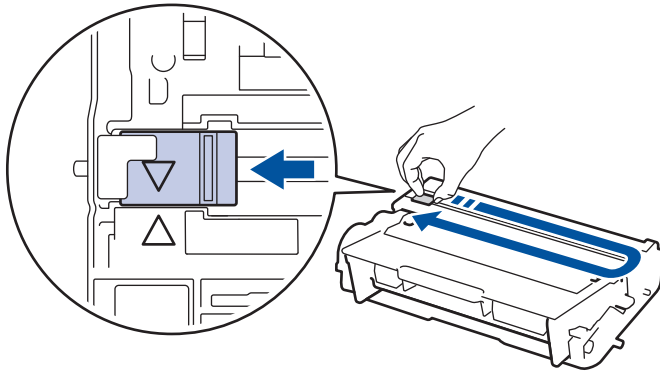

Be sure to return the tab to the Home position (▲). The arrow on the tab must be aligned with the arrow on the drum unit. If it is not, printed pages may have a vertical stripe.

8. Install the toner cartridge and drum unit assembly back into the machine.

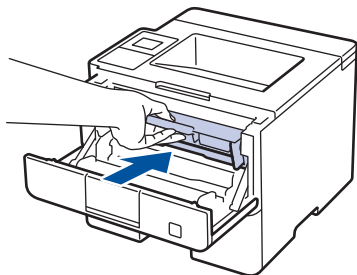

9. Close the front cover of the machine.



After installing the new drum unit, you must reset the drum counter. See *Related Information: Reset the Drum Counter*.

## NOTE

- Drum wear and tear occurs due to use and rotation of the drum and interaction with paper, toner and other materials in the paper path. In designing this product, Brother decided to use the number of rotations of the drum as a reasonable determinant of the drum life. When a drum reaches the factory-established rotation limit corresponding to the rated page yield, the product's LCD will advise you to replace the drum. The product will continue to function; however, print quality may not be optimal.
- If an unpacked drum unit is placed in direct sunlight (or room light for long periods of time), the unit may be damaged.
- There are many factors that determine the actual drum life, such as the temperature, humidity, type of paper, type of toner used and so on. Under ideal conditions, the average drum life is estimated at approximately 30,000 pages based on 1 page per job and 50,000 pages based on 3 pages per job [A4/letter simplex pages]. The number of pages may be affected due to a variety of factors including but not limited to media type and media size.

Because we have no control over the many factors that determine the actual drum life, we cannot guarantee a minimum number of pages that will be printed by your drum.

- For best performance, use only genuine Brother toner.
- The machine should be used only in a clean, dust-free environment with adequate ventilation.

Printing with a non-Brother drum unit may reduce not only the print quality but also the quality and life of the machine itself. Warranty coverage does not apply to problems caused by the use of a non-Brother drum unit.



## Related Information

- [Replace Supplies](#)

- 
- Error and Maintenance Messages
  - Reset the Drum Counter
-

## Reset the Drum Counter

When you replace the drum unit with a new one, you must reset the drum counter by completing the following steps:

### IMPORTANT

DO NOT reset the drum counter unless you are replacing the drum unit.

>> [HL-L5000D/HL-L5100DN/HL-L5200DW/HL-L5200DWT/HL-L6200DW/HL-L6200DWT](#)

>> [HL-L6300DW](#)

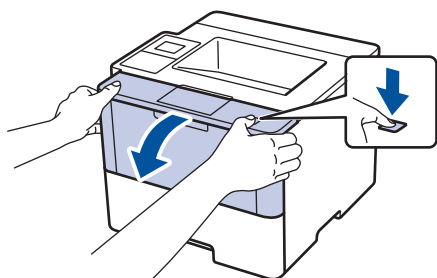

### HL-L5000D/HL-L5100DN/HL-L5200DW/HL-L5200DWT/HL-L6200DW/HL-L6200DWT

1. Make sure the machine is turned on.
2. Open the front cover.



3. Press and hold **OK** for about two seconds to display the [Drum Unit] option, and then press **OK**.
4. Press **▲** for [Reset] to reset the drum counter.
5. Close the front cover of the machine.

### HL-L6300DW

1. Make sure the machine is turned on.
2. Press  [Settings] > [Machine Information] > [Parts Life].
3. Press and hold [Drum Life].
4. Press [Yes].
5. Press .

### ✓ Related Information

- [Replace Supplies](#)
- [Replace the Drum Unit](#)

## Clean the Machine

Clean the outside and inside of the machine regularly with a dry, lint-free cloth.

When you replace the toner cartridge or the drum unit, make sure you clean the inside of the machine. If printed pages are stained with toner, clean the inside of the machine with a dry, lint-free cloth.

### WARNING

- DO NOT use flammable substances, any type of spray, or an organic solvent/liquid containing alcohol or ammonia to clean the inside or outside of the product. Doing so could cause a fire. Instead, use only a dry, lint-free cloth.



### IMPORTANT

- DO NOT use isopropyl alcohol to remove dirt from the control panel. It may crack the panel.
- To avoid print quality problems, DO NOT touch the shaded parts shown in the illustrations.

#### Toner cartridge

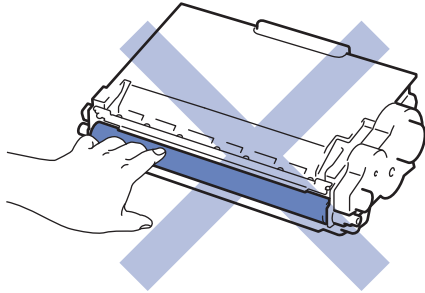

#### Drum unit

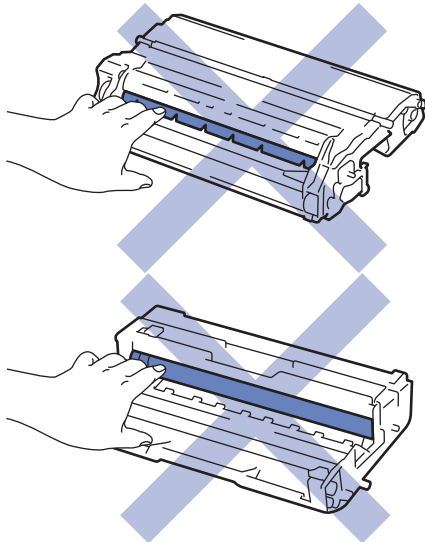

### Related Information

- [Routine Maintenance](#)
- [Clean the Touchscreen LCD](#)
- [Clean the Corona Wire](#)

- 
- Clean the Drum Unit
  - Clean the Paper Pick-up Rollers
-

## Clean the Touchscreen LCD

Related Models: HL-L6300DW

### IMPORTANT

DO NOT use any type of liquid cleaners (including ethanol).

1. Press and hold  to turn off the machine.
2. Clean the Touchscreen with a dry, soft lint-free cloth.

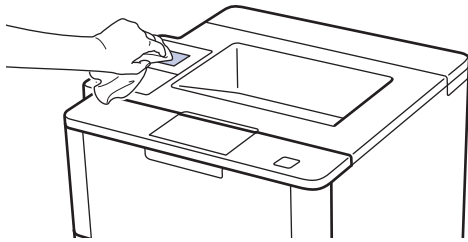

3. Press  to turn on the machine.



### Related Information

- [Clean the Machine](#)

## Clean the Corona Wire

If you have print quality problems or the control panel displays [Drum !] status, clean the corona wire.

1. Open the front cover.

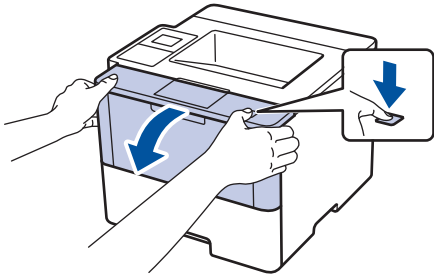

2. Remove the toner cartridge and drum unit assembly from the machine.

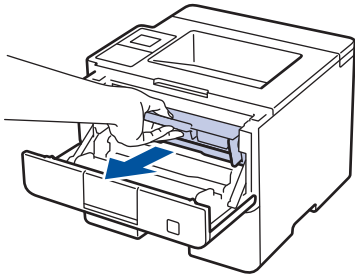

3. Clean the corona wire inside the drum unit by gently sliding the green tab from left to right and right to left several times.

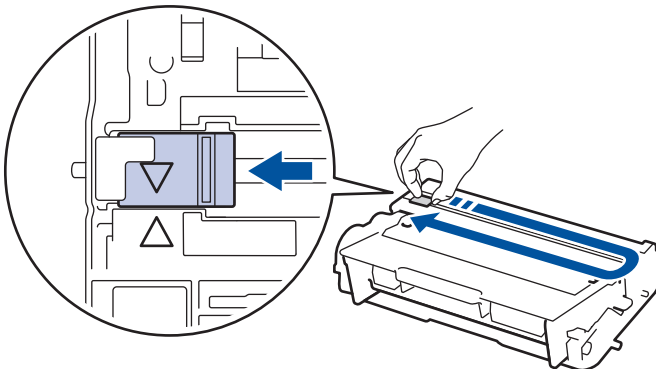

Be sure to return the tab to the Home position (▲). The arrow on the tab must be aligned with the arrow on the drum unit. If it is not, printed pages may have a vertical stripe.

4. Install the toner cartridge and drum unit assembly back into the machine.

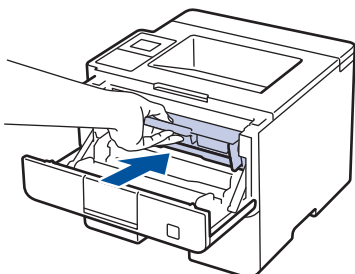

5. Close the front cover of the machine.



### Related Information

- [Clean the Machine](#)
- [Error and Maintenance Messages](#)

## Clean the Drum Unit

If your printout has dots or other repeating marks at 3.7 in. (94 mm) intervals, the drum may have foreign material, such as glue from a label, stuck on the drum surface.

>> HL-L5000D/HL-L5100DN/HL-L5200DW/HL-L5200DWT/HL-L6200DW/HL-L6200DWT

>> HL-L6300DW

### HL-L5000D/HL-L5100DN/HL-L5200DW/HL-L5200DWT/HL-L6200DW/HL-L6200DWT

1. Make sure the machine is in Ready Mode.
2. Press ▲ or ▼ to display the [Machine Info.] option, and then press **OK**.
3. Press ▲ or ▼ to select the [Drum Dot Print] option.
4. Press **OK**.  
The machine prints the Drum Dot Check Sheet.
5. Press and hold  to turn off the machine.
6. Open the front cover.

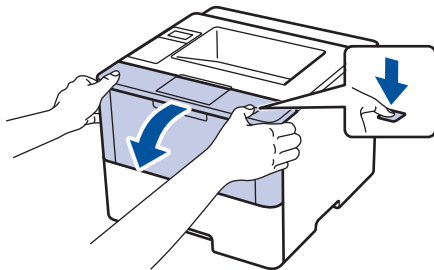

7. Remove the toner cartridge and drum unit assembly from the machine.

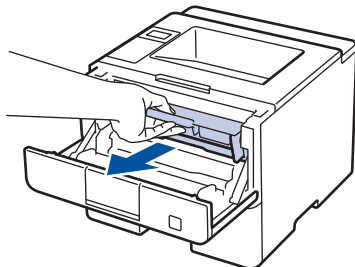

8. Push down the green lock lever and take the toner cartridge out of the drum unit.

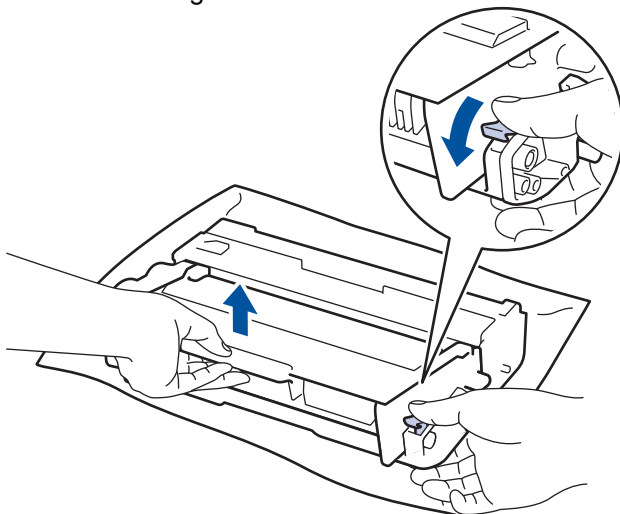

9. Turn the drum unit as shown in the illustration. Make sure that the drum unit gear is on the left side.



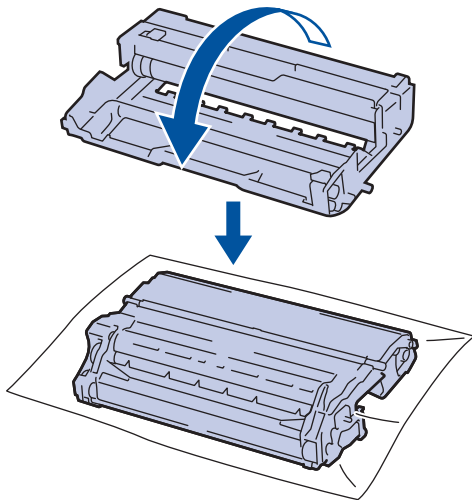

10. Use the numbered markers next to the drum roller to find the mark on the drum. For example, a dot in column 2 on the check sheet means that there is a mark in drum region "2".

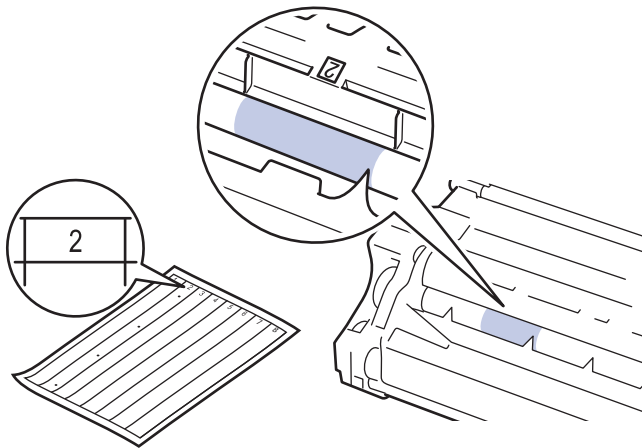

11. Turn the edge of the drum unit toward you while looking at the drum surface to find the mark.

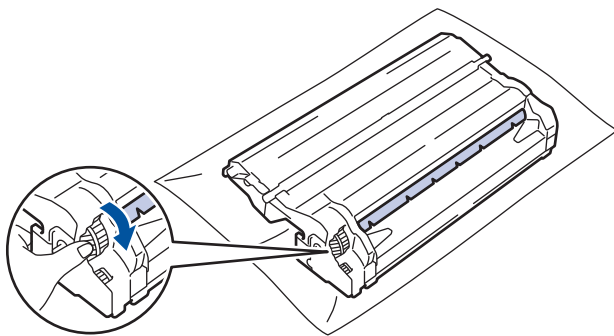

- To avoid print quality problems, **DO NOT** touch the surface of the drum unit, only the edge.
- You can turn the drum unit gear more easily by pulling down the black levers. When you have finished turning the gear, push the levers back to the original position.

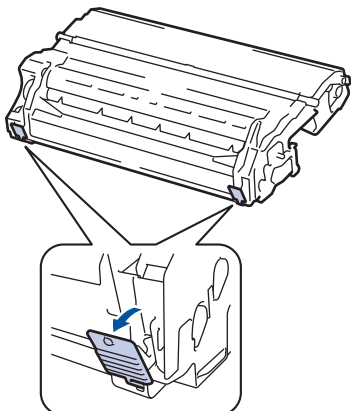

12. Wipe the surface of the drum gently with a dry cotton swab until the mark on the surface comes off.

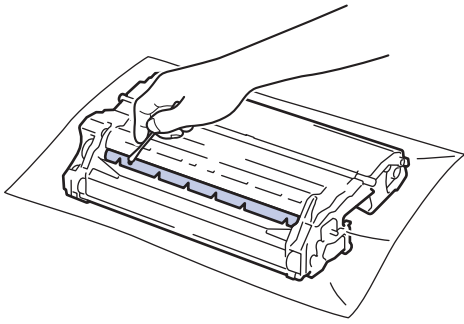

## NOTE

DO NOT clean the surface of the photosensitive drum with a sharp object or any liquids.

13. Put the toner cartridge firmly into the drum unit until you hear it lock into place.

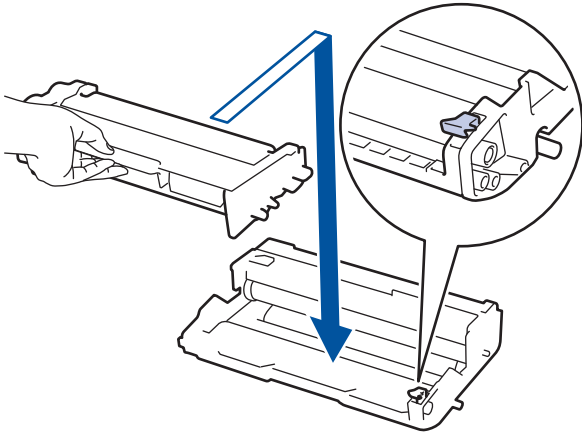

Make sure you put the toner cartridge in correctly or it may separate from the drum unit.

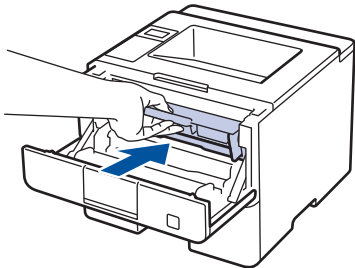

14. Install the toner cartridge and drum unit assembly back into the machine.



15. Close the front cover of the machine.

16. Press  to turn on the machine.

## HL-L6300DW

1. Make sure the machine is in Ready Mode.
2. Press  [Settings] > [Machine Information] > [Drum Dot Print].
3. Press [OK].  
The machine prints the Drum Dot Check Sheet.
4. Press and hold  to turn off the machine.
5. Open the front cover.

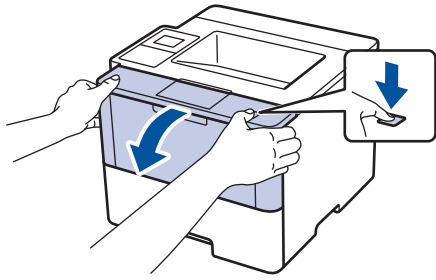

6. Remove the toner cartridge and drum unit assembly from the machine.

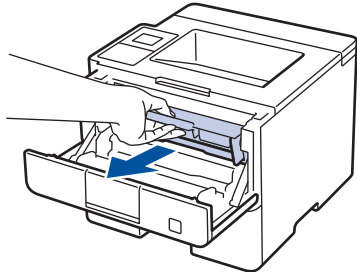

7. Push down the green lock lever and take the toner cartridge out of the drum unit.

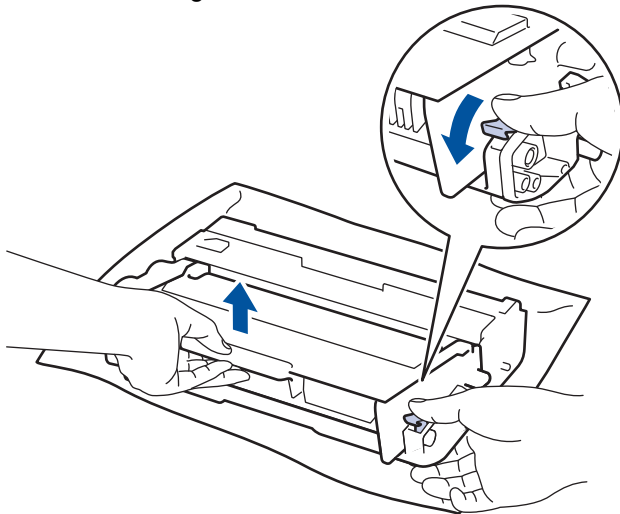

8. Turn the drum unit as shown in the illustration. Make sure that the drum unit gear is on the left side.

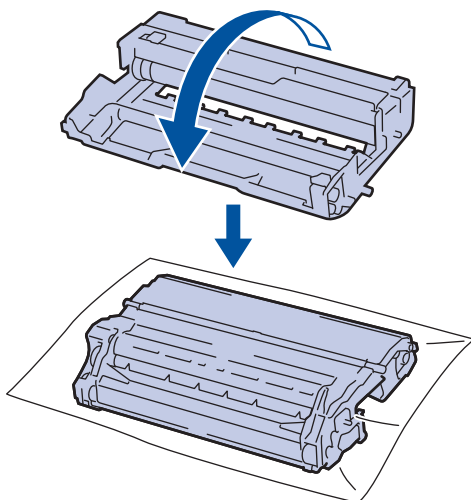

9. Use the numbered markers next to the drum roller to find the mark on the drum. For example, a dot in column 2 on the check sheet means that there is a mark in drum region "2".

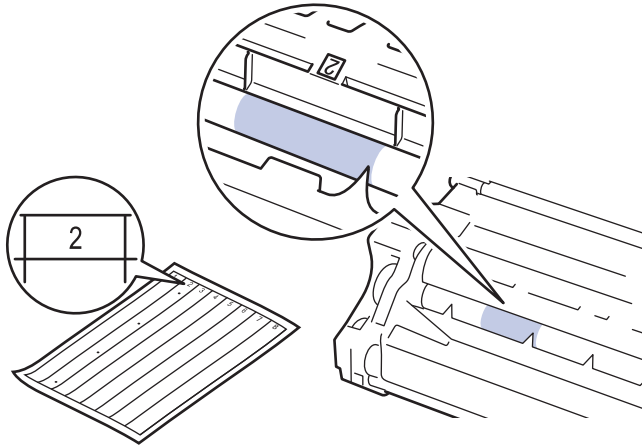

10. Turn the edge of the drum unit toward you while looking at the drum surface to find the mark.

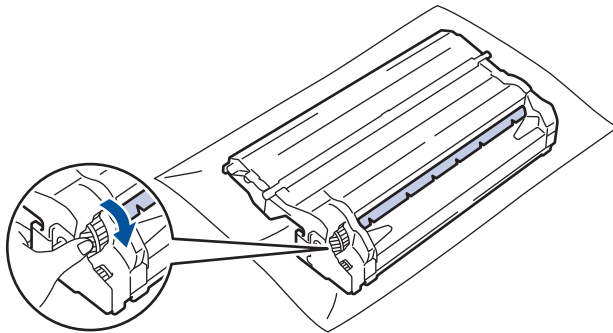

- To avoid print quality problems, **DO NOT** touch the surface of the drum unit, only the edge.
- You can turn the drum unit gear more easily by pulling down the black levers. When you have finished turning the gear, push the levers back to the original position.

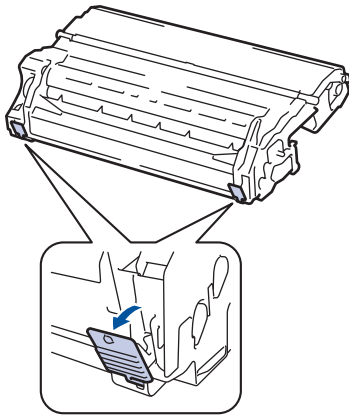

11. Wipe the surface of the drum gently with a dry cotton swab until the mark on the surface comes off.

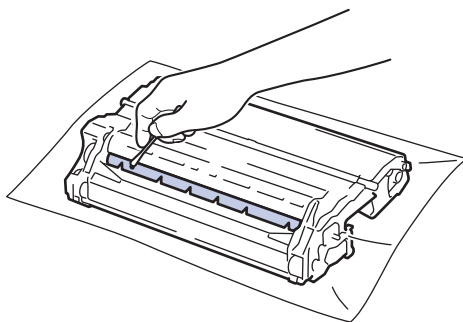

## NOTE

**DO NOT** clean the surface of the photosensitive drum with a sharp object or any liquids.

12. Put the toner cartridge firmly into the drum unit until you hear it lock into place.

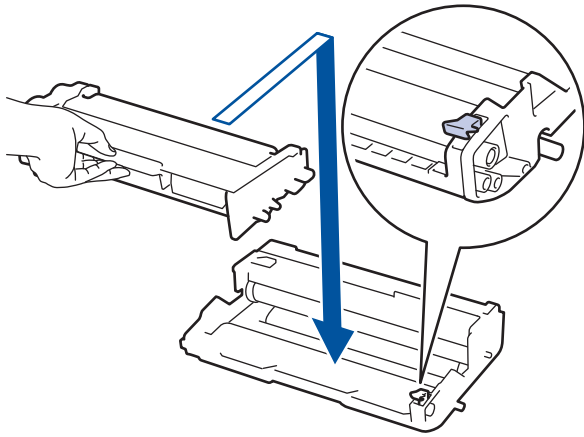

 **Make sure you put the toner cartridge in correctly or it may separate from the drum unit.**

13. Install the toner cartridge and drum unit assembly back into the machine.

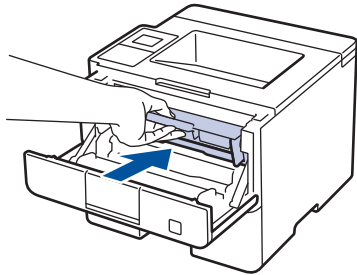

14. Close the front cover of the machine.

15. Press  to turn on the machine.

### **Related Information**

- [Clean the Machine](#)
- [Improve the Print Quality](#)

## Clean the Paper Pick-up Rollers

Cleaning the paper pick-up rollers periodically may prevent paper jams by ensuring that paper feeds properly.

If you have paper feed problems, clean the pick-up rollers as follows:

1. Press and hold  to turn off the machine.
2. Pull the paper tray completely out of the machine.

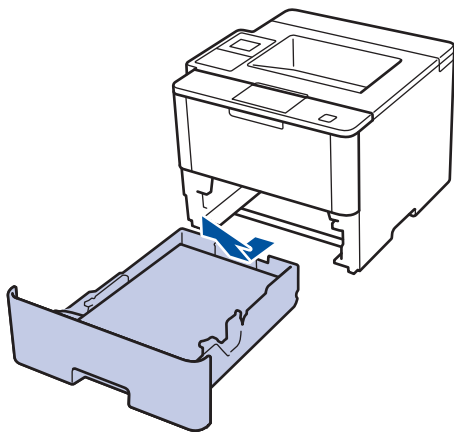

3. If paper is loaded or something is stuck inside in the paper tray, remove it.
4. Tightly wring out a lint-free cloth soaked in lukewarm water, and then wipe the separator pad on the paper tray to remove dust.

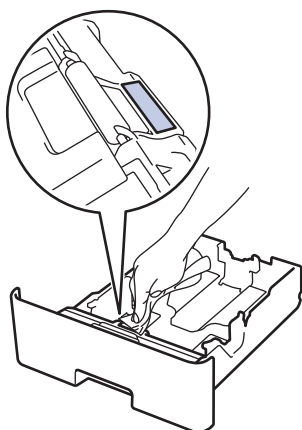

5. Wipe the two pick-up rollers inside the machine to remove dust.

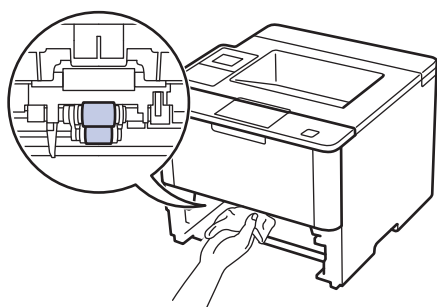

6. Reload the paper and put the paper tray firmly back in the machine.
7. Press  to turn on the machine.

### Related Information

- [Clean the Machine](#)
- [Printing Problems](#)

## Check the Remaining Life of Parts



>> [HL-L5000D/HL-L5100DN/HL-L5200DW/HL-L5200DWT/HL-L6200DW/HL-L6200DWT](#)

>> [HL-L6300DW](#)

### HL-L5000D/HL-L5100DN/HL-L5200DW/HL-L5200DWT/HL-L6200DW/HL-L6200DWT

1. Press ▲ or ▼ to display the [Machine Info.] option, and then press **OK**.
2. Press ▲ or ▼ to select the [Parts Life] option, and then press **OK**.
3. Press ▲ or ▼ to select the machine part you want to check, and then press **OK**.  
The LCD displays the approximate remaining part life.

### HL-L6300DW

1. Press  [Settings] > [Machine Information] > [Parts Life].
2. Press ▲ or ▼ to display the machine parts, and then press the machine part you want to check.  
The LCD displays the approximate remaining part life.
3. Press .

### Related Information

- [Routine Maintenance](#)

## Pack and Ship Your Machine

There are two ways to pack and ship your machine. To determine which you should follow, check the machine's original packing material for a toner pad.

- If there is NO toner pad in the original carton, see *Related Information: Pack the Machine and the Toner Cartridge Together*.
- If there is a toner pad in the original carton, see *Related Information: Pack the Machine and the Toner Cartridge Separately*.

### Toner Pad

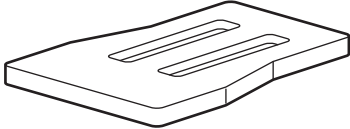

### ✓ Related Information

- [Routine Maintenance](#)
- [Pack the Machine and the Toner Cartridge Together](#)
- [Pack the Machine and the Toner Cartridge Separately](#)



## Pack the Machine and the Toner Cartridge Together

### WARNING

- When you move the machine, carry the machine as shown in the illustration below.

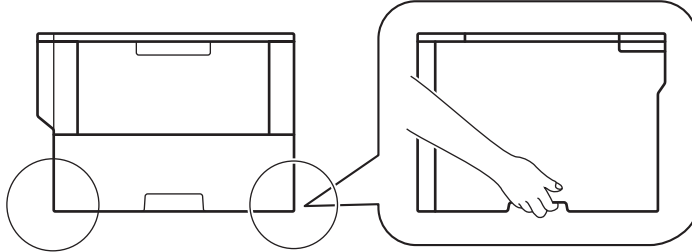

- If the machine has the Optional Tray(s) installed, remove the Optional Tray(s) BEFORE moving the machine. Attempting to move the machine without removing the Optional Tray(s) may cause injury to you or damage to the machine.
- Pack the Optional Tray(s) separately in its original carton with original packing material.



- If for any reason you must ship your machine, carefully repack the machine in the original packaging to avoid any damage during transit. The machine should be adequately insured with the carrier.

- Press and hold  to turn off the machine. Leave the machine off for at least 10 minutes to cool down.
- Disconnect all the cables, and then unplug the power cord from the AC power outlet.



The machine is equipped with a non-detachable AC power cord depending on the model.

- Put the machine into the bag it originally came in.
- Pack the machine, the printed materials, and the AC power cord (if applicable) in the original carton with the original packing material as shown. If you are returning your machine to Brother as part of the Exchange Service, pack only the machine. Keep all separate parts and printed materials to use with your "Exchange" machine.

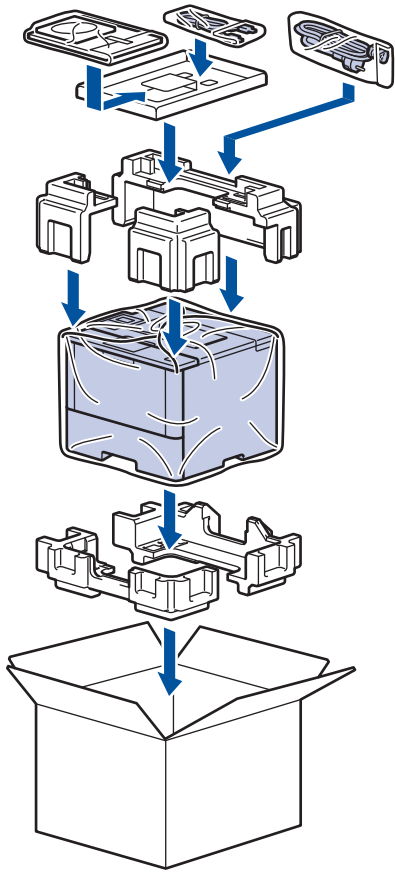

5. Close the carton and tape it shut.
6. If you have a Lower Tray, repack it as shown.

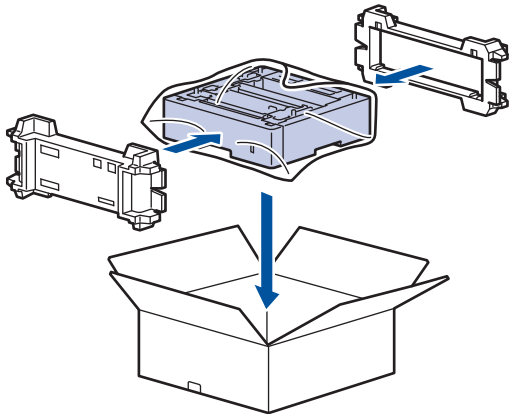

### Related Information

- [Pack and Ship Your Machine](#)

## Pack the Machine and the Toner Cartridge Separately

### WARNING

- When you move the machine, carry the machine as shown in the illustration below.

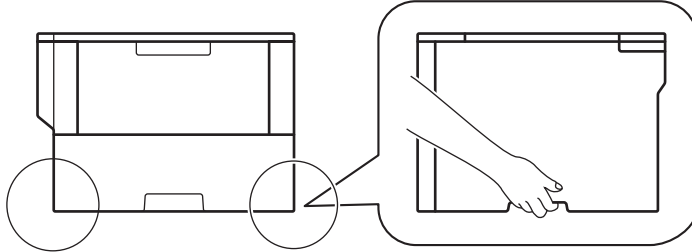

- If the machine has the Optional Tray(s) installed, remove the Optional Tray(s) BEFORE moving the machine. Attempting to move the machine without removing the Optional Tray(s) may cause injury to you or damage to the machine.
- Pack the Optional Tray(s) separately in its original carton with original packing material.



- If for any reason you must ship your machine, carefully repack the machine in the original packaging to avoid any damage during transit. The machine should be adequately insured with the carrier.

- Press and hold  to turn off the machine. Leave the machine off for at least 10 minutes to cool down.
- Disconnect all the cables, and then unplug the power cord from the AC power outlet.



The machine is equipped with a non-detachable AC power cord depending on the model.

- Remove the toner cartridge and drum unit assembly.

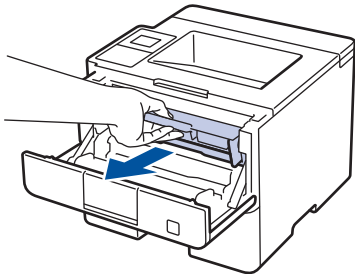

- Push down the green lock lever and take the toner cartridge out of the drum unit.

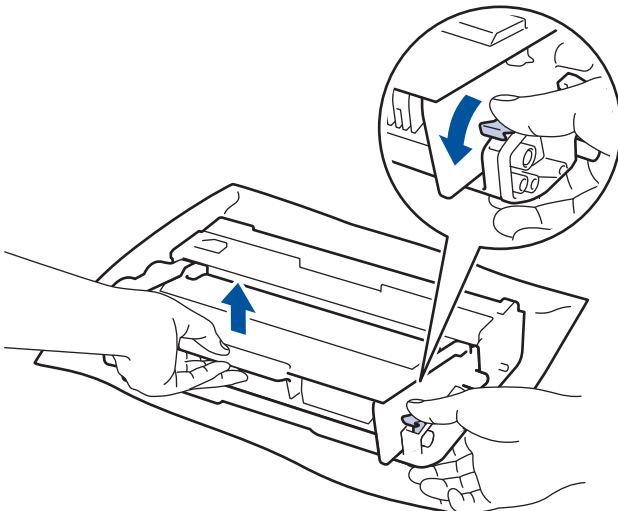

- Put the protective material on the toner cartridge. Put it in a plastic bag.

6. Install only the drum unit back into the machine.

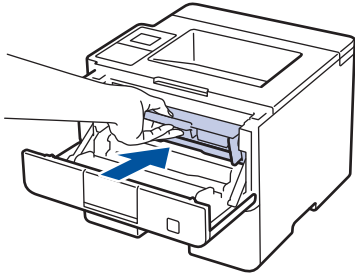

7. Close the front cover.
8. Put the machine into the bag it originally came in.
9. Pack the machine, the printed materials, and the AC power cord (if applicable) in the original carton with the original packing material as shown. If you are returning your machine to Brother as part of the Exchange Service, pack only the machine. Keep all separate parts and printed materials to use with your "Exchange" machine.

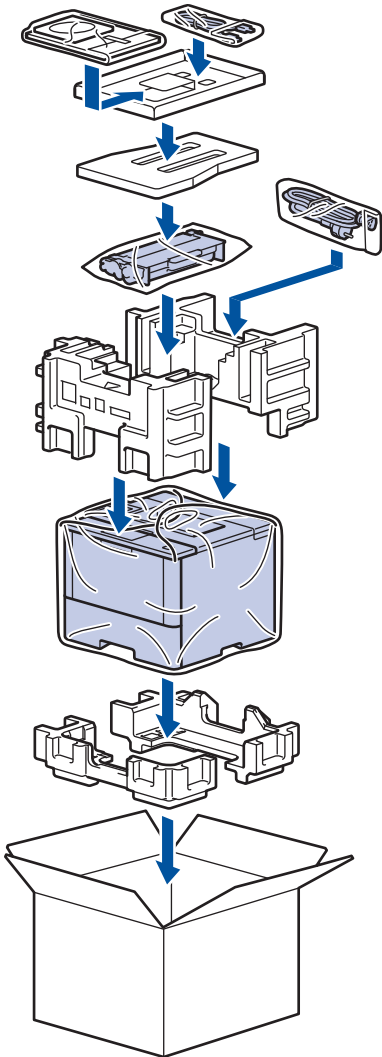

10. Close the carton and tape it shut.
11. If you have a Lower Tray, repack it as shown.

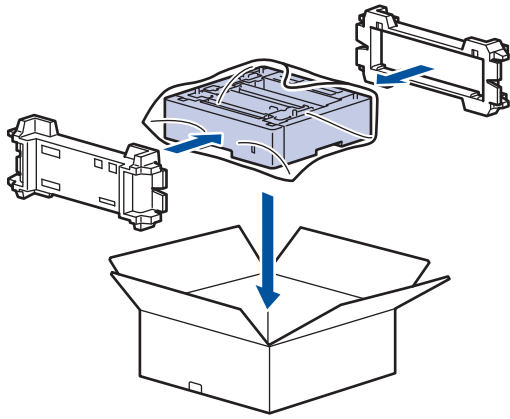

### Related Information

- [Pack and Ship Your Machine](#)
-

## Machine Settings

Customize settings and features, create shortcuts, and work with options displayed on the machine's LCD to make your Brother machine a more efficient work tool.

- [Change Machine Settings from the Control Panel](#)
- [Change Machine Settings from Your Computer](#)

## Change Machine Settings from the Control Panel

- [General Settings](#)
- [Settings and Features Tables](#)





## General Settings

- [Adjust the Machine's Volume](#)
- [Set Sleep Mode Countdown](#)
- [About Deep Sleep Mode](#)
- [Set Auto Power Off Mode](#)
- [Adjust the LCD Backlight Brightness](#)
- [Change How Long the LCD Backlight Stays On](#)
- [Reduce Toner Consumption](#)
- [Reduce Printing Noise](#)
- [Change the Language on the LCD](#)



## Adjust the Machine's Volume

Related Models: HL-L6300DW

1. Press  [Settings] > [General Setup] > [Volume] > [Beep].
2. Press  or  to display the [Off], [Low], [Med] or [High] option, and then press the option you want.
3. Press .



### Related Information

- [General Settings](#)

## Set Sleep Mode Countdown

The Sleep Mode (or Power Save Mode) setting can reduce power consumption. Select how long the machine must be idle before it goes into Sleep Mode. The Sleep Mode timer is reset when the machine receives a print job.



When the machine is in Sleep Mode, it acts as if it is turned off. The machine will wake up and start printing when it receives a print job. Use these instructions to set a time delay (countdown) before the machine enters Sleep Mode.

>> [HL-L5000D/HL-L5100DN/HL-L5200DW/HL-L5200DWT/HL-L6200DW/HL-L6200DWT](#)  
>> [HL-L6300DW](#)

### HL-L5000D/HL-L5100DN/HL-L5200DW/HL-L5200DWT/HL-L6200DW/HL-L6200DWT

1. Press **▲** or **▼** to select the [General Setup] option, and then press **OK**.
2. Press **▲** or **▼** to select the [Ecology] option, and then press **OK**.
3. Press **▲** or **▼** to select the [Sleep Time] option, and then press **OK**.
4. Press **▲** or **▼** to enter the length of time, in minutes, that the machine should remain idle before entering Sleep Mode.  
Press **Go**.

### HL-L6300DW

1. Press  [Settings] > [General Setup] > [Ecology] > [Sleep Time].
2. Enter the length of time (maximum 50 minutes) the machine will remain idle before entering Sleep Mode, and then press [OK].
3. Press .



### Related Information

- [General Settings](#)

## About Deep Sleep Mode

If the machine is in Sleep Mode and does not receive any jobs for certain length of time, the machine will automatically enter Deep Sleep Mode. The length of time is based on your specific model and settings.

Deep Sleep Mode uses less power than Sleep Mode.

Applicable Models	Machine's LCD in Deep Sleep Mode	Conditions That Will Wake the Machine
1-Line LCD models	The LCD displays <i>Deep Sleep</i> .	<ul style="list-style-type: none"><li>The machine receives a job.</li><li>Someone presses a button on the control panel.</li></ul>
Touchscreen LCD models	The LCD backlight turns off and  blinks.	<ul style="list-style-type: none"><li>The machine receives a job.</li><li>Someone presses  or the Touchscreen LCD.</li></ul>



### Related Information

- [General Settings](#)

## Set Auto Power Off Mode

If the machine is in Deep Sleep Mode for certain length of time, based on your model and settings, the machine will go into Power Off Mode automatically. The machine does not go into Power Off Mode when the machine is connected to a network or has secure print data in the memory.

- To start printing, press  on the control panel and then send a print job.

>> [HL-L5000D/HL-L5100DN/HL-L5200DW/HL-L5200DWT/HL-L6200DW/HL-L6200DWT](#)

>> [HL-L6300DW](#)



### HL-L5000D/HL-L5100DN/HL-L5200DW/HL-L5200DWT/HL-L6200DW/HL-L6200DWT



Select how long the machine must be in Deep Sleep Mode before it goes into Auto Power Off Mode.

- Press **▲** or **▼** to display the [General Setup] option, and then press **OK**.
- Press **▲** or **▼** to display the [Ecology] option, and then press **OK**.
- Press **▲** or **▼** to select the [Auto Power Off] option, and then press **OK**.
- Press **▲** or **▼** to select the option you want, and then press **Go**.

### HL-L6300DW

- Press  [Settings] > [General Setup] > [Ecology] > [Auto Power Off].
- Press **▲** or **▼** to display the [Off], [1hour], [2hours], [4hours] or [8hours] option, and then press the option you want.
- Press .



### Related Information

- [General Settings](#)

## Adjust the LCD Backlight Brightness

Related Models: HL-L6300DW

If you are having difficulty reading the LCD, changing the brightness setting may help.

1. Press  [Settings] > [General Setup] > [Panel Control] > [LCD Settings] > [Backlight].
2. Press ▲ or ▼ to display the [Light], [Med] or [Dark] option, and then press the option you want.
3. Press .



### ✓ Related Information

- [General Settings](#)

## Change How Long the LCD Backlight Stays On

Related Models: HL-L6300DW

Set how long the LCD backlight stays on after you return to the LCD's Home screen.

1. Press  [Settings] > [General Setup] > [Panel Control] > [LCD Settings] > [Dim Timer].
2. Press ▲ or ▼ to display the [Off], [10sec], [20sec] or [30sec] option, and then press the option you want.
3. Press .

### Related Information

- [General Settings](#)

## Reduce Toner Consumption

Using the Toner Save feature may reduce toner consumption. When Toner Save is set to on, the print on your documents appears lighter.

We DO NOT recommend using the Toner Save feature for printing photo or grayscale images.



>> [HL-L5000D/HL-L5100DN/HL-L5200DW/HL-L5200DWT/HL-L6200DW/HL-L6200DWT](#)

>> [HL-L6300DW](#)

### HL-L5000D/HL-L5100DN/HL-L5200DW/HL-L5200DWT/HL-L6200DW/HL-L6200DWT

1. Press ▲ or ▼ to display the [General Setup] option, and then press **OK**.
2. Press ▲ or ▼ to display the [Ecology] option, and then press **OK**.
3. Press ▲ or ▼ to display the [Toner Save] option, and then press **OK**.
4. Press ▲ or ▼ to display [On], and then press **Go**.

### HL-L6300DW

1. Press  [Settings] > [General Setup] > [Ecology] > [Toner Save].
2. Press [On] or [Off].
3. Press .

### ✓ Related Information

- [General Settings](#)

## Reduce Printing Noise



The Quiet Mode setting can reduce printing noise. When Quiet Mode is turned on, the print speed becomes slower. The factory setting is off.

>> [HL-L5000D/HL-L5100DN/HL-L5200DW/HL-L5200DWT/HL-L6200DW/HL-L6200DWT](#)  
>> [HL-L6300DW](#)

### HL-L5000D/HL-L5100DN/HL-L5200DW/HL-L5200DWT/HL-L6200DW/HL-L6200DWT

1. Press ▲ or ▼ to display the [General Setup] option, and then press **OK**.
2. Press ▲ or ▼ to display the [Ecology] option, and then press **OK**.
3. Press ▲ or ▼ to select the [Quiet Mode] option, and then press **OK**.
4. Press ▲ or ▼ to display the [On] or [Off] option, and then press **Go**.

### HL-L6300DW

1. Press  [Settings] > [General Setup] > [Ecology] > [Quiet Mode].
2. Press [On] or [Off].
3. Press .

### Related Information

- [General Settings](#)



## Change the Language on the LCD

Change the LCD language if needed.

This feature is not available in some countries.



>> HL-L5000D/HL-L5100DN/HL-L5200DW/HL-L5200DWT/HL-L6200DW/HL-L6200DWT

>> HL-L6300DW

### HL-L5000D/HL-L5100DN/HL-L5200DW/HL-L5200DWT/HL-L6200DW/HL-L6200DWT

1. Press ▲ or ▼ to display the [General Setup] option, and then press **OK**.
2. Press ▲ or ▼ to display the [Local Language] option, and then press **OK**.
3. Press ▲ or ▼ to display your language, and then press **Go**.

### HL-L6300DW

1. Press  [Settings] > [General Setup] > [Local Language].
2. Press your language.
3. Press .

### Related Information

- [General Settings](#)

## Settings and Features Tables

The Settings tables will help you understand the menu selections and options that are found in the machine's programs.

- [Access Menus and Change Your Machine's Settings](#)
- [Settings Tables \(1 Line LCD models\)](#)
- [Settings Tables \(1.8 inch Touchscreen models\)](#)
- [Features Tables \(1.8 inch Touchscreen models\)](#)

## Access Menus and Change Your Machine's Settings

**Related Models:** HL-L5000D/HL-L5100DN/HL-L5200DW/HL-L5200DWT/HL-L6200DW/HL-L6200DWT

Use the control panel to access the machine's menus and change various settings.

1. Scroll through each menu level by pressing ▲ or ▼.
2. When the option you want appears on the LCD, press **OK**.  
The LCD displays the next menu level.
3. Press ▲ or ▼ to scroll to your selection.
4. Press **OK** or **Go**.
5. When you have finished setting an option, the LCD displays [Accepted].



### Related Information

- [Settings and Features Tables](#)

## Settings Tables (1 Line LCD models)

**Related Models:** HL-L5000D/HL-L5100DN/HL-L5200DW/HL-L5200DWT/HL-L6200DW/HL-L6200DWT

Use these tables to understand the various menus and options that you will use to set your preferences on the machine.

### [Machine Info.]

Level 1	Level 2	Description
Print Settings	-	Print the Printer Settings page.
Print NetSetting (For network models)	-	Print the Network Configuration Report.
Print WLANReport (For wireless models)	-	Print the wireless LAN connectivity diagnosis result.
Print File List	-	Print a list of data saved in the memory.
Test Print	-	Print the test page.
Drum Dot Print	-	Print the Drum Dot Check Sheet.
Print Font	HP LaserJet	Print the font list and samples of HP LaserJet.
	BR-Script 3	Print the font list and samples of BR-Script.
Serial No.	-	Display the machine's serial number.
Version	Main Version	Display the main firmware version.
	Sub1 Version	Display the sub firmware version.
Page Count	-	Display the total printed pages.
Parts Life <sup>1</sup>	Toner Life	Display the remaining life of the toner cartridge.
	Drum Life	Display the remaining life of the drum unit.
	PF KitMP Life	Display the remaining life of the PF kit MP.
	PF Kit1 Life	Display the remaining life of the PF Kit 1.
	PF Kit2 Life <sup>2</sup>	Display the remaining life of the PF Kit 2.
	PF Kit3 Life <sup>2</sup>	Display the remaining life of the PF Kit 3.
	PF Kit4 Life <sup>2</sup>	Display the remaining life of the PF Kit 4.
	Fuser Life	Display the remaining life of the fuser unit.
Laser Life	Display the remaining life of the laser unit.	

<sup>1</sup> Life is approximate and may vary by type of use.

<sup>2</sup> Available if the Lower Tray(s) is installed.

### [Paper Tray]

Level 1	Level 2	Description
Tray Use	-	Select the tray that will be used.
Priority	-	When Auto is selected in Tray Use, select the order in which the machine uses paper trays that contain paper of the same size.
Skip Tray	-	Select a specific tray you do not want to use; if it is loaded with paper of the wrong size.

Level 1	Level 2	Description
Separator Tray	-	Select the tray that contains the paper used as the separator paper, which is inserted between each print job.
2-sided	2-sided Print	Select whether to print on both sides of the paper.
	Single Image	For a print job where the last page is a 1-sided image, select the 1-sided Feed option to reduce printing time. When you use Letterhead or Preprinted paper, you must select the 2-sided Feed option. If you select 1-sided Feed for Letterhead or Preprinted paper, the last page will be printed on the reverse side.
Paper Type	MP Tray	Select the paper type that matches the paper in the MP tray.
	Tray1	Select the paper type that matches the paper in the standard paper tray.
	Tray2 <sup>1</sup>	Select the paper type that matches the paper in the Optional Tray (Tray 2).
	Tray3 <sup>1</sup>	Select the paper type that matches the paper in the Optional Tray (Tray 3).
	Tray4 <sup>1</sup>	Select the paper type that matches the paper in the Optional Tray (Tray 4).
Paper Size	MP Tray	Select the size of paper you loaded in the MP tray.
	Tray1	Select the size of paper you loaded in the standard paper tray.
	Tray2 <sup>1</sup>	Select the size of paper you loaded in the Optional Tray (Tray 2).
	Tray3 <sup>1</sup>	Select the size of paper you loaded in the Optional Tray (Tray 3).
	Tray4 <sup>1</sup>	Select the size of paper you loaded in the Optional Tray (Tray 4).
Check Size	-	Select whether to display a message telling you to check that the size of the paper in the machine and the machine's Paper Size setting match.

<sup>1</sup> Available if the Optional Tray(s) is installed.

## [General Setup]

Level 1	Level 2	Description
Local Language	-	Select the LCD language for your country.
Resolution	-	Choose a print resolution.
Density	-	Increase or decrease the print density.
Ecology	Toner Save	Increase the page yield of the toner cartridge.
	Sleep Time	Set how much time will pass before the machine enters Power Saving Mode.
	Quiet Mode	Decrease printing noise.
	Auto Power Off	Set the number of hours that the machine will remain in Deep Sleep Mode before going into Power Off Mode.
Panel Control	Button Repeat	Set the time for the LCD message to change when holding ▲ or ▼ at intervals.
	Message Scroll	Set the time in seconds that an LCD message will scroll across the LCD. From Level 1=0.2 sec to Level 10=2.0 sec.
	LCD Contrast	Adjust the contrast of the LCD.
	Auto Online	Set the machine to return to Ready Mode after it has been idle for 30 seconds.
Setting Lock	-	Lock your machine's settings using the Setting Lock password.
Interface	Select	Select the interface to use. If you select Auto, the machine changes the interface to USB or Network depending on which interface is receiving data.

Level 1	Level 2	Description
Interface	Auto IF Time	Set the time-out period for the auto interface selection.
	Input Buffer	Increase or decrease the input buffer capacity.
	Inputprime (Available only for certain models)	Select if you want to use the signal of parallel ports as a reset.
Delete Storage	Macro ID	Delete the registered Macro data.
	Font ID	Delete the registered Font data.
	Format	Restore the Macro and Font data of your machine to the default settings.

#### [Print Menu]

Level 1	Level 2	Description
Emulation	-	Choose the emulation mode.
Auto Continue	-	Select this setting if you want the machine to clear paper size errors or media type errors, and use paper from other trays.
Paper Type	-	Set the type of paper.
Paper Size	-	Set the size of paper.
Copies	-	Set the number of printed pages.
Orientation	-	Set pages to print in either portrait or landscape orientation.
Print Position	X Offset	Move the print start position (at the top-left corner of pages) horizontally up to -500 (left) to +500 (right) dots in 300 dpi.
	Y Offset	Move the print start position (at the top-left corner of pages) vertically up to -500 (up) to +500 (down) dots in 300 dpi.
Auto FF	-	Allow the machine to print any remaining data automatically.
HP LaserJet	Font No.	Set the font number.
	Font Pitch	Set the font pitch. The Font Pitch menu appears when you choose I012 to I018, I031 to I037 or I097 to I109 in Font No. setting.
	Font Point	Set the font size. The Font Point menu appears when you choose I000 to I011, I019 to I030 or I038 to I096 in Font No. setting.
	Symbol Set	Select the symbol or character set.
	Table Print	Print the code table.
	Auto LF	ON: CR -> CR+LF, OFF: CR -> CR
	Auto CR	ON: LF -> LF+CR, FF -> FF+CR, or VT -> VT+CR OFF: LF -> LF, FF -> FF, or VT -> VT
	Auto WRAP	Choose whether a line feed and carriage return will happen when the machine reaches the right margin.
	Auto SKIP	Choose whether a line feed and carriage return will happen when the carriage position reaches the bottom margin.
	Left Margin	Set the left margin at column 0 to 70 columns at 1 cpi.
	Right Margin	Set the right margin at column 10 to 80 columns at 1 cpi.
	Top Margin	Set the top margin distance from the top edge of the paper.
Bottom Margin	Set the bottom margin distance from the bottom edge of the paper.	
Lines	Set the number of lines on each page.	

Level 1	Level 2	Description
HP LaserJet	Tray Command	Select this setting if a tray mismatch appears when you use the HP drivers.
Epson FX-850	Font No.	Set the font number.
	Font Pitch	Set the font pitch. The Font Pitch menu appears when you choose I012 to I018, I031 to I037 or I097 to I109 in Font No. setting.
	Font Point	Set the font size. The Font Point menu appears when you choose I000 to I011, I019 to I030 or I038 to I096 in Font No. setting.
	Character Set	Select the symbol or character set.
	Table Print	Print the code table.
	Auto LF	ON: CR -> CR+LF, OFF: CR -> CR
	Auto Mask	Set the top and bottom margins to two-line each. When you set Auto Mask to On, this setting overrides the Top Margin and Bottom Margin settings.
	Left Margin	Set the left margin at column 0 to 70 columns at 1 cpi.
	Right Margin	Set the right margin at column 10 to 80 columns at 1 cpi.
	Top Margin	Set the top margin distance from the top edge of the paper.
	Bottom Margin	Set the bottom margin distance from the bottom edge of the paper.
Lines	Set the number of lines on each page.	
IBM Proprinter	Font No.	Set the font number.
	Font Pitch	Set the font pitch. The Font Pitch menu appears when you choose I012 to I018, I031 to I037 or I097 to I109 in Font No. setting.
	Font Point	Set the font size. The Font Point menu appears when you choose I000 to I011, I019 to I030 or I038 to I096 in Font No. setting.
	Character Set	Select the symbol or character set.
	Table Print	Print the code table.
	Auto LF	ON: CR -> CR+LF, OFF: CR -> CR
	Auto CR	ON: LF -> LF+CR, FF -> FF+CR, or VT -> VT+CR OFF: LF -> LF, FF -> FF, or VT -> VT
	Auto Mask	Set the top and bottom margins to two-line each. When you set Auto Mask to On, this setting overrides the Top Margin and Bottom Margin settings.
	Left Margin	Set the left margin at column 0 to 70 columns at 1 cpi.
	Right Margin	Set the right margin at column 10 to 80 columns at 1 cpi.
	Top Margin	Set the top margin distance from the top edge of the paper.
Bottom Margin	Set the bottom margin distance from the bottom edge of the paper.	
Lines	Set the number of lines on each page.	
BR-Script 3	Error Print	Choose whether the machine prints the error information when errors occur.
Carbon Menu	Carbon Copy	Enable or disable the Carbon Copy function.
	Copies	Set the number of printed pages.
	Copy1 Tray	Select the tray you use for Copy1.

Level 1	Level 2	Description
Carbon Menu	Copy1 Macro (Available only for certain models)	Select a macro for Copy1.
	Copy2 Tray ... Copy8 Tray	Select the tray you use for Copy2 to 8. The menu appears when printing two pages or more.
	Copy2 Macro ... Copy8 Macro (Available only for certain models)	Select a macro for Copy2 to 8. The menu appears when printing two pages or more.

### [Network] (HL-L5100DN)

Level 1	Level 2	Description
TCP/IP	Boot Method	Choose the IP method that best suits your needs.
	IP Address	Enter the IP address.
	Subnet Mask	Enter the Subnet mask.
	Gateway	Enter the Gateway address.
	IP Boot Tries	Specify the number of attempts the machine will try to obtain an IP address when the <code>Boot Method</code> is set to any setting except <code>Static</code> .
	APIPA	Allocate the IP address from the link-local address range automatically <sup>1</sup> .
	IPv6	Enable or disable the IPv6 protocol.
Ethernet	-	Choose the Ethernet link mode.
Wired Status	-	Display the Ethernet link status.
MAC Address	-	Display the MAC address of the machine.
IPsec	-	IPsec is an optional security feature of the IP protocol that provides authentication and encryption services. We recommend contacting your network administrator before changing this setting.
Network Reset	-	Restore all network settings of your machine to the factory settings.

<sup>1</sup> On connection to the network, if the machine's 'Boot Method' is 'Auto' the machine will attempt to set the IP address and Subnet Mask from a boot server such as DHCP. If a boot server cannot be found, an APIPA IP address will be allocated, such as 169. 254. [001-254]. [000-255]. If the 'Boot Method' of the machine is set to 'Static' you must manually enter an IP address from the machine's control panel.

### [Network] (HL-L5200DW/HL-L5200DWT/HL-L6200DW/HL-L6200DWT)

Level 1	Level 2	Level 3	Description
Wired LAN	TCP/IP	Boot Method	Choose the IP method that best suits your needs.
		IP Address	Enter the IP address.
		Subnet Mask	Enter the Subnet mask.
		Gateway	Enter the Gateway address.
		IP Boot Tries	Specify the number of attempts the machine will try to obtain an IP address when the <code>Boot Method</code> is set to any setting except <code>Static</code> .
		APIPA	Allocate the IP address from the link-local address range automatically <sup>1</sup> .
		IPv6	Enable or disable the IPv6 protocol.
	Ethernet	-	Choose the Ethernet link mode.
	Wired Status	-	Display the Ethernet link status.
	MAC Address	-	Display the MAC address of the machine.



Level 1	Level 2	Level 3	Description
Wired LAN	Set to Default	-	Restore wired network settings of your machine to the factory settings.
	Wired Enable	-	Turn the wired interface on or off.
WLAN	TCP/IP	Boot Method	Choose the IP method that best suits your needs.
		IP Address	Enter the IP address.
		Subnet Mask	Enter the Subnet mask.
		Gateway	Enter the Gateway address.
		IP Boot Tries	Specify the number of attempts the machine will try to obtain an IP address when the <code>Boot Method</code> is set to any setting except <code>Static</code> .
		APIPA	Allocate the IP address from the link-local address range automatically <sup>1</sup> .
		IPv6	Enable or disable the IPv6 protocol.
	Setup Wizard	-	Configure the wireless network settings using the setup wizard.
	WLAN Assistant	-	Configure your wireless network settings using the Brother CD-ROM.
	WPS	-	Configure your wireless network settings using the one-button push method.
	WPS w/PIN Code	-	Configure the wireless network settings using WPS with a PIN code.
	WLAN Status	Status	Display the wireless Ethernet link status.
		Signal	Display the signal condition.
		Channel	Display the channel in use when <code>Status</code> is <code>Active</code> .
		Speed	Display the connection speed when <code>Status</code> is <code>Active</code> .
		SSID	Display SSID.
		Comm. Mode	Display the current Communication Mode.
	MAC Address	-	Display the MAC address of the machine.
	Set to Default	-	Restore wireless network settings of your machine to the factory settings.
WLAN Enable	-	Turn the wireless interface on or off.	
Wi-Fi Direct	Push Button	-	Configure your Wi-Fi Direct network settings using the one-button push method quickly.
	PIN Code	-	Configure your Wi-Fi Direct network settings using WPS with a PIN code quickly.
	Manual	-	Configure your Wi-Fi Direct network settings manually.
	Group Owner	-	Set your machine as the Group Owner.
	Device Info.	Device Name	View your machine's device name.
		SSID	Display the Group Owner's SSID.
		IP Address	Display your machine's IP Address.
	Status Info.	Status	Display the Wi-Fi Direct network status.
		Signal	Display the current Wi-Fi Direct network signal strength. When your machine acts as Group Owner, the LCD always displays <code>Strong</code> .
		Channel	Display the channel in use when the <code>Status</code> is <code>G/O Active</code> or <code>Client Active</code> .

Level 1	Level 2	Level 3	Description
Wi-Fi Direct	Status Info.	Speed	Display the connection speed when the Status is G/O Active or Client Active.
	I/F Enable	-	Enable or disable the Wi-Fi Direct connection.
IPsec	-	-	IPsec is an optional security feature of the IP protocol that provides authentication and encryption services. We recommend contacting your network administrator before changing this setting.
Network Reset	-	-	Restore all network settings of your machine to the factory settings.

<sup>1</sup> On connection to the network, if the machine's 'Boot Method' is 'Auto' the machine will attempt to set the IP address and Subnet Mask from a boot server such as DHCP. If a boot server cannot be found, an APIPA IP address will be allocated, such as 169. 254. [001-254]. [000-255]. If the 'Boot Method' of the machine is set to 'Static' you must manually enter an IP address from the machine's control panel.

### [Factory Reset] (Available only for certain models)

Description
Reset the machine and restore the printer settings (including command settings) to the factory settings.

### [Reset Menu] (Available only for certain models)

Level 1	Description
Network	Restore all network settings of your machine to the factory settings.
Factory Reset	Reset the machine and restore the printer settings (including command settings) to the factory settings.



### Related Information

- [Settings and Features Tables](#)

## Settings Tables (1.8 inch Touchscreen models)

Related Models: HL-L6300DW



[Settings] > [Machine Information]

Level 2	Level 3	Descriptions
Print Settings	-	Print the Printer Settings page.
Print NetSetting	-	Print the Network Configuration Report.
Print WLANReport (For wireless models)	-	Print the wireless LAN connectivity diagnosis result.
Print File List	-	Print a list of data saved in the memory.
Test Print	-	Print the test page.
Drum Dot Print	-	Print the Drum Dot Check Sheet.
Print Font	HP LaserJet	Print the font list and samples of HP LaserJet.
	BR-Script 3	Print the font list and samples of BR-Script.
Serial No.	-	Display the machine's serial number.
Version	Main Version	Display the main firmware version.
	Sub1 Version	Display the sub firmware version.
Page Count	-	Display the total printed pages.
Parts Life <sup>1</sup>	Toner Life	Display the remaining life of the toner cartridge.
	Drum Life	Display the remaining life of the drum unit.
	PF KitMP Life	Display the remaining life of the PF kit MP.
	PF Kit1 Life	Display the remaining life of the PF Kit 1.
	PF Kit2 Life <sup>2</sup>	Display the remaining life of the PF Kit 2.
	PF Kit3 Life <sup>2</sup>	Display the remaining life of the PF Kit 3.
	PF Kit4 Life <sup>2</sup>	Display the remaining life of the PF Kit 4.
	Fuser Life	Display the remaining life of the fuser unit.
Laser Life	Display the remaining life of the laser unit.	

<sup>1</sup> Life is approximate and may vary by type of use.

<sup>2</sup> Available if the Optional Tray(s) is installed.



[Settings] > [Paper Tray]

Level 2	Level 3	Descriptions
Tray Use	-	Select the tray that will be used.
Priority	-	When Auto is selected in Tray Use, select the order in which the machine uses paper trays that contain paper of the same size.
Output Tray <sup>1</sup>	-	Select the output tray you want.
MX Continue <sup>1</sup>	-	Select if you want the machine to continue printing as soon as there is any free space in the Mailbox (MX).

Level 2	Level 3	Descriptions
Skip Tray	-	Select a specific tray you do not want to use; if it is loaded with paper of the wrong size.
Separator Tray	-	Select the tray that contains the paper used as the separator paper, which is inserted between each print job.
2-sided	2-sided Print	Select whether to print on both sides of the paper.
	Single Image	For a print job where the last page is a 1-sided image, select the 1-sided Feed option to reduce printing time. When you use Letterhead or Preprinted paper, you must select the 2-sided Feed option. If you select 1-sided Feed for Letterhead or Preprinted paper, the last page will be printed on the reverse side.
Paper Type	MP Tray	Select the paper type that matches the paper in the MP tray.
	Tray 1	Select the paper type that matches the paper in the standard paper tray.
	Tray 2 <sup>2</sup>	Select the paper type that matches the paper in the Optional Tray (Tray 2).
	Tray 3 <sup>2</sup>	Select the paper type that matches the paper in the Optional Tray (Tray 3).
	Tray 4 <sup>2</sup>	Select the paper type that matches the paper in the Optional Tray (Tray 4).
Paper Size	MP Tray	Select the size of paper you loaded in the MP tray.
	Tray 1	Select the size of paper you loaded in the standard paper tray.
	Tray 2 <sup>2</sup>	Select the size of paper you loaded in the Optional Tray (Tray 2).
	Tray 3 <sup>2</sup>	Select the size of paper you loaded in the Optional Tray (Tray 3).
	Tray 4 <sup>2</sup>	Select the size of paper you loaded in the Optional Tray (Tray 4).
Paper Low Notice	Paper Low Notice	Select whether to display a message telling you that the paper tray is nearly empty.
	Notice Level	Select the minimum paper level that will trigger the message.
Check Size	-	Select whether to display a message telling you to check that the size of the paper in the machine and the machine's Paper Size setting match.

<sup>1</sup> Available if the Mailbox is installed.

<sup>2</sup> Available if the Optional Tray(s) is installed.



[Settings] > [General Setup]

Level 2	Level 3	Level 4	Descriptions
Local Language	-	-	Select the LCD language for your country.
Resolution	-	-	Choose a print resolution.
Density	-	-	Increase or decrease the print density.
Ecology	Toner Save	-	Increase the page yield of the toner cartridge.
	Sleep Time	-	Set how much time will pass before the machine enters Power Saving Mode.
	Quiet Mode	-	Decrease printing noise.
	Auto Power Off	-	Set the number of hours that the machine will remain in Deep Sleep Mode before going into Power Off Mode.
Volume	Beep	-	Adjust the beeper volume.
Panel Control	LCD Settings	Backlight	Adjust the brightness of the LCD backlight.
		Dim Timer	Set how long the LCD backlight stays on after the last finger press.

Level 2	Level 3	Level 4	Descriptions
Setting Lock	Set Password	-	Restrict unauthorized users from changing the machine's settings.
	Lock Off⇒On	-	
Interface	Select	-	Select the interface to use. If you select <i>Auto</i> , the machine changes the interface to USB or Network depending on which interface is receiving data.
	Auto IF Time	-	Set the time-out period for the auto interface selection.
	Input Buffer	-	Increase or decrease the input buffer capacity.
Delete Storage	Macro ID	-	Delete the registered Macro data.
	Font ID	-	Delete the registered Font data.
	Format	-	Restore the Macro and Font data of your machine to the default settings.



[Settings] > [Print Menu]

Level 2	Level 3	Descriptions
Emulation	-	Choose the emulation mode.
Auto Continue	-	Select this setting if you want the machine to clear paper size errors or media type errors, and use paper from other trays.
Paper Type	-	Set the type of paper.
Paper Size	-	Set the size of paper.
Copies	-	Set the number of printed pages.
Orientation	-	Set pages to print in either portrait or landscape orientation.
Print Position	X Offset	Move the print start position (at the top-left corner of pages) horizontally up to -500 (left) to +500 (right) dots in 300 dpi.
	Y Offset	Move the print start position (at the top-left corner of pages) vertically up to -500 (up) to +500 (down) dots in 300 dpi.
Auto FF	-	Allow the machine to print any remaining data automatically.
HP LaserJet	Font No.	Set the font number.
	Font Pitch	Set the font pitch. The <i>Font Pitch</i> menu appears when you choose I012 to I018, I031 to I037 or I097 to I109 in <i>Font No.</i> setting.
	Font Point	Set the font size. The <i>Font Point</i> menu appears when you choose I000 to I011, I019 to I030 or I038 to I096 in <i>Font No.</i> setting.
	Symbol Set	Select the symbol or character set.
	Table Print	Print the code table.
	Auto LF	ON: CR -> CR+LF, OFF: CR -> CR
	Auto CR	ON: LF -> LF+CR, FF -> FF+CR, or VT -> VT+CR OFF: LF -> LF, FF -> FF, or VT -> VT
	Auto WRAP	Choose whether a line feed and carriage return will happen when the machine reaches the right margin.
	Auto SKIP	Choose whether a line feed and carriage return will happen when the carriage position reaches the bottom margin.
	Left Margin	Set the left margin at column 0 to 70 columns at 1 cpi.
	Right Margin	Set the right margin at column 10 to 80 columns at 1 cpi.
Top Margin	Set the top margin distance from the top edge of the paper.	

Level 2	Level 3	Descriptions
HP LaserJet	Bottom Margin	Set the bottom margin distance from the bottom edge of the paper.
	Lines	Set the number of lines on each page.
	Tray Command	Select this setting if a tray mismatch appears when you use the HP drivers.
Epson FX-850	Font No.	Set the font number.
	Font Pitch	Set the font pitch. The Font Pitch menu appears when you choose I012 to I018, I031 to I037 or I097 to I109 in Font No. setting.
	Font Point	Set the font size. The Font Point menu appears when you choose I000 to I011, I019 to I030 or I038 to I096 in Font No. setting.
	Character Set	Select the symbol or character set.
	Table Print	Print the code table.
	Auto LF	ON: CR -> CR+LF, OFF: CR -> CR
	Auto Mask	Set the top and bottom margins to two-line each. When you set Auto Mask to On, this setting overrides the Top Margin and Bottom Margin settings.
	Left Margin	Set the left margin at column 0 to 70 columns at 1 cpi.
	Right Margin	Set the right margin at column 10 to 80 columns at 1 cpi.
	Top Margin	Set the top margin distance from the top edge of the paper.
	Bottom Margin	Set the bottom margin distance from the bottom edge of the paper.
Lines	Set the number of lines on each page.	
IBM Proprinter	Font No.	Set the font number.
	Font Pitch	Set the font pitch. The Font Pitch menu appears when you choose I012 to I018, I031 to I037 or I097 to I109 in Font No. setting.
	Font Point	Set the font size. The Font Point menu appears when you choose I000 to I011, I019 to I030 or I038 to I096 in Font No. setting.
	Character Set	Select the symbol or character set.
	Table Print	Print the code table.
	Auto LF	ON: CR -> CR+LF, OFF: CR -> CR
	Auto CR	ON: LF -> LF+CR, FF -> FF+CR, or VT -> VT+CR OFF: LF -> LF, FF -> FF, or VT -> VT
	Auto Mask	Set the top and bottom margins to two-line each. When you set Auto Mask to On, this setting overrides the Top Margin and Bottom Margin settings.
	Left Margin	Set the left margin at column 0 to 70 columns at 1 cpi.
	Right Margin	Set the right margin at column 10 to 80 columns at 1 cpi.
	Top Margin	Set the top margin distance from the top edge of the paper.
Bottom Margin	Set the bottom margin distance from the bottom edge of the paper.	
Lines	Set the number of lines on each page.	
BR-Script 3	Error Print	Choose whether the machine prints the error information when errors occur.
Carbon Menu	Carbon Copy	Enable or disable the Carbon Copy function.
	Copies	Set the number of printed pages.

Level 2	Level 3	Descriptions
Carbon Menu	Copy1 Tray	Select the tray you use for Copy1.
	Copy1 Macro	Select a macro for Copy1.
	Copy2 Tray... Copy8 Tray	Select the tray you use for Copy2 to 8. The menu appears when printing two pages or more.
	Copy2 Macro... Copy8 Macro	Select a macro for Copy2 to 8. The menu appears when printing two pages or more.



[Settings] > [Network]

Level 2	Level 3	Level 4	Level 5	Descriptions
Wired LAN	TCP/IP	Boot Method	-	Choose the IP method that best suits your needs.
		IP Address	-	Enter the IP address.
		Subnet Mask	-	Enter the Subnet mask.
		Gateway	-	Enter the Gateway address.
		WINS Configuration	-	Select the WINS configuration mode.
		WINS Server	Primary	Specify the IP address of the primary WINS server.
			Secondary	Specify the IP address of the secondary WINS server.
		DNS Server	Primary	Specify the primary DNS server's IP address.
			Secondary	Specify the secondary DNS server's IP address.
		IP Boot Tries	-	Specify the number of attempts the machine will try to obtain an IP address when the <code>Boot Method</code> is set to any setting except <code>Static</code> .
	APIPA	-	Allocate the IP address from the link-local address range automatically <sup>1</sup> .	
	IPv6	-	Enable or disable the IPv6 protocol.	
	Ethernet	-	-	Choose the Ethernet link mode.
	Wired Status	-	-	Display the Ethernet link status.
	MAC Address	-	-	Display the MAC address of the machine.
Set to Default	-	-	Restore wired network settings of your machine to the factory settings.	
Wired Enable	-	-	Turn the wired interface on or off.	
WLAN	TCP/IP	Boot Method	-	Choose the IP method that best suits your needs.
		IP Address	-	Enter the IP address.
		Subnet Mask	-	Enter the Subnet mask.
		Gateway	-	Enter the Gateway address.
		WINS Configuration	-	Select the WINS configuration mode.
		WINS Server	Primary	Specify the IP address of the primary WINS server.

Level 2	Level 3	Level 4	Level 5	Descriptions	
WLAN	TCP/IP	WINS Server	Secondary	Specify the IP address of the secondary WINS server.	
		DNS Server	Primary	Specify the primary DNS server's IP address.	
			Secondary	Specify the secondary DNS server's IP address.	
		IP Boot Tries	-	Specify the number of attempts the machine will try to obtain an IP address when the <code>Boot Method</code> is set to any setting except <code>Static</code> .	
		APIPA	-	Allocate the IP address from the link-local address range automatically <sup>1</sup> .	
		IPv6	-	Enable or disable the IPv6 protocol.	
	Setup Wizard	-	-	Configure the wireless network settings using the setup wizard.	
	WLAN Assistant	-	-	Configure your wireless network settings using the Brother CD-ROM.	
	WPS	-	-	Configure your wireless network settings using the one-button push method.	
	WPS w/ PIN Code	-	-	Configure the wireless network settings using WPS with a PIN code.	
	WLAN Status	Status	-	Display the wireless Ethernet link status.	
		Signal	-	Display the signal condition.	
		SSID	-	Display SSID.	
		Comm. Mode	-	Display the current Communication Mode.	
	MAC Address	-	-	Display the MAC address of the machine.	
	Set to Default	-	-	Restore wireless network settings of your machine to the factory settings.	
	WLAN Enable	-	-	Turn the wireless interface on or off.	
	Wi-Fi Direct	Push Button	-	-	Configure your Wi-Fi Direct network settings using the one-button push method quickly.
		PIN Code	-	-	Configure your Wi-Fi Direct network settings using WPS with a PIN code quickly.
Manual		-	-	Configure your Wi-Fi Direct network settings manually.	
Group Owner		-	-	Set your machine as the Group Owner.	
Device Info.		Device Name	-	View your machine's device name.	
		SSID	-	Display the Group Owner's SSID.	
		IP Address	-	Display your machine's IP Address.	
Status Info.		Status	-	Display the Wi-Fi Direct network status.	
		Signal	-	Display the current Wi-Fi Direct network signal strength.	
I/F Enable		-	-	Enable or disable the Wi-Fi Direct connection.	
NFC	-	-	-	Turn the NFC function on or off.	



Level 2	Level 3	Level 4	Level 5	Descriptions
Web Connect Settings	Proxy Settings	Proxy Connection	-	Change the web connection settings.
		Address	-	
		Port	-	
		User Name	-	
		Password	-	
Security	IPsec	-	-	IPsec is an optional security feature of the IP protocol that provides authentication and encryption services. We recommend contacting your network administrator before changing this setting.
Network reset	-	-	-	Restore all network settings of your machine to the factory settings.

<sup>1</sup> On connection to the network, if the machine's 'Boot Method' is 'Auto' the machine will attempt to set the IP address and Subnet Mask from a boot server such as DHCP. If a boot server cannot be found, an APIPA IP address will be allocated, such as 169. 254. [001-254]. [000-255]. If the 'Boot Method' of the machine is set to 'Static' you must manually enter an IP address from the machine's control panel.



[Settings] > [Reset Menu]

Level 2	Level 3	Descriptions
Network	-	Restore all network settings of your machine to the factory settings.
Factory Reset	-	Reset the machine and restore the printer settings (including command settings) to the factory settings.



### Related Information

- [Settings and Features Tables](#)
- [Mailbox Continue](#)

## Features Tables (1.8 inch Touchscreen models)

Related Models: HL-L6300DW

### (Toner)

Level 2	Level 3	Descriptions
 (Toner)	<b>Toner Life</b>	View the approximate remaining toner life.
	<b>Test Print</b>	Print the test page.

### (Wi-Fi Setup)

Level 2	Level 3	Descriptions
 (Wi-Fi Setup)	<b>Setup Wizard</b>	Configure the wireless network settings using the setup wizard.
	<b>WLAN Assistant</b>	Configure your wireless network settings using the Brother CD-ROM.
	<b>WPS</b>	Configure your wireless network settings using the one-button push method.

### [Web]

Level 2	Level 3	Descriptions
Web	<b>OneDrive®</b>	Connect the Brother machine to an Internet service.  Web services may have been added and service names may have been changed by the provider since this document was published.  Go to your model's <b>Manuals</b> page on the Brother Solutions Center at <a href="http://support.brother.com">support.brother.com</a> to download the Web Connect Guide.
	<b>Box</b>	
	<b>Google Drive™</b>	
	<b>Dropbox</b>	

### Related Information

- [Settings and Features Tables](#)

## Change Machine Settings from Your Computer

- [Change Machine Settings Using Web Based Management](#)
- [Where Can I Find My Brother Machine's Network Settings?](#)
- [Network Management Software and Utilities](#)

## Change Machine Settings Using Web Based Management

Web Based Management is a utility that uses a standard web browser to manage your machine using the Hyper Text Transfer Protocol (HTTP) or Hyper Text Transfer Protocol over Secure Socket Layer (HTTPS).

- [What is Web Based Management?](#)
- [Access Web Based Management](#)
- [Set a Login Password for Web Based Management](#)
- [Network Management Software and Utilities](#)

## What is Web Based Management?

**Related Models:** HL-L5100DN/HL-L5200DW/HL-L5200DWT/HL-L6200DW/HL-L6200DWT/HL-L6300DW

Web Based Management is a utility that uses a standard web browser to manage your machine using the Hyper Text Transfer Protocol (HTTP) or Hyper Text Transfer Protocol over Secure Socket Layer (HTTPS). Type your machine's IP address into your web browser to access and change your print server settings.



- We recommend Microsoft® Internet Explorer® 8.0/10.0/11.0 for Windows®, and Safari 8.0 for Macintosh. Make sure that JavaScript and Cookies are always enabled in whichever browser you use. If you use different web browser, make sure it is compatible with HTTP 1.0 and HTTP 1.1.
- You must use the TCP/IP protocol on your network and have a valid IP address programmed into the print server and your computer.

The screenshot displays the Brother Web Based Management interface. At the top, there is a header with the IP address 'XXX-XXXX' on the left and the 'brother' logo and 'Brother Solutions Center' on the right. Below the header is a navigation bar with tabs for 'General', 'Print', 'Administrator', and 'Network'. The 'General' tab is selected. On the left side, there is a vertical menu with options: 'Status', 'Auto Refresh Interval', 'Maintenance Information', 'Lists/Reports', 'Find Device', 'Contact & Location', 'Sleep Time', 'Auto Power Off', 'Language', 'Volume', and 'Panel'. The 'Status' option is highlighted. The main content area shows the 'Status' page with the following information:

- Device Status:** Ready (indicated by a green bar)
- Automatic Refresh:** Off (radio button selected)
- Toner Level:** BK (indicated by a dark bar)
- Web Language:** Auto (dropdown menu)
- Device Location:** Contact: (with a person icon) and Location: (with a house icon)

- The actual screen may differ from the screen shown above.
- The following explanations are examples. The available functions vary according to the model.

### General

Use this tab to confirm the current status of your Brother machine and to change basic settings, such as the timer settings.

### Print

Use this tab to confirm and change the print settings.

### Administrator

Use this tab to set the Web Based Management password, reset various settings, and configure the function settings that are mainly used by administrators. You can also use Secure Function Lock to restrict functions according to the user.

### Network

Use this tab to change the network settings, enable or disable the network protocols, and configure the security and certificate settings.



## Related Information

- [Change Machine Settings Using Web Based Management](#)
-

## Access Web Based Management

**Related Models:** HL-L5100DN/HL-L5200DW/HL-L5200DWT/HL-L6200DW/HL-L6200DWT/HL-L6300DW

- We recommend using the HTTPS security protocol when configuring settings using Web Based Management.
  - When you use HTTPS for Web Based Management configuration, your browser will display a warning dialog box.
1. Start your web browser.
  2. Type "http://machine's IP address" in your browser's address bar (where "machine's IP address" is the machine's IP address).

For example:

http://192.168.1.2



- If you are using a Domain Name System or enable a NetBIOS name, you can type another name, such as "SharedPrinter" instead of the IP address.

- For example:

http://SharedPrinter

If you enable a NetBIOS name, you can also use the node name.

- For example:

http://brnxxxxxxxxxxxx

The NetBIOS name can be found in the Network Configuration Report.

- For Macintosh, access Web Based Management by clicking the machine's icon on the **Status Monitor** screen.

3. No password is required by default. Type a password if you have set one, and then click .

You can now change the print server settings.

If you change the protocol settings, you must restart the machine after clicking **Submit** to activate the configuration.



### Related Information

- [Change Machine Settings Using Web Based Management](#)
- [Print the Network Configuration Report](#)

## Set a Login Password for Web Based Management

**Related Models:** HL-L5100DN/HL-L5200DW/HL-L5200DWT/HL-L6200DW/HL-L6200DWT/HL-L6300DW

We recommend setting a login password to prevent unauthorized access to Web Based Management.

1. Start your web browser.
2. Type "http://machine's IP address" in your browser's address bar (where "machine's IP address" is the machine's IP address).

For example:

http://192.168.1.2



- If you are using a Domain Name System or enable a NetBIOS name, you can type another name, such as "SharedPrinter" instead of the IP address.

- For example:

http://SharedPrinter

If you enable a NetBIOS name, you can also use the node name.

- For example:

http://brnxxxxxxxxxxxx

The NetBIOS name can be found in the Network Configuration Report.

- For Macintosh, access Web Based Management by clicking the machine's icon on the **Status Monitor** screen.

3. No password is required by default. Type a password if you have set one, and then click .
4. Click **Administrator**.
5. Type the password you want to use in the **Enter New Password** field (up to 32 characters).
6. Retype the password in the **Confirm New Password** field.
7. Click **Submit**.

In the future, every time you access Web Based Management, type the password in the **Login** field, and then click .

After configuring the settings, log off by clicking .



If you have not previously set a login password, you can also set a password by clicking the **Please configure the password** button on the machine's web page.



### Related Information

- [Change Machine Settings Using Web Based Management](#)



## Appendix

- [Specifications](#)
- [How to Enter Text on Your Brother Machine](#)
- [Supplies](#)
- [Accessories](#)

## Specifications

### General Specifications

<b>Printer Type</b>		Laser
<b>Print Method</b>		Electrophotographic Laser Printer
<b>Memory Capacity</b>	<b>Standard</b>	<ul style="list-style-type: none"> <li>(HL-L5000D) 128 MB</li> <li>(HL-L5100DN/HL-L5200DW/HL-L5200DWT/ HL-L6200DW/HL-L6200DWT/HL-L6300DW) 256 MB</li> </ul>
<b>LCD (liquid crystal display)</b>		<ul style="list-style-type: none"> <li>(HL-L5000D/HL-L5100DN/HL-L5200DW/ HL-L5200DWT/HL-L6200DW/HL-L6200DWT) 16 characters x 1 line</li> <li>(HL-L6300DW) 1.8 in. TFT Color Touchscreen LCD <sup>1</sup></li> </ul>
<b>Power Source</b>		110 to 120 V AC 50/60Hz
<b>Power Consumption</b> (Average)	<b>Peak</b> <sup>2</sup>	<ul style="list-style-type: none"> <li>(HL-L5000D/HL-L5100DN/HL-L5200DW/ HL-L5200DWT) Approximately 1,248 W</li> <li>(HL-L6200DW/HL-L6200DWT/HL-L6300DW) Approximately 1,368 W</li> </ul>
	<b>Printing</b> <sup>2</sup>	<ul style="list-style-type: none"> <li>(HL-L5000D/HL-L5100DN/HL-L5200DW/ HL-L5200DWT) Approximately 620 W at 77 °F (25 °C)</li> <li>(HL-L6200DW/HL-L6200DWT/HL-L6300DW) Approximately 670 W at 77 °F (25 °C)</li> </ul>
	<b>Printing (Quiet Mode)</b> <sup>2</sup>	<ul style="list-style-type: none"> <li>Approximately 375 W at 77 °F (25 °C)</li> </ul>
	<b>Ready</b> <sup>2</sup>	Approximately 32 W at 77 °F (25 °C)
	<b>Sleep</b> <sup>2</sup>	<ul style="list-style-type: none"> <li>(HL-L5000D/HL-L5100DN/HL-L5200DW/ HL-L5200DWT/HL-L6200DW/HL-L6200DWT) Approximately 6.7 W</li> <li>(HL-L6300DW) Approximately 7.2 W</li> </ul>
	<b>Deep Sleep</b> <sup>2</sup>	<ul style="list-style-type: none"> <li>(HL-L5000D/HL-L5100DN/HL-L5200DW/ HL-L5200DWT/HL-L6200DW/HL-L6200DWT/ HL-L6300DW) Approximately 1.3 W</li> </ul>
	<b>Power Off</b> <sup>3 4</sup>	Approximately 0.03 W
<b>Dimensions</b>		Unit: in. (mm) <ul style="list-style-type: none"> <li>(HL-L5000D/HL-L5100DN/HL-L5200DW) * 14.7 (373)</li> <li>** 10.0 (255)</li> </ul>

<sup>1</sup> Measured diagonally

<sup>2</sup> Measured when the machine is connected to the USB interface.

<sup>3</sup> Measured according to IEC 62301 Edition 2.0.

<sup>4</sup> Power consumption varies slightly depending on the usage environment.

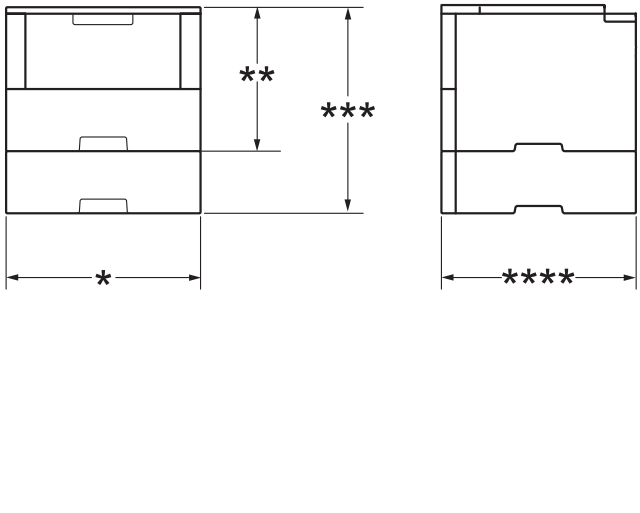
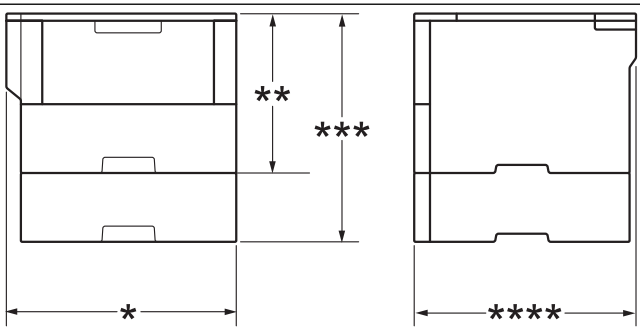
	<ul style="list-style-type: none"> <li>**** 15.3 (388)</li> <li>• (HL-L6200DW)</li> <li>* 14.7 (373)</li> <li>** 11.3 (287)</li> <li>**** 15.3 (388)</li> <li>• (HL-L5200DWT)</li> <li>* 14.7 (373)</li> <li>*** 15.2 (387)</li> <li>**** 15.3 (388)</li> <li>• (HL-L6200DWT)</li> <li>* 14.7 (373)</li> <li>*** 16.5 (419)</li> <li>**** 15.3 (388)</li> </ul>
	<p>Unit: in. (mm)</p> <ul style="list-style-type: none"> <li>• (HL-L6300DW)</li> <li>* 15.7 (400)</li> <li>** 11.3 (288)</li> <li>**** 15.6 (396)</li> </ul>
<p><b>Weights (with supplies)</b></p>	<ul style="list-style-type: none"> <li>• (HL-L5000D/HL-L5100DN/HL-L5200DW)</li> <li>23.5 lb (10.7 kg)</li> <li>• (HL-L6200DW)</li> <li>26.3 lb (11.9 kg)</li> <li>• (HL-L6300DW)</li> <li>29.0 lb (13.1 kg)</li> <li>• (HL-L5200DWT)</li> <li>32.1 lb (14.6 kg)</li> <li>• (HL-L6200DWT)</li> <li>35.0 lb (15.9 kg)</li> </ul>

<b>Noise Level</b>	<b>Sound Pressure</b>	<b>Printing</b>	<ul style="list-style-type: none"> <li>(HL-L5000D/HL-L5100DN/HL-L5200DW/HL-L5200DWT) LpAm = 52.0 dB (A)</li> <li>(HL-L6200DW/HL-L6200DWT/HL-L6300DW) LpAm = 54.0 dB (A)</li> </ul>
		<b>Printing (Quiet Mode)</b>	LpAm = 50.0 dB (A)
		<b>Ready</b>	<ul style="list-style-type: none"> <li>(HL-L5000D/HL-L5100DN/HL-L5200DW/HL-L5200DWT) LpAm = 34.0 dB (A)</li> <li>(HL-L6200DW/HL-L6200DWT/HL-L6300DW) LpAm = 35.0 dB (A)</li> </ul>
	<b>Sound Power</b>	<b>Printing</b>	<ul style="list-style-type: none"> <li>(HL-L5000D/HL-L5100DN/HL-L5200DW/HL-L5200DWT) LWAd = 6.90 B (A)</li> <li>(HL-L6200DW/HL-L6200DWT/HL-L6300DW) LWAd = 6.84 B (A)</li> </ul>
		<b>Printing (Quiet Mode)</b>	LWAd = 6.47 B (A)
		<b>Ready</b>	<ul style="list-style-type: none"> <li>(HL-L5000D/HL-L5100DN/HL-L5200DW/HL-L5200DWT) LWAd = 4.7 B (A)</li> <li>(HL-L6200DW/HL-L6200DWT/HL-L6300DW) LWAd = 4.8 B (A)</li> </ul>
<b>Temperature</b>	<b>Operating</b>	50 to 90 °F (10 to 32 °C)	
	<b>Storage</b>	32 to 104 °F (0 to 40 °C)	
<b>Humidity</b>	<b>Operating</b>	20 to 80% (without condensation)	
	<b>Storage</b>	35 to 85% (without condensation)	

## Print Media Specifications

<b>Paper Input</b>	<b>Paper Tray (Standard)</b>	<b>Paper Type</b>	Plain Paper, Letterhead, Colored Paper, Thin Paper, Recycled Paper, Thick Paper <sup>5</sup>
		<b>Paper Size</b>	A4, Letter, A5, A5 (Long Edge), A6, Executive, Legal, Folio, Mexico Legal, India Legal
		<b>Paper Weight</b>	16 to 32 lb (60 to 120 g/m <sup>2</sup> )
		<b>Maximum Paper Capacity</b>	<ul style="list-style-type: none"> <li>(HL-L5000D/HL-L5100DN/HL-L5200DW/HL-L5200DWT) Up to 250 sheets of 20 lb (80 g/m<sup>2</sup>) Plain Paper</li> <li>(HL-L6200DW/HL-L6200DWT/HL-L6300DW) Up to 520 sheets of 20 lb (80 g/m<sup>2</sup>) Plain Paper</li> </ul>
	<b>Multi-purpose tray (MP tray)</b>	<b>Paper Type</b>	Plain Paper, Letterhead, Colored Paper, Thin Paper, Thick Paper, Thicker Paper, Recycled Paper, Bond, Label, Envelope, Env.Thin, Env.Thick
		<b>Paper Size</b>	Width: 3 to 8.5 in. (76.2 to 215.9 mm) Length:

<sup>5</sup> Open the back cover (face up output tray) before printing to let the printed paper exit onto the face up output tray.

<b>Paper Input</b>	<b>Multi-purpose tray (MP tray)</b>		5 to 14 in. (127 to 355.6 mm)	
		<b>Paper Weight</b>	16 to 53 lb (60 to 200 g/m <sup>2</sup> )	
		<b>Maximum Paper Capacity</b>	Up to 50 sheets of 20 lb (80 g/m <sup>2</sup> ) Plain Paper Envelope: 10 envelopes up to 0.4 in. (10 mm) thick	
	<b>Paper Tray 2, 3, 4 (Optional)</b> <sup>6 7 8</sup>	<b>Paper Type</b>	Plain Paper, Letterhead, Colored Paper, Thin Paper, Recycled Paper, Thick Paper <sup>5</sup>	
		<b>Paper Size</b>	A4, Letter, A5, Executive, Legal, Folio, Mexico Legal, India Legal	
		<b>Paper Weight</b>	16 to 32 lb (60 to 120 g/m <sup>2</sup> )	
<b>Paper Output</b> <sup>9</sup>	<b>Face Down Output Tray</b>	<ul style="list-style-type: none"> <li>(HL-L5000D/HL-L5100DN/HL-L5200DW/HL-L5200DWT/HL-L6200DW/HL-L6200DWT) Up to 150 Sheets of 20 lb (80 g/m<sup>2</sup>) Plain Paper (face down delivery to the face down output paper tray)</li> <li>(HL-L6300DW) Up to 250 Sheets of 20 lb (80 g/m<sup>2</sup>) Plain Paper (face down delivery to the face down output paper tray)</li> </ul>		
	<b>Face Up Output Tray</b>	<ul style="list-style-type: none"> <li>(HL-L5000D/HL-L5100DN/HL-L5200DW/HL-L5200DWT/HL-L6200DW/HL-L6200DWT) One sheet (face up delivery to the face up output tray)</li> <li>(HL-L6300DW) Up to 10 sheets (face up delivery to the face up output tray)</li> </ul>		
	<b>Mailbox MX-4000 (Optional)</b>	(HL-L6300DW) 100 sheets x 4 bins of 20 lb (80 g/m <sup>2</sup> ) 400 sheets x 2 bins of 20 lb (80 g/m <sup>2</sup> )		
<b>2-sided</b>	<b>Automatic 2-sided Printing</b>	<b>Paper Type</b>	Plain Paper, Letterhead, Colored Paper, Thin Paper, Recycled Paper	
		<b>Paper Size</b>	Letter, Legal, Mexico Legal, India Legal, Folio	
		<b>Paper Weight</b>	16 to 28 lb (60 to 105 g/m <sup>2</sup> )	

## Printer Specifications

<b>Automatic 2-sided Print</b>	Yes
<b>Emulation</b>	PCL6, BR-Script3, IBM Proprinter XL, Epson FX-850, PDF version 1.7, XPS version 1.0
<b>Resolution</b>	Up to 1200 x 1200 dpi
<b>Print Speed</b> <sup>10 11</sup>	<b>1-sided print</b> • (HL-L5000D/HL-L5100DN/HL-L5200DW/HL-L5200DWT)

<sup>6</sup> HL-L5000D/HL-L5100DN/HL-L5200DW :You can install up to two Lower Trays 250 sheets (LT-5500) or 520 sheets (LT-6500).

<sup>7</sup> HL-L6200DW/HL-L6300DW :You can install up to two Lower Trays 250 sheets (LT-5500) or 520 sheets (LT-6500) or three Lower Trays 250 sheets (LT-5500)

<sup>8</sup> HL-L5200DWT/HL-L6200DWT :You can install one Lower Tray 250 sheets (LT-5500) or 520 sheets (LT-6500).

<sup>9</sup> For labels, we recommend removing the printed sheets from the output paper tray immediately after they exit the machine to avoid the possibility of smudging.

<sup>10</sup> The print speed may change depending on the type of document you print.

<b>Print Speed</b> <sup>10 11</sup>		Up to 42 pages/minute (Letter size) Up to 40 pages/minute (A4 size) • (HL-L6200DW/HL-L6200DWT/HL-L6300DW) Up to 48 pages/minute (Letter size) Up to 46 pages/minute (A4 size)
	<b>2-sided Print</b>	• (HL-L5000D/HL-L5100DN/HL-L5200DW/HL-L5200DWT) Up to 20 sides/minute (Up to 10 sheets/minute) (Letter or A4 size) • (HL-L6200DW/HL-L6200DWT/HL-L6300DW) Up to 24 sides/minute (Up to 12 sheets/minute) (Letter or A4 size)
<b>First Print Time</b> <sup>12</sup>		• (HL-L5000D/HL-L5100DN/HL-L5200DW/HL-L5200DWT) Less than 7.2 seconds at 73.4 °F (23 °C) / 115 V • (HL-L6200DW/HL-L6200DWT/HL-L6300DW) Less than 7.5 seconds at 73.4 °F (23 °C) / 115 V

## Interface Specifications

<b>Parallel</b> <sup>13</sup>	HL-L5000D	Compliant with IEEE1284
<b>USB</b> <sup>14 15</sup>	All	Hi-Speed USB 2.0 Use a USB 2.0 interface cable that is no longer than 6 ft (2 m).
<b>LAN</b>	HL-L5100DN/HL-L5200DW/ HL-L5200DWT	10BASE-T/100BASE-TX <sup>16</sup>
	HL-L6200DW/HL-L6200DWT/ HL-L6300DW	10BASE-T/100BASE-TX/1000Base-T <sup>16 17</sup>
<b>Wireless LAN</b>	HL-L5200DW/HL-L5200DWT/ HL-L6200DW/HL-L6200DWT/ HL-L6300DW	IEEE 802.11b/g/n (Infrastructure/Ad-hoc Mode) IEEE 802.11g/n (Wi-Fi Direct)
<b>NFC</b>	HL-L6300DW	Yes

## Supported Protocols and Security Features

### Ethernet

10Base-T/100Base-TX/1000Base-T

### Wireless LAN

IEEE 802.11b/g/n (Infrastructure Mode/Ad-hoc Mode), IEEE 802.11g/n (Wi-Fi Direct)

### Protocols (IPv4)

ARP, RARP, BOOTP, DHCP, APIPA(Auto IP), WINS/NetBIOS name resolution, DNS Resolver, mDNS, LLMNR responder, LPR/LPD, Custom Raw Port/Port9100, IPP/IPPS, FTP Server, TELNET Server, HTTP/HTTPS server, TFTP client and server, SMTP Client, SNMPv1/v2c/v3, ICMP, Web Services (Print), CIFS client, SNTTP client, LDAP (available only for certain models)

<sup>11</sup> Print speed may be slower when the machine is connected by wireless LAN.

<sup>12</sup> From Ready mode and standard tray

<sup>13</sup> If the parallel cable is not provided with the machine in your country or region, please contact Brother Customer Service or your local Brother dealer to purchase the optional parallel cable (PC-5000).

<sup>14</sup> Your machine has a USB 2.0 Hi-Speed interface. The machine can also be connected to a computer that has a USB 1.1 interface.

<sup>15</sup> Third party USB ports are not supported.

<sup>16</sup> Use a straight-through Category 5 (or greater) twisted-pair cable.

<sup>17</sup> When you connect the machine to a Gigabit Ethernet Network, use network devices complying with the 1000BASE-T specification.

## Protocols (IPv6)

NDP, RA, DNS resolver, mDNS, LLNMR responder, LPR/LPD, Custom Raw Port/Port9100, IPP/IPPS, FTP Server, TELNET Server, HTTP/HTTPS server, TFTP client and server, SMTP Client, SNMPv1/v2c, ICMPv6, Web Services (Print), CIFS Client, SNTP Client, LDAP (available only for certain models)

## Network Security (Wired)

SMTP-AUTH, SSL/TLS (IPPS, HTTPS, SMTP), SNMP v3 802.1x (EAP-MD5, EAP-FAST, PEAP, EAP-TLS, EAP-TTLS), Kerberos, IPsec

## Network Security (Wireless)

SMTP-AUTH, SSL/TLS (IPPS, HTTPS, SMTP), SNMP v3 802.1x (LEAP, EAP-FAST, PEAP, EAP-TLS, EAP-TTLS), Kerberos, IPsec

## Wireless Network Security

WEP 64/128 bit, WPA-PSK (TKIP/AES), WPA2-PSK (AES)

## Wireless Certification

Wi-Fi Certification Mark License (WPA™/WPA2™ - Enterprise, Personal), Wi-Fi Protected Setup (WPS) Identifier Mark License, Wi-Fi CERTIFIED Wi-Fi Direct

## Computer Requirements Specifications

### Supported Operating Systems And Software Functions

Computer Platform & Operating System Version		PC Interface				Processor	Hard Disk Space to Install
		Parallel <sup>1</sup> (IEEE1284)	USB <sup>2</sup>	10Base-T/ 100Base-TX/ 1000Base-T <sup>3 4</sup> (Ethernet)	Wireless <sup>5</sup> 802.11b/g/n		
Windows® Operating System	Windows® XP Home	Printing				32 bit (x86) or 64 bit (x64) processor	80 MB
	Windows® XP Professional						
	Windows Vista®						
	Windows® 7						
	Windows® 8						
	Windows® 8.1						
	Windows Server® 2003	Printing				32 bit (x86) or 64 bit (x64) processor	80 MB
	Windows Server® 2003 x64 Edition						
	Windows Server® 2008						
	Windows Server® 2008 R2						
	Windows Server® 2012					64 bit (x64) processor	

	Windows Server® 2012 R2			essor	
Macintosh Operating System	OS X v10.8.5	N/A	Printing	Intel® Processor	80 MB
	OS X v10.9.x				
	OS X v10.10.x				

1 HL-L5000D

2 Third party USB ports are not supported.

3 HL-L5100DN/HL-L5200DW/HL-L5200DWT support 10Base-T/100Base-TX

4 HL-L6200DW/HL-L6200DWT/HL-L6300DW support 10Base-T/100Base-TX/1000Base-T

5 HL-L5200DW/HL-L5200DWT/HL-L6200DW/HL-L6200DWT/HL-L6300DW

For the latest driver updates, go to your model's **Downloads** page on the Brother Solutions Center at [support.brother.com](http://support.brother.com).

All trademarks, brand and product names are the property of their respective companies.



## Related Information

- [Appendix](#)



## How to Enter Text on Your Brother Machine

>> [HL-L5000D/HL-L5100DN/HL-L5200DW/HL-L5200DWT/HL-L6200DW/HL-L6200DWT](#)  
>> [HL-L6300DW](#)

### HL-L5000D/HL-L5100DN/HL-L5200DW/HL-L5200DWT/HL-L6200DW/HL-L6200DWT

When setting certain options, such as the Network Key, you must enter characters on the machine:

- Hold down or repeatedly press ▲ or ▼ to select a character from this list:  
0123456789abcdefghijklmnopqrstuvwxyzABCDEFGHIJKLMNOPQRSTUVWXYZ(space)!"#\$%&'()\*+,-./:;<=>?  
@[^\_
- Press **OK** when the character or symbol you want is displayed, and then enter the next character.
- Press **Back** to delete characters entered incorrectly.

### HL-L6300DW

When text is required, a keyboard appears on your machine's LCD.

- The characters may differ depending on your country.
- The keyboard layout may differ depending on the operation you perform.





- Press  to cycle between letters, numbers and special characters.
- To move the cursor to the left or right, press ◀ or ▶.

#### Inserting spaces

- To enter a space, press  twice to choose special characters, then press the space button.

#### Making corrections

- If you entered a character incorrectly and want to change it, press ◀ or ▶ to move the cursor to the incorrect character and press . Enter the correct character.
- To insert a character, press ◀ or ▶ to move the cursor to the correct place, and then enter the character.
- Press  for each character you want to erase, or press and hold  to erase all the characters.

### ✓ Related Information

- [Appendix](#)
- [Configure Your Machine for a Wireless Network in Ad-Hoc Mode Using an Existing SSID](#)
- [Configure Your Machine for a Wireless Network Using the Machine's Control Panel Setup Wizard](#)
- [Configure Your Machine for a Wireless Network in Ad-Hoc Mode Using a New SSID](#)

- 
- [Configure Your Machine for a Wireless Network When the SSID Is Not Broadcast](#)
-

## Supplies

When the time comes to replace supplies, such as the toner or drum, an error message will appear on your machine's control panel or in the Status Monitor. For more information about the supplies for your machine, visit <http://www.brother.com/original/index.html> or contact your local Brother dealer.

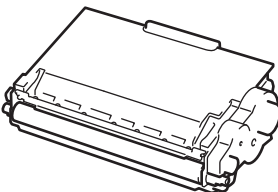
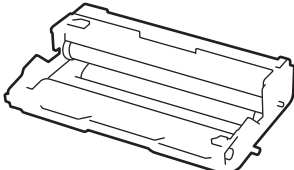

- The toner cartridge and drum unit are two separate parts.
- The toner cartridge number will vary depending on your country and region.

Supply	Supply order No.	Approximate Life (Page Yield)	Applicable Models
<b>Toner Cartridge</b> 	<b>Standard Toner:</b> TN-820	Approximately 3,000 pages <sup>1</sup> (Letter or A4 page)	HL-L5000D/HL-L5100DN/ HL-L5200DW/ HL-L5200DWT/ HL-L6200DW/ HL-L6200DWT/ HL-L6300DW
	<b>High Yield Toner:</b> TN-850	Approximately 8,000 pages <sup>1</sup> (Letter or A4 page)	HL-L5000D/HL-L5100DN/ HL-L5200DW/ HL-L5200DWT/ HL-L6200DW/ HL-L6200DWT/ HL-L6300DW
	<b>Super High Yield Toner:</b> TN-880	Approximately 12,000 pages <sup>1</sup> (Letter or A4 page)	HL-L6200DW/ HL-L6200DWT/ HL-L6300DW
	<b>Starter Toner:</b> supplied with your machine	Approximately 3,000 pages <sup>1</sup> (Letter or A4 page)	HL-L5000D/HL-L5100DN/ HL-L5200DW/ HL-L5200DWT/ HL-L6200DW/ HL-L6200DWT
		Approximately 8,000 pages <sup>1</sup> (Letter or A4 page)	HL-L6300DW
<b>Drum Unit</b> 	DR-820	Approximately 30,000 pages <sup>2</sup>	HL-L5000D/HL-L5100DN/ HL-L5200DW/ HL-L5200DWT/ HL-L6200DW/ HL-L6200DWT/ HL-L6300DW



### Related Information

- [Appendix](#)
- [Replace Supplies](#)

<sup>1</sup> Approximate cartridge yield is declared in accordance with ISO/IEC 19752.

<sup>2</sup> Approximately 30,000 pages based on 1 page per job and 50,000 pages based on 3 pages per job [A4/letter simplex pages]. The number of pages may be affected due to a variety of factors including but not limited to media type and media size.

## Accessories

Availability of accessories may vary depending on your country or region. For more information about the accessories for your machine, visit <http://www.brother.com/original/index.html> or contact your Brother dealer or Brother Customer Service.

Order No.	Item	Applicable Models
LT-5500	Lower Tray (250 sheets)	All models
LT-6500	Lower Tray (520 sheets)	All models
MX-4000	Mailbox	HL-L6300DW



### Related Information

- [Appendix](#)
- [Mailbox Unit](#)

## Mailbox Unit

Related Models: HL-L6300DW

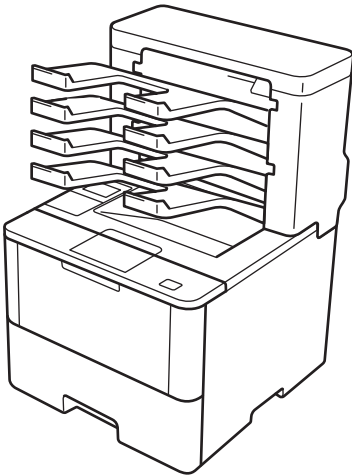

The optional Mailbox (MX) unit gives you increased control over your Brother machine's print output. You can assign the unit's four output bins to specific users, organize specific print jobs more efficiently, and extend the machine's printout capacity.

Use the Mailbox unit as a:

- **Mailbox:** Assign each bin to a specific user or group, and send print jobs directly to each recipient's bin.
- **Stacker:** When printing large documents, use the bins to increase your machine's output tray capacity. When the machine's output tray is full, the machine ejects the pages into the Mailbox bins.  
To increase the machine's output capacity to a maximum of 1,050 sheets (including the standard output tray), remove bins 2 and 4.
- **Sorter:** When printing multiple copies, set the printer driver to eject each copy into a different bin.

Set your preferences for Stacker (**MX Stacker**) and Sorter (**MX Sorter**) in your printer driver or on your Brother machine's LCD.

### To set MX Stacker or MX Sorter in your printer driver (for Windows®)

In your printer driver, click the **Advanced** tab, click the **Output Tray** drop-down menu, and select either **MX Stacker** or **MX Sorter**. Click **OK**.

### To set MX Stacker or MX Sorter in your printer driver (for Macintosh)

In your printer driver, select **Print Settings**, click the **Output Tray** pop-up menu, and select either **MX Stacker** or **MX Sorter**.



For more information on printer driver settings, see *Related Information*.

### To set MX Stacker or MX Sorter from the machine's LCD

On the machine's LCD, press  [Settings] > [Paper Tray] > [Output Tray] > [MX Stacker] or [MX Sorter].



### Related Information

- [Accessories](#)
- [Use Standard Tray When Full](#)
- [Mailbox Continue](#)
- [Assign a Mailbox Bin to a User or Group](#)

- 
- Print Settings (Windows®)
  - Print Options (Macintosh)
-

## Use Standard Tray When Full

**Related Models:** HL-L6300DW

The **Use Std. Tray when full** feature allows a large print job to continue printing, even if the Mailbox bins are full. If you select this option in your printer driver, the machine continues the print job, ejecting the remaining pages onto the machine's main output tray when the Mailbox bins are full.

For more information on the printer driver settings, see *Related Information*.



This setting's name is for Windows and may vary for Macintosh depending on your country.



### Related Information

- [Mailbox Unit](#)
- [Print Settings \(Windows®\)](#)
- [Print Options \(Macintosh\)](#)

## Mailbox Continue

**Related Models:** HL-L6300DW

If a print job stopped because all the bins are full, the MX (Mailbox) Continue feature allows the machine to resume the print job after you remove the printed pages from any of the printout locations.

Setting	Description
On	Your machine resumes the print job using the first empty output tray or Mailbox bin.
Off	You must remove the printed pages from the output tray and all Mailbox bins to resume the print job.

By default, MX Continue is off. To turn on MX Continue:

Press  [Settings] > [Paper Tray] > [MX Continue] > [On].

### Related Information

- [Mailbox Unit](#)
- [Settings Tables \(1.8 inch Touchscreen models\)](#)



## Assign a Mailbox Bin to a User or Group

**Related Models:** HL-L6300DW

To organize print jobs by sending them to a specific recipient, assign each Mailbox bin to an individual or to a group.



- This feature is available only when Secure Function Lock 3.0 is on.
- Make sure you select **Auto** (default setting) from **Output Tray** in the printer driver when you send the print job.
- This setting's name is for Windows and may vary for Macintosh depending on your country.

Anyone using your Brother machine can send a print job to a specific bin but the administrator must assign the bins to users or groups first.

1. Start your web browser.
2. Type "http://machine's IP address" in your browser's address bar (where "machine's IP address" is the machine's IP address).

For example:

http://192.168.1.2

3. Click the **Administrator** tab.
4. Click the **User Restriction Function** menu in the left navigation bar.
5. Select **Secure Function Lock**.
6. Click **Submit**.
7. Click the **User List** menu in the left navigation bar.
8. In the **User List** field, type the user name.
9. In the **PIN Number** field, type a four-digit password.
10. Click the **Output** drop-down list, and then select the output tray for each user.
11. Select **User List / Restricted Functions** from the drop-down list for each user.
12. Click **Submit**.
13. Click the **Print** tab.
14. Click the **Tray** menu in the left navigation bar.
15. Click the **Output** drop-down list, and then select **SFL setting**.
16. Click **Submit**.



### Related Information

- [Mailbox Unit](#)
- [Print Settings \(Windows®\)](#)
- [Print Options \(Macintosh\)](#)
- [Configure Secure Function Lock 3.0 Using Web Based Management](#)

## Glossary

This is a comprehensive list of features and terms that appear in Brother manuals. Availability of these features depends on the model you purchased.

**A B C D E G H I L M N O P R S T V W**

### A

- Active Directory® Authentication
- Ad-Hoc Mode
- AES
- APIPA
- ARP
- Authentication

### B

- BOOTP
- BRAdmin Light (Windows®)
- BRAdmin Professional 3 (Windows®)
- BRPrint Auditor (Windows®)

### C

- CA
- CA Certificate
- Certificate
- Channels
- CIFS
- CSR
- Custom Raw Port

## D

- [Density](#)
- [DHCP](#)
- [DNS Client](#)
- [DNS Server](#)
- [Driver Deployment Wizard](#)

## E

- [Encryption](#)

## G

- [Gateway](#)

## H

- [HTTP \(Web Server\)](#)
- [HTTPS](#)

## I

- [IEEE 802.1x](#)
- [Infrastructure Mode](#)
- [IP Address](#)
- [IPP](#)
- [IPPS](#)
- [IPsec](#)
- [IPv6](#)

## L

- [LEAP](#)
- [LLMNR](#)

- [LPD](#)
- [LPR](#)

## M

- [MAC Address](#)
- [mDNS](#)

## N

- [NetBIOS Name Resolution](#)
- [Network Configuration Report](#)
- [Network Connection Repair Tool](#)
- [Network Key](#)
- [Network Shared Printing](#)
- [Node Name](#)

## O

- [Open System](#)

## P

- [PEAP](#)
- [Peer-to-Peer](#)
- [Protocols](#)
- [Public Key Cryptosystem](#)

## R

- [RARP](#)
- [Resolution](#)

## S

- [Secure Function Lock 3.0](#)

- [Settings Tables](#)
- [Shared Key Cryptosystem](#)
- [SMTP Client](#)
- [SMTP over SSL](#)
- [SMTP-AUTH](#)
- [SNMP](#)
- [SNMPv3](#)
- [SNTP](#)
- [SSID](#)
- [SSL/TLS](#)
- [Status Monitor](#)
- [Store Print Log to Network](#)
- [Subnet Mask](#)

## T

- [TCP/IP](#)
- [TELNET](#)
- [TKIP](#)

## V

- [Vertical Pairing](#)

## W

- [Web Based Management](#)
- [Web Services](#)
- [WEP](#)
- [Wi-Fi Direct®](#)
- [WINS](#)

---

▲ Home > Glossary

- [WINS Server](#)
- [WLAN Report](#)
- [WPA-PSK/WPA2-PSK Authentication Method](#)
- [WPS](#)

## Active Directory® Authentication

Active Directory® Authentication restricts the use of the Brother machine. You cannot use your machine until you log on to the machine using a user ID and password.

## Ad-Hoc Mode

The mode of operation in a wireless network, in which all devices (machines and computers) are connected without an access point/router.

## AES

Advanced Encryption Standard (AES) is the Wi-Fi®-authorized strong encryption standard.

## APIPA

If you do not assign an IP address manually or automatically (using a DHCP, BOOTP, or RARP server), the Automatic Private IP Addressing (APIPA) protocol will automatically assign an IP address from the range 169.254.1.0 to 169.254.254.255.

## ARP

Address Resolution Protocol (ARP) performs mapping of an IP address to a MAC address in a TCP/IP network.

## Authentication

Most wireless networks use some kind of security settings. These security settings define the authentication (how the device identifies itself to the network) and encryption (how the data is encrypted as it is sent on the network). If you do not correctly specify these options when you are configuring your Brother wireless machine, it will not be able to connect to the wireless network. Therefore, care must be taken when configuring these options.

### Authentication Methods for a Personal Wireless Network

A personal wireless network is a small network (such as a home wireless network) without IEEE 802.1x support.

- Open system

Wireless devices are allowed to access the network without any authentication.

- Shared key

A secret pre-determined key is shared by all devices that will access the wireless network. The Brother wireless machine uses the WEP key as the pre-determined key.

- WPA-PSK/WPA2-PSK

Enables a Wi-Fi Protected Access® Pre-shared key (WPA-PSK/WPA2-PSK), which enables the Brother wireless machine to associate with access points using TKIP for WPA-PSK or AES for WPA-PSK and WPA2-PSK (WPA-Personal).

### Authentication Methods for an Enterprise Wireless Network

An enterprise wireless network is a large network, for example using your machine in a business enterprise wireless network, with IEEE 802.1x support. If you configure your machine in an IEEE 802.1x supported wireless network, you can use the following authentication methods.

- LEAP
- EAP-FAST

- PEAP
- EAP-TTLS
- EAP-TLS



---

The authentication methods above use the user ID less than 64 characters and a password of less than 32 characters in length.

---

## BOOTP

The Bootstrap Protocol (BOOTP) is a network protocol used by a network client to obtain an IP Address from a configuration server.



---

To use BOOTP, contact your network administrator.

---

## BRAdmin Light (Windows®)

BRAdmin Light is a utility for the initial setup of Brother network-connected devices. This utility can search for Brother products on your network, view the status and configure the basic network settings, such as IP address.

Go to your model's **Downloads** page on the Brother Solutions Center at [support.brother.com](http://support.brother.com) to download BRAdmin Light.

## BRAdmin Professional 3 (Windows®)

BRAdmin Professional 3 is a utility for more advanced management of network-connected Brother devices. This utility can search for Brother products on your network and view the device status from an easy-to-read Windows® Explorer-style screen that changes color to identify the status of each device. You can configure network and device settings, and update device firmware from a Windows® computer on your LAN. BRAdmin Professional 3 can also log activity of Brother devices on your network and export the log data in an HTML, CSV, TXT, or SQL format. For users who want to monitor locally-connected machines, install the Print Auditor Client software on the client computer. This utility allows you to use BRAdmin Professional 3 to monitor machines that are connected to a client computer via the USB interface.

Go to your model's **Downloads** page on the Brother Solutions Center at [support.brother.com](http://support.brother.com) to download the software.



- 
- This utility is available only for Windows®.
  - Go to your model's **Downloads** page on the Brother Solutions Center at [support.brother.com](http://support.brother.com) to download the latest version of Brother's BRAdmin Professional 3 utility.
  - Node name: The node name appears in the current BRAdmin Professional 3 window. The default node name is "BRNxxxxxxxxxxxx" for a wired network or "BRWxxxxxxxxxxxx" for a wireless network (where "xxxxxxxxxxxx" is your machine's MAC Address / Ethernet address).
  - If you are using Windows® Firewall, or the firewall function of an anti-spyware or antivirus application, temporarily disable them. When you are sure you can print, configure the software settings following the instructions.
- 

## BRPrint Auditor (Windows®)

Brother's BRPrint Auditor software brings the monitoring power of Brother network management tools to locally-connected machines. This utility allows a client computer to collect usage and status information from your



Brother machine connected via the parallel or USB interface. The BRPrint Auditor can then pass this information to another computer running BRAdmin Professional 3 on the network. This allows the administrator to check items, such as page counts, toner and drum status, and the firmware version. In addition to reporting to Brother network management applications, this utility can email the usage and status information directly to a predefined email address in a CSV or XML file format (SMTP Mail support required). The BRPrint Auditor utility also supports email notification for reporting warning and error conditions.

## CA

A Certificate Authority (CA) is an entity that issues digital certificates (especially X.509 certificates) and vouches for the binding between the data items in a certificate.

## CA Certificate

A CA Certificate is the certification that identifies the CA itself and owns its private key. A CA Certificate verifies a certificate issued by the CA.

## Certificate

A Certificate is the information that binds together a public key with an identity. The certificate can be used to verify that a public key belongs to an individual. The format is defined by the X.509 standard.

## Channels

Wireless networks use channels. Each wireless channel is on a different frequency. There are up to 14 different channels that can be used when using a wireless network. However, in many countries the number of channels available is restricted.

## CIFS

The Common Internet File System (CIFS) is the standard way that computer users share files and printers in Windows®.

## CSR

A Certificate Signing Request (CSR) is a message sent from an applicant to a Certificate Authority (CA) to apply for issue of a certificate. The CSR contains information identifying the applicant, the public key generated by the applicant and the digital signature of the applicant.

## Custom Raw Port

Custom raw port is a commonly used printing protocol on a TCP/IP network that enables interactive data transmission. Default is Port 9100.

## Density

Changing the Density makes the whole image lighter or darker.

## DHCP

The Dynamic Host Configuration Protocol (DHCP) is a network protocol that is used to configure network devices so that they can communicate on an IP Network.



To use DHCP, contact your network administrator.

## DNS Client

The Brother print server supports the Domain Name System (DNS) client feature. This feature allows the print server to communicate with other devices using its DNS name.

## DNS Server

The Domain Name System (DNS) is a technology to manage the names of web sites and internet domains. A DNS server allows your computer to find its IP address automatically.

## Driver Deployment Wizard

Brother's Installation CD-ROM includes the Windows® printer driver and Brother network port driver (LPR and NetBIOS). If an administrator installs the printer driver and port driver using this application, the administrator can save the file to the file server or send the file by email to users. Then, each user just clicks that file to have the printer driver, port driver, IP address, etc. automatically copied to their computer.

## Encryption

Most wireless networks use some kind of security settings. These security settings define the authentication (how the device identifies itself to the network) and encryption (how the data is encrypted as it is sent on the network). If you do not correctly specify these options when you are configuring your Brother wireless machine, it will not be able to connect to the wireless network. Therefore, care must be taken when configuring these options.

### Encryption Methods for a Personal Wireless Network

A personal wireless network is a small network (such as a home wireless network) without IEEE 802.1x support.

- None

No encryption method is used.

- WEP

When using Wired Equivalent Privacy (WEP) the data is transmitted and received with a secured key.

- TKIP

Temporal Key Integrity Protocol (TKIP) provides per-packet key mixing a message integrity check and rekeying mechanism.

- AES

Advanced Encryption Standard (AES) provides stronger data protection using a symmetric-key encryption.



- IEEE 802.11n does not support either WEP or TKIP as an encryption method.
- To connect to your wireless network using IEEE 802.11n, we recommend selecting AES.

## Encryption Methods for an Enterprise Wireless Network

An enterprise wireless network is a large network, for example using your machine in a business enterprise wireless network, with IEEE 802.1x support. If you configure your machine in an IEEE 802.1x supported wireless network, you can use the following encryption methods.

- TKIP
- AES
- CKIP

The original key Integrity Protocol for LEAP by Cisco Systems, Inc.

## Gateway

A gateway is a network point that acts as an entrance to another network and sends data transmitted via the network to an exact destination. The router knows where to direct data that arrives at the gateway. If a destination is located on an external network, the router transmits data to the external network. If your network communicates with other networks, you may need to configure the Gateway IP address. If you do not know the Gateway IP address, then contact your Network Administrator.

## HTTP (Web Server)

Hypertext Transfer Protocol (HTTP) is used to transmit the data between a web server and a web browser. The Brother print server is equipped with a built-in web server that allows you to monitor its status or change some of its configuration settings using a web browser.

## HTTPS

HTTPS (HTTP over SSL/TLS) is the version of the Hypertext Transfer Protocol (HTTP) that uses SSL/TLS so that web content is transferred and displayed securely.

## IEEE 802.1x

IEEE 802.1x is a networking authentication standard used to connect to a wired or wireless LAN. It restricts connections which are not authentic and only users authenticated by a central authority are allowed to be connected.

## Infrastructure Mode

The mode of operation in a wireless network, in which all devices (machines and computers) are connected via an access point/router.

## IP Address

An Internet Protocol (IP) address is a series of numbers that identifies each device connected to a network. An IP address consists of four numbers separated by dots. Each number is between 0 and 255.

Example: In a small network, you would normally change the final number.

192.168.1.1

192.168.1.2

192.168.1.3

How the IP address is assigned to your print server:

If you have a DHCP/BOOTP/RARP server in your network, the print server will automatically obtain its IP address from that server.



On smaller networks, the DHCP server may also be the Router.

If you do not have a DHCP/BOOTP/RARP server, the Automatic Private IP Addressing (APIPA) protocol will automatically assign an IP address from the range 169.254.1.0 to 169.254.254.255.

## IPP

The Internet Printing Protocol (IPP Version 1.0) allows you to print documents directly to any accessible machine via the Internet.

## IPPS

IPPS (Internet Printing Protocol) is the printing protocol that uses SSL. IPPS is used to send and receive printing data and manage printing devices.

## IPsec

IPsec is an optional security feature of the IP protocol that provides authentication and encryption services.

## IPv6

IPv6 is the next generation Internet protocol. For more information on the IPv6 protocol, go to your model's page on the Brother Solutions Center at [support.brother.com](http://support.brother.com).

## LEAP

Lightweight Extensible Authentication Protocol (LEAP) is a proprietary EAP method developed by Cisco Systems, Inc. that uses a user ID and password for authentication. LEAP is used in wireless networks.

## LLMNR

The Link-Local Multicast Name Resolution (LLMNR) protocol resolves the names of neighboring computers, if the network does not have a Domain Name System (DNS) server. The LLMNR Responder feature works in both the IPv4 or IPv6 environment when using Windows Vista® or greater.

## LPD

Line Printer Daemon (LPD or LPR) protocol is a commonly-used printing protocol on a TCP/IP network, mainly for UNIX®-based operating systems.

## LPR

Line Printer Daemon (LPR or LPD) protocol is a commonly-used printing protocol on a TCP/IP network.

## MAC Address

The MAC Address (Ethernet Address) is a unique number assigned for the machine's network interface.

## mDNS

Multicast DNS (mDNS) allows the Brother print server to configure itself to work in an OS X Simple Network Configuration system automatically.

## NetBIOS Name Resolution

Network Basic Input/Output System (NetBIOS) name resolution enables you to obtain the IP address of the other device using its NetBIOS name during the network connection.

## Network Configuration Report

The Network Configuration Report prints a report listing the current network configuration, including the network print server settings.

## Network Connection Repair Tool

The Network Connection Repair Tool is a program Brother provides to correct the driver's settings so that they match the machine's network settings. To use the Network Connection Repair Tool, ask your network administrator.

## Network Key

The Network Key is a password, which is used when the data is encrypted or decrypted. The Network Key is also described as the Password, Security Key, or Encryption Key. The table shows the number of characters of the key to use for each setting.

### Open system/Shared key with WEP

This key is a 64-bit or a 128-bit value that must be entered in an ASCII or hexadecimal format.

	ASCII	Hexadecimal
64 (40) bit	Uses five text characters. For example, "WSLAN" (case-sensitive).	Uses 10 digits of hexadecimal data. For example, "71f2234aba" (not case-sensitive).
128 (104) bit	Uses 13 text characters. For example, "Wirelesscomms" (case-sensitive).	Uses 26 digits of hexadecimal data. For example, "71f2234ab56cd709e5412aa2ba" (not case-sensitive).

### WPA-PSK/WPA2-PSK and TKIP or AES

Uses a Pre-Shared Key (PSK) that is eight or more characters in length, up to a maximum of 63 characters.

## Network Shared Printing

Network Shared Printing is a type of printing in a network shared environment. In a network shared environment, each computer sends data via a server or print server.

## Node Name

The Node Name is a machine name on the network. This name is often referred to as a NetBIOS name; it will be the name that is registered by the WINS server on your network. Brother recommends the name "BRNxxxxxxxxxxx" for a wired network or "BRWxxxxxxxxxxx" for a wireless network (where "xxxxxxxxxxx" is your machine's MAC address / ethernet address.)

## Open System

Open System is one of the network authentication methods. Under open system authentication, any wireless devices are allowed to access the network without requiring a WEP key.

## PEAP

Protected Extensible Authentication Protocol (PEAP) is a version of EAP method developed by Cisco Systems, Inc., Microsoft® Corporation and RSA Security. PEAP creates an encrypted Secure Sockets Layer (SSL)/Transport Layer Security (TLS) tunnel between a client and an authentication server, for sending a user ID and password. PEAP provides mutual authentication between the server and the client.

The Brother machine supports the following inner authentications:

- PEAP/MS-CHAPv2
- PEAP/GTC

## Peer-to-Peer

Peer-to-Peer is a type of printing in a peer-to-peer environment. In a peer-to-peer environment, each computer sends and receives data directly to and from each device. There is no central server controlling access or machine sharing.

## Protocols

Protocols are the standardized sets of rules for transmitting data on a network. Protocols allow users to gain access to network-connected resources. The print server used on your Brother machine supports the Transmission Control Protocol/Internet Protocol (TCP/IP) protocol.

## Public Key Cryptosystem

A Public Key Cryptosystem is a modern branch of cryptography in which the algorithms employ a pair of keys (a public key and a private key) and use a different component of the pair for different steps of the algorithm.

## RARP

Reverse Address Resolution Protocol (RARP) finds the logical address for a machine that knows only its physical address.



To use RARP, contact your network administrator.

## Resolution

The number of vertical and horizontal lines per inch.

## Secure Function Lock 3.0

Secure Function Lock 3.0 increases security by restricting the use of functions.

## Settings Tables

At-a-glance instructions that show all the settings and options that are available for setting up your machine.

## Shared Key Cryptosystem

A Shared Key Cryptosystem is a branch of cryptography involving algorithms that use the same key for two different steps of the algorithm (such as encryption and decryption).

## SMTP Client

Simple Mail Transfer Protocol (SMTP) client is used to send emails via the Internet or Intranet.

## SMTP over SSL

SMTP over SSL feature enables sending encrypted email using SSL.

## SMTP-AUTH

SMTP Authentication (SMTP-AUTH) expands SMTP (the Internet email sending protocol) to include an authentication method that ensures the true identity of the sender is known.

## SNMP

The Simple Network Management Protocol (SNMP) is used to manage network devices including computers, routers and Brother network-ready machines. The Brother print server supports SNMPv1, SNMPv2c and SNMPv3.

## SNMPv3

Simple Network Management Protocol version 3 (SNMPv3) provides user authentication and data encryption to manage network devices securely.

## SNTP

The Simple Network Time Protocol (SNTP) is used to synchronize computer clocks on a TCP/IP network. You can configure the SNTP settings using Web Based Management.

## SSID

Each wireless network has its own unique network name and it is technically referred to as a Service Set Identifier (SSID). The SSID is a 32-byte or less value and is assigned to the access point. The wireless network devices you want to associate to the wireless network should match the access point. The access point and wireless network devices regularly send wireless packets (referred to as beacons), which contain the SSID

information. When your wireless network device receives a beacon, you can identify the wireless network that is close enough for the radio waves to reach your device.

## SSL/TLS

Secure Socket Layer (SSL) or Transport Layer Security (TLS) is an effective method of protecting data that is sent over a local or wide area network. SSL/TLS works by encrypting data, such as a print job, sent over a network, so anyone trying to capture it will not be able to read it .

SSL/TLS can be configured on both wired and wireless networks and will work with other forms of security including WPA keys and firewalls.

## Status Monitor

The Status Monitor utility is a configurable utility to monitor the status of one or more devices, allowing you to get immediate notification when there is a problem, for example, when the machine runs out of paper or jams.

## Store Print Log to Network

The Store Print Log to Network feature allows you to save the print log file from your Brother machine to a network server using CIFS.

## Subnet Mask

A subnet mask allows you to identify which part of an IP address is used as the network address and which part is used as the host address.

In the following example, the last segment of the IP address is known as the host address and the first three segments are the network address.

Example: Computer 1 can talk to Computer 2

- Computer 1  
IP Address: 192.168.1.2  
Subnet Mask: 255.255.255.0
- Computer 2  
IP Address: 192.168.1.3  
Subnet Mask: 255.255.255.0



0 denotes that there is no limit to communication at this part of the address.

## TCP/IP

Transmission Control Protocol/Internet Protocol (TCP/IP) is the most popular set of protocols used for communication, such as Internet and email. This protocol can be used in almost all operating systems, including Windows®, Windows Server®, OS X and Linux®.

## TELNET

The TELNET protocol allows you to control the remote network devices on a TCP/IP network from your computer.



## TKIP

Temporal Key Integrity Protocol (TKIP) is one of the encryption methods adopted by WPA™ to be used in a wireless network. TKIP provides per-packet key mixing, a message integrity check and rekeying mechanism.

## Vertical Pairing

Vertical Pairing is a technology for Windows® that allows your Vertical Pairing-supported wireless machine to connect to your Infrastructure network using the PIN Method of Wi-Fi Protected Setup™ and the Web Services feature. It also enables printer driver installation from the printer icon in the **Add a device** screen.

## Web Based Management

A standard Web Browser can be used to manage your machine using the Hyper Text Transfer Protocol (HTTP) or Hyper Text Transfer Protocol over Secure Socket Layer (HTTPS). You can perform the function listed or get the following information from a machine on your network using a web browser:

- Machine status information
- Change network settings, such as TCP/IP information
- Configure Gigabit Ethernet
- Configure Secure Function Lock 3.0
- Configure Store Print Log to Network
- Configure LDAP
- Software version information of the machine and print server
- Change network and machine configuration details



To use Web Based Management, you must use the TCP/IP protocol on your network and have a valid IP address programmed into the print server and your computer.

## Web Services

The Web Services protocol enables Windows Vista®, Windows® 7, or Windows® 8 users to install the drivers used for printing by right-clicking on the machine icon in the **Network** folder. Web Services also lets you check the current status of the machine from your computer.

## WEP

Wired Equivalent Privacy (WEP) is one of the encryption methods used in a wireless network. When using WEP, the data is transmitted and received with a secure key.

## Wi-Fi Direct®

Wi-Fi Direct is one of the wireless configuration methods developed by the Wi-Fi Alliance®. This type of connection is a Wi-Fi standard that allows devices to connect with each other without a wireless access point, using secured method.

## WINS

Windows® Internet Name Service (WINS) is an information-providing service for NetBIOS name resolution. It consolidates an IP address and a NetBIOS name that is in the local network.

## WINS Server

Windows® Internet Name Service (WINS) Server maps IP addresses to computer names (NetBIOS names) in a Windows® network.

## WLAN Report

The WLAN Report prints your machine's wireless status report. If the wireless connection fails, check the error code on the printed report.

## WPA-PSK/WPA2-PSK Authentication Method

WPA-PSK/WPA2-PSK authentication method enables a Wi-Fi Protected Access® Pre-shared key (WPA-PSK/WPA2-PSK), which enables the Brother wireless machine to associate with access points using TKIP for WPA-PSK or AES for WPA-PSK and WPA2-PSK (WPA-Personal).

## WPS

Wi-Fi Protected Setup™ (WPS) is a standard that allows the setup of secured wireless networks. WPS was created by the Wi-Fi Alliance® in 2007.

Brother International Corporation  
200 Crossing Boulevard  
P.O. Box 6911  
Bridgewater, NJ 08807-0911 USA

Brother International Corporation (Canada) Ltd.  
1 rue Hôtel de Ville,  
Dollard-des-Ormeaux, QC, Canada H9B 3H6

**brother**

**Visit us on the World Wide Web**  
[www.brother.com](http://www.brother.com)

These machines are approved for use in the country of purchase only. Local Brother companies or their dealers will support only machines purchased in their own countries.



USA/CAN  
Version A

## Free Manuals Download Website

<http://myh66.com>

<http://usermanuals.us>

<http://www.somanuals.com>

<http://www.4manuals.cc>

<http://www.manual-lib.com>

<http://www.404manual.com>

<http://www.luxmanual.com>

<http://aubethermostatmanual.com>

Golf course search by state

<http://golfingnear.com>

Email search by domain

<http://emailbydomain.com>

Auto manuals search

<http://auto.somanuals.com>

TV manuals search

<http://tv.somanuals.com>