

Product Safety Guide

HL-L2350DW / HL-L2370DW / HL-L2370DWXL / HL-L2390DW /
DCP-L2550DW / HL-L2395DW / MFC-L2690DW / MFC-L2690DWXL /
MFC-L2710DW / MFC-L2717DW / MFC-L2730DW / MFC-L2750DW /
MFC-L2750DWXL

Brother Industries, Ltd.
15-1, Naeshiro-cho, Mizuho-ku, Nagoya 467-8561, Japan

Read this guide before attempting to operate the product, or before attempting any maintenance. Failure to follow these instructions may result in an increased risk of personal injury or damage to property, including through fire, electrical shock, burns or suffocation. Brother shall not be liable for damage caused where the product owner has failed to follow instructions set out in this guide.

How to use this guide:

1. Read the whole guide before using your product and keep it for later reference.
2. Carefully follow the instructions set out in this guide and always ensure that you follow all warnings and instructions marked on the product.
3. If you have concerns about how to use your product after reading this guide, contact Brother customer service or your local Brother dealer.
4. To ensure you understand all of the instructions, study the Symbols and Conventions used in the documentation.

NOTE

For more advanced instructions, information, and product specifications, see the *Online User's Guide* at support.brother.com/manuals

Symbols and Conventions Used in the Documentation

The following symbols and conventions are used throughout the documentation.

Follow all warnings and instructions marked on the product.

WARNING

WARNING indicates a potentially hazardous situation which, if not avoided, could result in death or serious injuries.

CAUTION

CAUTION indicates a potentially hazardous situation which, if not avoided, may result in minor or moderate injuries.

IMPORTANT

IMPORTANT indicates a potentially hazardous situation which, if not avoided, may result in damage to property or loss of product functionality.

NOTE

NOTE specifies the operating environment, conditions for installation, or special conditions of use.



Electrical Hazard icons alert you to possible electrical shock.



Fire Hazard icons alert you to the possibility of a fire.



Hot Surface icons warn you not to touch product parts that are hot.



Prohibition icons indicate actions that must not be performed.

Bold

Bold typeface identifies specific keys on the product's control panel or on the computer screen.

Italics

Italicized style emphasizes an important point or refers you to a related topic.

Courier New

Text in Courier New font identifies messages on the LCD of the product.

NOTE

- Not all models are available in all countries.
 - The illustrations in this guide show the HL-L2370DW/MFC-L2750DW.
-

Compilation and Publication Notice

Under the supervision of Brother Industries, Ltd., this product's manuals have been compiled and published, covering the latest product descriptions and specifications.

The contents of all manuals and the specifications of this product are subject to change without notice.

Brother reserves the right to make changes without notice in the specifications and materials contained herein and shall not be responsible for any damages (including consequential)

caused by reliance on the materials presented, including but not limited to typographical and other errors relating to the publication.

Choose a Safe Location for Your Product

WARNING

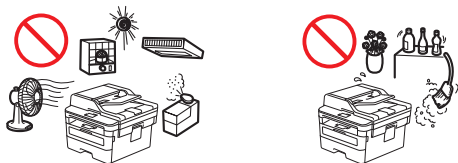

Choose a location where the temperature remains between 50°F and 90°F (10°C and 32°C), the humidity is between 20% and 80%, and where there is no condensation.



DO NOT place the product near heaters, air conditioners, electrical fans, refrigerators, or water. Doing so may create the risk of an electrical shock, short circuit, or fire, as water may come into contact with the product (including condensation caused by heating/air conditioning/ventilation equipment).

DO NOT allow this product to come into contact with water. This product should not be used around standing water, including a bathtub, sink, or swimming pool; around appliances containing water, including a refrigerator; or in a wet basement.



DO NOT expose the product to direct sunlight, excessive heat, open flames, corrosive gasses, moisture, or dust. Doing so may create a risk of an electrical shock, short circuit, or fire, causing damage to the product and/or rendering it inoperable.



DO NOT place the product near chemicals or in a place where chemicals could be spilled on it. Should chemicals come into contact with the product, there may be a risk of fire or electrical shock. In particular, organic solvents or liquids such as benzene, paint thinner, polish remover, or deodorizer may melt or dissolve the plastic cover and/or cables, resulting in a risk of fire or electrical shock. These or other chemicals may cause the product to malfunction or become discolored.



DO NOT put the product in a location that blocks or obstructs any slot or opening in the product. These slots and openings are provided for ventilation. Blocking the machine's ventilation could create a risk of overheating and/or fire.

Instead:

- Keep a minimum gap around the product as shown in the illustration.

Products without scanning function

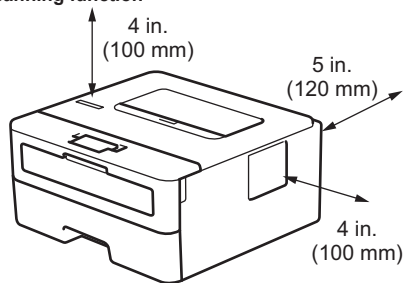

Products with scanning function

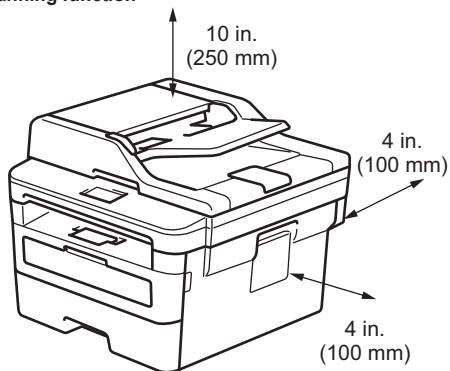

- Place the product on a solid level surface.
- DO NOT place this product near or over a radiator or heater.
- DO NOT place this product in any installation unless adequate ventilation is provided.

CAUTION

Put your product on a flat, level, stable surface (such as a desk), that is free from vibration and shocks. Put the product near a telephone wall jack (MFC models only) and a standard grounded AC power outlet.

DO NOT place this product on an unstable cart, stand, or table, particularly if children are expected to be near the product. The product is heavy and may fall, causing injury to you or others and serious damage to the product. For the products with scanning functionality, there is an added risk of injury if the scanner glass should break.

Avoid placing your product in a busy area. If you must place it in a busy area, ensure that the product is in a safe location where it cannot be accidentally knocked over, which could cause injury to you or others and serious damage to the product.

Ensure that cables and cords leading to the product are secured so as not to pose a tripping hazard.

DO NOT place heavy objects on the product.

DO NOT place any objects around the product. Such objects block the access to the power outlet in case of emergency. It is important that the product can be unplugged whenever needed.

The product may generate odorous gas such as ozone if used for a large volume of printing or used in a poorly ventilated room for multiple hours. In addition, the product emits some chemical substances during the printing process. Ensure adequate ventilation for the product to avoid injury or discomfort.

IMPORTANT

- DO NOT place your product next to devices that contain magnets or generate magnetic fields. Doing so may interfere with the operation of the product, causing print quality problems.
 - DO NOT place your product next to sources of interference, such as speakers or the base units of non-Brother cordless telephones. Doing so may interfere with the operation of the product's electronic components.
-

Connect the Product Safely

WARNING



ELECTRICAL HAZARDS

Failure to follow the warnings in this section may create the risk of an electrical shock. In addition, you could create an electrical short, which may create the risk of a fire.



There are high-voltage electrodes inside the product. Before you access the inside of the product, including for routine maintenance such as cleaning, make sure you have unplugged the telephone line cord first (MFC models only) and then the power cord from the AC power outlet, as well as any telephone/RJ-11 (MFC models only) or Ethernet/RJ-45 cables (Network models only) from the product.

DO NOT push objects of any kind into this product through slots or openings in the product, as they may touch dangerous voltage points or short-out parts.

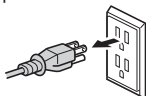

DO NOT handle the plug with wet hands. Doing this might cause an electrical shock.



Always make sure the plug is fully inserted. DO NOT use the product or handle the cord if the cord has become worn or frayed.



Unplug the power plug regularly to clean it. Use a dry cloth to clean the root of the plug blades and between the blades. If the power plug is plugged into the outlet over a long period, dust accumulates around the plug blades, which may cause a short circuit, resulting in a fire.



DO NOT dismantle this product. Dismantling this product could cause a fire or electrical shock.

DO NOT attempt to service this product yourself. Opening or removing covers may expose you to dangerous voltage points and other risks and may void your warranty. Refer all servicing to Brother Authorized Service Center.



DO NOT drop any metallic hardware or any type of liquid on the power plug of the product. It may cause an electrical shock or a fire.



If water, other liquids, or metal objects get inside the product, immediately unplug the product from the AC power outlet and contact Brother Authorized Service Personnel.



This product should be connected to an AC power source within the range indicated on the rating label (You can find the rating label on your machine). DO NOT connect it to a DC power source or inverter. If you are not sure what kind of power source you have, contact a qualified electrician.

Use the Product Safely

WARNING

ELECTRICAL HAZARDS

Failure to follow the warnings in this section may create the risk of an electrical shock. In addition, you could cause an electrical short, which may lead to a fire.



If the product has been dropped or the casing has been damaged, there may be the possibility of an electrical shock. Unplug the product from the AC power outlet and contact Brother Authorized Service Personnel.



DO NOT use this product during a thunderstorm. There may be a remote risk of an electrical shock from lightning.



DO NOT put toner cartridges or a toner cartridge and drum unit assembly into a fire or places susceptible to fire. It could explode, resulting in injuries.

FIRE HAZARDS

Failure to follow the warnings in this section may create the risk of a fire.



DO NOT use flammable substances, any type of spray, or an organic solvent/liquid containing alcohol or ammonia to clean the inside or outside of the product. Doing so could cause a fire. Instead, use only a dry, lint-free cloth. For instructions on how to clean the product, see the *Online User's Guide*.

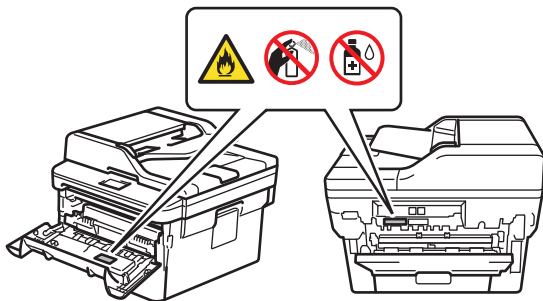

DO NOT attempt to operate this product when a paper jam or stray pieces of paper are inside the product. Prolonged contact of paper with the fuser unit could cause a fire.



DO NOT use a vacuum cleaner to clean up scattered toner. Doing this might cause the toner dust to ignite inside the vacuum cleaner, potentially starting a fire. Carefully clean the toner dust with a dry, lint-free soft cloth and dispose of it according to local regulations.

(Models with Wireless LAN function only)

DO NOT use the product near any medical electrical equipment. The radio waves emitted from the product may affect medical electrical equipment and cause a malfunction, which may result in accident or injury.

For users with pacemakers:

This product generates a weak magnetic field. If you feel anything wrong with the operation of your pacemaker when near the product, move away from the product and consult a doctor immediately.



DO NOT place the following objects on the product.

If these objects contact the electrical parts inside the product, it may cause a fire or electrical shock.

- Metal objects such as a clip or a staple
 - Precious metals such as a necklace or a ring
 - Containers holding water or liquid such as a glass, a flower vase, or a flower pot
-

HOT SURFACE

Immediately after using the product, some internal parts of the product will be extremely hot. Wait at least 10 minutes for the product to cool down before you touch the internal parts of the product.

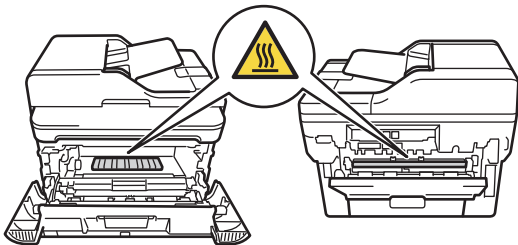

If the product becomes unusually hot, releases smoke, generates any strong smells, or if you accidentally spill any liquid on it, immediately unplug the product from the AC power outlet. Contact Brother Authorized Service Personnel.

Plastic bags are used in the packing of this product. Plastic bags are not toys. To avoid the danger of suffocation, keep these bags away from babies and children, and dispose of them properly.



(MFC models only)

Use caution when installing or modifying telephone lines. Never touch telephone wires or terminals that are not insulated unless the telephone line has been unplugged from the wall jack.

Never install telephone wiring during a thunderstorm. Never install a telephone wall jack in a location that is wet or may become wet, for example, near a refrigerator or other appliance that produces condensation.



Power Cord Safety:

- This product is equipped with a grounded plug. This plug will only fit into a grounded power outlet. This is a safety feature. If you are unable to insert the plug into the outlet, call your electrician to replace your obsolete outlet. DO NOT attempt to defeat the purpose of the grounded plug.
 - DO NOT allow anything to rest on the power cord.
 - DO NOT place this product where people might step on the cord.
 - DO NOT place this product in a position where the cord is stretched or strained, as it may become worn or frayed.
 - DO NOT use the product if the power cord is frayed or damaged. Doing so may cause an electrical shock or fire.
 - DO NOT pull on the middle of the AC power cord; pulling on the middle may cause the cord to separate from the plug. Doing this might cause an electrical shock.
 - DO NOT use any undesignated cables (or optional devices). Doing so may cause a fire or injuries. Installation must be performed properly according to the user's guide.
 - Brother strongly recommends that you DO NOT use any type of extension cord.
 - This product should be positioned so that nothing pinches or constricts the power cord.
 - DO NOT use any cable that does not meet the applicable cable specifications described in the *Quick Setup Guide*. Doing so may cause a fire or injuries. If the power cord is provided with this product, use ONLY the provided cord. Installation must be performed correctly as described in the *Quick Setup Guide*.
-

CAUTION

When you move the product, carry the product as shown in the illustration.

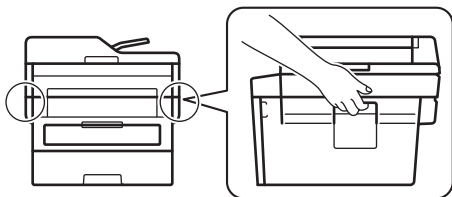

(Products with scanning function only)

To prevent injuries, be careful not to put your fingers in the areas shown in the illustrations.

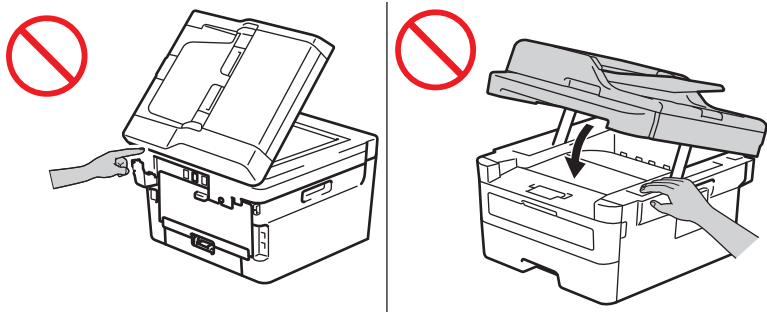

For your safety, unplug the product from the power outlet when it is not used for a long time.

When multiple devices, including this product, are connected to a computer using USB cables, you may feel an electric charge when you touch metal parts of the product.

Some products and/or their cartons contain a silica gel pack. **DO NOT** eat the silica gel pack; throw it away. If you ingest it, seek medical attention immediately.

DO NOT try to open a toner cartridge. If the toner powder leaks out, avoid inhaling it or letting it come in contact with your skin.

Keep toner cartridges out of the reach of children. If a child swallows the toner powder, consult a doctor immediately.

We recommend placing the toner cartridge and drum unit assembly on a clean, flat surface with disposable paper underneath it in case you accidentally spill or scatter toner. If toner scatters on your hands or clothes, immediately wipe or wash it off with cold water.

Should you come into contact with toner, follow these instructions:

- **Inhalation**

Obtain immediate medical attention. In case of accidental inhalation, move to fresh air immediately, then obtain medical attention.

- **Skin contact**

Remove contaminated clothing immediately and wash affected skin with plenty of water or soap and water.

- **Eye contact**

Obtain medical attention. If the toner has gotten into the eyes, immediately wash out the eyes with water continuously, for at least 15 minutes.

- **Ingestion**

Obtain immediate medical attention. Wash out mouth with water and drink 200 - 300 ml (one cup) of water.

DO NOT run your hand over the edge of the paper. The thin and sharp edges of the paper may cause an injury.

IMPORTANT

- A distinct change in the product's performance may indicate a need for service.
- DO NOT connect your product to an AC power outlet controlled by wall switches or automatic timers, or to the same circuit as a large appliance or other equipment that requires a significant amount of electricity. It could disrupt the power supply. Disruption of the power supply may also delete information from the product's memory, and repeated cycling of the power supply can damage the product.
- We recommend that you use our genuine toner cartridges to replace cartridges that come with the device. Non-genuine toner cartridges may cause damage to the machine. They may also result in differences in storage stability. (Not all non-genuine toner cartridges cause these issues.)
- DO NOT remove or damage any of the caution or warning labels inside the product.

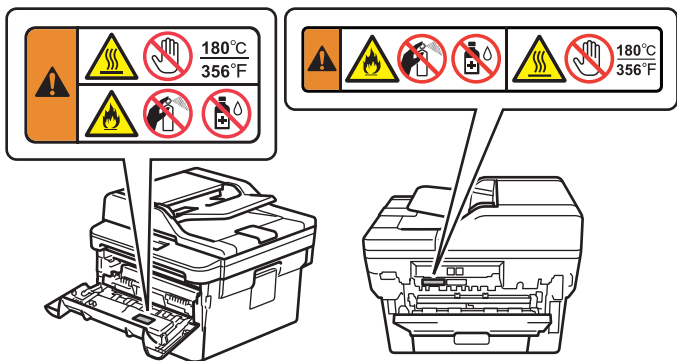

- DO NOT put objects on top of the product. Doing so may cause the product to malfunction.

Important Safety Instructions

DO NOT attempt to service this product yourself because opening or removing covers may expose you to dangerous voltage points and other risks and may void your warranty. Refer all servicing to a Brother Authorized Service Center.

1. Read all of these instructions.
2. Save these instructions for later reference.
3. Follow all warnings and instructions marked on the product.
4. Unplug this product from the AC power outlet and refer all servicing to Brother Authorized Service Personnel under the following conditions:
 - If liquid has been spilled into the product.
 - If the product has been exposed to rain or water.
 - If the product does not operate normally when the operating instructions are followed. Adjust only those controls that are discussed in the operating instructions. Improper adjustment of other controls may result in damage and will often require extensive work by a qualified technician to restore the product to normal operation.
 - If the product exhibits a distinct change in performance, indicating a need for service.
5. For the location of your nearest Brother Authorized Service Center, contact:

In USA: 1-877-BROTHER (1-877-276-8437)

In Canada: www.brother.ca/support

Regulations

WARNING



(MFC models only)

When using your telephone equipment, basic safety precautions should always be followed to reduce the risk of fire, electrical shock, and injury to people. These important safety precautions include the following:

1. DO NOT use this product near water or locations that may become wet, for example, near a bathtub, wash bowl, kitchen sink or washing machine, in a wet basement, or near a swimming pool.
2. Avoid using this product during a thunderstorm. There may be a remote risk of an electrical shock from lightning.
3. DO NOT use this product to report a gas leak in the vicinity of the leak.
4. Use only the power cord provided with the product (if included in the box).

Read all of the instructions. Save them for later reference.



(MFC models only)

To reduce the risk of fire, electrical shock, and injury to people;

- Use only a No. 26 AWG or larger telecommunication line cord.
-



Disconnect device

This product must be installed near an AC power outlet that is easily accessible. In case of an emergency, you must unplug the power cord from the AC power outlet to shut off the power completely.

IMPORTANT

This product has been certified to comply with FCC standards, which are applied to the USA only.

Standard Telephone and FCC Notices (MFC Models Only)

These notices are in effect on models sold and used in the United States only.

When programming emergency numbers or making test calls to emergency numbers:

- Remain on the line and briefly explain to the dispatcher the reason for the call before hanging up.
- Perform these activities in the off-peak hours, such as early morning or late evening.

This equipment complies with Part 68 of the FCC rules and the requirements adopted by the ACTA. On the back side of this equipment is a label that contains, among other information, a product identifier in the format US:AAAEQ##TXXXX. If requested, this number must be provided to the telephone company.

You may safely connect this equipment to the telephone line by means of a standard modular jack, USOC RJ11C.

A plug and jack used to connect this equipment to the premises wiring and telephone network must comply with the applicable FCC Part 68 rules and requirements adopted by the ACTA. A compliant telephone cord and modular plug is provided with this product. It is designed to be connected to a compatible modular jack that is also compliant. See installation instructions for details.

The Ringer Equivalence Number (REN) is used to determine the number of devices that may be connected to a telephone line. Excessive RENs on a telephone line may result in the devices not ringing in response to an incoming call. In most but not all areas, the sum of RENs should not exceed five (5.0). To be certain of the number of devices that may be connected to a line, as determined by the total RENs, contact the local telephone company. For products approved after July 23, 2001, the REN for this product is part of the product identifier that has the format US:AAAEQ##TXXXX. The digits represented by ## are the REN without a decimal point (e.g., 06 is a REN of 0.6). For earlier products, the REN is separately shown on the label.

If this equipment causes harm to the telephone network, the telephone company will notify you in advance that temporary discontinuance of service may be required. But if advance notice is not practical, the telephone company will notify you as soon as possible. Also, you will be advised of your right to file a complaint with the FCC if you believe it is necessary.

The telephone company may make changes in its facilities, equipment, operations, or procedures that could affect the operation of the equipment. If this happens, the telephone company will provide advance notice in order for you to make necessary modifications to maintain uninterrupted service.

If trouble is experienced with this equipment, for repair or warranty information, contact Brother Customer Service (see the *Online User's Guide: Brother Numbers*). If the equipment is causing harm to the telephone network, the telephone company may request that you disconnect the equipment until the problem is resolved.

Connection to party line service is subject to state tariffs. Contact the state public utility commission, public service commission or corporation commission for information.

If your home has specially wired alarm equipment connected to the telephone line, ensure the installation of this equipment does not disable your alarm equipment. If you have questions about what will disable the alarm equipment, call your telephone company or a qualified installer.

The Telephone Consumer Protection Act of 1991 makes it unlawful for any person to use a computer or electronic device to send any message via a telephone fax machine unless such messages clearly contain, in a margin at the top or bottom of each transmitted page, or on the first page of the transmission, the date and time it is sent and an identification of the business or

other entity or other individual sending the message and the telephone number of the sending machine or such business, other entity or individual. To program this information into your machine, see the *Quick Setup Guide: Set the date and time* and *Set the Station ID*.

If you are not able to solve a problem with your product, contact Brother Customer Service (see the *Online User's Guide: Brother Numbers*).

WARNING



For protection against the risk of electrical shock, always disconnect all cables from the wall outlet before the equipment is installed, serviced, or modified.

IMPORTANT

- This equipment may not be used on coin service lines provided by the telephone company or connected to party lines.
- Brother cannot accept any financial or other responsibilities that may be the result of your use of this information, including direct, special, or consequential damages. There are no warranties extended or granted by this document.
- A grounded plug should be plugged into a grounded AC power outlet after checking the rating of the local power supply for the product to operate properly and safely.

Federal Communications Commission (FCC) Declaration of Conformity (USA Only)

Responsible Party: Brother International Corporation
200 Crossing Boulevard
Bridgewater, NJ 08807-0911 USA
TEL: (908) 704-1700

declares, that the products

Product Name: Mono Laser Printer

Model Numbers: HL-L2350DW/HL-L2370DW/HL-L2370DWXL

Product Name: Multi Function Printer

Model Numbers: HL-L2390DW/DCP-L2550DW/HL-L2395DW/MFC-L2690DW/
MFC-L2690DWXL/MFC-L2710DW/MFC-L2717DW/MFC-L2730DW/MFC-L2750DW/
MFC-L2750DWXL

comply with Part 15 of the FCC Rules. Operation is subject to the following two conditions:

(1) This device may not cause harmful interference, and (2) this device must accept any interference received, including interference that may cause undesired operation.

This equipment has been tested and found to comply with the limits for a Class B digital device, pursuant to Part 15 of the FCC Rules. These limits are designed to provide reasonable protection against harmful interference in a residential installation. This equipment generates, uses, and can radiate radio frequency energy and, if not installed and used in accordance with the instructions, may cause harmful interference to radio communications. However, there is no guarantee that interference will not occur in a particular installation. If this equipment does cause harmful interference to radio or television reception, which can be determined by turning the equipment off and on, the user is encouraged to try to correct the interference by one or more of the following measures:

- Reorient or relocate the receiving antenna.
- Increase the separation between the equipment and receiver.
- Connect the equipment to an outlet on a circuit different from that to which the receiver is connected.
- Consult with an experienced radio/TV technician for help.
- (Wireless network models only)
This transmitter must not be co-located or operated in conjunction with any other antenna or transmitter.

IMPORTANT

- Changes or modifications not expressly approved by Brother Industries, Ltd. could void the user's authority to operate the equipment.
 - A shielded interface cable should be used to ensure compliance with the limits for a Class B digital device.
-

RF Exposure Notice (USA or Canada Only) (Wireless Models Only)

This equipment complies with FCC/IC radiation exposure limits set forth for an uncontrolled environment and meets the FCC radio frequency (RF) Exposure Guidelines and RSS-102 of the IC radio frequency (RF) Exposure rules. This equipment should be installed and operated keeping the radiator at least 20 cm or more away from a person's body.

Cet équipement est conforme aux limites d'exposition aux rayonnements énoncées pour un environnement non contrôlé et respecte les lignes directrices d'exposition aux fréquences radioélectriques (RF) de la FCC et les règles d'exposition aux fréquences radioélectriques (RF) CNR-102 de l'IC. Cet équipement doit être installé et utilisé en gardant une distance de 20 cm ou plus entre le radiateur et le corps humain.

Wireless Connection (Mexico Only) (Wireless Models Only)

The operation of this equipment is subject to the following two conditions:

(1) it is possible that this equipment or device may not cause harmful interference, and (2) this equipment or device must accept any interference, including interference that may cause undesired operation.

La operación de este equipo está sujeta a las siguientes dos condiciones:

(1) es posible que este equipo o dispositivo no cause interferencia perjudicial y (2) este equipo o dispositivo debe aceptar cualquier interferencia, incluyendo la que pueda causar su operación no deseada.

Industry Canada Compliance Statement (Canada Only)

This device complies with Industry Canada's licence-exempt RSSs. Operation is subject to the following two conditions:

(1) this device may not cause interference, and (2) this device must accept any interference, including interference that may cause undesired operation of the device.

Le présent appareil est conforme aux CNR d'Industrie Canada applicables aux appareils radio exempts de licence. L'exploitation est autorisée aux deux conditions suivantes:

(1) l'appareil ne doit pas produire de brouillage, et (2) l'utilisateur de l'appareil doit accepter tout brouillage radioélectrique subi, même si le brouillage est susceptible d'en compromettre le fonctionnement.

EQUIPMENT ATTACHMENT LIMITATIONS (Canada Only) (MFC Models Only)

NOTICE

This product meets the applicable Innovation, Science and Economic Development Canada technical specifications.

Le présent produit est conforme aux spécifications techniques applicables d'Innovation, Sciences et Développement économique Canada.

NOTICE

The Ringer Equivalence Number (REN) indicates the maximum number of devices allowed to be connected to a telephone interface. The termination of an interface may consist of any combination of devices subject only to the requirement that the sum of the RENs of all the devices not exceed five.

L'indice d'équivalence de la sonnerie (IES) sert à indiquer le nombre maximal de dispositifs qui peuvent être raccordés à une interface téléphonique. La terminaison d'une interface peut consister en une combinaison quelconque de dispositifs, à la seule condition que la somme des IES de tous les dispositifs n'excède pas cinq.

Laser Safety (for 110-120V Models Only)

This equipment is certified as a Class 1 laser product as defined in IEC60825-1:2007 specifications under the U.S. Department of Health and Human Services (DHHS) Radiation

Performance Standard according to the Radiation Control for Health and Safety Act of 1968. This means that the equipment does not produce hazardous laser radiation.

Since radiation emitted inside the equipment is completely confined within protective housings and external covers, the laser beam cannot escape from the product during any phase of user operation.

FDA Regulations (for 110-120V Models Only)

U.S. Food and Drug Administration (FDA) has implemented regulations for laser products manufactured on or after August 2, 1976. Compliance is mandatory for products marketed in the United States. One of the following labels on the back of the product indicates compliance with the FDA regulations and must be attached to laser products marketed in the United States.

Manufactured:

BROTHER INDUSTRIES (VIETNAM) LTD.

Phuc Dien Industrial Zone Cam Phuc Commune, Cam Giang District Hai Duong Province, Vietnam

This product complies with FDA performance standards for laser products except for deviations pursuant to Laser Notice No. 50, dated June 24, 2007.

WARNING

Use of controls, adjustments, or performance of procedures other than those specified in this manual may result in hazardous invisible radiation exposure.

Internal laser radiation:

Max. Radiation Power: 25 mW

Wave Length: 770 - 800 nm

Laser Class: Class 3B

For Use in the USA or Canada Only

These products are made for use in the USA and Canada only. We cannot recommend using them overseas because it may violate the Telecommunications Regulations (MFC models only) of that country and the power requirements of your product may not be compatible with the power available in foreign countries. Using USA or Canada models overseas is at your own risk and may void your warranty.

LAN Connection (Models with Wired LAN Function Only)

CAUTION

DO NOT connect this product to a LAN connection that is subject to over-voltages.

International ENERGY STAR® Qualification Statement

The purpose of the International ENERGY STAR® Program is to promote the development and popularization of energy-efficient office equipment.

As an ENERGY STAR® Partner, Brother Industries, Ltd. has determined that this product meets the ENERGY STAR® specifications for energy efficiency.



Trademarks

BROTHER is either a trademark or a registered trademark of Brother Industries, Ltd.

Microsoft and Windows are registered trademarks of Microsoft Corporation in the United States and/or other countries.

Apple, AirPrint, the AirPrint logo, Macintosh, and Mac are trademarks of Apple Inc., registered in the U.S. and other countries.

App Store is a service mark of Apple Inc.

Wi-Fi is a registered trademark of Wi-Fi Alliance®.

Android is a trademark of Google Inc.

Google Play is a trademark of Google Inc.

Mopria® and the Mopria® Logo are registered trademarks and service marks of Mopria Alliance, Inc. in the United States and other countries. Unauthorized use is strictly prohibited.

Each company whose software title is mentioned in this manual has a Software License Agreement specific to its proprietary programs.

Software Trademarks

FlashFX® is a registered trademark of Datalight, Inc.

FlashFX® Pro™ is a trademark of Datalight, Inc.

FlashFX® Tera™ is a trademark of Datalight, Inc.

Reliance™ is a trademark of Datalight, Inc.

Reliance Nitro™ is a trademark of Datalight, Inc.

Datalight® is a registered trademark of Datalight, Inc.

Any trade names and product names of companies appearing on Brother products, related documents and any other materials are all trademarks or registered trademarks of those respective companies.

Open Source Licensing Remarks

This product includes open-source software.

Go to the manual download selection of your model's home page of Brother Solutions Center at support.brother.com to view the Open Source Licensing Remarks and Copyright Information.

Copyright and License

©2019 Brother Industries, Ltd. All rights reserved.

This product includes software developed by the following vendors:

©1983-1998 PACIFIC SOFTWARES, INC. ALL RIGHTS RESERVED.

©2008 Devicescape Software, Inc. All rights reserved.

This product includes the "KASAGO TCP/IP" software developed by ZUKEN ELMIC, Inc.

Copyright 1989-2014 Datalight, Inc., All Rights Reserved.

FlashFX® Copyright 1998-2014 Datalight, Inc.

U.S. Patent Office 5,860,082/6,260,156

Legal Limitations for Copying (Products with Scanning Function Only)

Reproductions of certain documents are illegal and may result in either criminal or civil liability.

The listing below is intended to be a guide rather than a complete listing of every possible prohibition. In case of doubt, we suggest that you consult with the appropriate authority or advisor with regard to the specific document.

The following documents issued by the United States/Canadian Government or any of its Agencies, States, Territories, or Provinces may not be copied.

- Money
- Bonds or other certificates of indebtedness
- Certificates of Deposit
- Internal Revenue Stamps (canceled or uncanceled)
- Selective Service or draft papers
- Passports
- United States/Canadian Postage Stamps (canceled or uncanceled)
- Food Stamps
- Immigration Papers
- Checks or drafts drawn by Governmental agencies
- Identifying badges or insignias
- Licenses and Certificates of Title to motor vehicles, under certain State/Provincial law

Copying copyrighted works may be regulated by Federal, State, or local law. For more information, consult an appropriate authority or advisor.

brother

These machines are approved for use in the country of purchase only. Local Brother companies or their dealers will support only machines purchased in their own countries.

Month of publication: 11/2019



D01EPX001-00
USA/CAN
Version C

Free Manuals Download Website

<http://myh66.com>

<http://usermanuals.us>

<http://www.somanuals.com>

<http://www.4manuals.cc>

<http://www.manual-lib.com>

<http://www.404manual.com>

<http://www.luxmanual.com>

<http://aubethermostatmanual.com>

Golf course search by state

<http://golfingnear.com>

Email search by domain

<http://emailbydomain.com>

Auto manuals search

<http://auto.somanuals.com>

TV manuals search

<http://tv.somanuals.com>