

HL-2035

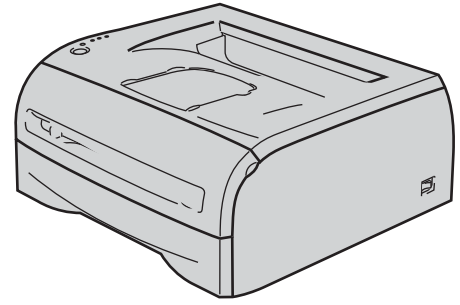

Laser Printer

Quick Setup Guide

Before you can use the printer, you must set up the hardware and install the driver. Please read this 'Quick Setup Guide' for proper set up and installation instructions.

STEP 1

Setting Up the Machine



STEP 2

Installing the Printer Driver

Setup is Complete!









How to use the printer, see the User's Guide on the CD-ROM.

Keep this 'Quick Setup Guide' and the supplied CD-ROM in a convenient place for quick and easy reference at all times.



Symbols used in this guide

 Warning	 Electrical Hazard	 Hot Surface	 Caution
<p>Warnings tell you what to do to prevent possible personal injury.</p>	<p>Electrical Hazard icons alert you to a possible electrical shock.</p>	<p>Hot Surface icons warn you not to touch machine parts that are hot.</p>	<p>Cautions specify procedures you must follow or avoid to prevent possible damage to the printer or other objects.</p>
 Improper Setup	 Note	 User's Guide	
<p>Improper Setup icons alert you to devices and operations that are not compatible with the printer.</p>	<p>Notes tell you how you should respond to a situation that may arise or give tips about how the current operation works with other features.</p>	<p>Indicates reference to the User's Guide which is on the CD-ROM we have supplied.</p>	

Safety Precautions	2
To Use the Printer Safely	2
Regulations	4

Getting Started

Carton Components	6
Control panel	7
Printer LED Indications	7
Supplied CD-ROM	8

STEP 1—Setting Up the Machine

Put the CD-ROM into the CD-ROM drive	9
Installing the drum unit and toner cartridge assembly	10
Loading paper in the paper tray	11
Printing a test page	12

STEP 2—Installing the Printer Driver

Windows®

For USB interface cable users	14
-------------------------------------	----

Macintosh®

For USB interface cable users	16
For Mac OS® X 10.2.4 or greater users	16
For Mac OS® 9.1 to 9.2 users	18

Other Information

Consumables	19
-------------------	----

Repacking Information

Shipment of the printer	20
-------------------------------	----

Troubleshooting



Chapter 6 of the User's Guide on the CD-ROM

To Use the Printer Safely

Warning



There are high voltage electrodes inside the printer. Before you clean the inside of the printer, make sure that you have turned off the power switch and unplugged the printer from the AC power outlet.

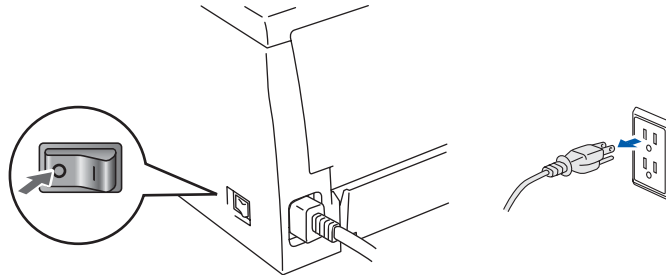

DO NOT handle the plug with wet hands. Doing this might cause an electrical shock.

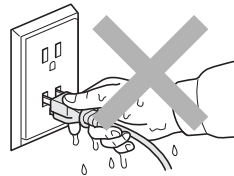

After you have just used the printer, some internal parts of the printer will be extremely hot. DO NOT touch the shaded parts shown in the illustration when you open the front or back cover of the printer.

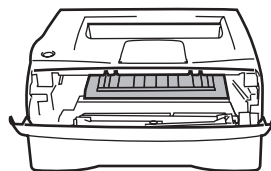

Inside the printer
(Front View)

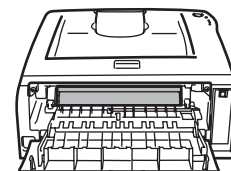

Inside the printer
(Back View)



DO NOT remove or damage the caution label located on or around the fuser.

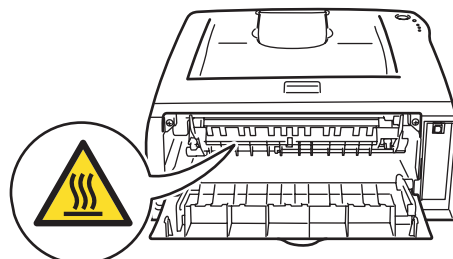

DO NOT use a vacuum cleaner to clean up scattered toner. Doing this might cause the toner dust to ignite inside the vacuum cleaner, potentially starting a fire. Please carefully clean the toner dust with a dry, lint-free cloth and dispose of it according to local regulations.



DO NOT use flammable substances or any type of spray to clean the inside or outside of the machine. Doing this may cause a fire or electrical shock. Refer to the User's Guide for how to clean the machine.



Regulations

Important

A shielded interface cable should be used in order to ensure compliance with the limits for a Class B digital device.

Changes or modifications not expressly approved by Brother Industries, Ltd. could void the user's authority to operate the equipment.

Radio interference (220-240 volt model only)

This printer follows EN55022 (CISPR Publication 22)/Class B.

Before you use this product, make sure that you use the following interface cable.

1. A USB cable.

The cable must not be more than 2 meters long.

EC Declaration of Conformity



EC Declaration of Conformity

Manufacturer

Brother Industries Ltd.
15-1, Naeshiro-cho, Mizuho-ku, Nagoya 467-8561 Japan

Plant

Brother Technology (ShenZhen) Ltd.,
NO6 Gold Garden Ind. Nanling Buji, Longgang, Shenzhen, China

Herewith declare that:

Products description : Laser Printer
Product Name : HL-2035
Model Number : HL-20

are in conformity with provisions of the Directives applied : Low Voltage Directive 2006/95/EC and the Electromagnetic Compatibility Directive 2004/108/EC.

Harmonized standards applied :

Safety	EN60950-1:2001
EMC	EN55022: 1998 +A1: 2000 +A2: 2003 Class B EN55024: 1998 +A1: 2001 +A2: 2003 EN61000-3-2: 2006 EN61000-3-3: 1995 +A1: 2001 +A2: 2005

Year in which CE marking was first affixed : 2008

Issued by : Brother Industries, Ltd.

Date : 6th February, 2008

Place : Nagoya, Japan

Signature :

Junji Shiota
General Manager
Quality Management Dept.
Printing & Solutions Company

International ENERGY STAR® Compliance Statement

The purpose of the International ENERGY STAR® Program is to promote the development and popularization of energy-efficient office equipment.

As an ENERGY STAR® Partner, Brother Industries, Ltd. has determined that this product meets the ENERGY STAR® guidelines for energy efficiency.



IEC 60825-1 specification (220 to 240 volt model only)

This printer is a Class 1 laser product as defined in IEC 60825-1 specifications. The label shown below is attached in countries where it is needed.



This printer has a Class 3B laser diode which produces invisible laser radiation in the scanner unit. You should not open the scanner unit under any circumstances.

! Caution

Use of controls or adjustments or performance of procedures other than those specified herein may result in hazardous radiation exposure.

For Finland and Sweden
LUOKAN 1 LASERLAITE
KLASS 1 LASER APPARAT

! Varoitus!

Laitteen käyttäminen muulla kuin tässä käyttöohjeessa mainitulla tavalla saattaa altistaa käyttäjän turvallisuusluokan 1 ylittävälle näkymättömälle lasersäteilylle.

! Varning

Om apparaten används på annat sätt än i denna Bruksanvisning specificerats, kan användaren utsättas för osynlig laserstrålning, som överskrider gränsen för laserklass 1.

Internal laser radiation

Maximum radiation power:	10 mW
Wave length:	780 - 800 nm
Laser class:	Class 3B

IMPORTANT - For Your Safety

To ensure safe operation, the supplied three-pin plug must be inserted only into a standard three-pin power outlet that is properly grounded through the normal household wiring.

Extension cords used with this printer must be three-pin plug type and correctly wired to provide proper grounding. Incorrectly wired extension cords may cause personal injury and equipment damage.

The fact that the equipment operates satisfactorily does not imply that the power is grounded and that the installation is completely safe. For your safety, if in any doubt about the effective grounding of the power, call a qualified electrician.

Maschinenlärminformations- Verordnung 3. GPSGV (For Germany only)

Der höchste Schalldruckpegel beträgt 70 dB(A) oder weniger gemäß EN ISO 7779.

Disconnect device

You must install this printer near a power outlet that is easily accessible. In case of an emergency, you must disconnect the power cord from the power outlet to shut off the power completely.

IT power system (For Norway only)

This product is also designed for an IT power system with phase-to-phase voltage 230V.

Wiring information (for UK)

Important

If you need to replace the plug fuse, fit a fuse that is approved by ASTA to BS1362 with the same rating as the original fuse.

Always replace the fuse cover. Never use a plug that does not have a cover.

Warning - This printer must be earthed.

The wires in the mains lead are coloured in line with the following code:

Green and Yellow:	Earth
Blue:	Neutral
Brown:	Live

If in any doubt, call a qualified electrician.

Carton Components

Carton components may vary from one country to another.

Save all packing materials and the printer carton in case for any reason you must ship your printer.

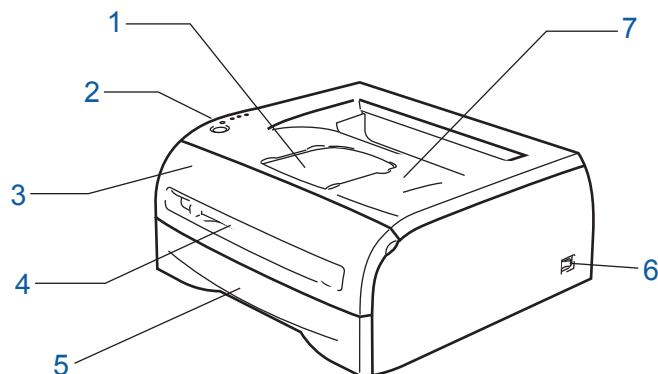

1 Face-down Output Tray Support Flap (Support Flap)

2 Control panel

3 Front Cover

4 Manual feed slot

5 Paper Tray

6 Power Switch

7 Face-down Output Tray (Top Output Tray)

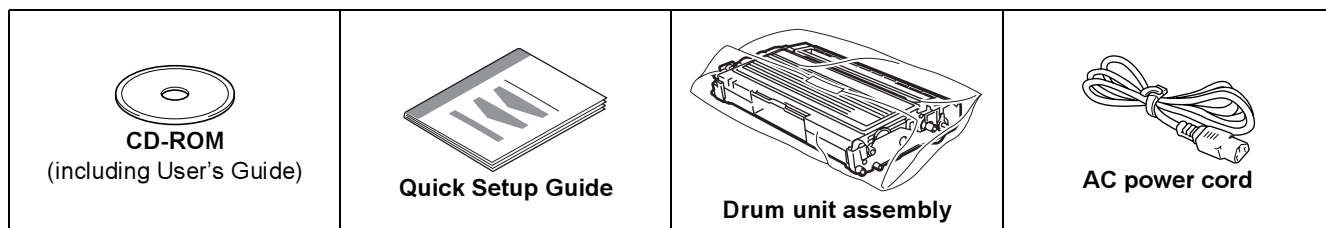

The interface cable is not a standard accessory. Buy the appropriate cable for the interface you are going to use.

■ USB cable

- Please make sure you use a USB 2.0 interface cable that is no longer than 6 feet (2 meters).
- DO NOT connect the interface cable at this time. Connecting the interface cable is done during the printer driver installation process.

When you use a USB cable, make sure you connect it to the USB port of your computer and not to a USB port on a keyboard or non-powered USB hub.

- USB is not supported under Windows[®] 95 or Windows NT[®] 4.0.

Control panel

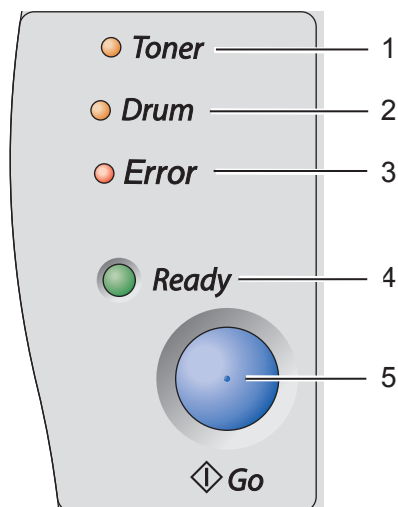

- 1 **Toner LED**
The Toner LED indicates when the toner is low or at the end of its life.
- 2 **Drum LED**
The Drum LED indicates when the drum is nearing the end of its life.
- 3 **Error LED**
The Error LED indicates when the printer is in one of the following states:
No paper / Paper jam / Cover open
- 4 **Ready LED**
The Ready LED indicates when the printer is ready or if Data is remaining.
- 5 **Go button**
Wake-up / Error recovery / Form feed / Job Cancel / Reprint

For the details of the control panel, see Chapter 3 of the User's Guide on the CD-ROM.

Printer LED Indications

★ : Blinking ● : ON ○ : OFF

Printer LED	Sleep/OFF	Warming up	Ready	Receiving data	Print Data remaining
Toner	○	○	○	○	○
Drum	○	○	○	○	○
Error	○	○	○	○	○
Ready (Green)	○	★	●	★	★

Printer LED	Toner low ¹	Toner life end	Drum near end of life ¹	Cover open Paper jam	No paper	Drum Error	Service call
Toner (Yellow)	★	●	○	○	○	○	★
Drum (Yellow)	○	○	★	○	○	★	★
Error (Red)	○	○	○	★	●	★	★
Ready (Green)	●	○	●	○	○	○	★
User's Guide	Chapter 5	Chapter 5	Chapter 5	Chapter 6	Chapter 1	Chapter 3	Chapter 3

¹ The LED will blink in a pattern of ON for 2 seconds and then OFF for 3 seconds.

Supplied CD-ROM

You can find a variety of information on the CD-ROM.

Windows®

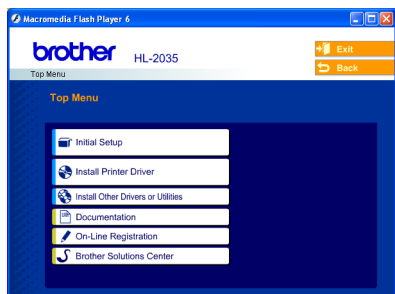

Macintosh®

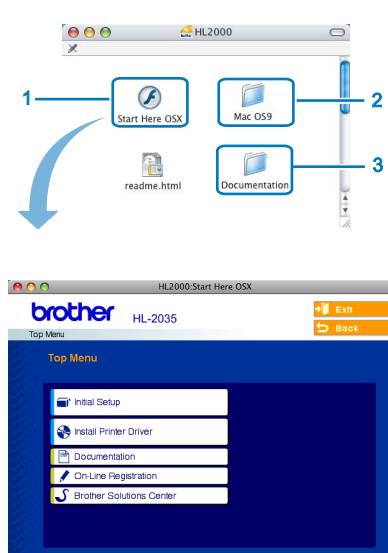

- 1 Mac OS® X 10.2.4 or greater Users
- 2 Mac OS® 9.1 to 9.2 Users
The menu screen is not supported by Mac OS® 9.1 to 9.2.
- 3 View the User's Guide in HTML format. (See  Documentation below.)

Initial Setup

Instructional movie for printer setup.

Install Printer Driver

Install the printer driver.

Install Other Driver or Utilities (For Windows® users)

Install optional driver.

Documentation

View the Printer User's Guide in HTML format.

You can also view the User's Guide in PDF format by accessing the Brother Solutions Center.

The User's Guide in HTML format will be installed automatically when you install the driver. (For Windows® users only) Click the **Start** button, **Programs**¹, your printer (e.g. Brother HL-2035), and then User's Guide. If you do not want to install the User's Guide, choose **Custom setup** from **Install Printer Driver**, and uncheck **User's Guide in HTML format** when you install the driver.

¹ All Programs for Windows® XP users

On-Line Registration

Register your product on-line.

Brother Solutions Center

The Brother Solutions Center (<http://solutions.brother.com>) is a one-stop resource for all your printer needs. Download the latest drivers and utilities for your printers, read FAQs and troubleshooting tips, or learn about printer solutions.

Note

For visually impaired users, we have prepared an HTML file on the supplied CD-ROM: readme.html. This file can be read by Screen Reader 'text-to-speech' software.

STEP 1 Setting Up the Machine

1 Put the CD-ROM into the CD-ROM drive

For Windows® users

⊘ Improper Setup

DO NOT connect the interface cable. Connecting the interface cable is done when installing the driver.

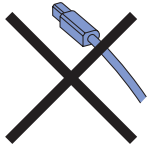

- 1 Put the supplied CD-ROM into your CD-ROM drive. The opening screen will appear automatically. Choose your language.



- 2 Click **Initial Setup** on the menu screen.



- 3 You can view the initial setup instructions and follow along with the steps on pages 10 to 12.

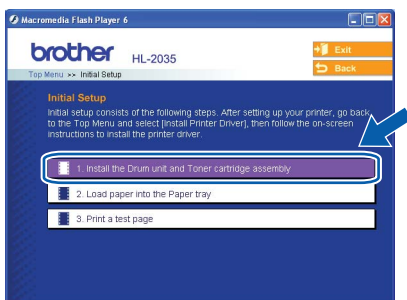

For Macintosh® users

⊘ Improper Setup

DO NOT connect the interface cable. Connecting the interface cable is done when installing the driver.

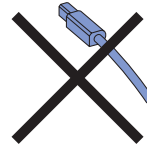

- 1 For Mac OS® 9.1 to 9.2 Users, go to next page. For Mac OS® 10.2.4 or greater Users, put the supplied CD-ROM into your CD-ROM drive, and then double-click the **HL2000** icon on your desktop. Double-click the **Start Here OS X** icon. Choose your language.

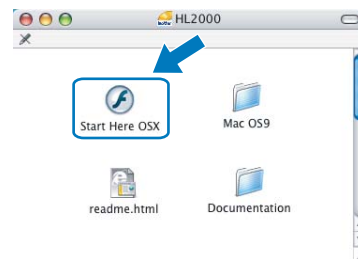

- 2 Click **Initial Setup** on the menu screen.



- 3 You can view the initial setup instructions and follow along with the steps on pages 10 to 12.

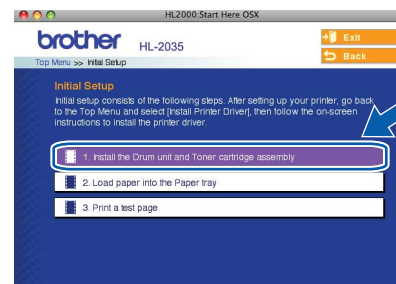

2 Installing the drum unit and toner cartridge assembly

⊘ Improper Setup

DO NOT connect the interface cable.
Connecting the interface cable is done when installing the driver.

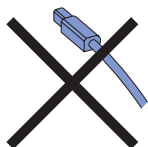

1 Open the front cover.

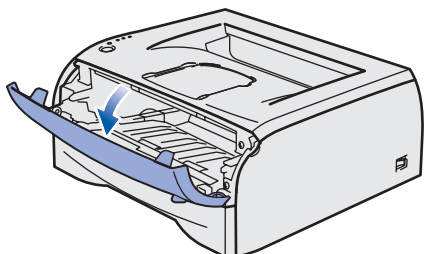

2 Unpack the drum unit and toner cartridge assembly.

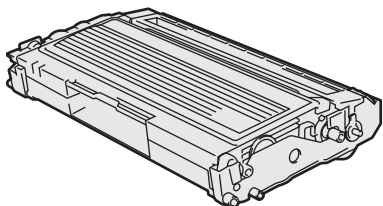

3 Rock it from side to side several times to distribute the toner evenly inside the assembly.

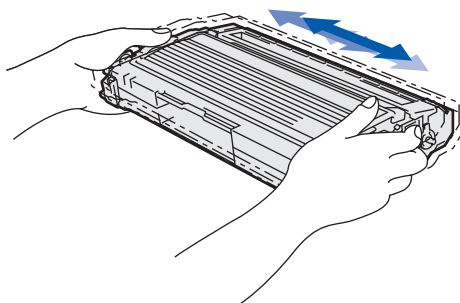

4 Put the drum unit and toner cartridge assembly into the printer.

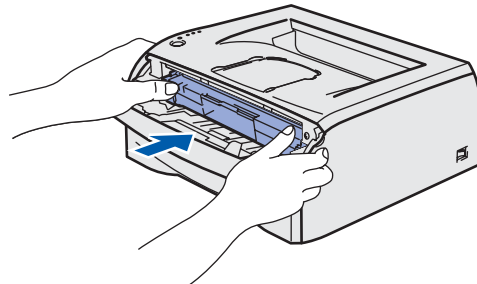
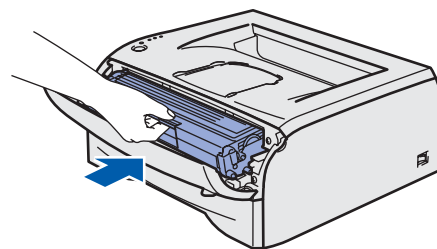

5 Close the front cover of the printer.

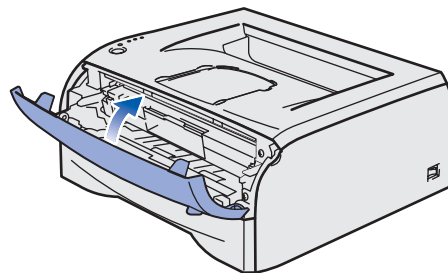

3 Loading paper in the paper tray

- 1 Pull the paper tray completely out of the printer.

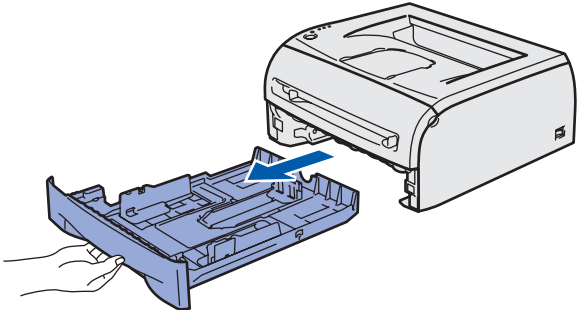

- 2 While pressing the paper-guide release lever (1), slide the paper guides to fit the paper size you are using. Make sure that the guides are firmly in the slots.

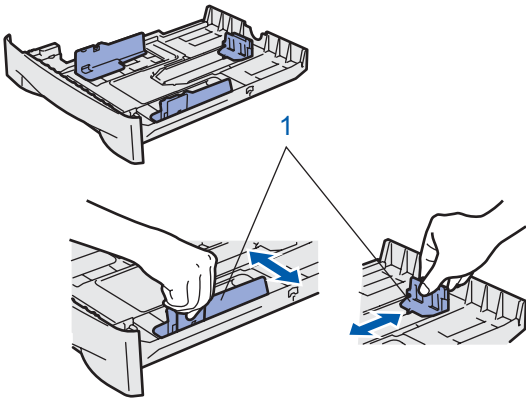

- 3 Fan the stack of paper well to avoid paper jams and misfeeds.

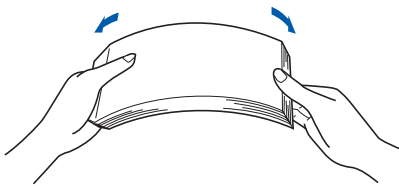

- 4 Put paper in the paper tray. Make sure that the paper is flat in the tray and below the maximum paper mark (1).

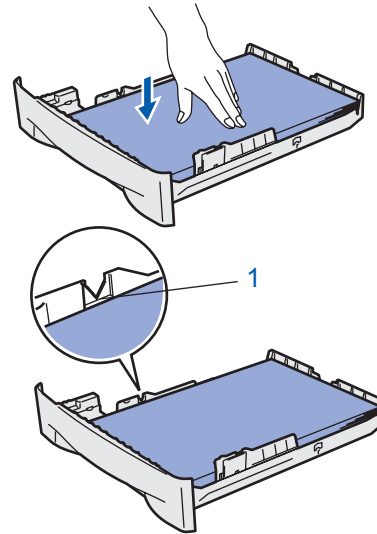

- 5 Put the paper tray firmly back into the printer. Make sure that it is completely inserted into the printer.

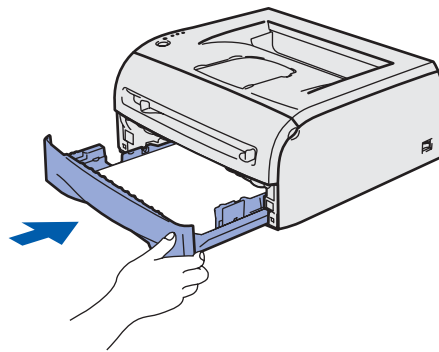

4 Printing a test page

⊘ Improper Setup

DO NOT connect the interface cable yet.

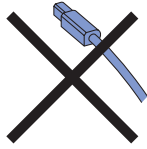

- 1 Make sure that the printer power switch is off. Connect the AC power cord to the printer.

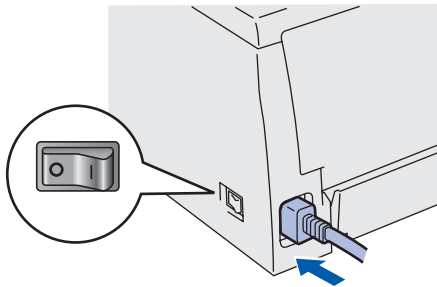

- 2 Plug the AC power cord into an AC power outlet. Turn on the printer power switch.

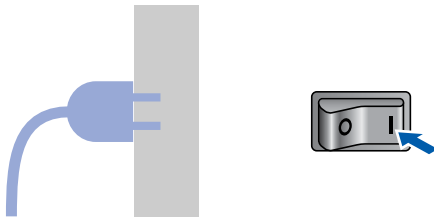

- 3 Unfold the support flap.

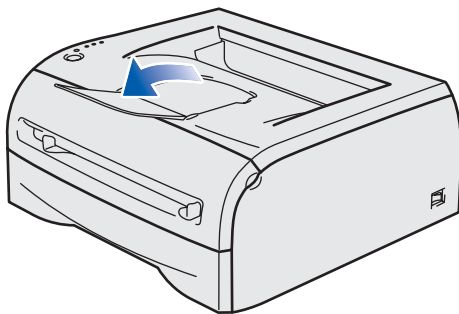

- 4 After the printer has finished warming up, the Ready LED stops blinking and stays green.

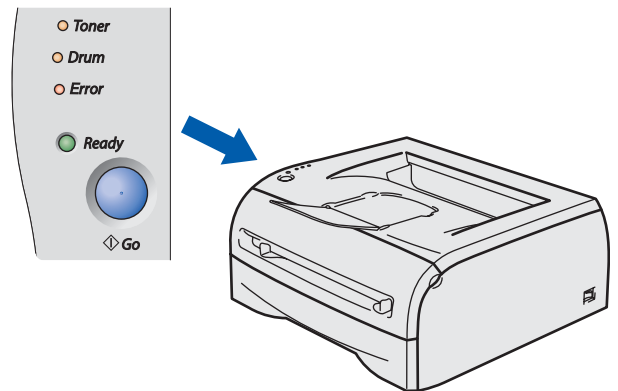

- 5 Press the Go button. The printer prints a test page. Check that the test page has printed correctly.

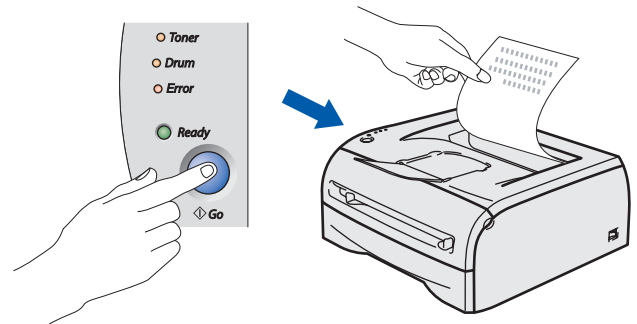

Note

This function will not be available after the first print job you send from your computer.

STEP 2

Installing the Printer Driver

Follow the instructions on this page for your operating system and interface.
For the latest drivers, documentation, and to find the best solution for your problem, access the Brother Solutions Center directly from the CD-ROM / Driver or visit <http://solutions.brother.com>.

Windows®

For USB interface cable users..... 14



Macintosh®

For USB interface cable users..... 16



- For Mac OS® X 10.2.4 or greater users 16
- For Mac OS® 9.1 to 9.2 users..... 18

For USB interface cable users



If the **Found New Hardware Wizard** appears on your computer, click **Cancel**.



For Windows Vista®, when the **User Account Control** screen appears, click **Continue**.

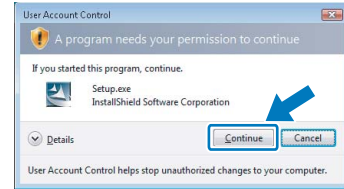

4 When the **License Agreement** window appears, click **Yes** if you agree to the License Agreement.

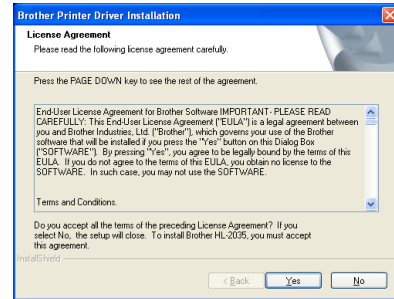

5 When this screen appears, make sure the printer power switch is on. Connect the USB interface cable to your computer, and then connect it to the printer. Click **Next**.

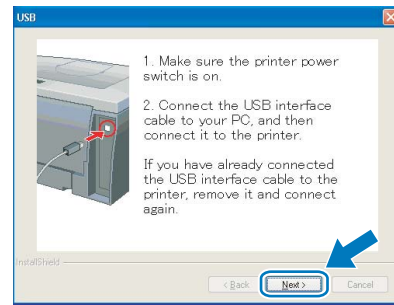

Installing the driver and connecting the printer to your computer

1 Make sure the USB interface cable is **NOT** connected to the printer, and then begin installing the driver. If you have already connected the cable, remove it.

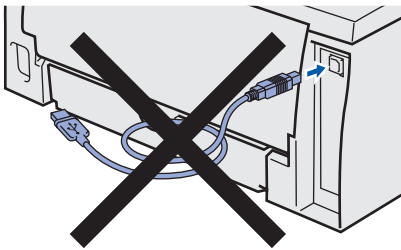

2 Click **Install Printer Driver** on the menu screen.



3 Click **USB cable users**.

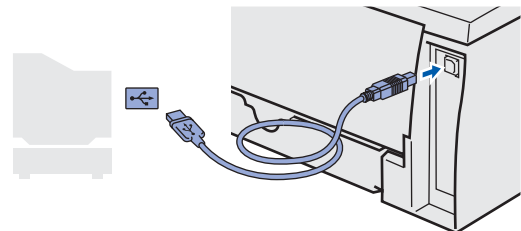

6 Click **Finish**.

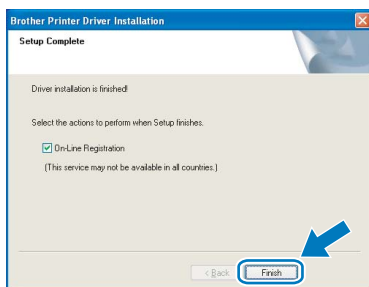

Note

If you want to register your product on-line, check **On-Line Registration**.

OK! For Windows® 98/Me users:
The Setup is now complete.

Note

Your **HL-2030 series** Printer Driver has been installed.

Now go to

For Windows® 2000/XP users:
Go to 'Setting Your Printer as the Default Printer'.

Setting your printer as the default printer (For Windows® 2000/XP only)

1 Click the **Start** button and then **Printers and Faxes**.

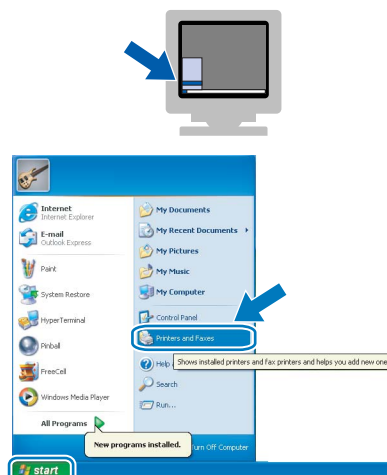

2 Choose the Brother Printer icon.

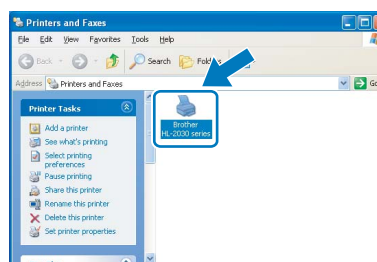

3 Click **File**, and then **Set as Default printer**.

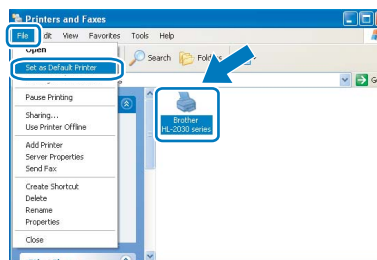

OK! The setup is now complete.

Note

Your **HL-2030 series** Printer Driver has been installed.

For USB interface cable users

For Mac OS® X 10.2.4 or greater users

Connecting the printer to your Macintosh® and installing the driver

- 1 Click **Install Printer Driver** on the menu screen.

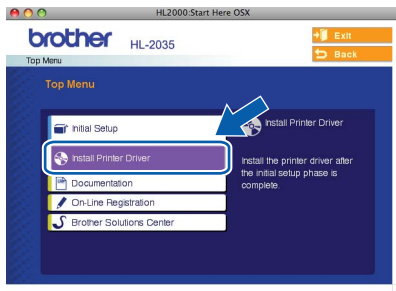

- 2 Click **USB cable users** and follow the on-screen instructions. Then, restart your Macintosh®.



- 3 Connect the USB interface cable to your Macintosh®, and then connect it to the printer.

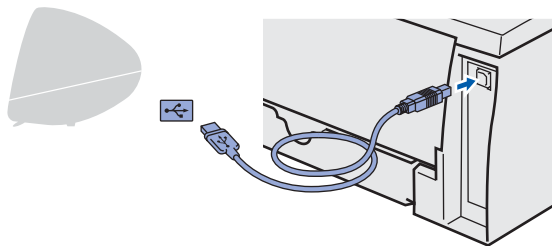

Improper Setup

DO NOT connect the printer to a USB port on a keyboard or a non-powered USB hub.

- 4 Make sure the printer power switch is on.



- 5 Click **Go**, then **Applications**.

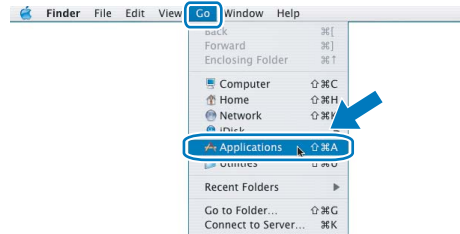

- 6 Double-click the **Utilities** folder.

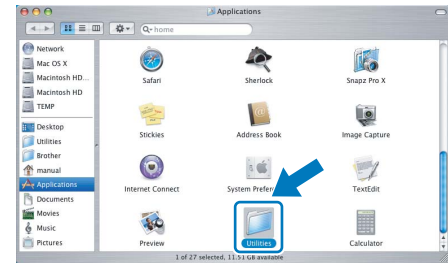

- 7 Double-click the **Printer Setup Utility** icon.

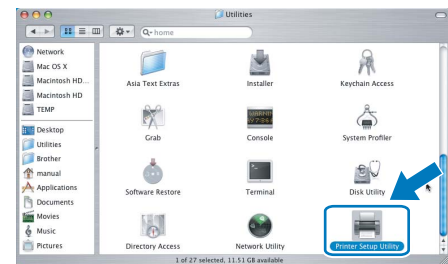

Note

For Mac OS® X 10.2 users, open the **Print Center** icon.

- 8 Click **Add**.

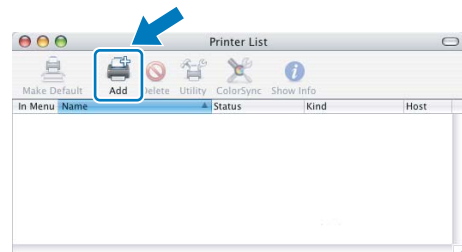

9 Choose USB.

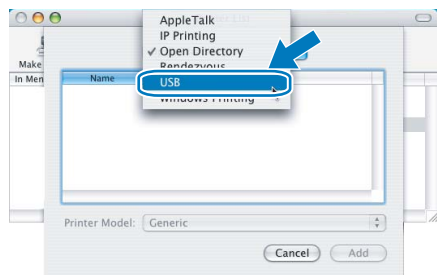

10 Choose the proper printer, and then click Add.

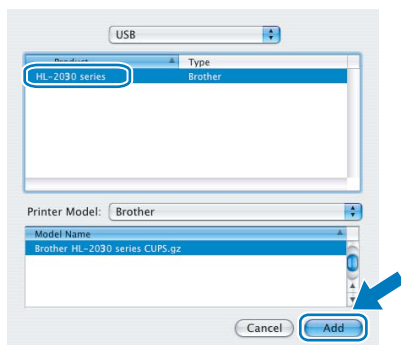

11 Click **Printer Setup Utility**, then **Quit Printer Setup Utility**.

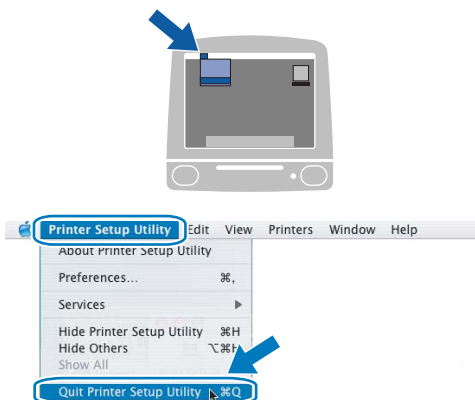

OK! The setup is now complete.

Note _____
Your HL-2030 series Printer Driver has been installed.

Macintosh®
USB

For Mac OS® 9.1 to 9.2 users

Connecting the printer to your Macintosh® and installing the driver

- Put the supplied CD-ROM into your CD-ROM drive. Double-click the **Mac OS 9** folder.

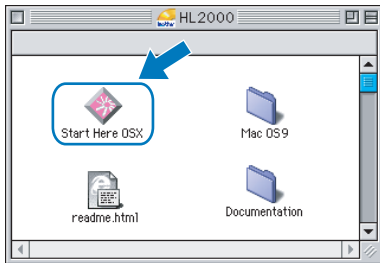

- Double-click your language folder.



- Double-click the **Printer Driver Installer** icon to install the printer driver. Follow the on-screen instructions and restart your Macintosh®.

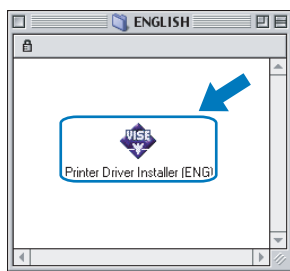

- Connect the USB interface cable to your Macintosh®, and then connect it to the printer.

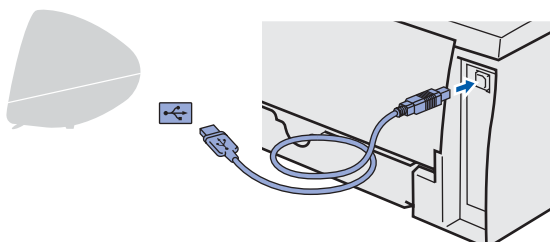

Improper Setup

DO NOT connect the printer to a USB port on a keyboard or a non-powered USB hub.

- Make sure the printer power switch is on.



- From the **Apple®** menu, click **Chooser**.

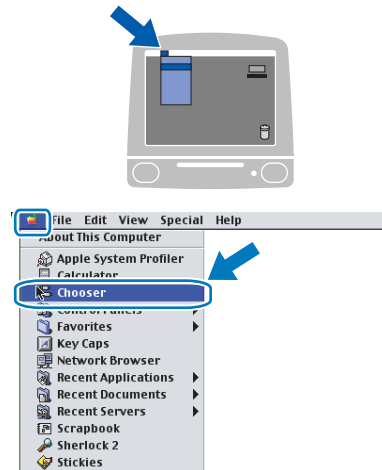

- Click the **Brother Laser** icon. On the right side of the **Chooser**, choose the printer to which you want to print. Close the **Chooser**.

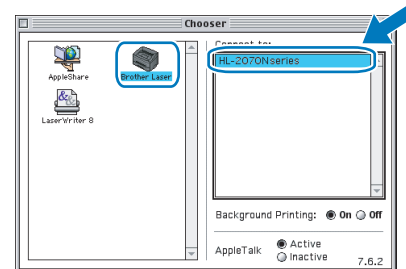

OK! The setup is now complete.

Note Your **HL-2030 series** Printer Driver has been installed.

Consumables

When the time comes to replace consumable items, an error will be indicated by the LED's on the control panel. For more information about the consumables for your printer, visit us at <http://solutions.brother.com> or contact your local Brother reseller.

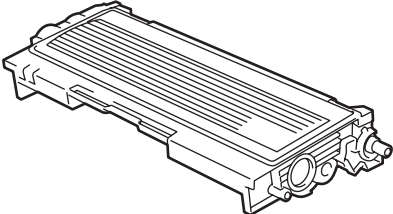
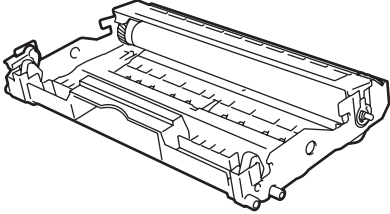

See Chapter 5 of the User's Guide on the CD-ROM.

Toner cartridge	Drum unit
 A line drawing of a toner cartridge, showing its rectangular shape and various mechanical components.	 A line drawing of a drum unit, showing its complex internal structure and various rollers and components.

Shipment of the printer

Shipment of the printer

If for any reason you must ship your printer, carefully package the printer to avoid any damage during transit. We recommend that you save and use the original packaging. The printer should also be adequately insured with the carrier.

! Caution

When shipping the printer, the DRUM UNIT and TONER CARTRIDGE assembly must be removed from the printer and put in a plastic bag. Failure to remove the unit and put it in a plastic bag before shipping may cause severe damage to the printer and may VOID THE WARRANTY.

- 1 Turn off the printer power switch, and then unplug the AC power cord.

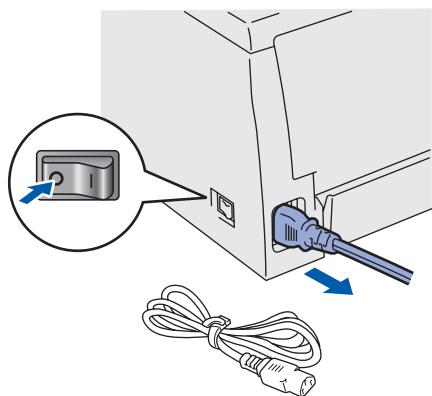

- 2 Remove the drum unit and toner cartridge assembly. Put it in a plastic bag and seal the bag completely.

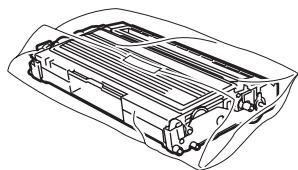

- 3 Repack the printer.

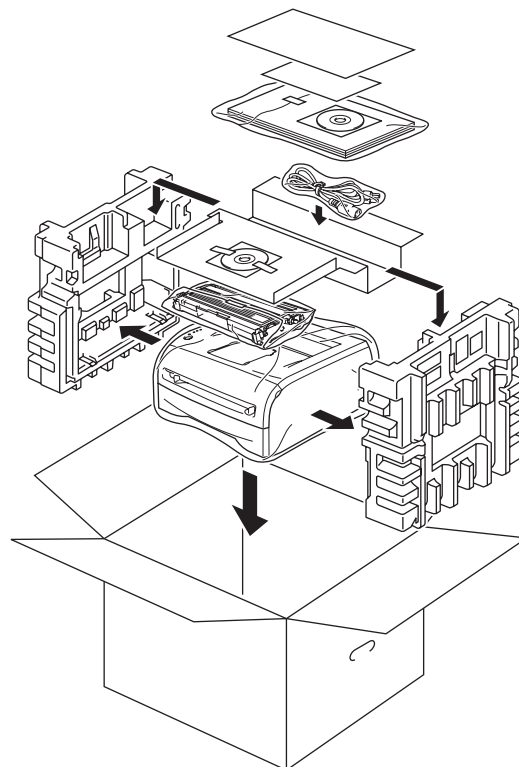

Trademarks

The Brother logo is a registered trademark of Brother Industries, Ltd.

Apple and Macintosh are registered trademarks and Safari is a trademark of Apple Inc.

Microsoft, MS-DOS and Windows are registered trademarks of Microsoft Corporation in the U.S. and other countries.

Windows Vista is either a registered trademark or trademark of Microsoft Corporation in the United States and/or other countries.

All other terms and brand and product names mentioned in this Quick Setup Guide are registered trademarks of their respective companies.

Compilation and Publication

This manual has been compiled and published, under the supervision of Brother Industries Ltd., covering the latest product descriptions and specifications.

The contents of this manual and the specifications of this product are subject to change without notice.

Brother reserves the right to make changes without notice in the specifications and materials contained herein and shall not be responsible for any damages (including consequential) caused by reliance on the materials presented, including but not limited to typographical and other errors relating to the publication.

This product is designed for use in a professional environment.

Copyright and License

© 2008 Brother Industries, Ltd. ALL RIGHTS RESERVED.

brother®

ENG

Free Manuals Download Website

<http://myh66.com>

<http://usermanuals.us>

<http://www.somanuals.com>

<http://www.4manuals.cc>

<http://www.manual-lib.com>

<http://www.404manual.com>

<http://www.luxmanual.com>

<http://aubethermostatmanual.com>

Golf course search by state

<http://golfingnear.com>

Email search by domain

<http://emailbydomain.com>

Auto manuals search

<http://auto.somanuals.com>

TV manuals search

<http://tv.somanuals.com>