

DCP-8040 DCP-8045D

brother

If you need to call Customer Service

Please complete the following information for future reference:

Model Number: DCP-8040, DCP-8045D
(Circle your model number)

Serial Number:* _____

Date of Purchase: _____

Place of Purchase: _____

* The serial number is on the back of the unit. Retain this User's Guide with your sales receipt as a permanent record of your purchase, in the event of theft, fire or warranty service.

Register your product on-line at

www.registermybrother.com

By registering your product with Brother International Corporation, you will be recorded as the original owner of the product. Your registration with Brother:

- may serve as confirmation of the purchase date of your product should you lose your receipt;
- may support an insurance claim by you in the event of product loss covered by insurance; and,
- will help us notify you of enhancements to your product and special offers.

The most convenient and efficient way to register your new product is on-line at www.registermybrother.com

Brother numbers

IMPORTANT

For technical help, you must call the country where you bought the DCP. Calls must be made **from within** that country.

Register your product

By registering your product with Brother International Corporation, you will be recorded as the original owner of the product. Your registration with Brother:

- may serve as confirmation of the purchase date of your product should you lose your receipt;
- may support an insurance claim by you in the event of product loss covered by insurance; and,
- will help us notify you of enhancements to your product and special offers.

Please complete and fax the Brother Warranty Registration And Test Sheet or, for your convenience and most efficient way to register your new product, register on-line at

www.registermybrother.com

Frequently asked questions (FAQs)

The Brother Solutions Center is our one-stop resource for all your Digital Copier/Printer needs. You can download the latest software and utilities, read FAQs and troubleshooting tips, and go to the “Solutions” section to learn how to get the most from your Brother product.

<http://solutions.brother.com>



You can check here for Brother driver updates.

For Customer Service

In USA: 1-800-284-4329 (voice)
1-901-379-1215 (fax)
1-800-284-3238 (TTY service for the hearing-impaired)

In Canada: 1-877-BROTHER (voice)
(514) 685-4898 (fax)

Service Center Locator (USA only)

For the location of a Brother authorized service center, call 1-800-284-4357.

Service Center Locations (Canada only)

For the location of a Brother authorized service center, call 1-877-BROTHER.

Brother fax back system (USA only)

Brother has installed an easy-to-use fax back system, so you can get instant answers to common technical questions and product information for all Brother products. This system is available 24 hours a day, 7 days a week. You can use the system to send faxes to any fax machine.

In USA only: 1-800-521-2846

Ordering accessories and supplies

For best quality results use only genuine Brother accessories, which are available at most Brother retailers. If you cannot find the accessory you need and you have a Visa, MasterCard, Discover, or American Express credit card, you can order accessories directly from Brother. (In the USA, you can visit us online for a complete selection of the Brother accessories and supplies that are available for purchase.)

In USA: 1-888-879-3232 (voice)
1-800-947-1445 (fax)

<http://www.brothermall.com>

In Canada: 1-877-BROTHER (voice)

Description	Item
Toner Cartridge	TN-540 (Standard, Prints up to 3,500 pages) TN-570 (High yield, Prints up to 6,700 pages)
Drum Unit	DR-510
IEEE-1284 Bi-directional Cable	F2A046-10
Power Protector for A/C Power, Phone Line Surges and Voltage Spikes (2 outlets)	QPD120
Power Protector for A/C Power, Phone Line Surges and Voltage Spikes (8 outlets)	FX120
Paper Tray #2 (Option)	LT-5000
Network (LAN) Board (Option) Brother Print Server (10/100 Base-TX Ethernet Network)	NC-9100h
User's Guide	LF2695001 LF2796001 (French For Canada)
Quick Setup Guide	LF2723001 LF2798001 (French For Canada)

Notice - Disclaimer of Warranties (USA and Canada)

BROTHER'S LICENSOR(S), AND THEIR DIRECTORS, OFFICERS, EMPLOYEES OR AGENTS (COLLECTIVELY BROTHER'S LICENSOR) MAKE NO WARRANTIES, EXPRESS OR IMPLIED, INCLUDING WITHOUT LIMITATION THE IMPLIED WARRANTIES OF MERCHANTABILITY AND FITNESS FOR A PARTICULAR PURPOSE, REGARDING THE SOFTWARE. BROTHER'S LICENSOR(S) DOES NOT WARRANT, GUARANTEE OR MAKE ANY REPRESENTATIONS REGARDING THE USE OR THE RESULTS OF THE USE OF THE SOFTWARE IN TERMS OF ITS CORRECTNESS, ACCURACY, RELIABILITY, CURRENTNESS OR OTHERWISE. THE ENTIRE RISK AS TO THE RESULTS AND PERFORMANCE OF THE SOFTWARE IS ASSUMED BY YOU. THE EXCLUSION OF IMPLIED WARRANTIES IS NOT PERMITTED BY SOME STATES IN THE USA AND SOME PROVINCES IN CANADA. THE ABOVE EXCLUSION MAY NOT APPLY TO YOU.

IN NO EVENT WILL BROTHER'S LICENSOR(S) BE LIABLE TO YOU FOR ANY CONSEQUENTIAL, INCIDENTAL OR INDIRECT DAMAGES (INCLUDING DAMAGES FOR LOSS OF BUSINESS PROFITS, BUSINESS INTERRUPTION, LOSS OF BUSINESS INFORMATION, AND THE LIKE) ARISING OUT OF THE USE OR INABILITY TO USE THE SOFTWARE EVEN IF BROTHER'S LICENSOR HAS BEEN ADVISED OF THE POSSIBILITY OF SUCH DAMAGES. BECAUSE SOME STATES IN THE USA AND SOME PROVINCES IN CANADA DO NOT ALLOW THE EXCLUSION OR LIMITATION OF LIABILITY FOR CONSEQUENTIAL OR INCIDENTAL DAMAGES, THE ABOVE LIMITATIONS MAY NOT APPLY TO YOU. IN ANY EVENT BROTHER'S LICENSOR'S LIABILITY TO YOU FOR ACTUAL DAMAGES FROM ANY CAUSE WHATSOEVER, AND REGARDLESS OF THE FORM OF THE ACTION (WHETHER IN CONTRACT, TORT (INCLUDING NEGLIGENCE), PRODUCT LIABILITY OR OTHERWISE), WILL BE LIMITED TO \$50.

Compilation and Publication Notice

Under the supervision of Brother Industries Ltd., this manual has been compiled and published, covering the latest product descriptions and specifications.

The contents of this manual and the specifications of this product are subject to change without notice.

Brother reserves the right to make changes without notice in the specifications and materials contained herein and shall not be responsible for any damages (including consequential) caused by reliance on the materials presented, including but not limited to typographical and other errors relating to the publication.

Brother® Three-Year Limited Warranty and Exchange Service For DCP-8040 and DCP-8045D (USA only)

Who is covered:

- This limited warranty ("warranty") is given only to the original end-use/retail purchaser (referred to in this warranty as "Original Purchaser") of the accompanying product, consumables and accessories (collectively referred to in this warranty as "this Product").
- If you purchased a product from someone other than an authorized Brother reseller in the United States or if the product was used (including but not limited to floor models or refurbished product), prior to your purchase you are not the Original Purchaser and the product that you purchased is not covered by this warranty.

What is covered:

- This Product includes a Machine and Consumable and Accessory Items. Consumable and Accessory Items include but are not limited to toner, drums, print heads and ink cartridges.
- Except as otherwise provided herein, Brother warrants that the Machine and the accompanying Consumable and Accessory Items will be free from defects in materials and workmanship, when used under normal conditions.
- This warranty applies only to products purchased and used in the United States. For products purchased in, but used outside, the United States, this warranty covers only warranty service within the United States (and does not include shipping outside the United States).

What is the length of the Warranty Period(s):

- Machines have a two-stage warranty: 2 years from the original purchase date and an additional warranty up to 3 years from the original purchase date.
- Accompanying Consumable and Accessories Items have a one-stage warranty: 90 days from the original purchase date or the rated life of the Consumable Item, whichever occurs first.

What is NOT covered:

This warranty does not cover:

- (1) Physical damage to this Product;
- (2) Damage caused by improper installation, improper or abnormal use, misuse, neglect or accident (including but not limited to transporting this Product without the proper preparation and/or packaging);
- (3) Damage caused by another device or software used with this Product (including but not limited to damage resulting from use of non Brother®-brand parts and Consumable and Accessory Items);
- (4) Consumable and Accessory Items that expired in accordance with a rated life; and,
- (5) Problems arising from other than defects in materials or workmanship.
- (6) Normal Periodic Maintenance Items, such as Paper Feeding Kit, Fuser and Laser Units.

This warranty is VOID if this Product has been altered or modified in any way (including but not limited to attempted warranty repair without authorization from Brother and/or alteration/removal of the serial number).

What to do if you think your Product is eligible for warranty service:

Report your issue to either our Customer Service Hotline at 1-800-284-4329 or a Brother Authorized Service Center **within the applicable warranty period.** Supply Brother or the Brother Authorized Service Center with a copy of your dated bill of sale showing that this Product was purchased within the U.S. For the name of local Brother Authorized Service Center(s), call 1-800-521-2846 or visit our web site at www.brother.com.

What Brother will ask you to do:

After contacting Brother or a Brother Authorized Service Center, you may be required to deliver (by hand if you prefer) or send the Product properly packaged, freight prepaid, to the Authorized Service Center together with a photocopy of your bill of sale. **You are responsible for the cost of shipping, packing product, and insurance (if you desire). You are also responsible for loss or damage to this Product in shipping.**

What Brother will do:

First 2 Years: If the problem reported concerning your Machine and/or accompanying Consumable and Accessory Item(s) is covered by this warranty and if (i) you first reported the problem with your Machine to Brother or an Authorized Service Center within 2 years from the original purchase date or (ii) you first reported the problem with the accompanying Consumable and Accessory Items to Brother or an Authorized Service Center within the earlier of 90 days from the original purchase date or the rated life of the item, Brother or its Authorized Service Center will repair or replace the Machine and/or accompanying Consumable and Accessory Item(s) at no charge to you for parts or labor. The decision as to whether to repair or replace the Machine and/or accompanying Consumable and Accessory Item(s) is made by Brother in its sole discretion. Brother reserves the right to supply a refurbished or remanufactured replacement Machine and/or accompanying Consumable and Accessory Item(s) and use refurbished parts provided such replacement products conform to the manufacturer's specifications for new product/parts. The repaired or replacement Machine and/or accompanying Consumable and Accessory Item(s) will be returned to you freight prepaid or made available for you to pick up at a conveniently located Authorized Service Center.

2 Years to 3 Years:

If the problem reported concerning your Machine is covered by this warranty and if you first reported the problem after 2 years, but before 3 years from the original purchase date, Brother or its Authorized Service Center will repair the Machine at no charge to you for parts or labor. Brother reserves the right to use refurbished parts provided such refurbished parts conform to the manufacturer's specifications for new product/parts. The repaired Machine will be returned to you freight prepaid or made available for you to pick up at a conveniently located Authorized Service Center.

If the Machine and/or accompanying Consumable and Accessory Item(s) are not covered by this warranty (either stage), you will be charged for shipping the Machine and/or accompanying Consumable and Accessory Item(s) back to you.

The foregoing are your sole (i.e., only) and exclusive remedies under this warranty.

What happens when Brother elects to replace your Machine:

When a replacement Machine is authorized by Brother, and you have delivered the Machine to an Authorized Service Center, the Authorized Service Center will provide you with a replacement Machine after receiving one from Brother. If you are dealing directly with Brother, Brother will send to you a replacement Machine with the understanding that you will, after receipt of the replacement Machine, supply the required proof of purchase information, together with the Machine that Brother agreed to replace. You are then expected to pack the Machine that Brother agreed to replace in the package from the replacement Machine and return it to Brother using the shipping bill supplied by Brother in accordance with the instructions provided by Brother. Since you will be in possession of two machines, Brother will require that you provide a valid major credit card number. Brother will issue a hold against the credit card account number that you provide until Brother receives your original Product and determines that your original Product is entitled to warranty coverage. Your credit card will be charged up to the cost of a new Product only if: (i) you do not return your original Product to Brother within five (5) business days; (ii) the problems of your original Product are not covered by the warranty; (iii) the proper packaging instructions are not followed and has caused damage to the product; or (iv) the warranty period on your original Product has expired or has not been sufficiently validated with a copy of the proof of purchase (bill of sale). The replacement Machine you receive (even if refurbished or remanufactured) will be covered by the balance of the warranty period remaining on the original Product, plus an additional thirty (30) days. You will keep the replacement Machine that is sent to you and your original Machine shall become the property of Brother. **Retain your original Accessory Items and a copy of the return shipping bill, signed by the courier.**

Limitations:

Brother is not responsible for damage to or loss of any equipment, media, programs or data related to the use of this Product. Except for that repair or replacement as described above, Brother shall not be liable for any direct, indirect, incidental or consequential damages or specific relief. Because some states do not allow the exclusion or limitation of consequential or incidental damages, the above limitation may not apply to you.

THIS WARRANTY IS GIVEN IN LIEU OF ALL OTHER WARRANTIES, WRITTEN OR ORAL, WHETHER EXPRESSED BY AFFIRMATION, PROMISE, DESCRIPTION, DRAWING, MODEL OR SAMPLE. ANY AND ALL WARRANTIES OTHER THAN THIS ONE, WHETHER EXPRESS OR IMPLIED, INCLUDING IMPLIED WARRANTIES OF MERCHANTABILITY AND FITNESS FOR A PARTICULAR PURPOSE, ARE HEREBY DISCLAIMED.

- This Warranty is the only warranty that Brother is giving for this Product. It is the *final expression and the exclusive and only statement* of Brother's obligations to you. It replaces all other agreements and understandings that you may have with Brother or its representatives.
- This warranty gives you certain rights and you may also have other rights that may vary from state to state.
- This Warranty (and Brother's obligation to you) may not be changed in any way unless you and Brother sign the same piece of paper in which we (1) refer to this Product and your bill of sale date, (2) describe the change to this warranty and (3) agree to make that change.

Important: *We recommend that you keep all original packing materials, in the event that you ship this product.*

BROTHER MULTIFUNCTION CENTER/FACSIMILE MACHINE LIMITED WARRANTY (Canada only)

Pursuant to this limited warranty of 1 year from the date of purchase for labour and parts, Brother International Corporation (Canada) Ltd. ("Brother"), or its Authorized Service Centers, will repair this DCP/Facsimile machine free of charge if defective in material or workmanship. This Limited Warranty does not include cleaning, consumables (including, without limitation, print cartridges, print head, toner and drum) or damage caused by accident, neglect, misuse or improper installation or operation, any damage caused from service, maintenance, modifications, or tampering by anyone other than a Brother Authorized Service Representative, or from the use of supplies or consumable items that are non-Brother products. Operation of the DCP/Facsimile machine in excess of the specifications or with the Serial Number or Rating Label removed shall be deemed abuse and all repairs thereafter shall be the sole liability of the end-user/purchaser. In order to obtain warranty service, the DCP/Facsimile machine must be delivered or shipped freight prepaid by the end user/purchaser to a "Brother" Authorized Service Center, together with your Proof of Purchase in the form of a Sales Receipt.

For laser products: Failure to remove the Toner Cartridge (and Toner Drum Unit on applicable models) during shipping will cause severe damage to the DCP/Facsimile and will VOID the Warranty. (Refer to your User's Guide for proper packaging.)

For ink-jet products: Do not remove the ink cartridges during shipping. Damage to your print head resulting from packing without the ink cartridges will VOID your warranty. (Refer to your User's Guide for proper packaging.)

BROTHER DISCLAIMS ALL OTHER WARRANTIES EXPRESSED OR IMPLIED INCLUDING, WITHOUT LIMITATION, ANY IMPLIED WARRANTIES OF MERCHANTABILITY OR FITNESS FOR A PARTICULAR PURPOSE, EXCEPT TO THE EXTENT THAT ANY WARRANTIES IMPLIED BY LAW CANNOT BE VALIDLY WAIVED.

No oral or written information, advice or representation provided by Brother, its Authorized Service Centers, Distributors, Dealers, Agents or employees, shall create another warranty or modify this warranty. This warranty states Brother's entire liability and your exclusive remedy against Brother for any failure of the DCP/Facsimile machine to operate properly.

Neither Brother nor anyone else involved in the development, production, or delivery of this DCP/Facsimile machine shall be liable for any indirect, incidental, special, consequential, exemplary, or punitive damages, including lost profits, arising from the use of or inability to use the product, even if advised by the end user/purchaser of the possibility of such damages. Since some Provinces do not allow the above limitation of liability, such limitation may not apply to you.

This Limited Warranty gives you specific legal rights and you may also have other rights which vary from Providence to Providence.

Warranty Service is available at Brother Authorized Service Centers throughout Canada. For Technical Support or for the name and location of your nearest Authorized Service Center call 1-877-BROTHER.

Internet support: support@brother.ca or browse

Brother's Web Site: www.brother.com

Brother International Corporation (Canada) Ltd.

1 Rue Hôtel de Ville

Dollard-Des-Ormeaux, QC H9B 3H6







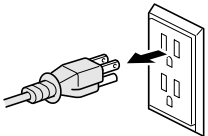

At your side.
brother®

Safety precautions

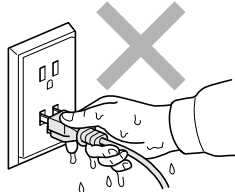
To use the DCP safely

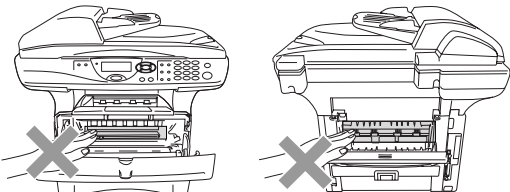
Save these instructions for later reference.

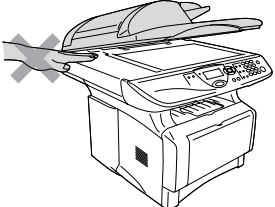
WARNING

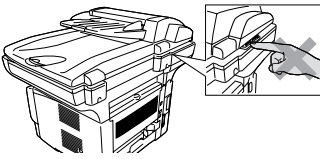
	<p>There are high voltage electrodes inside the DCP. Before you clean the DCP or clear a paper jam, make sure you have unplugged the power cord from the power outlet.</p> 		<p>Do not handle the plug with wet hands. Doing this might cause an electrical shock.</p> 
	<p>After you use the DCP, some internal parts are extremely HOT! To prevent injuries, be careful not to put your fingers in the area shown in the illustration.</p> 		
	<p>To prevent injuries, be careful not to put your hands on the edge of the DCP under the document cover.</p> 		<p>To prevent injuries, be careful not to put your fingers in the area shown in the illustration.</p> 

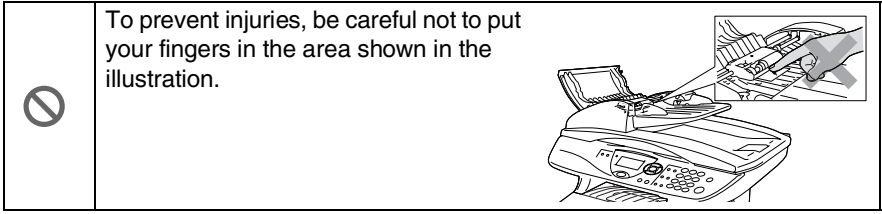

! WARNING

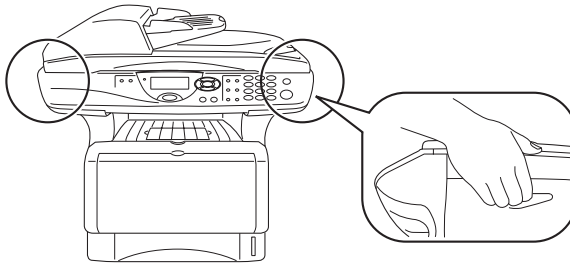

- When you move the DCP, grasp the side handholds that are under the scanner. Do NOT carry the DCP by holding it at the bottom.
- Install equipment with a power cord near a socket/outlet that is easily accessible.
- Do not use this product near appliances that use water, in a wet basement or near a swimming pool.

! Caution

- Lightning and power surges can damage this product! We recommend that you use a quality surge protection device on the AC power line, or unplug the line during a lightning storm.

Choosing a location

Place your DCP on a flat, stable surface that is free of vibration and shocks, such as a desk. Put the DCP near a telephone jack and a standard, grounded power outlet. Choose a location where the temperature remains between 50°F and 95.5°F (10°-32.5°C).

! Caution

- Do not place near heaters, air conditioners, water, chemicals, or refrigerators.
- Do not expose the DCP to direct sunlight, excessive heat, moisture, or dust.
- Do not connect your DCP to electrical outlets controlled by wall switches or automatic timers.
- Disruption of power can wipe out information in the DCP's memory.
- Do not connect your DCP to electrical outlets on the same circuit as large appliances or other Equipment that might disrupt the power supply.
- Avoid interference sources, such as speakers or the base units of cordless phones.



Table of Contents

1

Introduction	1-1
Using this Guide	1-1
Finding information	1-1
Symbols used in this Guide	1-1
On-line Registration (USA and Canada)	1-2
DCP part names and operations	1-3
Control panel overview	1-6
Status LED indications	1-8
Inserting originals for copying (and scanning)	1-10
Using the ADF (automatic document feeder)	1-10
Using the scanner glass	1-12

2

Paper	2-1
About paper	2-1
Type and size of paper	2-1
Recommended paper	2-1
Choosing acceptable paper	2-2
Paper capacity of the paper trays	2-3
Paper specifications for each paper tray	2-4
How to load paper	2-5
To load paper or other media in the paper tray	2-5
To load paper or other media in the manual feed tray (For DCP-8040)	2-7
To load paper or other media in the multi-purpose tray (MP tray) (For DCP-8045D)	2-9
To use Automatic Duplexing for copy and print operations (For DCP-8045D)	2-11

3

On-screen programming	3-1
User-friendly programming	3-1
Menu table	3-1
Navigation keys	3-2
Key Operations table	3-10

4

Getting started	4-1
General Setup	4-1
Setting the Paper Type	4-1
Setting the Paper Size	4-3
Setting the Beeper Volume	4-4
Toner Save	4-4
Sleep Time	4-5

Turning off the Scanner Lamp	4-5
Setting the Tray Use for Copy mode	4-6
Setting the LCD Contrast.....	4-7
Printing the User Settings List	4-7

5

Making copies	5-1
Using the DCP as a copier	5-1
Printable area	5-1
Temporary copy settings	5-2
Making a single copy from the ADF.....	5-3
Making multiple copies from the ADF	5-3
Single or multiple copies using the scanner glass	5-4
Out of Memory message	5-4
Using the copy keys (temporary settings).....	5-5
Enlarge/Reduce.....	5-6
Quality (type of original).....	5-8
Sorting copies using the ADF	5-8
Contrast	5-9
Tray Select.....	5-10
Duplex/N in 1	5-11
Duplex/N in 1 copy.....	5-12
N in 1 copy.....	5-12
Poster	5-13
Duplex (1 in 1) (For DCP-8045D)	5-14
Duplex (2 in 1) and Duplex (4 in 1) (For DCP-8045D)	5-16
Changing the default copy settings.....	5-17
Quality	5-17
Contrast	5-17

6

Using the DCP as a printer	6-1
Using the Brother DCP-8040, DCP-8045D printer driver ...	6-1
How to print your document.....	6-2
Simultaneous printing and scanning.....	6-3
Two-sided printing (Duplex Printing).....	6-3
Automatic Duplex Printing (For DCP-8045D)	6-3
Manual Duplex Printing	6-4
Face-down output tray.....	6-4
Printing on plain paper.....	6-5
The manual feed tray (For DCP-8040)	6-5
The MP tray (For DCP-8045D).....	6-6
Printing on thicker paper and card stock	6-7
The manual feed tray (For DCP-8040)	6-7

The multi-purpose tray (MP tray) (For DCP-8045D)	6-9
Printing on envelopes	6-11
Printer operation keys	6-16
Job Cancel	6-16
Secure key	6-16
Setting the Emulation Selection	6-17
Printing the Internal Font List	6-18
Printing the print configuration list	6-18
Restoring default settings	6-18

7

Printer driver settings	7-1
Printer driver settings	7-1
How to access the printer driver settings	7-1
Features in the Brother Native Driver	7-2
Basic tab	7-2
Paper Size	7-3
Multiple Page	7-3
Orientation	7-3
Copies	7-4
Media Type	7-4
Advanced tab	7-5
Print Quality	7-5
Duplex Printing	7-7
Watermark	7-8
Page Setting	7-10
Device Options	7-11
Secure Print	7-11
Accessories tab	7-14
Support tab	7-16
Features in the PS printer driver (For Windows®)	7-17
Ports tab	7-18
Device Settings tab	7-19
Layout tab	7-20
Booklet (For DCP-8045D) (For Windows® 2000/XP)	7-20
Paper/Quality tab	7-21
Advanced Options	7-22

8

How to scan using Windows®	8-1
Scanning a document	8-1
TWAIN compliant	8-1
How to access the Scanner	8-2
Scanning a document into the PC	8-3

Scanning a whole page	8-3
Pre-Scanning to crop a portion you want to scan....	8-4
Settings in the Scanner window.....	8-6
Image Type.....	8-6
Resolution.....	8-6
Scan Type	8-7
Brightness.....	8-7
Contrast	8-7
Document Size	8-8
Scanning a document (For Windows® XP only)	8-10
WIA compliant.....	8-10
How to access the scanner.....	8-10
Scanning a document into the PC	8-11
Scanning a document using the ADF	8-11
Pre-Scanning to crop a portion you want to scan using the scanner glass	8-13
Brother Scanner Utility.....	8-15
Using the scan key	
(For USB or Parallel interface cable users)	8-16
Scan to E-mail	8-17
Scan to Image	8-17
Scan to OCR.....	8-18
Scan to File.....	8-18
Using ScanSoft® PaperPort® and OmniPage® OCR	8-19
Viewing items.....	8-20
Organizing your items in folders	8-21
Quick links to other applications	8-21
ScanSoft® OmniPage® OCR lets you convert image text into text you can edit.....	8-22
You can Import items from other applications	8-22
You can Export items in other formats.....	8-23
Exporting an image file	8-23
How to Uninstall PaperPort® and ScanSoft® OmniPage®	8-23

9

Using the Brother Control Center (For Windows® 98/98SE/Me/2000 Professional and Windows NT® WS 4.0)	9-1
Brother MFL-Pro Control Center.....	9-1
AutoLoad the Brother Control Center	9-2
How to turn off AutoLoad.....	9-2
Brother Control Center features.....	9-3
Auto Configuration	9-3
Scan key operations	9-4

Copy operations	9-4
Scanner settings for Scan and Copy buttons	9-5
Global settings	9-5
Setting up the scanner configurations	9-6
Perform an operation from the Control Center screen ..	9-7
Scan to File.....	9-8
To access Scan to File Configurations screen	9-8
Scanner settings.....	9-8
Destination folder.....	9-9
Scan to E-mail	9-10
To access Scan to E-mail Configurations screen	9-10
Scanner settings.....	9-10
E-mail application	9-11
Send to Options.....	9-11
Scan to OCR (Word Processor)	9-12
To access Scan to OCR Configurations screen	9-12
Scanner settings.....	9-12
Word Processor.....	9-13
Scan to Image	9-14
To access Scan to Image Configurations screen	9-14
Scanner Settings	9-14
Target Application.....	9-14
Copy	9-15
To access the Copy Configurations screen	9-15
Scanner settings.....	9-15
Number of copies	9-15

10

Using the Windows®-Based Brother SmartUI

Control Center (For Windows® XP)	10-1
Brother SmartUI Control Center	10-1
AutoLoad the Brother Control Center	10-2
How to turn off Auto Load.....	10-2
Brother Control Center features	10-3
Auto Configuration.....	10-4
Hardware Section: Changing the Scan to button configuration	10-5
Scan to E-mail	10-6
Scan to File.....	10-7
Scan to Image	10-8
Scan to OCR	10-10
Software Section	10-12
Scan	10-13
Copy	10-13
Custom	10-14

Scan to File.....	10-15
Scan to E-mail	10-17
File attachments	10-19
Scanner settings.....	10-20
Scan to OCR (Word Processing program)	10-21
Scan to Graphics application (example: Microsoft Paint).....	10-23
Copy	10-25
Custom: User-defined buttons.....	10-27
Customizing a user-defined button.....	10-27
1. Select the Scan Action	10-27
2. Select Configuration for the Scan Type.....	10-28
3. Select Scan Settings.	10-32

11

Using your DCP with a Macintosh®	11-1
Setting up your USB-equipped Apple® Macintosh®	11-1
Using the Brother printer driver with your Apple® Macintosh® (Mac OS® 8.6 - 9.2).....	11-2
Using the Brother Printer Driver with Your Apple® Macintosh® (Mac OS® X).....	11-4
Choosing page setup options	11-4
Specific settings.....	11-5
Using the PS driver with your Apple® Macintosh®	11-7
For Mac OS® 8.6 to 9.2 users.....	11-7
For Mac OS® X users	11-11
Using the Brother TWAIN scanner driver with your Macintosh®.....	11-14
Accessing the scanner.....	11-14
Scanning an image into your Macintosh®.....	11-15
Scanning a whole page	11-15
Pre-Scanning an image	11-16
Settings in the Scanner window.....	11-17
Image.....	11-17
Scanning Area.....	11-19
Business Card Size	11-19
Adjusting the Image.....	11-20
Using Presto!® PageManager®.....	11-21
Highlights	11-21
System requirements.....	11-22
Technical Support.....	11-22

12

Network Scanning (Windows® 98/98SE/Me/2000 Professional and XP only)	12-1
Network License	12-1
Registering your PC with the DCP	12-1
Using the Scan key	12-5
Scan to E-mail (PC)	12-5
Scan to Image	12-6
Scan to OCR	12-7
Scan to File	12-8

13

Important information	13-1
Federal Communications Commission (FCC)	
Declaration of Conformity (USA only)	13-1
Important	13-2
Important – about the interface cable	13-2
Industry Canada Compliance Statement (Canada only)	13-3
For your safety	13-3
International ENERGY STAR® Compliance Statement	13-3
Laser safety	13-4
FDA regulations	13-4
Important safety instructions	13-6
Trademarks	13-8

14

Troubleshooting and routine maintenance	14-1
Troubleshooting	14-1
Error messages	14-1
Original jams	14-4
Original is jammed in the top of the ADF unit.	14-4
Original is jammed inside the ADF unit.	14-4
Paper jams	14-5
Paper is jammed in the duplex tray (For DCP-8045D)	14-9
If you are having difficulty with your DCP	14-11
Improving the print quality	14-14
Packing and shipping the DCP	14-18
Routine maintenance	14-21
Cleaning the scanner	14-21
Cleaning the printer	14-22
Cleaning the drum unit	14-23
Replacing the toner cartridge	14-24
How to replace the toner cartridge	14-25

Replacing the drum unit.....	14-30
Checking the drum life.....	14-34
Page Counter	14-34

15

Optional accessories	15-1
Memory board.....	15-1
Installing the optional memory board.....	15-2
Network (LAN) board.....	15-5
Before starting installation	15-6
Step 1: Hardware installation.....	15-6
Step 2: Connecting the NC-9100h to an Unshielded Twisted Pair 10BASE-T or 100BASE-TX Ethernet Network	15-9
LED.....	15-9
TEST SWITCH	15-10
Paper Tray #2.....	15-11

G

Glossary	G-1
-----------------------	------------

S

Specifications	S-1
Product description.....	S-1
General	S-1
Print media.....	S-2
Copy	S-3
Scanner	S-3
Printer	S-4
Interfaces	S-4
Computer requirements.....	S-5
Consumable items.....	S-6
Network (LAN) board (NC-9100h).....	S-7
Optional External Wireless Print/Scan Server (NC-2200w)	S-8

Index	I-1
--------------------	------------

1 Introduction

Using this Guide

Thank you for buying a Brother Digital Copier Printer (DCP). Your DCP-8040 or DCP-8045D is simple to use, with LCD screen instructions to guide you through programming it. You can make the most of your DCP by taking a few minutes to read this Guide.





Finding information

All the chapter headings and subheadings are listed in the Table of Contents. You will be able to find information about a specific feature or operation by checking the Index at the back of this Guide.

Symbols used in this Guide

Throughout this Guide you'll see special symbols alerting you to important warnings, notes and actions. To make things clearer and to help you press the correct keys, we used special fonts and added some of the messages that will appear in the LCD.

Bold	Bold typeface identifies specific keys on the DCP control panel.
<i>Italics</i>	Italicized typeface emphasizes an important point or refers you to a related topic.
<code>Courier New</code>	Courier New typeface identifies the message on the LCD of the DCP.

-  Warnings inform you what to do to avoid possible personal injury.
-  Cautions specify procedures you must follow or avoid to prevent possible damage to the DCP.
-  Notes tell you how you should respond to a situation that may arise or give tips about how the current operation works with other features.
-  Improper Setup alerts you to devices and operations that are not compatible with the DCP.

On-line Registration (USA and Canada)

- 1** Insert the MFL-Pro Suite CD-ROM into your CD-ROM drive.
- 2** Click **Online Registration** to register your product.

DCP part names and operations

■ Front view

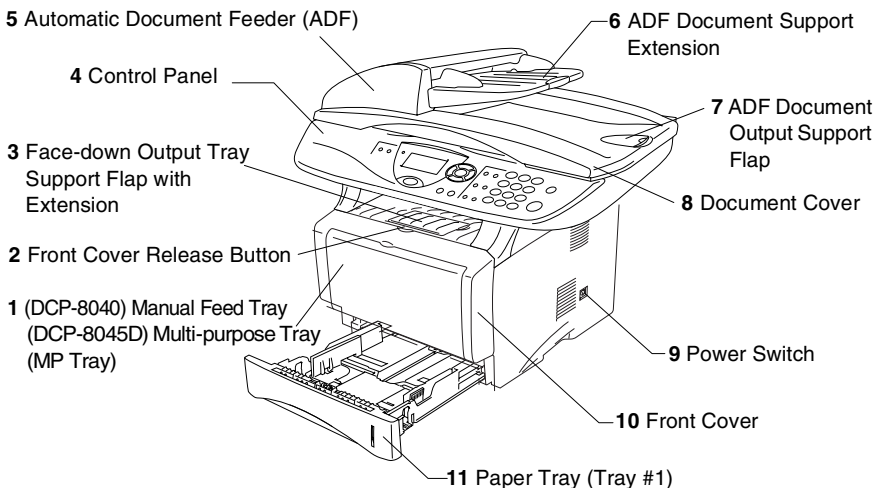

No.	Name	Description
1	(DCP-8040) Manual Feed Tray (DCP-8045D) Multi-purpose Tray (MP Tray)	Load paper here.
2	Front Cover Release Button	Press it to open the front cover.
3	Face-down Output Tray Support Flap with Extension (Support Flap)	Unfold it to prevent the printed paper from sliding off the DCP.
4	Control Panel	Use the keys and display to control the DCP.
5	Automatic Document Feeder (ADF)	Use the ADF unit for multiple page originals.
6	ADF Document Support Extension	Place the original here to use the ADF unit.
7	ADF Document Output Support Flap	Unfold to prevent the scanned pages from sliding off the DCP.
8	Document Cover	Open to place the original on the scanner glass.
9	Power Switch	Switch it on or off.
10	Front Cover	Open to install a toner cartridge or drum unit.
11	Paper Tray (Tray #1)	Load paper here.

■ Back view

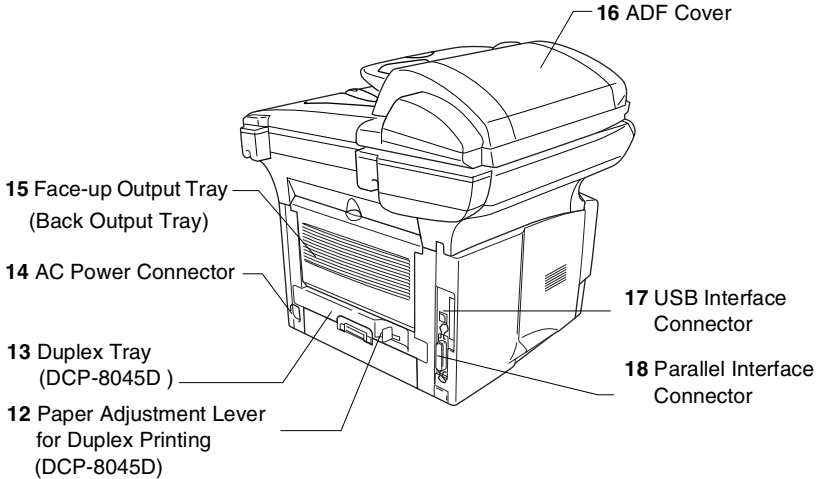

No.	Name	Description
12	Paper Adjustment Lever for Duplex Printing (DCP-8045D)	Use to match your paper size for duplex printing.
13	Duplex Tray (DCP-8045D)	Slide out to remove paper jammed inside the DCP.
14	AC Power Connector	Connect the AC Power Connector here.
15	Face-up Output Tray (Back Output Tray)	Open it when thicker paper is placed in the MP tray or Manual feed tray.
16	ADF Cover	Open to remove paper jammed inside the ADF unit.
17	USB Interface Connector	Connect the USB Cable here.
18	Parallel Interface Connector	Connect the Parallel Cable here.

■ Inside view (document cover open)

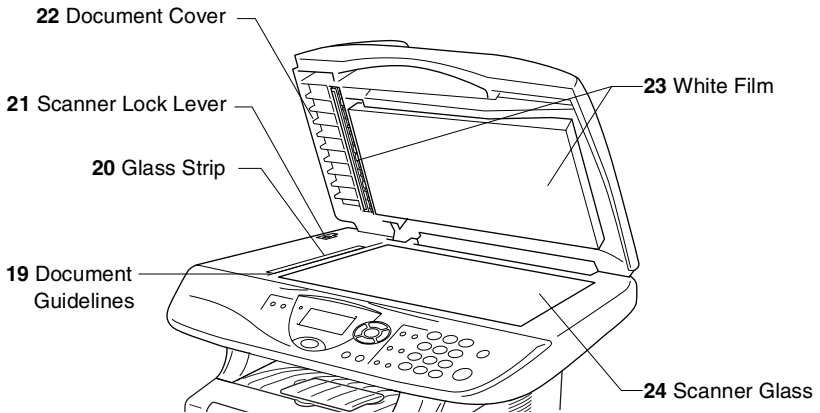

No.	Name	Description
19	Document Guidelines	Use to center the original on the scanner glass.
20	Glass Strip	This is used to scan the original when using the ADF.
21	Scanner Lock Lever	Use to lock/unlock the scanner when relocating the DCP.
22	Document Cover	Open to place the original on the scanner glass.
23	White Film	Clean it for good quality copying and scanning.
24	Scanner Glass	Place the original to be scanned here.

Control panel overview

DCP-8040 and DCP-8045D have similar control panel keys.

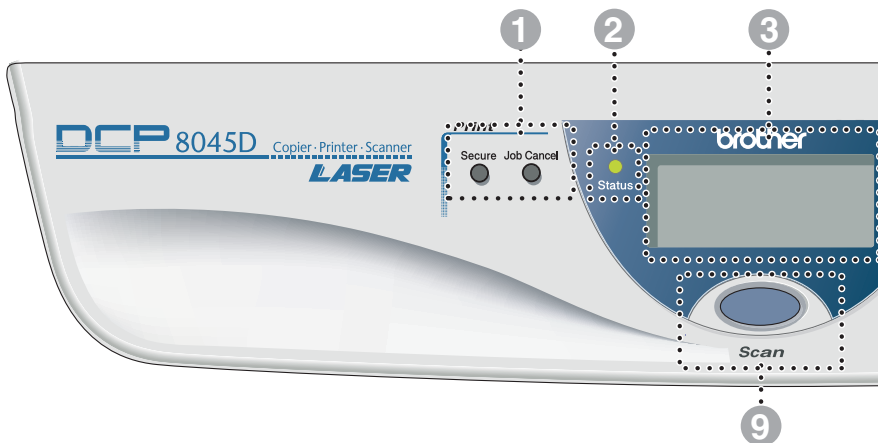

1 Print keys:

Secure

Lets you print out data saved in memory by entering your four-digit password.

Job Cancel

Clears data from the printer memory.

2 Status LED

(Light-Emitting Diode)

The LED will flash and change color depending on the DCP status.

3 5-Line Liquid Crystal Display (LCD)

Displays messages on the screen to help you to set up and use your DCP.

4 Navigation keys:

Menu

Lets you access the Menu to program.

Set

Lets you store your settings in the DCP.

Clear/Back

Deletes entered data or lets you exit the menu by pressing repeatedly.



Press to scroll forward or backward to a menu selection.



Press to scroll through the menus and options.

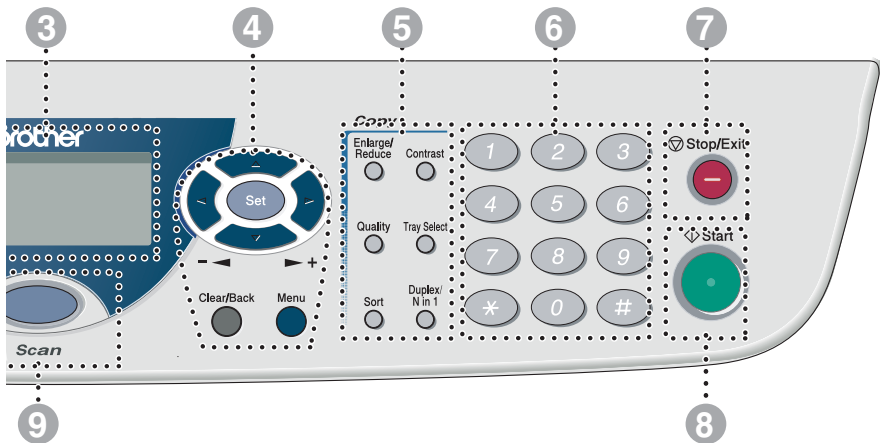

5 Copy keys

(Temporary Settings):

Enlarge/Reduce

Lets you reduce or enlarge copies depending upon the ratio you select.

Contrast

Lets you make a copy that is lighter or darker than the original.

Quality

Lets you select the copy quality for your type of original.

Tray Select

You can select which tray you would like to use for the next copy.

Sort

Lets you sort multiple copies using the ADF.

N in 1 (For DCP-8040)

N in 1 lets you copy 2 or 4 pages onto one page.

Duplex/N in 1 (For DCP-8045D)

You can choose Duplex to copy on both sides of the paper or N in 1 to copy 2 or 4 pages onto one page.

6 Numeric keys

Use the numeric keys to enter the number of multiple copies (99 maximum).

7 Stop/Exit

Stops a copy and scan operation or exits from the menu.

8 Start

Lets you start making copies or scanning.

9 Scan key:





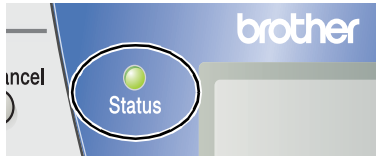

Lets you access Scan mode.





Status LED indications



The **Status** LED (Light Emitting Diode) will flash and change color depending on the DCP status.



The LED indications shown in the table below are used in the illustrations in this chapter.

LED				LED status
				LED is off.
	 Green	 Yellow	 Red	LED is on.
	 Green	 Yellow	 Red	LED is blinking.

LED	DCP status	Description
	Sleep Mode	The power switch is off or the DCP is in Sleep mode or Power save mode.
 Green	Warming Up	The DCP is warming up for printing.
 Green	Ready	The DCP is ready to print.
 Yellow	Receiving Data	The DCP is either receiving data from the computer, processing data in memory or printing data.
 Yellow	Data Remaining in Memory	Print data remains in the DCP memory.

LED	DCP status	Description
 Red	Service error	<p>Follow the steps below.</p> <ol style="list-style-type: none"> 1. Turn off the power switch. 2. Wait a few seconds, and then turn it back on and try to print again. <p>If you cannot clear the error and see the same service call indication after turning the DCP back on, please call Brother Customer Service at: 1-800-284-4329 (in USA) or 1-877-BROTHER (in Canada).</p>
 Red	Cover open	The cover is open. Close the cover. (See <i>Error messages</i> on page 14-1.)
	Toner empty	Replace the toner cartridge with a new one. (See <i>Replacing the toner cartridge</i> on page 14-24.)
	Paper error	Put paper in the tray or clear the paper jam. Check the LCD message. (See <i>Troubleshooting and routine maintenance</i> on page 14-1.)
	Scan lock	Check that the scanner lock lever is released. (See <i>Scanner Lock Lever</i> on page 1-5.)
	Others	Check the LCD message. (See <i>Troubleshooting and routine maintenance</i> on page 14-1.)
	Out of memory	Memory is full. (See <i>Error messages</i> on page 14-1.)

Inserting originals for copying (and scanning)

You can copy from either the ADF (automatic document feeder) or from the scanner glass.

Using the ADF (automatic document feeder)

The automatic document feeder (ADF) can hold up to 50 pages, feeding each one individually through the DCP. Use standard (20 lb/75g/m²) paper when using the ADF. Always fan the pages well and stagger them.

Temperature: 68°F - 86°F (20°C - 30°C)

Humidity: 50% - 70%

- ! DO NOT use curled, wrinkled, folded, or ripped paper, or paper with staples, paper clips, paste or tape attached. DO NOT use cardboard, newspaper, or fabric. (To copy or scan this kind of document, see *Using the scanner glass* on page 1-12.)

Make sure originals written with ink are completely dry.

- 1 Pull out the ADF document support extension.
- 2 Unfold the ADF document output support flap.
- 3 Fan the pages well and stagger them at an angle. Make sure you put the documents **face up, top edge first** in the ADF until you feel them touch the feed roller.

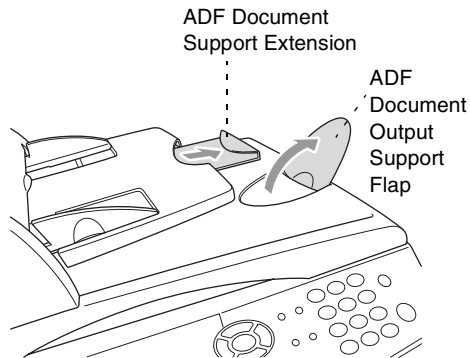

- 4** Adjust the paper guides to fit the width of your originals.

**The documents
are Face Up
in the ADF**

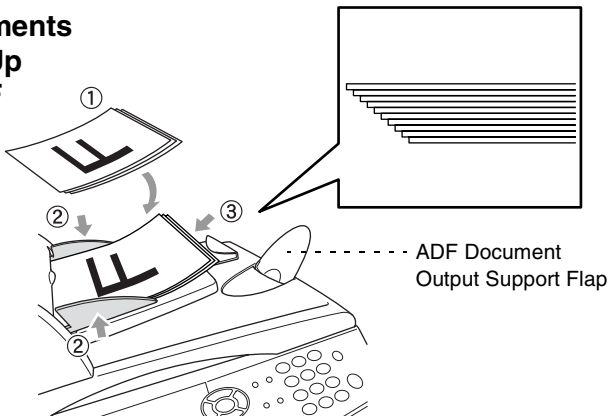

- 5** Press **Start**. The DCP starts scanning the first page.

Using the scanner glass

You can use the scanner glass to copy one page at a time, or pages of a book. To use the scanner glass, the ADF must be empty. You can make multiple copies; however, if you want them sorted you must use the ADF.

- 1 Lift the document cover.

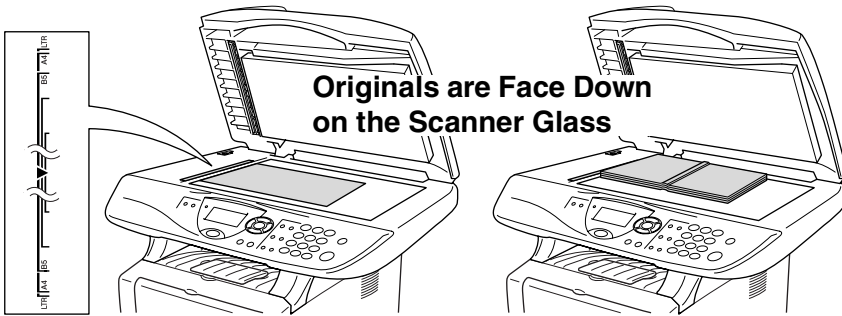

- 2 Using the document guidelines on the left, center the original face down on the scanner glass and close the document cover.
- 3 Using the numeric keys, enter the number of copies you want (up to 99).
- 4 Press **Start**.

The DCP will start scanning the original.

- ! If the original is a book or is thick, do not slam the cover or press on it or you may damage the DCP.

2 Paper

About paper

Type and size of paper

The DCP loads paper from the installed paper tray, manual feed tray, multi-purpose tray or optional lower tray.

Tray Type	Model name
Paper tray (Tray #1)	DCP-8040, DCP-8045D
Manual feed tray	DCP-8040
Multi-purpose tray (MP tray)	DCP-8045D
Optional lower tray (Tray #2)	Option for DCP-8040, DCP-8045D

Recommended paper

Plain Paper: Xerox 4200DP 20 lb
Hammermill Laser Paper 24 lb

Transparency: 3M CG 3300

Labels: Avery laser label #5160

- Before you buy a large amount of paper, please test some to make sure that the paper is suitable.
- Use paper that is made for plain-paper copying.
- Use paper that is 75 to 90 g/m² (20 to 24 lb).
- Use neutral paper. Do not use acidic or alkaline paper.
- Use long-grain paper.
- Use paper with a moisture content of approximately 5%.

Caution

Do not use ink jet paper. It may cause a paper jam and damage your DCP.



The output quality depends on the paper type and paper brand. Visit us at <http://solutions.brother.com> and check the latest recommendations for paper that can be used with the DCP-8040 and DCP-8045D.

Choosing acceptable paper

We recommend that you test paper (especially special sizes and types of paper) on the DCP before purchasing large quantities.

- Avoid feeding label sheets that are partly used or your DCP will be damaged.
- Avoid using coated paper, such as vinyl coated paper.
- Avoid using preprinted or highly textured paper, or paper with an embossed letterhead.

For optimum printing, use a recommended type of paper, especially for plain paper and transparencies. For more information on paper specifications, call your nearest authorized sales representative or the place where you purchased your DCP.

- Use label or transparencies that are designed for use in *laser* printers.
- For the best print quality, we recommend using long-grained paper.
- If you are using special paper and the paper has problems feeding from the paper tray, try again using the manual feed tray or multi-purpose tray.
- You can use recycled paper in this DCP.

Paper capacity of the paper trays

	Paper size	Number of sheets
Multi-purpose tray (MP tray) (DCP-8045D)	Width: 2.75 to 8.66 in. (69.8 to 220 mm) Height: 4.57 to 16.0 in. (116 to 406.4 mm)	50 sheets (20 lb or 80 g/m ²)
Manual feed tray (DCP-8040)	Width: 2.75 to 8.66 in. (69.8 to 220 mm) Height: 4.57 to 16.0 in. (116 to 406.4 mm)	Single sheet
Paper tray (Tray #1)	A4, Letter, Legal, B5 (ISO), B5 (JIS), Executive, A5, A6, B6 (ISO)	250 sheets (20 lb or 80 g/m ²)
Optional lower tray (Tray #2)	A4, Letter, Legal, B5 (ISO), B5 (JIS), Executive, A5, B6 (ISO)	250 sheets (20 lb or 80 g/m ²)
Duplex printing (DCP-8045D)	A4, Letter, Legal	—

Paper specifications for each paper tray

Model		DCP-8040	DCP-8045D
Paper types	Multi-purpose tray	N/A	Plain paper, Bond paper, Recycled paper, Envelope ^{*1} , Labels ^{*2} , and Transparency ^{*2}
	Manual feed tray	Plain paper, Bond paper, Recycled paper, Envelope, Labels, and Transparency	N/A
	Paper tray	Plain paper, Recycled paper, and Transparency ^{*2}	
	Optional Lower tray	Plain paper, Recycled paper, and Transparency ^{*2}	
Paper weights	Multi-purpose tray	N/A	16 to 43 lb (60 to 161 g/m ²)
	Manual feed tray	16 to 43 lb (60 to 161 g/m ²)	N/A
	Paper tray	16 to 28 lb (60 to 105 g/m ²)	
	Optional Lower tray	16 to 28 lb (60 to 105 g/m ²)	
Paper sizes	Multi-purpose tray	N/A	Width: 2.75 to 8.66 in. (69.8 to 220 mm) Height: 4.57 to 16.0 in. (116 to 406.4 mm)
	Manual feed tray	Width: 2.75 to 8.66 in. (69.8 to 220 mm) Height: 4.57 to 16.0 in. (116 to 406.4 mm)	N/A
	Paper tray	A4, Letter, Legal, B5 (ISO), B5 (JIS), Executive, A5, A6, B6 (ISO)	
	Optional Lower Tray	A4, Letter, Legal, B5 (ISO), B5 (JIS), Executive, A5, B6 (ISO)	

*1 Up to 3 envelopes

*2 Up to 10 sheets



When printing transparencies, remove each one from the face-down output tray after it exists the DCP.

How to load paper

To load paper or other media in the paper tray

- 1 Pull the paper tray completely out of the DCP.

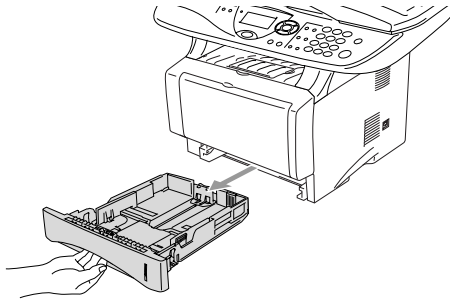

- 2 While pressing the paper guide release lever, slide the adjusters to fit the paper size.

Check that the guides are firmly in the slots.

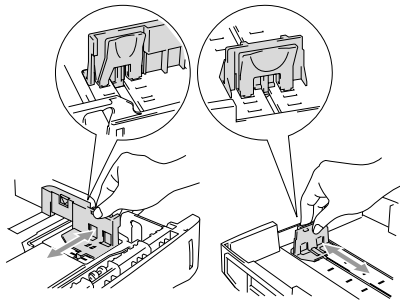

-  For Legal size paper, press the universal guide release button and pull out the back of the paper tray.

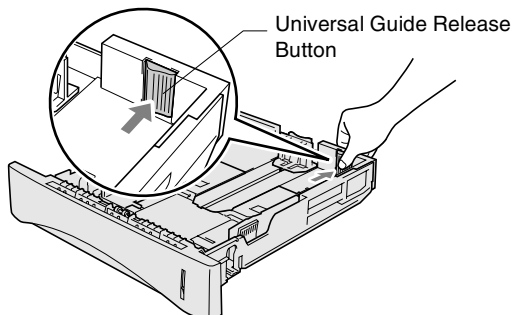

3 Fan the stack of paper well to avoid paper jams and misfeeds.

4 Put paper in the paper tray.

Check that the paper is flat in the tray, below the maximum paper mark, and that the paper guide is flush against the paper stack.

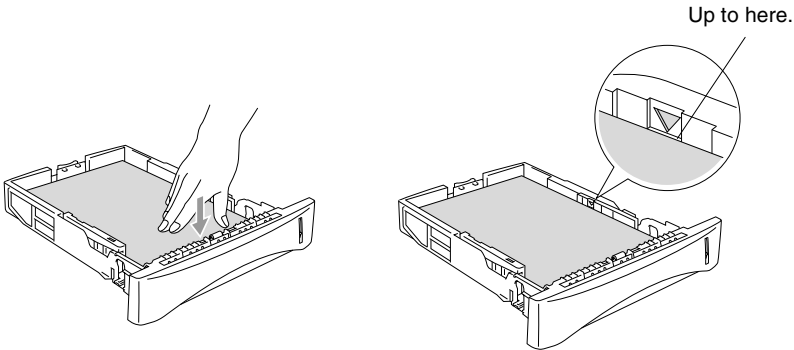

5 Put the paper tray firmly back in the DCP and unfold the support flap before you use the DCP.

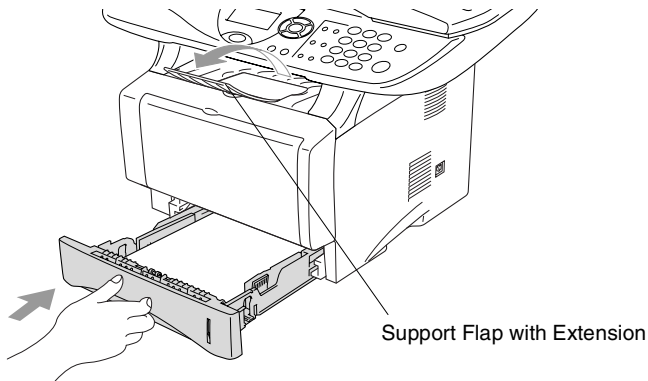

When you put paper in the paper tray, please remember the following

- The side to be printed on must be face down.
- Put the leading edge (top of the paper) in first and push it gently into the tray.
- To copy Legal size paper, unfold the support flap extension, too.

To load paper or other media in the manual feed tray (For DCP-8040)

 When printing envelopes and labels you should only use the manual feed tray.

- 1** Open the manual feed tray. Slide the paper guides to fit the paper size.

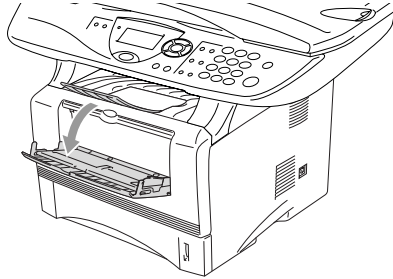

- 2** Using both hands put paper in the manual feed tray until the front edge of the paper touches the paper feed roller. Hold the paper in this position until the DCP automatically feeds the paper in for a short distance, and then let go of the paper.

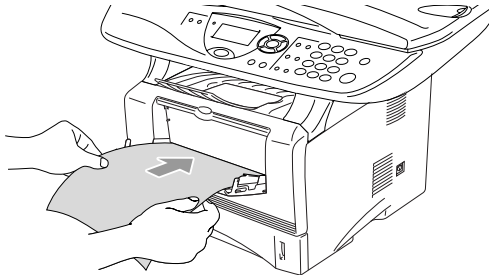



When you put paper in the manual feed tray, please remember the following

- The side to be printed on must be face up.
- Put the leading edge (top of the paper) in first and push it gently into the tray.
- Make sure that the paper is straight and in the proper position on the manual feed tray. If it is not, the paper may not be fed properly, resulting in a skewed printout or a paper jam.
- Do not put more than one sheet of paper or envelope in the manual feed tray at any one time, or it may cause a jam.

To load paper or other media in the multi-purpose tray (MP tray) (For DCP-8045D)

 When printing envelopes and labels you should only use the multi-purpose tray.

- 1 Open the MP tray and lower it gently.

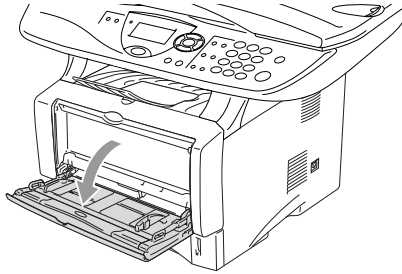

- 2 Pull out and unfold the MP tray support flap.

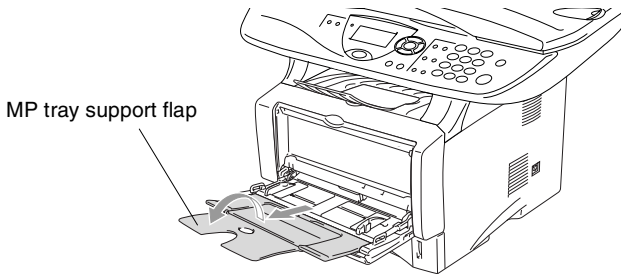

- 3 When loading paper in the MP tray, make sure it touches the back of the tray.

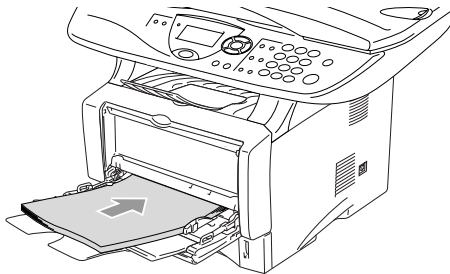

 Make sure that the paper is straight and in the proper position on the MP tray. If it is not, the paper may not be fed properly, resulting in a skewed printout or a paper jam.



You can place up to 3 envelopes or up to 50 sheets of 80 g/m² or 20 lb paper in the MP tray.

- 4 While pressing the paper-guide release lever, slide the paper guide to fit the paper size.

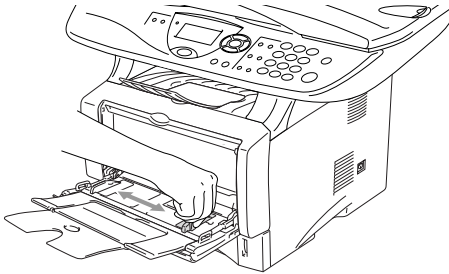

When you put paper in the MP tray, please remember the following:

- The side to be printed on must be face up.
- During printing, the inside tray rises to feed paper into the DCP.
- Put the leading edge (top of the paper) in first and push it gently into the tray.

To use Automatic Duplexing for copy and print operations (For DCP-8045D)

If you want to print on both sides of the paper using the Duplex feature for copy or print, you will need to set the Paper Adjustment Lever to the size of paper you are using.

This feature is available for A4, Letter or Legal size paper. (See *Duplex/N in 1* on page 5-11 and *Two-sided printing (Duplex Printing)* on page 6-3.)

- 1** Load paper in the Paper Tray or Multi-purpose Tray.
- 2** Set the Paper Adjustment Lever for Duplex Printing, in the back of the DCP, to match your paper size.

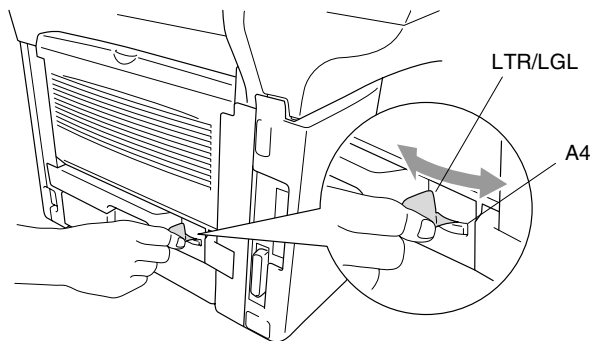

- 3** Your DCP is now ready to print two-sided pages.

3 On-screen programming



User-friendly programming

Your DCP is designed to be easy to use with LCD on-screen programming using the navigation keys. User-friendly programming helps you take full advantage of all the menu selections your DCP has to offer.

Since your programming is done on the LCD, we have created step-by-step on-screen instructions to help you program your DCP. All you need to do is follow the instructions as they guide you through the menu selections and programming options.

Menu table

You can probably program your DCP without the User's Guide. But to help you understand the menu selections and options that are found in the DCP programs, use the Menu table on page 3-4.

You can program your DCP by pressing **Menu** followed by the menu number. For example: to set `Quality` to `Photo`, press **Menu, 2, 1** and  or  to select `Photo`, and then press **Set**.

Navigation keys

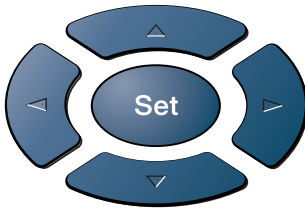

Clear/Back



Menu



* Access the menu



* Go to the next menu level

* Accept an option



* Exit the menu by pressing repeatedly

* Go back to the previous menu level



* Scroll through the current menu level



* Go back to the previous menu level



* Go forward to the next menu level

⏏ Stop/Exit



* Exit the menu

You can access the menu mode by pressing **Menu**.

When you enter the menu, the LCD scrolls.

Press **1** for General Setup menu

—OR—

Press **2** for Copy menu

—OR—

Press **3** for Printer menu



—OR—

Press **4** for LAN menu

(Only for the optional LAN board (NC-9100h) is installed.)



—OR—

1.General Setup
2.Copy
3.Printer
4.LAN
Select ▲▼ & Set

You can scroll more quickly through each menu level by pressing the arrow for the direction you want:  or .

Then set an option by pressing **Set** when that option appears on the LCD.

The LCD will then show the next menu level.

Press  or  to scroll to your next menu selection.

Press **Set**.

When you finish setting an option, the LCD shows *Accepted*.



Use  to scroll backward if you passed your choices or want to save keystrokes.

The current setting is always the option with “*”.

Press the Menu numbers.
(ex. Press 1, 1 for Paper Type)

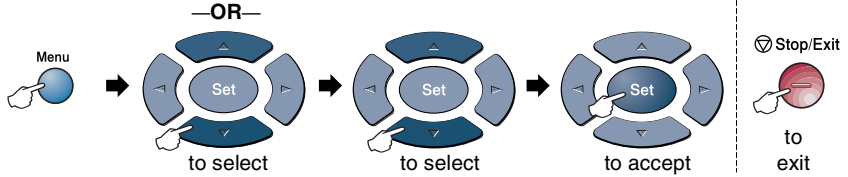

Main Menu	Submenu	Menu Selections	Options	Descriptions	Page
1.General Setup	1.Paper Type	1.MP Tray (DCP-8045D)	Thin Plain* Thick Thicker Transparency	Sets the type of paper in the Multi-purpose tray.	4-1
		2.Tray #1 (This menu only appears if you have the optional tray #2.)	Thin Plain* Thick Thicker Transparency	Sets the type of paper in paper tray #1.	4-1
		3.Tray #2 (option)	Thin Plain* Thick Thicker Transparency	Sets the type of paper in paper tray #2.	4-1
	2.Paper Size	1.Tray #1 (This menu only appears if you have the optional tray #2.)	A4 Letter* Legal Executive A5 A6 B5 B6	Sets the size of paper in paper tray #1.	4-3
		2.Tray #2 (option)	A4 Letter* Legal Executive A5 B5 B6	Sets the size of paper in paper tray #2.	4-3



The default settings are shown in Bold with *.

Press the Menu numbers.
(ex. Press 1, 1 for Paper Type)

—OR—

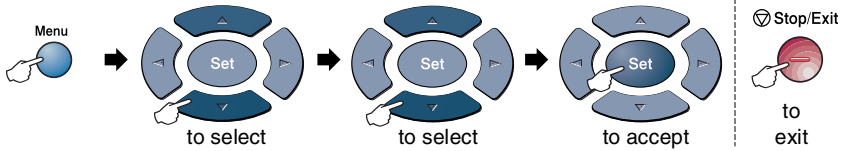

Main Menu	Submenu	Menu Selections	Options	Descriptions	Page
1.General Setup (Continued)	3.Beeper	—	Low Med * High Off	Adjusts the volume level of the beeper.	4-4
	4.Ecology	1.Toner Save	On Off *	Increases the life of the toner cartridge.	4-4
		2.Sleep Time	(00-99) 05Min *	Conserves power.	4-5
	5.Tray Use: Copy (For DCP-8040, this menu does not appear.) (If you have the optional tray#2, see page 3-9.)	—	Tray#1 Only MP Only Auto *	Selects the tray that will be used for Copy mode.	4-6
	5.LCD Contrast (For DCP-8040) 6.LCD Contrast (For DCP-8045D) (If you have the optional tray#2, see page 3-9.)	—	—	- □□□■ + - □□□□ + - □□■□ + * - □■□□ + - ■□□□ +	Adjusts the contrast of the LCD.
6.Drum Life (For DCP-8040) 7.Drum Life (For DCP-8045D) (If you have the optional tray#2, see page 3-9.)	—	—	—	You can check the percentage of drum life that remains available.	14-34



The default settings are shown in **Bold** with *.

Press the Menu numbers.
(ex. Press 1, 1 for Paper Type)

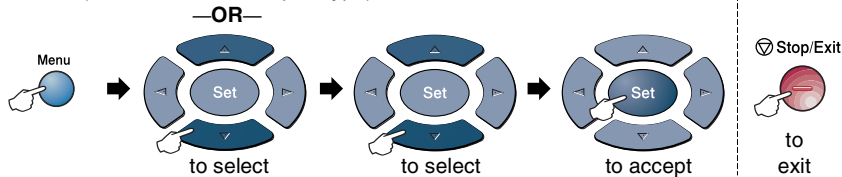

Main Menu	Submenu	Menu Selections	Options	Descriptions	Page
1.General Setup (Continued)	7. Page Counter (For DCP-8040) 8. Page Counter (For DCP-8045D) (If you have the optional tray#2, see page 3-9.)	—	Total Copy Print List	Lets you check the number of total pages the DCP has printed so far.	14-34
	8. User Settings (For DCP-8040) 9. User Settings (For DCP-8045D) (If you have the optional tray#2, see page 3-9.)	—	—	You can print lists.	4-7
	0. Local Language (Canada Only)	—	English* French	Allows you to change the LCD Language for your country.	See Quick Setup Guide
2.Copy	1. Quality	—	Text Photo Auto*	Selects the Copy resolution for your type of original.	5-17
	2. Contrast	—	- o o o o ■ + - o o o o ■ + - o o ■ o o + * - ■ o o o o + - ■ o o o o +	Adjusts the contrast for copies.	5-17
3.Printer	1. Emulation	—	Auto* HP LaserJet BR-Script 3	Selects the Emulation mode.	6-17
	2. Print Options	1. Internal Font	—	Prints a list of the DCP's internal fonts or current printer settings.	6-18
		2. Configuration	—		6-18
3. Reset Printer	—	—	—	Returns the DCP to the default settings.	6-18



The default settings are shown in Bold with *.

Press the Menu numbers.
(ex. Press 1, 1 for Paper Type)

—OR—

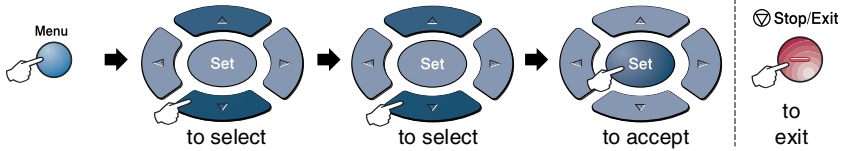

If you installed optional LAN board (NC-9100h), the LCD shows the following LAN menu. (See the Network User's Guide on the CD-ROM.)

Main Menu	Submenu	Menu Selections	Options	Descriptions	Page
4.LAN (option)	1.Setup TCP/IP	1.BOOT Method	Auto * Static RARP BOOTP DHCP	You can choose the BOOT method that best suits you needs.	See Network User's Guide on the CD-ROM.
		2.IP Address	[000-255]. [000-255]. [000-255]. [000-255]	Enter the IP address.	
		3.Subnet Mask	[000-255]. [000-255]. [000-255]. [000-255]	Enter the Subnet mask.	
		4.Gateway	[000-255]. [000-255]. [000-255]. [000-255]	Enter the Gateway address.	
		5.Host Name	BRN_XXXXXX	Enter the Host name.	
		6.WINS Config	Auto * Static	You can choose the WINS configuration mode.	
		7.WINS Server	Primary Secondary	Specifies the IP address of the primary or secondary server.	
		8.DNS Server	Primary Secondary	Specifies the IP address of the primary or secondary server.	
		9.APIPA	On * Off	Automatically allocates the IP address from the link-local address range.	

The default settings are shown in Bold with *.

Press the Menu numbers.
(ex. Press 1, 1 for Paper Type)

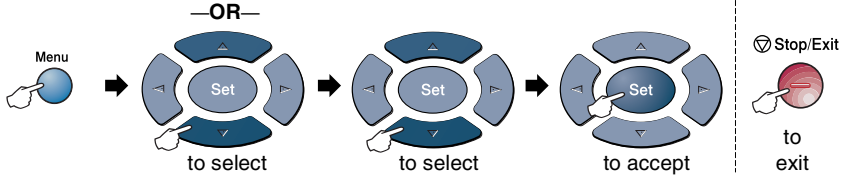

(See the Network User's Guide on the CD-ROM.)

Main Menu	Submenu	Menu Selections	Options	Descriptions	Page
4.LAN (option) (Continued)	2.Setup Misc.	1.Netware	On * Off	Select On to use the DCP on a Netware network.	See Network User's Guide on the CD-ROM.
		2.Net Frame	Auto * 8023 ENET 8022 SNAP	Lets you specify the frame type.	
		3.AppleTalk	On * Off	Select On to use the DCP on a Macintosh network.	
		4.DLC/LLC	On * Off	Select On to use the DCP on a DLC/LLC network.	
		5.Net BIOS/IP	On * Off	Select On to use the DCP on a Net BIOS/IP network.	
		6.Ethernet	Auto * 100B-FD 100B-HD 10B-FD 10B-HD	Selects Ethernet link mode.	



The default settings are shown in Bold with *.



If you have the optional paper tray, the LCD displays these menu options.

(For DCP-8040 with the optional paper tray #2)

Main Menu	Submenu	Menu Selections	Options	Descriptions	Page
1.General Setup	5.Tray Use: Copy	—	Tray#1 Only Tray#2 Only Auto *	Select the tray that will be used for copying.	4-6
	6.LCD Contrast	—	- o o o o ■ + - o o o ■ o + - o o ■ o o + * - o ■ o o o + - ■ o o o o +	Adjusts the contrast of the LCD.	4-7
	7.Drum Life	—	—	You can check the percentage of drum life that remains available.	14-34
	8.Page Counter	—	Total Copy Print List	Lets you check the number of total pages the DCP has printed so far.	14-34
	9.User Settings	—	—	You can print lists.	4-7

(For DCP-8045D with the optional paper tray #2)

Main Menu	Submenu	Menu Selections	Options	Descriptions	Page
1.General Setup	5.Tray Use: Copy	—	Tray#1 Only Tray#2 Only MP Only Auto *	Select the tray that will be used for copying.	4-6
	6.LCD Contrast	—	- o o o o ■ + - o o o ■ o + - o o ■ o o + * - o ■ o o o + - ■ o o o o +	Adjusts the contrast of the LCD.	4-7
	7.Drum Life	—	—	You can check the percentage of drum life that remains available.	14-34
	8.Page Counter	—	Total Copy Print List	Lets you check the number of total pages the DCP has printed so far.	14-34
	9.User Settings	—	—	You can print lists.	4-7



The default settings are shown in Bold with *.

Key Operations table

You can use the keys on the control panel to conveniently choose *temporary* copy settings and access the scanning operations. The Key Operations Table below will help you understand the options they provide.

Temporary keys	Options	Descriptions	Page
Secure	—	Print data saved in the memory by entering your four-digit password.	6-16
Job Cancel	—	Clear data from the printer memory.	6-16
Scan	Scan to E-mail	Scan a black & white or color original into your E-mail application as a file attachment.	8-17
	Scan to Image	Scan an image into your graphics application (such as a color picture) for viewing and editing.	8-17
	Scan to OCR	Scan a text document so ScanSoft® will perform OCR in OmniPage® to convert it to editable text and display it in your word processing application.	8-18
	Scan to File	Scan a black & white or a color original into your computer and save it as a file in the folder you choose.	8-18
Enlarge/Reduce	104%, 141%, 200%, 50%, 70%, 78%, 83%, 85%, 91% Full Page, 94%, 97%, AUTO, Custom (25-400), 100%	Enlarge or reduce the size of copies.	5-6
Contrast	- □□■□□ +	Adjust the contrast.	5-9
Quality	Auto, Text, Photo	Select the Copy resolution for your type of original.	5-8
Tray Select (For DCP-8040)	#1 (XXX*), #2 (XXX*), Auto	Change the tray use only for the next copy.	5-10
(For DCP-8045D)	#1 (XXX*), #2 (XXX*), MP Tray, Auto		5-10
Sort		Sort multiple copies, using the ADF.	5-8
N in 1 (For DCP-8040)	2 in 1 (P), 2 in 1 (L), 4 in 1 (P), 4 in 1 (L), Poster, off	Change the layout of copies on the print media.	5-12
Duplex/N in 1 (For DCP-8045D)	Portrait 1, Portrait 2, Landscape 1, Landscape 2		5-11

■ XXX* is the paper size you set.

■ #2 XXX* is shown when the optional paper tray is installed.

4 Getting started

General Setup

Setting the Paper Type

To get the best print quality, set the DCP for the type of paper you are using.

For DCP-8040



1 Press **Menu, 1, 1**.

—OR—

If you have the optional paper tray, press **Menu, 1, 1, 1** to set the paper type for Tray #1 or **Menu, 1, 1, 2** to set the paper type for Tray #2.

11.Paper Type
▲ Plain
Thick
▼ Thicker
Select ▲▼ & Set

11.Paper Type
1.Tray #1
2.Tray #2
Select ▲▼ & Set

2 Press  or  to select Thin, Plain, Thick, Thicker or Transparency.

3 Press **Set**.

4 Press **Stop/Exit**.

For DCP-8045D



- 1** Press **Menu, 1, 1, 1** to set the paper type for MP Tray.

—OR—

Press **Menu, 1, 1, 2** to set the paper type for Tray #1.

—OR—

If you have the optional paper tray, press **Menu, 1, 1, 3** to set the paper type for Tray #2.

- 2** Press  or  to select Thin, Plain, Thick, Thicker or Transparency.

- 3** Press **Set**.

- 4** Press **Stop/Exit**.



11.Paper Type
1.MP Tray
2.Tray #1
3.Tray #2
Select ▲▼ & Set

11.Paper Type
1.MP Tray
▲ Plain
▼ Thin
Select ▲▼ & Set

 You can select Transparency for Tray #1 and Tray #2 only when A4, Letter or Legal is selected in **Menu, 1, 2**.



Setting the Paper Size

You can use eight sizes of paper for printing copies: A4, letter, legal, executive, A5, A6, B5 and B6. When you change the size of paper in the DCP, you will need to change the setting for Paper Size at the same time so your DCP can fit reduced copy on the page.

- 1 Press **Menu, 1, 2**.
- 2 Press  or  to select A4, Letter, Legal, Executive, A5, A6, B5 or B6.
Press **Set**.
- 3 Press **Stop/Exit**.

12.Paper Size
▲ A4
Letter
▼ Legal
Select ▲▼ & Set

With optional paper tray (LT-5000)

- 1 Press **Menu, 1, 2, 1** to set the paper size for Tray #1.
—OR—
Press **Menu, 1, 2, 2** to set the paper size for Tray #2.
- 2 Press  or  to select A4, Letter, Legal, Executive, A5, A6, B5 and B6.
Press **Set**.
- 3 Press **Stop/Exit**.



12.Paper Size
1.Tray #1
2.Tray #2
Select ▲▼ & Set



- If you are using the optional paper tray, paper size A6 is not available.
- If you select Transparency in **Menu, 1, 1**, you can only select A4, Letter or Legal.

Setting the Beeper Volume



You can change the beeper volume. The default setting is **Med.** When the beeper is on, the DCP beeps every time you press a key or make a mistake.

- 1 Press **Menu, 1, 3.**
- 2 Press  or  to select your option.
(Low, Med, High or Off)
Press **Set.**
- 3 Press **Stop/Exit.**

13. Beeper
▲ Med
High
▼ Off
Select ▲▼ & Set

Toner Save

You can conserve toner using this feature. When you set Toner Save to **On**, print appears somewhat lighter. The default setting is **Off.**

- 1 Press **Menu, 1, 4, 1.**
- 2 Press  or  to select **On** (or **Off**).
- 3 Press **Set.**
- 4 Press **Stop/Exit.**

14. Ecology
1. Toner Save
▲ On
▼ Off
Select ▲▼ & Set

Sleep Time



Setting the Sleep Time reduces power consumption by turning off the fuser inside the DCP, while it is idle. You can choose how long the DCP is idle (from 00 to 99 minutes) before it goes into sleep mode. The timer is automatically reset when the DCP receives PC data, or makes a copy. The factory setting is 05 minutes. While the DCP is in sleep mode, you will see **Sleep** on the LCD. If you try to print or copy in sleep mode, there will be a short delay while the fuser warms up to working temperature.

- 1 Press **Menu**, **1**, **4**, **2**.
- 2 Use the Numeric keys to enter the length of time the DCP is idle before it goes into sleep mode (00 to 99).
- 3 Press **Set**.
- 4 Press **Stop/Exit**.



- If you want to turn sleep mode off, press **Secure** and **Job Cancel** simultaneously in Step 2.
- If the DCP is in Sleep Mode when you change the Sleep Time, the new setting will take effect the next time the DCP copies or prints is restarted.

Turning off the Scanner Lamp

The scanner lamp stays on for 16 hours before automatically switching off to preserve the life of the lamp. You can turn off the scanner lamp manually if you wish by pressing the  and  keys simultaneously. The scanner lamp will remain turned off until the next time you use the scanning feature.

Turning off the scanner lamp will also reduce the power consumption.



- Please note that turning the lamp off regularly will reduce the lamp's life. Some people prefer to turn the lamp off as they leave the office, or late at night at home. This is not necessary for normal day to day use.



Setting the Tray Use for Copy mode



If your DCP is a DCP-8040 without the optional tray #2, you can skip this setting.

DCP-8040



The default setting of **Auto** allows ^{*1}your DCP to choose the optional Tray #2 when paper is out in Tray #1 or ^{*2}when the size of the original will fit best on the paper in Tray #2.

- 1 Press **Menu, 1, 5**.
- 2 Press  or  to select **Tray#1 Only, Tray#2 Only, or Auto**.
- 3 Press **Set**.
- 4 Press **Stop/Exit**.



15.Tray Use:Copy
▲ Tray#1 Only
Tray#2 Only
▼ Auto
Select ▲▼ & Set

DCP-8045D

The default setting of **Auto** allows ^{*1}your DCP to choose the optional Tray #2 or the MP Tray when paper is out in Tray #1 and ^{*2}when the size of the original will fit best on the paper in Tray #2.

- 1 Press **Menu, 1, 5**.
- 2 Press  or  to select **Tray#1 Only, MP Only, or Auto**.

—OR—

If you have the optional paper tray. Press  or  to select **Tray#1 Only, Tray#2 Only, MP Only, or Auto**.

- 3 Press **Set**.
- 4 Press **Stop/Exit**.

15.Tray Use:Copy
▲ Tray#1 Only
MP Only
▼ Auto
Select ▲▼ & Set

15.Tray Use:Copy
▲ Tray#1 Only
Tray#2 Only
▼ MP Only
Select ▲▼ & Set



^{*1} Copies will automatically be printed from Tray #2 only if the Paper Size setting for Tray #2 is the same as Tray #1.

^{*2} When using the ADF, copies will automatically be printed from Tray #2 if the Paper Size setting for Tray #2 is different than Tray #1 and this paper size is more suitable for the scanned original.

Setting the LCD Contrast

You can change the contrast to help the LCD look lighter or darker.

- 1 (DCP-8040)
Press **Menu, 1, 5.**
(DCP-8045D)
Press **Menu, 1, 6.**

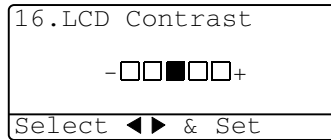

—OR—

If you have the optional Tray #2, press **Menu, 1, 6.**

- 2 Press  to increase the contrast.

—OR—

Press  to decrease the contrast.

Press **Set.**

- 3 Press **Stop/Exit.**

Printing the User Settings List

You can print a list of various settings.

- 1 (DCP-8040)
Press **Menu, 1, 8.**
(DCP-8045D)
Press **Menu, 1, 9.**

—OR—

If you have the optional Tray #2, press **Menu, 1, 9.**

- 2 Press **Start.**

5 Making copies

Using the DCP as a copier

Your DCP can make up to 99 copies at a time.

Printable area

The printable area of your DCP begins at approximately 0.14 in. (3.64 mm) on both sides and 0.12 in. (3 mm) on the top and bottom of the paper.

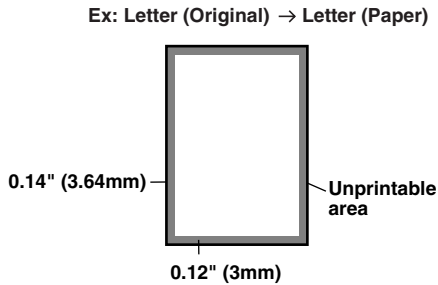

Temporary copy settings

You can improve your copies by using the temporary copy keys (**Copy**): **Enlarge/Reduce**, **Contrast**, **Quality**, **Tray Select**, **Sort** and **N in 1** (For DCP-8040) or **Duplex/N in 1** (For DCP-8045D). These settings are *temporary*, and the DCP returns to its default settings 1 minute after it finishes copying. If you want to use these temporary settings again, place the next original in the ADF or on the scanner glass within that time.

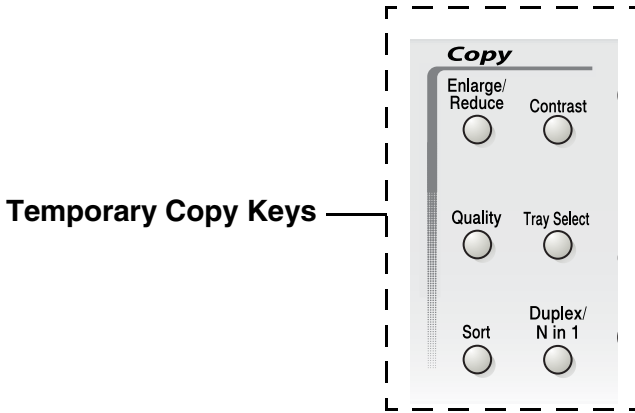

Making a single copy from the ADF

- 1 Place the original face up in the ADF.
 - 2 Press **Start**.
Do **NOT** pull on the original while copying is in progress.
-  To stop copying and eject the original, press **Stop/Exit**.

Making multiple copies from the ADF

- 1 Insert the original face up in the ADF.
 - 2 Use the Numeric keys to enter the number of copies you want (up to 99).
 - 3 Press **Start**.
-  To sort the copies, press the **Sort** key.

Single or multiple copies using the scanner glass

You can make multiple copies using the scanner glass. Multiple copies will be stacked (all copies of page 1, then all copies of page 2, and so on). Use the Temporary Copy keys to choose more settings. (See *Using the copy keys (temporary settings)* on page 5-5.)

- 1 Lift the document cover.

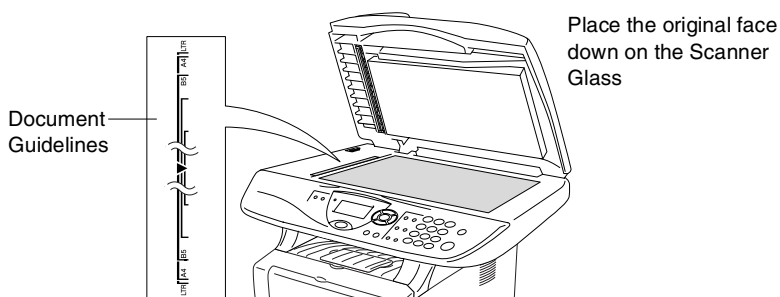

- 2 Using the document guidelines on the left, center the original face down on the scanner glass and close the document cover.
- 3 Using the numeric keys, enter the number of copies you want (up to 99).
For example, press **3 8** for 38 copies.
- 4 Press **Start**.
The DCP will start scanning the original.



If you want to sort multiple copies, use the ADF.

(See *Making a single copy from the ADF* on page 5-3.)

Out of Memory message

If the Out of Memory message appears, press **Stop/Exit** to cancel or **Start** to copy scanned pages.

Out of Memory
Copy: Press Start
Quit: Press Stop



If this error message appears more than once you may wish to consider increasing the memory size. For more information on how to increase the memory size, see *Memory board* on page 15-1.

Using the copy keys (temporary settings)

When you want to change the settings only for the next copy, use the temporary copy keys.

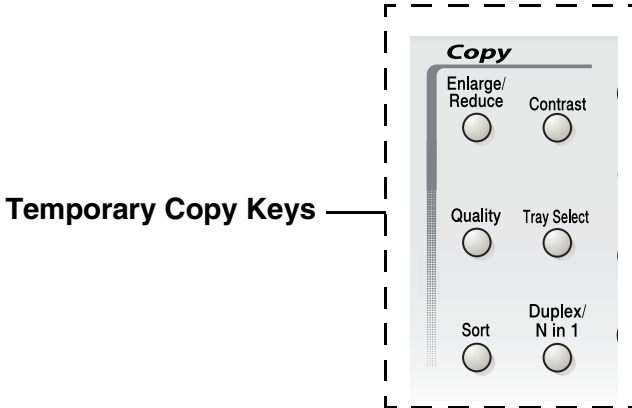

Temporary Copy Keys

You can use different combinations. The large LCD shows your current copy mode settings.

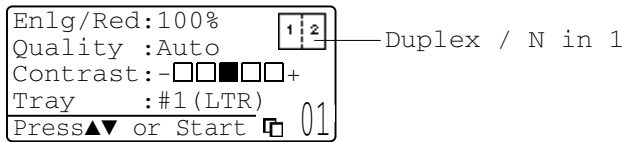

Example of Copy mode LCD

Enlarge/Reduce

You can select the following enlargement or reduction ratios.

Auto sets the DCP to calculate the reduction ratio that fits the size of your paper.

Custom allows you to enter a ratio from 25% to 400%.



Press Enlarge/Reduce	
	100%
	104% (EXE → LTR)
	141% (A5 → A4)
	200%
	Auto
	Custom (25 - 400%)
	50%
	70% (A4 → A5)
	78% (LGL → LTR)
	83% (LGL → A4)
	85% (LTR → EXE)
	91% (Full Page)
	94% (A4 → LTR)
97% (LTR → A4)	

 **Auto** appears only when you place the document in the ADF.

- 1 Place the original face up in the ADF, or face down on the scanner glass.
- 2 Use the numeric keys to enter the number of copies you want (up to 99).
- 3 Press **Enlarge/Reduce**.
- 4 Press **Enlarge/Reduce** or .

Enlg/Red:100%
Quality :Auto
Contrast:-□□■□□+
Tray :#1(LTR)

01

5 Press  or  to select the enlargement or reduction ratio you want.

Press **Set**.

—OR—

You can select *Custom* (25-400%) and press **Set**.

Use the numeric keys to enter an enlargement or reduction ratio from 25% to 400%.

Press **Set**.

(For example, press **5 3** to enter 53%.)

6 Press **Start**.

—OR—

Press other temporary copy keys for more settings.





■ Special Copy Options (2in1, 4in1 or Poster) are not available with **Enlarge/Reduce**.

■ *Auto* is not available with the scanner glass.

Quality (type of original)

You can select the Quality for your type of original. The default setting is **Auto**, which is used for originals that contain both text and photographs. **Text** is used for originals containing only text. **Photo** is used for copying photographs.

- 1** Place the original face up in the ADF, or face down on the scanner glass.
 - 2** Use the numeric keys to enter the number of copies you want (up to 99).
 - 3** Press **Quality**.
 - 4** Press  or  to choose the type of original (**Auto**, **Text** or **Photo**).
- Press **Set**.
- 5** Press **Start**.

—OR—

Press other Temporary Copy keys for more settings.

Sorting copies using the ADF

If you want to sort multiple copies, use the ADF. Pages will be printed in the order 123, 123, 123, and so on.



- 1** Place the original face up in the ADF.
- 2** Use the numeric keys to enter the number of copies you want (up to 99).
- 3** Press **Sort**.
- 4** Press **Start**.

—OR—

Press other Temporary Copy keys for more settings.

Contrast

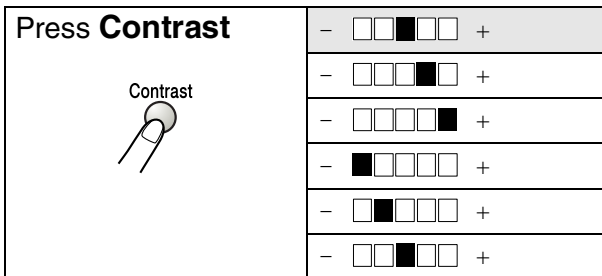

You can adjust the copy contrast to make copies darker or lighter.

- 1 Place the original face up in the ADF, or face down on the scanner glass.
- 2 Use the numeric keys to enter the number of copies you want (up to 99).
- 3 Press **Contrast**.
- 4 Press  to make a copy lighter
—OR—
Press  to make a copy darker.
Press **Set**.
- 5 Press **Start**.
—OR—
Press other Temporary Copy keys for more settings.



Tray Select

You can change the tray use only for the next copy.

- 1** Place the original face up in the ADF, or face down on the scanner glass.
- 2** Use the numeric keys to enter the number of copies you want (up to 99).
- 3** Press **Tray Select**.
- 4** Press  or  to select the tray usage.
Press **Set**.
- 5** Press **Start**.
—OR—
Press other Temporary Copy keys for more settings.

(For DCP-8040 with the optional paper tray #2)

Press Tray Select Tray Select 	Auto
	#1 (XXX*)
	#2 (XXX*)

(For DCP-8045D with the optional paper tray #2)

Press Tray Select Tray Select 	Auto
	#1 (XXX*)
	#2 (XXX*)
	MP Tray











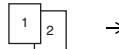
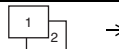

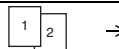

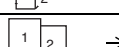

XXX* is the paper size you set in **Menu, 1, 2**.



For DCP-8040 the LCD displays the tray use selections only if the optional paper tray is installed.

Duplex/N in 1

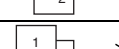
'Duplex' prints on both sides of the paper.

Temporary Key	Level 1	Level 2	Option	Original → Finished Layout	
Press Duplex/N in 1 (DCP-8045D) N in 1 (DCP-8040) Duplex/ N in 1 	N in 1	—	2 in 1 (P)		
			2 in 1 (L)		
			4 in 1 (P)		
			4 in 1 (L)		
	Duplex(1 in 1) (DCP-8045D)	Portrait1	—	—	
				Portrait2	Single Sided
		Landscape1	—	Single Sided	
				Double Sided	
		Landscape2	—	—	
				—	
	Duplex(2 in 1) (DCP-8045D)	—	—	Portrait1	
				Portrait2	
				Landscape1	
				Landscape2	
	Duplex(4 in 1) (DCP-8045D)	—	—	Portrait1	
				Portrait2	
				Landscape1	
				Landscape2	
	Poster	—	—	—	
	Off	—	—	—	—



Duplex/N in 1 copy

N in 1 copy

You can save paper by copying either two or four pages onto one page. Please make sure paper size is set to A4, Letter or Legal.

- 1 Place the original face up in the ADF, or face down on the scanner glass.
- 2 Use the numeric keys to enter the number of copies you want (up to 99).
- 3 Press **Duplex/N in 1**.

Press **Set** to select N in 1.

- 4 Press  or  to select 2 in 1 (P), 2 in 1 (L), 4 in 1 (P) or 4 in 1 (L).



Press **Set**.

- 5 If you are ready to copy, go to Step 7.

—OR—

Press  or  to select Quality, Contrast or Tray.

Press **Set**.

- 6 Press  or  to select a new setting.

Press **Set**.

- 7 Press **Start**.

If you are using the ADF, the DCP scans the originals and prints the copies.

—OR—

If you are using the scanner glass, the DCP scans the page. Place the next original on the scanner glass.

- 8 Select **1** and press **Set**, or press **1**, to copy next page.

- 9 Repeat Steps 7 and 8 for each page of the layout.

Enlg/Red:100%
Quality :Auto
Contrast:-□□■□□+
Tray :#1(LTR)
Press ▲▼ or Start 01

Flatbed Copy:
Next Page?
▲ 1.Yes
▼ 2.No
Select ▲▼ & Set

10 After all the pages of the original have been scanned, select **2** and press **Set**, or press **2**, to print the copies.





- (P) means Portrait and (L) means Landscape.
- You can also combine the **N in 1** and **Duplex** operations. (See *Duplex (2 in 1)* and *Duplex (4 in 1)* (For DCP-8045D) on page 5-16.)
- For **2 in 1 (P)**, **2 in 1 (L)**, **4 in 1 (P)** or **4 in 1 (L)**, you can not use the **Enlarge/Reduce** setting.

Poster

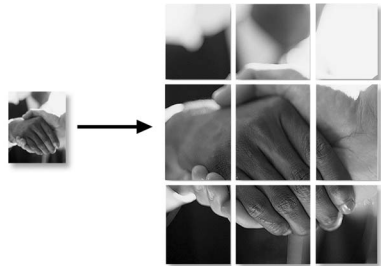
You can make a poster size copy of a photograph. You must use the scanner glass.



- 1** Place the original face down on the scanner glass.
- 2** Press **Duplex/N in 1** and  or  to select **Poster**. Press **Set**.
- 3** Press **Start**.

The DCP starts scanning the original and prints the pages for the poster.









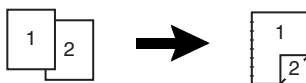

For poster copies, you cannot make more than one copy or use the **Enlarge/Reduce** setting.

Duplex (1 in 1) (For DCP-8045D)

Making a double-sided copy from a single-sided original







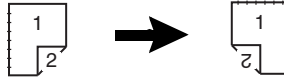

- 1 Place the original face up in the ADF, or face down on the scanner glass.
- 2 Use the numeric keys to enter the number of copies you want (up to 99).
- 3 Press **Duplex/N in 1** and  or  to select **Duplex(1 in 1)**.
Press **Set**.
- 4 Press  or  to select **Portrait2** or **Landscape1**.
Press **Set**.
—OR—
Press  or  to select **Portrait1** or **Landscape2**, and then go to Step 6.
- 5 Press  or  to select **Single Sided** for the original.
(If you are using the scanner glass or changed the number of copies at Step 2, this option will not appear.)
Press **Set**.
- 6 Press **Start**. The DCP starts scanning.
If you are using the ADF, the DCP starts printing the copy.
—OR—
If you placed the original on the scanner glass, go to Step 7.
- 7 Place the next original on the scanner glass.
Select **1** and press **Set** or press **1**.
Repeat Step 7 for each page of the original.
- 8 After all the pages of the original have been scanned, select **2** and press **Set**, or press **2**, to print the copy.





Flatbed Copy: Next Page? ▲ 1.Yes ▼ 2.No Select ▲▼ & Set

Making a double-sided copy from a double-sided original



- 1** Place the original face up in the ADF.
- 2** Press **Duplex/N in 1** and  or  to select Duplex(1 in 1).
Press **Set**.
- 3** Press  or  to select Portrait2 or Landscape1.
Press **Set**.
- 4** Press  or  to select Double Sided for the original.
Press **Set**.
- 5** Make sure that you have put the original in the ADF as shown on the LCD and press **Start**.
- 6** After all the pages of the original have been scanned on one side, turn over the original so the other side is face up in the ADF.
Press **Start**.

Duplex (2 in 1) and Duplex (4 in 1) (For DCP-8045D)

- 1 Place the original face up in the ADF, or face down on the scanner glass.
- 2 Use the numeric keys to enter the number of copies you want (up to 99).
- 3 Press **Duplex/N in 1** and  or  to select Duplex(2 in 1) or Duplex(4 in 1).
Press **Set**.
- 4 Press  or  to select Portrait1, Portrait2, Landscape1 or Landscape2.
Press **Set**.
- 5 Press **Start**. The DCP starts scanning.
If you are using the ADF, the DCP starts printing the copy.

—OR—

If you placed the original on the scanner glass, go to Step 6.

- 6 Place the next original on the scanner glass.
Select **1** and press **Set**, or press **1**.
Repeat Step 6 for each page of the original.

Flatbed Copy: Next Page? ▲ 1.Yes ▼ 2.No Select ▲▼ & Set



- 7 After all the pages of the original have been scanned, select **2** and press **Set**, or press **2**, to print the copy.

Changing the default copy settings

You can adjust the copy settings that are shown in the chart. These settings will stay until you change them again.

Submenu	Menu Selections	Options	Factory Settings
1.Quality	—	Text	Auto
		Photo	
		Auto	
2.Contrast	—	- ◻◻◻◻ + - ◻◻◻◻ + - ◻◻◻◻ + - ◻◻◻◻ + - ◻◻◻◻ +	- ◻◻◻◻ +



Quality

- 1 Press **Menu**, **2**, **1**.
- 2 Press  or  to select **Text**, **Photo** or **Auto**.
Press **Set**.
- 3 Press **Stop/Exit**.



Contrast

You can change the contrast to help an image look lighter or darker.

- 1 Press **Menu**, **2**, **2**.
- 2 Press  to make lighter.
—OR—
Press  to make darker.
Press **Set**.
- 3 Press **Stop/Exit**.

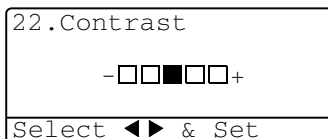

6 Using the DCP as a printer

Using the Brother DCP-8040, DCP-8045D printer driver

A Printer Driver is software that translates data from the format used by a computer into the format required by a particular printer, using a printer command language or page description language.

The printer drivers are on the CD-ROM we have supplied. Install the drivers first by following the Quick Setup Guide. Also, the latest printer driver can be downloaded from the Brother Solutions Center at:

<http://solutions.brother.com>

Windows® Printing

The dedicated printer driver and TrueType™ compatible fonts for Microsoft® Windows® 98/98SE/Me/2000 Professional/XP and Windows NT® workstation 4.0 are available on the CD-ROM supplied with your DCP. You can install them easily into your Windows® system using our installer program. The driver supports our unique compression mode to enhance printing speed in Windows® applications, and allows you to set various printer settings, including economy printing mode and custom paper size.

Popular Printer Emulation Support

The DCP supports HP LaserJet (PCL level 6) and BR-Script 3 (PostScript® 3™) printer emulation mode. If you use DOS application software, you can use HP LaserJet (PCL level 6) and BR-Script 3 (PostScript® 3™) emulation mode for printer operations.

How to print your document

When the DCP receives data from your computer, it begins printing by picking up paper from the paper tray. The paper tray can feed many types of paper and envelopes.

- 1** From your computer select the Print command.
If your computer is also connected to any other printers, select **Brother DCP-8040** or **DCP-8045D (USB) Printer** as your printer driver from the Print or Print Settings menu in your software application, and then click on OK to begin printing.
 - 2** Your computer sends a print command and data to the DCP.
 - 3** The LED blinks in yellow and the DCP starts to print.
-  You can select the paper size, and orientation in your application software.

If your application software does not support your custom paper size, select the next largest paper size.

Then adjust the print area by changing the right and left margins in your application software.

Simultaneous printing and scanning

Your DCP can print from your computer while scanning an original into the computer.

Two-sided printing (Duplex Printing)

The supplied printer driver supports duplex printing. (For more information, see *Duplex Printing* on page 7-7.)

Automatic Duplex Printing (For DCP-8045D)

In this mode, the DCP prints on both sides of the A4, Letter or Legal paper automatically.

- 1 Open the Properties dialog box in the printer driver.
- 2 Select Duplex Printing mode in the Advanced tab, make sure that '**Use Duplex Unit**' has been selected, and then click the **OK** button. (See *Duplex Printing* on page 7-7.) The printer will print on both sides of the paper automatically.



- When you select **Use Duplex Unit**, HQ1200 is not available.
- If you also want to use Duplex Printing for copy operations, see *To use Automatic Duplexing for copy and print operations (For DCP-8045D)* on page 2-11.

Manual Duplex Printing

The DCP prints all the even-numbered pages on one side of the paper first. Then, the Windows® driver instructs you (with a pop-up message) to reinsert the paper. Before reinserting the paper, straighten it well, or you may get a paper jam. Very thin or very thick paper is not recommended. We recommend 20 to 24 lb (75 to 90 g/m²) paper.

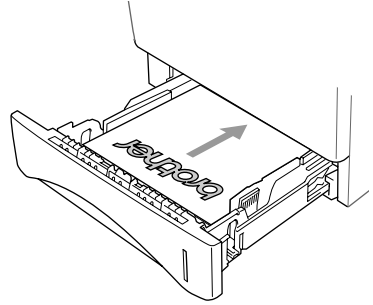

Face-down output tray

The DCP ejects paper with printed surfaces *face down* into the output tray in the front of the DCP. Unfold the support flap to support the printed pages.



When printing transparencies, remove each one from the support flap after it exits the DCP.

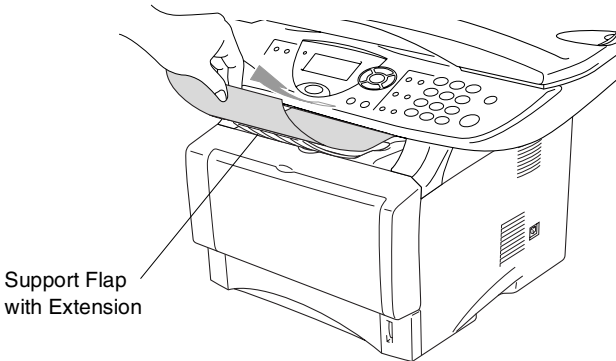

Printing on plain paper

The manual feed tray (For DCP-8040)

 The DCP automatically turns on the Manual Feed mode when you put paper in the manual feed tray.

- 1 Select the **Paper Size**, **Media Type**, **Paper Source**, and other settings in the printer driver.

Media Type: Plain Paper

Paper Source: Manual

- 2 Send the print data to the DCP.
- 3 Open the manual feed tray. Slide the paper guides to fit the paper size.
- 4 Using both hands put paper in the manual feed tray until the front edge of the paper touches the paper feed roller and the DCP grips the paper.

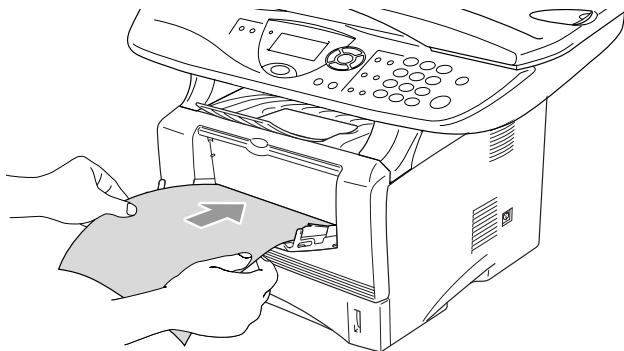

 ■ Make sure that the paper is straight and in the proper position on the manual feed tray. If it is not, the paper may not be fed properly, resulting in a skewed printout or a paper jam.

■ Do not put more than one piece of paper in the manual feed tray at any one time, or it may cause a jam.

- 5 After the printed page comes out of the DCP, put in the next sheet of paper as in Step 4 above. Repeat for each page that you want to print.

The MP tray (For DCP-8045D)

- 1 Select the **Paper Size**, **Media Type**, **Paper Source**, and other settings in the printer driver.

Media Type: Plain Paper

Paper Source: MP Tray

- 2 Open the MP tray and lower it gently.
- 3 Pull out the MP tray support flap.
- 4 When loading paper in the MP tray, make sure it touches the back of the tray.

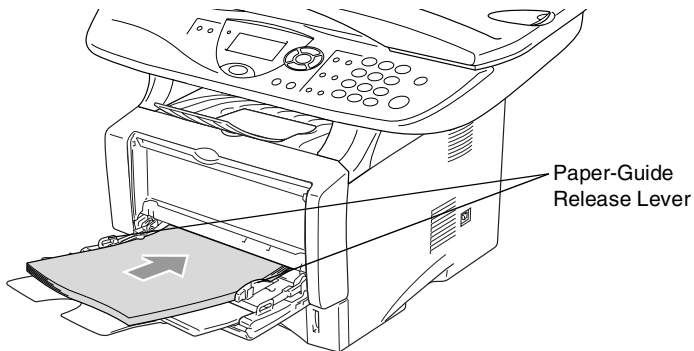

-  Make sure that the paper is straight and in the proper position on the MP tray. If it is not, the paper may not be fed properly, resulting in a skewed printout or a paper jam.

- 5 While pressing the paper-guide release lever, slide the paper guide to fit the paper size.

-  When you put paper in the MP tray, please remember the following:

- The side to be printed on must be face up.
- During printing, the inside tray rises to feed paper into the DCP.
- Put the leading edge (top of the paper) in first and push it gently into the tray.

- 6 Send the print data to the DCP.

Printing on thicker paper and card stock

When the back output tray is pulled down, the DCP has a straight paper path from the manual feed tray or the MP tray through to the back of the DCP. Use this paper feed and output method when you want to print on thicker paper or card stock.

The manual feed tray (For DCP-8040)

- 1 Select the **Paper Size**, **Media Type**, **Paper Source**, and other settings in the printer driver.

Media Type: Thick paper or Thicker paper

Paper Source: Manual

- 2 Open the back output tray.

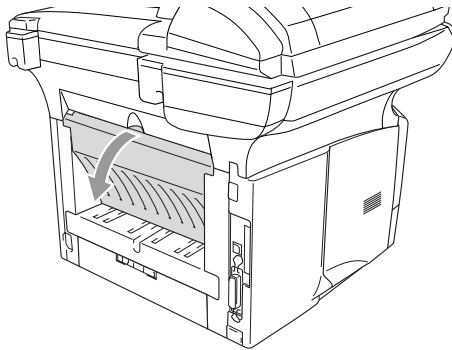

- 3 Open the manual feed tray. Slide the paper guides to fit the paper size.
- 4 Using both hands put the paper in the manual feed tray until the front edge of the paper touches the paper feed roller and the DCP grips the paper.



- Make sure that the paper is straight and in the proper position in the manual feed tray. If it is not, the paper may not be fed properly, resulting in a skewed printout or a paper jam.
- Do not put more than one piece of paper in the manual feed tray at any one time, or it may cause a jam.

- 5 Send the print data to the DCP.
- 6 After the printed page comes out of the DCP, put in the next sheet of paper as in Step 4 above. Repeat for each page that you want to print.
- 7 When you have finished the print job, close the back output tray.

! **Caution**

Remove each sheet immediately after printing. Stacking the sheets may cause a paper jam or the paper to curl.

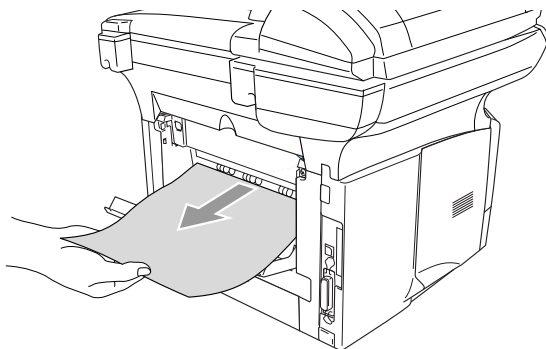

The multi-purpose tray (MP tray) (For DCP-8045D)

- 1 Select the **Paper Size**, **Media Type**, **Paper Source**, and other settings in the printer driver.

Media Type: Thick paper or Thicker paper

Paper Source: MP Tray

- 2 Open the back output tray, and then pull out the face-up output tray support if necessary.

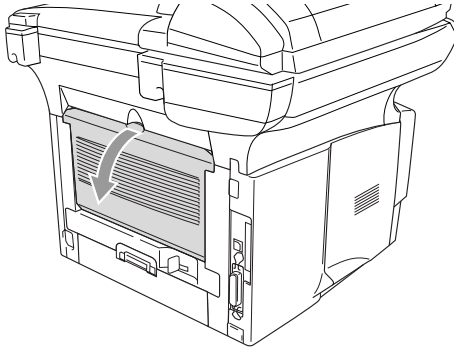

- 3 Open the MP tray and lower it gently.

- 4 Pull out the MP tray support flap.

- 5 When putting paper in the MP tray, make sure it touches the back of the tray.

 Make sure that the paper is straight and in the proper position in the MP tray. If it is not, the paper may not be fed properly, resulting in a skewed printout or a paper jam.

- 6 While pressing the paper-guide release lever, slide the paper guide to fit the paper size.

 When you put paper in the MP tray, please remember the following;

- During printing, the inside tray rises to feed paper into the DCP.
- The side to be printed on must be face up.
- Put the leading edge (top of the paper) in first and push it gently into the tray.

7 Send the print data to the DCP.

8 When you have finished the print job, close the back output tray.

! **Caution**

Remove each sheet immediately after printing. Stacking the sheets may cause a paper jam or the paper to curl.

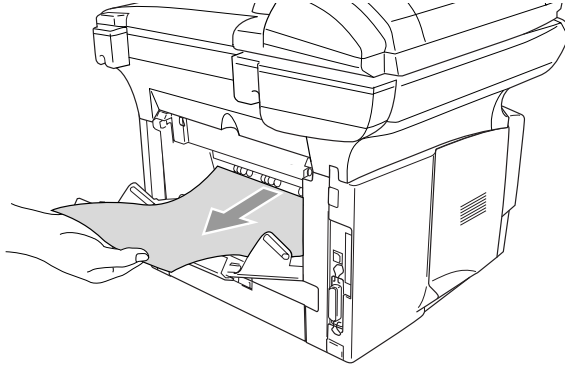

Printing on envelopes

To print on envelopes use manual feed tray or multi-purpose tray.



- The DCP automatically turns on the Manual Feed mode when you put paper in the manual feed tray.
- All sides should be properly folded without any wrinkles or creases.

1 Select the **Paper Size**, **Media Type**, **Paper Source**, and other settings in the printer driver.

Media Type: Envelope, Env.thin or Env.thick

For DCP-8040:

2 Open the back output tray.

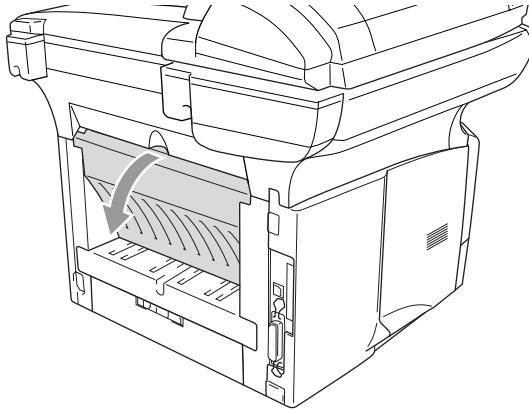

3 Open the manual feed tray. Slide the paper guides to fit the envelope size.



If envelopes are created after they have been printed:

At the back of the DCP, open the back output tray and push down the blue tabs at the left and right hand sides (as shown in the figure below). When you have finished printing your envelopes, close the back output tray to reset the two blue tabs back to their original position.

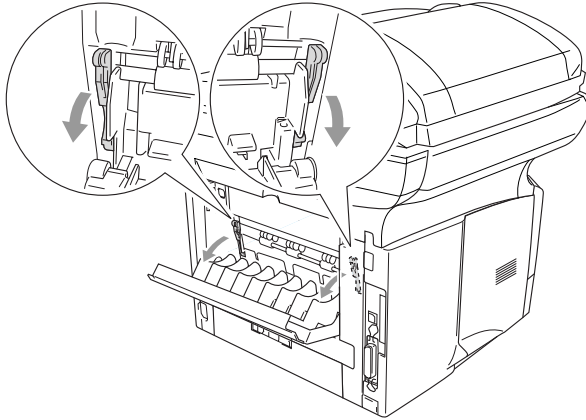

4 Using both hands put the envelope in the manual feed tray until the front edge of the envelope touches the paper feed roller. Hold the envelope in this position until the DCP automatically feeds it in for a short distance, and then let go of the envelope.

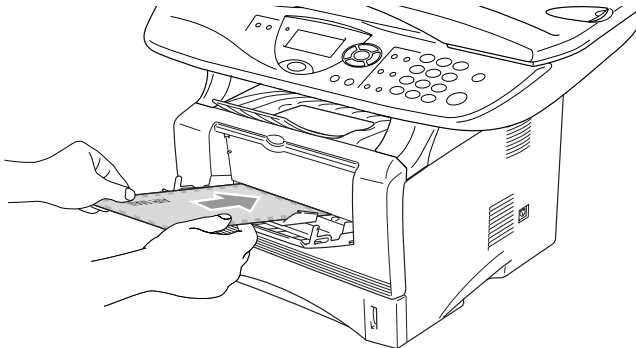



- Make sure the envelope is straight as you insert it in the manual feed tray. If it is not, the envelope may not be fed properly, resulting in a skewed printout or a jam.
 - Do not put more than one envelope in the manual feed tray at any one time, or it may cause a jam.
 - Put the envelope in the manual feed tray, making sure that the side to be printed on is face up in the tray.
- 5** After the printed envelope comes out of the DCP, the DCP will wait until you put in the next envelope. Repeat Step 4 for each envelope you want to print.
 - 6** Send the print data to the DCP.
 - 7** After you finish the print job, close the back output tray.

For DCP-8045D:

- 2** Open the back output tray, and then unfold the face-up output tray support if necessary.

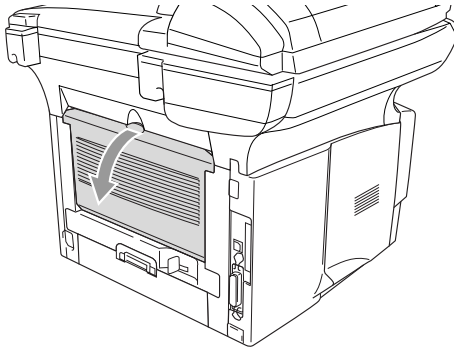

- 3** Open the MP tray and lower it gently.

4 Pull out the MP tray support flap.



If envelopes are creased after they have been printed:

At the back of the DCP, open the back output tray and push down the blue tabs at the left and right hand sides (as shown in the figure below). When you have finished printing your envelopes, close the back output tray to reset the two blue tabs back to their original position.

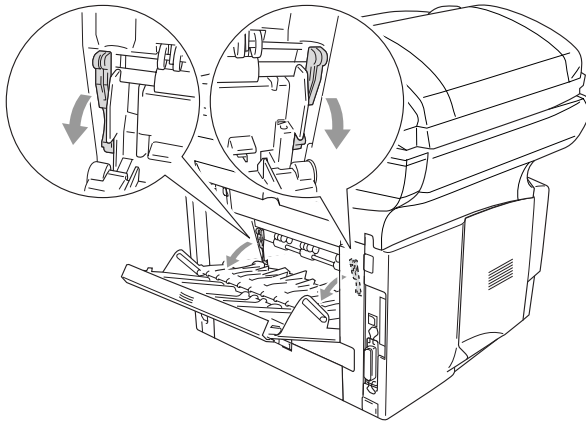

5 Put the envelopes in the MP tray so that they touch the back of the tray. Do not put more than 3 envelopes in the MP tray at any one time, or it may cause a jam.

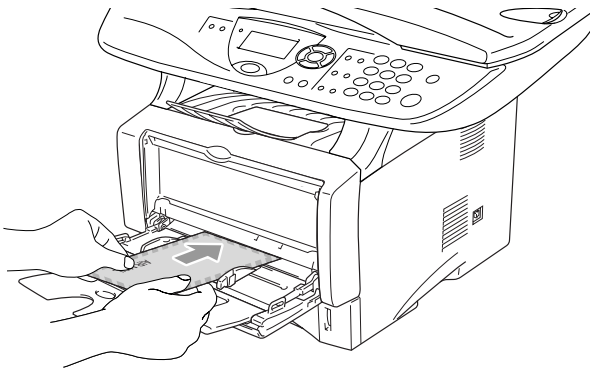

Make sure that the envelopes are neatly stacked and in the proper position in the MP tray. If they are not, the envelopes may not be fed properly, resulting in a skewed printout or a jam.

6 Press and slide the paper-width guide to fit the envelope size.



When you put envelopes in the MP tray, please remember the following;

- During printing, the inside tray rises to feed envelopes into the DCP.
- The side to be printed on must be face up.
- Put the leading edge (top of the envelope) in first and push it gently into the tray.

7 Send the print data to the DCP.

8 After you finish the print job, close the back output tray.

Printer operation keys

Job Cancel

You can clear data from the memory by pressing the Job Cancel key.

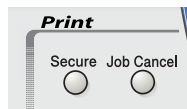

Secure key

Secured data is password protected. Only those people that know the password will be able to print the data. The DCP will not print secure data until the password is entered. After the document is printed, the data will be cleared from the memory. To use this function, you need to set your password in the printer driver dialog box. (See *Device Options* on page 7-11.)

 The **Secure** Key function is not available when using the Brother BR-Script driver.

1 Press **Secure**.

—OR—

The LCD displays **No Data !** if there is no secured data in the memory.

2 Press or to select the user name.

Press **Set**. The LCD displays job selections.



3 Press or to select the job.

Press **Set**. The LCD prompts you to enter your four-digit password.





4 Enter your password using the numeric keys.

Press **Set**.

5 Press  or  to select `Print`.

Press **Set**. The DCP prints the data.

—OR—

If you want to delete the secured data press  or  to select `Delete`.

Press **Stop/Exit**.





- If you turn the power switch off, the secured data saved in memory will be cleared.
- After you print the secured data, it will be cleared from memory.

Secure Print Test1
Password:XXXX
Enter & Set Key

Setting the Emulation Selection

This DCP has an Automatic Emulation Selection function. When the DCP receives information from the PC, it automatically chooses the emulation mode. This function has been set at the factory to AUTO. You can change the default emulation mode manually by using the control panel.

1 Press **Menu, 3, 1**.

2 Press  or  to select `Auto`, `HP LaserJet` or `BR-Script 3`.

Press **Set**.

3 Press **Stop/Exit**.

31.Emulation
▲ Auto
HP LaserJet
▼ BS-Script 3
Select ▲▼ & Set



Try this function with your application software or network server. If the function does not work properly, either select the required emulation mode manually using the DCP panel buttons or use the emulation selection commands in your software.

Printing the Internal Font List

You can print a list of the DCP's internal (or resident) fonts to see how each font looks before you select it.

- 1 Press **Menu, 3, 2, 1**.
- 2 Press **Start**. The DCP prints the list.
- 3 Press **Stop/Exit**.

32.Print Options 1.Internal Font
Press Start

Printing the print configuration list

You can print a list of current printer settings.

- 1 Press **Menu, 3, 2, 2**.
- 2 Press **Start**. The DCP prints the settings.
- 3 Press **Stop/Exit**.

32.Print Options 2.Configuration
Press Start

Restoring default settings

You can return the DCP to the default settings. Fonts and macros in the temporary settings are cleared.

- 1 Press **Menu, 3, 3**.
- 2 Press **1** to restore the factory settings
—OR—

33.Reset Printer
▲ 1.Reset
▼ 2.Exit
Select ▲▼ & Set

Press **2** to exit without making a change.

- 3 Press **Stop/Exit**.



Only the printer settings will be returned to the default settings.

7

Printer driver settings

(Windows® Only)

Printer driver settings

You can change the following printer settings when you print from your computer:

- **Media Type**
- **Multiple Page**
- **Duplex**
- **Watermark***1*2
- **Scaling***2
- **Print Date & Time***1*2
- **Quick Print Setup***1*2
- **Secure Print***1

*1 These settings are not available with the BR-Script driver.

*2 These settings are not available with the Universal printer driver.

How to access the printer driver settings

- 1 Select **Print** from the **File** menu in your application software.
- 2 Select **Brother DCP-8040** or **DCP-8045D (USB) Printer** as your printer and click **Preferences** for Windows® 2000/XP (**Properties** for Windows® 98/98SE and Me, **Document Defaults** for Windows NT® 4.0). The **Printing Preferences** dialog box will appear.



- The way you access the printer driver settings depends on your operating system and software applications.
- The screens shown in this section are from Windows® XP. The screens on your Computer may vary depending on your Windows Operating System.
- Some descriptions in this chapter are based on the DCP-8045D. These descriptions also apply to the DCP-8040.

Features in the Brother Native Driver

The Brother Native driver is a printer driver developed exclusively by Brother. This driver includes more features than the Microsoft® Windows® Universal printer driver.

Basic tab

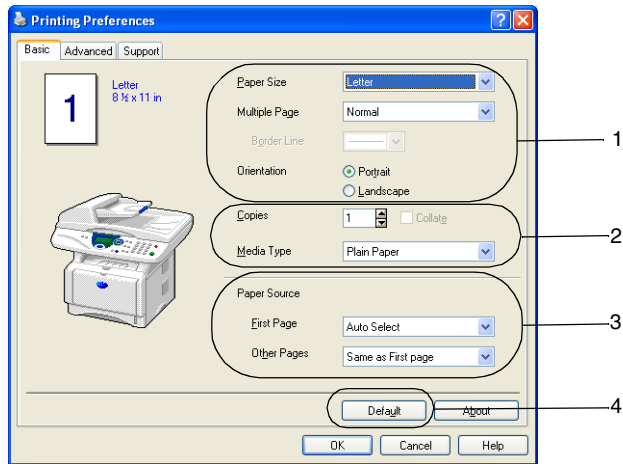

- 1** Select the **Paper Size**, **Multiple Page**, **Border Line** (if any) and **Orientation**.
- 2** Select number of **Copies** and **Media Type**.
- 3** Select **Paper Source (First Page and Other Pages)**. **Auto Select** allows the printer driver to select a suitable tray for **Paper Size** automatically. You can set the paper size for each tray in the Accessories tab (see *Accessories tab* on page 7-14).
- 4** To return to the default settings, click the **Default** button.

Paper Size

From the drop-down box select the Paper Size you are using.

Multiple Page

The Multiple Page selection can reduce the image size of a page allowing multiple pages to be printed on one sheet of paper or enlarging the image size for printing one page on multiple sheets of paper.

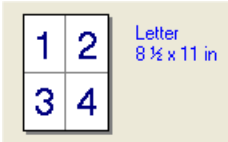

Ex. 4 in 1



Ex. 1 in 2 x 2 pages

Border Line

When printing multiple pages on one sheet with the Multiple Page feature you can select to have a solid border, dash border or no border around each page on the sheet.

Orientation

Orientation selects the position of how your document will be printed (**Portrait** or **Landscape**).

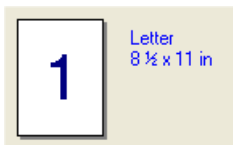

Portrait



Landscape

Copies

The copies selection sets the number of copies that will be printed.

Collate

With the **Collate** check box selected, one complete copy of your document will be printed and then repeated for the number of copies you selected. If the **Collate** check box is not selected, then each page will be printed for all the copies selected before the next page of the document is printed.

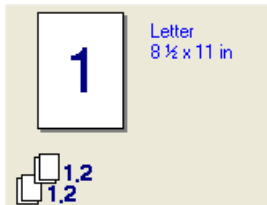

Collate box checked



Collate box not checked

Media Type

You can use the following types of media in your DCP. For the best print quality, select the type of media that you wish to use.

Plain Paper

Thin Paper

Thick Paper

Thicker Paper

Bond Paper

Transparencies

Envelopes

Env. Thick

Env. Thin



When using ordinary plain paper (19 to 25 lb / 70 to 90 g/m²), select **Plain Paper**. When using heavier weight paper or rough paper select **Thick Paper** or **Thicker Paper**. For bond paper, select **Bond Paper** and for OHP transparencies, select **Transparencies**. When using ordinary envelopes, select **Envelopes**. When using heavier weight paper or rough paper select **Env. Thick** or **Env. Thin**.

When you use envelopes, select **Envelopes**. If the toner is not fixed to the envelope correctly when **Envelopes** has been selected, select **Env. Thick**. If the envelope is crumpled when **Envelopes** has been selected, select **Env. Thin**.

Advanced tab

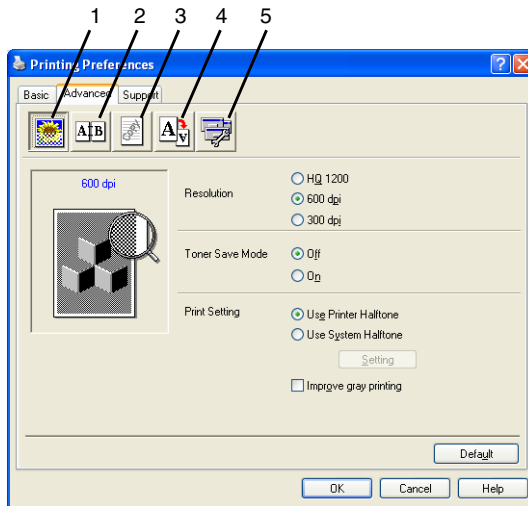

To return to the default settings, click the **Default** button.

Change the tab settings by selecting one of the following icons:

- 1 **Print Quality**
- 2 **Duplex**
- 3 **Watermark**
- 4 **Page Setting**
- 5 **Device Options**

Print Quality

Resolution

You can change the resolution as follows:

- HQ 1200
- 600 dpi
- 300 dpi



When you select **Use Duplex Unit**, HQ1200 is not available.

Toner Save Mode

You can save running costs by turning on the Toner Save Mode, which reduces the print density.

Print Setting

For Windows® 98/98SE/Me

Print Setting is used for optimizing your print quality for the type of original being printed (Photos, Graphics or Scanned Images). When you choose **Auto (Recommended)**, the printer automatically prints with the most suitable print settings.

With the Print Setting set to Manual, you can change the Brightness, Contrast and Graphics Quality options manually.

For Windows® 2000/XP/NT® WS 4.0

- Check **Use Printer Halftone** to print using Halftone.
- Check **Use System Halftone** to print using Halftone of the system. To change the setting, press **Setting**.
- If the halftone cannot be printed correctly, check **Improve gray printing**.

Duplex Printing

Choosing the Duplex Printing icon displays the Duplex features available.

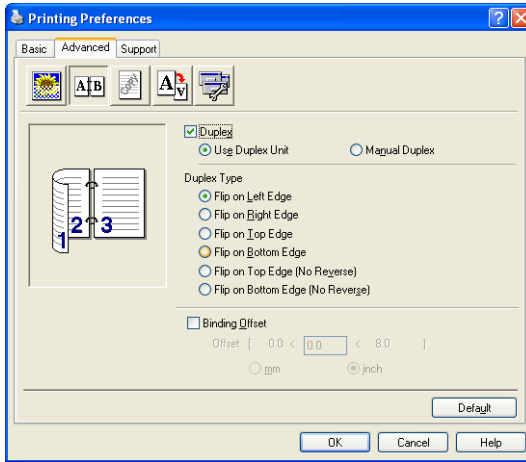

Use Duplex Unit (For DCP-8045D)

Check the Duplex box and then select **Use Duplex Unit**. In this mode the DCP prints on both sides of the paper automatically.

Manual Duplex

Check the Duplex box and then select **Manual Duplex**. In this mode, the DCP prints all the even numbered pages first. Then the printer driver stops and shows the instructions required to re-install the paper. When you click OK the odd numbered pages are printed.

Duplex Type

You can select **Duplex Type**. There are six types of duplex directions available for each orientation.

Flip on Left Edge 

Flip on Right Edge 

Flip on Top Edge 

Flip on Bottom Edge 

Flip on Top Edge (No Reverse) 

Flip on Bottom Edge (No Reverse) 

Binding Offset

Check the Binding Offset option, you can specify the offset value of the binding side in inches or millimeters (0 - 8 inches) [0 - 203.2 mm].

Watermark

You can place a logo or text into your document as a Watermark. You can select one of the preset Watermarks, or you can use a bitmap file or text file that you have created.

Check **Use Watermark**, and then select the watermark you want to use.

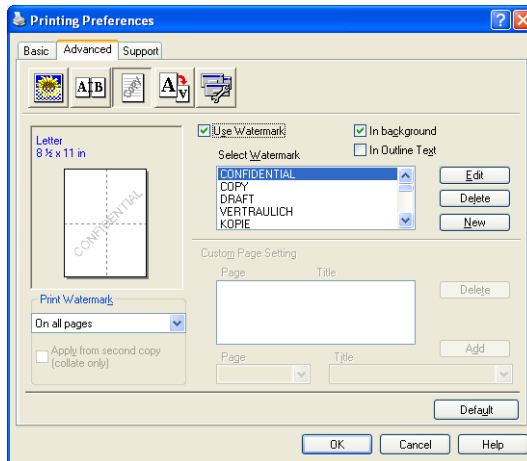

In background

Check **In background** to print the watermark image in the background of your document. If this feature is not checked then the Watermark will be printed on top of your document.

In Outline Text

(Windows® 2000 Professional/XP/NT® WS 4.0 Only)

Check **In Outline Text** if you only want to print an outline of the watermark.

Print Watermark

The **Print Watermark** feature offers the following print choices:

- **On all pages**
- **On first page only**
- **From second page**
- **Custom**
- **Apply from second copy (collate only)**
(For Windows® 2000/XP/Windows NT® 4.0)

Watermark Setting

You can change the Watermark's size and position on the page by selecting the Watermark, and clicking the **Edit** button. If you want to add a new Watermark, click the **New** button, and then select **Text** or **Bitmap** in the **Watermark Style**.

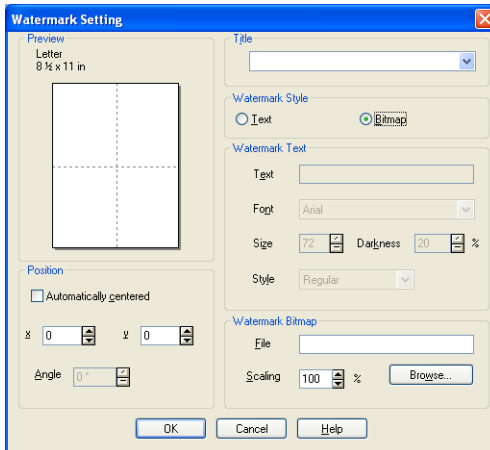

- **Title**
You can select **CONFIDENTIAL**, **COPY** or **DRAFT** as the standard title or enter a title you like in the field.
- **Watermark Text**
Enter your Watermark text into the **Text** Box, and then select the **Font**, **Size**, **Darkness** and **Style**.
- **Watermark Bitmap**
Enter the file name and location of your bitmap image in the **File** box, or **Browse** for the file location. You can also set the scaling size of the image.
- **Position**
This setting offers you the control for where the Watermark is to be positioned on the page.

Page Setting

You can change the print size of your document with the Scaling feature.

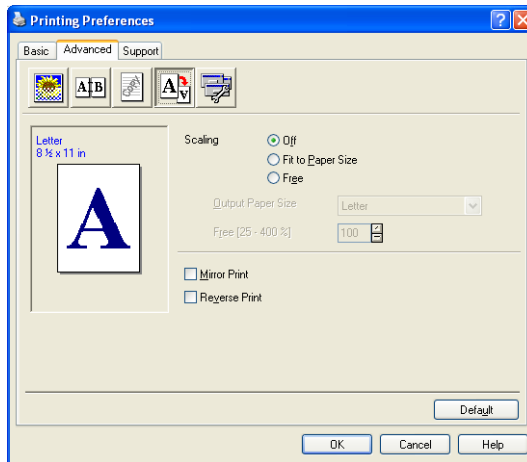

- Check **Off** if you want to print the document as it appears on your screen.
- Check **Fit to Paper Size**, if your document has an unusual size, or if you have only the standard size paper.
- Check the **Free** box if you want to manually reduce or enlarge the output.
- You can also use the **Mirror Print** or **Reverse Print** feature for your page setting.

Device Options

Lets you set the following Printer Functions:

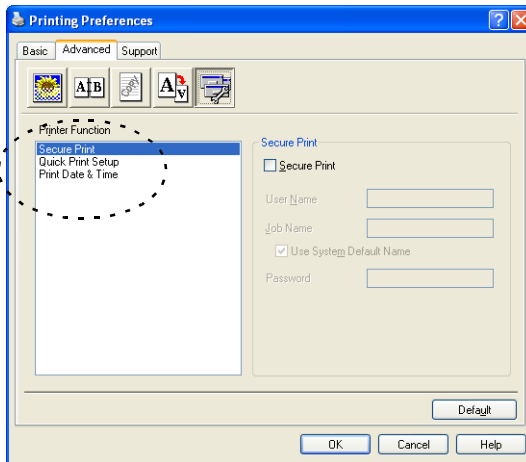

Secure Print

Secure documents are documents that are password protected when they are sent to the DCP. Only the people who know the password will be able to print them. Since the documents are secured at the DCP, you must use the control panel of the DCP (with the password) to print them.

To send a secured document:

- 1** Select **Secure Print** from **Printer Function** and check **Secure Print**.
- 2** Enter your password, user name and job name and click OK.
- 3** You must print the secured documents from the control panel of the DCP. (See *Secure key* on page 6-16.)

To delete a secured document:

You need to use the control panel of the DCP to delete a secured document. (See *Secure key* on page 6-16.)



You can store up to 8 MB of secured data in the DCP's memory.

Quick Print Setup

The Quick Print Setup feature allows you to quickly select driver settings. To view setting, simply click your mouse button on the task tray  icon. This feature can be set to ON or OFF from the Device Options section.

 The factory setting is OFF

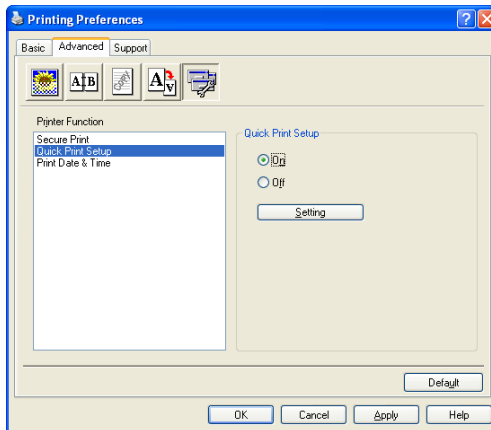

Administrator (For Windows® 98/98SE/Me Users Only)

The administrator selection permits the Copy, Scaling and Watermark features to be locked and password protected.

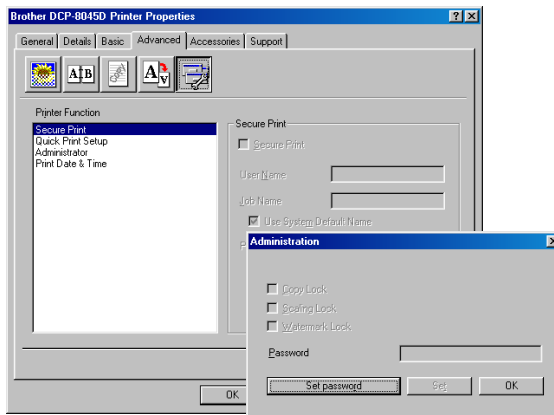

 Record your password and keep it in a safe place for future reference. If you forget your password these settings can not be accessed.

Print Date & Time

When enabled the **Print Date and Time** feature will automatically print the date and time from your computers system clock on your document.

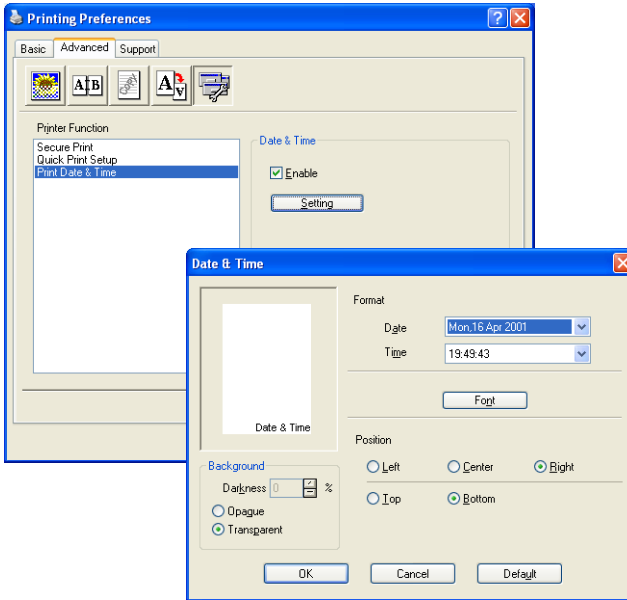

Click the **Setting** button to change the **Date** and **Time** Format. You can change the Font by clicking the **Font** button or the **Position**. To include a background with the **Date** and **Time** select **Opaque**. When **Opaque** is selected you can set the **Darkness** of the **Date** and **Time** background by changing the percentage.



The Date and Time indicated in the selection box represents the format that will be printed. The actual Date and Time printed on your document is automatically retrieved from the settings of your computer.

Accessories tab

The **Accessories** Tab includes the settings for configuring the printer driver for the size of paper loaded in each paper source. This tab also installs any additional options into the driver settings.

Paper Source Setting

To configure the paper size for each paper source, highlight the source in the **Paper Source Setting** list. Select the **Paper Size** from the pull-down box and click **Update**. When Auto Select (default Paper Source) is set in the Basic tab of the printer driver (see *Basic tab* on page 7-2), the printer driver will automatically use the **Paper Source Setting** to select a tray which matches the **Paper Size** setting in the printer driver.

Default Source

The **Default Source** allows you to choose the paper source that will be used when the paper size of the document being sent does not match the Paper Source settings.

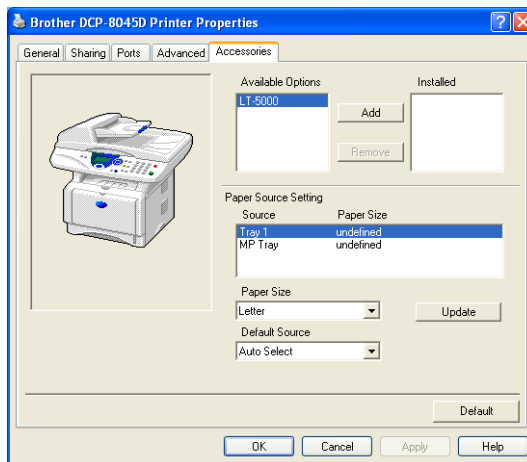

Available Options

In order to access the optional 2nd paper tray the option must be installed in the driver. Highlight the model number from the **Available Options** list and click **Add**. The optional tray will then be listed in the **Installed** box, **Paper Source Setting** list and the screen illustration will display the 2nd tray.

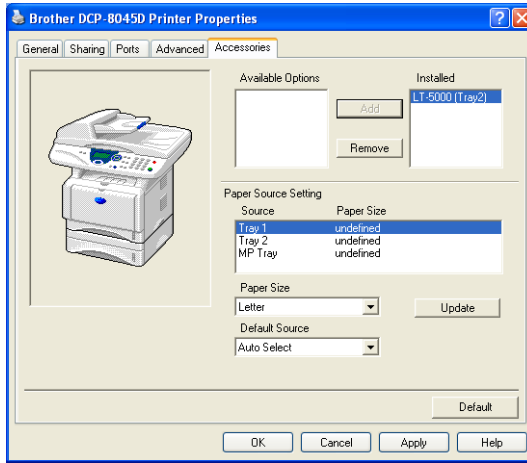

Support tab

The **Support** tab provides driver version and setting information. In addition there are links to the **Brother Solutions Center** and the Driver Update Web sites.

Click the **Support** tab to display the following screen:

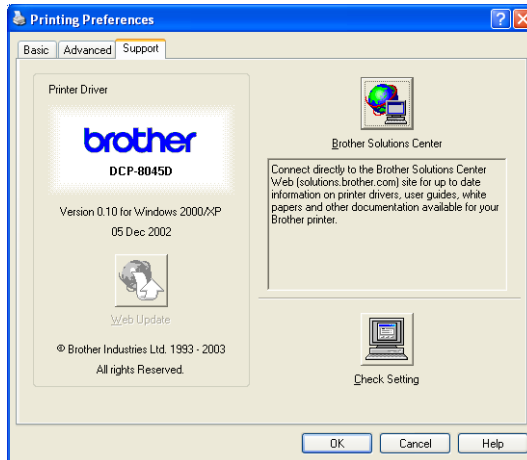

Brother Solutions Center

The **Brother Solutions Center** is a Web site offering information about your Brother product including FAQs (Frequently Asked Questions), User Guides, Driver Updates and Tips for using your DCP.

Web Update

Web Update checks the Brother web site for updated drivers, and automatically downloads and updates the printer driver on your computer.

Check Setting

The **Check Setting** selection displays a list of your current driver settings.

Features in the PS printer driver (For Windows®)

The Windows® 98/98SE/Me/2000 Professional/XP and Windows NT® 4.0 utilizes BR-Script 3(PostScript® 3™ language emulation) driver.

To install the PS driver

If you have already installed the printer driver following the instruction in the Quick Setup Guide, insert the CD-ROM into the CD-ROM drive on your PC and click **Install Software**. Choose **MFL-Pro Suite** and follow the on-screen instructions. When the **Select Components** screen appears, check **PS Printer Driver**, and then continue following the on-screen instructions.

If you have not previously installed the driver and software, insert the CD-ROM into the CD-ROM drive on your PC and click **Install Software**. Choose **MFL-Pro Suite** and follow the on-screen instructions. When the **Setup Type** screen appears, select **Custom** and check the **PS Printer Driver**. Then continue following on-screen instructions.

You can download the latest driver by accessing the Brother Solutions Center at <http://solutions.brother.com>



The screens in this section are from Windows® XP.

The screens on your PC will vary depending on your Operating System.

Ports tab

Select the port where your printer is connected or the path to the network printer you are using.

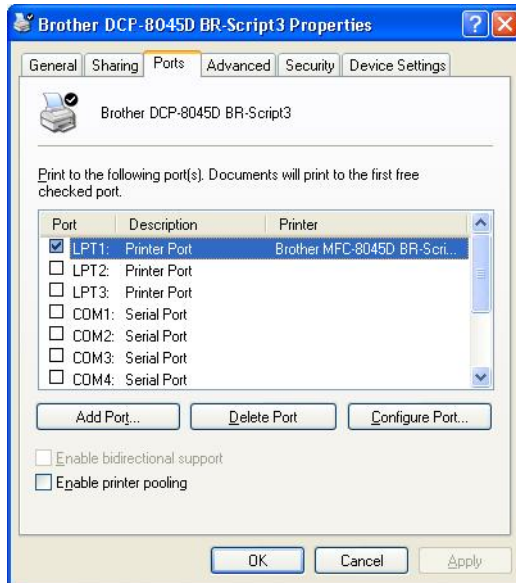

Device Settings tab

Select the options you installed.

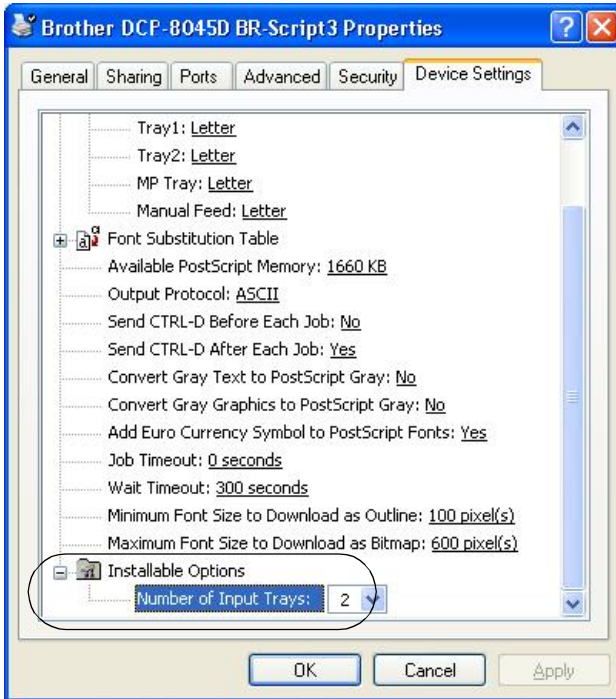

Layout tab

 If you are using Windows NT[®] 4.0, Windows[®] 2000 or XP, you can access the **Layout** tab by clicking **Printing Preferences...** in the **General** tab of the **Brother DCP-8045D BR-Script3 Properties** screen.

You can change the Layout setting by selecting the setting in the **Orientation**, **Page Order** and **Page Per Sheet**.

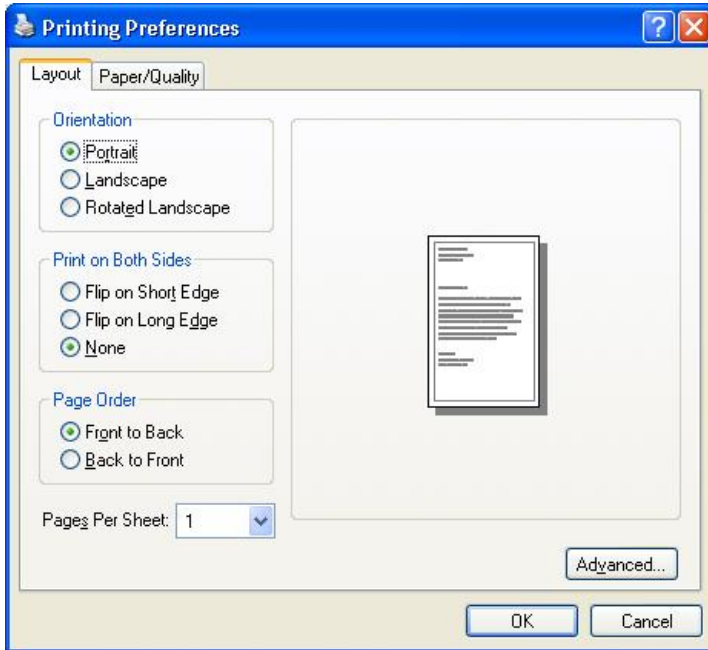

Booklet (For DCP-8045D) (For Windows[®] 2000/XP)

You can print a booklet by selecting **Booklet** from **Pages Per Sheet** list.

Paper/Quality tab



If you are using Windows NT® 4.0, Windows® 2000 or XP, you can access the **Layout** tab by clicking **Printing Preferences...** in the **General** tab of the **Brother DCP-8045D BR-Script3 Properties** screen.

Select the **Paper Source**.

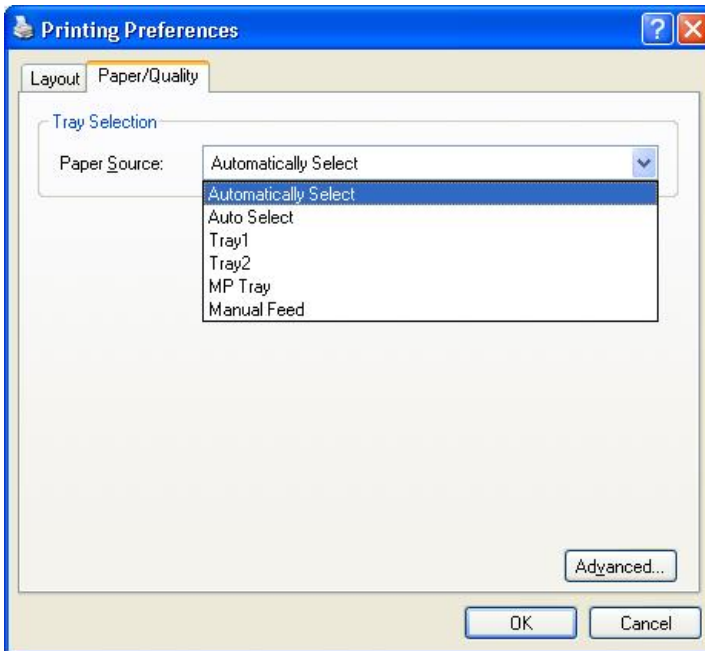

Advanced Options

 If you are using Windows NT® 4.0, Windows® 2000 or XP, you can access the **Advanced Options** tab by clicking **Advanced...** button in the **Layout** tab or the **Paper/Quality** tab.

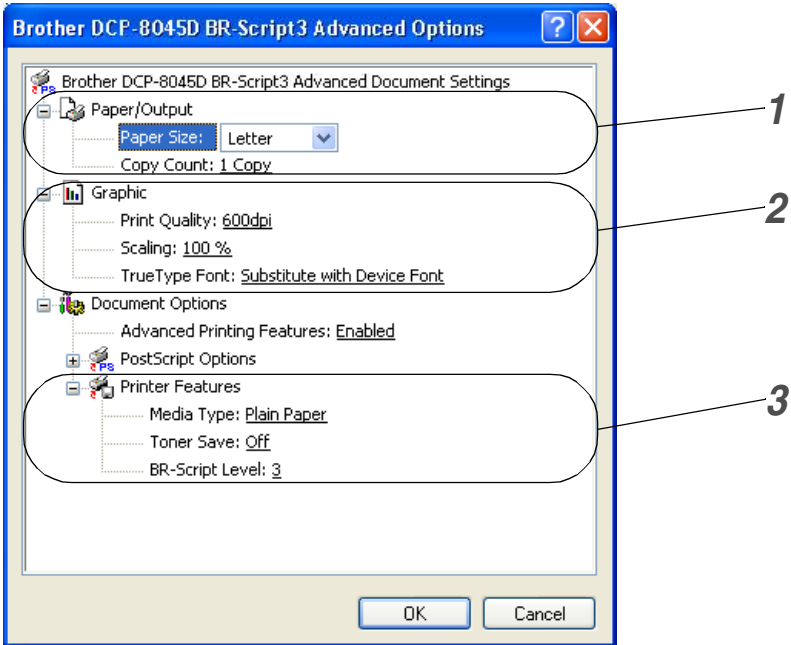

- 1** Select the **Paper Size** and **Copy Count**.
- 2** Set the **Print Quality**, **Scaling** and **TrueType Font** setting.
- 3** You can change settings by selecting the setting in the Printer Features list:
 - **Media Type**
 - **Toner Save**
 - **BR-Script Level**

8

How to scan using Windows®



- The scanning operations and drivers will be different depending on your operating system.

For Windows® 98/98SE/Me/2000 Professional and Windows NT® Workstation 4.0

The DCP uses a TWAIN Compliant driver for scanning documents from your applications. (See *Scanning a document, TWAIN compliant* on page 8-1.)

For Windows® XP

The DCP uses Windows® Imaging Acquisition (WIA) for scanning documents. (See *Scanning a document (For Windows® XP only)* on page 8-10.)

- **For ScanSoft®, PaperPort® and OmniPage® OCR**
Go to *Using ScanSoft® PaperPort® and OmniPage® OCR* on page 8-19.

Scanning a document

TWAIN compliant

The Brother MFL-Pro Suite software includes a TWAIN compliant scanner driver. TWAIN drivers meet the standard universal protocol for communicating between scanners and software applications. This means that not only can you scan images directly into the PaperPort® viewer that Brother included with your DCP, but you can also scan images directly into hundreds of other software applications that support TWAIN scanning. These applications include popular programs like Adobe® Photoshop®, Adobe® PageMaker®, CorelDraw® and many more.

How to access the Scanner

 The instructions for scanning in this Guide are for when you use ScanSoft® PaperPort® 8.0SE.

- 1 Open the software application (ScanSoft® PaperPort®) to scan a document.
- 2 Select **Scan** from the **File** drop-down menu or select the **Scan** button.
- 3 Select **Brother DCP-8045D** (if using a parallel interface), **Brother DCP-8045D USB** or **Brother DCP-8045D LAN** from the **Scanner** drop-down list box.
- 4 Click **Scan**.

If the DCP is connected via:

Parallel—use '**Brother DCP-8045D**'

USB—use '**Brother DCP-8045D USB**'

LAN—use '**Brother DCP-8045D LAN**'

The **Brother DCP-8045D**, **Brother DCP-8045D USB** or **Brother DCP-8045D LAN** Scanner Setup dialog box will appear:

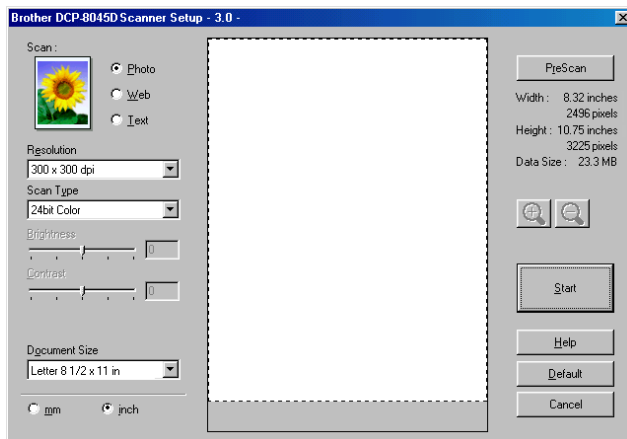

Scanning a document into the PC

You can scan a whole page

—OR—

Scan a portion of the page after pre-scanning the document.

Scanning a whole page

- 1 Place the original face up in the ADF (automatic document feeder), or face down on the scanner glass.
- 2 Adjust the following settings, if required, in the Scanner window:
 - **Image Type**
 - **Resolution**
 - **Scan Type**
 - **Brightness**
 - **Contrast**
 - **Document Size**



After you select a document size, you can adjust the scanning area further by clicking the left mouse button and dragging it. This is required when you want to crop an image when scanning.

See *Settings in the Scanner window* on page 8-6.

- 3 Click the **Start** button in the scanner window. When scanning is completed, click **Cancel** to return to the PaperPort® window.

Pre-Scanning to crop a portion you want to scan

The **PreScan** button is used to preview an image for cropping any unwanted areas from the image. When you are satisfied with the preview, click the **Start** button in the scanner window to scan the image.

- 1 Place the original face up in the ADF, or face down on the scanner glass.

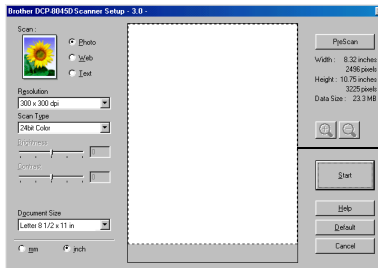

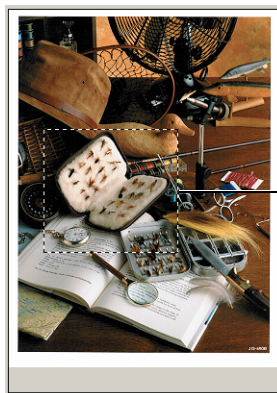

- 2 Select the settings for **Image Type**, **Resolution**, **Scan Type**, **Brightness** and **Contrast**, as needed.
- 3 In the **Brother DCP-8045D**, **Brother DCP-8045D USB** or **Brother DCP-8045D LAN** Scanner Setup dialog box, click the **PreScan** button.

The entire original will be scanned into the PC and will appear in the Scanning Area.



4 Select the portion you want to scan by clicking the left mouse button and dragging it.



You can enlarge the portion you selected by pressing  to check it. If you want to select the different portion, use  to undo the image.

5 If you have used the ADF in Step 1, please the original face up in the ADF again.

6 Click **Start**.

This time only the selected area of the original will appear in the PaperPort® window (or your software application window).

7 In the PaperPort® window, use the options available to refine the image.

Settings in the Scanner window

Image Type

Select the image type of output from **Photo**, **Web** or **Text**.

Resolution and **Scan Type** will be altered for each default setting.

The default settings are:

Image Type		Resolution	Scan Type
Photo	Select for scanning photo images.	300 x 300 dpi	24-bit color
Web	Select for attaching the scanned image to web pages.	100 x 100 dpi	24-bit color
Text	Select for scanning text documents.	200 x 200 dpi	Black & White

Resolution

You can change the scanning resolution from the **Resolution** drop down list. Higher resolutions take more memory and transfer time, but can achieve a finer scanned image. The following table shows the resolution you can choose and the available colors.

Resolution	Black & White / Gray (Error Diffusion)	256 color	True Gray / 24 bit color / 24 bit color (Fast)
100 × 100 dpi	Yes	Yes	Yes
150 × 150 dpi	Yes	Yes	Yes
200 × 200 dpi	Yes	Yes	Yes
300 × 300 dpi	Yes	Yes	Yes
400 × 400 dpi	Yes	Yes	Yes
600 × 600 dpi	Yes	Yes	Yes
1200 × 1200 dpi	Yes	No	Yes
2400 × 2400 dpi	Yes	No	Yes
4800 × 4800 dpi	Yes	No	Yes
9600 × 9600 dpi	Yes	No	Yes

Scan Type

Black & White: Set the Scan Type to **Black & White** for text or line art.

Gray Scale: Set the Scan Type to Gray or True Gray for photographic images.

Colors: Set either:

256 Color, which scans up to 256 colors, or **24-bit color** which scans up to 16.8 million colors.

Although using **24-bit color** creates an image with the most accurate colors, the image file will be approximately three times larger than a file created with **256 Color**.

Brightness

Adjust this settings (-50 to 50) to obtain the best image. The default value is 0, representing an 'average'.

You can set the level by dragging the slide bar to the right or left to lighten or darken the image. You can also type a value in the box for the setting.

If the scanned image is too light, set a lower brightness value and scan the document again. If the image is too dark, set a higher brightness value and scan the document again.

Contrast

This setting is adjustable only when you have selected one of the gray scale settings. It is not available when **Black & White** and **Color** settings are selected as the **Scan Type**.

You can increase or decrease the contrast level by moving the slide bar to the left or right. An increase emphasizes dark and light areas of the image, while a decrease reveals more detail in gray areas. You can also type a value in the box for the setting.

Document Size

Set the Size to one of the following:

- Letter (8 1/2 × 11 in.)
- A4 (210 × 297 mm)
- Legal (8 1/2 × 14 in.)
- A5 (148 × 210 mm)
- B5 (182 × 257 mm)
- Executive (7 1/4 × 10 1/2 in.)
- Business Card (90 × 60 mm)
- Photo 3.5 × 5 in. (9 × 13cm)
- Photo 5 × 7 in. (13 × 18cm)
- APS C 4 × 6 in. (10 × 15cm)
- Custom (User adjustable from 0.35 × 0.35 in. to 8.5 × 14 in or 8.9 × 8.9 mm to 215.9 × 355.6 mm.)

To scan photographs or business cards, select the document size, and then place the document face down at the center of scanner glass.

When scanning photographs or other images for use in a word processor or other graphics application. You should try different settings for the contrast and resolution modes to see which best suits your needs.

If you selected **Custom** as the size, The **Custom Document Size** dialog box will appear.

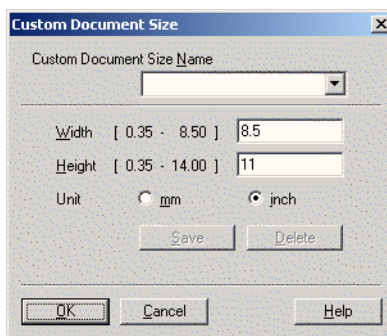

Type the **Name**, **Width** and **Height** for the document.

You can choose “mm” or “inch” as the unit for Width and Height.



You can see the actual paper size you selected on the screen.

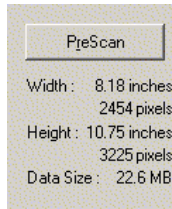

- **Width:** shows the width of scanning area
- **Height:** shows the height of scanning area
- **Data Size:** shows the approximate data size calculated in a Bitmap format. The size will be different for other file formats such as JPEG.

Scanning a document (For Windows® XP only)

WIA compliant

Windows® XP uses Windows Image Acquisition (WIA) for scanning images from the DCP. You can scan images directly into the PaperPort® viewer that Brother included with your DCP or you can scan images directly into any other software application that supports WIA or TWAIN scanning.

How to access the scanner

 The instructions for scanning in this Guide are for when you use ScanSoft® PaperPort® 8.0. The steps for scanning from another application may vary.

- 1 Open your software application to scan a document.
- 2 Select **Scan** from the **File** drop-down menu or select the Scan button.
- 3 Select your DCP model from the **Scanner** drop-down list box.
- 4 Click **Scan**.

The Scan dialog box will appear:

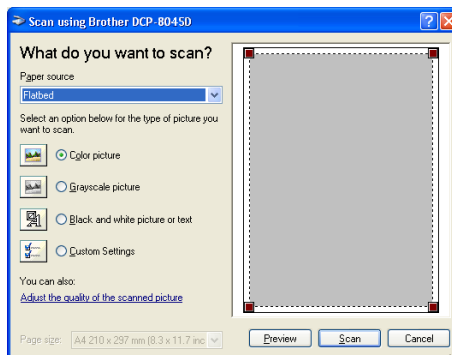

Scanning a document into the PC

These are two ways in which you can scan a whole page. You can either use the ADF or the Flatbed scanner glass.

If you would like to scan and then crop a portion of the page after pre-scanning the document you will need to use the scanner glass (Flatbed).

Scanning a document using the ADF

- 1 Place the original face up in the ADF (automatic document feeder).

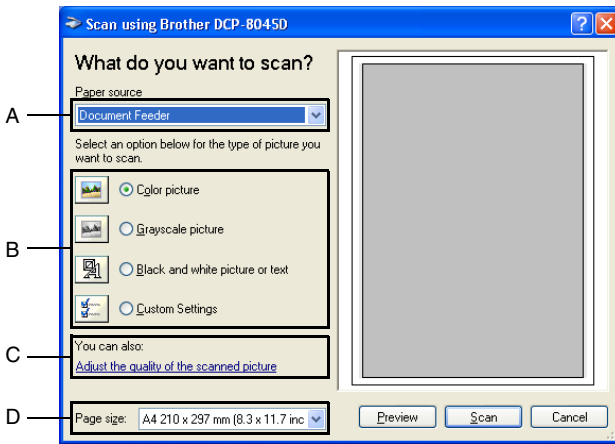

- 2 Select the **Document Feeder** from the **Paper source** drop-down list box (A).
- 3 Select the picture type (B).
- 4 Select the **Paper size** from the drop-down list box (D).

- 5 If you require advanced settings, click on the tab **Adjust the quality of the scanned picture (C)**. You can select **Brightness**, **Contrast**, **Resolution** and **Picture Type** from the **Advanced Properties**. Click the **OK** button after you choose your settings.

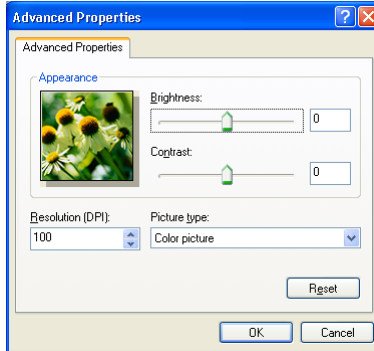

- The scanner resolution you can select is up to 1200 × 1200 dpi.
 - For resolutions greater than 1200dpi, use the Brother Scanner Utility. (See *Brother Scanner Utility* on page 8-15.)
- 6 To start scanning your document, click the **Scan** button in the Scan dialog box.

Pre-Scanning to crop a portion you want to scan using the scanner glass

The **Preview** button is used to preview an image for cropping any unwanted portions from the image. When you are satisfied with the preview, click the **Scan** button from the scanner window to scan the image.

- 1 Place the original face down on the scanner glass.
- 2 Make sure you selected Flatbed in the Paper source pull-down box (A).

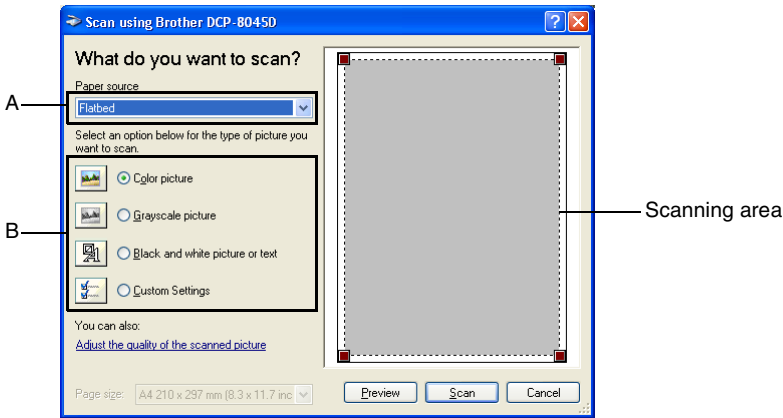

- 3 Select the picture type (B).
- 4 In the Scan dialog box, click the **Preview** button. The entire original will be scanned into the PC and will appear in the scanning area.
- 5 Select the portion you want to scan by clicking the left mouse button and dragging it over the area.

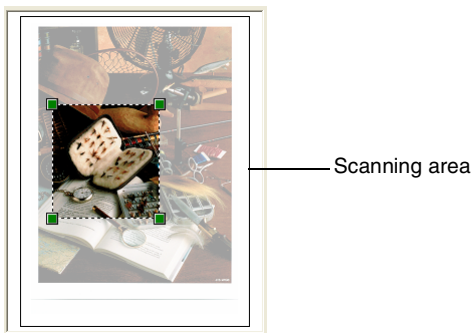

- 6 If you require advanced settings, click **Picture Type** from the **Adjust the quality of the scanned picture (C)**. You can select **Brightness, Contrast, Resolution and Advanced Properties**. Click the **OK** button after you choose your settings.

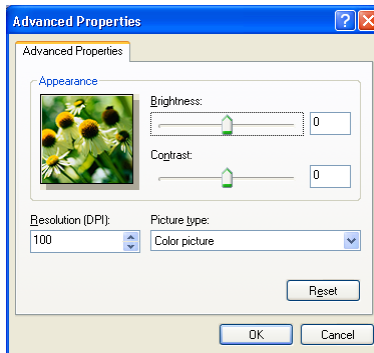
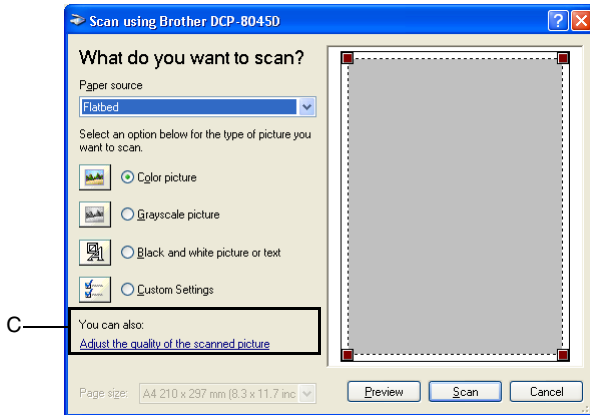

- 7 To start scanning your document, click the **Scan** button in the Scan dialog box. This time only the selected area of the original will appear in the PaperPort® window (or your software application window).

Brother Scanner Utility

The Brother Scanner Utility is used for configuring the scanner driver for resolutions greater than 1200dpi and for changing the paper size. If you want to set Legal size as the default size, change the setting using this utility. You must restart your PC for the new settings to take effect.

To run the utility:

You can run the utility by selecting the **Scanner Utility** located in the **Start/All Programs/Brother/MFL-Pro Suite DCP-8045D** menu.

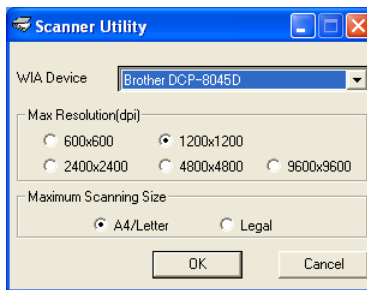

If you scan the original at resolutions greater than 1200dpi, the file size maybe very large. Please make sure that you have sufficient memory and hard disk space for the size of the file you are trying to scan. If the memory & hard disk is not sufficient then your computer may freeze and you could lose your file.

Using the scan key (For USB or Parallel interface cable users)

You can use **Scan** on the control panel to scan originals into your word processing, graphics or E-mail applications or your computer folder. The advantage of using **Scan** is that you avoid the mouse clicks required to scan from your computer.



Scan



For Scan to E-mail, Scan to Image, Scan to OCR and Scan to File



Before you can use **Scan** on the control panel, you must have connected the DCP to your Windows® based computer and loaded the appropriate Brother Drivers for your version of Windows®.

When you are ready to use **Scan**, make sure the Brother Control Center application is running on your computer. For details about how to configure the Brother Control Center buttons to launch the application of your choice using **Scan**, go to the appropriate chapter:

- For Windows® 98/98SE/Me/2000 Professional and Windows NT® WS 4.0, see *Using the Brother Control Center (For Windows® 98/98SE/Me/2000 Professional and Windows NT® WS 4.0)* on page 9-1.
- For Windows® XP, see *Using the Windows®-Based Brother SmartUI Control Center (For Windows® XP)* on page 10-1.
- If your DCP is connected with both a USB and a Parallel cable, you need to select USB or Parallel as the destination in each step.

Scan to E-mail

You can either scan a black and white or color original into your E-mail application as a file attachment. You can change the **Scan** configuration. (See *Scan to E-mail* on page 9-10 to 9-11) (For Windows® XP: See *Hardware Section: Changing the Scan to button configuration* on page 10-5 to 10-11.)



- 1 Place the original face up in the ADF, or face down on the scanner glass.
- 2 Press **Scan**.
- 3 Press  or  to select Scan to E-mail.
Press **Set**.

▲Scan to E-mail
Scan to Image
Scan to OCR
▼Scan to File
Select ▲▼ & Set

The DCP will scan the original, create a file attachment, and launch your E-mail application, displaying the new message waiting to be addressed.

Scan to Image

You can scan a color picture into your graphics application for viewing and editing. You can change the **Scan** configuration. (See *Scan to Image* on page 9-14.) (For Windows® XP: See *Hardware Section: Changing the Scan to button configuration* on page 10-5 to 10-11.)



- 1 Place the original face up in the ADF, or face down on the scanner glass.
- 2 Press **Scan**.
- 3 Press  or  to select Scan to Image.
Press **Set**.

▲Scan to E-mail
Scan to Image
Scan to OCR
▼Scan to File
Select ▲▼ & Set

The DCP will start the scanning process.

Scan to OCR

If your original is text, you can have it converted by ScanSoft® OmniPage® to an editable text file and then have the result displayed in your word processing application for viewing and editing. You can change the **Scan** configuration. (See *Scan to OCR (Word Processor)* on page 9-12 to 9-13.) (For Windows® XP: See *Hardware Section: Changing the Scan to button configuration* on page 10-5 to 10-11.)



- 1 Place the original face up in the ADF, or face down on the scanner glass.
- 2 Press **Scan**.
- 3 Press  or  to select Scan to OCR.
Press **Set**.

▲Scan to E-mail
Scan to Image
Scan to OCR
▼Scan to File
Select ▲▼ & Set

The DCP will start the scanning process.

Scan to File

You can scan a black and white or a color original into your computer and save it as a file in the folder you choose. The file type and specific folder are based on the settings you have chosen in the Scan to File screen of the Brother MFL-Pro Control Center. (See *Scan to File* on page 9-8 to 9-9.) (For Windows® XP: See *Hardware Section: Changing the Scan to button configuration* on page 10-5 to 10-11.)

- 1 Place the original face up in the ADF, or face down on the scanner glass.
- 2 Press **Scan**.
- 3 Press  or  to select Scan to File.
Press **Set**.

▲Scan to E-mail
Scan to Image
Scan to OCR
▼Scan to File
Select ▲▼ & Set

The DCP will start the scanning process.

Using ScanSoft® PaperPort® and OmniPage® OCR

ScanSoft® PaperPort® for Brother is a document management application. You will use PaperPort® to view scanned documents. PaperPort® has a sophisticated, yet easy-to-use, filing system that will help you organize your graphics and text documents. It allows you to combine or “stack” documents of different formats for printing or filing.

ScanSoft® PaperPort® can be accessed through the ScanSoft® PaperPort® program group.

See *Documentation for ScanSoft® PaperPort® on the CD-ROM.*

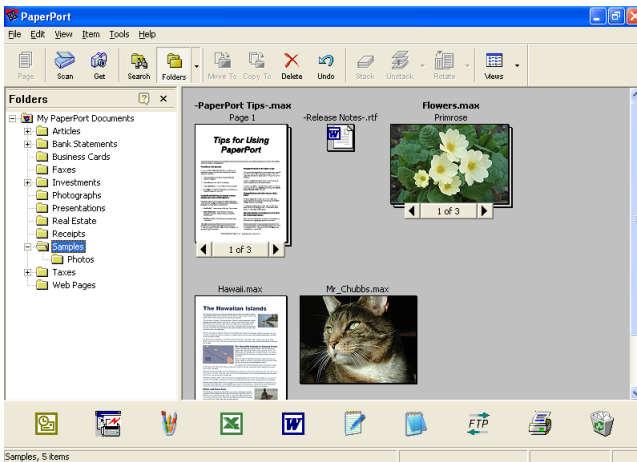

The complete ScanSoft® PaperPort® Users Guide, including ScanSoft® OmniPage® OCR, is in the documentation on the CD-ROM.

This chapter is only an introduction to the basic operations.

When you install MFL-Pro Suite, ScanSoft® PaperPort® for Brother and ScanSoft® OmniPage® OCR are installed with it automatically.

 If you are using Windows® XP, Windows NT® 4.0 or Windows® 2000 Professional, we recommend that you are logged on with administrator rights.

Viewing items

ScanSoft® PaperPort® provides several ways to view items:

Desktop View displays a thumbnail (a small graphic that represents each item in a Desktop or folder).

Items in the selected folder appear on the PaperPort® Desktop. You can see PaperPort® items (MAX files) and non-PaperPort® items (files created using other applications).

Non-PaperPort® items include an icon that indicates the application that was used to create the item; a non-PaperPort® item is represented by a small rectangular thumbnail and not an actual image.

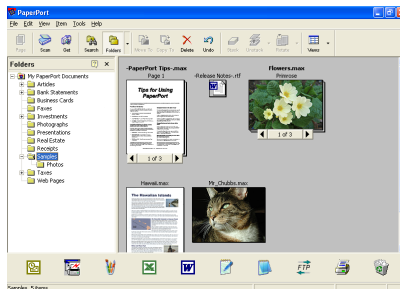

Desktop View displays items as thumbnails

Page View displays a close-up of a single page and you can open a PaperPort® item by double-clicking on it.

As long as you have the appropriate application on your computer to display it, you can also double-click a non-PaperPort® item to open it.

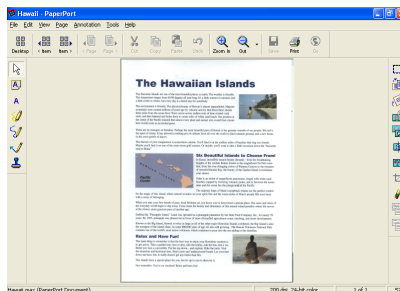

Page View displays each item as a full page

Organizing your items in folders

PaperPort® has an easy-to-use filing system for organizing your items. The filing system consists of folders and items that you select to view in Desktop View. An item can be a PaperPort® item or a non-PaperPort® item:

- Folders are arranged in a “tree” structure in the Folder View. You use this section to select folders and view their items in Desktop View.
- You can simply drag and drop an item onto a folder. When the folder is highlighted, release the mouse button and the item is stored in that folder.
- Folders can be “nested”—that is, stored in other folders.
- When you double-click a folder, its items (both PaperPort® MAX files and non paperport® files) appear on the Desktop.
- **You can also use Windows® Explorer to manage the folders and items shown in Desktop View.**

Quick links to other applications

ScanSoft® PaperPort® automatically recognizes many other applications on your computer and creates a “working link” to them. The Send To Bar at the bottom of the Desktop view shows icons of those linked applications.

To use a link, drag an item onto one of the icons to start the application represented by the icon.

This sample Send To Bar shows several applications with links to PaperPort®.



If PaperPort® does not automatically recognize one of the applications on your computer, you can manually create a link using the **Add to Send To Bar...** command.

(See PaperPort® in the Documentation section on the CD-ROM for more information about creating new links.)

ScanSoft® OmniPage® OCR lets you convert image text into text you can edit

Software by:



ScanSoft® OmniPage® OCR is installed automatically with PaperPort® when you install MFL-Pro Suite on your computer.

ScanSoft® PaperPort® can quickly convert the text on a ScanSoft® PaperPort® item (which is really just a picture of the text) into text that you can edit with a word processing application.

PaperPort® uses the optical character recognition application ScanSoft® OmniPage®, which comes with PaperPort®

—OR—

PaperPort® can use your preferred OCR application if it is already on your computer. You can convert the entire item, or by using the **Copy Text** command, you can select only a portion of the text to convert.

Dragging an item onto a word-processing link icon starts PaperPort®'s built-in OCR application, or you can use your own OCR application.



You can Import items from other applications

In addition to scanning items, you can bring items into PaperPort® in a variety of ways and convert them to PaperPort® (MAX) files in several different ways:

- Print to the Desktop View from another application, such as Microsoft® Excel.
- Import files saved in other file formats, such as Windows® Bitmap (BMP) or Tag Image File Format (TIFF).

You can Export items in other formats

You can export or save PaperPort® items in several popular file formats, such as BMP, JPEG, TIFF, or self-viewing.

For example, to create a file for an Internet Web site, export it as a JPEG file. Web pages often use JPEG files for displaying images.

Exporting an image file

- 1 Select the **Save As** command from the File pull-down menu in the PaperPort® window. The Save 'XXXXX' as dialog box will be displayed.
- 2 Select the drive and directory where you want to store the file.
- 3 Enter the new file name and choose the file type or select a name from the File Name text box. (You can scroll through the Directories and File Name listing for prompting.)
- 4 Select the **OK** button to save your file, or **Cancel** to return to the PaperPort® without saving it.

How to Uninstall PaperPort® and ScanSoft® OmniPage®

For Windows® 98/98SE, and Windows NT® Workstation 4.0 and Windows® Me:

Select **Start, Settings, Control Panel, Add/Remove Programs** and the **Install/Uninstall** tab.

Select **Brother Extensions for Paperport** and click the **Add/Remove** button.

Select **PaperPort® 8.0 SE** from the list and click the **Add/Remove** button.

For Windows® 2000 Professional:

Select **Start, Settings, Control Panel** and **Add/Remove Programs**.

Select **Brother Extensions for Paperport** and click the **Change/Remove** button.

Select **PaperPort® 8.0 SE** from the list and click the **Change** button.

For Windows® XP:

Select **Start, Control Panel, Add or Remove Programs** and the **Change or Remove Programs** icon.

Select **PaperPort® 8.0 SE** from the list and click the **Change** button.

9

Using the Brother Control Center (For Windows® 98/98SE/Me/2000 Professional and Windows NT® WS 4.0)

 If you are using Windows® 2000 Professional or Windows® 4.0, we recommend that you are logged on with administrator rights.

Brother MFL-Pro Control Center

The Brother Control Center is a software utility that pops up on the PC screen whenever paper is put in the ADF of the DCP. This allows you to quickly and with very few mouse clicks, to access the most frequently used scanning applications. Using the Control Center stops the need to manually startup any specific applications.

The Brother Control Center provides two operations (Scan and Copy):

- Scan directly to a file, E-mail, word processor or graphic application of your choice
- Copy





AutoLoad the Brother Control Center

The Control Center is loaded every time Windows® is started.



When the Control Center is loaded, the **Control Center**  icon will appear on the task bar.

If you don't want the Control Center to load automatically, you can turn off AutoLoad.

 If the **Control Center**  icon does not appear on your task bar, you will have to launch the software.

Double-click the **Control Center**  icon on the desktop or from the **Start** menu, select **Programs, ScanSoft PaperPort 8.0**, and then click **Brother SmartUI POPUP**.

How to turn off AutoLoad

- 1 Left-click the Control Center  icon and click **Show**.
- 2 When the Control Center window appears, left click the Smart  Control Center button.

A dialog box will appear:

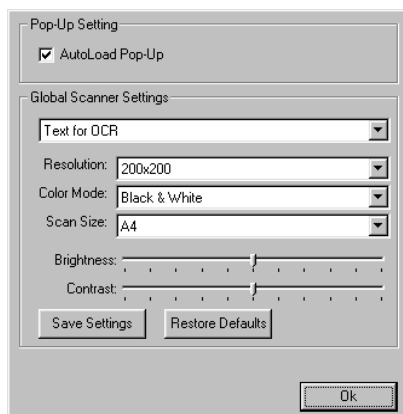

- 3 Uncheck the 'AutoLoad' Pop-Up check box.

Brother Control Center features

Auto Configuration

During installation the Control Center will check your system to set up the default applications for E-mail, word processing and the graphics viewer/editor.

For example, if you are using Outlook as your default E-mail application, the Control Center will create a link and a scanning application button for Outlook.

You can change a default application. Right-click the appropriate Control Center button to display *Configurations* and then click it. Select a different application.

For example, you can change a scan button from MS Word Pad



to MS Word



by changing the application that is listed for the Word Processor.

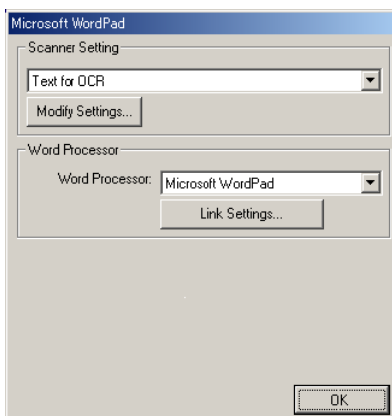

Scan key operations

Scan to File—Lets you scan directly to a file on your computer. You can change the file type and directory for the document you are scanning.

Scan to E-mail—Lets you scan a picture or text document directly into an E-mail application as a standard attachment. You can choose the file type and resolution for the attachment.

Scan to OCR (Word Processor)—Lets you scan a text document, run ScanSoft® OmniPage® OCR, and insert the text original (not a graphic image) into a word processing file. You can choose the word processing application, such as Word Pad, MS Word, and so on.

Scan to Image—Lets you scan an image directly into any graphic viewer/editor application. You can choose the graphics application, such as Microsoft Paint.

Copy operations

Copy—Lets you use the PC and any Windows® printer driver for enhanced copy operations.

You can scan the page on the Brother DCP and print the copies using any of the features of the Brother DCP printer driver.

—OR—

You can send the copy output to any standard Windows® printer driver that is on your PC.

Scanner settings for Scan and Copy buttons

When the Pop-Up screen appears, you can access the Scanner Settings window.

Click the Smart Click  icon at the top right of the Brother Control Center screen

—OR—

Click the **Modify Settings** button on any of the Configuration screens.

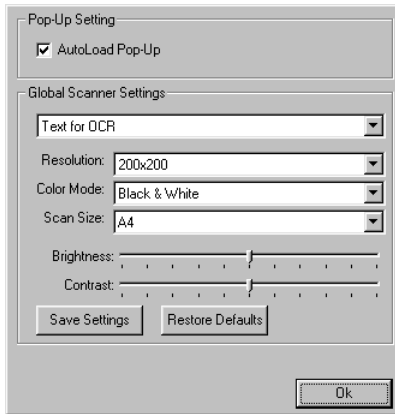

Global settings

AutoLoad Pop-Up—Select this checkbox if you want Brother MFL Control Center to load when you turn on your computer.

Setting up the scanner configurations

The Pop-Up application stores eight different scanning modes. Each time you scan an original, you can choose the most appropriate scanning mode from the following:

Faxing, Filing and Copying

Text for OCR

Photos

Photos (High Quality)

Photos (Quick Scan)

Custom

Draft Copy

Fine Copy

Each mode has its own set of stored settings. You can keep the default settings or change them at any time:

Resolution—From the pull-down list, select the scanning resolution you most often use.

Color Mode—From the pull-down list, select the color settings you most often use.

Scan Size—From the pull-down list, select the scan size you most often use.

Brightness—Slide the adjuster from 0% to 100%

Contrast—Slide the adjuster from 0% to 100%

Click **OK** to save your changes. If you make a mistake or want the default setting, just click the **Restore Defaults** button when the scanning mode is displayed.



Faxing is only possible if you have a fax modem attached to your computer.

Perform an operation from the Control Center screen

If you see this screen it means you left-clicked a button in the Control Center window without first placing an original in the ADF.

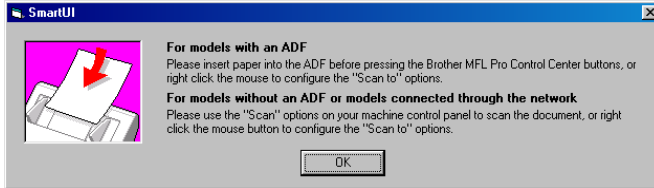

Place the original in the DCP's ADF, and then click **OK** to go to the Control Center screen.



If you want to scan the original from the scanner glass, please use **Scan** on the control panel of the DCP.

Scan to File

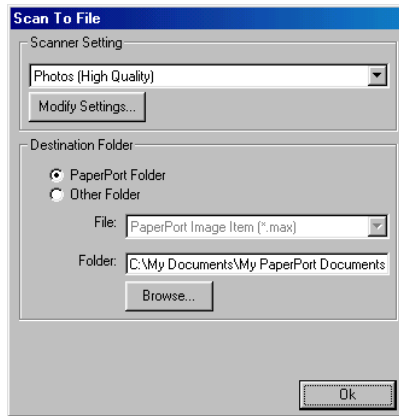

To access Scan to File Configurations screen

- 1 Place the original face up in the ADF. The Brother Control Center screen will pop up.
- 2 Right-click Scan to File and click on *Configuration*. Click the **Modify Settings** button to view the configuration screen of the **Control Center**.
- 3 To save your settings, click **OK**.
—OR—
To go back to the default settings, click the **Restore Defaults** button.

Scanner settings

From the pull-down list, select the scanning mode that is appropriate for the type of file: **Faxing, Filing and Copying; Text for OCR; Photos; Photos (High Quality); Photos (Quick Scan); Custom; Draft Copy or Fine Copy.**

To change any of the settings for the mode, click **Modify Settings**.



Faxing is only possible if you have a fax modem attached to your computer.

Destination folder

PaperPort Folder—Select this checkbox to scan the original into your PaperPort folder.

Other Folder—Select this checkbox, to scan the original as another file type or to store it in another directory/folder.

File—If you selected Other folder from the pull-down list, select the type of file:

- PaperPort Image Item (*.max)
- PaperPort Self-Viewing (*.exe)
- PaperPort Browser-Viewable (*.htm)
- PaperPort 5.0 Image Item (*.max)
- PaperPort 4.0 Image Item (*.max)
- PaperPort 3.0 Image Item (*.max)
- Windows Bitmap (*.bmp)
- PC Paintbrush (*.pcx)
- PCX Multi-page (*.dxc)
- JPEG (*.jpg)
- TIFF-Uncompressed (*.tif)
- TIFF-Group 4 (*.tif)
- TIFF-Class F (*.tif)
- TIFF Multi-page - Uncompressed (*.tif)
- TIFF Multi-page - Group 4 (*.tif)
- TIFF Multi-page - Class F (*.tif)
- Portable Network Graphics (*.png)
- FlashPix (*.fpx)

To Search your system for the directory and folder you want, click the **Browse** button. Click **OK** to save your settings.

Scan to E-mail

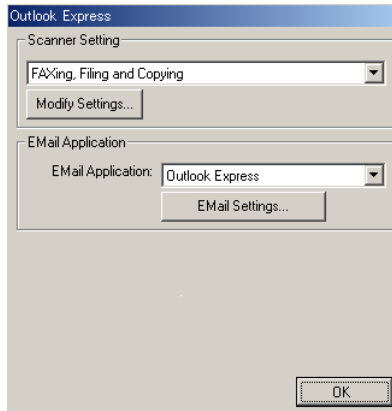

To access Scan to E-mail Configurations screen

- 1 Place the original face up in the ADF. The Brother Control Center screen will pop up.
- 2 Right-click the E-mail application button and click on *Configuration*. Click the **Modify Settings** button to view the configuration screen of the **Control Center**.
- 3 To save your settings, click **OK**.
—OR—
To go back to the default settings, click the **Restore Defaults** button.

Scanner settings

From the pull-down list, select the scanning mode that is appropriate for the type of file: **Faxing, Filing and Copying; Text for OCR; Photos; Photos (High Quality); Photos (Quick Scan); Custom; Draft Copy or Fine Copy.**

To change any of the settings for this mode, click **Modify Settings**.



Faxing is only possible if you have a fax modem attached to your computer.

E-mail application

E-mail Application—From the pull-down list, select your E-mail application.

E-mail Settings—Click the **E-Mail Settings** button to set up links. The **Send To Options** window will appear:

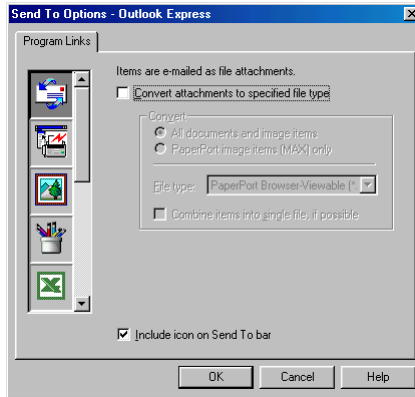

Send to Options

Convert attachments to specified file type—Converts items to the type in the **File Type** box. Clear this check box to keep files in their source format; for example, to keep Word documents in the .doc format and JPEG images in the .jpg format.

All documents and image items—Converts all items regardless of the program in which the item was created; for example, converts all Word (doc) files and JPEG (.jpg) files to the file type.

PaperPort image items (max) only—Converts only PaperPort image items (.max) files. PaperPort does not convert other file types, such as JPEG images and Word documents.

File type—Identifies the format in which to convert items; for example, JPEG or TIFF.

Combine items into single file, if possible—Combines all selected items into a single file that contains multiple pages. This option is available only when the file type supports multiple pages, such as multi-page TIFF.

Scan to OCR (Word Processor)

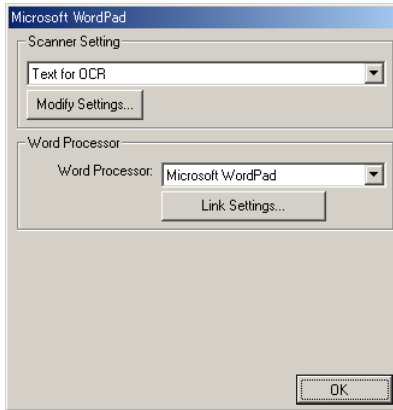

To access Scan to OCR Configurations screen

- 1 Place the original face up in the ADF. The Brother Control Center screen will pop up.
- 2 Right-click the word processor application button and click on *Configuration*. Click the **Modify Settings** button to view the configuration screen of the **Control Center**.
- 3 To save your settings, click **OK**.
—OR—
To go back to the default settings, click the **Restore Defaults** button.

Scanner settings

From the pull-down list, select the scanning mode that is appropriate for the type of file: **Faxing, Filing and Copying; Text for OCR; Photos; Photos (High Quality); Photos (Quick Scan); Custom; Draft Copy or Fine Copy.**

To change any of the settings for this mode, click **Modify Settings**.



Faxing is only possible if you have a fax modem attached to your computer.

Word Processor

Word Processor—From the pull-down list, select the word processor you want to use.

Click the **Link Settings** button to display the screen to set up the document format you want to use and identify the OCR program:

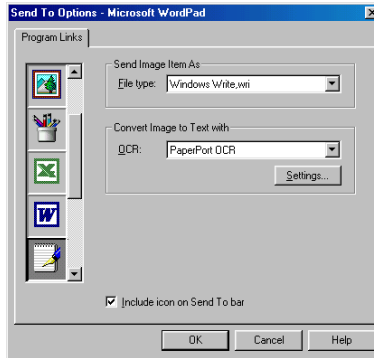

File type—From the pull-down list, select the file type you want to use for your word processor or text documents.

OCR—Identify the OCR program to use to convert scanned document images to editable documents. This option is available only when you have an OCR program other than the one provided with PaperPort. (PaperPort 8.0 uses the same OCR engine that is in ScanSoft's OmniPage® Pro Millennium product.)

Click the **Settings** button to choose how the OCR application will read the pages that you scan into your word processor application.

The **OCR Settings** window will appear:

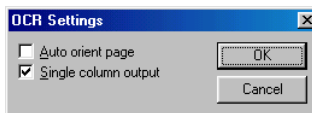

Select your setting and click **OK**.

- *Auto orient page*—Click this checkbox to automatically rotate pages so that the text is upright.
- *Single column output*—Click this checkbox if you want to remove columns from multi-column documents so that converted text appears in a one-column format.

Scan to Image

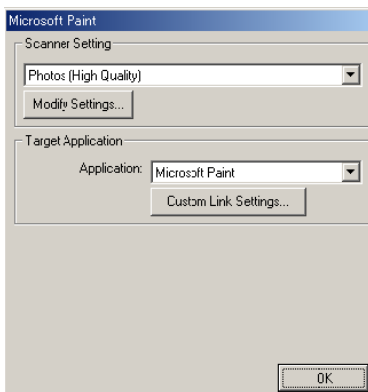

To access Scan to Image Configurations screen

- 1 Place the original face up in the ADF. The Brother Control Center screen will pop up.
- 2 Right-click the graphic application button and click on *Configuration*. Click the **Modify Settings** button to view the configuration screen of the **Control Center**.
- 3 To save your settings, click **OK**.
—OR—
To go back to the default settings, click the **Restore Defaults** button.

Scanner Settings

From the pull-down list, select the scanning mode that is appropriate for the type of file: **Faxing, Filing and Copying; Text for OCR; Photos; Photos (High Quality); Photos (Quick Scan); Custom; Draft Copy** or **Fine Copy**.

To change any of the settings for this mode, click **Modify Settings**.



Faxing is only possible if you have a fax modem attached to your computer.

Target Application

Application—From the pull-down list, select the application you want to add to this Pop-Up screen.

Click the **Custom Link Settings** button to set up links for your user-defined application.

Copy

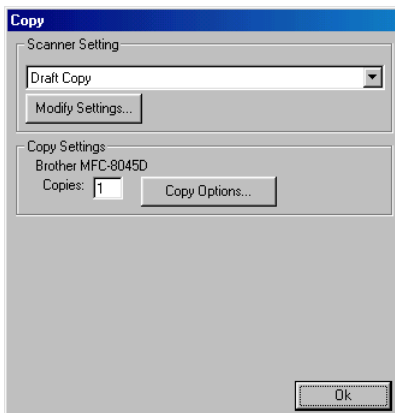

To access the Copy Configurations screen

- 1 Place the original face up in the ADF. The Brother Control Center screen will pop up.
- 2 Right-click the Copy and click on *Configuration*. Click the **Modify Settings** button to view the configuration screen of the **Control Center**.
- 3 To save your settings, click **OK**.
—OR—
To go back to the default settings, click the **Restore Defaults** button.

Scanner settings

From the pull-down list, select the scanning mode that is appropriate for the type of file: **Draft Copy** or **Fine Copy**.

To change any of the settings for this mode, click **Modify Settings**.

Number of copies

Copies—Enter the number of copies you want to print.

To change the copy options, click the **Copy Options** button.

Click **OK** to save your Copy settings.

10 Using the Windows®-Based Brother SmartUI Control Center (For Windows® XP)

Brother SmartUI Control Center

The Brother Control Center is a software utility that allows you to quite easily, with very few mouse clicks, access the most frequently used scanning applications. Using the Control Center eliminates the need to manually launch the specific applications and allows you to scan a document directly to a folder on your computer. The Brother Control Center provides four categories of operations:

- 1 Scan directly to a file, E-mail, word processor or graphics application of your choice.
- 2 Enhanced copy functions, such as Four/Two or One-on-One Copying.
- 3 Custom buttons allow you to configure a button to meet your own application requirements.



In the Task Tray right-click on the Control Center  icon and select **Show** to have access to the Brother SmartUI Control Center window.

AutoLoad the Brother Control Center

The Control Center is initially configured to automatically load each time Windows® is started. When the Control Center is loaded the Control Center  icon will appear in the task bar. If you don't want the Control Center to load automatically, you can turn AutoLoad off.

How to turn off Auto Load

- 1 Click the Control Center  icon in the Task Tray and select **Show**.
- 2 The main SmartUI Control Center window appears. Please look at the bottom of the window for a check box labeled “AutoLoad Pop-up”.



- 3 Uncheck the AutoLoad Pop-Up option to prevent the SmartUI from automatically loading every time Windows is started.

Brother Control Center features

The SmartUI control center gives you the ability to configure the hardware **Scan** key on your DCP such as “Scan to File”. The “Scan to File” feature allows you to scan a document directly to your hard disk and choose the file format and destination folder without having to run any other applications. Select which section you want by clicking on the appropriate tab.

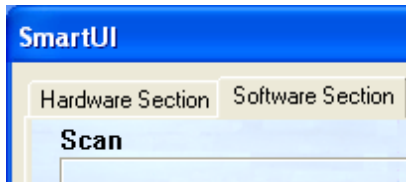

Auto Configuration

During the installation process the Control Center checks your system to determine the default applications for E-mail, word processing and graphics viewer/editor.

For example, if you are using Outlook as your default E-mail application, the Control Center automatically will create a link and a scanning application button for Outlook.

You can change the default application by right-clicking on any of the scan buttons in the Control Center and then clicking *Configuration*. Select the Configuration tab and from the Application pull down menu select a different application. For example, you can change the E-mail scan button from Outlook Express to Outlook by changing the application that is listed.

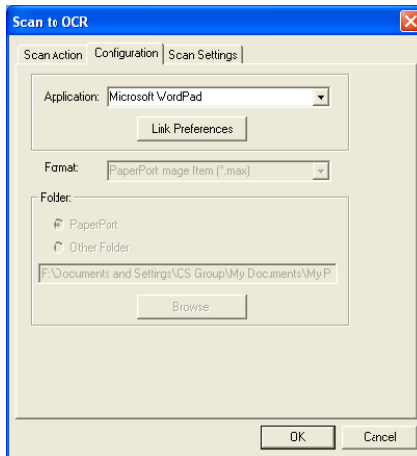

Hardware Section: Changing the Scan to button configuration

When the SmartUI Control Center is displayed, you can access the Hardware Section window to reconfigure the **Scan** button on your DCP. Click the Hardware Section tab at the top left of the SmartUI Control Center screen. (See *Using the scan key (For USB or Parallel interface cable users)* on page 8-16.)

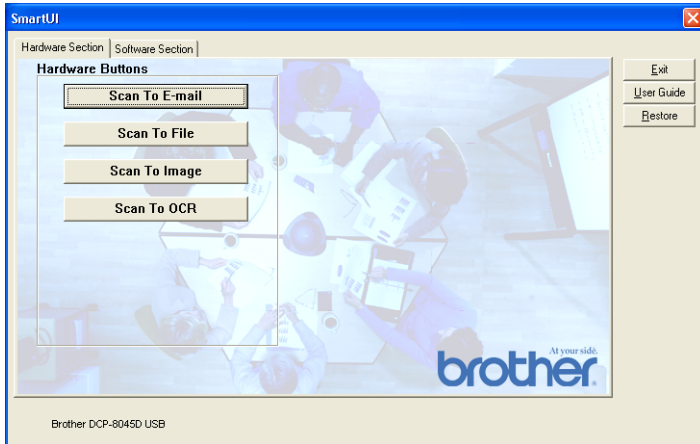

Scan to E-mail

To configure the Scan to E-mail feature left-click on the **Scan to E-mail** button and the following screen will appear. You have the ability to change the configuration that includes the destination E-mail application, attachment file and the scanner settings.

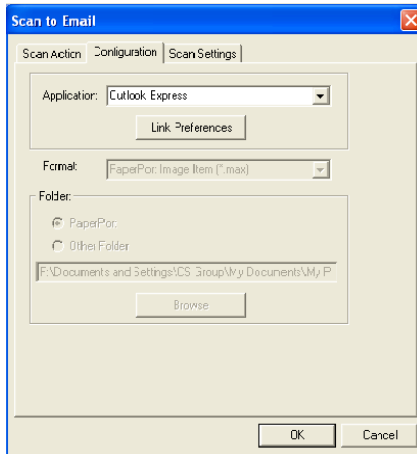

To change the destination E-mail application you use the Application pull down list to select the compatible E-mail application, which is installed on your system.

If you wish to change the attachment file type click on the **Link Preferences** button to display a list of file types.

Scan to File

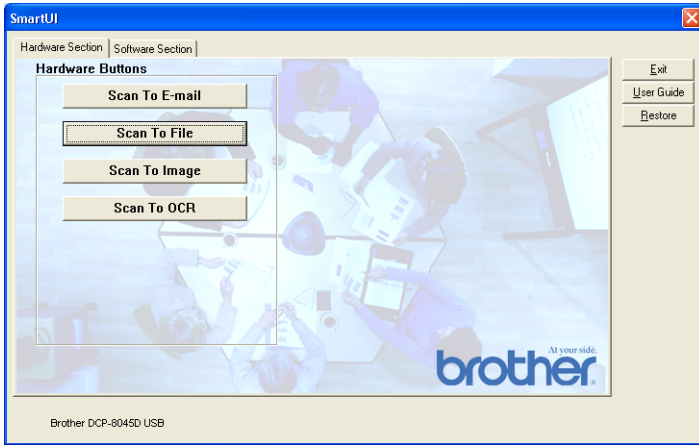

To configure the Scan to File feature, left click on the Scan to File button and the following screen will appear.

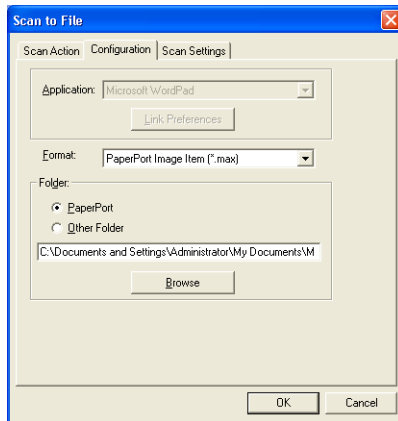

Select the file type for the saved image by selecting from the Format pull down list. You can save the file to the default PaperPort folder so the file appears in PaperPort or you can select another folder/directory by clicking the Browse button.

Scan to Image

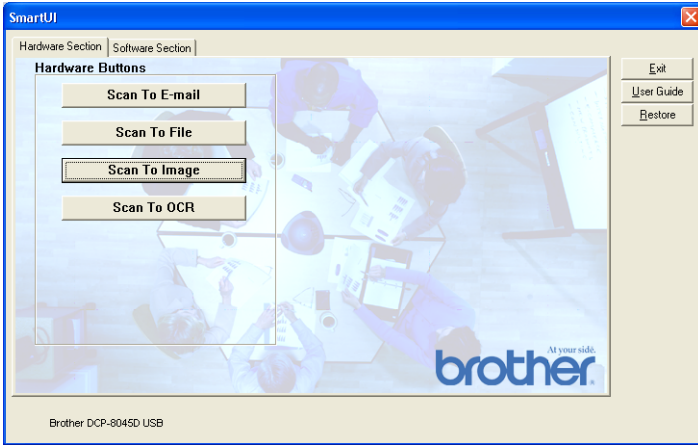

To configure the Scan to Image feature left-click on the **Scan to Image** button and the following screen will appear. You can change the configuration, which includes the destination image format or document application.

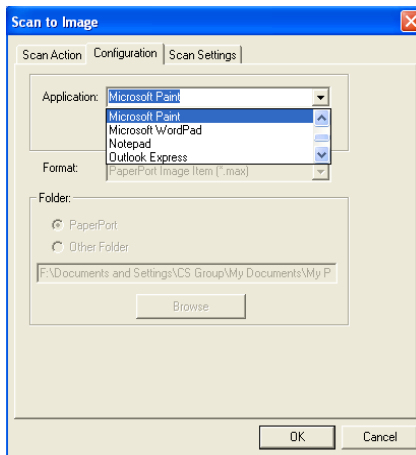

To change the default settings of the scan, click on the **Scan Settings** tab.

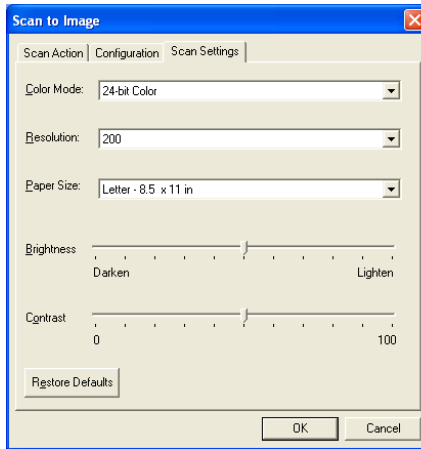

You can set the Color Mode to Black & White, 8-bit Gray or 24-bit Color.

The resolution can be changed from 100 to 1200 dpi. You can define the size of the paper you're using, and you can adjust the brightness and contrast of the image before scanning.

Scan to OCR

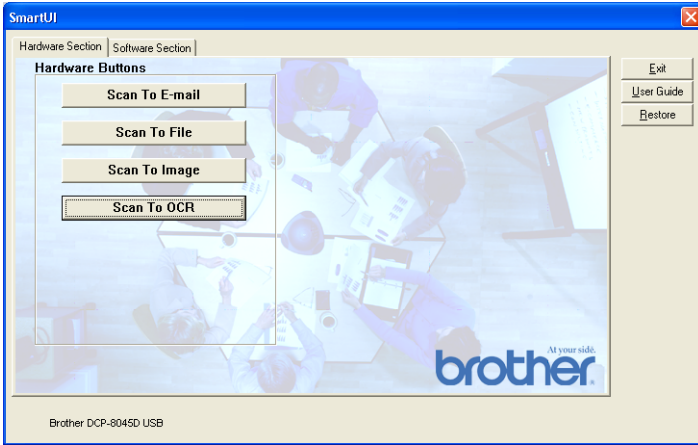

To configure the Scan to OCR feature left-click on the **Scan to OCR** button and the following screen will appear. You can change the configuration, which includes the destination applications.

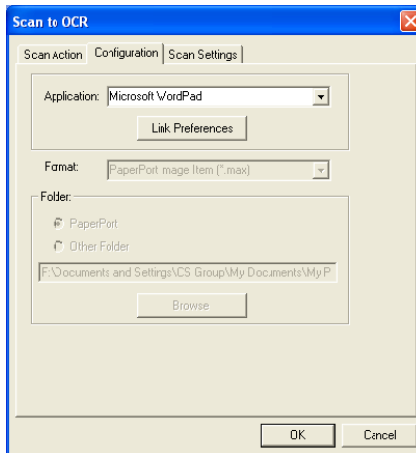

You have the option to send your scan as a different file type. You can select the application from the File Type window according to your needs.

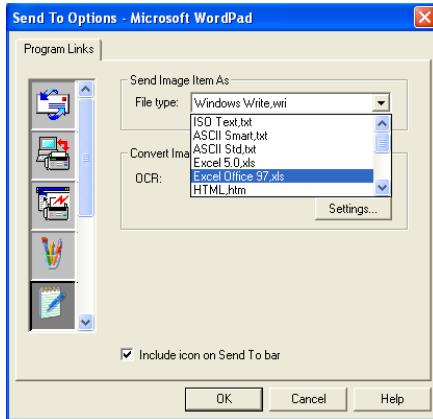

You have the option to choose your OCR setting from **Single column output** to **Auto orient page**.

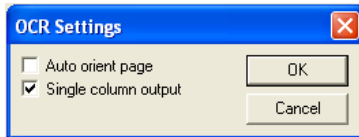

Software Section

The Software Section contains three groups of scan to buttons. Each section has a number of different buttons which are predefined for the most frequently used applications. The **Scan** section contains four buttons for Scan to File, Scan to E-mail, Scan to Word Processor and Scan to Image applications. The **Copy** section contains three buttons for N to 1 copying. The **Custom** section contains three buttons with you can assign your own function.

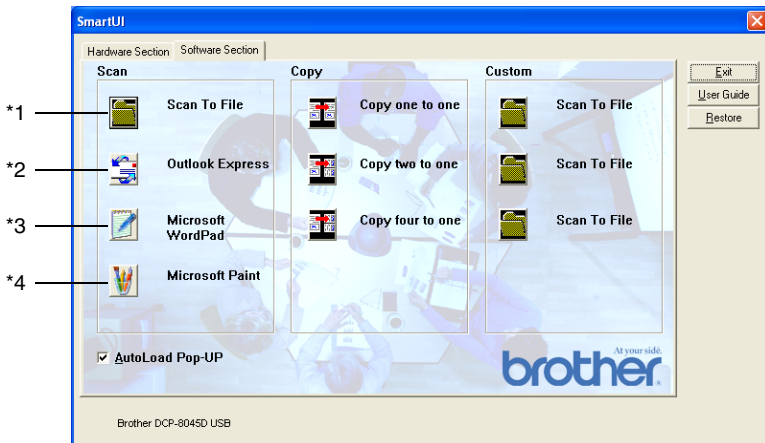

Scan

*1 *Scan to File*—enables you to scan directly to a disk file. You can change the file type and destination directory, as needed.

*2 *Scan to E-mail (Default: Outlook Express)*—enables you to scan a page or document directly into an E-mail application as a standard attachment. You have the option of selecting the file type and resolution for the attachment.

*3 *Scan to Word Processor (Default: MS WordPad)*—enables you to scan a page or document, automatically run ScanSoft® OmniPage® OCR and insert the text (not graphic image) into a word processing program. You have the option of selecting the destination word processing program, such as WordPad, MS Word, Word Perfect or whichever word processing program is installed on your computer.

*4 *Scan to Graphic Application (Default: MS Paint)*—enables you to scan a page directly into any graphic viewer/editor application. You can select the destination application, such as MS Paint, Corel PhotoPaint, Adobe PhotoShop, or any kind of image editor application you already have installed on your computer.

Copy

Copy (Copy one to one)—allows you to use the PC and any Windows® printer driver for enhanced copy operations. You can scan the page on the DCP and print the copies using any of the features of the DCP printer driver—**OR**—you can direct the copy output to any standard Windows® printer driver installed on the PC including network printers.

Four/Two to One Copy—enables you to use the Four/Two on One-page features of the Brother printer driver to copy four/two original pages onto a single output page.

Custom

Scan to File—These buttons have been pre-programmed for the Scan to File feature. You can change the configuration of each of these buttons to meet your specific requirements by right-clicking on a button and following the configuration menus.

Scan to File

The Scan to File button allows you to scan an image and save it in a specific file type to any directory on your hard disk. This allows you to easily archive your paper documents. To configure the file type and save to directory right-click on the Scan to File button and click Configuration.

The Scan Action tab is set to File and should not be changed.

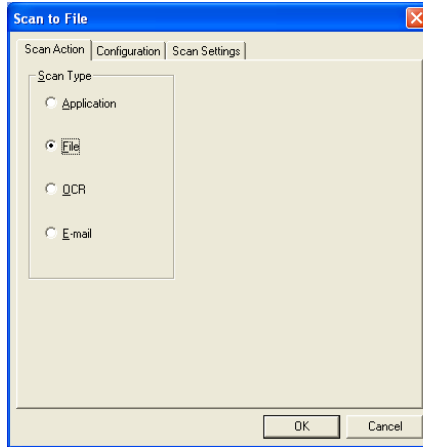

To change the configuration click on the Configuration tab.

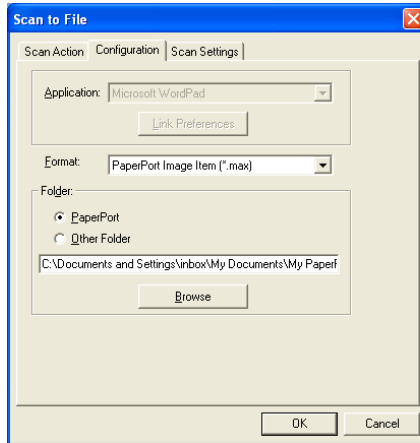

Select the file type for the saved image by selecting from the Format pull down list. You can save the file to the default PaperPort folder so the file appears in PaperPort, or you can select another folder/directory by clicking the Browse button.

You can change the default setting by selecting the Other Folder button and then clicking Browse and selecting the folder in which you wish to save your files.

Scan to E-mail

The Scan To E-mail is automatically configured to your default E-mail application. To change the default E-mail application or attachment file type, right-click on the E-mail button and select “Configuration”.

The Scan Action tab is set to E-mail and should not be changed.

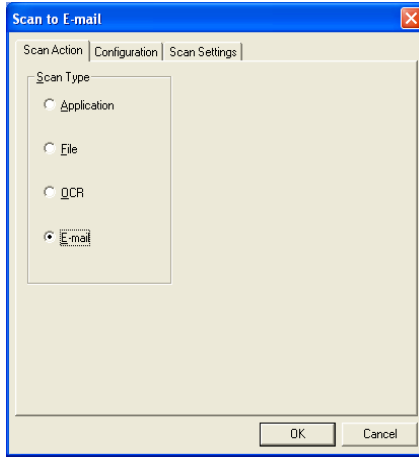

To change the E-mail application click on the Configuration tab. From the Application pull down list, select your preferred E-mail application.

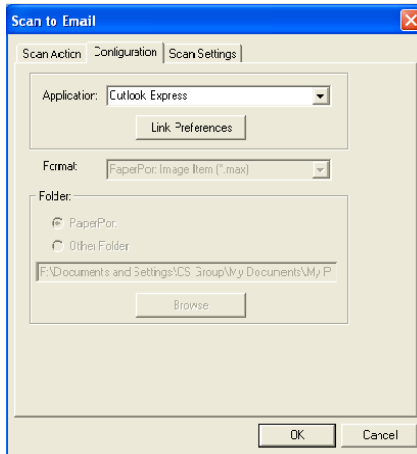

To change the file type of the attachment click the **Link Preferences** button to set up links. Check the **Convert attachment to specified file type** box and then select the appropriate file type from the pull down list.

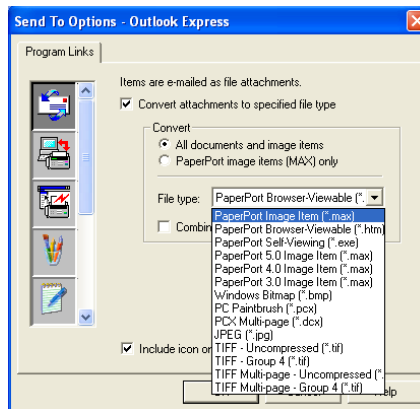

File attachments

Items are mailed as file attachments using the file type you have selected.

Convert attachments to specified file type—Click this check box if you want to change the file type of attachments.

All documents and image items—Click this check box if you want to convert all scanned images to the same file type.

PaperPort image items (MAX) only—Click this check box if you want to convert only attachments that are PaperPort MAX files.

Combine items into single file, if possible—Click this check box if you want to combine all the attachments into one file. With this box unchecked each scanned page will be saved in its own individual file.

File Type—Select from the pull-down list the type of file you want the scanned images to be saved in.

- PaperPort Image Item (*.max)
- PaperPort Browser-Viewable (*.htm)
- PaperPort Self Viewing (*.exe)
- PaperPort 5.0 Image Item (*.max)
- PaperPort 4.0 Image Item (*.max)
- PaperPort 3.0 Image Item (*.max)
- Windows Bitmap (*.bmp)
- PC Paintbrush (*.pcx)
- PCX Multi-page (*.dcm)
- JPEG (*.jpg)
- TIFF-Uncompressed (*.tif)
- TIFF Group 4 (*.tif)
- Multi-Page -Uncompressed (*.tif)
- Multi-Page - Group 4 (*.tif)

Scanner settings

You have the ability to change the scanner settings used to create the file attachments. Click on the Scan Settings tab and select the appropriate settings.

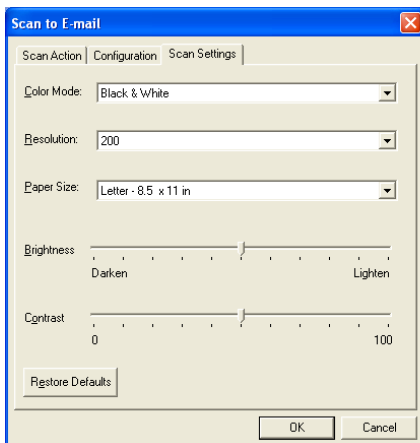

Scan to OCR (Word Processing program)

Scan to OCR converts the graphic page image data to text which can be edited by any word processor program. You can change the default word processor program (example: Word Pad instead of Word) and file type. You can also choose another OCR software package besides the OmniPage® OCR which is built into PaperPort. To configure Scan to OCR right-click on the WordPad button and select Configuration. The Scan Action tab is set to OCR and should not be changed.

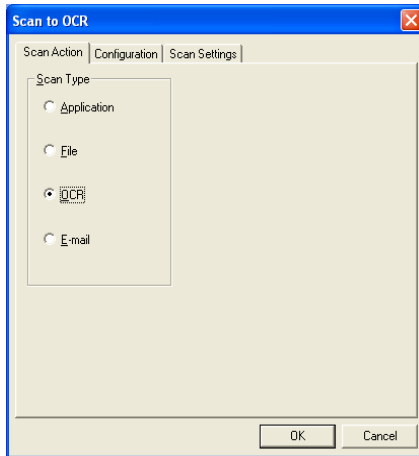

To change the word processing application click on the Configuration Tab. You can select the destination word processing application from the Application pull down list.

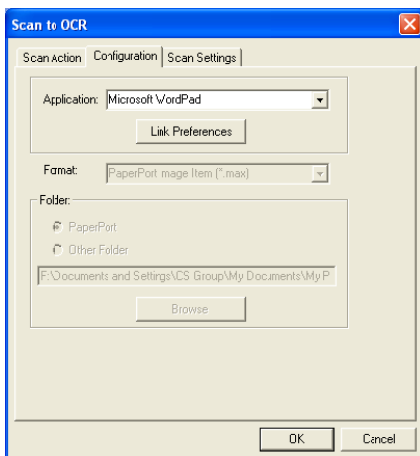

To change the program link preferences click the Link Preferences button.

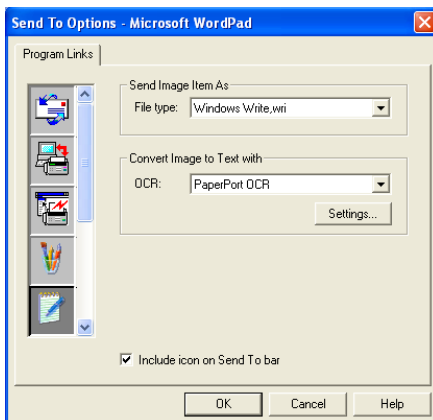

File Type—From the pull-down list, select the file format you want to use for documents.

OCR—Select the OCR application from the OCR pull down list.

Scan to Graphics application (example: Microsoft Paint)

The Scan to Graphics Application allows you to scan an image so you can edit the image. To change the default graphics application right-click on the button and select Configuration.

The Scan Action tab is set to Application and should not be changed.

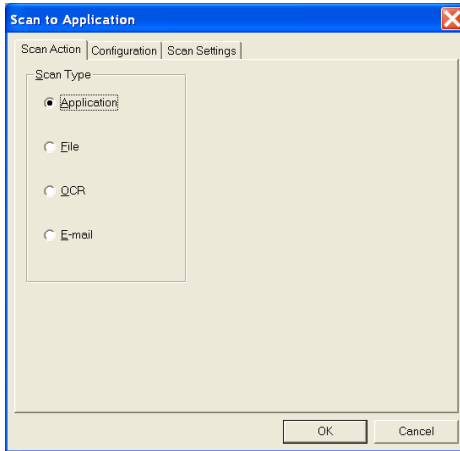

To change the configuration of the destination application click on the Configuration Tab.

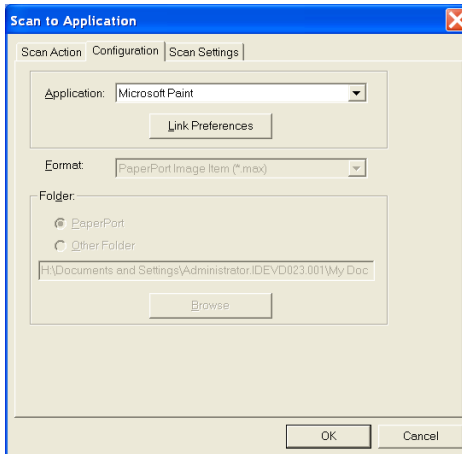

To change the destination application select the appropriate application from the Application pull down list.

To change the other configuration options click the Link Preferences button.

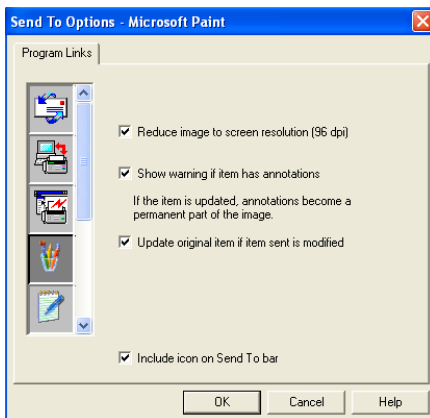

These options enable you to reduce the image to a screen resolution of (96dpi), show a warning if the item has any annotations and update the original item if the sent item is modified.

Copy

The copy buttons can be customized to allow you to take advantage of the features built into the Brother printer drivers to do advanced copy functions such as n-in-1 printing.

The Copy buttons are automatically linked to the default Windows printer driver. You can set any printer as the default printer including non-Brother printers. Before you can use the Copy buttons you must first configure the printer driver by right-clicking on a Copy button and selecting Configuration.

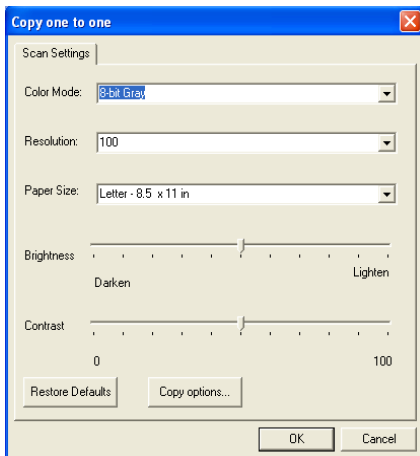

In the Scan Settings window you can select the color mode, resolution, paper size, brightness and contrast settings to be used.

To finish the Copy button configuration you must set the printer driver. Click the Copy options button to display the printer driver settings.



The copy options screen will vary depending upon which Brother model you purchased.

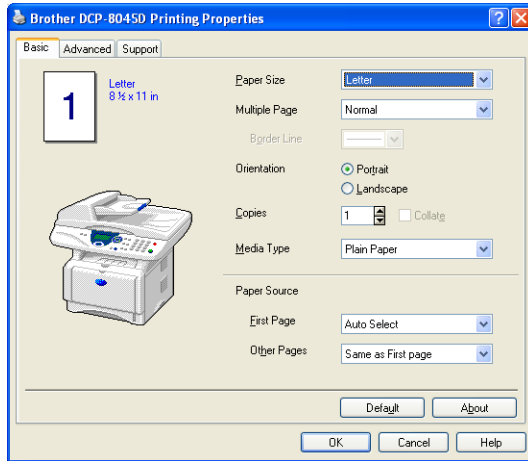

Select the number of Pages Per Sheet from the Scaling selections. As an example to configure the section Copy button to copy two pages to one you must select 2 in 1.



You must configure each of the copy buttons before they can be used.

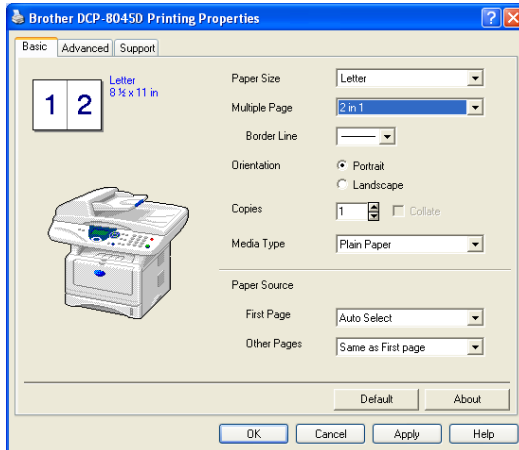

Custom: User-defined buttons

There are up to three Custom buttons on the Brother SmartUI Control Center. (NOTE: The number of Custom buttons depends on which Brother model you purchased.) You can set your own preferences and configuration to fit your required application.

To configure a Custom Button right click on the button and then click Configuration. The configuration window will appear. You have four function choices Application, File, OCR and E-mail.

Application: This setting will link the Control Panel button to any button which appears on the PaperPort Send to Bar. Please see the PaperPort help file for more information regarding PaperPort compatible applications.

File: This setting allows you to save a scanned image to any directory on local or network hard disk. You can also select the file format to be used.

OCR: Scanned documents will be converted to editable text files. If you have a third party OCR software package installed on your PC you can select it. The default OCR software is OmniPage® which is built into PaperPort 8.0. You can also select the destination word processor and file format for the editable text.

E-mail: Scanned images will be attached to an E-mail message. You can choose which E-mail package to use if you have more than one installed on your system. You can also select the file type for the attachment.

Customizing a user-defined button

To configure a Custom button right-click on the button and then click Configuration. Please follow the following guide lines for Custom Button configuration.

1. Select the Scan Action

Select the type of scan by clicking the appropriate button.

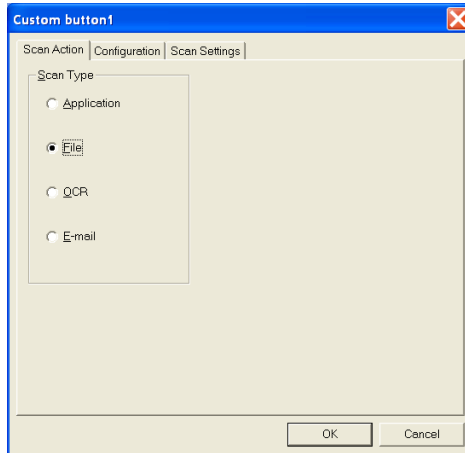

2. Select Configuration for the Scan Type.

To configure the scan operation click on the Configuration Tab. Depending upon which Scan Type button you selected you will see a different Configuration Tab list of settings.

Application:

Select the destination application program from the pull down list.

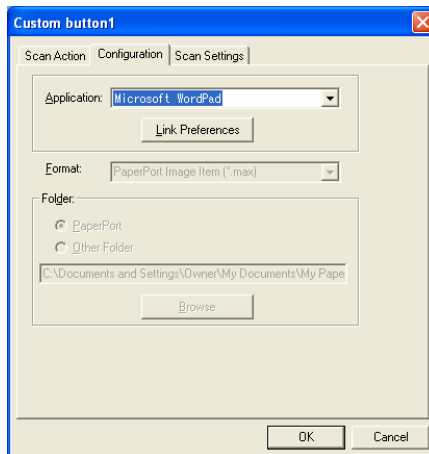

Click on Link Preferences to set the Send to options. You can select the application from the scroll menu on the left.

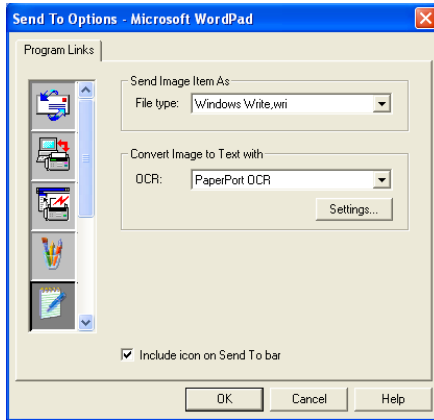

File:

Select the file format from the Format pull down list. You can either send the file to the default PaperPort directory or select your own destination directory by selecting Other Folder. Use the Browse button to select the destination directory.

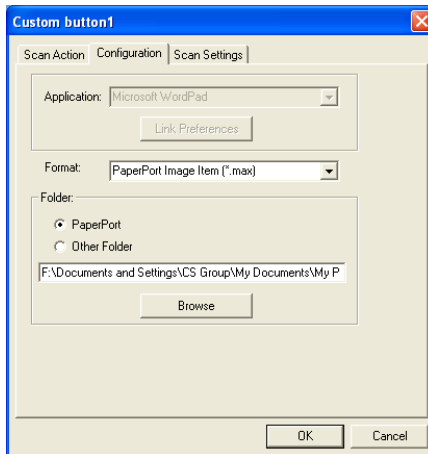

OCR:

Select the destination word processing application program from the pull down list.

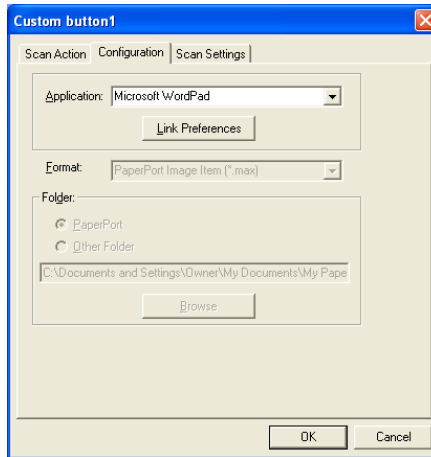

Click on Link Preferences and select the destination Application from the scroll menu on the left. Select the File Type from the File Type pull down list. You can also choose another OCR application from the OCR pull down list if another is installed on your system. ScanSoft® OmniPage® is installed as part of the PaperPort 8.0 application.

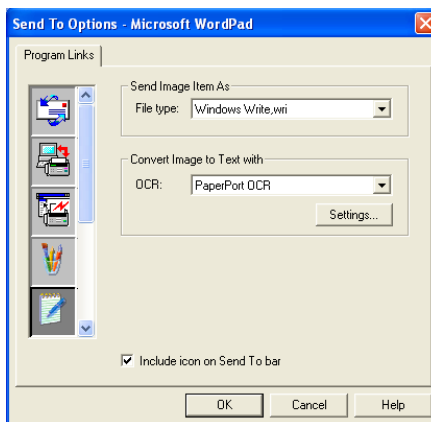

E-mail:

Select the destination E-mail application program from the pull down list.

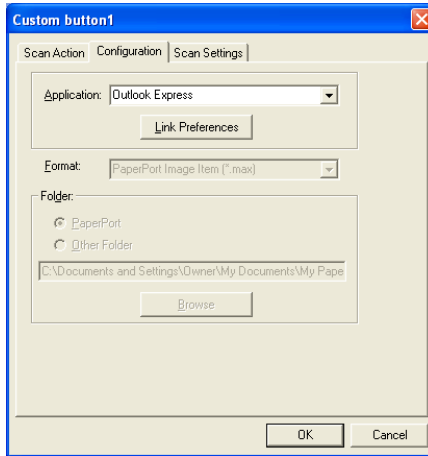

Click on the **Link Preferences** button to configure the Send To E-mail options. You can select the File type and Quick Send E-mail address list.

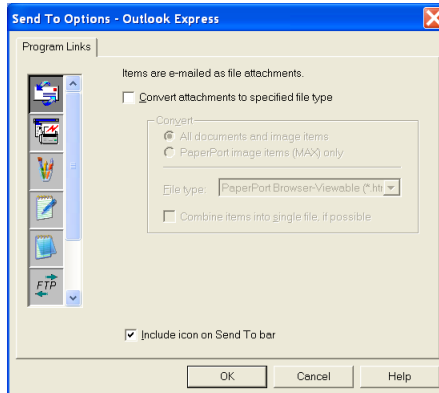

3. Select Scan Settings.

You can select the scanner settings from each of the Scan Type options for the Custom buttons. You have the option to select Color Mode, Resolution, Paper Size and Brightness and Contrast settings.

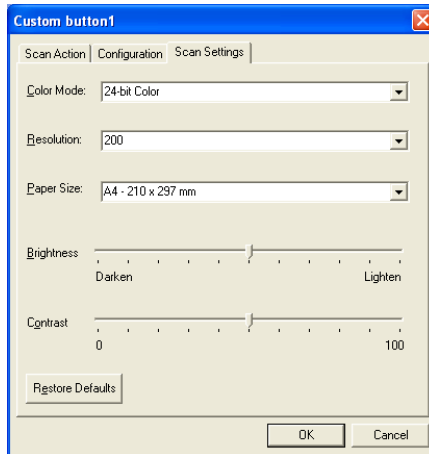

11 Using your DCP with a Macintosh®

Setting up your USB-equipped Apple® Macintosh®



- Before you can connect the DCP to your Macintosh®, you must buy a USB cable that is not longer than 1.8 metres. **Do not connect the DCP to a USB port on a key board or a non-powered USB hub.**
- Some descriptions in this chapter are based on the DCP-8045D. These descriptions also apply to the DCP-8040.

The features supported by the DCP will depend on the operating system you are using. The chart below shows which features are supported.

Feature	Mac OS®		Mac OS® X	
	8.6	9.X	10.1	10.2.1 or greater* ¹
Printing	Yes	Yes	Yes	Yes
Scanning (TWAIN)	Yes	Yes	No	Yes

*¹ For Mac OS® X 10.2 users, please upgrade to Mac OS® X 10.2.1 or greater. (For the latest information for Mac OS® X, please visit at: <http://solutions.brother.com>)

Using the Brother printer driver with your Apple® Macintosh® (Mac OS® 8.6 - 9.2)

To select a Printer:

- 1 Open the **Chooser** from the Apple menu.

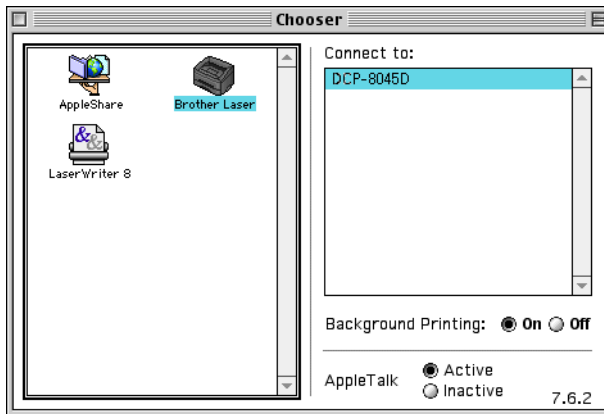

- 2 Click the **Brother Laser** icon. On the right side of the **Chooser** window, click the printer you want to print to. Close the **Chooser**.

To print a document:

- 1 From the application software such as Presto!® PageManager®, click **File** menu and select **Page Setup**. You can change the settings for **Paper Size**, **Orientation**, and **Scaling**, and then click **OK**.

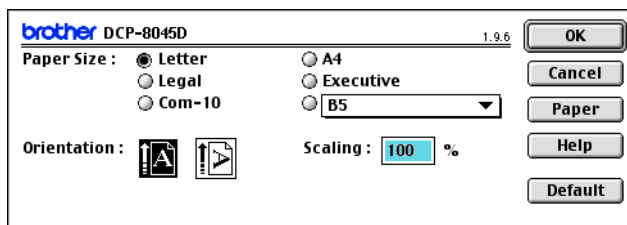

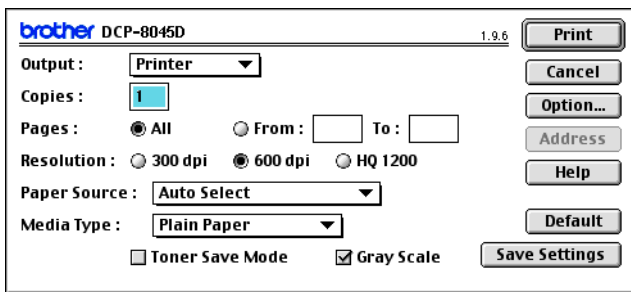

- 2 From application software such as Presto!® PageManager®, click **File** menu and select **Print**. Click **Print** to start printing.

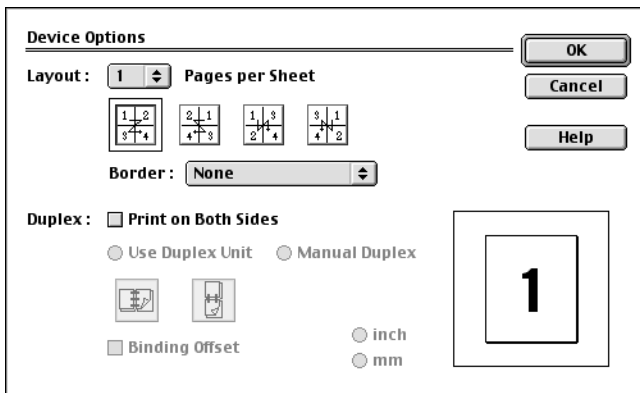

 If you want to change **Copies**, **Pages**, **Resolution**, **Paper Source** and **Media Type**, select your settings before clicking **Print**.

Device Options allows you to select **Duplex**.



 Automatic Duplex is only available with the DCP-8045D.

Using the Brother Printer Driver with Your Apple® Macintosh® (Mac OS® X)

Choosing page setup options

- 1 From application software such as Presto!® PageManager®, click the **File** menu and select **Page Setup**. Make sure *DCP-8040* or *DCP-8045D* is selected in the **Format for** pop-up menu. You can change the settings for **Paper Size**, **Orientation** and **Scaling**, then click **OK**.

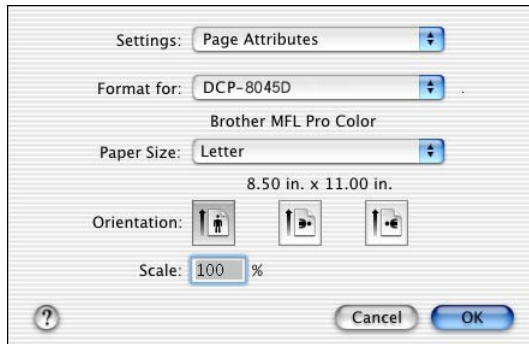

- 2 From application software such as Presto!® PageManager®, click **File** menu and select **Print**. Click **Print** to start printing.

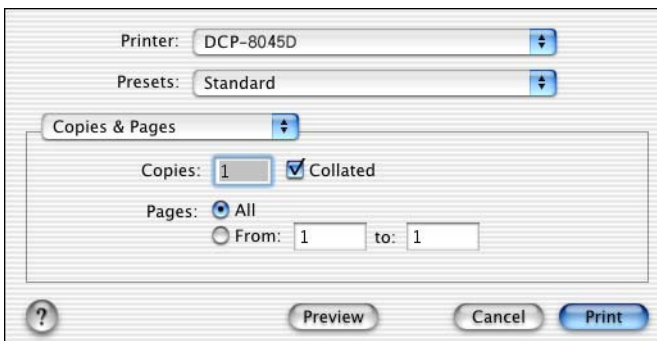

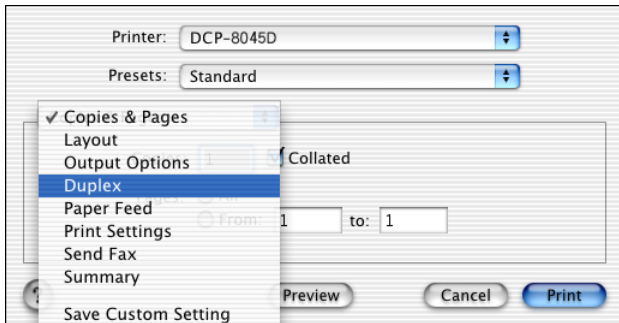

Specific settings

Set the **Media Type**, **Resolution**, **Toner Save**, and other settings. Press **Copies & Pages** to select settings you want to change.

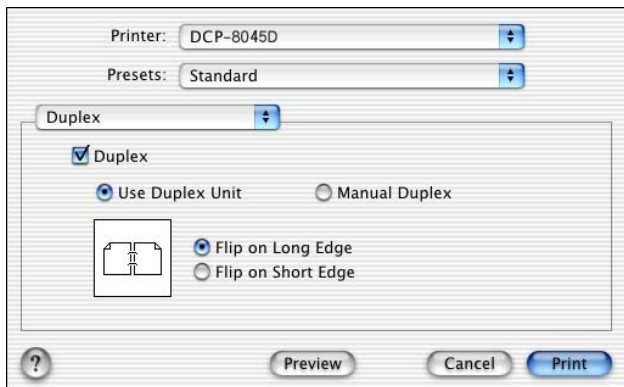

Duplex



 Automatic Duplex is only available with the DCP-8045D.

Printer settings

Printer: DCP-8045D

Presets: Standard

Print Settings

Quality

- Normal (300 dpi)
- Fine (600 dpi)
- Super Fine (HQ1200)

Media Type : Plain Paper

Toner Save Mode

? Preview Cancel Print

Using the PS driver with your Apple® Macintosh®

 To use the PS driver on a Network, see the NC-9100h Network User's Guide on CD-ROM.

 To use the PS driver with a USB cable, you need to set the Emulation to BR-Script 3 (**Menu, 3,1**) before connecting the USB cable. (See *Setting the Emulation Selection* on page 6-17.)

 The PS driver does not support the following functions:

- HQ 1200
- Secure Print

For Mac OS® 8.6 to 9.2 users

1 For Mac OS® 8.6 to 9.04 Users:

Open the **Apple Extras** folder. Open the **Apple LaserWriter Software** folder.

For Mac OS® 9.1 to 9.2 Users:

Open the **Applications** (Mac OS® 9) folder. Open the **Utilities** folder.*

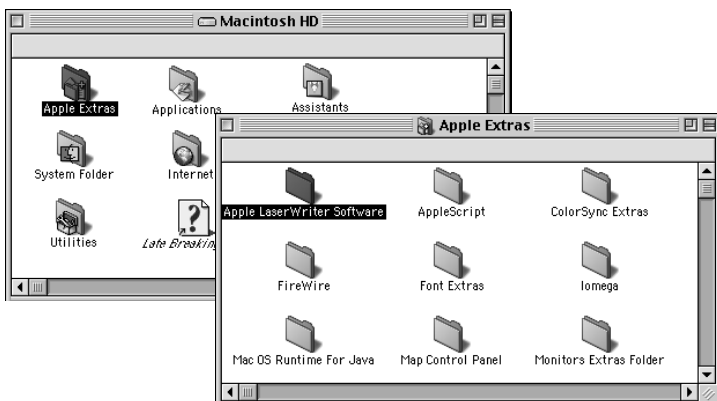

* The screens are based on Mac OS® 9.04.

- 2 Open the **Desktop Printer Utility** icon.

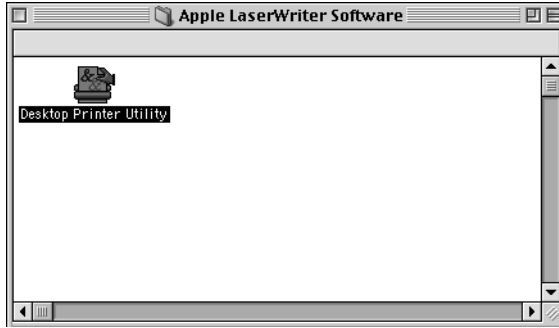

- 3 Select **Printer (USB)**, and then click **OK**.



- 4 Click **Change...** in the PostScript® Printer Description (PPD) file. Select **Brother DCP-8045D**, and then click **Select**.

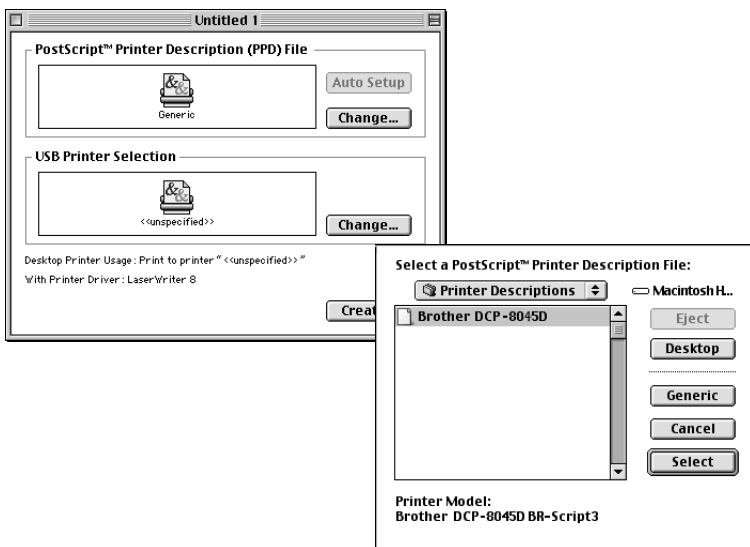

- 5 Click **Change...** in the **USB Printer Selection**. Select **Brother DCP-8045D**, and then click **OK**.

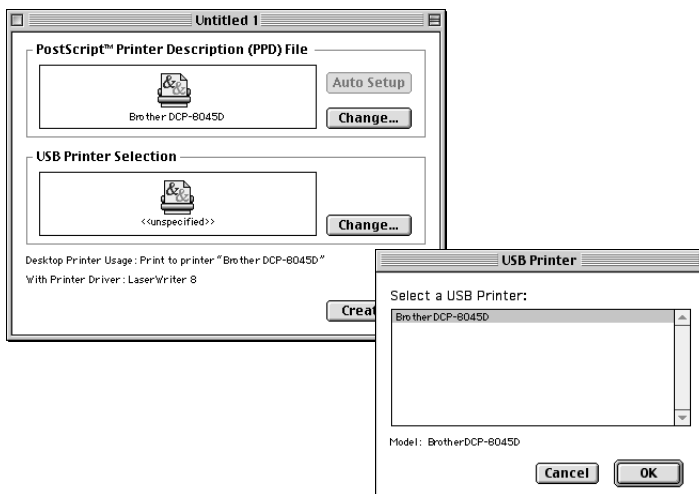

6 Click **Create....**

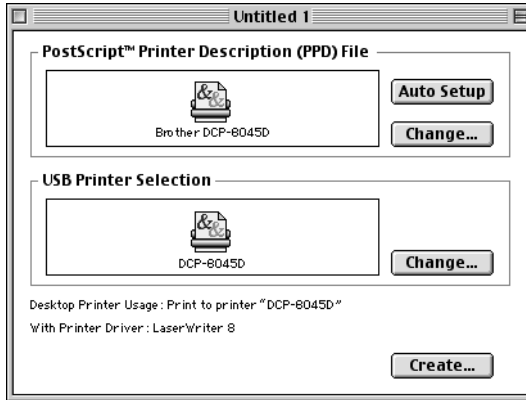

7 Enter your DCP name (DCP-8045D), and then click **Save**.

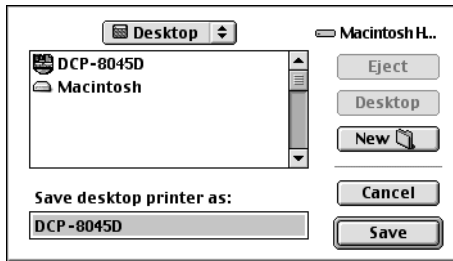

8 Select **Quit** from the **File** menu.

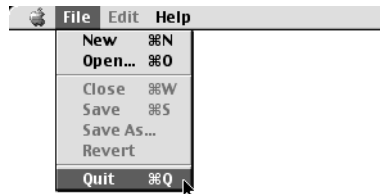
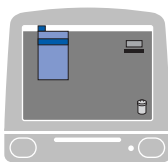

9 Click the **DCP-8045D** icon on the Desktop.



10 Select **Set Default Printer** from the **Printing** menu.

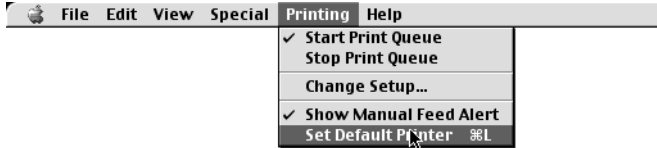

For Mac OS® X users

You need to install the PS driver using the following instructions.



- If you use a USB cable and your Macintosh® is “Mac OS® X”, only one printer driver for a DCP can be registered in Print Center.
- If a Brother Native Driver (DCP-XXX) is already listed in Printer list, you will need to delete it and then install the PS driver.
- To use the PS driver with a USB cable, you need to set the Emulation to BR-Script 3 (**Menu, 3, 1**) before connecting the USB cable. (See *Setting the Emulation Selection* on page 6-17.)

1 Select **Applications** from the **Go** menu.



2 Open the **Utilities** folder.



3 Open the **Print Center** icon.

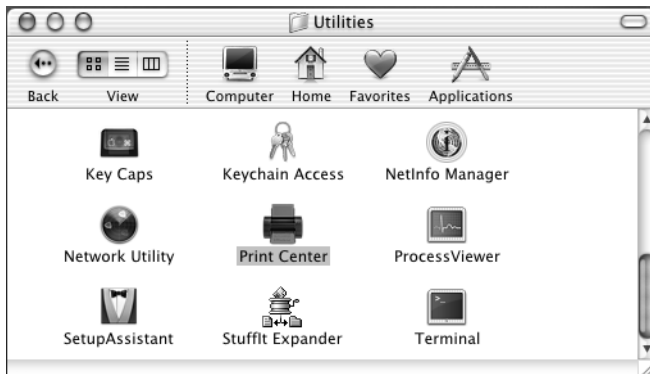

4 Click **Add Printer...**



5 Select **USB**.



6 Select **DCP-8045D**, and then click **Add**.

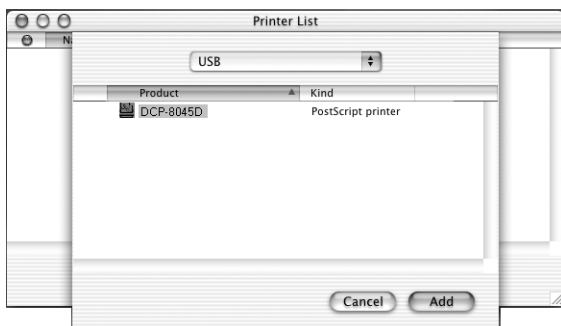

7 Select **Quit Printer Center** from the **Print Center** menu.

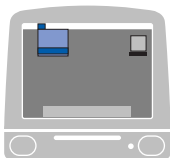

Using the Brother TWAIN scanner driver with your Macintosh®

The Brother DCP software includes a TWAIN Scanner driver for Macintosh®. You can use this Macintosh® TWAIN Scanner driver with any applications that support the TWAIN specifications.

 Mac OS® X Scanning is supported in Mac OS® X 10.2.1 or greater.

Accessing the scanner

Run your Macintosh® TWAIN-compliant application software. The first time you use the Brother TWAIN driver (MFL Pro/P2500), set it as the default by choosing **Select Source** (or the other menu name to select the device). Afterwards, for each document you scan choose **Acquire Image** or **Scan**. The scanner setup dialog box will appear.

-  ■ The screen shown in this section are from Mac OS® 9. The screen on your Macintosh® may vary depending on your Operating System.
- The method of selecting the source or choosing to scan may vary depending on the application software you are using.

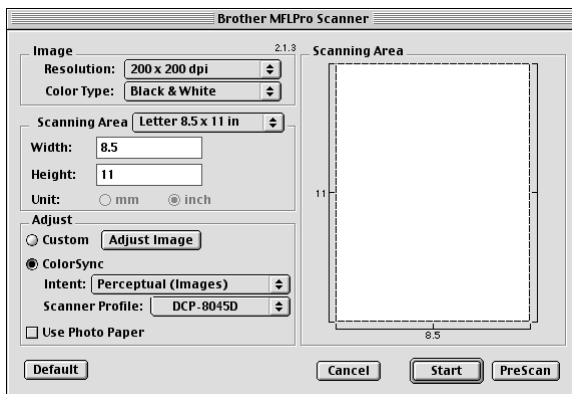

(Mac OS® 8.6–9.2)

Scanning an image into your Macintosh®

You can scan a whole page

—OR—

scan a portion after prescanning the document.

Scanning a whole page

- 1** Place the original face up in the ADF, or face down on the scanner glass.
- 2** Adjust the following settings, if needed, in the Scanner Setup dialog box:
 - Resolution**
 - Color Type**
 - Scanning Area**
 - Brightness**
 - Contrast**
- 3** Click **Start**.
When scanning has finished, the image will appear in your graphics application.

Pre-Scanning an image

Pre-Scanning allows you to scan an image quickly at a low resolution. A thumbnail version will appear in the **Scanning Area**. This is only a preview of the image, so you can see how it will look. The **PreScan** button will allow you to crop unwanted areas from the images. When you are satisfied with the preview, click **Start** to scan the image.

- 1** Insert the original face up in the ADF, or face down on the scanner glass.
- 2** Click **PreScan**.
The whole image will be scanned into your Macintosh® and will appear in the **Scanning Area** of the Scanner dialog box:
- 3** To scan a portion of the pre-scanned image, click and drag the mouse to crop it.

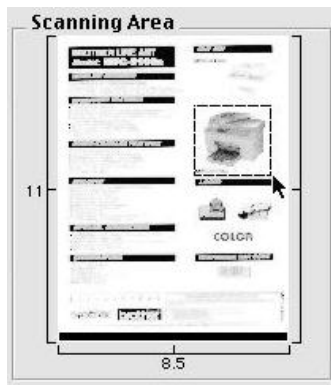

- 4** Insert original in the ADF, if you are using ADF.
- 5** Make your adjustments to the settings for **Resolution**, **Color Type** (Gray Scale), **Brightness**, **Contrast**, and **Size** in the Scanner Setup dialog box.
- 6** Click **Start**.
This time only the cropped area of the original will appear in the Scanning Area.
- 7** In your editing software, you can refine the image.

Settings in the Scanner window

Image

Resolution

From the **Resolution** pop-up menu choose the scanning resolution. Higher resolutions use more memory and transfer time, but produce a finer scanned image.

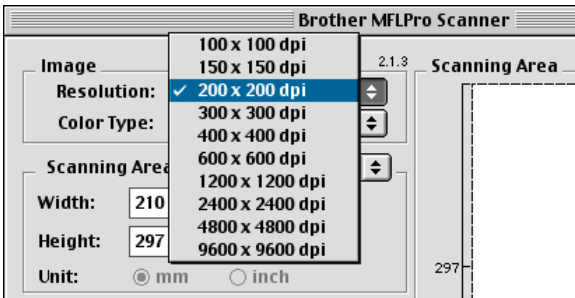

Color Type

Black & White—Set the image Type to *Black and White* for text or line art. For photographic images, set the image type to Gray (Error diffusion) or True Gray.

Gray (Error Diffusion)—is used for documents with photographic images or graphics. (Error Diffusion is a method for creating simulated gray images by placing black dots instead of the true gray dots in a specific matrix instead of true gray dots.)

True Gray—is used for documents with photographic images or graphics. This mode is more exact because it uses up to 256 shades of gray. It requires the most memory and takes the longest transfer time.

Colors—Choose either 8-bit Color, which scans up to 8-bit Color or 24-bit Color which scans up to 16.8 million colors. Although using 24-bit Color creates an image with the most accurate colors, the image file will be about three times larger than a file created with 8-bit Color.

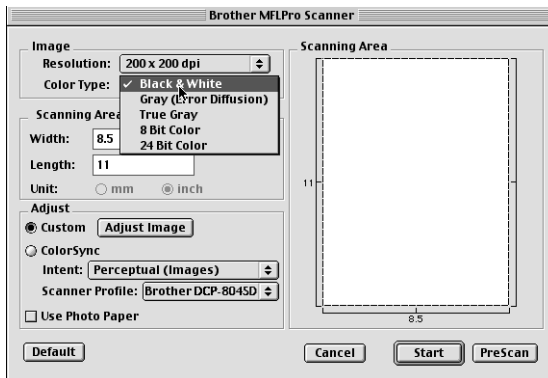

Scanning Area

Set the **Size** to one of the following:

- *Letter (8.5 × 11 in.)*
- *A4 (210 × 297 mm)*
- *Legal (8 1/2 × 14 in.)*
- *A5 (148 × 210 mm)*
- *B5 (182 × 257 mm)*
- *Executive (7.25 × 10.5 in.)*
- *Business Card (90 × 60 mm)*
- *Custom (User adjustable from 0.35 × 0.35 in. to 8.5 × 14 in. or 8.9 × 8.9 mm to 216 × 356 mm)*

After you choose a custom size, you can adjust the scanning area. Click and hold the mouse button as you drag the mouse to crop the image.

Width: Enter the width of the custom size.

Height: Enter the height of the custom size.

Business Card Size

To scan business cards, select the Business Card size (90 × 60 mm) and place the business card at the center of scanner glass.

When you are scanning photographs or other images to use in a word processor or other graphics application, it is a good idea to try different settings for the Contrast, Mode and Resolution to determine which settings look the best.

Adjusting the Image

Brightness

Adjust the **Brightness** setting to get the best image. The Brother TWAIN Scanner driver offers 100 Brightness levels (-50 to 50). The default value is 0, representing an 'average' setting.

You can set the **Brightness** level by dragging the slide bar to the right to lighten the image or to the left to darken the image. You can also type a value in the box to set the level. Click **OK**.

If the scanned image is too light, set a lower Brightness level and scan the image again.

If the image is too dark, set a higher Brightness level and scan the image again.

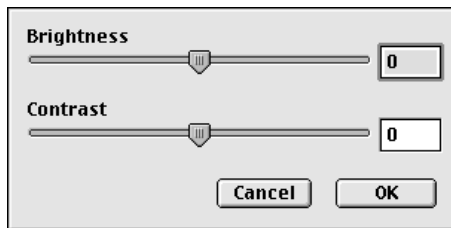

Contrast

You can only adjust the **Contrast** level when you have selected one of the Gray Scale settings, it is not available when you have selected Black & White as the selected **Color Type**.

Increasing the **Contrast** level (by dragging the slide bar to the right) emphasizes dark and light areas of the image, while reducing the **Contrast** level (by dragging the slide bar to the left) reveals more detail in the gray areas. Instead of using the slide bar, you can type a value in the box to set the Contrast. Click **OK**.

Using Presto!® PageManager®

Presto!® PageManager® is application software for managing the documents in your computer. Since it is compatible with most image editors and word processing programs, Presto!® PageManager® gives you unmatched control over your computer files. You can easily manage your documents and edit your E-mail files and read documents with the OCR software built into Presto!® PageManager®.

If you use the DCP as a scanner, we recommend that you install Presto!® PageManager®. To install Presto!® PageManager®, see the Quick Setup Guide on page 38 to 41.



The complete NewSoft Presto!® PageManager® 4.0 User's Guide can be found in the documentation on the CD-ROM supplied with your DCP.

Highlights

- **OCR:** In one step scan an image, recognize the text, and edit it with a word processor.
- **Scan Buttons:** Scan documents and open them with a designated program in one step.
- **Image Editing:** Enhance, crop and rotate images, or open them with an image-editing program of your choice.
- **Annotation:** Add removable notes, stamps and drawings to images.
- **Treeview Window:** View and arrange your folder hierarchy for easy access.
- **Thumbnail Window:** View files as thumbnails for easy identification.

System requirements

- PowerPC processor
- System 8.6, 9X, 10.1, or greater
- CD-ROM drive
- Hard disk drive with at least 120 MB of free disk space

Recommended:

- 8-bit Color or higher video adapter.
- Eudora Mail, or Outlook Express electronic mail software

Technical Support

For USA

Newsoft America Inc.

Postal Address: 4113 Clipper Court Fremont, CA 94538, USA

Telephone: 510-4458600

FAX: 510-4458601

E-mail Address: contactus@newsoftinc.com

URL: <http://www.newsoftinc.com/>

For Canada

E-mail Address: contactus@newsoftinc.com

12 Network Scanning (Windows[®] 98/98SE/Me/2000 Professional and XP only)

To use the DCP as a Network Scanner, the NC-9100h Network board should be installed into the DCP and configured with TCP/IP. You can set or change NC-9100h settings from the control panel or with the BRAdmin Professional utility or Web Management. (Please see the NC-9100h User's Guide on the CD-ROM.)

Network License

This product includes a single PC license. If you purchase an optional Network LAN board NC-9100h that includes the license for up to 4 additional Users, you can install the MFL-Pro Software Suite including ScanSoft[®] PaperPort[®] on up to 5 PC's for use on a network. If you want to use more than 5 PCs with ScanSoft[®] PaperPort[®] installed, please purchase NL-5 which is a multiple PC license agreement pack for up to an additional 5 Users. To purchase NL-5, please contact your Brother Sales Office.

Registering your PC with the DCP

If you need to change the DCP that was registered to your PC during the installation of Brother MFL-Pro Suite (see Quick Setup Guide on page 34), follow the steps below.

1 For Windows[®] 98/Me/2000

From the **Start** menu, select **Control Panel, Scanners and Cameras**, and then right-click Scanner Device icon and select **Properties** to view the Network Scanner Properties dialog box.

For Windows[®] XP

From the **Start** menu, select **Control panel, Printers and Other Hardware, Scanners and Cameras** (or **Control Panel, Scanners and Cameras**).

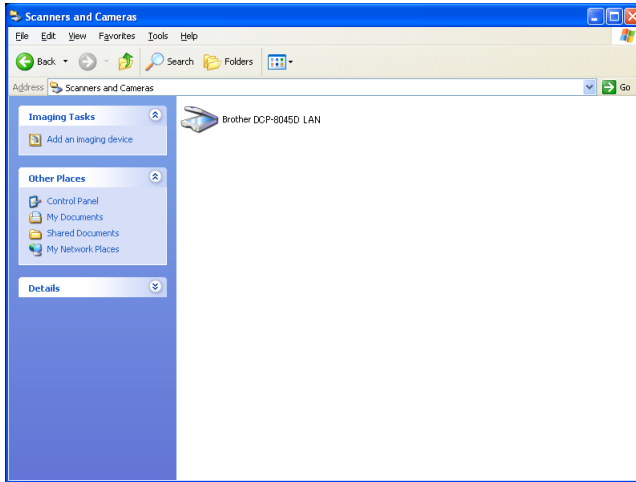

Right-click Scanner Device icon and select properties to view the Network Scanner Properties dialog box.

- 2 Click the **Network Setting** tab in the dialog box and select a method to specify the DCP as a Network scanner for your PC.

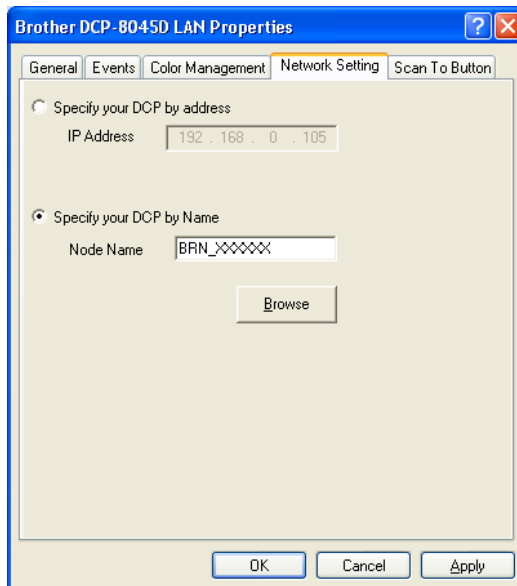

Specify your DCP by address

Enter the actual IP address of the DCP in the IP Address field.

Click **Apply** and then **OK**.

Specify your DCP by Name

Enter the DCP Node name in the Node Name field.

Click **Apply** and then **OK**.

Search from a list of available device

Click Browse and select the appropriate device you want to use.

Click **OK**.

Click **Apply** and then **OK**.

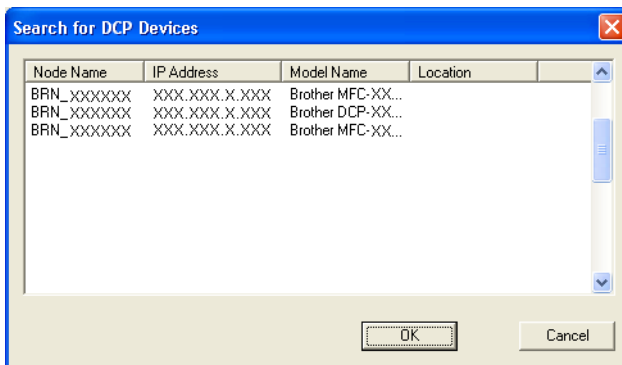

- 3 Click the **Scan To Button** tab in the dialog box and enter your PC Name in the Display Name field. The DCP's LCD displays the Name you enter. Default setting is your PC Name. You can enter a name if you like.

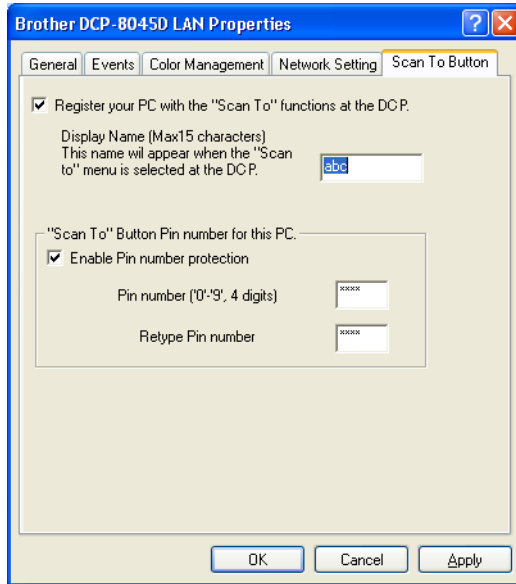

- 4 You can avoid receiving unwanted documents by setting a 4-digit PIN Number. Enter your PIN Number in the PIN Number and Retype PIN Number field. To send data to a PC protected by a PIN Number, the LCD prompts to enter the PIN Number before the document can be scanned and sent to the DCP. (See *Using the Scan key* on page 12-5 to 12-8.)

Using the Scan key

Scan to E-mail (PC)

When you select Scan to E-mail (PC) your original will be scanned and sent directly to the PC you designated on your network. The Brother SmartUI will activate the default E-mail application on the designated PC for addressing to the recipient. You can scan a black and white or color original and it will be sent with the E-mail from the PC as an attachment.





For Network Scanning the Brother Control Center (SmartUI) selections are used only for configuring the **Scan** button. You will not be able to initiate a Network scan from the Brother Control Center (SmartUI).



You can change the **Scan** configuration. For Windows® 98/98SE/Me/2000: (See *Scan to E-mail* on page 9-10 to 9-11.) (For Windows® XP: See *Hardware Section: Changing the Scan to button configuration* on page 10-5 to 10-9.)

1 Place the original face up in the ADF, or face down on the scanner glass.

2 Press **Scan**.

3 Press  or  to select Scan to E-mail.

Press **Set**.

4 Press  or  to select the destination PC you want to use for E-mailing your original.

Press **Set**.

If the LCD prompts you to enter a PIN Number, enter the 4-digit PIN Number for the destination PC on the control panel.

Press **Set**.

The DCP will start the scanning process.

▲Scan to E-mail
Scan to Image
Scan to OCR
▼Scan to File
Select ▲▼ & Set

Scan to Image

When you select Scan to Image your original will be scanned and sent directly to the PC you designated on your network. The Brother SmartUI will activate the default graphics application on the designated PC. You can change the **Scan** configuration. (For Windows® 98/Me/2000: See *Scan to Image* on page 9-14.) (For Windows® XP: See *Hardware Section: Changing the Scan to button configuration* on page 10-5 to 10-10.)



 For Network Scanning the Brother Control Center (SmartUI) selections are used only for configuring the **Scan** button. You will not be able to initiate a Network scan from the Brother Control Center (SmartUI).

1 Place the original face up in the ADF, or face down on the scanner glass.

2 Press **Scan**.

3 Press  or  to select Scan to Image.

Press **Set**.

4 Press  or  to select a destination you want to send.

Press **Set**.

If the LCD prompts you to enter a PIN Number, enter the 4-digit PIN Number for the destination PC on the control panel.

Press **Set**.

The DCP will start the scanning process.

▲Scan to E-mail
Scan to Image
Scan to OCR
▼Scan to File
Select ▲▼ & Set





Scan to OCR

When you select Scan to OCR your original will be scanned and sent directly to the PC you designated on your network. The Brother SmartUI will activate ScanSoft® OmniPage® and convert your original into text for viewing and editing from a word processing application on the designated PC. You can change the **Scan** configuration.

(For Windows® 98/Me/2000: See *Scan to OCR (Word Processor)* on page 9-12 to 9-13.) (For Windows® XP: See *Hardware Section: Changing the Scan to button configuration* on page 10-5 to 10-11.)



For Network Scanning the Brother Control Center (SmartUI) selections are used only for configuring the **Scan** button. You will not be able to initiate a Network scan from the Brother Control Center (SmartUI).

- 1 Place the original face up in the ADF, or face down on the scanner glass.
- 2 Press **Scan**.
- 3 Press  or  to select Scan to OCR.
Press **Set**.
- 4 Press  or  to select a destination you want to send.
Press **Set**.

▲Scan to E-mail
Scan to Image
Scan to OCR
▼Scan to File
Select ▲▼ & Set

If the LCD prompts you to enter a PIN Number, enter the 4-digit PIN Number for the destination PC on the control panel.

Press **Set**.

The DCP will start the scanning process.

Scan to File

When you select Scan to File you can scan a black and white or color original and send it directly to a PC you designate on your network. The file will be saved in the folder and file format that you have configured in the Brother SmartUI on the designated PC. You can change the **Scan** configuration.

(For Windows® 98/Me/2000: See *Scan to File* on page 9-8 to 9-9.)
(For Windows® XP: See *Hardware Section: Changing the Scan to button configuration* on page 10-5 to 10-11.)





For Network Scanning the Brother Control Center (SmartUI) selections are used only for configuring the **Scan** button. You will not be able to initiate a Network scan from the Brother Control Center (SmartUI).

1 Place the original face up in the ADF, or face down on the scanner glass.

2 Press **Scan**.

3 Press  or  to select Scan to File.

Press **Set**.

4 Press  or  to select a destination you want to send.

Press **Set**.

If the LCD prompts you to enter a PIN Number, enter the 4-digit PIN Number for the destination PC on the control panel.

Press **Set**.

The DCP will start the scanning process.



Max. 25 clients can be connected to one DCP on a Network. For example, if 30 clients are connect at a time, 5 clients will not be shown on the LCD.

▲Scan to E-mail
Scan to Image
Scan to OCR
▼Scan to File

13 Important information

Federal Communications Commission (FCC) Declaration of Conformity (USA only)

Responsible Party: Brother International Corporation
100 Somerset Corporate Boulevard
Bridgewater, NJ 08807-0911 USA
TEL: (908) 704-1700

declares, that the products

Product Name: DCP-8040, DCP-8045D

comply with Part 15 of the FCC Rules. Operation is subject to the following two conditions: (1) This device may not cause harmful interference, and (2) this device must accept any interference received, including interference that may cause undesired operation.

This equipment has been tested and found to comply with the limits for a Class B digital device, pursuant to Part 15 of the FCC Rules. These limits are designed to provide reasonable protection against harmful interference in a residential installation. This equipment generates, uses, and can radiate radio frequency energy and, if not installed and used in accordance with the instructions, may cause harmful interference to radio communications. However, there is no guarantee that interference will not occur in a particular installation. If this equipment does cause harmful interference to radio or television reception, which can be determined by turning the equipment off and on, the user is encouraged to try to correct the interference by one or more of the following measures:

- Reorient or relocate the receiving antenna.
- Increase the separation between the equipment and receiver.
- Connect the equipment into an outlet on a circuit different from that to which the receiver is connected.
- Call the dealer or an experienced radio/TV technician for help.

 WARNING

- This DCP has been certified to comply with FCC standards, which are applied to the USA only. A grounded plug should be plugged into a grounded AC outlet after checking the rating of the local power supply for the DCP to operate properly and safely.
- For protection against the risk of electrical shock, always disconnect all cables from the wall outlet before servicing, modifying or installing the equipment.

Important

Changes or modifications not expressly approved by Brother Industries, Ltd. could void the user's authority to operate the equipment.

 WARNING

Brother cannot accept any financial or other responsibilities that may be the result of your use of this information, including direct, special or consequential damages. There are no warranties extended or granted by this document.

Important – about the interface cable

A shielded interface cable should be used to ensure compliance with the limits for a Class B digital device.

Industry Canada Compliance Statement (Canada only)

This Class B digital apparatus complies with Canadian ICES-003.
Cet appareil numérique de la classe B est conforme à la norme
NMB-003 du Canada.

For your safety

To ensure safe operation the three-pin plug supplied must be inserted only into a standard three-pin power point which is effectively grounded through the standard wiring.

The fact that the equipment operates satisfactorily does not imply that the power is grounded and that the installation is completely safe. For your safety, if in any doubt about the effective grounding of the power, call a qualified electrician.

WARNING

This machine has a Class 3B Laser Diode which emits invisible laser radiation in the Scanner Unit. The Scanner Unit should not be opened under any circumstances.

International ENERGY STAR[®] Compliance Statement

The purpose of the International ENERGY STAR[®] Program is to promote the development and popularization of energy-efficient office equipment.

As an ENERGY STAR[®] Partner, Brother Industries, Ltd. has determined that this product meets the ENERGY STAR[®] guidelines for energy efficiency.



Laser safety

This equipment is certified as a Class I laser product under the U.S. Department of Health and Human Services (DHHS) Radiation Performance Standard according to the Radiation Control for Health and Safety Act of 1968. This means that the equipment does not produce hazardous laser radiation.

Since radiation emitted inside the equipment is completely confined within protective housings and external covers, the laser beam cannot escape from the DCP during any phase of user operation.

FDA regulations

U.S. Food and Drug Administration (FDA) has implemented regulations for laser products manufactured on and after August 2, 1976. Compliance is mandatory for products marketed in the United States. The following label on the back of the DCP indicates compliance with the FDA regulations and must be attached to laser products marketed in the United States.

Manufactured:

BROTHER CORP. (ASIA) LTD.

BROTHER BUJI NAN LING FACTORY

Gold Garden Industry, Nan Ling Village, Buji, Rong Gang,
Shenzhen, China.

This product complies with FDA radiation performance standards,
21 CFR Subchapter J.



WARNING

Use of controls, adjustments or performance of procedures other than those specified in this manual may result in hazardous invisible radiation exposure.

⚠ WARNING

Changes or modifications not expressly approved by Brother Industries, Ltd. may void the user's authority to operate the equipment.

Internal laser radiation

Max. Radiation Power 5 mW

Wave Length 760 - 810 nm

Laser Class Class IIIb (Accordance with 21 CFR
Part 1040.10)

Important safety instructions

- 1** Read all of these instructions.
- 2** Save them for later reference.
- 3** Follow all warnings and instructions marked on the product.
- 4** Before cleaning, turn off the DCP's power switch and unplug the power cord from the wall outlet. Do not use liquid or aerosol cleaners. Use a damp cloth for cleaning.
- 5** Do not use this product near water.
- 6** Do not place this product on an unstable cart, stand, or table. The product may fall, causing serious damage to the product.
- 7** Slots and openings in the cabinet and the back or bottom are provided for ventilation; to ensure reliable operation of the product and to protect it from overheating, these openings must not be blocked or covered. The openings should never be blocked by placing the product on a bed, sofa, rug, or other similar surface. This product should never be placed near or over a radiator or heater. This product should never be placed in a built-in installation unless proper ventilation is provided.
- 8** This product should be operated from the type of power source indicated on the label. If you are not sure of the type of power available, call your dealer or local power company.
Use only the power cord supplied with this DCP.
- 9** This product is equipped with a 3-wire grounded plug, a plug having a third (grounded) pin. This plug will only fit into a grounded power outlet. This is a safety feature. If you are unable to insert the plug into the outlet, call your electrician to replace your obsolete outlet. Do not defeat the purpose of the grounded plug.
- 10** Do not allow anything to rest on the power cord. Do not place this product where people can walk on the cord.
- 11** If an extension cord is used with this product, make sure that the total ampere ratings on the products plugged into the extension cord do not exceed the extension cord ampere rating. Also, make sure that the total of all products plugged into the wall outlet does not exceed 15 amperes (USA only).
- 12** Wait until pages have exited the DCP before picking them up.

13 Never push objects of any kind into this product through cabinet slots, since they may touch dangerous voltage points or short out parts resulting in the risk of fire or electric shock. Never spill liquid of any kind on the product. Do not attempt to service this product yourself because opening or removing covers may expose you to dangerous voltage points and other risks and may void your warranty. Refer all servicing to a Brother Authorized Service Center. For the location of your nearest Brother Authorized Service Center, please call:

In USA: 1-800-284-4357 or **In Canada:** 1-877-BROTHER.

(See *Brother numbers* on page i.)

14 Unplug this product from the wall outlet and refer servicing to a Brother Authorized Service Center under the following conditions:

- When the power cord is damaged or frayed.
- If liquid has been spilled into the product.
- If the product has been exposed to rain or water.
- If the product does not operate normally when the operating instructions are followed. Adjust only those controls that are covered by the operating instructions. Improper adjustment of other controls may result in damage and will often require extensive work by a qualified technician to restore the product to normal operation.
- If the product has been dropped or the cabinet has been damaged.
- If the product exhibits a distinct change in performance, indicating a need for service.

15 To protect your product against power surges, we recommend the use of a power protection device (Surge Protector).

16 To reduce the risk of fire, electric shock and injury to persons, note the following:

- Do not use this product near appliances that use water, a swimming pool or in a wet basement.
- Use only the power cord indicated in this manual.

Trademarks

The Brother logo is a registered trademark of Brother Industries, Ltd.

Brother is a registered trademark of Brother Industries, Ltd.

Multi-Function Link is a registered trademark of Brother International Corporation.

© Copyright 2003 Brother Industries, Ltd. All rights reserved.

Windows, Microsoft and Windows NT are registered trademarks of Microsoft in the U.S. and other countries.

Macintosh, QuickDraw, iMac and iBook are trademarks or registered trademarks of Apple Computer, Inc.

Postscript and Postscript Level 3 are registered trademarks or trademarks of Adobe Systems Incorporated.

PaperPort and OmniPage OCR are registered trademarks of ScanSoft, Inc.

Presto! PageManager is a registered trademark of NewSoft Technology Corporation.

Each company whose software title is mentioned in this manual has a Software License Agreement specific to its proprietary programs.

All other brand and product names mentioned in this User's Guide are registered trademarks of their respective companies.

14 Troubleshooting and routine maintenance

Troubleshooting

IMPORTANT

For technical help, you must call the country where you bought the DCP. Calls must be made **from within** that country.

Error messages

As with any sophisticated office product, errors may occur. If this happens, your DCP identifies the problem and displays an error message. The most common error messages are shown below.

You can correct most problems by yourself. If you need additional help, call the Brother fax back system (USA only).

In USA only: 1-800-521-2846

ERROR MESSAGES		
ERROR MESSAGE	CAUSE	ACTION
Change Drum Soon	The drum unit is near the end of its life.	Use the drum unit until you have a print quality problem; then replace the drum unit with a new one.
	The drum counter was not reset.	1. Open the front cover, and then press Clear/Back . 2. Press 1 to reset.
Check Original	The originals were not inserted or fed properly, or original scanned from ADF was longer than about 36 inches (90cm).	See <i>Original jams</i> on page 14-4.
Check Paper Check Paper #1 Check Paper #2	The DCP is out of paper or paper is not properly loaded in the paper tray.	Refill the paper in the paper tray or MP tray. —OR— Remove the paper and load it again.
Check Paper MP	Paper in the MP tray runs out.	Reload paper. (See <i>To load paper or other media in the multi-purpose tray (MP tray)</i> (For DCP-8045D) on page 2-9.)
Check Paper Size	When you see this error, the paper in the paper tray does not match the paper size you set in Menu, 1, 2 .	Load the appropriate size paper or change the default Paper Size setting.

ERROR MESSAGES		
ERROR MESSAGE	CAUSE	ACTION
Check Scan Lock	The scanner lock is locked.	Release the scanner lock lever, and then press Stop/Exit .
Cooling Down Wait for a while	The temperature of the drum unit or toner cartridge is too hot. The DCP will pause its current print job and go in to cooling down mode. During the cooling down mode, you will hear the cooling fan running while the display on the DCP shows <i>Cooling Down</i> , and <i>Wait for a while</i> .	You must wait 20 minutes for it to cool.
Cover Open Pls Close Cover	The front cover was not completely closed.	Close the front cover for the drum unit.
DX Lever Error	The paper adjustment lever for duplex printing is not correctly set for the paper size.	Set the duplex lever to the correct position. (See <i>To use Automatic Duplexing for copy and print operations (For DCP-8045D)</i> on page 2-11.)
Face Up Open	The face-up output tray is open.	Please close the face-up out tray.
Fuser Open	The fuser cover is open.	Please close the jam clear cover. (See <i>Paper jams</i> on page 14-5.)
Machine Error XX	DCP has a mechanical problem.	Call Brother Customer Service and tell them the Machine Error number. In USA: 1-800-284-4329 In Canada: 1-877-BROTHER
No DX Tray	You tried to make duplex printing with duplex cover open.	Install the duplex tray correctly. (See <i>Paper is jammed in the duplex tray (For DCP-8045D)</i> on page 14-9.)
Out of Memory	You can't store data in the memory.	(Copy operation in process) Press Stop/Exit and wait until the other operations in process finish and then try again. —OR— Add an optional memory. (See <i>Memory board</i> on page 15-1.) (Printing operation in process) Reduce print resolution. (See <i>Print Quality</i> on page 7-5.) —OR— Add an optional memory. (See <i>Memory board</i> on page 15-1.)

ERROR MESSAGES		
ERROR MESSAGE	CAUSE	ACTION
Pls Open Cover	A page, piece of paper or paper clip, etc. may be jammed inside the DCP.	Open the front cover. If you see any jammed paper or other item, gently pull it out, then close the front cover. If the error message remains, open and close the front cover again. If the DCP cannot reset itself and return to the copy setting prompt, it will display <i>Machine Error XX</i> . Please call Brother Customer Service and tell them the Machine Error number: In USA: 1-800-284-4329 In Canada: 1-877-BROTHER
Paper Jam	The paper is jammed in the DCP.	See <i>Paper jams</i> on page 14-5 and <i>Paper is jammed in the duplex tray (For DCP-8045D)</i> on page 14-9.
Toner Empty	Toner cartridge is not installed. —OR— Toner is used up and printing is not possible.	Reinstall the toner cartridge. —OR— Replace the toner cartridge with a new one. (See <i>Replacing the toner cartridge</i> on page 14-24.)
Toner Low	If the LCD shows <i>Toner Low</i> , you can still print. But the toner is depleted and the DCP is telling you that the toner will soon run out.	Order a new toner cartridge now.

Original jams

Based upon where the original is jammed, follow the appropriate set of instructions to remove it.

Original is jammed in the top of the ADF unit.

- 1 Take out any paper from the ADF that is not jammed.
- 2 Lift the ADF cover.
- 3 Pull the jammed original out to the right.
- 4 Close the ADF cover.
- 5 Press **Stop/Exit**.

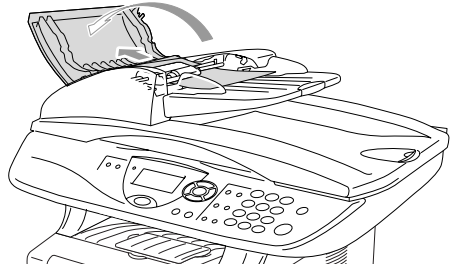

Original is jammed inside the ADF unit.

- 1 Take out any paper from the ADF that is not jammed.
- 2 Lift the document cover.
- 3 Pull the jammed original out to the right.
- 4 Close the document cover.
- 5 Press **Stop/Exit**.

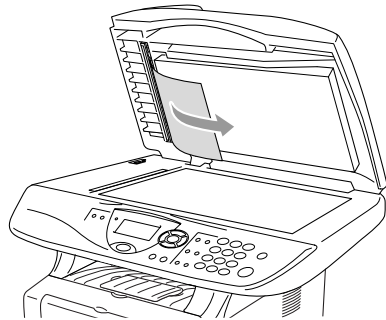

—OR—

- 1 Take the ADF support out of the ADF unit.
- 2 Pull the jammed original out to the right.
- 3 Press **Stop/Exit**.

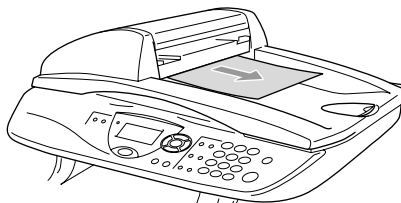

Paper jams

To clear paper jams, please follow the steps in this section.

WARNING

After you have just used the DCP, some parts inside the DCP are extremely hot. When you open the front cover or back output tray of the DCP, never touch the shaded parts shown in the following diagram.

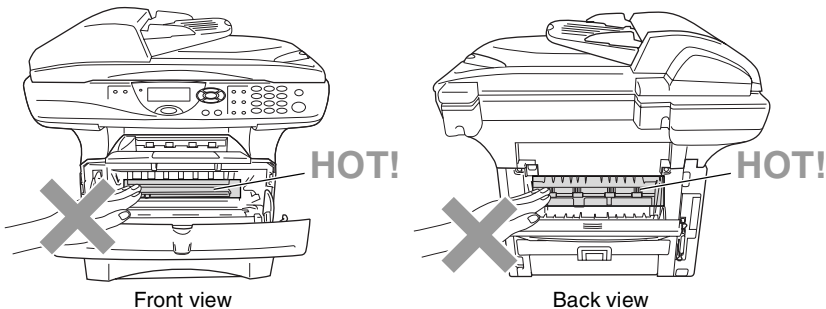

Clear the jammed paper as follows.

If the jammed paper is removed completely by using the information in the following steps, you can install the paper tray first, and then close the front cover and the DCP will resume printing automatically.



- If a paper jam occurs when using the optional lower tray unit, check for correct installation of the upper paper tray.
- Always remove all paper from the paper tray and straighten the stack when you add new paper. This helps prevent multiple sheets of paper from feeding through the DCP at one time and reduces paper jams.

- 1** Pull the paper tray completely out of the DCP.
- 2** Pull the jammed paper up and out of the DCP.

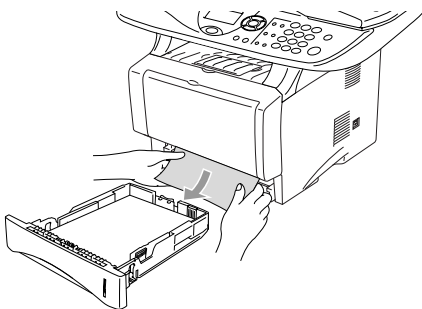

- 3** Press the cover release button and then open the front cover.
- 4** Pull out the drum unit assembly. Pull the jammed paper up and out of the DCP. If you cannot remove the drum unit assembly easily at this time, do not use extra force. Instead, pull the edge of the jammed paper from the paper tray.

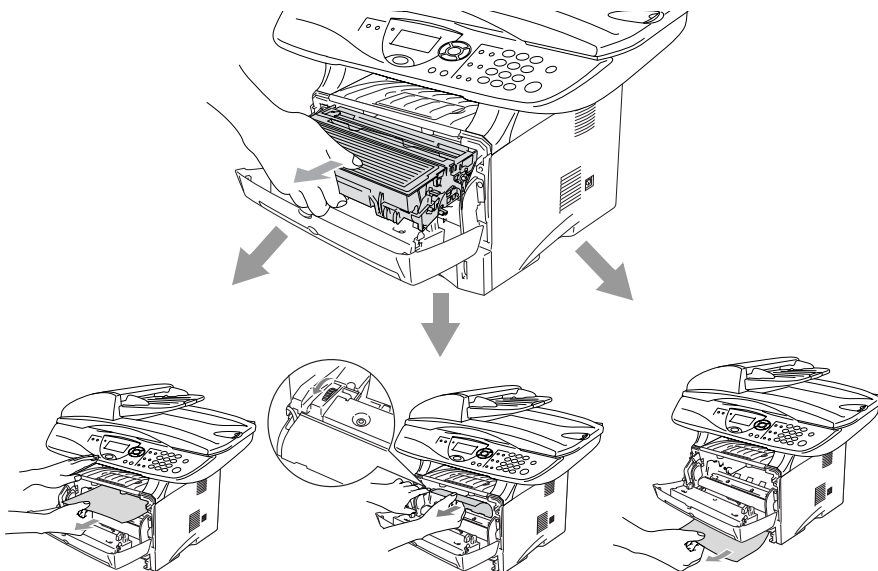

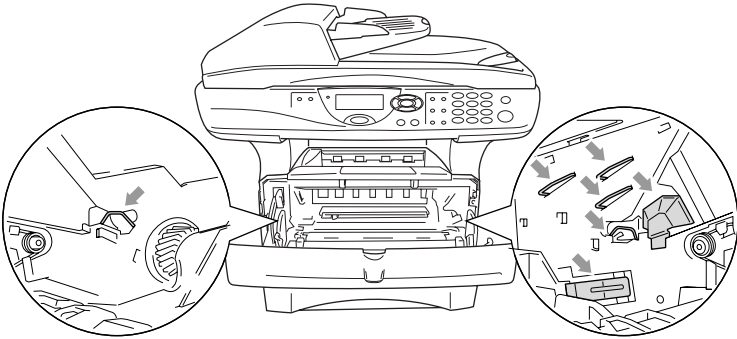

⚠ WARNING

To prevent damage to the DCP caused by static electricity, do not touch the electrodes shown in the following diagram.

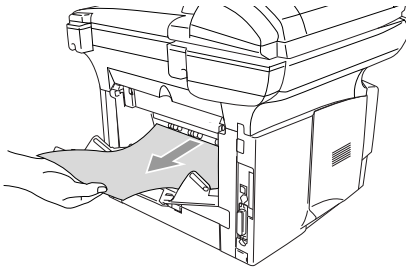

- 5 Open the back output tray. Pull the jammed paper out of the fuser unit. If the paper jam can be cleared, go to Step 7.



 If you have to pull the paper toward the back of the DCP, the fuser may get dirty with toner powder and it may scatter on the next printouts. Print a few copies of the test page until the scattering of toner stops.

⚠ WARNING

After you have just used the DCP, some internal parts of the DCP are extremely **HOT!** Wait for the DCP to cool down before you touch the internal parts of the DCP.

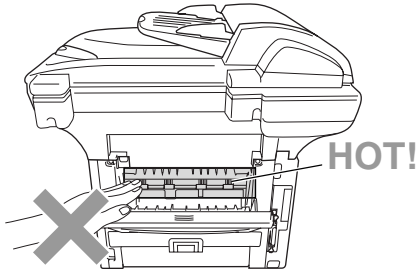

Back view

- 6 Open the jam clear cover (fuser cover). Pull the jammed paper out of the fuser unit.

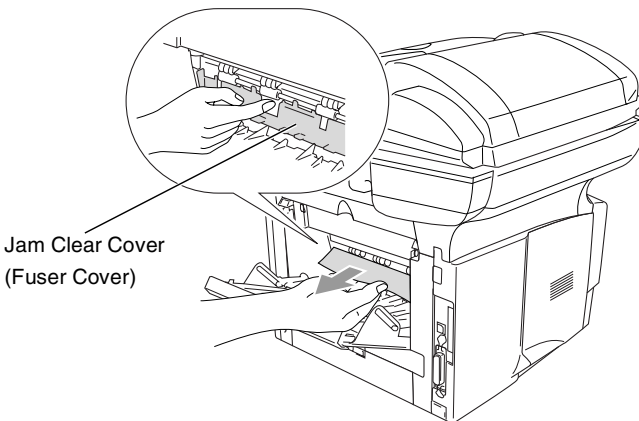

- 7 Close the jam clear cover. Close the back output tray.

- 8** Push the lock lever down and take the toner cartridge out of the drum unit. Take out the jammed paper if there is any inside the drum unit. Then put the toner cartridge back in the drum unit.

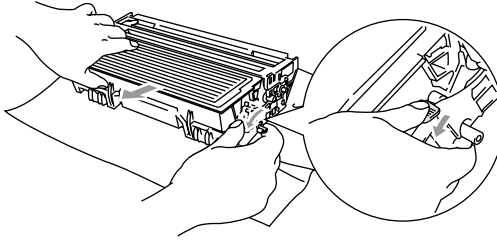

- 9** Put the drum unit assembly back in the DCP.
10 Put the paper tray in the DCP.
11 Close the front cover.

Paper is jammed in the duplex tray (For DCP-8045D)

- 1** Pull the duplex tray and paper tray out of the DCP.

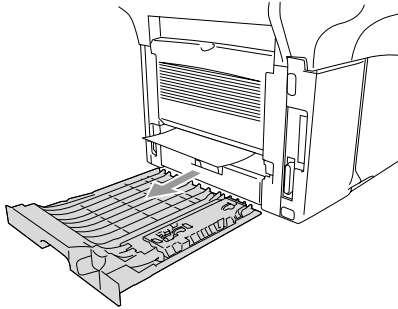

- 2** Pull the jammed paper out of the DCP.

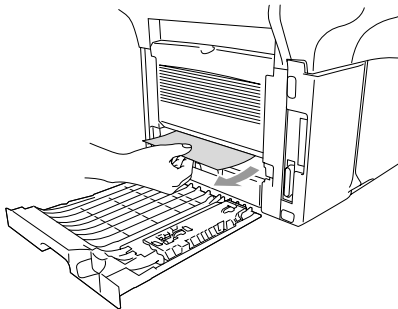

3 Put the duplex tray and paper tray back into the DCP.

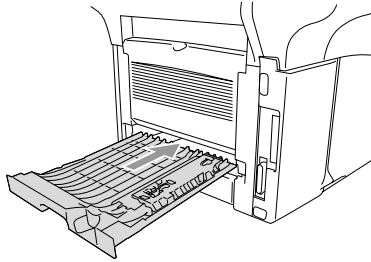

- The `Jam Duplex` message appears if you remove a sheet of paper from the Face Down Output Tray after only one side has printed.
- If the Paper Adjustment Lever for Duplex Printing is not set correctly for the paper size, paper jams may occur and the printing will be out of position on the page. (See *To use Automatic Duplexing for copy and print operations (For DCP-8045D)* on page 2-11.)

If you are having difficulty with your DCP

If the copy looks good, the problem is probably not your DCP. Check the chart below and follow the troubleshooting tips.





DIFFICULTY	SUGGESTIONS
Printing	
Condensed print and horizontal streaks or the top and bottom of sentences are cut off.	If the copy looks bad, clean the scanner area. If there is still problem, call Brother Customer Service at 1-800-284-4329 (in USA) or 1-877-BROTHER (in Canada) or your dealer for service.
Poor quality print.	See <i>Improving the print quality</i> on page 14-14.
Vertical black lines.	Your DCP's primary corona wire for printing may be dirty. Clean your primary corona wire (see <i>Cleaning the drum unit</i> on page 14-23). If the problem continues, call Brother Customer Service at 1-800-284-4329 (in USA) or 1-877-BROTHER (in Canada).
Copy Quality Difficulties	
Vertical streaks appear in copies.	Sometimes you may see vertical streaks on your copies. Either the scanner or the primary corona wire for printing is dirty. Clean them both. (See <i>Cleaning the scanner</i> on page 14-21 and <i>Cleaning the drum unit</i> on page 14-23.)
Printer Difficulties	
The DCP does not print.	Check the following: <ul style="list-style-type: none"> • The DCP is plugged in and the power switch is turned On. (See Quick Setup Guide on page 5.) • The toner cartridge and drum unit are installed properly. (See <i>Replacing the drum unit</i> on page 14-30.) • The interface cable is securely connected between the DCP and computer. (See Quick Setup Guide.) • Check to see if LCD is showing an error message. (See <i>Error messages</i> on page 14-1.)
The DCP prints unexpectedly or it prints garbage.	Reset the DCP or turn it off and then on again. Check the primary settings in your application software to make sure it is set up to work with your DCP.
The DCP prints first couple of pages correctly, then some pages have text missing.	Your computer is not recognizing the printer's input buffer full signal. Please make sure to connect the DCP cable correctly.
The DCP cannot print full pages of a document. <i>Out of Memory message occurs.</i>	Reduce the printing resolution. Reduce the complexity of your document and try again. Reduce the graphic quality or the number of font sizes within your application software.
My headers or footers appear when I view my document on the screen but do not appear when I print them.	Most laser printers have a restricted area that will not accept print. Usually these are the first two lines and last two lines, leaves 62 printable lines. Adjust the top and bottom margins in your document to allow for this.
Scanning Difficulties	
TWAIN errors appear while scanning.	Make sure the Brother TWAIN driver is selected as the primary source. In PaperPort®, click Scan in the File menu and select the Brother TWAIN driver.

DIFFICULTY	SUGGESTIONS
Software Difficulties	
Cannot install software or print.	Run the MFC-Pro Suite Repair and Install program on the CD-ROM. This program will repair and reinstall the software.
Cannot perform '2 in 1 or 4 in 1' printing.	Check that the paper size setting in the application and in the printer driver are the same.
Cannot print when using Adobe Illustrator.	Try to reduce the print resolution.
When using ATM fonts, some characters are missing or some characters are printed in their place.	If you are using Windows® 98/98SE/Me, select 'Printer Settings' from the 'Start' menu. Select the properties of the 'Brother DCP-8040 or DCP-8045D (USB) Printer'. Click 'Spool Setting' on the 'Details' tab. Select 'RAW' from 'Spool Data Format.'
"Unable to write to LPT1" or "LPT1 already in use" Error Message appears.	<ol style="list-style-type: none"> 1. Make sure the DCP is on (plugged into the AC power outlet) and turned the power switch on, and that it is connected directly to the computer using the bundled IEEE-1284 bi-directional parallel cable. The cable must not go through another peripheral device (such as a Zip Drive, External CD-ROM Drive, or Switch box). 2. Make sure the DCP is not displaying an error message on the LCD Display. 3. Make sure no other device drivers, which also communicate through the parallel port, are running automatically when you boot up the computer (such as, drivers for Zip Drives, External CD-ROM Drive, etc.) Suggested areas to check: (<i>Load=, Run=command lines in the win.ini file or the Statup Group</i>) 4. Check with you computer manufacturer to confirm that the computer's parallel port settings in the BIOS are set to support a bi-directional machine; i.e. (Parallel Port Mode – ECP)
"MFC is Busy" Error Message appears.	
"MFC Connect Failure"	If the DCP is not connected to your PC and you have loaded the Brother software, the PC will show 'MFC Connect Failure' each time you restart Windows®. You can ignore this message or you can turn it off as follows. Double-click "\tool\WarnOFF.REG" from the supplied CD-ROM. The Scan key on the DCP's control panel will not work unless you restart your PC with the DCP connected. To turn it back on, Double-click "\tool\WarnON.REG" from the supplied CD-ROM.
Paper Handling Difficulties	
The DCP does not load paper. The LCD shows Check Paper or Paper Jam.	Check to see if the <i>Check Paper</i> or <i>Paper Jam</i> message appears on the LCD. If it is empty, load a new stack of paper into the paper tray. If there is paper in the paper tray, make sure it is straight. If the paper is curled, you should straighten it. Sometimes it is helpful to remove the paper, turn the stack over and put it back into the paper tray. Reduce the amount of paper in the paper tray, and then try again. Check that the manual feed mode or MP tray or MP mode is not selected in the printer driver.
The DCP does not feed paper from the manual feed tray.	Reinsert the paper firmly, load one sheet at a time. Make sure that manual feed mode or MP mode is selected in the printer driver.
How can I load envelopes?	You can load envelopes from the manual feed or MP tray. Your application software must be set up to print the envelope size you are using. This is usually done in the Page Setup or Document Setup menu of your software. Refer to your software application manual.
What paper can I use?	You can use plain paper, envelopes, transparencies and labels that are made for laser machines. (For information on paper you can use, see <i>Printer operation keys</i> on page 6-16.)
How can I clear paper jams?	See <i>Paper jams</i> on page 14-5.

DIFFICULTY	SUGGESTIONS
Print Quality Difficulties	
Printed pages are curled.	Thin or thick paper below the standard can cause this problem. Make sure you select the Paper Type that suits the media type you use. (See <i>Setting the Paper Type</i> on page 4-1 and <i>Media Type</i> on page 7-4.)
Printed pages are smeared.	The Paper Type setting may be incorrect for the type of print media you are using— OR —The print media may be too thick or have a rough surface. (See <i>Setting the Paper Type</i> on page 4-1 and <i>Media Type</i> on page 7-4.)
Printouts are too light.	Set Toner Save mode to off in the Advance tab in the printer driver. (See <i>Toner Save Mode</i> on page 7-6.)
Network Difficulties	
I cannot print over the Network	Make sure that your DCP is powered on and is On Line and in Ready mode. Press the Test switch. Then the current settings of the NC-9100h are printed. Verify that the cabling and Network connections are good. If possible, try connecting the DCP to a different port on your hub using a different cable. Check to see if there is any LED activity. The NC-9100h has a two color LED for diagnosing problems.

Improving the print quality

This section provides information on the following topics:

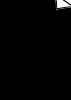
Examples of poor print quality	Recommendation
 <p>Faint</p>	<p>Check the printer's environment. Conditions such as humidity, high temperatures, and so on may cause this print fault. (See <i>Choosing a location</i> on page x.)</p> <p>If the whole page is too light, Toner Save mode may be on. Turn off Toner Save mode in the printer Properties tab of the driver.</p> <p>—OR—</p> <p>If your DCP is not connected to a computer, turn off Toner Save mode in the DCP itself. (See <i>Toner Save</i> on page 4-4.)</p> <p>Try installing a new toner cartridge. (See <i>Replacing the toner cartridge</i> on page 14-24.)</p> <p>Try installing a new drum unit. (See <i>Replacing the drum unit</i> on page 14-30.)</p>
 <p>Gray background</p>	<p>Make sure that you use paper that meets the recommended specifications. (See <i>About paper</i> on page 2-1.)</p> <p>Check the printer's environment - high temperatures and high humidity can increase the amount of background shading. (See <i>Choosing a location</i> on page x.)</p> <p>Use a new toner cartridge. (See <i>Replacing the toner cartridge</i> on page 14-24.)</p> <p>Use a new drum unit. (See <i>Replacing the drum unit</i> on page 14-30.)</p>
 <p>Ghost</p>	<p>Make sure you use paper that meets our specifications. Rough-surfaced paper or thick print media may cause this problem.</p> <p>Make sure that you choose the appropriate media type in the printer driver. (See <i>About paper</i> on page 2-1.)</p> <p>Try using a new drum unit. (See <i>Replacing the drum unit</i> on page 14-30.)</p>
 <p>Toner specks</p>	<p>Make sure that you use paper that meets our specifications. Rough-surfaced paper may cause the problem. (See <i>About paper</i> on page 2-1.)</p> <p>The drum unit may be damaged. Put in a new drum unit. (See <i>Replacing the drum unit</i> on page 14-30.)</p>
 <p>Hollow print</p>	<p>Make sure that you use paper that meets our specifications. (See <i>About paper</i> on page 2-1.)</p> <p>Choose Thick paper mode in the printer driver, or use thinner paper than you are currently using.</p> <p>Check the printer's environment because conditions such as high humidity can cause hollow print. (See <i>Choosing a location</i> on page x.)</p>
 <p>All black</p>	<p>You may clear the problem by cleaning the primary corona wire inside the drum unit by sliding the blue tab. Make sure you return the blue tab to the home position (▲). (See <i>Cleaning the drum unit</i> on page 14-23.)</p> <p>The drum unit may be damaged. Put in a new drum unit. (See <i>Replacing the drum unit</i> on page 14-30.)</p>

Examples of poor print quality

Recommendation

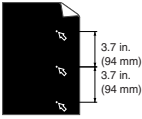

White Spots on black text and graphics at 3.7 in. (94 mm) intervals

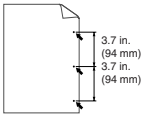

Black Spots at 3.7 in. (94 mm) intervals

If the problem is not solved after printing a few pages, the drum unit may have glue from label stock on the OPC drum surface.

Clean the drum unit as follows:

- 1 Position the print sample in front of the drum unit, and find the exact position of the poor print.

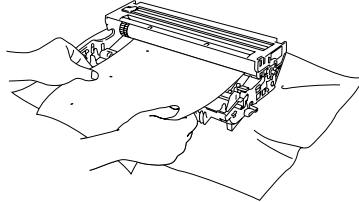

- 2 Turn the drum unit gear by hand while looking at the surface of the OPC drum.

! Caution

Do not touch the photosensitive drum with your fingers.

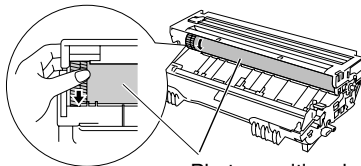



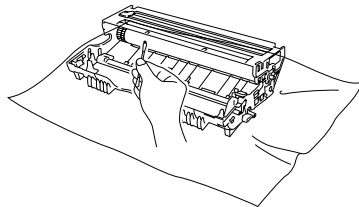

- 3 When you have located the mark on the drum that matches the print sample, wipe the surface of the OPC drum with a cotton swab until the dust or paper powder on the surface comes off.



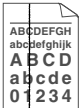

! Caution

Do not try to clean the surface of the photosensitive drum with a sharp object, such as a ball-point pen, and so on.

The drum unit may be damaged. Put in a new drum unit. (See *Replacing the drum unit* on page 14-30.)

Examples of poor print quality	Recommendation
 <p>Black toner marks across the page</p>	<p>The drum unit may be damaged. Put in a new drum unit. (See <i>Replacing the drum unit</i> on page 14-30.)</p> <p>Make sure that you use paper that meets our specifications. (See <i>About paper</i> on page 2-1.)</p> <p>If you use label sheets for laser printers, the glue from the sheets may sometimes stick to the OPC drum surface. Clean the drum unit. (See <i>Cleaning the drum unit</i> on page 14-23.)</p> <p>Do not use paper that has clips or staples because they will scratch the surface of the drum.</p> <p>If the unpacked drum unit is in direct sunlight or room light, the unit may be damaged.</p>
 <p>White lines across the page</p>	<p>Make sure that you use paper that meets our specifications. A rough surfaced paper or thick print media can cause the problem.</p> <p>Make sure that you select the appropriate media type in the printer driver.</p> <p>The problem may disappear by itself. Try printing multiple pages to clear this problem, especially if the printer has not been used for a long time.</p> <p>The drum unit may be damaged. Put in a new drum unit. (See <i>Replacing the drum unit</i> on page 14-30.)</p>
 <p>Lines across the page</p>	<p>Clean the inside of the printer and the primary corona wire in the drum unit. (See <i>Cleaning the drum unit</i> on page 14-23.)</p> <p>The drum unit may be damaged. Put in a new drum unit. (See <i>Replacing the drum unit</i> on page 14-30.)</p>
 <p>Black lines down the page Printed pages have toner stains down the page.</p>	<p>Clean the primary corona wire of the drum unit.</p> <p>Make sure the primary corona wire cleaner is at the home position (▲).</p> <p>The drum unit may be damaged. Install a new drum unit. (See <i>Replacing the drum unit</i> on page 14-30.)</p> <p>The toner cartridge may be damaged. Put in a new toner cartridge. (See <i>Replacing the toner cartridge</i> on page 14-24.) Make sure that a torn piece of paper is not inside the printer covering the scanner window.</p> <p>The fixing unit may be smudged. Call Customer Service.</p>
 <p>White lines down the page</p>	<p>You may clear the problem by wiping the scanner window with a soft cloth. (See <i>Cleaning the printer</i> on page 14-22.)</p> <p>The toner cartridge may be damaged. Put in a new toner cartridge. (See <i>Replacing the toner cartridge</i> on page 14-24.)</p>
 <p>Page skewed</p>	<p>Make sure the paper or other print media is loaded properly in the paper tray and that the guides are not too tight or too loose against the paper stack.</p> <p>Set the paper guides correctly.</p> <p>If you are using the manual feed tray (or the multi-purpose tray). (See <i>How to load paper</i> on page 2-5.)</p> <p>The paper tray may be too full.</p> <p>Check the paper type and quality. (See <i>About paper</i> on page 2-1.)</p>

Examples of poor print quality	Recommendation
 <p data-bbox="169 293 284 312">Curl or wave</p>	<p data-bbox="371 169 956 212">Check the paper type and quality. High temperatures and high humidity will cause paper to curl.</p> <p data-bbox="371 217 956 300">If you don't use the printer very often, the paper may have been in the paper tray too long. Turn over the stack of paper in the paper tray. Also, try fanning the paper stack and then rotating the paper 180° in the paper tray.</p> <p data-bbox="371 304 939 347">Try printing using the straight-through output path. (See <i>How to load paper</i> on page 2-5.)</p>
 <p data-bbox="138 485 315 504">Wrinkles or creases</p>	<p data-bbox="371 360 706 384">Make sure that paper is loaded properly.</p> <p data-bbox="371 389 919 413">Check the paper type and quality. (See <i>About paper</i> on page 2-1.)</p> <p data-bbox="371 418 939 461">Try printing using the straight-through output path. (See <i>How to load paper</i> on page 2-5.)</p> <p data-bbox="371 466 956 509">Turn over the stack of paper in the tray or try rotating the paper 180° in the input tray.</p>



The drum unit is a consumable item and it is necessary to replace it periodically.

Packing and shipping the DCP

Whenever you transport the DCP, use the packing materials that came with your machine. If you do not pack the DCP correctly, you may void your warranty.

- 1 Turn the DCP power switch off.
- 2 Unplug the DCP from the AC outlet.

Lock the Scanner Lock

- 3 Push the Scanner Lock Lever up to lock the scanner. This lever is located on the left of the scanner glass.

Scanner Lock Lever

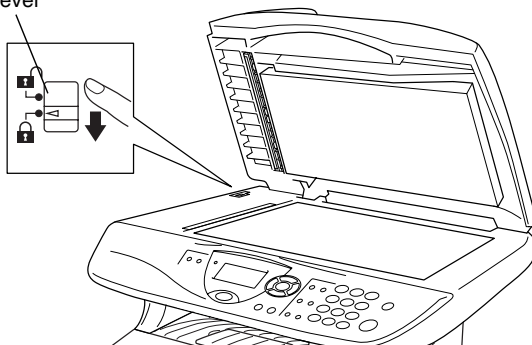

Caution

Damage caused to your DCP by failure to lock the scanner before moving and shipping may void your warranty.

- 4 Open the front cover.

- 5** Remove the drum unit and toner cartridge assembly. Leave the toner cartridge installed in the drum unit.

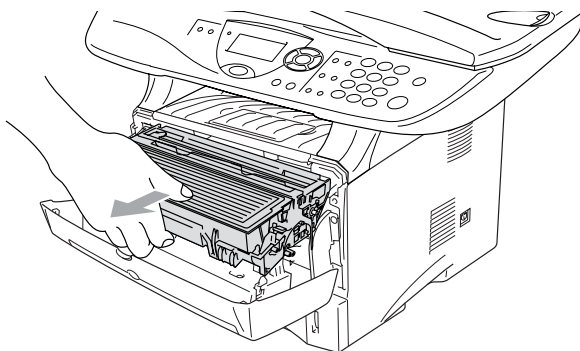

- 6** Place the drum unit and toner cartridge assembly into the plastic bag and seal the bag.

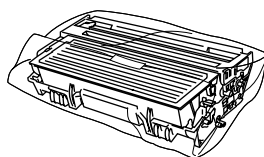

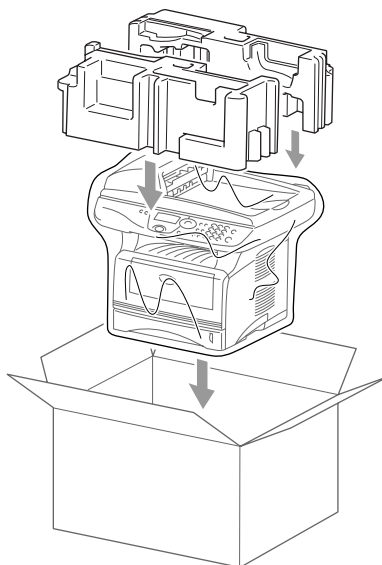
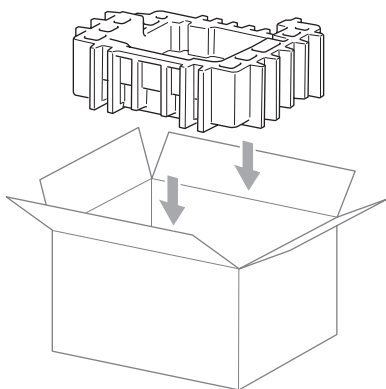

- 7** Close the front cover. Fold down the face-down output tray flap.

- 8** Wrap the DCP in the plastic bag and place it in the original carton with the original packing material.

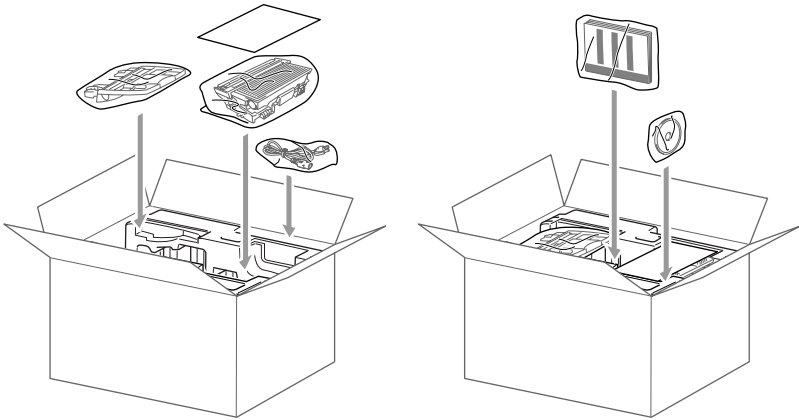

- 9** Pack the drum unit and toner cartridge assembly, AC cord and printed materials in the original carton as shown below:



-  If you are returning the DCP to Brother as part of the Exchange Service, pack *only* the DCP. Keep all separate parts to use with your 'Exchange' machine.

- 10** Close the carton and tape it shut.

Routine maintenance

Cleaning the scanner

Turn the DCP power switch off and lift the document cover. Clean the scanner glass and glass strip with dry cloth and the white film with isopropyl alcohol on a lint free cloth.

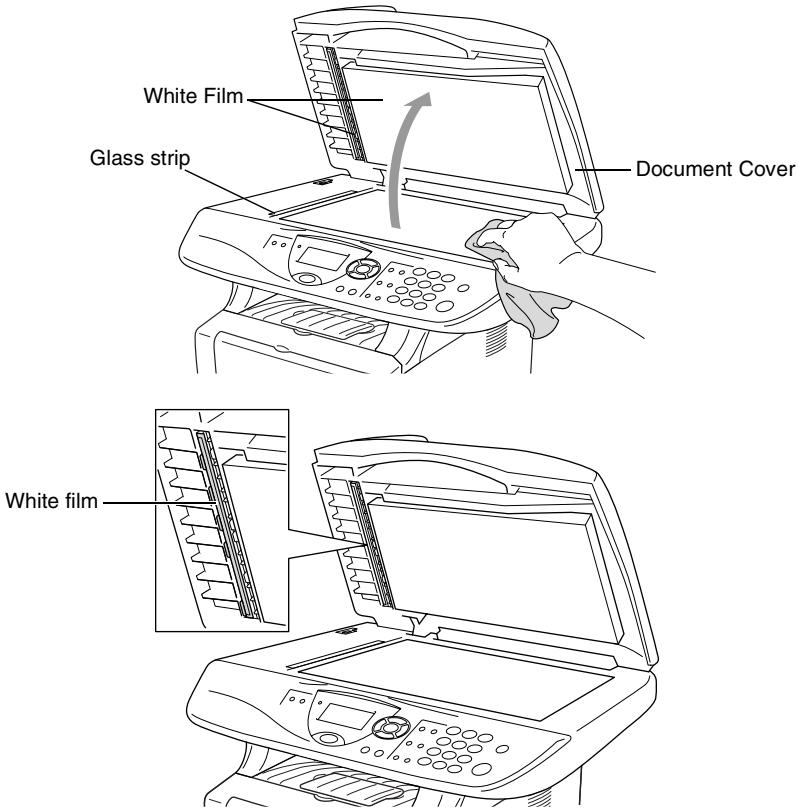

If the screen *still* displays a scanner error, call Brother Customer Service for assistance at 1-800-284-4329 (in USA) or 1-877-BROTHER (in Canada).

Cleaning the printer

! Caution

- Do *not* use isopropyl alcohol to remove dirt from the control panel. It may crack the panel.
 - Do *not* use isopropyl alcohol to clean the laser scanner window.
 - Do *not* touch the scanner window with your finger.
 - The drum unit contains toner, so handle it carefully. If toner scatters and your hands or clothes get dirty, immediately wipe or wash it off with cold water.
- 1 Turn the DCP power switch off and open the front cover.
 - 2 Remove the drum unit and toner cartridge assembly.

! WARNING

Just after you have used the DCP, some internal parts of the machine are extremely **HOT!** When you open the front cover of the DCP, never touch the shaded parts shown in the diagram below.

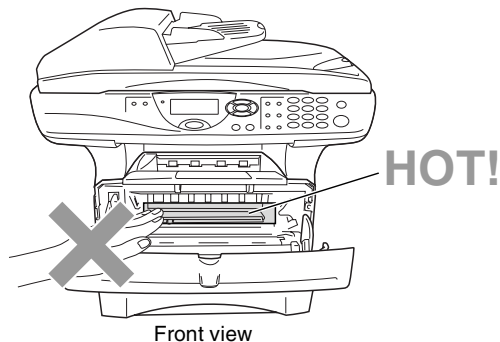

- 3 Gently clean the scanner window by wiping it with a clean soft dry cloth. Do *not* use isopropyl alcohol.

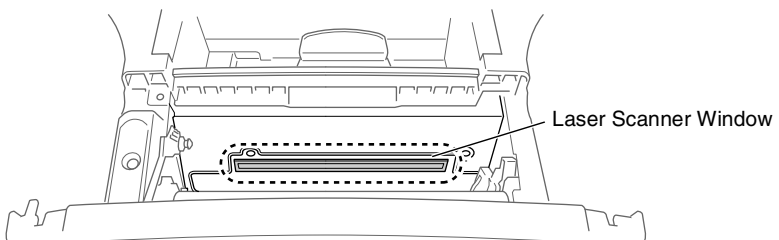

Cleaning the drum unit

We recommend placing the drum unit and toner cartridge assembly on a cloth or large disposable paper to avoid spilling and scattering toner.

- 1 Clean the primary corona wire inside the drum unit by gently sliding the blue tab from right to left several times.
- 2 Return the blue tab and snap it into the Home position (▼).

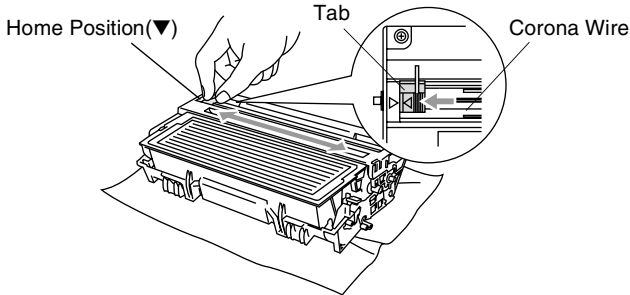

! Caution

If the blue tab is not at Home position (▼), printed pages may have vertical stripes.

- 3 Reinstall the drum unit and toner cartridge assembly into the DCP.
(See *Replacing the drum unit* on page 14-30.)
- 4 Close the front cover.
- 5 Plug in the power cord.

Replacing the toner cartridge

The DCP can print *up to* 6,700 pages using a *high yield* toner cartridge. When the toner cartridge is running low, the LCD shows `Toner Low`. The DCP is supplied with a *standard* toner cartridge that must be replaced after approximately 3,500 pages. Actual page count will vary depending on your average type of original (i.e., standard letter, detailed graphics).



It is a good idea to keep a new toner cartridge ready for use when you see the `Toner Low` warning.

Discard the used toner cartridge according to local regulations, keeping it separate from domestic waste. Be sure to seal the toner cartridge tightly so toner powder does not spill out of the cartridge. If you have questions, call your local waste disposal office.

We recommend that you clean the DCP when you replace the toner cartridge.

How to replace the toner cartridge

WARNING

Just after you use the DCP, some internal parts of the machine will be extremely **HOT!** So, never touch the shaded parts shown in the illustration.

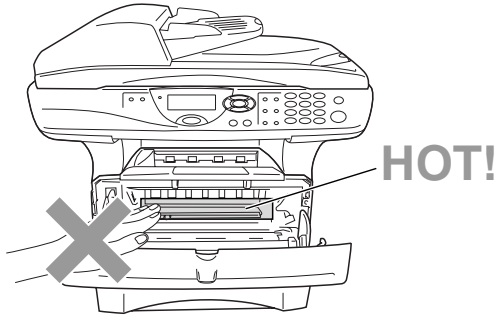

- 1 Open the front cover and pull out the drum unit.

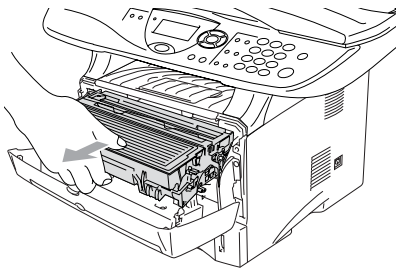
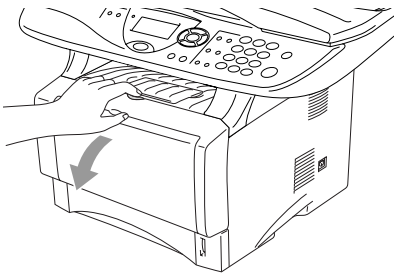

! Caution

- Place the drum unit on a drop cloth or large piece of disposable paper to avoid spilling and scattering the toner.
- To prevent damage to the DCP from static electricity, do not touch the electrodes shown below.

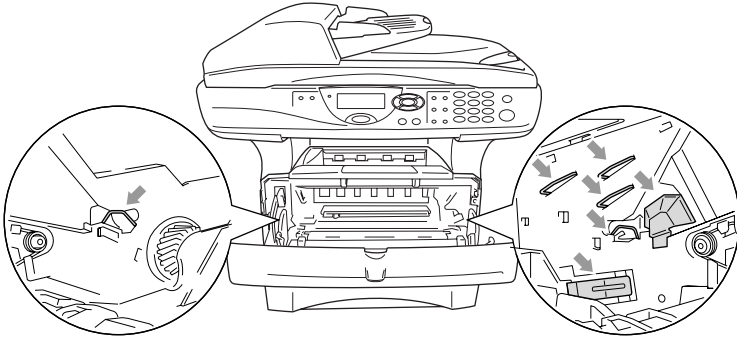

- 2** Hold down the lock lever on the right and pull the toner cartridge out of the drum unit.

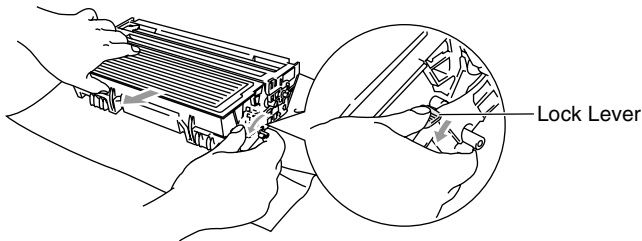

! Caution

Handle the toner cartridge carefully. If toner scatters on your hands or clothes, immediately wipe it off or wash it with cold water.

- 3 Unpack the new toner cartridge. Place the used toner cartridge into the aluminum bag and discard it according to local regulations.

 **Caution**

- Wait to unpack the toner cartridge until immediately before you install it in the DCP. If a toner cartridge is left unpacked for a long period of time, the toner life is shortened.
- Brother strongly recommends that you do not refill the toner cartridge provided with your DCP. We also strongly recommend that you continue to use only Genuine Brother Brand replacement toner cartridges. (TN-540 and TN-570). Using or attempting to use potentially incompatible toner and/or toner cartridges in your DCP may cause damage to the machine itself and/or it may result in unsatisfactory print quality. Our warranty coverage does not apply to any problem that was caused by the use of unauthorized third party toner and toner cartridges. To protect your investment and guarantee your print quality please continue to replace consumed toner cartridges with only Genuine Brother Branded Supplies.

- 4** Gently rock the toner cartridge from side to side five or six times to distribute the toner evenly inside the cartridge.

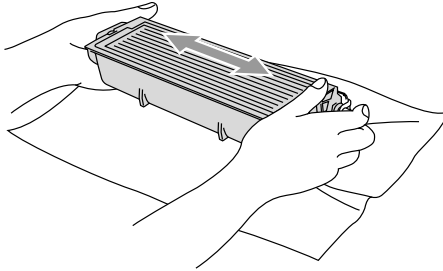

- 5** Remove the protective cover.

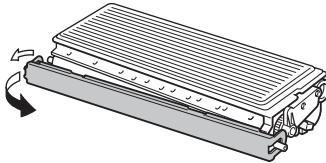

- 6** Insert the new toner cartridge in the drum unit until it clicks into place. If you put it in properly, the lock lever will lift automatically.

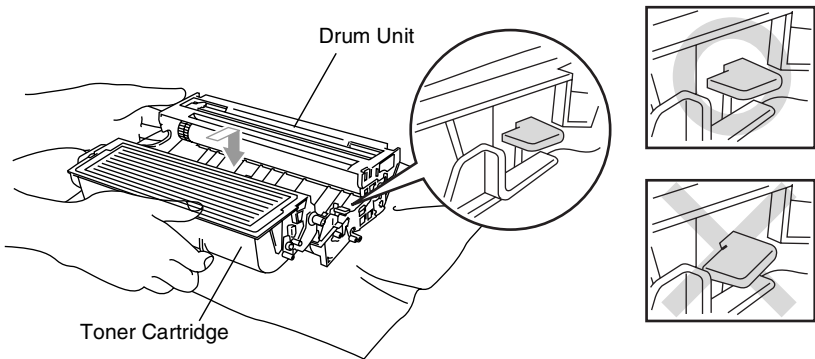

- 7** Clean the primary corona wire inside the drum unit by gently sliding the blue tab from right to left several times. Return the blue tab to the Home position (▼) before reinstalling the drum unit and toner cartridge assembly.

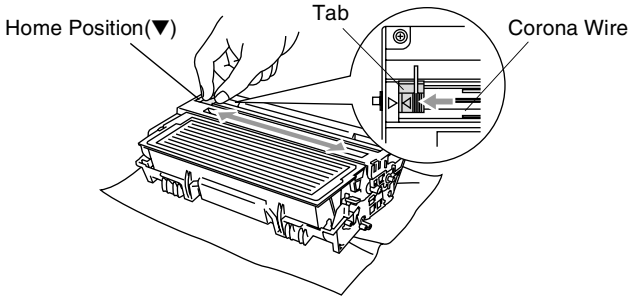

- 8** Reinstall the drum unit and toner cartridge assembly and close the front cover.

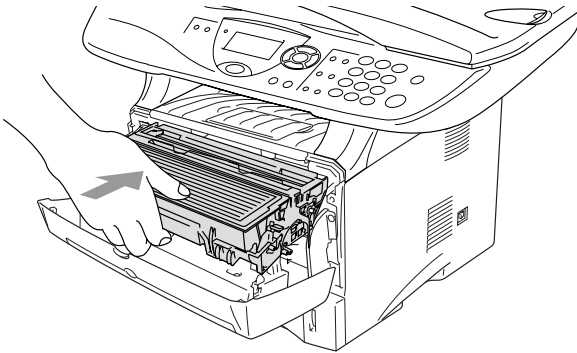

Replacing the drum unit

The DCP uses a drum unit to create print images on paper. If the LCD shows *Change Drum Soon*, the drum unit is near the end of its life and it is time to purchase a new one.

Even if the LCD shows *Change Drum Soon*, you may be able to continue printing without having to replace the drum unit for a while. However, if there is a noticeable deterioration in the output print quality (even before *Change Drum Soon* appears), then the drum unit should be replaced. You should clean the DCP when you replace the drum unit. (See *Cleaning the drum unit* on page 14-23.)

Caution

When removing the drum unit, handle it carefully because it contains toner. If toner scatters and your hands or clothes get dirty, immediately wipe or wash with cold water.



The drum unit is a consumable item, and it is necessary to replace it periodically. There are many factors that determine the actual drum life, such as temperature, humidity, type of paper and how much toner you use for the number of pages per print job. The estimated drum life is *up to* 20,000 pages. The actual number of pages your drum will print may be significantly less than these estimates. Because we have no control over the many factors that determine the actual drum life, we cannot guarantee a minimum number of pages that will be printed by your drum.

⚠ WARNING

Just after you have used the DCP, some internal parts of the DCP are extremely **HOT!** So please be careful.

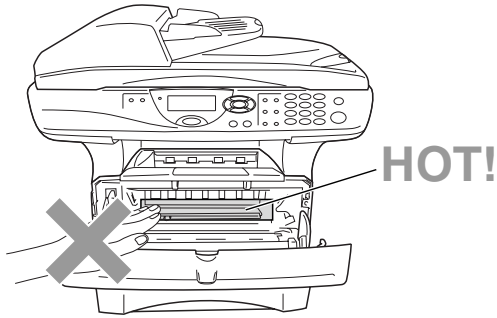

Follow these steps to replace the drum unit:

- 1** Press the cover release button and then open the front cover.
- 2** Remove the old drum unit and toner cartridge assembly. Place it on a drop cloth or disposable paper to avoid scattering toner.

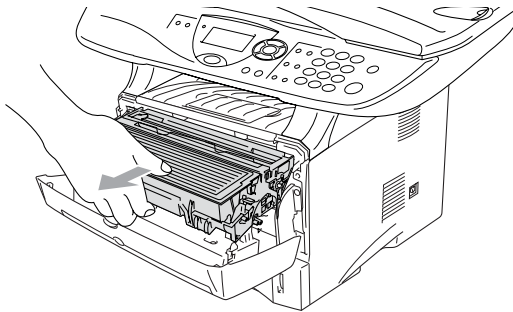

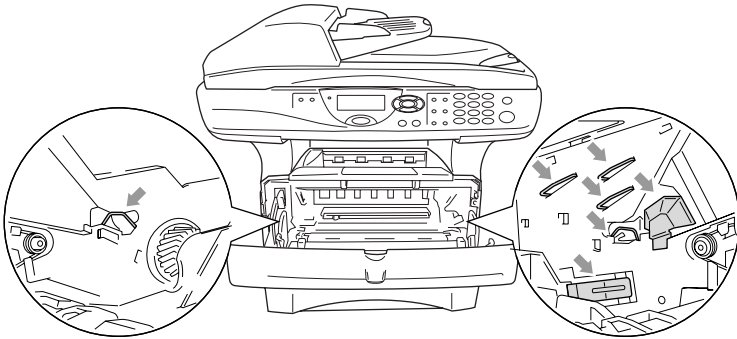

! Caution

To prevent damage to the printer from static electricity, do not touch the electrodes shown below.

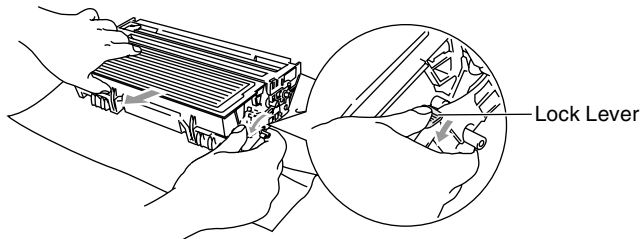

- 3** Hold down the lock lever on the right and pull the toner cartridge out of the drum unit. (See *Replacing the toner cartridge* on page 14-24.)



-  Discard the used drum unit according to local regulations, keeping it separate from domestic waste. Be sure to seal the drum unit tightly so toner powder does not spill out of the unit. If you have questions, call your local waste disposal office.

- 4 Wait to unpack the new drum unit until immediately before installing it. Place the old drum unit into the plastic bag and discard it according to local regulations.
- 5 Reinstall the toner cartridge into the new drum unit. (See *Replacing the toner cartridge* on page 14-24.)
- 6 Reinstall the new drum unit, keeping the front cover *open*.
- 7 Press **Clear/Back**.
- 8 Press **1** and when the LCD shows *Accepted*, and close the front cover.



! **Caution**

If toner scatters and your hands or clothes get dirty, immediately wipe off or wash with cold water.

Checking the drum life

You can see the percentage of the drum's life that remains available.

- 1 (DCP-8040)
Press **Menu, 1, 6.**

—OR—

If you have the optional tray #2,
press **Menu, 1, 7.**

(DCP-8045D)

Press **Menu, 1, 7.**

- 2 For five seconds, the LCD shows the available percentage of drum life.



Even if the remaining drum life is 0%, you may continue to use the drum unit until you have a print quality problem.

17.Drum Life
Remaining:100%

Page Counter

You can see number of total pages, copy pages, print pages and List (total list print) pages that your DCP has printed.

- 1 (DCP-8040)
Press **Menu, 1, 7.**

—OR—

If you have the optional tray #2,
press **Menu, 1, 8.**

(DCP-8045D)

Press **Menu, 1, 8.**

- 2 The LCD shows number of pages for **Total** and **Copy**.

Press  to see **Print** and **List**.

- 3 Press **Stop/Exit**.

18.Page Counter
▲ Total :123456
▼ Copy :120002

15 Optional accessories

Memory board

The memory board is installed on the main controller board inside the DCP. When you add the optional memory board, it increases the performance for both copier and printer operations.

Model Name	Optional Memory
DCP-8040 (32 MB Standard Memory)	32MB TECHWORKS 12457-0001
DCP-8045D (32 MB Standard Memory)	64MB TECHWORKS 12458-0001
	128MB TECHWORKS 12459-0001

In general, the DIMM must have the following specifications:

Type: 100 pin and 32 bit output

CAS Lantency: 2 or 3

Clock Frequency: 100MHz or more

Capacity: 32, 64, 128MB

Height: 35mm (1.4 inches) or less

Parity: NONE

DRAM Type: SDRAM 4 Bank

Some DIMMs might not work with this DCP. For the latest information from Brother visit:

<http://solutions.brother.com>

Installing the optional memory board

⚠ WARNING

- DO NOT touch the surface of the main board within 15 minutes after turning off the power.

1 Turn the DCP power switch off, unplug the DCP power cord from the AC outlet, and then disconnect the interface cable.

⚠ WARNING

Turn the DCP power switch off, before installing (or removing) the memory board.

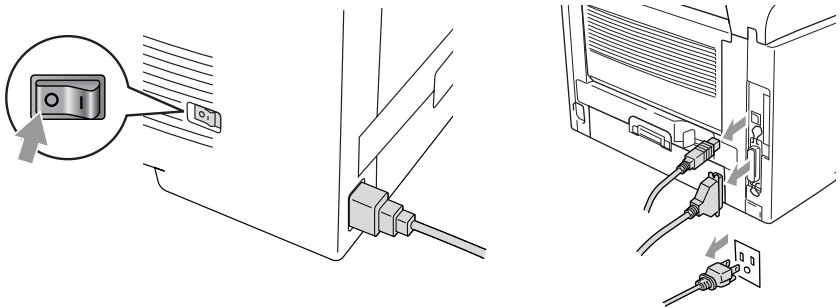

2 Remove the side cover. Loosen the two screws, and then remove the metal shield plate.

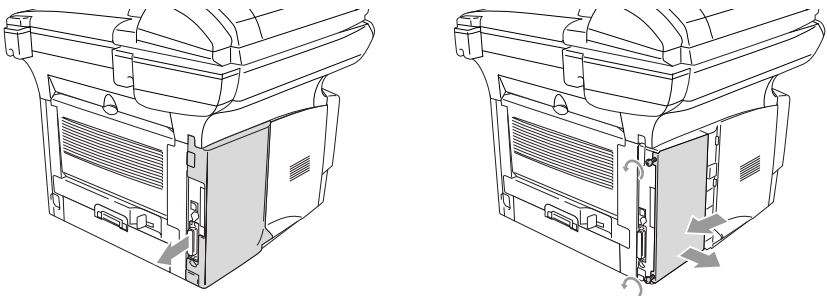

3 Unpack the DIMM and hold it by the edges.

⚠ WARNING

DIMM boards can be damaged by even a small amount of static electricity. Do not touch the memory chips or the board surface. Wear an antistatic wrist strap when you install or remove the board. If you do not have an antistatic wrist strap, frequently touch the bare metal on the printer.

- 4 Hold the DIMM with your fingers on the side edges and your thumb on the back edge. Line up the notches on the DIMM with the DIMM slot. (Check that the locks on each side of the DIMM slot are open or facing outwards.)

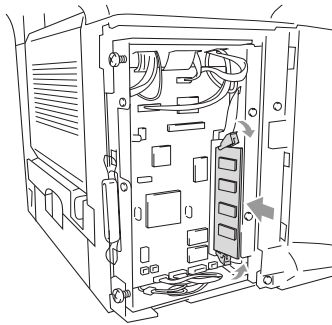

- 5 Press the DIMM straight into the slot (press firmly). Make sure the locks on each side of the DIMM click into place. (To remove a DIMM, you must release the locks.)
- 6 Put the metal plate back on and secure the metal plate with the two screws.
- 7 Put the side cover back on.

8 Reconnect any additional interface cables that you removed.

9 Reconnect the power cable and then turn on the DCP power switch.



■ To check that you have installed the DIMM correctly, print the printer settings by using the selection in the driver and check the printout to make sure it shows the additional memory.

■ You can check the current memory size to press **Menu, 1, 8** (DCP-8040) or **Menu, 1, 9** (DCP-8045D).



WARNING

If the Status LED turns Red for a Service Error, please call Brother Customer Service at: 1-800-284-4329 (in USA) or 1-877-BROTHER (in Canada).

Network (LAN) board

When you add the optional Network (LAN) Board (NC-9100h), you can connect your DCP into the network to use the Network Scanner, Network Printer and Network Management operations.

⚠ WARNING

DO NOT touch the surface of the main board within 15 minutes after turning off the power.

For more details about how to configure the Network board, please see the NC-9100h Network User's Guide on the CD-ROM supplied with the DCP.

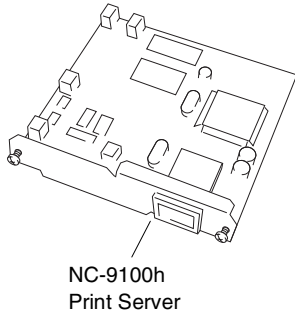

Before starting installation

Be careful when handling the NC-9100h. There are many delicate electronic components that are susceptible to damage from static electricity. To avoid such damage, use the following precautions when handling the board.

- Leave the NC-9100h in its anti-static bag until you are ready to install it.
- Make sure that you are adequately grounded before touching the NC-9100h. Use an anti-static wrist strap and a grounding mat if possible. If you do not have an anti-static wrist strap, touch the bare metal surface on the back of the machine before handling the NC-9100h.
- Avoid moving around the work area in order to eliminate static charge build-up.
- If possible, do not work on a carpeted area.
- Do not flex the board and do not touch the components on the card.

Tools Required:

Phillips Screwdriver 

Step 1: Hardware installation



WARNING

DO NOT touch the surface of the main boards within 15 minutes after turning off the power.

- 1 Turn the DCP power switch off, unplug the DCP power cord from the AC outlet, and then disconnect the interface cable.

⚠ WARNING

Turn the DCP power switch off, before installing (or removing) the NC-9100h board.

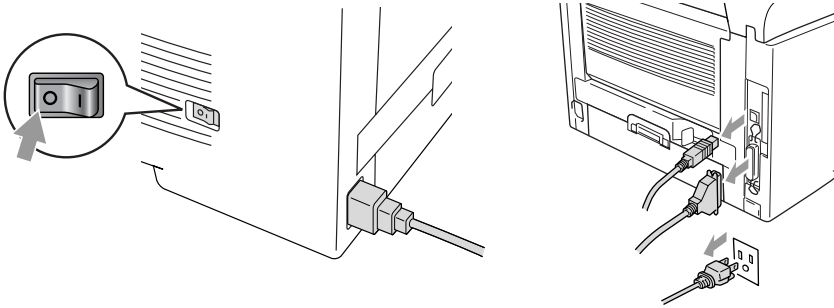

- 2** Remove the side cover. Loosen the two screws, and then remove the metal shield plate.

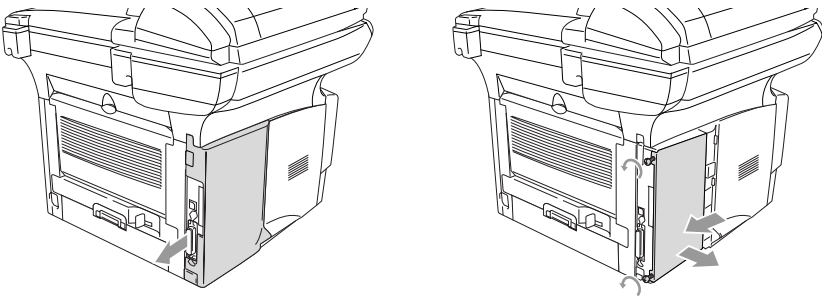

- 3** Loosen the two screws, and then remove the metal cover plate.

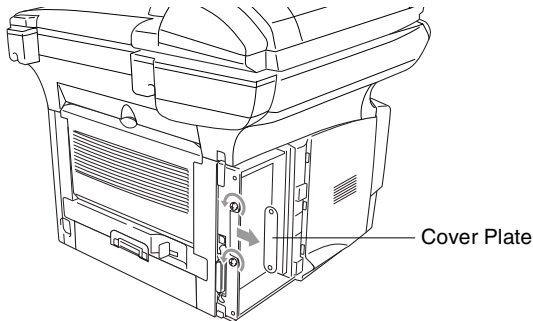

- 4 Plug the NC-9100h into connector P1 located on the main board as shown in the illustration (press firmly) and secure the NC-9100h with the two screws.

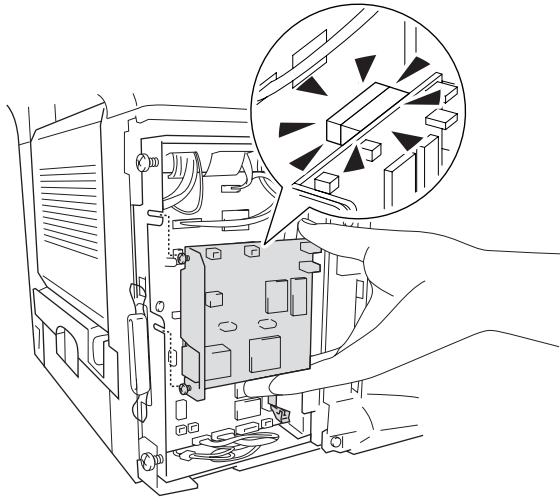

- 5 Put the metal shield plate back on and secure it with the two screws.
- 6 Put the side cover back on.
- 7 Reconnect any additional interface cables that you removed.
- 8 Reconnect the power cable and then turn on the DCP power switch.
- 9 Press the Test switch and print a network configuration page. (See *TEST SWITCH* on page 15-10.)

Step 2: Connecting the NC-9100h to an Unshielded Twisted Pair 10BASE-T or 100BASE-TX Ethernet Network

To connect the NC-9100h to a 10BASE-T or 100BASE-TX Network, you must have an Unshielded Twist Pair Cable. One side of the cable must be connected to a free port on your Ethernet hub and the other side must be connected to the 10BASE-T or 100BASE-TX connector (an RJ45 Connector) of the NC-9100h.

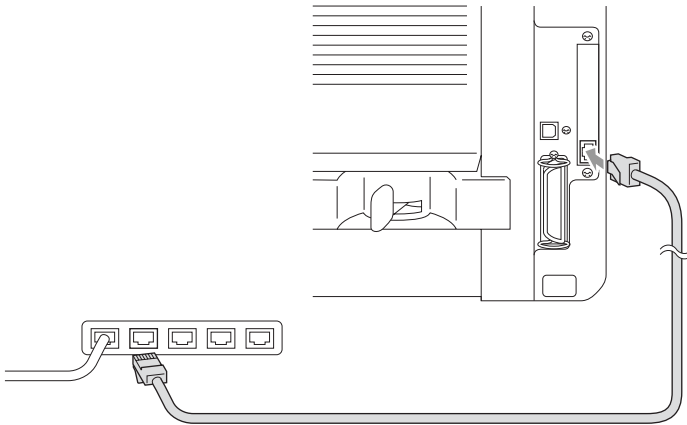

Verifying successful hardware Installation:

Plug in the AC power cord. After initialization and warm-up (this may take several seconds), the DCP will come to a Ready state.

LED

No light:

If both of the two LEDs are off, then the print server is not connected to the network.

Link/Speed LED is orange: Fast Ethernet

This Link/Speed LED will be orange if the print server is connected to a 100BASETX Fast Ethernet network.

Link/Speed LED is green: 10 BASE T Ethernet

This Link/Speed LED will be green if the print server is connected to a 10 BASE T Ethernet.

Active LED is yellow:

The Active LED will blink if the print server is receiving or transmitting data.



If there is a valid connection to the network, the LED will blink orange or green.

TEST SWITCH

Short push: Prints the network configuration page.

Long push (more than 5 seconds): Reset the network configuration back to the default settings.

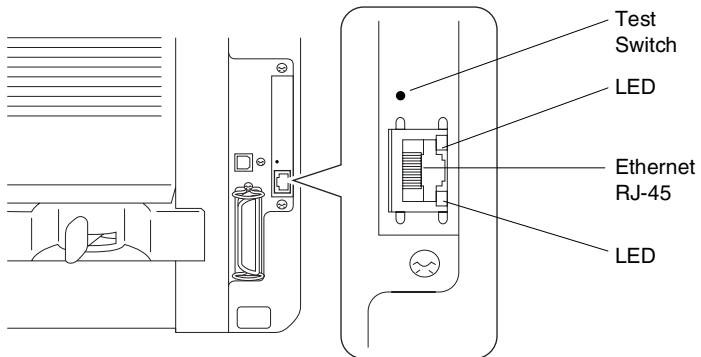

To set up the DCP on the Network, see the *NC-9100h Network User's Guide* on the CD-ROM.

Paper Tray #2

You can purchase the Paper Tray #2 accessory (LT-5000) to use as a third paper source. Tray #2 holds up to 250 sheets of 20 lb (80 g/m²) paper.

Paper Tray #2:	Holds approx. 250 sheets of 20 lb (80 g/m ²) Letter/A4 paper
Basis Weight:	16 to 28 lb (60 to 105 g/m ²)
Moisture Content:	4% to 6% by weight
We Recommend:	Xerox 4200DP 20 lb
Cut sheet:	Hammermill Laser Paper 24 lb

G Glossary

ADF (Automatic Document Feeder) The original can be placed in the ADF and scanned one page at a time automatically.

Beeper Volume Volume setting for the beep when you press a key or make an error.

Contrast Setting to compensate for dark or light originals, by making copies of dark originals lighter and light originals darker.

Drum Unit A printing device for the DCP.

Gray scale The shades of gray available for copying photographs.

LCD (liquid crystal display) The display screen on the DCP that shows interactive messages during On-Screen Programming.

Menu mode Programming mode for changing your DCP's settings.

MFL-Pro Suite Turns your DCP into a printer and a scanner using the DCP.

OCR (optical character recognition) The bundled ScanSoft® OmniPage® software application converts an image of text to text you can edit.

Photo mode A resolution setting that uses varying shades of gray for the best representation of photographs.

Scanning The process of sending an electronic image of a paper document into your computer.

Toner cartridge An accessory that holds toner for the drum unit on Brother laser models.

Toner Save A process that causes less toner to be affixed to the page to extend the life of the toner assembly. This will make the printing document significantly lighter.

True Type fonts The fonts that are used in the Windows® operating systems. If you install the Brother True Type fonts, more types of fonts will be available for Windows® applications.

User Settings A printed report that shows the current settings of your DCP.

S Specifications

Product description

The DCP-8040 and DCP-8045D are **3 in 1** Multi-Function Centers: Printer, Copier and Color Scanner. The DCP-8045D includes Duplex Printing.

General

Memory Capacity	32 MB
Optional Memory	1 DIMM slot; Memory expandable up to 160 MB
Automatic Document Feeder (ADF)	Up to 50 pages Temperature: 68°F - 86°F (20°C - 30°C) Humidity: 50% - 70% Paper: 20 lb or 75 g/m ² Letter size
Paper Tray	250 Sheets (20 lb/80 g/m ²)
Manual Feed Tray	Single sheet (20 lb/80 g/m ²) (DCP-8040 only)
Multi-Purpose Tray	Up to 50 Sheets (20 lb/80 g/m ²) (DCP-8045D only)
Printer Type	Laser
Print Method	Electrophotography by semiconductor laser beam scanning
LCD (Liquid Crystal Display)	22 characters × 5 lines
Warm-up	Max. 18 seconds at 73.4°F (23°C)
Power Source	120V AC 50/60Hz (USA, Canadian Version Only)
Power Consumption	Average Operating (Copying): 450W or less (25°C) Peak: 1090W or less Sleep: 14W or less 16W or less (When Network LAN board (NC-9100h) is installed.) Standby: 85W or less (25°C)
Dimensions	21.28 x 17.76 x 18.76 (in.) 532 × 444 × 469 (mm)

General (continued)

Weight	Without Drum/Toner Unit: DCP-8040: 36.6 lb/16.6 kg DCP-8045D: 39.9 lb/18.1 kg
Noise	Operating: 53 dB A or less Standby: 30 dB A or less
Temperature	Operating: 50 - 90.5°F (10 - 32.5°C) Storage: 32 - 104°F (0 - 40°C)
Humidity	Operating: 20 to 80% (without condensation) Storage: 10 to 90% (without condensation)

Print media

Paper Input

Paper Tray

- Paper type:
Plain paper, recycled paper and transparencies, envelopes (Manual Feed/Multi-purpose Tray)
- Paper size:
A4, Letter, Legal, B5 (ISO), B5 (JIS), Executive, A5, A6, B6 (ISO)
Weight: 16 - 28 lb (60 - 105 g/m²) (Paper Tray)
For more details, see *Paper specifications for each paper tray* on page 2-4.
- Maximum paper tray capacity: Approx. 250 sheets of 20 lb (80 g/m²) plain paper
- Maximum multi-purpose tray capacity: Approx. 50 sheets of 20 lb (80 g/m²) plain paper (DCP-8045D only)

Manual Feed Tray/Multi-Purpose Tray

- Paper size:
Width: 2.75 - 8.66" (69.8 - 220.0 mm)
Height: 4.60 - 16.00" (116.0 - 406.4 mm)
Weight: 16 - 43 lb (60 - 161 g/m²)

Paper Output

Up to 150 sheets of plain paper (Face down print delivery to the output paper support)

Copy

Color/Monochrome	Monochrome
Copy Speed	Up to 21 copies/minute (Letter paper) Up to 20 copies/minute (A4 paper)
Multiple Copies	Stacks or Sorts up to 99 pages
Enlarge/Reduce	25% to 400% (in increments of 1%)
Resolution	Max. 1200 x 600 dpi

Scanner

Color/Monochrome	Color/Monochrome
TWAIN Compliant	Yes (Windows® 98/98SE/Me/2000 Professional and Windows NT® Workstation Version 4.0) Mac OS® 8.6-9.2/Mac OS® X 10.2.1 or greater
WIA Compliant	Yes (Windows® XP)
Resolution	Up to 9,600 × 9,600 dpi (interpolated)* Up to 600 × 2,400 dpi (optical) * Maximum 1200 x 1200 dpi scanning with Windows® XP (resolution up to 9600 x 9600 dpi can be selected by using the Brother scanner utility)
Document Size	ADF Width: 5.8" to 8.5" (148 mm to 216 mm) ADF Height: 5.8" to 14.0" (148 mm to 356 mm) Scanner Glass Width: Max. 8.5" (216 mm) Scanner Glass Height: Max. 14.0" (356 mm)
Scanning Width	8.35 inches (212 mm)
Gray Scale	256 levels



- Scanning directly to a networked PC is available with Windows® 98/98SE/Me/2000 Professional and XP.
- Mac OS® X scanning is supported in Mac OS® X 10.2.1 or greater.

Printer

Emulation	PCL6 (Brother Printing System for Windows® emulation mode of HP LaserJet) and BR-Script (PostScript®) Level 3
Printer Driver	Windows® 98/98SE/Me/2000 Professional/XP and Windows NT® Workstation Version 4.0 driver supporting Brother Native Compression mode and bi-directional capability Apple® Macintosh® QuickDraw® Driver and PostScript (PPD) for Mac OS® 8.6-9.2/Mac OS® X 10.1/10.2.1 or greater
Resolution	HQ1200 (Max. 2400 × 600 dots/inch)
Print Quality	Normal printing mode Economy printing mode (saves toner usage)
Print Speed	Up to 21 copies/minute (Letter paper) Up to 20 copies/minute (A4 paper) (when loading paper from paper tray)
Duplex Printing	Up to 8.5 pages/minute: (DCP-8045D only) (8.5 sides per minute, 4.25 sheets per minute)
First Print	Up to 12 seconds (using letter size paper in paper tray)

Interfaces

Interface	Recommended Cable
Parallel	A bi-directional shielded parallel cable that is IEEE 1284 compliant and not longer than 6 feet (2 m).
USB	A Hi-Speed USB 2.0 cable that is not longer than 6 feet (2 m).



- Please make sure that you use a Hi-Speed USB 2.0 certified cable if your computer uses a Hi-Speed USB 2.0 interface.
- Even if your computer has a USB 1.1 interface you can connect the DCP.

Computer requirements

Minimum System Requirements						
Computer Platform & Operating System Version		Processor Minimum Speed	Minimum RAM	Recommended RAM	Available Hard Disk Space	
					Driver	Application Software ^{*1}
Windows® Operating System	98, 98SE	Pentium 75MHz	24 MB	32 MB	80 MB	100 MB
	Me	Pentium 150 MHz	32 MB	64 MB		
	NT® Workstation 4.0	Pentium 75MHz	64 MB	128 MB		
	2000 Professional	Pentium 133MHz				
	XP	Pentium 233MHz	128 MB	256 MB	180 MB	
Apple® Macintosh® Operating System	Mac OS® 8.6 - 9.2 (Printing and Scanning Only)	All base models meet minimum Requirements	32 MB	64 MB	50 MB	200 MB
	Mac OS® X 10.1/10.2.1 or greater (Printing and Scanning ^{*2} Only)		128 MB	160 MB		
NOTE: USB is not supported under Windows NT® WS 4.0. All registered trademarks referenced herein are the property of their respective companies.						
For the latest drivers, access the Brother Solutions Center at http://solutions.brother.com/						



*1 Application Software is different for Windows® and Macintosh®

*2 Scanning is supported in 10.2.1 or greater.

Consumable items

Toner Cartridge Life Expectancy

TN-540:
Standard Toner Cartridge - Up to 3,500*
pages

TN-570:
High Yield Toner Cartridge - Up to 6,700* pages
*(when printing letter size or A4 paper at 5% print
coverage)



Toner life expectancy will vary depending upon the
type of average print job.

Drum Unit Life Expectancy

DR-510:
Up to 20,000 pages/drum unit



There are many factors that determine the actual
drum life, such as temperature, humidity, type of
paper, toner you use and number of pages per print
job.

Network (LAN) board (NC-9100h)

DCP-8040 (Option)

DCP-8045D (Option)

When you add the optional Network (LAN) Board (NC-9100h), you can connect your DCP into the network to use the Network Scanner, Network Printer and Network Management software operations for small workgroups.

Support for:

Windows® 98/Me/NT® 4.0/2000/XP
Novell NetWare 3.X, 4.X, 5.X
Mac OS® 8.6 - 9.2, X 10.0-10.2.1 or greater
Ethernet 10/100 BASE-TX Auto Negotiation
TCP/IP, IPX/SPX, AppleTalk, DLC/LLC, NetBIOS
RARP, BOOTP, DHCP, APIPA, WINS
LPR/LPD, Port9100, SMTP/POP3
SMB(NetBIOS/ IP), IPP, SSDP
Apple Rendezvous™, FTP
SNMP, MIBII as well as Brother private MIB
TELNET, HTTP, TFTP

Included Utilities:

BRAdmin Professional and Web Based Management



- Scanning directly to a networked PC is not supported in Windows NT® and Mac OS®.
- BRAdmin Professional is not supported in Mac OS®.

Optional External Wireless Print/Scan Server (NC-2200w)

NC-2200w External Wireless Print/Scan Server (Optional)

Network types

Support for

Protocols

Connecting the optional External Wireless Print/Scan Server (NC-2200w) to your MFC will allow you to print and scan over a wireless network.

IEEE802.11b wireless LAN

Windows® 98/98SE/Me/2000/XP and Windows NT®
Mac OS® X 10.2.4 or greater
(Apple Rendezvous™)*

TCP/IP

ARP, RARP, BOOTP, DHCP, APIPA (Auto IP),
WINS/NetBIOS, DNS, LPR/LPD, Port9100,
SMB Print, IPP, RawPort, Apple Rendezvous™,
TELNET, SNMP, HTTP

* Network Scanning are not available for Mac.



You can assign the scan key to one networked computer only.

Index

A

- Accessories and supplies ii
- ADF (automatic document feeder), using 1-10
- ADF cover 14-4

B

- Brother
 - accessories and supplies ii
 - Brother numbers i
 - Customer Service i
 - fax back system ii
 - frequently asked questions (FAQs) i
 - product support i
 - warranties iii, iv, vii
- Brother Control Center
 - using and configuring 9-1

C

- cleaning (routine maintenance)
 - drum unit 14-23
 - printer 14-22
 - scanner 14-21
- computer requirements S-5
- control panel, overview 1-6
- copy
 - contrast 5-17
 - default settings, changing 5-17
 - Duplex/N in 1 5-11 to 5-16
 - Enlarge/Reduce 5-6
 - keys 5-5
 - multiple 5-4
 - paper 2-1 to 2-4
 - Quality (type of original) ... 5-8

- single 5-3, 5-4
- Sort (ADF only) 5-8
- specifications S-3
- temporary settings 5-2, 5-5
- Tray Select 5-10
- tray use 4-6
- using ADF 5-3
- using scanner glass 5-4

D

- drivers
 - printer
 - Macintosh® 11-1
 - Windows® 6-1, 7-1
 - scanner
 - Macintosh® 11-14
 - Windows® 8-1
- drum unit
 - checking remaining life ... 14-34
 - replacing 14-30
- Duplex, setting up
 - paper adjustment lever ... 2-11
- Duplex/N in 1 key ... 5-11 to 5-16
- Duplex/1 in 1 5-14
- Duplex/2 in 1 5-16
- Duplex/4 in 1 5-16

E

- ecology
 - scanner lamp 4-5
 - Sleep Time 4-5
 - Toner Save 4-4
- Enlarge/Reduce key 5-6
- envelopes 2-3
- error messages on LCD 14-1
 - Check Paper 14-1
 - Machine Error 14-2

Out of Memory 14-2
while scanning
a document 5-4

F

FCC Notices (USA)
..... 13-1 to 13-2

G

gray scale S-3

J

jams
original 14-4
paper 14-5

L

LAN Configuration 3-7, 3-8
LCD (Liquid Crystal Display)
LCD Contrast 4-7

M

maintenance, routine 14-21
manual feed tray 6-5, 6-7
memory (option)
adding 15-8
installing 15-2
memory is full see *Error
messages on LCD*
memory security
(Secure key) 6-16
Menu table 3-1
multi-purpose tray
(MP tray) 2-1

O

OCR, changing settings
..... 10-10, 10-21

P

Page Counter 14-34
Paper S-2
capacity 2-3
jam 14-4
labels 2-1
loading 2-5
size, setting 4-3
transparency 2-1

PaperPort®
accessing 8-2
exporting 8-23
importing 8-22

print
area 5-1
canceling jobs 6-16
difficulties 14-11
drivers 7-1, 7-17
Duplex (two-sided) 6-3
emulation
Windows® 6-1, 7-17
Emulation Selection 6-17
envelopes 6-11
improving the print quality
..... 14-14
jams 14-5
jobs 6-16
manual feed tray 6-5
media 2-1, S-2
multi-purpose tray 6-6
on thick paper 6-7
reports and lists 6-18
resolution S-4
Secure key 6-16
specifications S-4

Q

Quality key (copying) 5-5

R

Resolution
 print S-4
 reports and lists 6-16
 scan 8-6, S-3

S

safety instructions viii, 13-6
scan key 8-16, 9-4
scanner lamp 4-5
scanner lock 14-18
scanning
 combine items into
 a single file 9-11
 Macintosh® 11-14
 settings, changing 10-9
 specifications S-3
 Windows® 98/98SE/Me/2000
 Professional and Windows
 NT® WS 4.0 9-1
 Windows® Network 12-1
 Windows® XP 10-1
Scanning into PC 8-3
 ScanSoft® OmniPage®
 OCR 8-22
 ScanSoft® PaperPort® ... 8-19
Secure key 6-16
shipping the DCP 14-18
Sleep Time 4-5
software
 Brother Control Center 9-1
 ScanSoft® PaperPort® ... 8-19
specifications, general S-1

T

temporary copy settings 5-5
toner cartridge
 replacing 14-24, 14-25
 save toner 4-4
Tray Use, setting
 copy 4-6
troubleshooting 14-1
 error messages on LCD ... 14-1
 if you are having difficulty
 paper handling 14-12
 printer difficulties 14-11
 improving print quality ... 14-14

U

User Settings List 4-7

V

volume, setting
 beeper 4-4

W

warranties iii
 Canada vii
 Notice-Disclaimer iii
 USA iv
World Wide Web i

EQUIPMENT ATTACHMENT LIMITATIONS (Canada only)

NOTICE

This product meets the applicable Industry Canada technical specifications.

NOTICE

The Ringer Equivalence Number is an indication of the maximum number of devices allowed to be connected to a telephone interface. The termination on an interface may consist of any combination of devices subject only to the requirement that the sum of the RENs of all the devices does not exceed five.

brother®

Brother International Corporation
100 Somerset Corporate Boulevard
P.O. Box 6911
Bridgewater, NJ 08807-0911 USA

Brother International Corporation (Canada) Ltd.
1 rue Hôtel de Ville,
Dollard-des-Ormeaux, QC, CANADA H9B 3H6

Visit us on the World Wide Web
<http://www.brother.com>

These machines are made for use in the USA and Canada only. We cannot recommend using them overseas because the power requirements of your Digital Copier/Printer may not be compatible with the power available in foreign countries. **Using USA or Canada models overseas is at your own risk and may void your warranty.**

Free Manuals Download Website

<http://myh66.com>

<http://usermanuals.us>

<http://www.somanuals.com>

<http://www.4manuals.cc>

<http://www.manual-lib.com>

<http://www.404manual.com>

<http://www.luxmanual.com>

<http://aubethermostatmanual.com>

Golf course search by state

<http://golfingnear.com>

Email search by domain

<http://emailbydomain.com>

Auto manuals search

<http://auto.somanuals.com>

TV manuals search

<http://tv.somanuals.com>