



# VivoMini VM45

## User Manual



# E13080

## First Edition

### June 2017

#### COPYRIGHT INFORMATION

No part of this manual, including the products and software described in it, may be reproduced, transmitted, transcribed, stored in a retrieval system, or translated into any language in any form or by any means, except documentation kept by the purchaser for backup purposes, without the express written permission of ASUSteK COMPUTER INC. ("ASUS").

ASUS PROVIDES THIS MANUAL "AS IS" WITHOUT WARRANTY OF ANY KIND, EITHER EXPRESS OR IMPLIED, INCLUDING BUT NOT LIMITED TO THE IMPLIED WARRANTIES OR CONDITIONS OF MERCHANTABILITY OR FITNESS FOR A PARTICULAR PURPOSE. IN NO EVENT SHALL ASUS, ITS DIRECTORS, OFFICERS, EMPLOYEES OR AGENTS BE LIABLE FOR ANY INDIRECT, SPECIAL, INCIDENTAL, OR CONSEQUENTIAL DAMAGES (INCLUDING DAMAGES FOR LOSS OF PROFITS, LOSS OF BUSINESS, LOSS OF USE OR DATA, INTERRUPTION OF BUSINESS AND THE LIKE), EVEN IF ASUS HAS BEEN ADVISED OF THE POSSIBILITY OF SUCH DAMAGES ARISING FROM ANY DEFECT OR ERROR IN THIS MANUAL OR PRODUCT.

Products and corporate names appearing in this manual may or may not be registered trademarks or copyrights of their respective companies, and are used only for identification or explanation and to the owners' benefit, without intent to infringe.

SPECIFICATIONS AND INFORMATION CONTAINED IN THIS MANUAL ARE FURNISHED FOR INFORMATIONAL USE ONLY, AND ARE SUBJECT TO CHANGE AT ANY TIME WITHOUT NOTICE, AND SHOULD NOT BE CONSTRUED AS A COMMITMENT BY ASUS. ASUS ASSUMES NO RESPONSIBILITY OR LIABILITY FOR ANY ERRORS OR INACCURACIES THAT MAY APPEAR IN THIS MANUAL, INCLUDING THE PRODUCTS AND SOFTWARE DESCRIBED IN IT.

Copyright © 2017 ASUSteK COMPUTER INC. All Rights Reserved.

#### LIMITATION OF LIABILITY

Circumstances may arise where because of a default on ASUS' part or other liability, you are entitled to recover damages from ASUS. In each such instance, regardless of the basis on which you are entitled to claim damages from ASUS, ASUS is liable for no more than damages for bodily injury (including death) and damage to real property and tangible personal property; or any other actual and direct damages resulted from omission or failure of performing legal duties under this Warranty Statement, up to the listed contract price of each product.

ASUS will only be responsible for or indemnify you for loss, damages or claims based in contract, tort or infringement under this Warranty Statement.

This limit also applies to ASUS' suppliers and its reseller. It is the maximum for which ASUS, its suppliers, and your reseller are collectively responsible.

UNDER NO CIRCUMSTANCES IS ASUS LIABLE FOR ANY OF THE FOLLOWING: (1) THIRD-PARTY CLAIMS AGAINST YOU FOR DAMAGES; (2) LOSS OF, OR DAMAGE TO, YOUR RECORDS OR DATA; OR (3) SPECIAL, INCIDENTAL, OR INDIRECT DAMAGES OR FOR ANY ECONOMIC CONSEQUENTIAL DAMAGES (INCLUDING LOST PROFITS OR SAVINGS), EVEN IF ASUS, ITS SUPPLIERS OR YOUR RESELLER IS INFORMED OF THEIR POSSIBILITY.

#### SERVICE AND SUPPORT

Visit our multi-language web site at <https://www.asus.com/support/>

# Contents

About this manual .....	4
Conventions used in this manual .....	4
Typography.....	4
Package contents .....	5

## Getting to know your VivoMini

Features .....	8
Front panel.....	8
Left side .....	9
Rear panel .....	10

## Using your VivoMini

Getting started.....	14
Connect the AC power adapter to your VivoMini.....	14
Connect a display panel to your VivoMini.....	16
Connect the USB cable from keyboard or mouse .....	17
Turn on your VivoMini.....	18
Turning your VivoMini off.....	19
Putting your VivoMini to sleep.....	19
Entering the BIOS Setup .....	19
Quickly enter the BIOS.....	20

## Memory upgrade

Upgrading memory modules .....	22
--------------------------------	----

## Appendix

Safety information .....	30
Setting up your system.....	30
Care during use .....	31
Regulatory notices.....	32
ASUS contact information .....	36

## About this manual

This manual provides information about the hardware and software features of your PC, organized through the following chapters:

### Chapter 1: Getting to know your VivoMini

This chapter details the hardware components of your VivoMini.

### Chapter 2: Using your VivoMini

This chapter provides you with information on using your VivoMini.

### Chapter 3: Memory upgrade

This chapter provides you with information on how to upgrade the memory modules of your VivoMini.

### Appendix

This section includes notices and safety statements your VivoMini.

## Conventions used in this manual

To highlight key information in this manual, some text are presented as follows:

---

**IMPORTANT!** This message contains vital information that must be followed to complete a task.

---

---

**NOTE:** This message contains additional information and tips that can help complete tasks.

---

---

**WARNING!** This message contains important information that must be followed to keep you safe while performing certain tasks and prevent damage to your VivoMini's data and components.

---

## Typography

### **Bold text**

Indicates a menu or an item to select.

### *Italic*

This indicates sections that you can refer to in this manual.

# Package contents

Your VivoMini package contains the following items:



VivoMini VM45

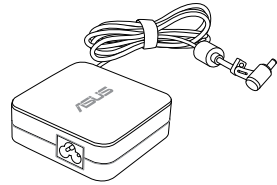

AC power adapter\*

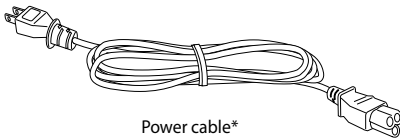

Power cable\*



Technical documentations

---

## NOTES:

- \*Actual product specifications and package contents may vary with your VivoMini's model type or with country or region.
  - If the device or its components fail or malfunction during normal and proper use within the warranty period, bring the warranty card to the ASUS Service Center for replacement of the defective components.
-



# 1

***Getting to know your VivoMini***

# Features

## Front panel

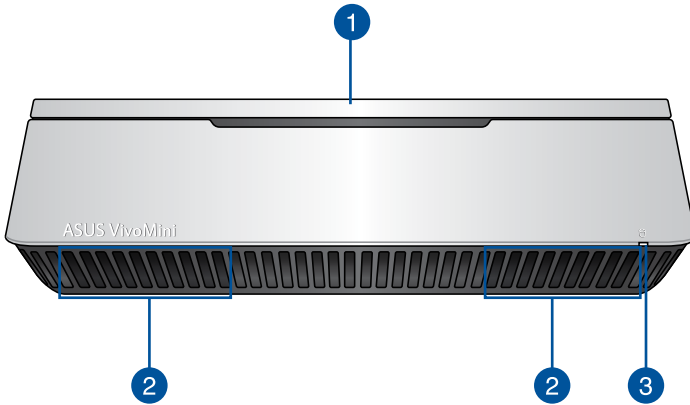

1

### Top cover

The removable top cover allows you access to the hard disk drive and the memory modules.

---

**IMPORTANT!** Before removing the top cover, turn off your VivoMini and unplug the power cable.

---

2

### Audio speakers

Your VivoMini uses SonicMaster technology to provide hi-fi sound quality, with richer bass sounds, straight from the built-in audio speakers.

3

### Drive activity indicator

This indicator lights up when your VivoMini is accessing the internal storage drive.



## Left side

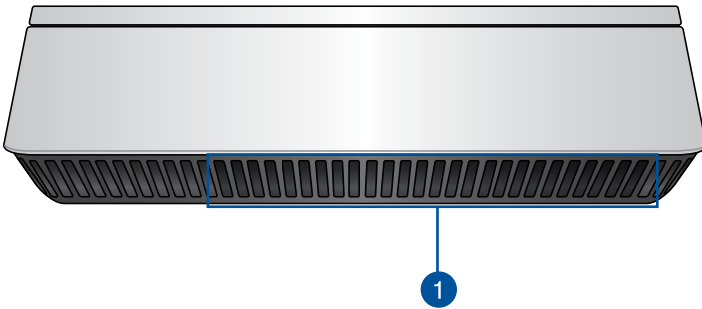

1

### Air vents

The air vents on the left side allow cooler air to enter your VivoMini chassis.

---

**IMPORTANT!** For optimum heat dissipation and air ventilation, ensure that the air vents are free from obstructions.

---

## Rear panel

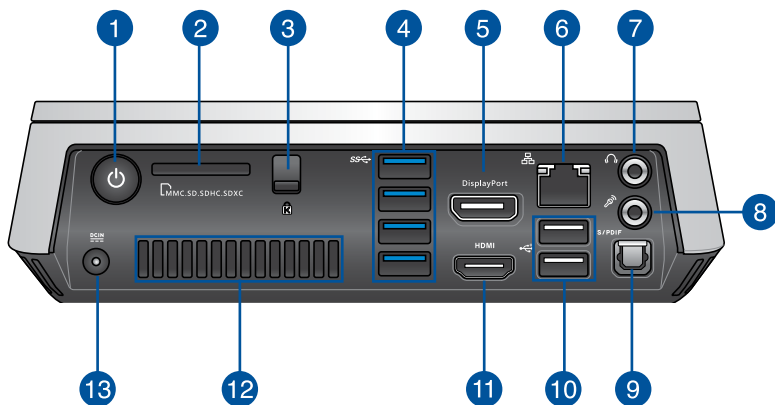

- 1**  **Power button**

The power button allows you to turn the VivoMini on or off. You can also press the power button once to put your VivoMini to sleep mode.
- 2**  **Memory card slot**

The built-in memory card reader enables your VivoMini to read and write data to and from MMC/SD/SDHC/SDXC cards.
- 3**  **Top cover lock latch + Kensington security slot**

The top cover lock latch fastens the top cover on your VivoMini.

The Kensington security slot allows you to secure your VivoMini using Kensington® security products.
- 4**  **USB 3.1 Gen 1 ports**

These USB 3.1 Gen 1 (Universal Serial Bus) ports provide a transfer rate of up to 5 Gbit/s and are backward compatible with USB 2.0.

5

DisplayPort

### DisplayPort port

Use this port to connect your VivoMini to a DisplayPort or VGA, DVI, or HDMI external display.

6



### LAN port

The 8-pin RJ-45 LAN port supports a standard Ethernet cable for connection to a local network.

7



### Headphone/Audio Out jack

The stereo headphone jack is used to connect the system's audio out signal to amplified speakers or headphones.

8



### Microphone jack

The microphone jack is designed to connect the microphone used for video conferencing, voice narrations, or simple audio recordings.

9

S/PDIF

### Digital audio out port (S/PDIF optical)

The Sony/Philips Digital Interface (S/PDIF) optical out port allows you to transfer digital audio from your VivoMini into an amplifier or your TV.

10



### USB 2.0 ports

The USB (Universal Serial Bus) 2.0 ports are compatible with USB 2.0/1.1 devices such as keyboards, mouse devices, cameras, and hard disk drives. USB allows many devices to run simultaneously on a single computer, with some peripheral acting as additional plug-in sites or hubs.

11

HDMI

### HDMI port

The HDMI (High Definition Multimedia Interface) port supports a Full-HD device such as an LCD TV or monitor to allow viewing on a larger external display.

12

### Rear air vents

The air vents on the rear allow warm air to exit the VivoMini.

---

**IMPORTANT!** For optimum heat dissipation and air ventilation, keep the air vents at least 10cm away from any obstructions.

---

13

DC IN

### Power input (DC 19V)

The supplied power adapter converts AC power to DC power for use with this jack. Power supplied through this jack supplies power to the PC. To prevent damage to the PC, always use the bundled power adapter.

---

**WARNING!** The power adapter may become warm to hot when in use. Do not cover the adapter and keep it away from your body.

---

***Using your VivoMini***

2

# Getting started

## Connect the AC power adapter to your VivoMini

### To connect the AC power adapter to your VivoMini:

- A. Connect the AC power cord to the AC/DC adapter.
- B. Connect the DC power connector into your VivoMini's power (DC) input port.
- C. Plug the AC power cord into a 100V~240V power source.

---

**NOTE:** The power adapter may vary in appearance, depending on models and your region.

---

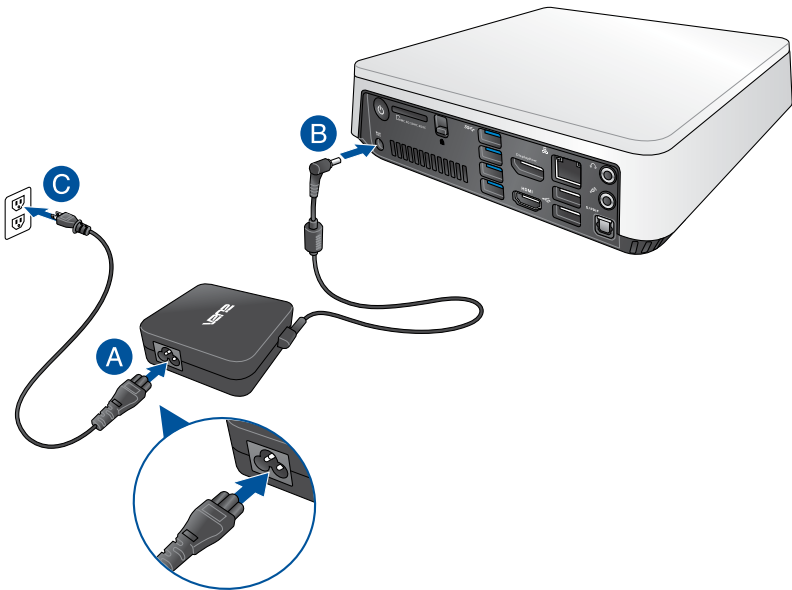

---

**IMPORTANT!**

- We strongly recommend that you use only the AC power adapter and cable that came with your VivoMini.
  - We strongly recommend that you use a grounded wall socket while using your VivoMini.
  - The socket outlet must be easily accessible and near your VivoMini.
  - To disconnect your VivoMini from its main power supply, unplug your VivoMini from the power socket.
- 

**NOTE:**

Power adapter information:

- Input voltage: 100-240Vac
  - Input frequency: 50-60Hz
  - Rating output current: 3.42A(65W)
  - Rating output voltage: 19V
-

## Connect a display panel to your VivoMini

You can connect a display panel or projector to your VivoMini that has the following connectors:

- HDMI connector
- DisplayPort connector
- VGA connector (use with a DisplayPort to VGA adapter or HDMI to VGA adapter)
- DVI connector (use with an HDMI to DVI adapter)

---

**NOTE:** The HDMI to DVI adapter, DisplayPort to VGA adapter, or HDMI to VGA adapter are each sold separately.

---

### To connect a display panel to your VivoMini:

Connect a display cable either to the HDMI or DisplayPort port.

Connecting display via HDMI port

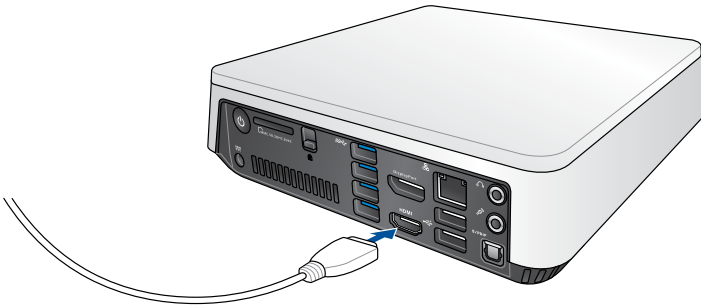

Connecting display via DisplayPort port

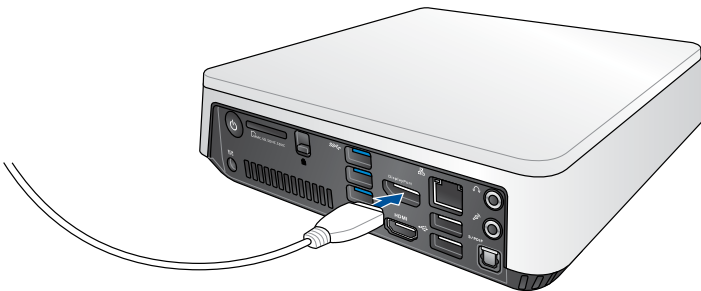





## Turn on your VivoMini

Press the power button to turn on your VivoMini.

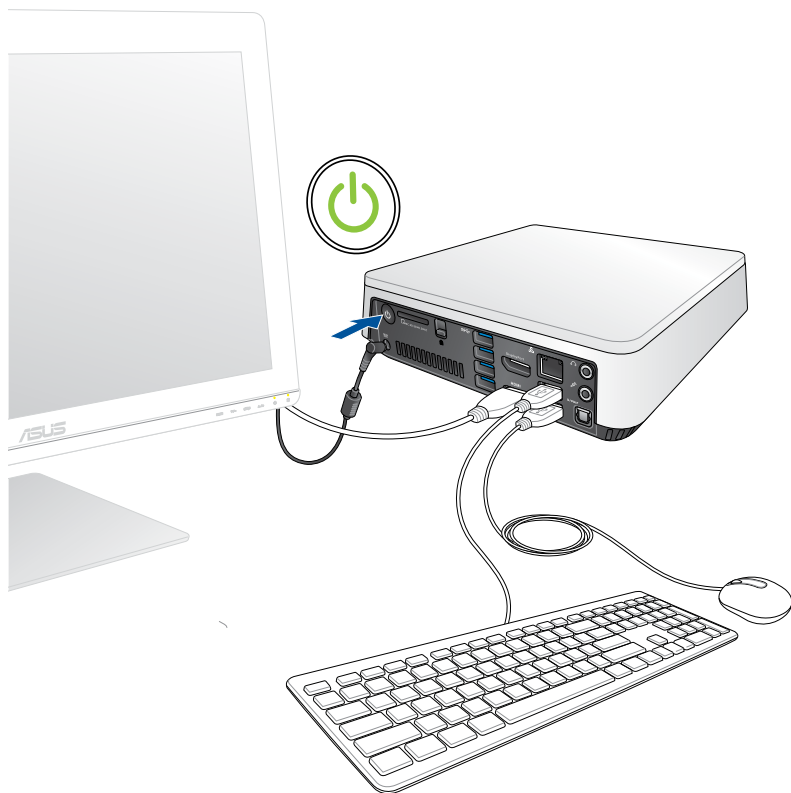

## Turning your VivoMini off

If your VivoMini is unresponsive, press and hold the power button for at least four (4) seconds until your VivoMini turns off.

## Putting your VivoMini to sleep

To put your VivoMini on Sleep mode, press the Power button once.

## Entering the BIOS Setup

BIOS (Basic Input and Output System) stores system hardware settings that are needed for system startup in the VivoMini.

In normal circumstances, the default BIOS settings apply to most conditions to ensure optimal performance. Do not change the default BIOS settings except in the following circumstances:

- An error message appears on the screen during the system bootup and requests you to run the BIOS Setup.
- You have installed a new system component that requires further BIOS settings or update.

---

**WARNING!** Inappropriate BIOS settings may result to instability or boot failure. We strongly recommend that you change the BIOS settings only with the help of a trained service personnel.

---

## Quickly enter the BIOS

To quickly enter the BIOS:

- Press the power button for at least four (4) seconds to shut down your VivoMini, then press the power button again to turn your VivoMini back on, then press <F2> or <Del> during POST.
- When your PC is off, disconnect the power cord from your VivoMini's power connector. Reconnect the power cable and press the power button to turn on your VivoMini. Press <F2> or <Del> during POST.

---

**NOTE:** POST (Power-On Self Test) is a series of software controlled diagnostic tests that run when you turn on your PC.

---

3

***Memory upgrade***

# Upgrading memory modules

Your VivoMini comes with two SO-DIMM memory slots that allow you to install two 2 GB, 4 GB, 8 GB, or 16 GB DDR4 260-pin SO-DIMMs for a maximum of 32 GB memory.

---

**IMPORTANT!** You can only install DDR4 SO-DIMM to the VivoMini's DIMM slots.

---

**NOTE:** Refer to <http://www.asus.com> for the list of compatible DIMMs.

---

To install or upgrade the memory modules:

1. Turn off your VivoMini.
2. Disconnect all cables and peripherals.
3. Place the VivoMini on a stable and flat surface.

4. Press down the latch at the rear panel to release the top cover.

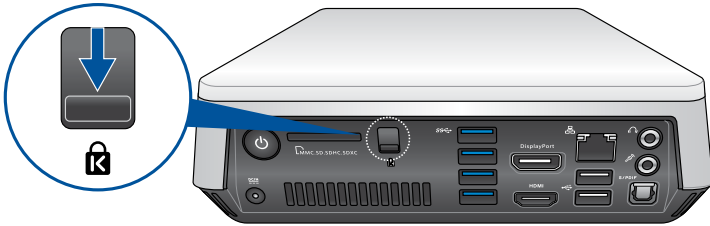

5. Slide the top cover towards the rear of VivoMini until it is detached from the chassis.

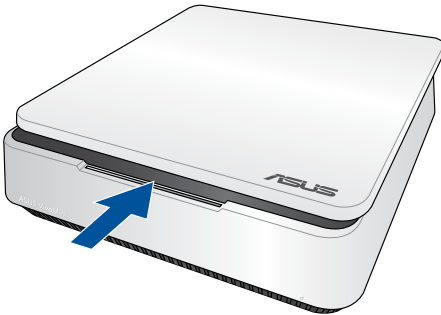

6. Remove the cover and set aside.

- Carefully slide the HDD or the Vivo DualBay adapter (with SSD or 2.5-inch HDD inside) from the SATA connector, then remove it from the drive bay.

Removing the HDD from drive bay

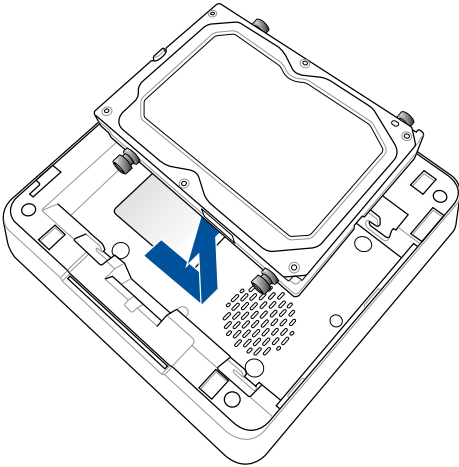

Removing the Vivo DualBay adapter (with SSD or 2.5-inch HDD inside) from drive bay

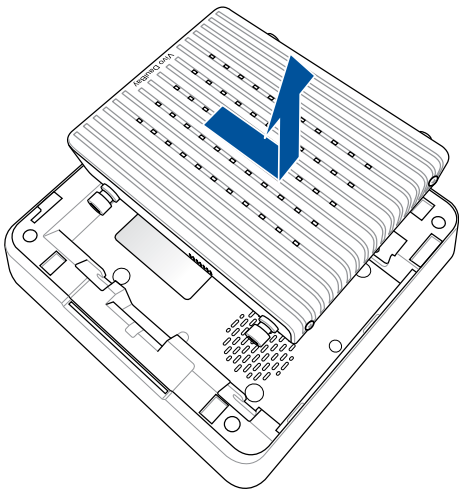



8. Prepare the memory module.
9. Release the screw that secures the SO-DIMM slot cover, then pry the slot cover open.

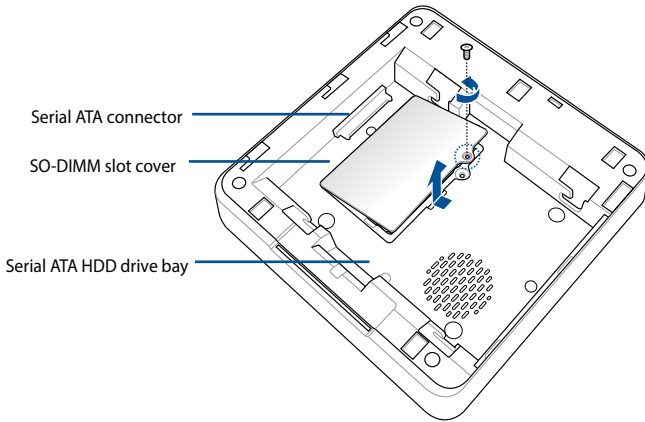

10. Align and insert the memory module into the slot (A) and press it down (B), until it is securely seated in place.

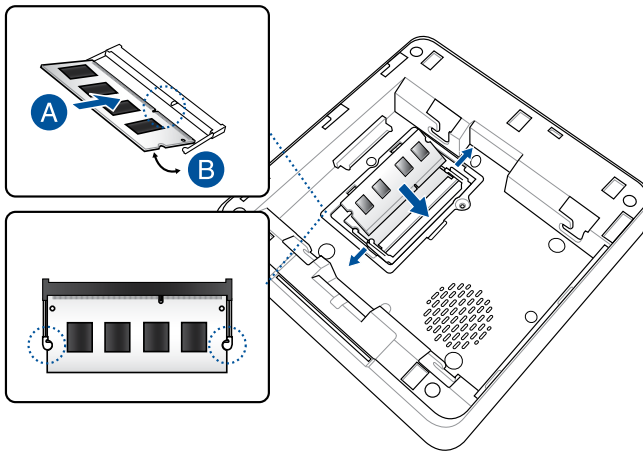

11. Replace the SO-DIMM slot cover and secure it with the screw.

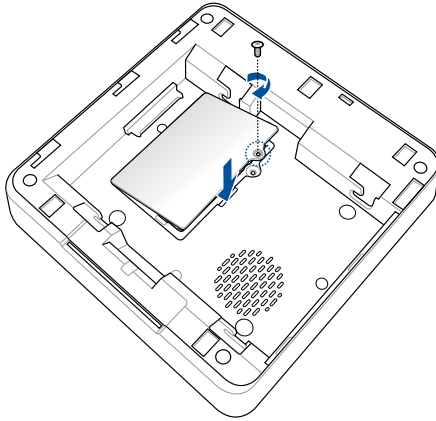

12. For HDD and Vivo DualBay adapter, match the rubber heads of the screws with the four screw slots on the drive bay.

- Carefully place the Serial ATA HDD or the Vivo DualBay adapter (with SSD or 2.5-inch HDD inside) into the drive bay, then slide the drive towards the SATA connector.

Re-installing the HDD to the drive bay

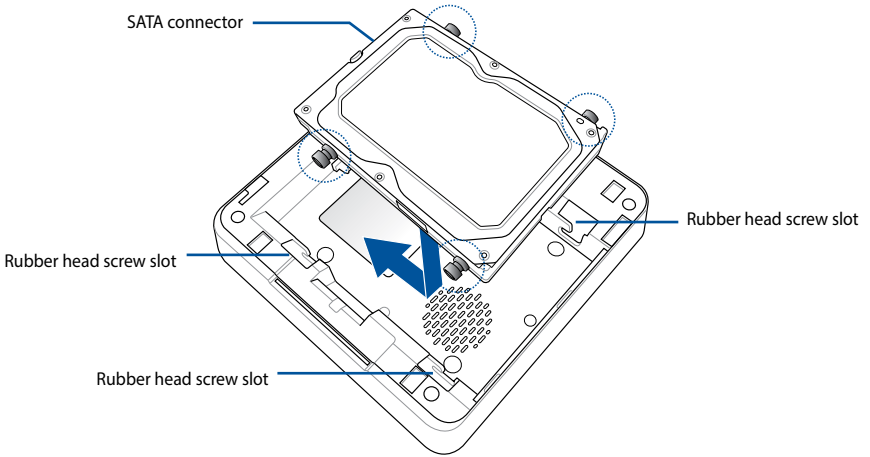

Re-installing the Vivo DualBay adapter (with SSD or 2.5-inch HDD inside) to the drive bay

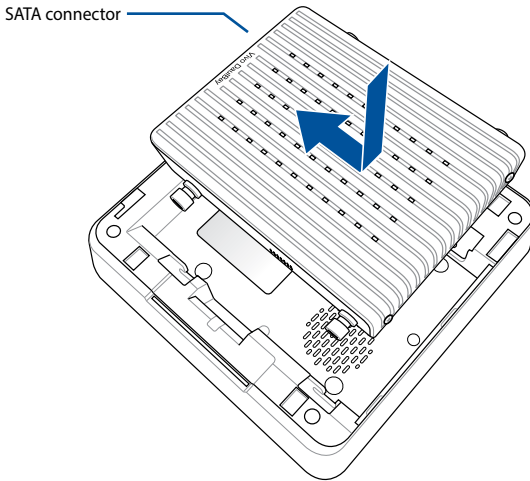

14. Replace the top cover then slide it towards the front of VivoMini to re-attach.



15. Lock the latch to securely fasten the top cover to the chassis.



# ***Appendix***

## Safety information

Your VivoMini is designed and tested to meet the latest standards of safety for information technology equipment. However, to ensure your safety, it is important that you read the following safety instructions.

### Setting up your system

- Read and follow all instructions in the documentation before you operate your system.
- Do not use this product near water or a heated source.
- Set up the system on a stable surface.
- Openings on the chassis are for ventilation. Do not block or cover these openings. Make sure you leave plenty of space around the system for ventilation. Never insert objects of any kind into the ventilation openings.
- Use this product in environments with ambient temperatures between 0°C and 35°C.
- If you use an extension cord, make sure that the total ampere rating of the devices plugged into the extension cord does not exceed its ampere rating.
- This equipment should be installed and operated with a minimum distance of 20cm between the radiator and your body.

## Care during use

- Do not walk on the power cord or allow anything to rest on it.
- Do not spill water or any other liquids on your system.
- When the system is turned off, a small amount of electrical current still flows. Always unplug the power cord from the power outlets before cleaning the system.
- If you encounter the following technical problems with the product, unplug the power cord and contact a qualified service technician or your retailer.
  - The power cord or plug is damaged.
  - Liquid has been spilled into the system.
  - The system does not function properly even if you follow the operating instructions.
  - The system was dropped or the cabinet is damaged.
  - The system performance changes.

### Lithium-Ion Battery Warning

**CAUTION:** Danger of explosion if battery is incorrectly replaced. Replace only with the same or equivalent type recommended by the manufacturer. Dispose of used batteries according to the manufacturer's instructions.

### NO DISASSEMBLY

**The warranty does not apply to the products that have been disassembled by users**



**DO NOT** throw the VivoMini in municipal waste. This product has been designed to enable proper reuse of parts and recycling. This symbol of the crossed out wheeled bin indicates that the product (electrical, electronic equipment, and mercury-containing button cell battery) should not be placed in municipal waste. Check local technical support services for product recycling.

# Regulatory notices

## REACH

Complying with the REACH (Registration, Evaluation, Authorization, and Restriction of Chemicals) regulatory framework, we publish the chemical substances in our products at ASUS REACH website at <http://csr.asus.com/english/REACH.htm>

## ASUS Recycling/Takeback Services

ASUS recycling and takeback programs come from our commitment to the highest standards for protecting our environment. We believe in providing solutions for you to be able to responsibly recycle our products, batteries, other components, as well as the packaging materials. Please go to <http://csr.asus.com/english/Takeback.htm> for the detailed recycling information in different regions.

## COATING NOTICE

---

**IMPORTANT!** To provide electrical insulation and maintain electrical safety, a coating is applied to insulate the device except on the areas where the I/O ports are located.

---

## Federal Communications Commission Statement

This device complies with Part 15 of the FCC Rules. Operation is subject to the following two conditions:

- This device may not cause harmful interference, and
- This device must accept any interference received including interference that may cause undesired operation.

This equipment has been tested and found to comply with the limits for a Class B digital device, pursuant to Part 15 of the FCC Rules.

These limits are designed to provide reasonable protection against harmful interference in a residential installation. This equipment generates, uses and can radiate radio frequency energy and, if not installed and used in accordance with manufacturer's instructions, may cause harmful interference to radio communications. However, there is no guarantee that interference will not occur in a particular installation.



If this equipment does cause harmful interference to radio or television reception, which can be determined by turning the equipment off and on, the user is encouraged to try to correct the interference by one or more of the following measures:

- Reorient or relocate the receiving antenna.
- Increase the separation between the equipment and receiver.
- Connect the equipment to an outlet on a circuit different from that to which the receiver is connected.
- Consult the dealer or an experienced radio/TV technician for help.

---

**CAUTION!** Any changes or modifications not expressly approved by the grantee of this device could void the user's authority to operate the equipment.

---

### **RF exposure warning**

This equipment must be installed and operated in accordance with provided instructions and the antenna(s) used for this transmitter must be installed to provide a separation distance of at least 20 cm from all persons and must not be co-located or operating in conjunction with any other antenna or transmitter. End-users and installers must be provide with antenna installation instructions and transmitter operating conditions for satisfying RF exposure compliance.

### **ISED Radiation Exposure Statement for Canada**

This equipment complies with ISED radiation exposure limits set forth for an uncontrolled environment. To maintain compliance with ISED RF exposure compliance requirements, please avoid direct contact to the transmitting antenna during transmitting. End users must follow the specific operating instructions for satisfying RF exposure compliance.

Operation is subject to the following two conditions:

- This device may not cause interference and
- This device must accept any interference, including interference that may cause undesired operation of the device.

## Compliance Statement of Innovation, Science and Economic Development Canada (ISED)

This Class B digital apparatus complies with Canadian ICES-003, RSS-210, and CAN ICES-3(B)/NMB-3(B).

This device complies with Industry Canada license exempt RSS standard(s). Operation is subject to the following two conditions: (1) this device may not cause interference, and (2) this device must accept any interference, including interference that may cause undesired operation of the device.

## Déclaration de conformité de Innovation, Sciences et Développement économique Canada (ISED)

Cet appareil numérique de classe B est conforme aux normes canadiennes ICES-003, RSS-210 et CAN ICES-3(B)/NMB-3(B).

Cet appareil est conforme aux normes CNR exemptes de licence d'Industrie Canada. Le fonctionnement est soumis aux deux conditions suivantes : (1) cet appareil ne doit pas provoquer d'interférences et (2) cet appareil doit accepter toute interférence, y compris celles susceptibles de provoquer un fonctionnement non souhaité de l'appareil.

## Wireless Operation Channel for Different Domains

N. America	2.412-2.462 GHz	Ch01 through CH11
Japan	2.412-2.484 GHz	Ch01 through Ch14
Europe ETSI	2.412-2.472 GHz	Ch01 through Ch13

## Regional notice for Singapore

Complies with  
IMDA Standards  
DB103778

This ASUS product complies with IMDA Standards.

## Regional notice for California



### WARNING

Cancer and Reproductive Harm -  
[www.P65Warnings.ca.gov](http://www.P65Warnings.ca.gov)

## ENERGY STAR complied product



ENERGY STAR is a joint program of the U.S. Environmental Protection Agency and the U.S. Department of Energy helping us all save money and protect the environment through energy efficient products and practices.

All ASUS products with the ENERGY STAR logo comply with the ENERGY STAR standard, and the power management feature is enabled by default. The monitor and computer are automatically set to sleep after 10 and 30 minutes of user inactivity. To wake your computer, click the mouse or press any key on the keyboard.

Please visit <http://www.energystar.gov/powermanagement> for detail information on power management and its benefits to the environment. In addition, please visit <http://www.energystar.gov> for detail information on the ENERGY STAR joint program.

---

**NOTE:** Energy Star is NOT supported on FreeDOS and Linux-based products.

---

# ASUS contact information

## ASUSTeK COMPUTER INC.

Address 4F, No. 150, Li-Te Rd., Peitou, Taipei 112, Taiwan  
Telephone +886-2-2894-3447  
Fax +886-2-2890-7798  
Web site <http://www.asus.com>

### Technical Support

Telephone +86-21-3842-9911  
Fax +86-21-5866-8722, ext. 9101#  
Online support <http://qr.asus.com/techserv>

## ASUS COMPUTER INTERNATIONAL (America)

Address 800 Corporate Way, Fremont, CA 94539, USA  
Telephone +1-510-739-3777  
Fax +1-510-608-4555  
Web site <http://usa.asus.com>

### Technical Support

Support fax +1-812-284-0883  
General support +1-812-282-2787  
Online support <http://qr.asus.com/techserv>

## ASUS COMPUTER GmbH (Germany and Austria)

Address Harkort Str. 21-23, D-40880 Ratingen, Germany  
Fax +49-2102-959931  
Web site <http://www.asus.com/de>  
Online contact <http://eu-rma.asus.com/sales>

### Technical Support

Telephone +49-2102-5789555  
Support Fax +49-2102-959911  
Online support <http://qr.asus.com/techserv>

<b>Manufacturer</b>	ASUSTeK Computer Inc.	
	Tel:	+886-2-2894-3447
	Address:	4F, No. 150, LI-TE RD., PEITOU, TAIPEI 112, TAIWAN
<b>Authorised representative in Europe</b>	ASUSTeK Computer GmbH	
	Address:	HARKORT STR. 21-23, 40880 RATINGEN, GERMANY

# DECLARATION OF CONFORMITY

Per FCC Part 2 Section 2. 1077(a)



**Responsible Party Name:** Asus Computer International

**Address:** 800 Corporate Way, Fremont, CA 94539.

**Phone/Fax No:** (510)739-3777/(510)608-4555

hereby declares that the product

**Product Name :** VivoMini

**Model Number :** VM45

Conforms to the following specifications:

FCC Part 15, Subpart B, Unintentional Radiators

## Supplementary Information:

This device complies with part 15 of the FCC Rules. Operation is subject to the following two conditions: (1) This device may not cause harmful interference, and (2) this device must accept any interference received, including interference that may cause undesired operation.

Representative Person's Name : Steve Chang / President

A handwritten signature in blue ink that reads "Steve Chang". The signature is written in a cursive style and is positioned above the "Signature:" label.

Signature :

Date : Jun. 30, 2017

Ver. 170324



## Free Manuals Download Website

<http://myh66.com>

<http://usermanuals.us>

<http://www.somanuals.com>

<http://www.4manuals.cc>

<http://www.manual-lib.com>

<http://www.404manual.com>

<http://www.luxmanual.com>

<http://aubethermostatmanual.com>

Golf course search by state

<http://golfingnear.com>

Email search by domain

<http://emailbydomain.com>

Auto manuals search

<http://auto.somanuals.com>

TV manuals search

<http://tv.somanuals.com>