

TOSHIBA Carrier INSTALLATION MANUAL

Super Heat Recovery Multi System Air Conditioner

T-shaped branching joints (For R410A)

Model name: RBM-BT14FUL, RBM-BT24FUL

Please read and follow the "Precautions for safety" in the installation manual for the air conditioner.

- Make sure all the parts listed in the table are included in the package.
- Read the installation manual for the air conditioner regarding the selection of the size and material of the refrigerant pipes.
- Ask an authorized dealer or qualified installation professional to install this product.
- Installation work must be carried out by following this installation manual and using exclusive tools and pipes for the refrigerant R410A.

Thank you for purchasing the "T-shaped branching joints" for TOSHIBA Carrier Air Conditioner. Before starting the installation work, please read this manual carefully and install the product properly.

PARTS TABLE

NOTE

- (): indicates outer diameter.
- For the sockets, the side with a notch is the one to connect a pipe. (⑥7, ⑥9, ⑥1, ⑥2 : without notch)

Socket

Diameter of the connecting pipe

External diameter of socket

Notch

	Suction gas side joint				Discharge gas side joint				Liquid side joint				Balance pipe joint					
RBM-BT14FUL													—					
Socket	⑤9	Ø1 3/8" x (Ø1 1/4") [Ø34.9 x (Ø31.8)]	1 pc	④3	(Ø1 1/8") x Ø7/8" [(Ø28.6) x Ø22.2]	2 pcs	⑥7	Ø1 1/8" x (Ø1") [Ø28.6 x (Ø25.4)]	1 pc	②2	(Ø1") x Ø7/8" [(Ø25.4) x Ø22.2]	1 pc	⑬	Ø5/8" x (Ø3/4") [Ø15.9 x (Ø19.1)]	1 pc	⑩	(Ø3/4") x Ø1/2" [(Ø19.1) x Ø12.7]	2 pcs
	②7	Ø1 1/8" x (Ø1 1/4") [Ø28.6 x (Ø31.8)]	1 pc							⑬	Ø1" x Ø3/4" [(Ø25.4) x Ø19.1]	2 pcs						
Joint	Joint		1 pc	L-pipe (Ø1") x Ø1 1/8" [(Ø25.4) x Ø28.6]		1 pc	T-joint 3-Ø1" [3-Ø25.4]		1 pc	T-joint 3-Ø3/4" [3-Ø19.1]		1 pc						
Heat insulator	Heat insulator for joint		1 pc	Heat insulator for L-pipe		1 pc	Locally procured			Locally procured								
RBM-BT24FUL													3-Ø3/8"					
Socket	⑥2	Ø1 5/8" x (Ø1 1/2") [Ø41.3 x (Ø38.1)]	1 pc	⑦1	(Ø1 1/2") x Ø1 1/8" [(Ø38.1) x Ø28.6]	1 pc	⑤9	Ø1 3/8" x (Ø1 1/4") [Ø34.9 x (Ø31.8)]	1 pc	②7	(Ø1 1/4") x Ø1 1/8" [(Ø31.8) x Ø28.6"]	1 pc	⑩	(Ø7/8") x Ø3/4" [(Ø22.2) x Ø19.1]	1 pc			
	⑥1	Ø1 3/8" x (Ø1 1/2") [Ø34.9 x (Ø38.1)]	1 pc	④3	(Ø1 1/8") x Ø7/8" [(Ø28.6) x Ø22.2]	1 pc				②3	(Ø1 1/4") x Ø7/8" [(Ø31.8) x Ø22.2]	2 pcs	⑭	(Ø7/8") x Ø5/8" [(Ø22.2) x Ø15.9]	2 pcs	⑧5	(Ø7/8") x Ø1/2" [(Ø22.2) x Ø12.7]	1 pc
Joint	Joint		1 pc	L-pipe (Ø1 1/8") x Ø1 1/8" [(Ø28.6) x Ø28.6]		1 pc	T-joint 3-Ø1 1/4" [3-Ø31.8]		1 pc	T-joint 3-Ø7/8" [3-Ø22.2]		1 pc	T-joint 3-Ø3/8" [3-Ø9.5]		1 pc			
Heat insulator	Heat insulator for joint		1 pc	Heat insulator for L-pipe		1 pc	Locally procured			Locally procured								

INSTALLATION AND CONNECTION

Select the model and the number of outdoor unit connection piping kits that you need based on the sales catalog, design engineering, and the data book and installation manual of outdoor unit.

CAUTION

- When brazing the refrigerant pipes, be sure to put the nitrogen first to prevent from oxidizing the inner pipe. If not, the oxidization scale brings the refrigerant cycle clogging and result in malfunction.
- Use clean new pipes for the refrigerant pipes, and do not let water, moisture or dust get into the pipes during installation.

1 INSTALLATION MODE

<Suction gas joint>

Install them horizontally with a maximum gradient of ±15 degrees for even distribution. (Do not install them perpendicularly or upright.) (Figure 4, Figure 5, Figure 6, Figure 7)

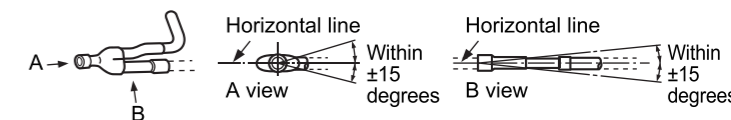

<Discharge gas / Liquid / balance pipe joint>

No restrictions on the installation orientation by the direction of refrigerant flow. However, on the discharge gas / liquid joint the installation cannot have the refrigerant from the main pipe flow directly into the header unit. (Figure 2)

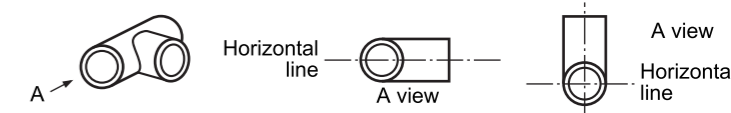

Discharge gas / Liquid pipes

Figure 1

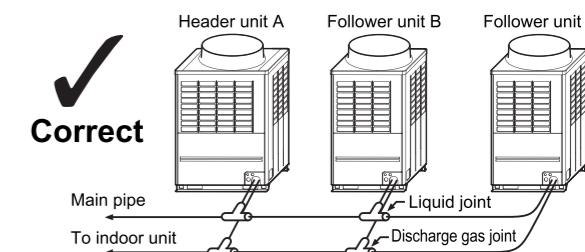
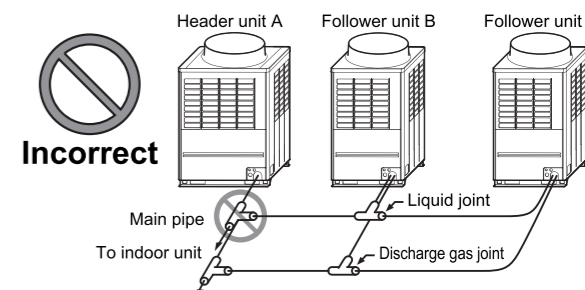
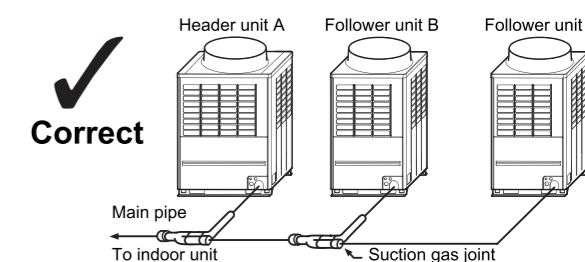

Figure 2



Suction gas pipes

Figure 3



Suction gas joint reverse orientation installation

Figure 4

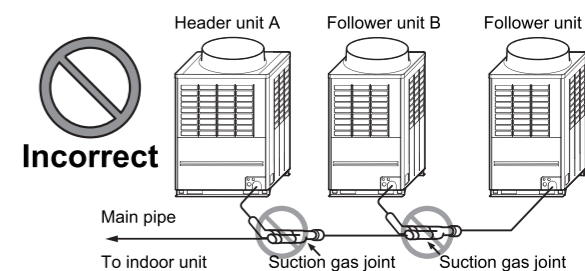

<Suction gas joint upright orientation installation>
Figure 5

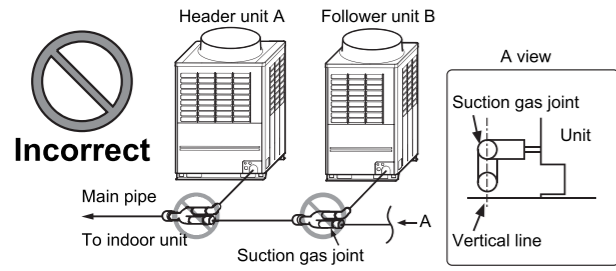

<Vertical installation>
Figure 6

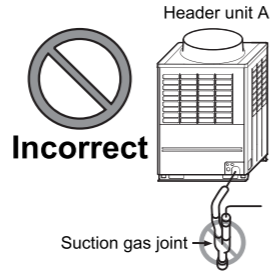

<Vertical installation>
Figure 7

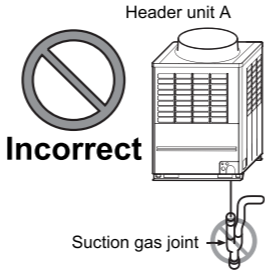

2 CONNECTION METHOD

<Suction gas joint>

Determine the installation orientation of the L-pipe according to the piping connections from the outdoor unit, and select a socket that matches the diameter of the locally procured pipes.

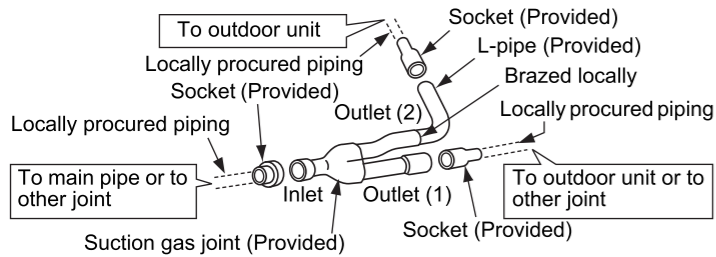

NOTE

- Select the socket (No.in ○) fitting to the pipe diameter connected to the outdoor unit.
- After cutting the pipe, be sure to remove the burrs and polish the end surface. When some squash or deformation, etc. occurs, improve the pipe insertion condition by using the flare tool.
- Confirm whether no dust, water, foreign matters, etc exists on the gas joint, the liquid joint, the balance pipe joint and the socket to be inserted.

<Discharge gas / Liquid joint>

Select a socket to match the diameter of the locally procured piping and install it.

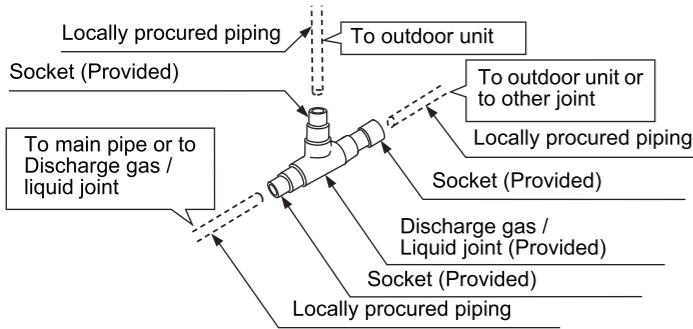

<Balance pipe joint>

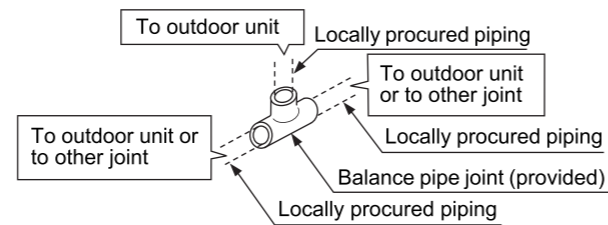

For 2 outdoor units system, connect directly between the header unit and the follower unit.

3 EXAMPLE OF PIPE CONNECTIONS

Install and connect the piping between the outdoor units as shown in the diagram below.

NOTE

There are no specific requirements on the length of the straight pipe before the joint for either the gas or liquid sides.

<For connections to the front>

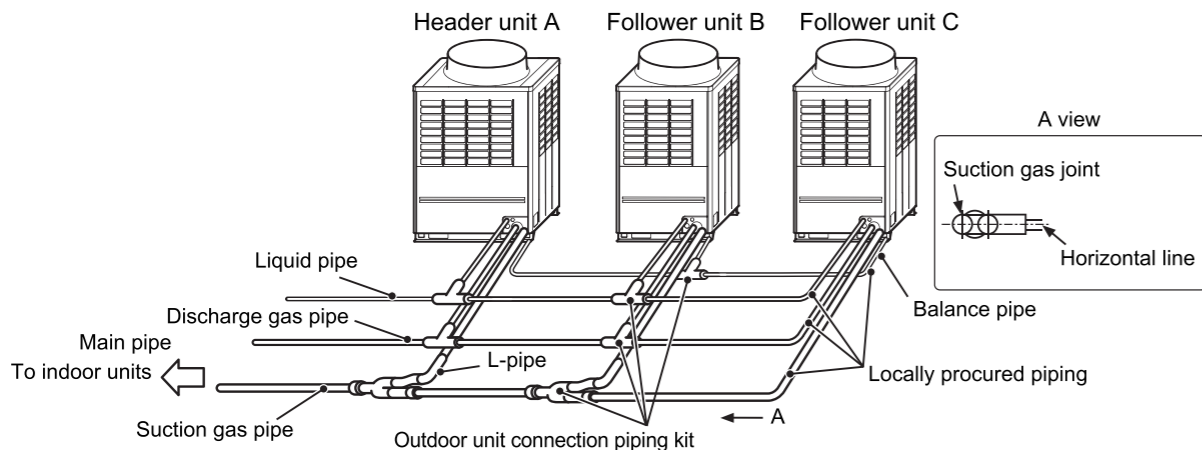

<For connections to the bottom>

Remove the knock-out hole from the bottom of the outdoor units. (Refer to the installation manual of the outdoor unit.)

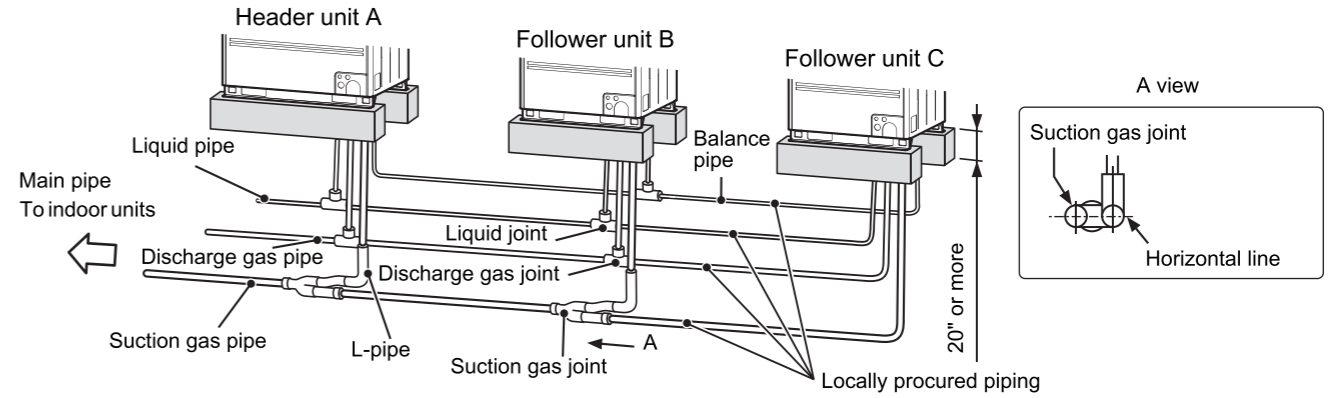

4 HEAT INSULATING FOR PIPES

- Insulate the joints of the liquid pipe, suction gas pipe, discharge gas pipe, and balance pipe individually.
- Insulator for the discharge gas joint, liquid joint and the balance pipe joint are not provided. Please procure it locally.

<Suction gas pipe>

- Use heat insulators with heat resistance of 248 °F or more for the discharge gas pipe.
- In order to prevent dripping condensation, do not leave any gap between heat insulator for branching joint (included in package) and heat insulator for pipe (locally procured). And then, wrap the seam with heat insulator with thickness of 0.4" or more (locally procured).

How to apply the insulation to the suction gas joint

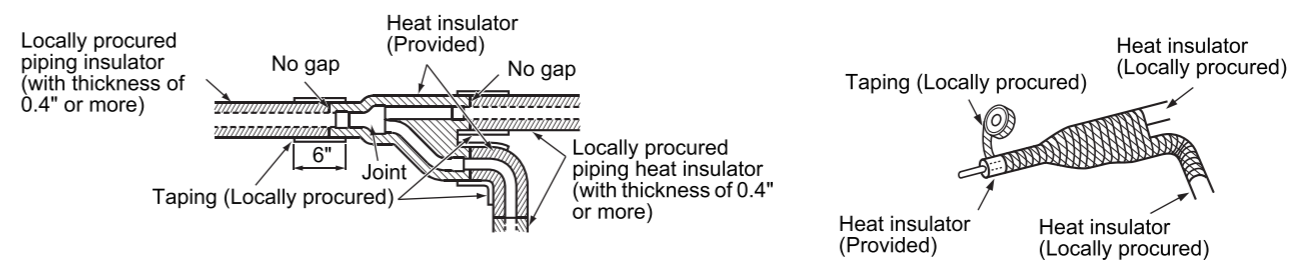

<Discharge gas / Liquid / Balance pipe>

- To heat insulate the T-joints, use a commercially available joint cover (for T-shape) that is with 0.4" or more thickness, or one applied with machining as shown in the figure.
- Seal the T-joints completely without any gap to prevent condensation and dripping water.

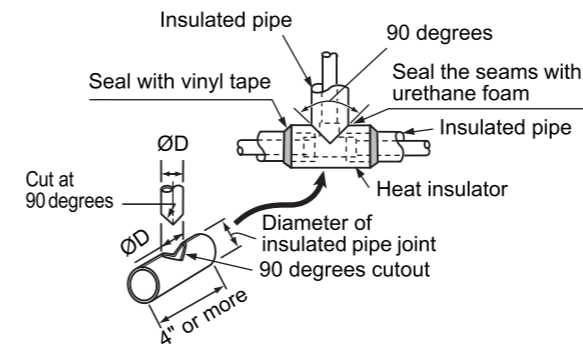

Free Manuals Download Website

<http://myh66.com>

<http://usermanuals.us>

<http://www.somanuals.com>

<http://www.4manuals.cc>

<http://www.manual-lib.com>

<http://www.404manual.com>

<http://www.luxmanual.com>

<http://aubethermostatmanual.com>

Golf course search by state

<http://golfingnear.com>

Email search by domain

<http://emailbydomain.com>

Auto manuals search

<http://auto.somanuals.com>

TV manuals search

<http://tv.somanuals.com>