

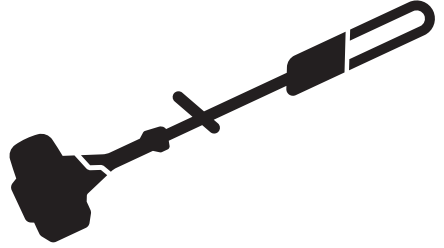

**Husqvarna**<sup>®</sup>



**530iP4, 530iPT5**



7. Keypad
8. Power trigger lockout
9. Power trigger
10. Rear handle
11. Front handle
12. Flexible cord
13. Battery charger (Accessory)
14. Power indicator
15. Battery release buttons
16. Battery (Accessory)
17. Warning indicator
18. Battery indicator button
19. Battery status
20. Start and stop button
21. SavE button
22. Harness
23. 4 mm hex key
24. Combination key
25. Operator's manual
26. Telescopic function (530IPT5)
27. Branch hook
28. Transport guard
29. Impact guard

## Symbols on the product



**WARNING!** This product is dangerous. Injury or death can occur to the operator or bystanders if the product is not used carefully and correctly. To prevent injury to the operator or bystanders, read and obey all safety instructions in the operator's manual. Please read the operator's manual carefully and make sure that you understand the instructions before use.



Use a protective helmet in locations where objects can fall on you. Use approved

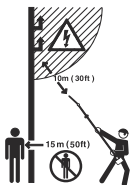

This product is not electrically insulated. If the product touches or comes close to high-voltage power lines it could lead to death or serious injury. Electricity can jump from one point to another by arcing. The higher the voltage, the greater the distance electricity can jump. Electricity can also travel through branches and other objects, especially if they are wet. Always keep a distance of at least 10 m between the machine and high-voltage power lines and/or any objects that are touching them. If you have to work within this safe distance you should always contact the relevant power company to make sure the power is switched off before you start work.

The operator of the product must ensure, while working, that no persons or animals come closer than 15 meters.

hearing protection. Use approved eye protection.



Use approved protective gloves.



Use heavy-duty slip-resistant boots.



The arrows show the limit for the handle position.

**IPX4** Protected against splashing water.



Direct current.



Keep all parts of your body away from the hot surfaces.



Filling with chain oil and adjusting oil flow.



Cutting unit operating cycle, operation time/ idle time.



The product or package cannot be disposed as domestic waste. The product and package must be sent to a correct recycling station for the recovery of electrical and electronic equipment. (Applies to Europe only)

yyyywwxxxx

The rating plate shows the serial number. **yyyy** is the production year, **ww** is the production week and **xxxx** is the sequential number.



Use and keep the battery charger indoors only.



Double insulation.



The product agrees with the applicable EC directives.

**Note:** Other symbols/decals on the product refer to certification requirements for some markets.

## Symbols on the battery and/or on the battery charger



Recycle this product at a recycling station for electrical and electronic equipment. (Applies to Europe only)



Fail-safe transformer.

## Product liability

As referred to in the product liability laws, we are not liable for damages that our product causes if:

- the product is incorrectly repaired.
- the product is repaired with parts that are not from the manufacturer or not approved by the manufacturer.
- the product has an accessory that is not from the manufacturer or not approved by the manufacturer.
- the product is not repaired at an approved service center or by an approved authority.

## Safety

### Safety definitions

Warnings, cautions and notes are used to point out specially important parts of the manual.



**WARNING:** Used if there is a risk of injury or death for the operator or bystanders if the instructions in the manual are not obeyed.



**CAUTION:** Used if there is a risk of damage to the product, other materials or the adjacent area if the instructions in the manual are not obeyed.

**Note:** Used to give more information that is necessary in a given situation.

### General power tool safety warnings



**WARNING:** Read all safety warnings and all instructions. Failure to follow the warnings and instructions may result in electric shock, fire and/or serious injury.

**Note:** Save all warnings and instructions for future reference. The term "power tool" in the warnings refers

to your mains-operated (corded) power tool or battery-operated (cordless) power tool.

### Work area safety

- **Keep work area clean and well lit.** Cluttered or dark areas invite accidents.
- **Do not operate power tools in explosive atmospheres, such as in the presence of flammable liquids, gases or dust.** Power tools create sparks which may ignite the dust or fumes.
- **Keep children and bystanders away while operating a power tool.** Distractions can cause you to lose control.

### Electrical safety

- **Power tool plugs must match the outlet. Never modify the plug in any way. Do not use any adapter plugs with earthed (grounded) power tools.** Unmodified plugs and matching outlets will reduce risk of electric shock.
- **Avoid body contact with earthed or grounded surfaces, such as pipes, radiators, ranges and refrigerators.** There is an increased risk of electric shock if your body is earthed or grounded.
- **Do not expose power tools to rain or wet conditions.** Water entering a power tool will increase the risk of electric shock.

- **Do not abuse the cord. Never use the cord for carrying, pulling or unplugging the power tool. Keep cord away from heat, oil, sharp edges or moving parts.** Damaged or entangled cords increase the risk of electric shock.
- **When operating a power tool outdoors, use an extension cord suitable for outdoor use.** Use of a cord suitable for outdoor use reduces the risk of electric shock.
- **If operating a power tool in a damp location is unavoidable, use a residual current device (RCD) protected supply.** Use of a RCD reduces the risk of electric shock.

## Personal safety

- **Stay alert, watch what you are doing and use common sense when operating a power tool. Do not use a power tool while you are tired or under the influence of drugs, alcohol or medication.** A moment of inattention while operating power tools may result in serious personal injury.
- **Use personal protective equipment. Always wear eye protection.** Protective equipment such as dust mask, non-skid safety shoes, hard hat or hearing protection used for appropriate conditions will reduce personal injuries.
- **Prevent unintentional starting. Ensure the switch is in the OFF-position before connecting to a power source and/or battery pack, picking up or carrying the tool.** Carrying power tools with your finger on the switch or energising power tools that have the switch on invites accidents.
- **Remove any adjusting key or wrench before turning the power tool on.** A wrench or a key left attached to a rotating part of the power tool may result in personal injury.
- **Do not overreach. Keep proper footing and balance at all times.** This enables better control of the power tool in unexpected situations.
- **Dress properly. Do not wear loose clothing or jewellery. Keep your hair and clothing away from moving parts.** Loose clothes, jewellery or long hair can be caught in moving parts.
- **If devices are provided for the connection of dust extraction and collection facilities, ensure these are connected and properly used.** Use of dust collection can reduce dust-related hazards.
- **Do not let familiarity gained from frequent use of tools allow you to become complacent and ignore tool safety principles.** A careless action can cause severe injury within a fraction of a second.
- The vibration emission during actual use of the power tool can differ from the declared total value depending on the ways in which the tool is used. Operators should identify safety measures to protect themselves that are based on an estimation of exposure in the actual conditions of use (taking account of all parts of the operating cycle such as the times when the tool is switched off and when it is running idle in addition to the trigger).

## Power tool use and care

- **Do not force the power tool. Use the correct power tool for your application.** The correct power tool will do the job better and safer at the rate for which it was designed.
- **Do not use the power tool if the switch does not turn it on and off.** Any power tool that cannot be controlled with the switch is dangerous and must be repaired.
- **Disconnect the plug from the power source and/or the battery pack from the power tool before making any adjustments, changing accessories, or storing power tools.** Such preventive safety measures reduce the risk of starting the power tool accidentally.
- **Store idle power tools out of the reach of children and do not allow persons unfamiliar with the power tool or these instructions to operate the power tool.** Power tools are dangerous in the hands of untrained users.
- **Maintain power tools. Check for misalignment or binding of moving parts, breakage of parts and any other condition that may affect the power tool's operation. If damaged, have the power tool repaired before use.** Many accidents are caused by poorly maintained power tools.
- **Keep cutting tools sharp and clean.** Properly maintained cutting tools with sharp cutting edges are less likely to bind and are easier to control.
- **Use the power tool, accessories and tool bits etc. in accordance with these instructions, taking into account the working conditions and the work to be performed.** Use of the power tool for operations different from those intended could result in a hazardous situation.

## Battery tool use and care

- **Recharge only with the charger specified by the manufacturer.** A charger that is suitable for one type of battery pack may create a risk of fire when used with another battery pack.
- **Use power tools only with specifically designated battery packs.** Use of any other battery packs may create a risk of injury and fire.
- **When battery pack is not in use, keep it away from other metal objects, like paper clips, coins, keys, nails, screws or other small metal objects, that can make a connection from one terminal to another.** Shorting the battery terminals together may cause burns or a fire.
- **Under abusive conditions, liquid may be ejected from the battery; avoid contact. If contact accidentally occurs, flush with water. If liquid contacts eyes, additionally seek medical help.** Liquid ejected from the battery may cause irritations or burns.

## Service

- **Have your power tool serviced by a qualified repair person using only identical replacement parts.** This

will ensure that the safety of the power tool is maintained.

## Pole pruner safety warnings - personal safety

- **Keep all parts of the body away from the saw chain when using the pole pruner. Before you start the pole pruner, make sure the saw chain is not contacting anything.** A moment of inattention while operating pole pruners may cause entanglement of your clothing or body with the saw chain.
- **Always hold the pole pruner with your right hand on the rear handle and your left hand on the front handle.** Holding the chain saw with a reversed hand configuration increases the risk of personal injury and should never be done.
- **Hold the pole pruner by insulated gripping surfaces only, because the saw chain may contact hidden wiring or its own cord.** Saw chains contacting a "live" wire may make exposed metal parts of the pole pruner "live" and could give the operator an electric shock.
- **Wear eye protection. Further protective equipment for hearing, head, hands, legs and feet is recommended.** Adequate protective equipment will reduce personal injury from flying debris or accidental contact with the saw chain.
- **Always keep proper footing and operate the chain saw only when standing on fixed, secure and level surface.** Slippery or unstable surfaces may cause a loss of balance or control of the pole pruner.
- **When cutting a limb that is under tension, be alert for spring back.** When the tension in the wood fibres is released, the spring loaded limb may strike the operator and/or throw the pole pruner out of control.
- **Use extreme caution when cutting brush and saplings.** The slender material may catch the pole pruner and be whipped toward you or pull you off balance.
- **Follow instructions for lubricating, chain tensioning and changing the bar and chain.** Improperly tensioned or lubricated chain may either break or increase the chance for kickback.
- **Carry the pole pruner by the front handle with the pole pruner switched off and away from your body.** When transporting or storing the pole pruner, always fit the guide bar cover. Proper handling of the pole pruner will reduce the likelihood of accidental contact with the moving saw chain.
- **Cut wood only. Do not use pole pruner for purposes not intended. For example: do not use pole pruner for cutting metal, plastic, masonry or non-wood building materials.** Use of the pole pruner for operations different than intended could result in a hazardous situation.
- **Keep handles dry, clean and free from oil and grease.** Greasy, oily handles are slippery causing loss of control.
- **Do not attempt to fell a tree until you have an understanding of the risks and how to avoid them.**

Serious injury could occur to the operator or bystanders while felling a tree.

- **This pole pruner is not intended for tree felling.** Use of the pole pruner for operations different than intended could result in serious injury to the operator or bystanders.
- We strongly recommend that first time users practice sawing logs on a saw horse or cradle.

## Causes and operator prevention of kickback

Kickback may occur when the nose or tip of the guide bar touches an object, or when the wood closes in and pinches the pole pruner in the cut. Tip contact in some cases may cause a sudden reverse reaction, kicking the guide bar up and back towards the operator. Pinching the pole pruner along the top of the guide bar may push the guide bar rapidly back towards the operator. Either of these reactions may cause you to lose control of the pole pruner which could result in serious personal injury. Do not rely exclusively upon the safety devices built into your pole pruner. As a pole pruner user, you should take several steps to keep your cutting jobs free from accident or injury. Kickback is the result of pole pruner misuse and/or incorrect operating procedures or conditions and can be avoided by taking proper precautions as given below:

- **Maintain a firm grip, with thumbs and fingers encircling the pole pruner handles, with both hands on the pole pruner and position your body and arm to allow you to resist kickback forces.** Kickback forces can be controlled by the operator, if proper precautions are taken. Do not let go of the pole pruner.
- **Do not overreach and do not cut above shoulder height.** This helps prevent unintended tip contact and enables better control of the pole pruner in unexpected situations.
- **Only use replacement guide bars and pole pruners specified by the manufacturer.** Incorrect replacement guide bars and pole pruners may cause chain breakage and/or kickback.
- **Follow the manufacturer's sharpening and maintenance instructions for the pole pruner.** Decreasing the depth gauge height can lead to increased kickback.

## General safety instructions



**WARNING:** Read the warning instructions that follow before you use the product.

- Remove the battery to prevent the product from being started by accident.
- This product is a dangerous tool if you are not careful or if you use the product incorrectly. This product can cause serious injury or death to the operator or others.

- Do not use the product if it is changed from its initial specification. Do not change a part of the product without approval from the manufacturer. Only use parts that are approved by the manufacturer. Injury or death is a possible result of incorrect maintenance.
- Do a check of the product before use. See, *To check before starting on page 14* and *Maintenance schedule on page 15*. Do not use a defective product. Do the safety checks, maintenance and service instructions described in this manual.
- Children should be supervised to ensure that they do not play with the product. Never allow children or other persons not trained in the use of the product and/or the battery to use or service it. Local laws may regulate the age of the user.
- Keep the product in a locked area to prevent access for children or persons that are not approved.
- Store the product out of reach of children.
- Under no circumstances may the design of the product be modified without the permission of the manufacturer. Always use original accessories. Non-authorized modifications and/or accessories can result in serious personal injury or the death of the operator and others.

---

**Note:** National or Local laws can regulate the use. Comply to given regulations.

---

## Safety instructions for operation

---



**WARNING:** Read and obey the warning instructions that follow before you use the product.

---

- Listen out for warning signals or shouts when you wear hearing protection. Always remove your hearing protection as soon as the product stops.
- Overexposure to vibration can lead to circulatory damage or nerve damage in persons who have poor circulation. Speak to your physician if you experience symptoms of overexposure to vibration. Such symptoms include numbness, loss of feeling, tingling, pricking, pain, loss of strength, changes in skin colour or condition. These symptoms usually show in the fingers, hands or wrists.
- Never use a cutting attachment without an approved guard. If an incorrect or faulty guard is fitted this can cause serious personal injury.
- Always stop the product, remove the battery and make sure that the cutting equipment stops completely before you start to do any work on the product. Departure from the sharpening instructions considerably increase the risk of kickback.
- If you encounter a situation where you are uncertain how to proceed you should ask an expert. Contact your dealer or your service workshop. Avoid all usage which you consider to be beyond your capability.
- Avoid all usage which you consider to be beyond your capability.
- Never use the product if you are fatigued, while under the influence of alcohol or drugs, medication or anything that could affect your vision, alertness, coordination or judgment.
- The product can be thrown violently to the side when the tip of the guide bar comes in contact with a fixed object. This is called kickback. A kickback can be violent enough to cause the product/operator to be propelled in any direction, and possibly lose control of the product. Avoid cutting with the guide bar tip.
- Do not use the product unless you are able to call for help in case of an accident.
- Keep a good balance and a firm foothold. Make sure that you can move and stand safely. Check the area around you for possible obstacles (roots, rocks, branches, ditches, etcetera) in case you have to move suddenly. Take great care when you work on sloping ground.
- Always inspect the working area. Remove all loose objects such as stones, broken glass, nails, steel wire, string, etcetera, that could be thrown out or become wrapped around the cutting attachment.
- Take great care when cutting a tree that is in tension. A tree that is in tension may spring back to its normal position before or after being cut. If you position yourself incorrectly or make the cut in the wrong place the tree may hit you or the product and cause you to lose control. Both situations can cause serious personal injury.
- Use the harness to support the weight of the product and make it easier to handle.
- Always hold the product with both hands. Hold the product on the right side of your body.

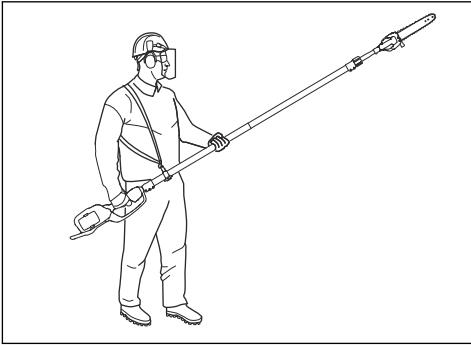

- Use a protective helmet where there is a risk of falling objects.

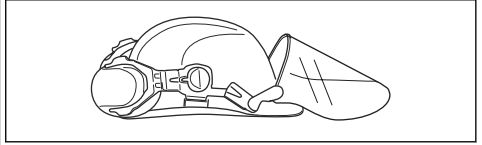

- Long term exposure to noise can result in damaged hearing. In general, battery powered products are relatively quiet but damage can result from a combination of noise level and long usage. recommends that operators use hearing protectors when using products for a longer coherent time of a day. Continual and regular users should have their hearing checked regularly.

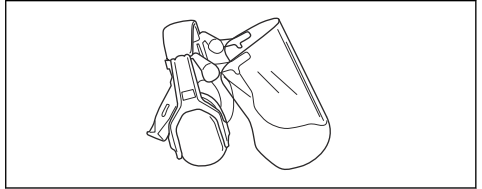

**WARNING:** Hearing protectors limit the ability to hear sounds and warning signals.

- Use approved eye protection. If you use a visor, you must also use approved protective goggles. Approved protective goggles must comply with the ANSI Z87.1 standard in the USAs or EN 166 in EU countries.

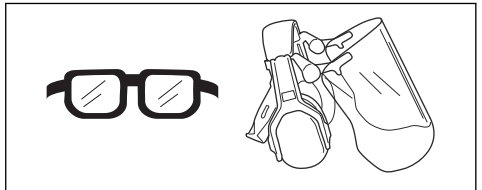

- Use gloves when necessary, for example when you attach, examine or clean the cutting equipment.

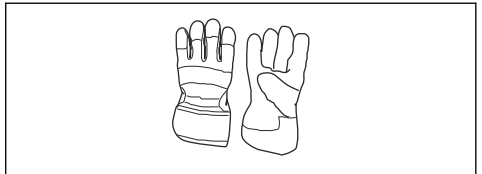

- Stop the product before you move to another area. Attach the transport guard before carrying or transporting the product any distance.
- Never put the product down when it is activated unless you have it in clear sight.
- If the product is operated at temperatures below -10°C the product and the battery must be stored in a heated space for at least 24 hours before starting work.
- Never stand directly underneath a branch that is being cut. This could lead to serious or even fatal personal injury.
- Observe the applicable safety regulations for work in the vicinity of overhead power lines.
- This product is not electrically insulated. If the product touches or comes close to high-voltage power lines it could lead to death or serious bodily injury. Electricity can jump from one point to another by arcing. The higher the voltage, the greater the distance electricity can jump. Electricity can also travel through branches and other objects, especially if they are wet. Always keep a distance of at least 10 m /33 ft between the product and high voltage power lines and/or objects that are touching them. If you have to work within this safe distance you should always contact the relevant power company to make sure the power is switched off before you start work.
- A faulty cutting attachment may increase the risk of accidents.

## Personal protective equipment



**WARNING:** Read the warning instructions that follow before you use the product.

- Always use approved personal protective equipment when you use the product. Personal protective equipment cannot fully prevent injury but it decreases the degree of injury if an accident does occur. Let your dealer help you select the right equipment.



- Use sturdy non-slip boots or shoes.

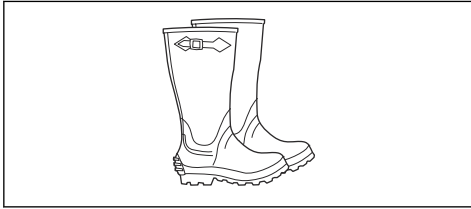

- Use clothing made of a strong fabric. Always use heavy, long pants and long sleeves. Do not use loose clothing that can catch on twigs and branches. Do not wear jewelry, short pants, sandals or go with bare feet. Put your hair up safely above shoulder level.
- Keep first aid equipment close at hand.

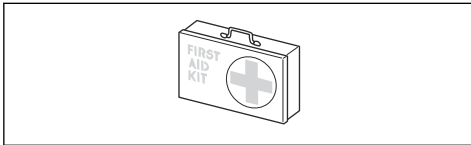

## Safety devices on the product



**WARNING:** Read the warning instructions that follow before you use the product.

- Do not use a product with defective safety devices.
- Do a check of the safety devices regularly. Refer to *Maintenance schedule on page 15*.
- If the safety devices are defective, speak to your Husqvarna servicing dealer.

### To do a check of the keypad

1. Push the start/stop button (A).

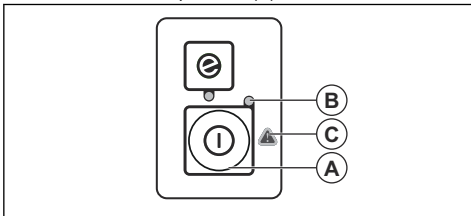

- a) The product is on when the LED (B) is on.
  - b) The product is off when the LED (B) is off.
2. If the warning indicator (C) is on or flashes. Refer to *Keypad on page 22*.

### To do a check of the power trigger lockout

The power trigger lockout is designed to prevent accidental operation. When you press the lock (A) it releases the power trigger (B). When you release the handle, the power trigger and the power trigger lockout

both move back to their original positions. This movement is operated by independent springs.

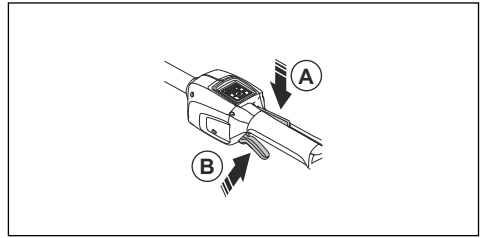

1. Make sure that the power trigger is locked when the lock is in its original position.

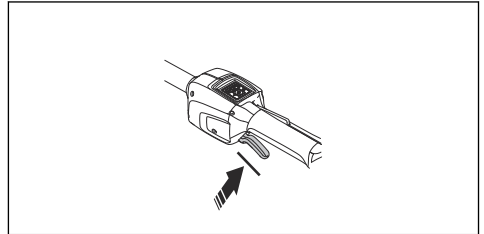

2. Press the power trigger and make sure it returns to its original position when you release it.

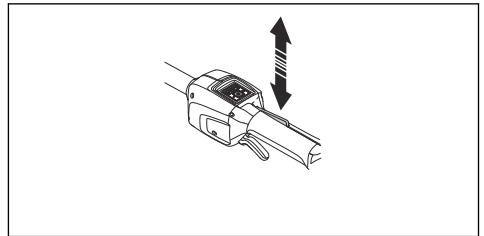

3. Make sure that the power trigger and the lock moves freely and that the return spring works properly.

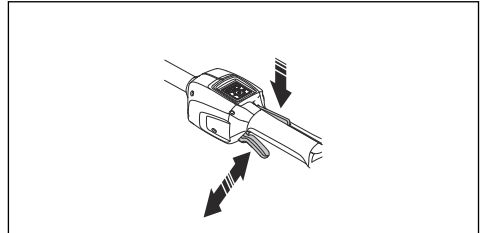

4. Start the product, see *To start the product on page 14*.
5. Apply full throttle.
6. Release the power trigger and make sure that the cutting attachment stops and remains still.

### Cutting attachment guard

The cutting attachment guard prevents a loose object to eject in the direction of the operator.

Examine the cutting attachment guard for damage and replace it if it is damaged. Only use the approved guard for the cutting attachment.

### Safety instructions for the cutting equipment



**WARNING:** Read the warning instructions that follow before you use the product.

- Only use the guide bar/saw chain combinations and filing equipment that we recommend. Refer to *Accessories on page 24* for instructions.
- Use protective gloves when you use or do maintenance on the saw chain. A saw chain that does not move can also cause injuries.
- Keep the cutting teeth correctly sharpened. Obey the instructions and use the recommended file gauge. A saw chain that is damaged or incorrectly sharpened increases the risk of accidents.

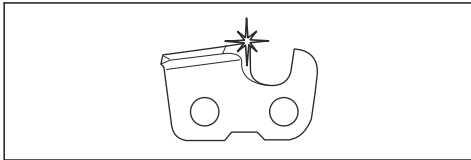

- Keep the correct depth gauge setting. Obey the instructions and use the recommended depth gauge setting. Too large depth gauge setting increases the risk of kickback.

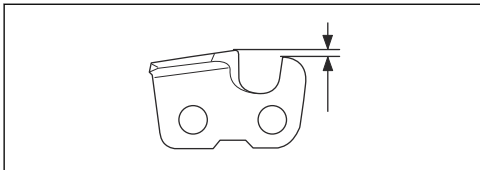

- Make sure that the saw chain has the correct tension. If the saw chain is not tight against the guide bar, the saw chain can derail. An incorrect saw chain tension increases wear on the guide bar, saw chain and chain drive sprocket. Refer to *To tension the chain on page 20*.

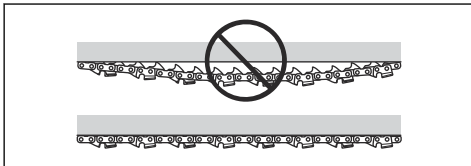

- Do maintenance on the cutting equipment regularly and keep it correctly lubricated. If the saw chain is

not correctly lubricated, the risk of wear on the guide bar, saw chain and chain drive sprocket increases.

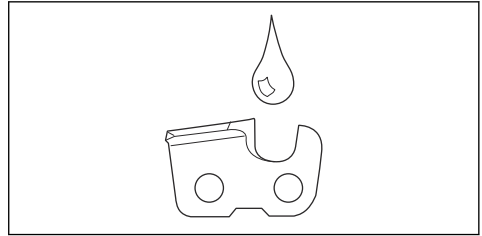

### Battery safety



**WARNING:** Read the warning instructions that follow before you use the product.

- Only use the BLi batteries that we recommend for your product. The batteries are software encrypted.
- Use the BLi batteries that are rechargeable as a power supply for the related Husqvarna products only. To prevent injury, do not use the battery as a power supply for other devices.
- Risk of electrical shock. Do not connect the battery terminals to keys, screws or other metal. This can cause a short circuit of the battery.
- Do not use batteries that are non-rechargeable.
- Do not put objects into the air slots of the battery.
- Keep the battery away from sunlight, heat or open flame. The battery can cause burns and/or chemical burns.
- Keep the battery away from microwaves and high pressure.
- Do not try to disassemble or break the battery.
- Do not let battery acid touch your skin. Battery acid causes injuries to the skin, corrosion and burns. If you get battery acid in your eyes, do not rub but flush with water for minimum 15 minutes. If battery acid has touched your skin, you must clean the skin with a large quantity of water and soap. Get medical aid.
- Use the battery in temperatures between -10 °C (14 °F) and 40 °C (104 °F).
- Do not clean the battery or the battery charger with water. Refer to *To clean the product, the battery and the battery charger on page 21*.
- Do not use a defective or damaged battery.
- Keep batteries in storage away from metal objects such as nails, screws or jewelry.
- Keep the battery away from children.

### Battery charger safety



**WARNING:** Read the warning instructions that follow before you use the product.

- Risk of electrical shock or short circuit if the safety instructions are not obeyed.
- Do not use other battery chargers than the one supplied for your product. Only use chargers when you charge BLi replacement batteries.
- Do not try to disassemble the battery charger.
- Do not use a defective or damaged battery charger.
- Do not lift the battery charger by the power cord. To disconnect the battery charger from a mains socket, pull out the plug. Do not pull the power cord.
- Keep all cables and extension leads away from water, oil and sharp edges. Make sure that the cable is not caught between objects, for example, doors, fences or equivalent.
- Do not use the battery charger near flammable materials or materials that can cause corrosion. Make sure that the battery charger is not covered. Pull out the plug to the battery charger if there is smoke or fire.
- Only charge the battery indoors in a location with good airflow and away from sunlight. Do not charge the battery outdoors. Do not charge the battery in wet conditions.
- Only use the battery charger where the temperature is between 5 °C (41 °F) and 40 °C (104 °F). Use the charger in an environment which has a good airflow, dry and free from dust.
- Do not put objects into the cooling slots of the battery charger.
- Do not connect the battery charger terminals to metal objects as this can short circuit the battery charger.
- Use approved mains sockets that are not damaged. Make sure that the cord of the battery charger is not damaged. If extension cables are used, make sure that the extension cables are not damaged.

## Safety instructions for maintenance



**WARNING:** Read the warning instructions that follow before you do maintenance on the product.

- Remove the battery before you do maintenance, other checks or assemble the product.
- The operator must only do the maintenance and servicing shown in this operator's manual. Turn to your servicing dealer for maintenance and servicing of a larger extension.
- Do not clean the battery or the battery charger with water. Strong detergent can cause damage to the plastic.
- If you do not do maintenance, it decreases the life cycle of the product and increases the risk of accidents.
- Special training is necessary for all servicing and repair work, especially for the safety devices on the product. If not all checks in this operator's manual are approved after you have done maintenance, turn to your servicing dealer. We guarantee that there are professional repairs and servicing available for your product.
- Only use original spare parts.

## Assembly

### Introduction



**WARNING:** Read and understand the safety chapter before you assemble the product.

### To assemble the guide bar and saw chain

1. Remove the bar nut that holds the clutch cover.
2. Adjust the guide bar on the guide bar bolt. Put the guide bar in the rear position. Put the saw chain on the drive sprocket and in the groove on the guide bar. Start on the top side of the guide bar.
3. Make sure that the edges of the cutters point forward on the top edge of the guide bar (C).

4. Align the hole in the guide bar with the chain adjuster pin and install the clutch cover. Make sure that the drive links fit correctly on the chain drive sprocket (B). Make sure that the saw chain is in the groove in the guide bar. Tighten the bar nuts by hand as tightly as you can.

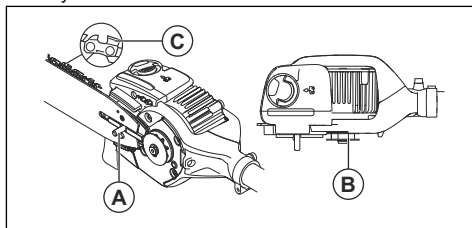

5. Apply tension to the saw chain, refer to *To tension the chain on page 20*.

### To adjust the angle of the saw head



**WARNING:** Stop the product and remove the battery before you continue. Use protective gloves.

1. Loosen the screws on the saw head (A).
2. Turn the saw head (B) 90°.
3. Tighten the screws (A).

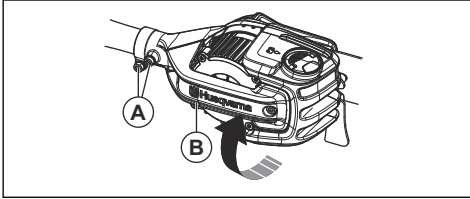

### To assemble the branch hook

- Use 2 screws to attach the branch hook.

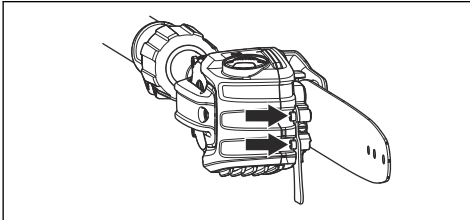

### To assemble the shock guard

1. Use 6 screws to attach the shock guard.

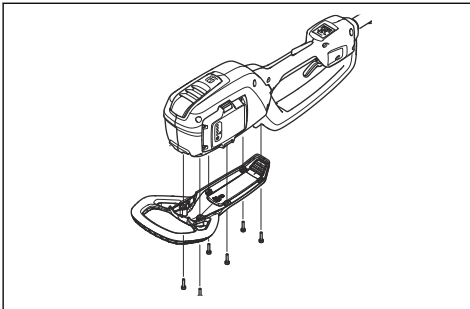

### To adjust the length of the shaft

1. Undo the knob.

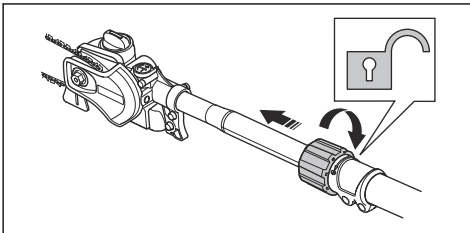

2. Pull out the shaft to the desired length.

3. Tighten the knob.

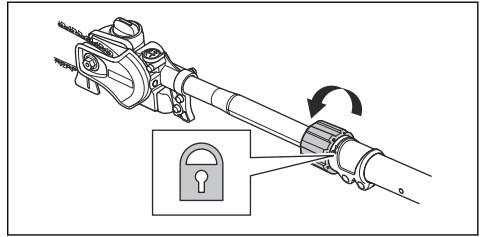

### To adjust the harness

1. Put on the harness.
2. Attach the harness to the harness support hook.
3. Adjust the length of the harness until the harness support hook is in level with your right hip.

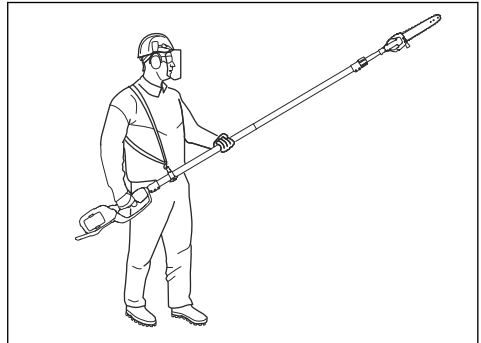

### To connect the battery charger

1. Connect the battery charger to the voltage and frequency that is specified on the rating plate.
2. Put the plug in a grounded socket outlet. The LED on the battery charger flashes green one time.

**Note:** The battery does not charge if the battery temperature is more than 50 °C/122 °F. If the temperature is more than 50 °C/122 °F, the battery charger makes the battery become cool before the battery charges.

### To connect the battery to the product



**WARNING:** Only use Husqvarna original batteries with the product.

1. Make sure that the battery is fully charged.

2. Push the battery into the battery holder of the product. The battery locks into position when you hear a click.

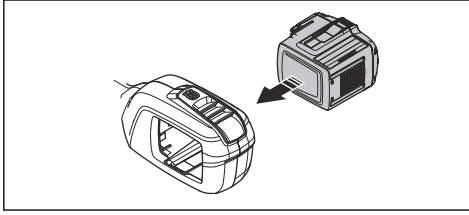

**CAUTION:** If the battery does not move easily into the battery holder, the battery is not installed correctly. This can cause damage to the product.

3. Make sure that the battery is installed correctly.

## Battery information

Refer to the operator's manual of the battery for information about how to use the battery.

## To fill with chain oil

Fill with chain oil after 1 hour of operation or when the battery is empty.

1. Open the chain oil cap on top of the saw head.

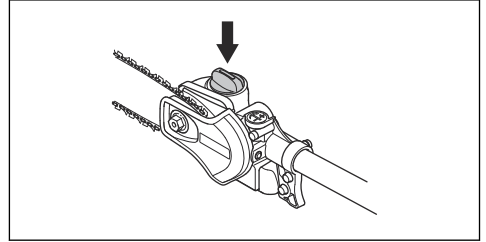

2. Fill with Husqvarna chain oil.
3. Attach the chain oil cap.

## Operation

### Introduction



**WARNING:** Read and understand the safety chapter before you use the product.

### To charge the battery

**Note:** Charge the battery if it is the first time that you use it. A new battery is only 30% charged.

1. Make sure that the battery is dry.
2. Put the battery in the battery charger.

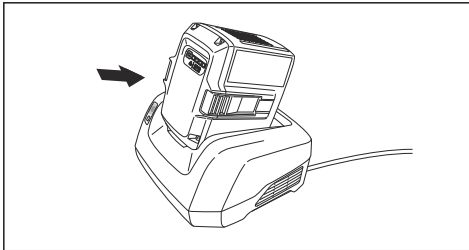

3. Make sure that the green charging light on the battery charger comes on. That means that the battery is connected correctly to the battery charger.

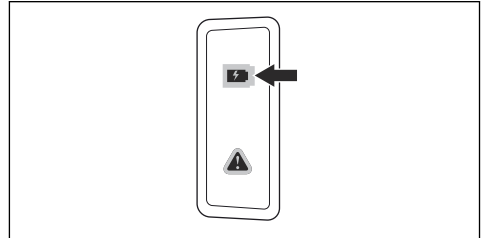

4. When all LEDs on the battery come on, the battery is fully charged.

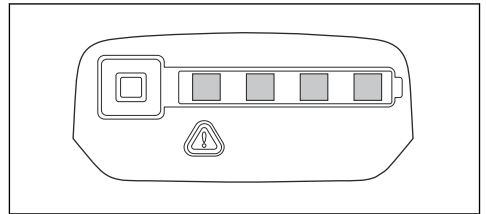

5. To disconnect the battery charger from the mains socket, pull the plug. Do not pull the cable.
6. Remove the battery from the battery charger.

**Note:** Refer to the battery and battery charger manuals for more information.

## To check before starting

1. Inspect the working area. Remove any objects that could be thrown out.
2. Check the saw chain. Never use blunt, cracked or damaged equipment.
3. Check that the product is in perfect working order.
4. Check that all nuts and screws are tight.
5. Make sure the chain is adequately lubricated, refer to *To lubricate cutting equipment on page 21*.
6. Check that the saw chain always stops when the engine is idling.
7. Only use the product for the purpose it was intended for.
8. Make sure the handle and safety features are in order. Never use a machine that has any parts missing or has been modified in relation to the specification.

## To start the product

1. Push and hold the start/stop button until the green LED is on.

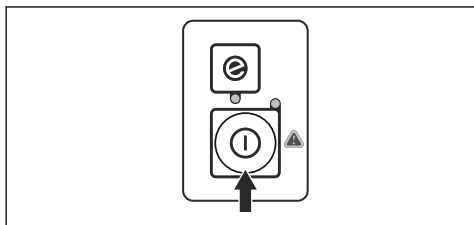

2. Use the power trigger to control the speed.

## To use the SavE function

This product has a power saving function, SavE. The SavE function decreases the chain speed and gives the longest operation time from the battery.

**Note:** The SavE function does not decrease the cutting power of the product.

1. Push the SavE button on the keypad.
2. Make sure that the green LED comes on.
3. Push the SavE button again to disconnect the function. The green LED goes out.

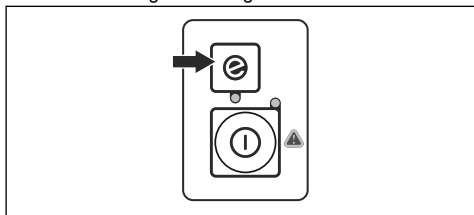

## To stop the product

1. Release the power trigger or the power trigger lockout.
2. Push the start/stop button until the green LED is off.
3. Push the release buttons on the battery and pull the battery out.

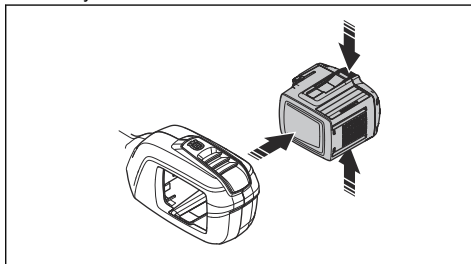

## To use the product



**WARNING:** Do not stay directly below a branch that is being cut. This can result in death or injury.

- Be careful when you operate near overhead power lines. Falling branches can result in short-circuiting.
- If possible, position yourself so that you can make the cut at right angles to the branch.

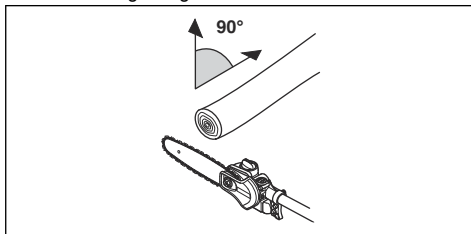

- Cut large branches in sections. Note that falling branches can bounce in the direction of the user after hitting the ground.

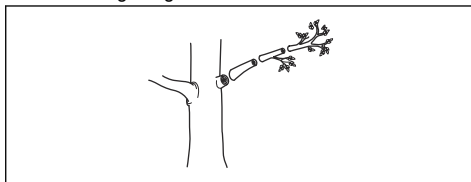

- Never cut through the swelling at the root of the branch as this will slow down healing and increase the risk of fungal attack!

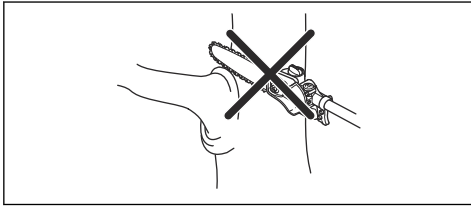

- Use the stop at the base of the cutting head to provide support during cutting. This will help prevent the cutting attachment from "jumping" on the branch.

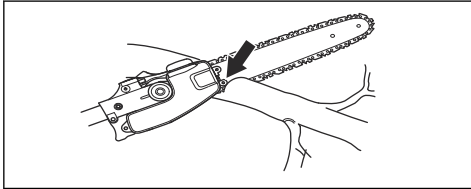

- Make an initial cut on the underside of the branch before cutting through the branch. This will prevent tearing of the bark, which could lead to slow healing and cause permanent damage to the tree. The cut should not be deeper than 1/3 of the branch thickness to prevent jamming. Keep the chain running while you withdraw the cutting attachment from the branch to prevent it jamming.

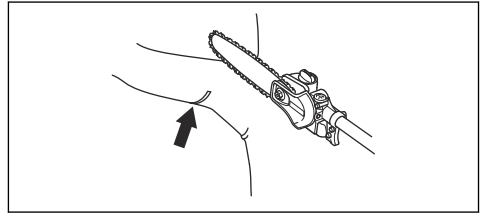

- Make sure you have a firm footing and that you can work without being hampered by branches, stones and trees.



**WARNING:** Never activate the power trigger without having the cutting attachment in full view.

## Maintenance

### Introduction



**WARNING:** Read and understand the safety chapter before you do maintenance work on the product.



**WARNING:** Remove the battery before you do maintenance on the product.

### Maintenance schedule



**WARNING:** Remove the battery before you do maintenance.

The following is a list of the maintenance steps that you must do on the product. Refer to the tasks in the maintenance chapter for more information.

Maintenance	Daily	Weekly	Monthly
Clean the external parts of the product with a dry cloth. Do not use water.	X		
Make sure that the start and stop button works correctly and are not damaged.	X		
Make sure that the power trigger and the power trigger lockout function correctly from a safety point of view.	X		
Make sure that all controls work and are not damaged.	X		
Keep the handles dry and clean. Make sure that there is no oil and grease on the handles.	X		
Make sure that the saw chain cover is not damaged. Replace the saw chain cover if it is damaged.	X		

Maintenance	Daily	Weekly	Monthly
Make sure that the screws and nuts are tight.	X		
Clean the oil tank cap	X		
Make sure that the battery release buttons on the battery works and locks the battery in the product.	X		
Examine that the battery charger is not damaged and function correctly.	X		
Make sure that the battery is not damaged.	X		
Make sure that the battery is charged.	X		
Make sure that the battery charger is not damaged.	X		
Examine all cables, couplings and connections. Make sure that there is no damage or dirt.		X	
Clean the saw chain cover.		X	
Do a check of the connections between the battery and the product. Do a check of the connection between the battery and the battery charger.			X
Make sure that the saw head is not damaged. Replace the saw head if it is damaged.	An approved Husqvarna dealer must do all servicing on the saw head.		
Examine the wear of the chain drive sprocket.	Replace the chain drive sprocket after approximately 100 hours of operation or more frequently if it is necessary.		

## To examine the battery and the battery charger

1. Examine the battery for damages, for example cracks.
2. Examine the battery charger for damages, for example cracks.
3. Make sure that the connection cord of the battery charger is not damaged and that there are no cracks in it.

## To perform maintenance on the attachment

### To check the saw chain

Do a check of the saw chain daily.

1. Make sure that there are no cracks in rivets and links.

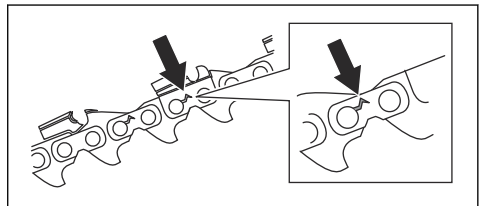

2. Examine if the saw chain is rigid.
3. Compare the saw chain with a new saw chain to examine if the rivets and links are worn.
4. Replace the saw chain if it exhibits any of the conditions above.



- Replace the saw chain when the length of the cutting teeth has worn down to only 4 mm (0.16 in.)

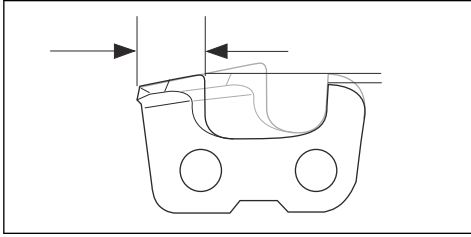

### To examine the chain drive sprocket

- Regularly do a check of the degree of wear on the chain drive sprocket.

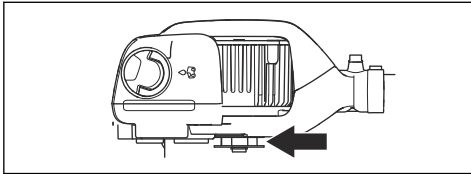

- Replace the chain drive sprocket if it is worn and moves from side to side on the motor axle.

### To do a check of the guide bar

- Make sure that the oil channel is not blocked. Clean if it is necessary.

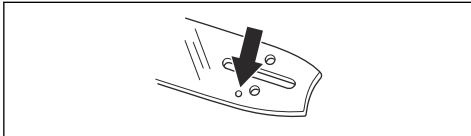

- Examine if there are burrs on the edges of the guide bar. Remove the burrs using a file.

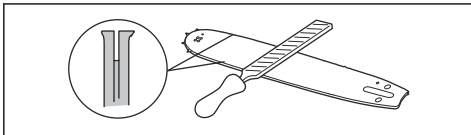

- Clean the groove in the guide bar.

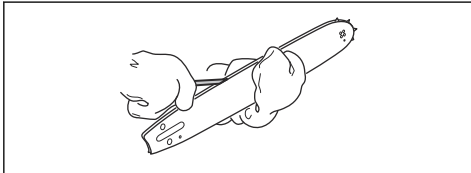

- Examine the groove in the guide bar for wear. Replace the guide bar if it is necessary.

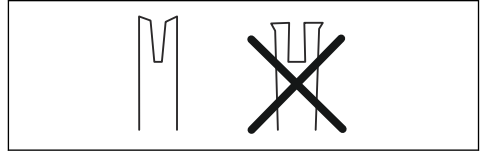

- Examine if the guide bar tip is rough or very worn.

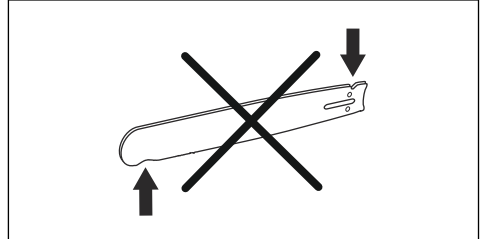

- Make sure that the bar tip sprocket turns freely and that the lubricating hole in the bar tip sprocket is not blocked. Clean and lubricate if it is necessary.

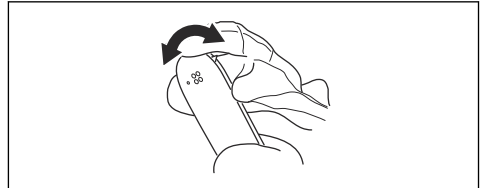

- Turn the guide bar daily to extend its life cycle.

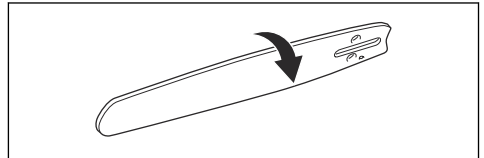

### To sharpen the saw chain

#### Information about the guide bar and saw chain



**WARNING:** Use protective gloves when you use or do maintenance on the saw chain. A saw chain that does not move can also cause injuries.

Replace a worn or damaged guide bar or saw chain with the guide bar and saw chain combination recommended by Husqvarna. This is necessary to keep the safety functions of the product. Refer to *Accessories* on page 24, for a list of replacement bar and chain combinations that we recommend.

- Guide bar length, in/cm. Information about the guide bar length can usually be found on the rear end of the guide bar.

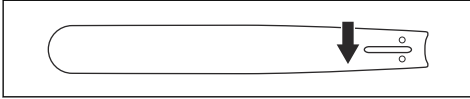

- Number of teeth on bar tip sprocket (T).

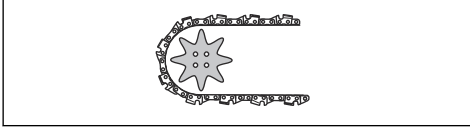

- Chain pitch, in. The distance between the drive links of the saw chain must align with the distance of the teeth on the bar tip sprocket and drive sprocket.

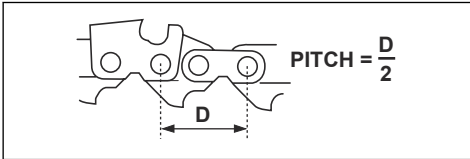

- Number of drive links. The number of drive links is decided by the type of guide bar.

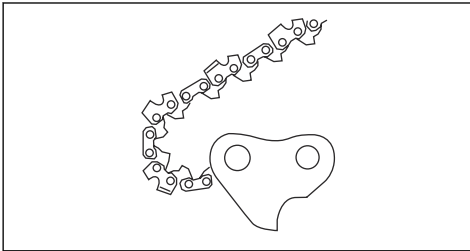

- Bar groove width, in/mm. The groove width in guide bar must be the same as the chain drive links width.

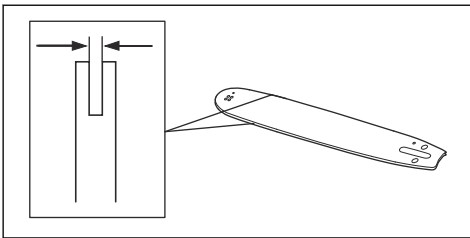

- Chain oil hole and hole for chain tensioner. The guide bar must align with product.

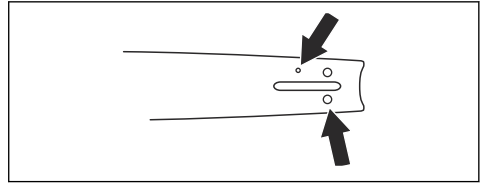

- Drive link width, mm/in.

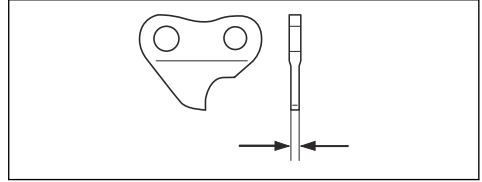

### General information about how to sharpen the cutting teeth

Do not use a blunt saw chain. If the saw chain is blunt, you must apply more pressure to push the guide bar through the wood. If the saw chain is very blunt, there will be no wood chips but sawdust.

A sharp saw chain eats through the wood and the wood chips becomes long and thick.

The cutting tooth (A) and the depth gauge (B) together makes the cutting part of the saw chain, the cutter. The difference in height between the two gives the cutting depth (depth gauge setting).

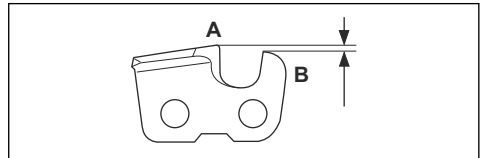

When you sharpen a cutting tooth, think about the following:

- Filing angle.

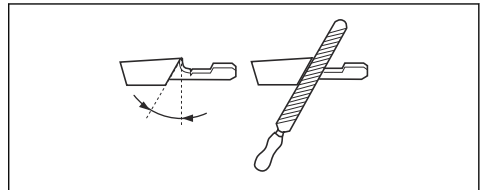

- Cutting angle.

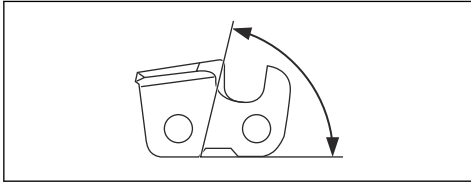

- File position.

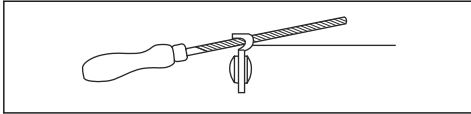

- Round file diameter.

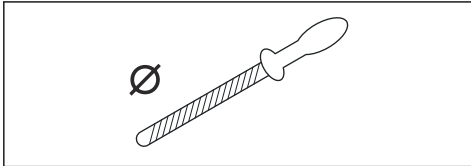

It is not easy to sharpen a saw chain correctly without the correct equipment. Use the recommended file gauge. This will help you to keep maximum cutting performance and the kickback risk at a minimum.



**WARNING:** The risk of kickback increases a lot if you do not follow the sharpening instructions.

**Note:** See *To sharpen the cutting teeth on page 19* for information about sharpening of the saw chain.

## To sharpen the cutting teeth

1. Use a round file and a file gauge to sharpen the cutting teeth.

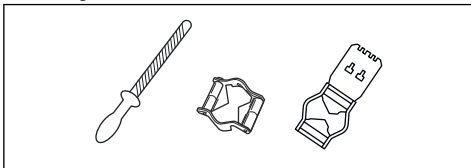

**Note:** See *Accessories on page 24* for information about which file and gauge that we recommend for your saw chain.

2. Make sure that the saw chain has the correct tension. A saw chain without the correct tension moves from side to side. This does not make it easy to sharpen the saw chain. See *To tension the chain on page 20* for instructions.

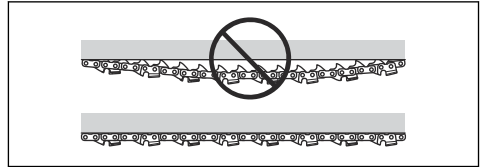

3. Move the file from the inner side of the cutting teeth and out. Decrease the pressure on the pull stroke.

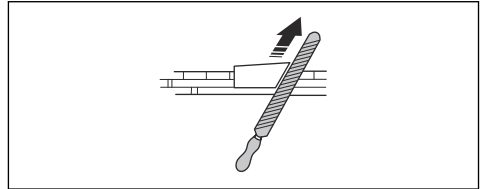

4. Remove filing material on all teeth on one side first.
5. Turn the product around and remove filing material on the other side.
6. Make sure that the all cutting teeth become the same length when you remove filing material.
7. The saw chain is worn out when the cutting teeth is decreased to 4 mm (0.16"). Replace the saw chain.

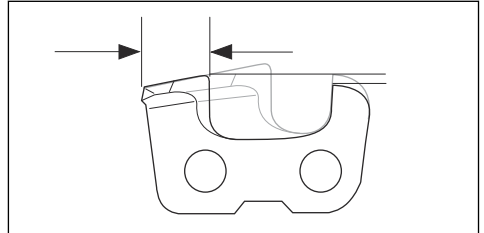

## General information about how to adjust the depth gauge setting

The depth gauge setting (C) decreases when you sharpen the cutting tooth (A). To keep maximum cutting performance you must remove filing material from the depth gauge (B) to receive the recommended depth gauge setting. See *Accessories on page 24* for instructions about how to receive the correct depth gauge setting for your saw chain.

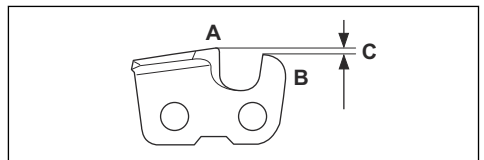



**WARNING:** The risk of kickback increases if the depth gauge setting is too large!

### To adjust the depth gauge setting

Before you adjust the depth gauge setting or sharpen the cutting teeth, See *To sharpen the cutting teeth on page 19*, for instructions. We recommend you to adjust the depth gauge setting after each third operation that you sharpen the cutting teeth.

**Note:** This recommendation applies only if the length of the cutting teeth does not decrease too much.

We recommend that you use our depth gauge tool to receive the correct depth gauge setting and bevel for the depth gauge.

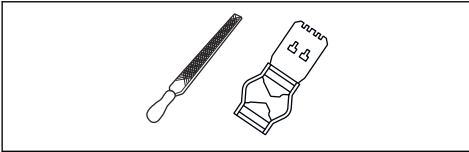

1. Use a flat file and a depth gauge tool to adjust the depth gauge setting. Only use the recommended depth gauge tool to receive the correct depth gauge setting and bevel for the depth gauge.
2. Put the depth gauge tool on the saw chain.

**Note:** See the package of the depth gauge tool for more information about how to use the tool.

3. Use the flat file to remove the part of the depth gauge that extends through the depth gauge tool.

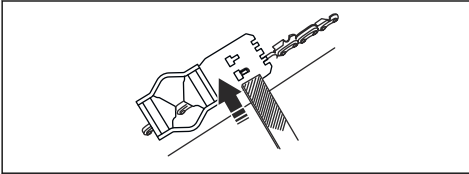

**Note:** The depth gauge setting is correct when you do not feel resistance as you move the file along the depth gauge tool.

### To tension the chain



**WARNING:** A saw chain with an incorrect tension can derail from the guide bar and cause serious injury or death.

A saw chain becomes longer when you use it. Adjust the saw chain regularly.

1. Loosen the bar nut that hold the clutch cover/chain brake. Use a wrench.

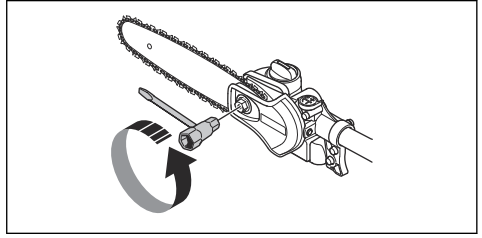

2. Tighten the bar nuts by hand as tightly as you can.
3. Lift the front of the guide bar and turn the chain tensioning screw. Use a wrench.

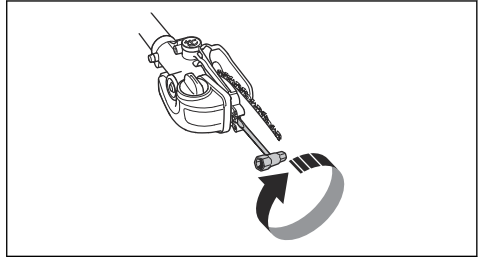

4. Tighten the saw chain until it is tight against the guide bar but still can move easily.
5. Tighten the bar nuts using the wrench and lift the front of the guide bar at the same time.

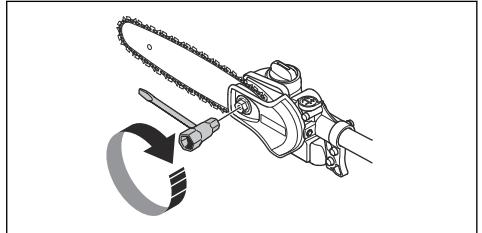

6. Make sure you can pull the saw chain around freely by hand and that it does not hang from the guide bar.

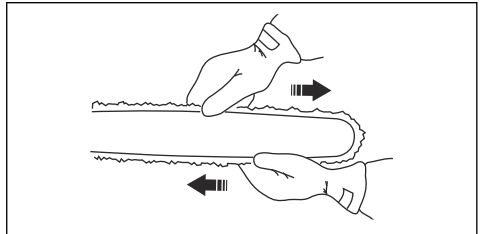

## To lubricate cutting equipment



**WARNING:** Poor lubrication of cutting equipment may cause the chain to snap, which could lead to serious, even fatal injuries.



**WARNING: Do not use waste oil!** Waste oil is dangerous for persons, the product and for the environment.

### Chain oil



**WARNING:** Poor lubrication of cutting equipment may cause the chain to snap, which could lead to serious, even fatal injuries.

- Chain oil must demonstrate good adhesion to the chain and also maintain its flow characteristics regardless of whether it is warm summer or cold winter weather.
- We have developed an optimal chain oil which, with its vegetable oil base, is also biodegradable. We recommend the use of our own oil for both maximum chain life and to minimise environmental damage.
- If our own chain oil is not available, standard chain oil is recommended.
- In areas where oil specifically for lubrication of saw chains is unavailable, ordinary EP 90 transmission oil may be used.
- **Never use waste oil!** This is dangerous for yourself, the machine and the environment.

### To check the chain lubrication

1. Check the chain lubrication each time you refuel. Aim the tip of the bar at a light coloured surface about 20 cm (8 inches) away. After 1 minute running at 75% throttle you should see a distinct line of oil on the light surface.

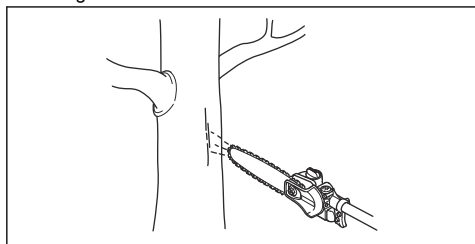

### To do a check if lubrication does not work

1. Check that the oil channel in the bar is not obstructed. Clean if necessary.

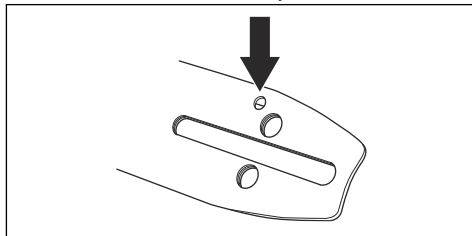

2. Check that the oil channel in the gear housing is clean. Clean if necessary.
3. Check that the bar tip sprocket turns freely. If the chain lubrication system is still not working after carrying out the above checks you should contact your service workshop.

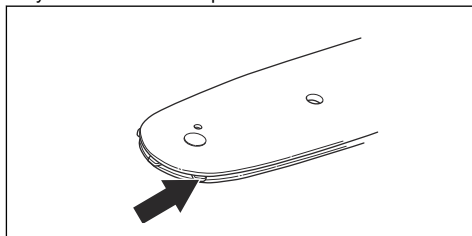

## To replace the chain drive sprocket

1. Remove the bar nut (A) that holds the clutch cover.
2. Remove the clutch cover (B).
3. Disassemble the washer clip (C).
4. Remove the washer (D).
5. Remove the chain drive sprocket (E).

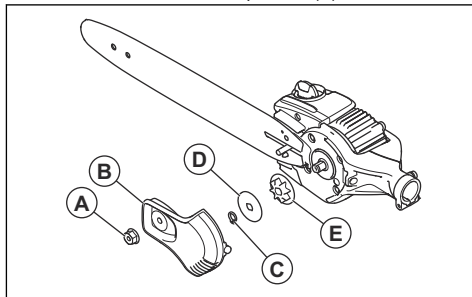

6. Install a new chain drive sprocket.

## To clean the product, the battery and the battery charger

1. Clean the product with a dry cloth after use.
2. Clean the battery and battery charger with a dry cloth. Keep the battery guide tracks clean.

3. Make sure that the terminals on the battery and the battery charger are clean before use.
4. Clean around the oil tank cap with a brush.
5. Clean the inner surface of the protective cover with a brush.

---

## Troubleshooting

---

### Keypad

Problem	Possible faults	Possible solution
Green start LED flashes.	Low battery voltage.	Charge the battery.
Red error LED flashes.	Overload.	The cutting attachment is blocked. stop the product. Remove the battery. Clean the cutting attachment from unwanted materials. Loosen the chain.
	Temperature deviation.	Let the product become cool.
	The power trigger and the start button are pushed at the same time.	Release the power trigger and push the start button.
The product does not start.	Dirt in the battery connectors.	Clean the battery connectors with compressed air or a soft brush.
Red error LED comes on.	It is necessary to do servicing on the product.	Speak to your servicing dealer.

### Battery

LED display	Possible faults	Possible action
Green activate LED flashing	Low battery voltage.	Charge the battery.
Error LED flashing	The battery is discharged.	Charge the battery.
	Temperature deviation.	Use the battery in surroundings where temperatures are between -10°C (14°F) and 40°C (104°F).
Error LED is lit	Cell difference is too much (1V).	Contact your servicing agent.

### Battery charger

Problem	Possible faults	Possible solution
Red error LED flashes.	Temperature deviation.	Use the battery charger in temperatures between 5 °C (41 °F) and 40 °C (104 °F).
Red error LED comes on.		Speak to your servicing dealer.

---

## Transportation, storage and disposal

---

### Transportation and storage

**Note:** Variations in temperature can lead to pressure in the oil tank with temporary oil leakage as a result. Follow the storage instructions.

- **Clean the product and empty the oil tank before you put the product in storage.**
- **Put the product in a horizontal position or hung with the bar pointed down during storage.**
- **Do not put the product with the bar pointed up during storage.**
- The supplied Li-ion batteries obey the Dangerous Goods Legislation requirements.
- Obey the special requirement on package and labels for commercial transportation, including by third parties and forwarding agents.
- Speak to a person with special training in dangerous material before you send the product. Obey all applicable national regulations.
- Use tape on open contacts when you put the battery in a package. Put the battery in the package tightly to prevent movement.
- Remove the battery for storage or transportation.
- Put the battery and the battery charger in a space that is dry and free from moisture and frost.
- Do not keep the battery in an area where static electricity can occur. Do not keep the battery in a metal box.
- Put the battery in storage where the temperature is between 5 °C (41 °F) and 25 °C (77 °F) and away from open sunlight.

- Put the battery charger in storage where the temperature is between 5 °C (41 °F) and 45 °C (113 °F) and away from open sunlight.
- Charge the battery 30% to 50% before you put it in storage for long periods.
- Put the battery charger in storage in a space that is closed and dry.
- Keep the battery away from the battery charger during storage. Do not let children and other not approved persons to touch the equipment. Keep the equipment in a space that you can lock.
- Use the transportation guard on the product to prevent injuries or damage on the product during transportation and storage.
- Attach the product safely during transportation.

### Disposal of the battery, battery charger and product

The symbol below means that the product is not domestic waste. Recycle it at a recycling station for electrical and electronic equipment. This helps to prevent damage to the environment and to persons.

Speak to local authorities, domestic waste service or your dealer for more information.

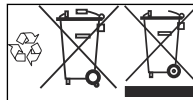

**Note:** The symbol shows on the product or package of the product.

---

## Technical data

---

### Technical data

	530IP4	530IPT5
<b>Motor</b>		
Motor type	BLDC (brushless) 36 V	
Chain speed, m/s (1/4)	18	18
Oil tank capacity, l/cm <sup>3</sup>	0.15/150	0.15/150
<b>Weight</b>		
Weight without battery, kg	3.4	5
<b>Water protection level</b>		

	<b>530iP4</b>	<b>530iPT5</b>
IPX4 <sup>1</sup>	Yes	Yes
<b>Noise emissions</b>		
Sound power level, measured dB(A)	98	98
Sound power level, guaranteed L <sub>WA</sub> dB(A)	98	98
<b>Sound levels<sup>2</sup></b>		
Equivalent sound pressure level at the operator's ear, measured according to EN ISO 22868, dB(A), min./max.:	88	83
<b>Vibration levels<sup>3</sup></b>		
Equivalent vibration levels (a <sub>hveq</sub> ) at handles, measured according to EN ISO 22867, m/s <sup>2</sup>		
Extended shaft, front/rear handles	1.0/0.9	1.0/1.2
Short shaft front/rear handle	-	1.4/1.2

---

## Accessories

---

### Approved batteries

Only use original BLi batteries for this product.

### Approved battery chargers for the product

Battery charger	QC330	QC500
Mains voltage, V	100-240	100-240
Frequency, Hz	50-60	50-60
Power, W	330	500

### Guide bar and saw chain combinations

The following combinations are CE approved.

Guide bar			Saw chain	
Length, in	Pitch, in	Gauge, mm	Type	Length, drive links, no.
10	1/4	1.3	Husqvarna H00	58
12				64

<sup>1</sup> The Husqvarna Handheld Battery products marked with IPX4 fulfils these requirements on product approval level

<sup>2</sup> Reported data for equivalent sound pressure level for the machine has a typical statistical dispersion (standard deviation) of 1 dB (A).







<sup>3</sup> Reported data for equivalent vibration level has a typical statistical dispersion (standard deviation) of 2 m/s<sup>2</sup>.

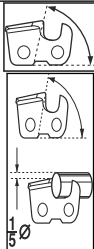
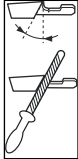

## Saw chain filing and file gauge

Use the recommended file gauge to get the correct filing angles. We recommend you to always use the recommended file gauge to restore the sharpness of the saw chain.

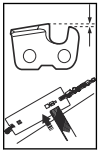
If you do not know which saw chain you have on your product, speak to your servicing dealer.

	 mm/in	 80°	 30°	 0°	 mm/in	 5056981-03	 5806875-01
37	4.0 / 5/32	80°	30°	0°	0.65/0.025	5056981-03	5806875-01

---

# EC Declaration of Conformity

---

## EC Declaration of Conformity

**Husqvarna AB**, SE-561 82 Huskvarna, Sweden, tel: +46-36-146500, declares that the pole pruner

**Husqvarna 530iP4, 530iPT5** with serial numbers dating 2018 and onwards (the year is clearly stated on the rating plate, followed by the serial number), comply with the requirements of the COUNCIL'S DIRECTIVE:

- of May 17, 2006 "relating to machinery" **2006/42/EC**
- of February 26, 2014 "relating to electromagnetic compability" **2014/30/EU**
- of June 8, 2011 "restriction of use of certain hazardous substances" **2011/65/EU**

The following standards have been applied:

**EN 60745-1:2009 + A11:2010, EN ISO 11680-1:2011, EN ISO 14982:2009, CISPR12:2007+amd1 2009, EN 50581:2012**

Notified body (0404): RISE SMP, Svensk Maskinprovning AB, Box 7035, SE-750 07, Uppsala, Sweden, has carried out EC type examination in accordance with the machinery directive's (2006/42/EC) article 12, clause 3b. The certificates for EC type examination have the numbers: **0404/19/2530**.

Huskvarna 2019-04-11



Pär Martinsson, Development Manager (Authorized representative for Husqvarna AB and responsible for technical documentation)





[www.husqvarna.com](http://www.husqvarna.com)

Original instructions

1140373-26



2019-06-06

## Free Manuals Download Website

<http://myh66.com>

<http://usermanuals.us>

<http://www.somanuals.com>

<http://www.4manuals.cc>

<http://www.manual-lib.com>

<http://www.404manual.com>

<http://www.luxmanual.com>

<http://aubethermostatmanual.com>

Golf course search by state

<http://golfingnear.com>

Email search by domain

<http://emailbydomain.com>

Auto manuals search

<http://auto.somanuals.com>

TV manuals search

<http://tv.somanuals.com>