

Operator's manual **357XP 359**

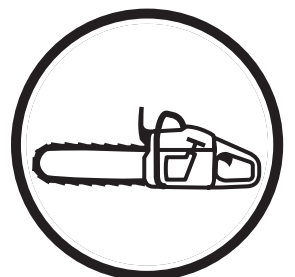

Please read the operator's manual carefully and make sure you understand the instructions before using the machine.

English

KEY TO SYMBOLS

Key to symbols

WARNING! Chain saws can be dangerous! Careless or incorrect use can result in serious or fatal injury to the operator or others.



Please read the operator's manual carefully and make sure you understand the instructions before using the machine.



Always wear:

- Approved protective helmet
- Approved hearing protection
- Protective goggles or a visor



This product is in accordance with applicable EC directives.



Noise emission to the environment according to the European Community's Directive. The machine's emission is specified in chapter Technical data and on label.



Other symbols/decals on the machine refer to special certification requirements for certain markets.

Switch off the engine by moving the stop switch to the STOP position before carrying out any checks or maintenance.

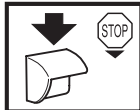

Always wear approved protective gloves.

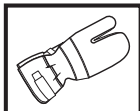

Regular cleaning is required.

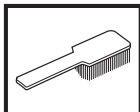

Visual check.



Protective goggles or a visor must be worn.



Refuelling.

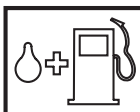

Filling with oil and adjusting oil flow.



If your machine bears this symbol it is equipped with carburettor heating.

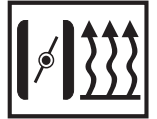

If your machine bears this symbol it is equipped with a catalytic converter.

E-tech

CONTENTS

Contents

KEY TO SYMBOLS

Key to symbols 2

CONTENTS

Contents 3

Before using a new chain saw 3

SAFETY INSTRUCTIONS

Personal protective equipment 4

Machine's safety equipment 4

Checking, maintaining and servicing the machine's safety equipment 7

Cutting equipment 9

How to avoid kickback 15

General safety precautions 16

General working instructions 18

WHAT IS WHAT?

What is what on the chain saw? 24

ASSEMBLY

Fitting the bar and chain 25

FUEL HANDLING

Fuel 26

The following applies to chain saws with catalytic converters: 26

Chain oil 27

Fuelling 27

STARTING AND STOPPING

Starting and stopping 28

MAINTENANCE

Carburettor 30

Starter 31

Air filter 32

Spark plug 32

Muffler 33

Needle bearing lubrication 33

Adjustment of the oil pump 33

Cooling system 34

"Air Injection" centrifugal cleaning 34

Heated handles 34

Electrical carburettor heating 34

Winter use 34

Daily maintenance 35

Weekly maintenance 35

Monthly maintenance 35

TECHNICAL DATA

Technical data 36

EC-declaration of conformity 38

Before using a new chain saw

- Please read the operator's manual carefully.
- Check that the cutting equipment is correctly fitted and adjusted. See instructions under the heading Assembly.
- Refuel, start the chain saw and check the carburettor settings. See the instructions under the headings Fuel Handling, Starting and Stopping, and Carburettor.
- Do not use the chain saw until sufficient chain oil has reached the chain. See instructions under the heading Lubricating cutting equipment.

IMPORTANT! If the carburettor mixture is too lean it greatly increases the risk of engine failure. Poor maintenance of the air filter will cause carbon build-up on the spark plug and lead to starting difficulties. If the chain is improperly adjusted it will cause increased wear or damage to the bar, drive sprocket and chain.



WARNING! Under no circumstances may the design of the machine be modified without the permission of the manufacturer. Always use genuine accessories. Non-authorized modifications and/or accessories can result in serious personal injury or the death of the operator or others.



WARNING! A chain saw is a dangerous tool if used carelessly or incorrectly and can cause serious, even fatal injuries. It is very important that you read and understand the contents of this operator's manual.



WARNING! The inside of the muffler contain chemicals that may be carcinogenic. Avoid contact with these elements in the event of a damaged muffler.



WARNING! Long term inhalation of the engine's exhaust fumes, chain oil mist and dust from sawdust can represent a health risk.

Husqvarna AB has a policy of continuous product development and therefore reserves the right to modify the design and appearance of products without prior notice.

SAFETY INSTRUCTIONS

Personal protective equipment



WARNING! Most chain saw accidents happen when the chain touches the operator.

You must use approved personal protective equipment whenever you use the machine. Personal protective equipment cannot eliminate the risk of injury but it will reduce the degree of injury if an accident does happen. Ask your dealer for help in choosing the right equipment.



WARNING! Long or continuous exposure to high noise levels may cause permanent hearing impairment. Always wear approved hearing protection when operating a chain saw.

- Protective helmet
- Hearing protection
- Protective goggles or a visor

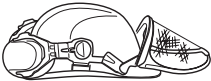

- Gloves with saw protection



- Protective trousers with saw protection

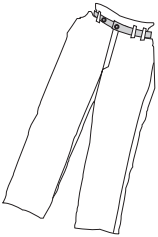

- Boots with saw protection, steel toe-cap and non-slip sole



Generally clothes should be close-fitting without restricting your freedom of movement.

- Always have a first aid kit nearby.



Machine's safety equipment

This section describes the machine's safety equipment, its purpose, and how checks and maintenance should be carried out to ensure that it operates correctly. See the "What is what?" section to locate where this equipment is positioned on your machine.



WARNING! Never use a machine that has faulty safety equipment! Carry out the inspection, maintenance and service routines listed in this section.

- Chain brake and front hand guard

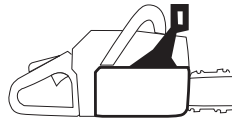

- Throttle lock

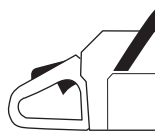

- Chain catcher

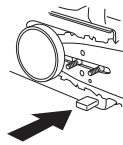

- Right hand guard

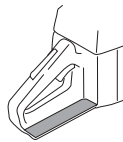

- Vibration damping system



- Stop switch

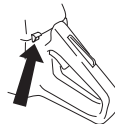

- Muffler

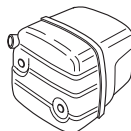

SAFETY INSTRUCTIONS

- Cutting equipment. See instructions under the heading Cutting equipment.

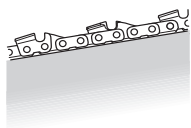

Chain brake and front hand guard

Your chain saw is equipped with a chain brake that is designed to stop the chain immediately if you get a kickback. The chain brake reduces the risk of accidents, but only you can prevent them.

Take care when using your saw and make sure the kickback zone of the bar never touches any object.

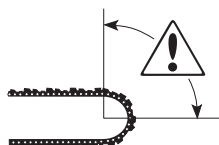

- The chain brake (A) can either be activated manually (by your left hand) or automatically by the inertia release mechanism (a pendulum that swings independently of the chain saw. On most of our models the front hand guard acts as a counterweight in case of kickback).

The brake is applied when the front hand guard (B) is pushed forwards.

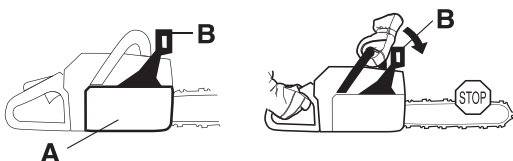

This movement activates a spring-loaded mechanism that tightens the brake band (C) around the engine drive system (D) (clutch drum).

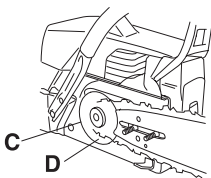

- The front hand guard is not designed solely to activate the chain brake. Another important feature is that it reduces the risk of the chain hitting your left hand if you lose grip of the front handle.

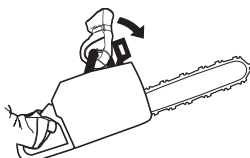

- The chain brake must be engaged when the chain saw is started.



- You can also use the chain brake as a temporary brake when you change position or if you put the chain saw down for a short time! Apart from the fact that a chain saw with a chain brake greatly reduces the risk of accidents due to kickback, you should also apply the chain brake manually if there is a risk of the chain accidentally hitting anyone or anything close by.

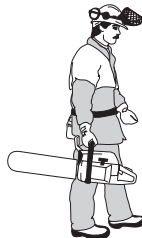

- To release the chain brake pull the front hand guard backwards, towards the front handle.



- Kickback can be very sudden and violent. Most kickbacks are minor and do not always activate the chain brake. If this happens you should hold the chain saw firmly and not let go.



- The way the chain brake is activated, either manually or automatically by the inertia release mechanism, depends on the force of the kickback and the position of the chain saw in relation to the object that the kickback zone of the bar strikes.

If you get a violent kickback while the kickback zone of the bar is farthest away from you the chain brake will be activated by the movement of the counterweight (inertia activated) in the kickback direction.



If the kickback is less violent or the kickback zone of the bar is closer to you the chain brake will be activated manually by the movement of your left hand.

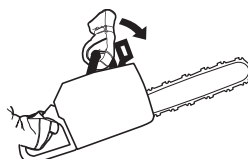

- During felling your left hand grasps the front handle in such a way that it cannot activate the chain brake. In this position, i.e. when your left hand is in such a position that

SAFETY INSTRUCTIONS

it cannot affect the movement of the front hand guard, the chain brake can only be activated by the inertia of the counterweight.



- The inertia activated chain brake is a valuable feature but there are certain factors to remember (see point above).

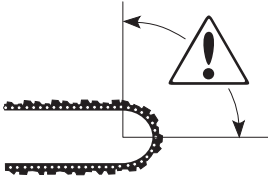

Throttle lock

The throttle lock is designed to prevent accidental operation of the throttle control. When you press the lock (A) (i.e. when you grasp the handle) it releases the throttle control (B). When you release the handle the throttle control and the throttle lock both move back to their original positions. This movement is controlled by two independent return springs. This arrangement means that the throttle control is automatically locked at the idle setting.

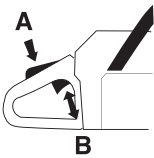

Chain catcher

The chain catcher is designed to catch the chain if it snaps or jumps off. This should not happen if the chain is properly tensioned (see instructions under the heading Assembly) and if the bar and chain are properly serviced and maintained (see instructions under the heading General working instructions).

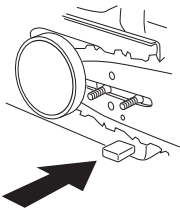

Right hand guard

Apart from protecting your hand if the chain jumps or snaps, the right hand guard stops branches and twigs from interfering with your grip on the rear handle.

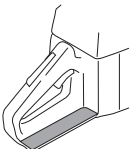

Vibration damping system

Your machine is equipped with a vibration damping system that is designed to minimize vibration and make operation easier.



When you use a chain saw, vibration is generated by the uneven contact between the chain and the wood you are cutting.

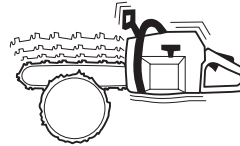

Cutting hardwoods (most broadleaf trees) creates more vibration than cutting softwoods (most conifers). Cutting with cutting equipment that is blunt or faulty (wrong type or badly sharpened) will increase the vibration level. See instructions under the heading Cutting equipment.

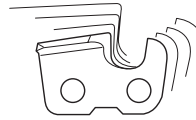

The machine's vibration damping system reduces the transfer of vibration between the engine unit/cutting equipment and the machine's handle unit. The body of the chain saw, including the cutting equipment, is insulated from the handles by vibration damping units.

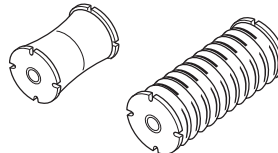

WARNING! Overexposure to vibration can lead to circulatory damage or nerve damage in people who have impaired circulation. Contact your doctor if you experience symptoms of overexposure to vibration. Such symptoms include numbness, loss of feeling, tingling, pricking, pain, loss of strength, changes in skin colour or condition. These symptoms normally appear in the fingers, hands or wrists. The risk increases at low temperatures.

Stop switch

Use the stop switch to switch off the engine.

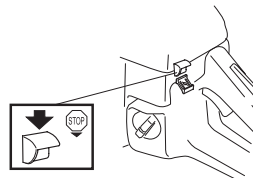

SAFETY INSTRUCTIONS

Muffler

The muffler is designed to keep noise levels to a minimum and to direct exhaust fumes away from the user.

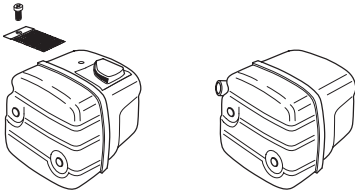

WARNING! The exhaust fumes from the engine are hot and may contain sparks which can start a fire. Never start the machine indoors or near combustible material!

In areas with a hot, dry climate there is a high risk of fires. These areas are sometimes controlled by legislation and requirements that among other things the muffler must be equipped with an approved type of spark arrestor mesh.

For mufflers it is very important that you follow the instructions on checking, maintaining and servicing your machine. See instructions under the heading Checking, maintaining and servicing the machine's safety equipment.



WARNING! The muffler gets very hot in use and remains so for a short time afterwards. Do not touch the muffler if it is hot!



WARNING! The catalytic converter muffler gets very hot during and after use. This also applies during idling. Be aware of the fire hazard, especially when working near flammable substances and/or vapours.

Checking, maintaining and servicing the machine's safety equipment



WARNING! All servicing and repair work on the machine requires special training. This is especially true of the machine's safety equipment. If your machine fails any of the checks described below you must contact your service agent. When you buy any of our products we guarantee the availability of professional repairs and service. If the retailer who sells your machine is not a servicing dealer, ask him for the address of your nearest service agent.

Chain brake and front hand guard

Checking brake band wear

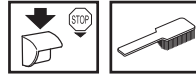

Brush off any wood dust, resin and dirt from the chain brake and clutch drum. Dirt and wear can impair operation of the brake.

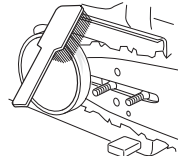

Regularly check that the brake band is at least 0.6 mm thick at its thinnest point.

Checking the front hand guard

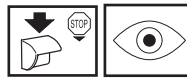

Make sure the front hand guard is not damaged and that there are no visible defects such as cracks.

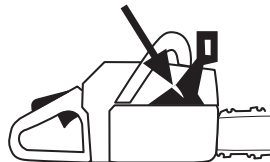

Move the front hand guard forwards and back to make sure it moves freely and that it is securely anchored to the clutch cover.



Checking the inertia brake release



Hold the chain saw over a stump or other firm object. Let go of the front handle so that the bar drops towards the stump as the chain saw rotates around the rear handle.



When the bar hits the stump the brake should be applied.

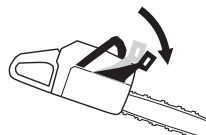

SAFETY INSTRUCTIONS

Checking the brake trigger

Place the chain saw on firm ground and start it. Make sure the chain does not touch the ground or any other object. See the instructions under the heading Start and stop.

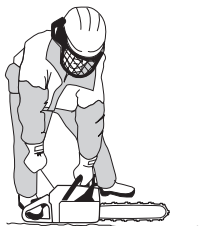

Grasp the chain saw firmly, wrapping your fingers and thumbs around the handles.



Apply full throttle and activate the chain brake by tilting your left wrist forward onto the front hand guard. Do not let go of the front handle. **The chain should stop immediately.**



Throttle lock



- Make sure the throttle control is locked at the idle setting when the throttle lock is released.

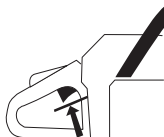

- Press the throttle lock and make sure it returns to its original position when you release it.

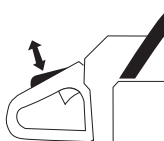

- Check that the throttle control and throttle lock move freely and that the return springs work properly.

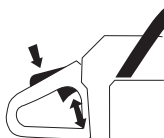

- Start the chain saw and apply full throttle. Release the throttle control and check that the chain stops and remains stationary. If the chain rotates when the throttle control is in the idle position you should check the carburettor idle adjustment.

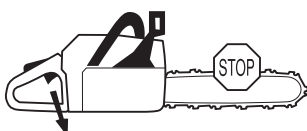

Chain catcher

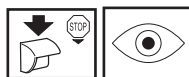

Check that the chain catcher is not damaged and is firmly attached to the body of the chain saw.

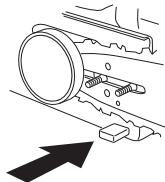

Right hand guard

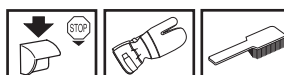

Check that the right hand guard is not damaged and that there are no visible defects, such as cracks.

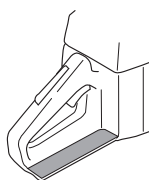

Vibration damping system

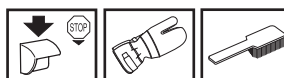

Regularly check the vibration damping units for cracks or deformation.



Make sure the vibration damping units are securely attached to the engine unit and handle unit.

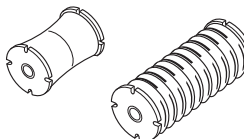

Stop switch



Start the engine and make sure the engine stops when you move the stop switch to the stop setting.

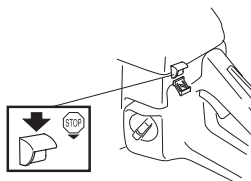

SAFETY INSTRUCTIONS

Muffler



Never use a machine that has a faulty muffler.



Regularly check that the muffler is securely attached to the machine.

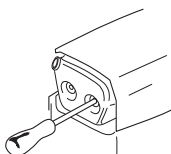

If the muffler on your machine is fitted with a spark arrestor mesh this must be cleaned regularly. A blocked mesh will cause the engine to overheat and may lead to serious damage.

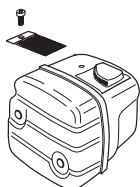

Never use a muffler if the spark arrestor mesh is missing or defective.



WARNING! Never use a machine with faulty safety equipment. The machine's safety equipment must be checked and maintained as described in this section. If your machine fails any of these checks contact your service agent to get it repaired.

Cutting equipment

This section describes how to choose and maintain your cutting equipment in order to:

- Reduce the risk of kickback.
- Reduce the risk of the chain breaking or jumping.
- Obtain maximum cutting performance.
- Extend the life of cutting equipment.

General rules

- **Only use cutting equipment recommended by us!** See the Technical data section.

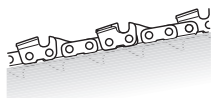

- **Keep the chain's cutting teeth properly sharpened! Follow our instructions and use the recommended file gauge.** A damaged or badly sharpened chain increases the risk of accidents.



- **Maintain the correct raker clearance! Follow our instructions and use the recommended raker gauge.** Too large a clearance increases the risk of kickback.



- **Keep the chain properly tensioned!** If the chain is slack it is more likely to jump off and lead to increased wear on the bar, chain and drive sprocket.



- **Keep cutting equipment well lubricated and properly maintained!** A poorly lubricated chain is more likely to break and lead to increased wear on the bar, chain and drive sprocket.



Cutting equipment designed to minimise kickback



WARNING! Faulty cutting equipment or the wrong combination of bar and chain increases the risk of kickback! Use only the bar and chain combinations that we recommend. See the Technical data section.

The only way to avoid kickback is to make sure that the kickback zone of the bar never touches anything.

By using cutting equipment with "built-in" kickback reduction and keeping the chain sharp and well-maintained you can reduce the effects of kickback.

Bar

The smaller the tip radius the smaller the kickback zone and the lower the chance of kickback.

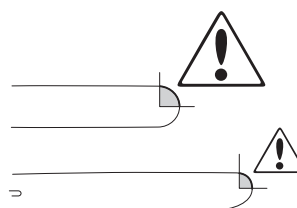

SAFETY INSTRUCTIONS

Chain

A chain is made up of a number of links, which are available in standard and low-kickback versions.

	None	Standard	Low-kickback
Cutting link			
Drive link			
Side link			

Combining these links in different ways gives different degrees of kickback reduction. In terms of kickback reduction alone, four different types of link are available.

Level of kickback reduction

	Cutting link	Drive link	Side link
Low			
Standard			
High			
Extra high			

Some terms that describe the bar and chain

When the cutting equipment supplied with your saw becomes worn or damaged you must replace it with one of the bars and chains recommended by us. See the Technical data section.

Bar

- Length (inches/cm)

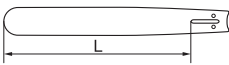

- Number of teeth on bar tip sprocket (T). Small number = small tip radius = low risk of kickback.



- Chain pitch (inches). The spacing between the drive links of the chain must match the spacing of the teeth on the bar tip sprocket and drive sprocket.

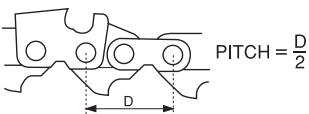

- Number of drive links. The number of drive links is determined by the length of the bar, the chain pitch and the number of teeth on the bar tip sprocket.

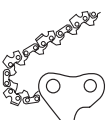

- Bar groove width (inches/mm). The groove in the bar must match the width of the chain drive links.



- Chain oil hole and hole for chain tensioner. The bar must be matched to the chain saw design.

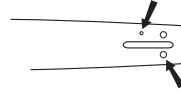

Chain

- Chain pitch (inches)

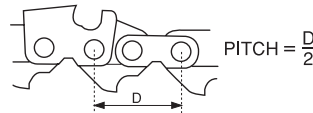

- Drive link width (mm/inches)

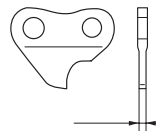

- Number of drive links.



- Level of kickback reduction. The level of kickback reduction offered by a chain is only indicated by its model number. See the Technical data section to find the model numbers of chains that are recommended for use with your model of chain saw.

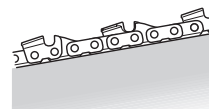

Sharpening your chain and adjusting raker clearance



WARNING! The risk of kickback is increased with a badly sharpened chain!

General information on sharpening cutting teeth

- Never use a blunt chain. When the chain is blunt you have to exert more pressure to force the bar through the wood and the cuttings will be very small. If the chain is very blunt it will not produce any cuttings at all. Wood powder would be the only result.
- A sharp chain eats its way through the wood and produces long, thick cuttings.

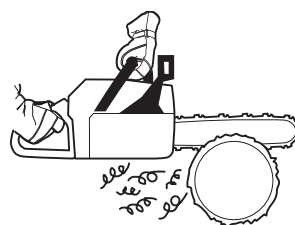

SAFETY INSTRUCTIONS

- The cutting part of the chain is called the cutting link and this consists of a cutting tooth (A) and the raker lip (B). The cutting depth is determined by the difference in height between the two.

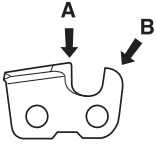

When you sharpen a cutting tooth there are five important factors to remember.

1 Filing angle

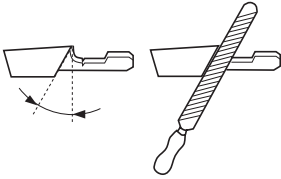

2 Cutting angle

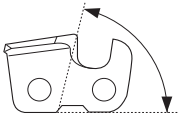

3 File position

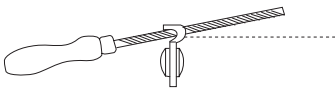

4 Round file diameter

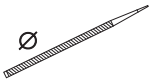

5 File depth

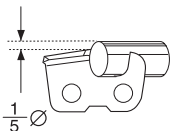

It is very difficult to sharpen a chain correctly without the right equipment. We recommend that you use our file gauge. This will help you obtain the maximum kickback reduction and cutting performance from your chain.

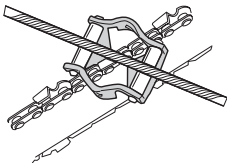

See the Technical data section for information about sharpening your chain.



WARNING! The following faults will increase the risk of kickback considerably:

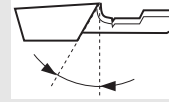

File angle too large

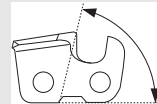

Cutting angle too small

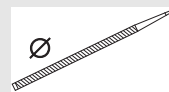

File diameter too small

Sharpening cutting teeth

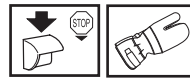

To sharpen cutting teeth you will need a round file and a file gauge. See the Technical data section for information on the size of file and gauge that are recommended for the chain fitted to your chain saw.

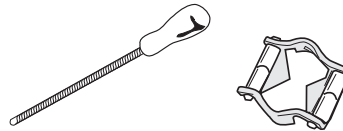

- Check that the chain is correctly tensioned. A slack chain will move sideways, making it more difficult to sharpen correctly.



- Always file cutting teeth from the inside face. Reduce the pressure on the return stroke. File all the teeth on one side first, then turn the chain saw over and file the teeth on the other side.

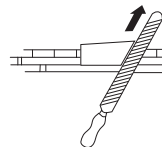

- File all the teeth to the same length. When the length of the cutting teeth is reduced to 4 mm (0.16") the chain is worn out and should be replaced.

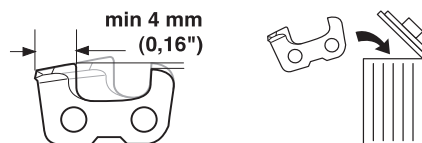

SAFETY INSTRUCTIONS

General advice on setting raker clearance

- When you sharpen the cutting teeth you reduce the raker clearance (=cutting depth). To maintain optimal cutting performance you must file back the raker lip to the recommended height.

See the Technical data section to find the raker clearance for your particular chain.

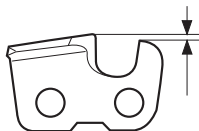

- On a low-kickback cutting link the front edge of the raker lip is rounded. It is very important that you maintain this radius or bevel when you adjust the raker clearance.



- We recommend that you use our raker gauge to achieve the correct clearance and bevel on the raker lip.

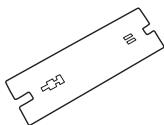

WARNING! The risk of kickback is increased if the raker clearance is too large!

Setting the raker clearance



- Before setting the raker clearance the cutting teeth should be newly sharpened. We recommend that you adjust the raker clearance every third time you sharpen the chain. NOTE! This recommendation assumes that the length of the cutting teeth is not reduced excessively.
- To adjust the raker clearance you will need a flat file and a raker gauge.

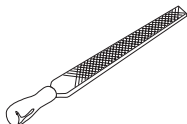

- Place the gauge over the raker lip.

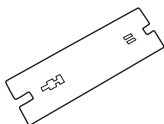

- Place the file over the part of the lip that protrudes through the gauge and file off the excess. The clearance is correct when you no longer feel any resistance as you draw the file over the gauge.

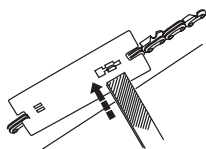

Tensioning the chain



WARNING! A slack chain may jump off and cause serious or even fatal injury.

The more you use a chain the longer it becomes. It is therefore important to adjust the chain regularly to take up the slack.

Check the chain tension every time you refuel. NOTE! A new chain has a running-in period during which you should check the tension more frequently.

The position of the chain tensioning screw on our chain saws varies from model to model. See the What is what? section to find out where it is on your model.

Tension the chain as tightly as possible, but not so tight that you cannot pull it round freely by hand.

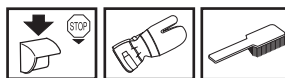
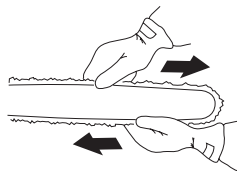

- Undo the bar nuts that hold the clutch cover/chain brake. Use the combination spanner. Then tighten the bar nuts by hand as tight as you can.

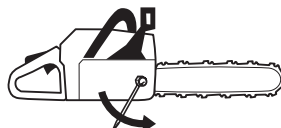

- Raise the tip of the bar and stretch the chain by tightening the chain tensioning screw using the combination spanner. Tighten the chain until it does not sag from the underside of the bar.

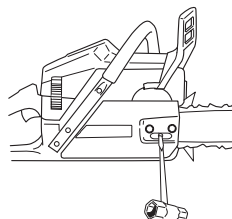

- Use the combination spanner to tighten the bar nuts while lifting the tip of the bar at the same time. Check that you can pull the chain round freely by hand and that it does not sag from the underside of the bar.



SAFETY INSTRUCTIONS

Lubricating cutting equipment



WARNING! Poor lubrication of cutting equipment may cause the chain to snap, which could lead to serious, even fatal injuries.

Chain oil

Chain oil must demonstrate good adhesion to the chain and also maintain its flow characteristics regardless of whether it is warm summer or cold winter weather.

As a chain saw manufacturer we have developed an optimal chain oil which, with its vegetable oil base, is also biodegradable. We recommend the use of our own oil for both maximum chain life and to minimise environmental damage. If our own chain oil is not available, standard chain oil is recommended.

In areas where oil specifically for lubrication of saw chains is unavailable, ordinary EP 90 transmission oil may be used.

Never use waste oil! This is dangerous for yourself, the machine and the environment.

Filling with chain oil

- All our chain saws have an automatic chain lubrication system. On some models the oil flow is also adjustable.

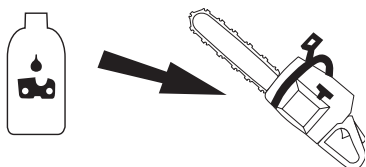

- The sizes of the chain oil tank and fuel tank have been chosen so that the engine will run out of fuel before running out of oil. This means that you should never run with a dry chain.

However, this safety feature requires that you use the right sort of chain oil (if the oil is too thin it will run out before the fuel), and that you adjust the carburettor as recommended (a weak mixture may mean that the fuel lasts longer than the oil) and that you also use the recommended cutting equipment (a bar that is too long will use more chain oil). The above conditions also apply to chain saw models with an adjustable oil pump.

Checking chain lubrication

- Check the chain lubrication each time you refuel.

Aim the tip of the bar at a light coloured surface about 20 cm (8 inches) away. After 1 minute running at 3/4 throttle you should see a distinct line of oil on the light surface.



If the chain lubrication is not working:

- Check that the oil channel in the bar is not obstructed. Clean if necessary.

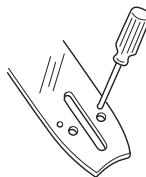

- Check that the groove in the edge of the bar is clean. Clean if necessary.

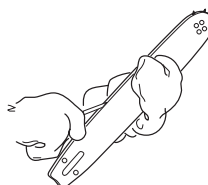

- Check that the bar tip sprocket turns freely and that the lubricating hole in the tip sprocket is not blocked. Clean and lubricate if necessary.



If the chain lubrication system is still not working after carrying out the above checks and associated measures you should contact your service agent.

Lubricating the bar tip sprocket

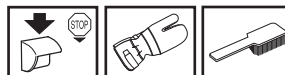

Lubricate the bar tip sprocket each time you refuel. Use the special grease gun and a good quality bearing grease.

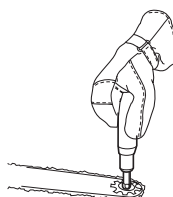

Needle bearing lubrication



The clutch drum is fitted with one of the following drive sprockets:

- A Spur sprocket (the chain sprocket is welded on the drum)
- B Rim sprocket (replaceable)

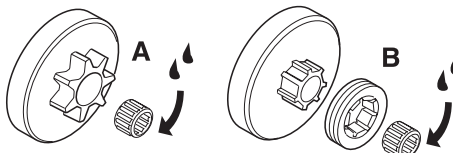

Both versions have a needle bearing on the drive shaft, which has to be greased regularly (once a week). **CAUTION!** Use a high-quality bearing grease or engine oil.

SAFETY INSTRUCTIONS

Checking wear on cutting equipment



Check the chain daily for:

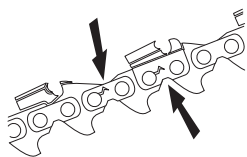

- Visible cracks in rivets and links.
- Whether the chain is stiff.
- Whether rivets and links are badly worn.

We recommend you compare the existing chain with a new chain to decide how badly the existing chain is worn.

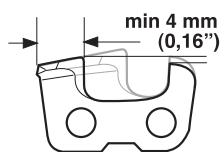

When the length of the cutting teeth has worn down to only 4 mm the chain must be replaced.

Chain drive sprocket

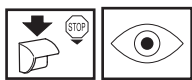

The clutch drum is fitted with one of the following drive sprockets:

- A Spur sprocket (the chain sprocket is welded on the drum)
- B Rim sprocket (replaceable)

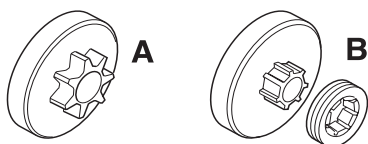

Regularly check the degree of wear on the drive sprocket. Replace if wear is excessive. Replace the drive sprocket whenever you replace the chain.

Bar



Check regularly:

- Whether there are burrs on the edges of the bar. Remove these with a file if necessary.

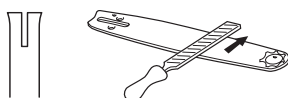

- Whether the groove in the bar has become badly worn. Replace the bar if necessary.



- Whether the tip of the bar is uneven or badly worn. If a hollow forms on the underside of the bar tip this is due to running with a slack chain.

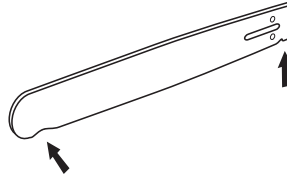

- To prolong the life of the bar you should turn it over daily.



WARNING! Most chain saw accidents happen when the chain touches the operator.

Wear personal protective equipment. See instructions under the heading Personal protective equipment.

Do not tackle any job that you feel you are not adequately trained for. See instructions under the headings Personal protective equipment, How to avoid kickback, Cutting equipment and General working instructions.

Avoid situations where there is a risk of kickback. See instructions under the heading Machine's safety equipment.

Use the recommended protective equipment and check its condition. See instructions under the heading General working instructions.

Check that all the chain saw safety features are working. See instructions under the headings General working instructions and General safety precautions.

SAFETY INSTRUCTIONS

How to avoid kickback



WARNING! Kickback can happen very suddenly and violently; kicking the chain saw, bar and chain back at the user. If this happens when the chain is moving it can cause very serious, even fatal injuries. It is vital you understand what causes kickback and that you can avoid it by taking care and using the right working technique.

What is kickback?

The word kickback is used to describe the sudden reaction that causes the chain saw and bar to jump off an object when the upper quadrant of the tip of the bar, known as the kickback zone, touches an object.



Kickback always occurs in the cutting plane of the bar. Normally the chain saw and bar are thrown backwards and upwards towards the user. However, the chain saw may move in a different direction depending on the way it was being used when the kickback zone of the bar touched the object.



Kickback only occurs if the kickback zone of the bar touches an object.

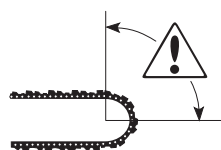

General rules

- 1 If you understand what kickback is and how it happens then you can reduce or eliminate the element of surprise. By being prepared you reduce the risk. Kickback is usually quite mild, but it can sometimes be very sudden and violent.
- 2 Always hold the chain saw firmly with your right hand on the rear handle and your left hand on the front handle. Wrap your fingers and thumbs around the handles. You should use this grip whether you are right-handed or left-handed. This grip minimises the effect of kickback and lets you keep the chain saw under control.

Do not let go of the handles!



- 3 Most kickback accidents happen during limbing. Make sure you are standing firmly and that there is nothing in the way that might make you trip or lose your balance.

Lack of concentration can lead to kickback if the kickback zone of the bar accidentally touches a branch, nearby tree or some other object.

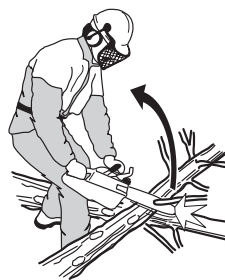

- 4 Never use the chain saw above shoulder height and try not to cut with the tip of the bar. **Never use the chain saw one-handed!**



- 5 You must have a steady stance in order to have full control over the chain saw. Never work standing on a ladder, in a tree or where you do not have firm ground to stand on.



- 6 Always use a fast cutting speed, i.e. full throttle.
- 7 Take great care when you cut with the top edge of the bar, i.e. when cutting from the underside of the object. This is known as cutting on the push stroke. The chain tries to push the chain saw back towards the user.

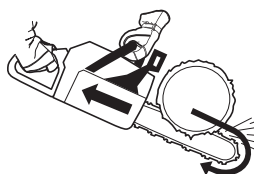

SAFETY INSTRUCTIONS

Unless the user resists this pushing force there is a risk that the chain saw will move so far backwards that only the kickback zone of the bar is in contact with the tree, which will lead to a kickback.



Cutting with the bottom edge of the bar, i.e. from the top of the object downwards, is known as cutting on the pull stroke. In this case the chain saw pulls itself towards the tree and the front edge of the chain saw body rests naturally on the trunk when cutting. Cutting on the pull stroke gives the operator better control over the chain saw and the position of the kickback zone.

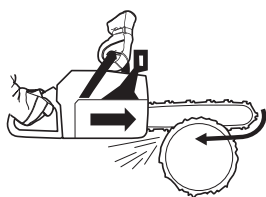

- 8 Follow the instructions on sharpening and maintaining your bar and chain. When you replace the bar and chain use only combinations that are recommended by us. See instructions under the headings Cutting equipment and Technical data.



WARNING! The risk of kickback is increased if you use the wrong cutting equipment or a chain that is not sharpened correctly. The wrong combination of bar and chain can increase the risk of kickback!

General safety precautions

- Chain saws are designed solely for cutting wood. The only accessories you may use with this engine unit are the combinations of bars and chains we recommend in the Technical data section.
- Never use the machine if you are tired, if you have drunk alcohol, or if you are taking medication that could affect your vision, your judgement or your co-ordination.

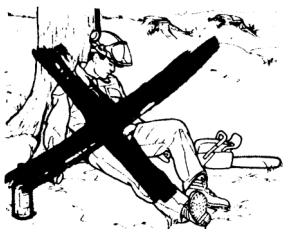

WARNING! Running an engine in a confined or badly ventilated area can result in death due to asphyxiation or carbon monoxide poisoning.

- Wear personal protective equipment. See instructions under the heading Personal protective equipment.

- Never use a machine that has been modified in any way from its original specification.
- Never use a machine that is faulty. Carry out the checks, maintenance and service instructions described in this manual. Some maintenance and service measures must be carried out by trained and qualified specialists. See instructions under the heading Maintenance.
- Never use any accessories other than those recommended in this manual. See instructions under the headings Cutting equipment and Technical data.



WARNING! The risk of accident is increased if you use the wrong cutting equipment or a chain that is not sharpened correctly. Using the wrong combination of bar and chain can increase the risk of accidents.

Before use:

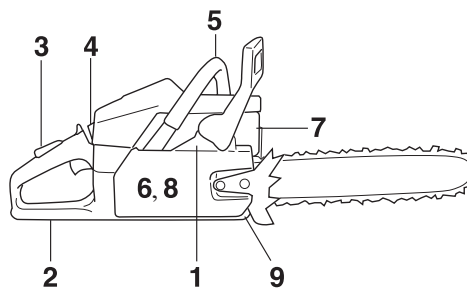

- Check that the chain brake works correctly and is not damaged. See the instructions under the heading Checking the chain brake.
- Check that the rear right hand guard is not damaged.
- Check that the throttle lock works correctly and is not damaged.
- Check that the start and stop switch works correctly and is not damaged.
- Check that all handles are free from oil.
- Check that the anti vibration system works and is not damaged.
- Check that the muffler is securely attached and not damaged.
- Check that all parts of the chain saw are tightened correctly and that they are not damaged or missing.
- Check that the chain catcher is in place and not damaged.

Starting



WARNING! Long term inhalation of the engine's exhaust fumes, chain oil mist and dust from sawdust can represent a health risk.

- Never start a chain saw unless the bar, chain and all covers are fitted correctly.

SAFETY INSTRUCTIONS

- The chain brake must be engaged when the chain saw is started. See the instructions under the heading Start. Never air drop start the chain saw. This method is extremely dangerous, as it is easy to lose control of the chain saw. See the instructions under the heading Start.

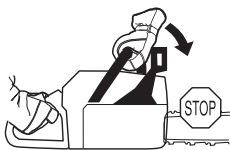

- Never start a chain saw unless the bar, chain and clutch cover are fitted correctly. See instructions under the heading Assembly.
- Never start the machine indoors. Exhaust fumes can be dangerous if inhaled.



- Observe your surroundings and make sure that there is no risk of people or animals coming into contact with the cutting equipment.



- Place the chain saw on the ground and hold the rear handle down with your right foot. Grasp the front handle firmly using your left hand. Make sure the chain saw is steady and the chain is not touching the ground or other objects. Then grasp the starter handle with your right hand and pull the starter cord. **Never twist the starter cord around your hand.**

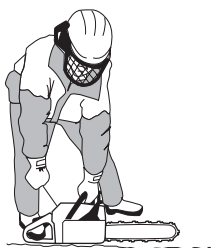

Fuel safety



WARNING! The catalytic converter muffler gets very hot during and after use. This also applies during idling. Be aware of the fire hazard, especially when working near flammable substances and/or vapours.



WARNING! Fuel and fuel vapour are highly flammable. Take care when handling fuel and chain oil. Be aware of the risks of fire, explosion and those associated with inhalation.

- Never refuel the machine while the engine is running.
- Make sure there is plenty of ventilation when refuelling or mixing fuel (petrol and 2-stroke oil).
- Move the machine at least 3 m from the refuelling point before starting it.

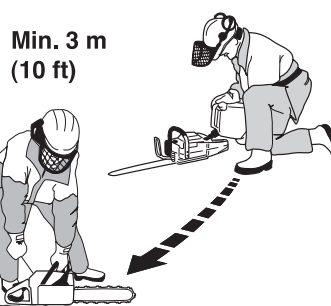

- Never start the machine:
 - 1 If you have spilt fuel or chain oil on the machine. Wipe off the spillage and allow remaining fuel to evaporate.
 - 2 If you have spilt fuel on yourself or your clothes, change your clothes. Wash any part of your body that has come in contact with fuel. Use soap and water.
 - 3 If the machine is leaking fuel. Check regularly for leaks from the fuel cap and fuel lines.

Transport and storage

- Always store the chain saw and fuel so that there is no risk of leakages or fumes coming into contact with sparks or naked flames from electrical equipment, electric motors, relays/switches, boilers and the like.
- Always store fuel in an approved container designed for that purpose.
- For longer periods of storage or for transport of the chain saw, the fuel and chain oil tanks should be emptied. Ask where you can dispose of waste fuel and chain oil at your local petrol station.
- Ensure the machine is cleaned and that a complete service is carried out before long-term storage.
- The transport guard must always be fitted to the cutting attachment when the machine is being transported or in storage.

SAFETY INSTRUCTIONS

General working instructions



WARNING! This section describes basic safety rules for using a chain saw. This information is never a substitute for professional skills and experience. If you get into a situation where you feel unsafe, stop and seek expert advice. Contact your chain saw dealer, service agent or an experienced chain saw user. Do not attempt any task that you feel unsure of!

Before using a chain saw you must understand the effects of kickback and how to avoid them. See instructions under the heading How to avoid kickback.

Before using a chain saw you must understand the difference between cutting with the top and bottom edges of the bar. See instructions under the heading How to avoid kickback.

Basic safety rules

- Look around you:
 - To ensure that people, animals or other things cannot affect your control of the machine.
 - To make sure that none of the above might come within reach of your saw or be injured by falling trees.

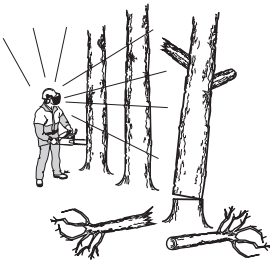

Follow the instructions above, but do not use a chain saw in a situation where you cannot call for help in case of an accident.

- Do not use the machine in bad weather, such as dense fog, heavy rain, strong wind, intense cold, etc. Working in bad weather is tiring and often brings added risks, such as icy ground, unpredictable felling direction, etc.
- Take great care when removing small branches and avoid cutting bushes (i.e. cutting many small branches at the same time). Small branches can be grabbed by the chain and thrown back at you, causing serious injury.



- Make sure you can move and stand safely. Check the area around you for possible obstacles (roots, rocks, branches, ditches, etc.) in case you have to move suddenly. Take great care when working on sloping ground.



- Take the utmost care when cutting through branches or logs that are in tension. A log or branch that is in tension can suddenly spring back into its natural position before or after you cut it. If you stand on the wrong side or start cutting in the wrong place it may strike you or your chain saw, so that you lose control. Both situations could cause serious injury.



- Before moving your chain saw switch off the engine and lock the chain using the chain brake. Carry the chain saw with the bar and chain pointing backwards. Fit a guard to the bar before transporting the chain saw or carrying it for any distance.

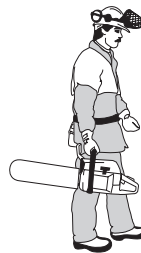

- Never put a chain saw down while the engine is running unless you have it in clear view and the chain brake is on. Switch the engine off before leaving your chain saw for any length of time.



SAFETY INSTRUCTIONS

Basic cutting technique



WARNING! Never use a chain saw by holding it with one hand. A chain saw is not safely controlled with one hand; you can cut yourself. Always have a secure, firm grip around the handles with both hands.

General

- Always use full throttle when cutting!
- Reduce the speed to idle after every cut (running the engine for too long at full throttle without any load, i.e. without any resistance from the chain during cutting, can lead to serious engine damage).
- Cutting from above = Cutting on the pull stroke.
- Cutting from below = Cutting on the push stroke.

Cutting on the push stroke increases the risk of kickback. See instructions under the heading How to avoid kickback.

Terms

Cutting = General term for cutting through wood.

Limbing = Cutting branches off a felled tree.

Splitting = When the object you are cutting breaks off before the cut is complete.

There are five important factors you should consider before making a cut:

- 1 Make sure the cutting equipment will not jam in the cut.

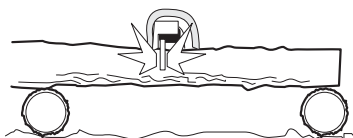

- 2 Make sure the object you are cutting will not split.

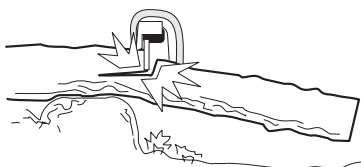

- 3 Make sure the chain will not strike the ground or any other object during or after cutting.



- 4 Is there a risk of kickback?

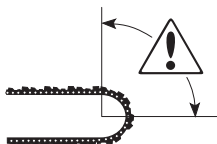

- 5 Do the conditions and surrounding terrain affect how safely you can stand and move about?

Two factors decide whether the chain will jam or the object that you are cutting will split: the first is how the object is supported before and after cutting, and the second is whether it is in tension.

In most cases you can avoid these problems by cutting in two stages; from the top and from the bottom. You need to support the object so that it will not trap the chain or split during cutting.



WARNING! If the chain jams in the cut: stop the engine! Don't try to pull the chain saw free. If you do you may be injured by the chain when the chain saw suddenly breaks free. Use a lever to open up the cut and free the chain saw.

The following instructions describe how to handle the commonest situations you are likely to encounter when using a chain saw.

Cutting

The log is lying on the ground. There is little risk of the chain jamming or the object splitting. However there is a risk that the chain will touch the ground when you finish the cut.



Cut all the way through the log from above. Avoid letting the chain touch the ground as you finish the cut. Maintain full throttle but be prepared for what might happen.

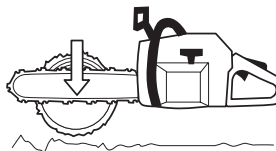

If it is possible (can you turn the log?) stop cutting about 2/3 of the way through the log.

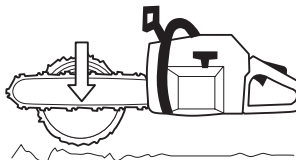

Turn the log and finish the cut from the opposite side.

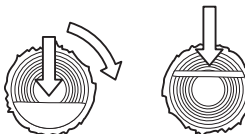

SAFETY INSTRUCTIONS

The log is supported at one end. There is a high risk that it will split.

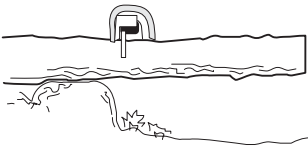

Start by cutting from below (about 1/3 of the way through).

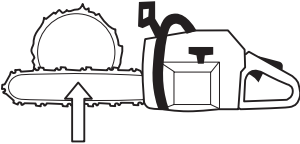

Finish by cutting from above so that the two cuts meet.

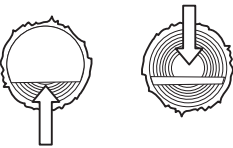

The log is supported at both ends. There is a high risk that the chain will jam.

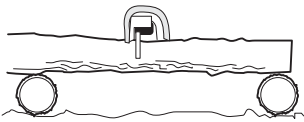

Start by cutting from above (about 1/3 of the way through).

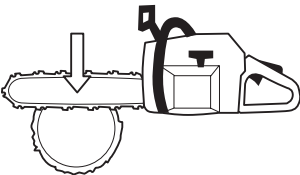

Finish by cutting from below so that the two cuts meet.

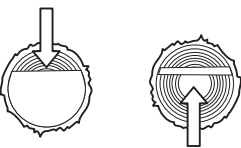

Limbing

When limbing thick branches you should use the same approach as for cutting.

Cut difficult branches piece by piece.

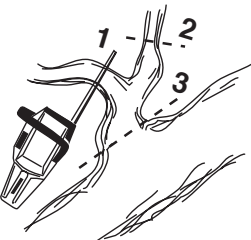

Tree felling technique



WARNING! It takes a lot of experience to fell a tree. Inexperienced users of chain saws should not fell trees. Do not attempt any task that you feel unsure of!

Safe distance

The safe distance between a tree that is to be felled and anyone else working nearby is at least 2 1/2 tree lengths. Make sure that no-one else is in this "risk zone" before or during felling.

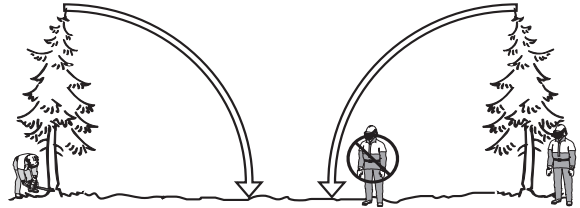

Felling direction

The aim is to fell the tree in a position where you can limb and cross-cut the log as easily as possible. You want it to fall on ground where you can stand and move about safely. The main point to avoid is letting the tree fall onto another tree. See instructions under the heading Freeing a tree that has fallen badly.



Once you have decided which way you want the tree to fall you must judge which way the tree would fall naturally.

Several factors affect this:

- Lean of the tree
- Bend
- Wind direction
- Arrangement of branches
- Weight of snow

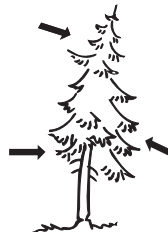

You may find you are forced to let the tree fall in its natural direction because it is impossible or dangerous to try to make it fall in the direction you first intended.

SAFETY INSTRUCTIONS

Another very important factor, which does not affect the felling direction but does affect your safety, is to make sure the tree has no damaged or dead branches that might break off and hit you during felling.



WARNING! During critical felling operations, hearing protectors should be lifted immediately when sawing is completed so that sounds and warning signals can be heard.

Clearing the trunk and preparing your retreat

Remove any branches that are in the way. To do this it is best to work from the top down and keep the trunk between you and the chain saw. Never limb above shoulder height.

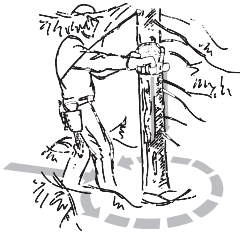

Remove any undergrowth from the base of the tree and check the area for obstacles (stones, branches, holes, etc.) so that you have a clear path of retreat when the tree starts to fall. Your path of retreat should be roughly 135 degrees away from the intended felling direction.

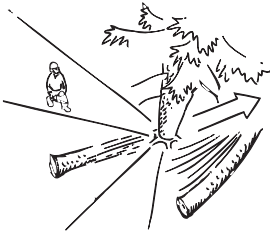

Felling

Felling is done using three cuts. First you make the directional cuts, which consist of the top cut and the bottom cut, then you finish with the felling cut. By placing these cuts correctly you can control the felling direction very accurately.

Directional cuts

To make the directional cuts you begin with the top cut. Stand to the right of the tree and cut on the pull stroke.

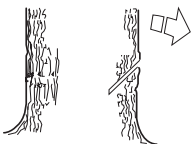

Next make the bottom cut so that it finishes exactly at the end of the top cut.

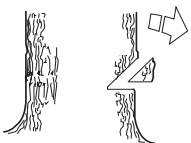

The directional cuts should run 1/4 of the diameter through the trunk and the angle between the top cut and bottom cut should be 45°.

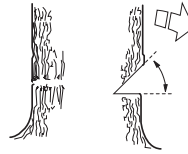

The line where the two cuts meet is called the directional cut line. This line should be perfectly horizontal and at right angles (90°) to the chosen felling direction.

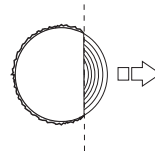

Felling cut

The felling cut is made from the opposite side of the tree and it must be perfectly horizontal. Stand on the left side of the tree and cut on the pull stroke.

Make the felling cut about 3-5 cm (1.5-2 inches) above the bottom directional cut.

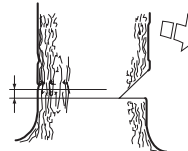

Set the spike bumper (if one is fitted) just behind the felling hinge. Use full throttle and advance the chain/bar slowly into the tree. Make sure the tree does not start to move in the opposite direction to your intended felling direction. Drive a wedge or breaking bar into the cut as soon as it is deep enough.

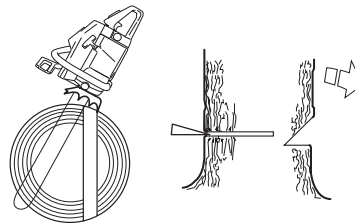

Finish the felling cut parallel with the directional cut line so that the distance between them is at least 1/10 of the trunk diameter. The uncut section of the trunk is called the felling hinge.

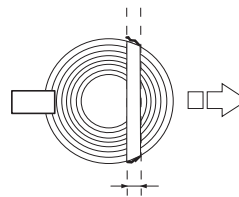

SAFETY INSTRUCTIONS

The felling hinge controls the direction that the tree falls in.

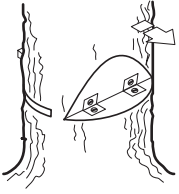

All control over the felling direction is lost if the felling hinge is too narrow or non-existent, or if the directional cuts and felling cut are badly placed.



When the felling cut and directional cut are complete the tree should start to fall by itself or with the aid of a felling wedge or breaking bar.

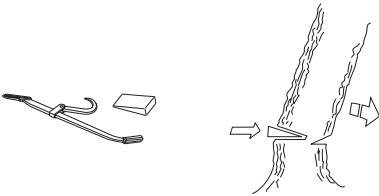

We recommend that you use a bar that is longer than the diameter of the tree, so that you can make the felling cut and directional cuts with single cutting strokes. See the Technical data section to find out which lengths of bar are recommended for your saw.

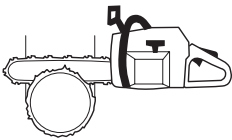

There are methods for felling trees with a diameter larger than the bar length. However these methods involve a much greater risk that the kickback zone of the bar will come into contact with the tree.

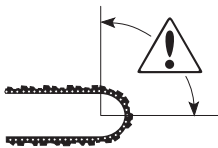

WARNING! Unless you have special training we advise you not to fell trees with a diameter larger than the bar length of your saw!

Limbing



WARNING! Most kickback accidents happen during limbing! Pay close attention to the position of the kickback zone of the bar when you are limbing branches that are in tension!

Make sure that you can stand and move about safely. Work on the left side of the trunk. Work as close as possible to the chain saw for maximum control. If possible, let the weight of the chain saw rest on the trunk.



Keep the trunk between you and the chain saw as you move along the trunk.

Cutting the trunk into logs

See instructions under the heading Basic cutting technique.

SAFETY INSTRUCTIONS

Freeing a tree that has fallen badly

Freeing a "trapped tree"

It is very dangerous to remove a trapped tree and there is high accident risk.

The safest method is to use a winch.

- Tractor-mounted



- Portable

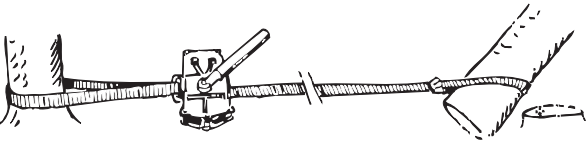

Cutting trees and branches that are in tension

Preparations:

Work out which side is in tension and where the point of maximum tension is (i.e. where it would break if it was bent even more).



Decide which is the safest way to release the tension and whether you are able to do it safely. In complicated situations the only safe method is to put aside your chain saw and use a winch.

General advice:

Position yourself so that you will be clear of the tree or branch when the tension is released.



Make one or more cuts at or near the point of maximum tension. Make as many cuts of sufficient depth as necessary to reduce the tension and make the tree or branch break at the point of maximum tension.

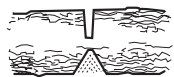

Never cut straight through a tree or branch that is in tension!

WHAT IS WHAT?

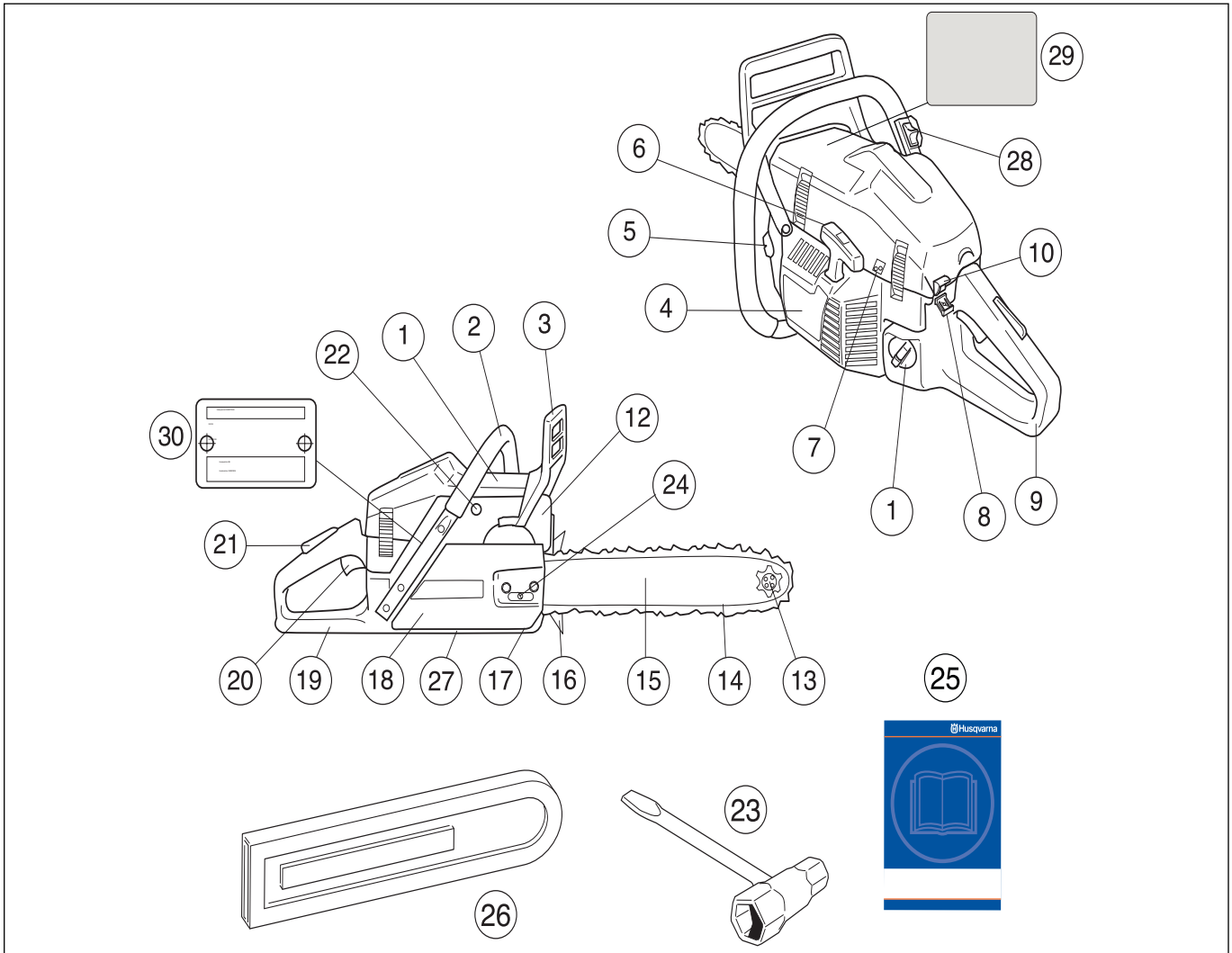

What is what on the chain saw?

- | | |
|--|---|
| 1 Cylinder cover | 16 Spike bumper |
| 2 Front handle | 17 Chain catcher (Catches chain if it jumps or breaks.) |
| 3 Front hand guard | 18 Clutch cover |
| 4 Starter | 19 Right hand guard (Protects right hand if chain breaks or jumps.) |
| 5 Chain oil tank | 20 Throttle control |
| 6 Starter handle | 21 Throttle lock (Prevents accidental operation of throttle control.) |
| 7 Adjuster screws, carburettor | 22 Decompression valve (359)
Automatic decompression valve (357XP) |
| 8 Choke control/Start throttle lock | 23 Combination spanner |
| 9 Rear handle | 24 Chain tensioning screw |
| 10 Stop switch (Ignition on/off switch.) | 25 Operator's manual |
| 11 Fuel tank | 26 Bar guard |
| 12 Muffler | 27 Oil pump adjustment screw |
| 13 Bar tip sprocket | 28 Switch for heated handle (357 XPG, 359 G) |
| 14 Chain | 29 Warning decal |
| 15 Bar | |

ASSEMBLY

Fitting the bar and chain

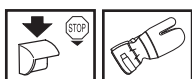

WARNING! Always wear gloves, when working with the chain.

Check that the chain brake is in disengaged position by moving the front hand guard towards the front handle.

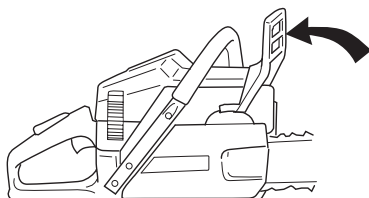

Remove the bar nuts and remove the clutch cover (chain brake). Take off the transportation ring (A).

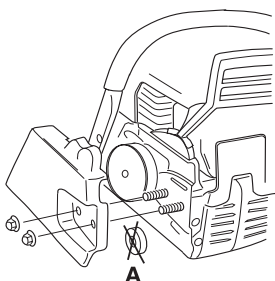

Fit the bar over the bar bolts. Place the bar in its rearmost position. Place the chain over the drive sprocket locate it in the groove on the bar. Begin on the top edge of the bar.

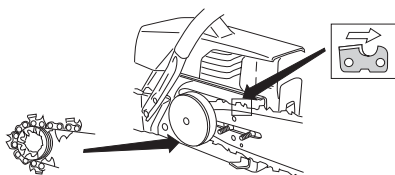

Make sure that the edges of the cutting links are facing forward on the top edge of the bar.

Fit the clutch cover and locate the chain adjuster pin in the hole in the bar. Check that the drive links of the chain fit correctly over the drive sprocket and that the chain is correctly located in the groove in the bar. Tighten the bar nuts finger tight.

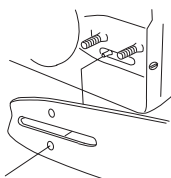

Tension the chain by turning the chain tensioning screw clockwise using the combination spanner. The chain should be tensioned until it does not sag from the underside of the bar.

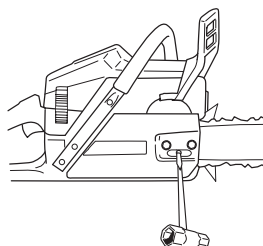

The chain is correctly tensioned when it does not sag from the underside of the bar, but can still be turned easily by hand. Hold up the bar tip and tighten the bar nuts with the combination spanner.

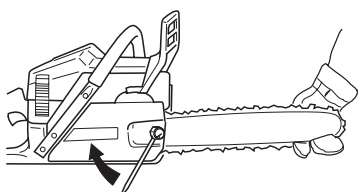

When fitting a new chain, the chain tension has to be checked frequently until the chain is run-in. Check the chain tension regularly. A correctly tensioned chain ensures good cutting performance and long life.

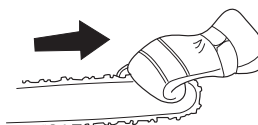

Fitting a spike bumper

To fit a spike bumper – contact your service agent.

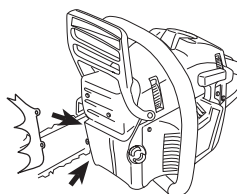

FUEL HANDLING

Fuel

CAUTION! The machine is equipped with a two-stroke engine and must always be run using a mixture of petrol and two-stroke engine oil. It is important to accurately measure the amount of oil to be mixed to ensure that the correct mixture is obtained. When mixing small amounts of fuel, even small inaccuracies can drastically affect the ratio of the mixture.



WARNING! Always ensure there is adequate ventilation when handling fuel.

Petrol

- Use good quality unleaded or leaded petrol.

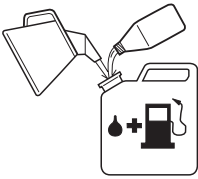

- The lowest octane recommended is 90. If you run the engine on a lower octane than 90 it can result in knocking. This gives rise to a high engine temperature, which can result in serious engine damage.
- When working with continuous high revs (e.g. limbing) a higher octane is recommended.

Two-stroke oil

- For best results and performance use HUSQVARNA two-stroke oil, which is specially formulated for our two-stroke engines. Mixture 1:50 (2%).
- If HUSQVARNA two-stroke oil is not available, you may use another two-stroke oil of good quality that is intended for air cooled engines. Contact your dealer when selecting an oil. Mixing ratio 1:33 (3%)-1:25 (4%).
- Never use two-stroke oil intended for water-cooled outboard engines, sometimes referred to as outboard oil.
- Never use oil intended for four-stroke engines.

Petrol, litre	Two-stroke oil, litre		
	2% (1:50)	3% (1:33)	4% (1:25)
5	0,10	0,15	0,20
10	0,20	0,30	0,40
15	0,30	0,45	0,60
20	0,40	0,60	0,80

Mixing

- Always mix the petrol and oil in a clean container intended for fuel.
- Always start by filling half the amount of the petrol to be used. Then add the entire amount of oil. Mix (shake) the fuel mixture. Add the remaining amount of petrol.
- Mix (shake) the fuel mixture thoroughly before filling the machine's fuel tank.

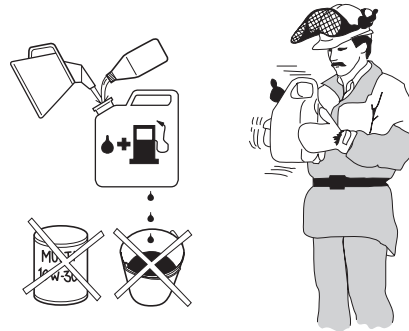

- Do not mix more than one month's supply of fuel at a time.
- If the machine is not used for some time the fuel tank should be emptied and cleaned.

The following applies to chain saws with catalytic converters:

Petrol

Always use high grade unleaded petrol (minimum 95 RON)! Leaded petrol will destroy the catalytic converter and it will no longer serve its purpose. The green fuel cap on chain saws with catalytic converters means that only unleaded petrol can be used.

Two-stroke oil

For best results and performance use HUSQVARNA two-stroke oil, which is specially formulated for our two-stroke engines. Mixture 1:50 (2%).



WARNING! The catalytic converter muffler gets very hot during and after use. This also applies during idling. Be aware of the fire hazard, especially when working near flammable substances and/or vapours.

For additional information about fuels, see above.

FUEL HANDLING

Chain oil



- The chain lubrication system is automatic and we recommend the use of special oil (chain oil) with good adhesion characteristics.

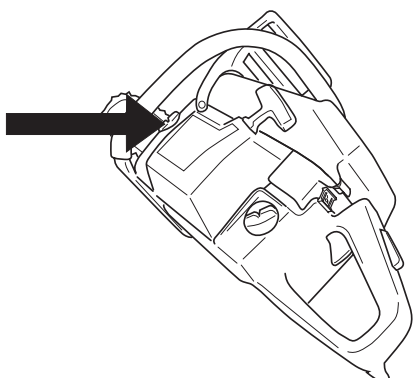

- In countries where no special chain oil is available, EP90 transmission oil can be used.
- Never use waste oil. This results in damage to the oil pump, the bar and the chain.
- It is important to use oil of the right grade (suitable viscosity range) to suit the air temperature.
- In temperatures below 0°C (32°F) some oils become too viscous. This can overload the oil pump and result in damage to the oil pump components.
- Contact your service agent when choosing chain oil.

Fuelling



WARNING! Taking the following precautions, will lessen the risk of fire:

Do not smoke or place hot objects near fuel.

Always shut off the engine before refuelling.

When refuelling, open the fuel cap slowly so that any excess pressure is released gently.

Tighten the fuel cap carefully after refuelling.

Always move the machine away from the refuelling area before starting.



WARNING! The catalytic converter muffler gets very hot during and after use. This also applies during idling. Be aware of the fire hazard, especially when working near flammable substances and/or vapours.

Clean the area around the fuel cap. Clean the fuel and chain oil tanks regularly. The fuel filter must be replaced at least once a year. Contamination in the tanks causes malfunction. Make sure the fuel is well mixed by shaking the container before refuelling. The capacities of the chain oil tank and fuel tank are carefully matched. You should therefore always fill the chain oil tank and fuel tank at the same time.

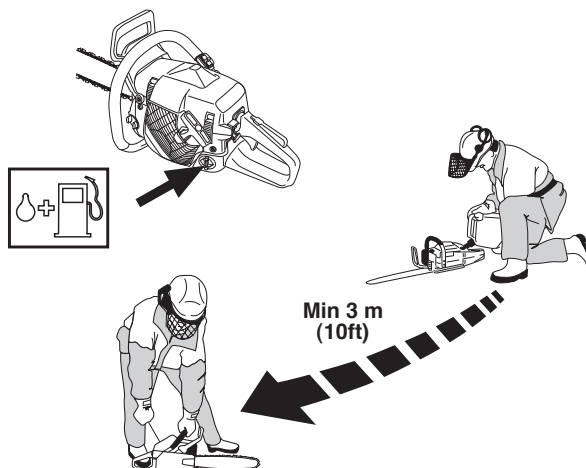

STARTING AND STOPPING

Starting and stopping



WARNING! Note the following before starting:

Never start a chain saw unless the bar, chain and all covers are fitted correctly. Otherwise the clutch can come loose and cause personal injuries.

Always move the machine away from the refuelling area before starting.

Place the machine on firm ground. Make sure you have a secure footing and that the chain cannot touch anything.

Keep people and animals well away from the working area.

Cold engine

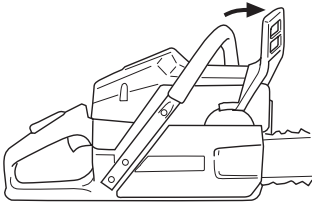

Starting: The chain brake must be engaged when the chain saw is started. Activate the brake by moving the front hand guard forwards.

Ignition; choke: Set the choke control in the choke position. This should automatically set the stop switch to the start position.

Start throttle: The correct choke/start throttle setting is obtained by moving the control to the choke position.

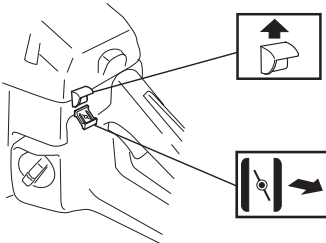

Decompression valve (359)

If the machine is fitted with a decompression valve (A): Press the valve to reduce the pressure in the cylinder and make starting easier. You should always use the decompression valve when starting the machine. Once the machine has started the valve will automatically return to its original setting.

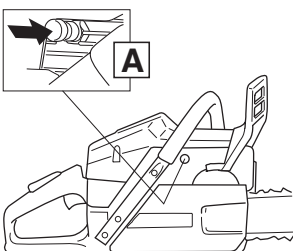

Automatic decompression valve (357XP)

The valve is always in the open position before starting and closes automatically when the saw starts.

Warm engine

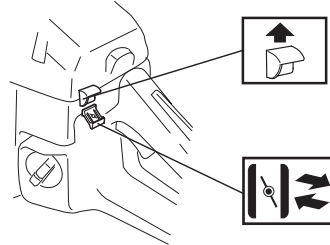

Use the same procedure as for starting a cold engine but without setting the choke control in the choke position. The correct choke/start throttle setting is obtained by moving the choke control to the choke position and then pushing it in again.

Starting



Grip the front handle with your left hand. Hold the chain saw on the ground by placing your right foot through the rear handle. Pull the starter handle with your right hand and pull out the starter cord slowly until you feel a resistance (as the starter pawls engage) then pull firmly and rapidly. **Never twist the starter cord around your hand.**

As the chain brake is still engaged the speed of the engine must be set to idling as soon as possible, this is achieved by quickly disengaging the throttle lock. This prevents unnecessary wear to the clutch, clutch drum and brake band.

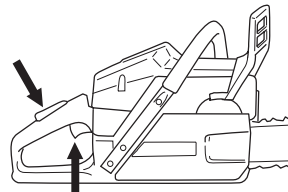

Push in the choke control as soon as the engine fires and keep pulling until the engine starts. When the engine starts, quickly apply full throttle; the throttle start lock will automatically disengage.

STARTING AND STOPPING

CAUTION! Do not pull the starter cord all the way out and do not let go of the starter handle when the cord is fully extended. This can damage the machine.

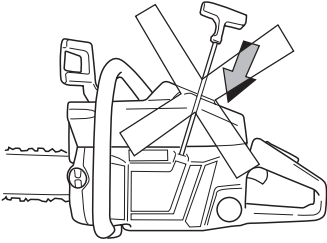

Reactivate the chain brake by pushing the front hand guard back towards the front handle. The chain saw is now ready for use.

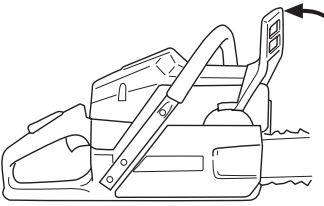

Stopping

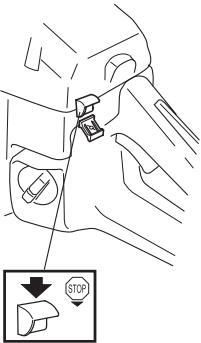

Stop the engine by switching off the ignition.

MAINTENANCE

Carburettor

Function, Basic settings, Fine adjustment



WARNING! Do not start the chain saw unless the bar, chain and clutch cover (chain brake) are fitted, otherwise the clutch may come loose and cause personal injury.

Function

- The carburettor governs the engine's speed via the throttle control. Air and fuel are mixed in the carburettor. The air/fuel mixture is adjustable. Correct adjustment is essential to get the best performance from the machine.
- Adjusting the carburettor means that the engine is adapted to local operating conditions, e.g. climate, altitude, petrol and the type of 2-stroke oil.
- The carburettor has three adjustment controls:
 - L = Low speed jet
 - H = High speed jet
 - T = Idle adjustment screw

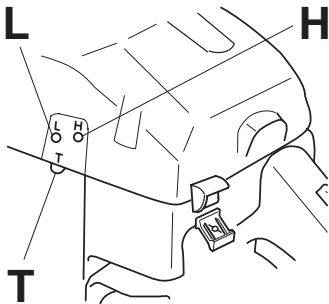

- The L and H-jets are used to adjust the supply of fuel to match the rate that air is admitted, which is controlled with the throttle. If they are screwed clockwise the air/fuel ratio becomes leaner (less fuel) and if they are turned anti-clockwise the ratio becomes richer (more fuel). A lean mixture gives a higher engine speed and a rich mixture gives a lower engine speed.
- The T-screw regulates the throttle setting at idle speed. If the T-screw is turned clockwise this gives a higher idle speed; turning it anti-clockwise gives a lower idle speed.



WARNING! The catalytic converter muffler gets very hot during and after use. This also applies during idling. Be aware of the fire hazard, especially when working near flammable substances and/or vapours.

Basic settings and running in

The basic carburettor settings are adjusted during testing at the factory. **The basic settings are H = 1 turn and L = 1 turn.**

To provide the engine's components with good initial lubrication (during running in) the carburettor should be set for a richer fuel mixture for the first 3-4 hours that the chain saw is in use. To do this, adjust the fast idle speed to 600-700 rpm below the recommended max. fast idle speed.

If you are unable to check the fast idle speed using a tachometer the H-jet should not be set for a leaner mixture than given in the basic settings. The recommended max. fast idle speed must not be exceeded.

Fine adjustment

When the machine has been "run-in" the carburettor should be finely adjusted. The fine adjustment should be carried out by a qualified person. First adjust the L-jet, then the idling screw T and then the H-jet.

	Max. fast idle speed, rpm	Idle speed, rpm
357XP	14000	2700
359	13500	2700

Changing the type of fuel

Fine tuning may be required if the chain saw, after changing the type of fuel, performs differently with regard to starting, acceleration, max. speed, etc.

Conditions

- Before any adjustments are made the air filter should be clean and the cylinder cover fitted. Adjusting the carburettor while a dirty air filter is in use will result in a leaner mixture next time the filter is cleaned. This can give rise to serious engine damage.
- Carefully turn the L and H-jets clockwise as far as they will go. Now turn the jets one turn anti-clockwise. The carburettor is now set to H = 1 and L = 1.
- Now start the machine according to the starting instructions and let it warm up for 10 minutes. **CAUTION! If the chain rotates while idling the T-screw must be turned anti-clockwise until the chain stops.**
- Place the machine on a flat surface so that the bar points away from you and so that the bar and chain do not come into contact with the surface or other objects.

Low speed jet L

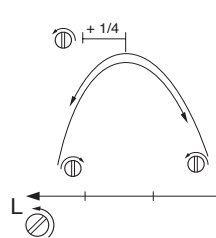

Try to find the highest idle speed by turning the low speed jet L clockwise then anti-clockwise. When the highest speed has been found, turn the low speed jet L 1/4 turn anti-clockwise.

CAUTION! If the chain rotates while idling the T-screw must be turned anti-clockwise until the chain stops.

Fine adjustment of the idle speed T

Adjust the idle speed with the T-screw. If it is necessary to re-adjust, turn the T-screw clockwise while the engine is running, until the chain starts to rotate. Then turn anti-clockwise until the chain stops. When the idle speed is correctly adjusted the

MAINTENANCE

engine should run smoothly in every position and the engine speed should be safely below the speed at which the chain starts to rotate.



WARNING! Contact your servicing dealer, if the idle speed setting cannot be adjusted so that the chain stops. Do not use the chain saw until it has been properly adjusted or repaired.

High speed jet H

- The high speed jet H influences the power and engine speed of the machine. If the high speed jet is set too rich (H-jet screwed in too far) the machine will over-rev and this will damage the engine. Run the machine at full throttle for about 10 seconds. Then turn the H-jet 1/4 turn anti-clockwise. Run the machine at full throttle for another 10 seconds or so and listen to the difference in the fast idle speed. Repeat this procedure with the H-jet turned a further 1/4 turn anti-clockwise.

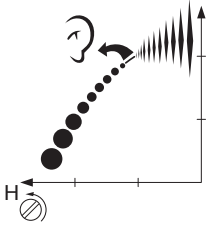

- You have now run the machine at settings of $H = \pm 0$, $H = +1/4$, $H = +1/2$ relative to the basic settings. At full throttle the engine has sounded different for each setting. The H-jet is correctly adjusted when the machine burbles a little. If the machine "screams" then the machine is set too lean. If the muffler emits a lot of smoke and the machine burbles a lot then the setting is too rich. Turn the H-jet clockwise until the setting sounds right

CAUTION! To ensure correct adjustment you should enlist a qualified mechanic who has access to a tachometer. The recommended maximum fast idle speed must not be exceeded.

Correctly adjusted carburettor

When the carburettor is correctly adjusted the machine accelerates without hesitation and burbles a little at full throttle. It is also important that the chain does not rotate at idle. If the L-jet is set too lean it may cause starting difficulties and poor acceleration. If the H-jet is set too lean the machine will have less power, poor acceleration and could suffer damage to the engine. If the L and H-jets are set too rich it will lead to acceleration problems or too low a working speed.

Starter



WARNING! When the recoil spring is wound up in the starter housing it is under tension and can, if handled carelessly, pop out and cause personal injury. Always be careful when changing the recoil spring or the starter cord. Always wear protective goggles.

Changing a broken or worn starter cord

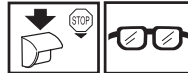

- Loosen the screws that hold the starter against the crankcase and remove the starter.

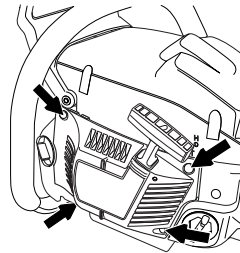

- Pull out the cord approx. 30 cm and hook it into the notch in the rim of the pulley. Release the recoil spring by letting the pulley rotate slowly backwards.

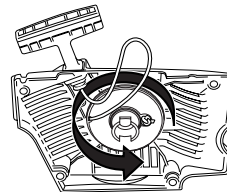

- Undo the screw in the centre of the pulley and remove the pulley. Insert and fasten a new starter cord to the pulley. Wind approx. 3 turns of the starter cord onto the pulley. Connect the pulley to the recoil spring so that the end of the spring engages in the pulley. Fit the screw in the centre of the pulley. Insert the starter cord through the hole in the starter housing and the starter handle. Make a secure knot in the end of the starter cord.

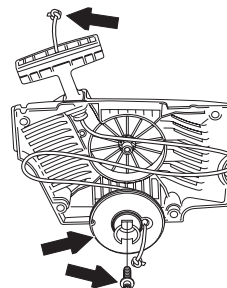

MAINTENANCE

Tensioning the recoil spring

- Hook the starter cord in the notch in the pulley and turn the starter pulley about 2 turns clockwise.

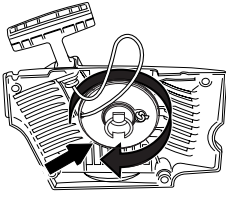

•

CAUTION! Check that the pulley can be turned at least a further 1/2 turn when the starter cord is pulled all the way out.

Changing a broken recoil spring



- Lift off the pulley. See instructions under heading Changing a broken or worn starter cord.
- Remove the recoil spring from inside the pulley by tapping the pulley lightly with its inside face downwards against a work bench or the like. If the spring pops out during fitting, wind it up again, working from the outside in towards centre.
- Lubricate the recoil spring with light oil. Fit the pulley and tension the recoil spring.

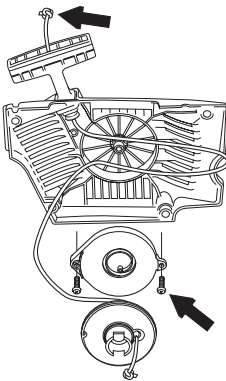

Fitting the starter

- To fit the starter, first pull out the starter cord and place the starter in position against the crankcase. Then slowly release the starter cord so that the pulley engages with the pawls.
- Fit and tighten the screws that hold the starter.

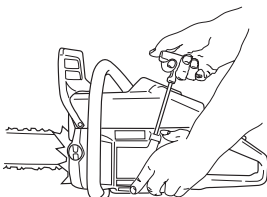

Air filter

The air filter must be regularly cleaned to remove dust and dirt in order to avoid:

- Carburettor malfunctions
- Starting problems
- Loss of engine power
- Unnecessary wear to engine parts.
- Excessive fuel consumption.



Clean the air filter daily, or more often in demanding conditions.

- Remove the air filter after taking off the air filter cover. When refitting make sure that the air filter seals tightly against the filter holder. Clean the filter by brushing or shaking it.

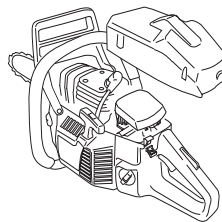

- The filter can be cleaned more thoroughly by washing it in water and detergent.

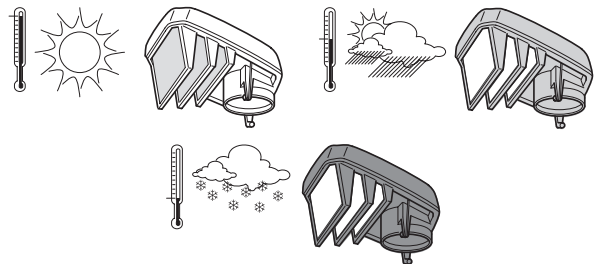

An air filter that has been in use for a long time cannot be cleaned completely. The filter must therefore be replaced with a new one at regular intervals. **A damaged air filter must always be replaced.**

A HUSQVARNA chain saw can be equipped with different types of air filter according to working conditions, weather, season, etc. Contact your dealer for advice.

Spark plug



The spark plug condition is influenced by:

- Incorrect carburettor adjustment.
- Wrong fuel mixture (too much oil).
- A dirty air filter.

These factors cause deposits on the spark plug electrodes, which may result in operating problems and starting difficulties.

- If the machine is low on power, difficult to start or runs poorly at idle speed: always check the spark plug first before taking any further action. If the spark plug is dirty,

MAINTENANCE

clean it and check that the electrode gap is 0.5 mm. The spark plug should be replaced after about a month in operation or earlier if necessary.

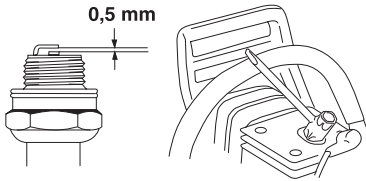

CAUTION! Always use the recommended spark plug type! Use of the wrong spark plug can damage the piston/cylinder.

Muffler



The muffler is designed to reduce the noise level and to direct the exhaust gases away from the operator. The exhaust gases are hot and can contain sparks, which may cause fire if directed against dry and combustible material.

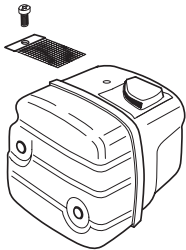

Some mufflers are equipped with a special spark arrester mesh. If your machine has this type of muffler, you should clean the mesh at least once a week. This is best done with a wire brush.

CAUTION! The mesh must be replaced if it is damaged. If the mesh is blocked the machine will overheat and this will cause damage to the cylinder and piston. Never use a machine with a muffler that is in poor condition.

A muffler fitted with a catalytic converter greatly reduces the concentration of hydrocarbons (HC), oxides of nitrogen (NO) and aldehydes emitted with exhaust gases. However, it does not cut down carbon monoxide (CO), which you cannot smell! Consequently, never work in an enclosed or badly ventilated area. Good air circulation should always prevail when working in snowy hollows, ravines or in confined conditions.



WARNING! The catalytic converter muffler gets very hot during and after use. This also applies during idling. Be aware of the fire hazard, especially when working near flammable substances and/or vapours.

Needle bearing lubrication

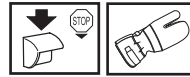

The clutch drum is fitted with one of the following drive sprockets:

- A Spur sprocket (the chain sprocket is welded on the drum)
- B Rim sprocket (replaceable)

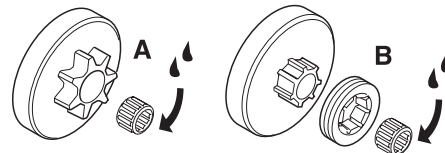

Both versions have a needle bearing on the drive shaft, which has to be greased regularly (once a week).

CAUTION! Use a high-quality bearing grease or engine oil.

Adjustment of the oil pump



The oil pump is adjustable. Adjustments are made by turning the screw using a screwdriver or combination spanner. The machine is supplied from the factory with the screw set to position 2. Turning the screw clockwise will reduce the oil flow and turning the screw anti-clockwise will increase the oil flow.

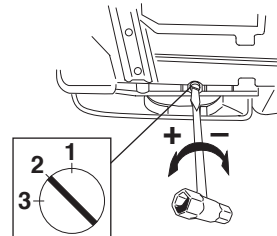

WARNING! The engine must not be running when making adjustments.

Recommended settings:

Bar 13"-15": Position 1

Bar 15"-18": Position 2

Bar 18"-20": Position 3

MAINTENANCE

Cooling system



To keep the working temperature as low as possible the machine is equipped with a cooling system.

The cooling system consists of:

- 1 Air intake on the starter.
- 2 Air guide plate.
- 3 Fins on the flywheel.
- 4 Cooling fins on the cylinder.
- 5 Cylinder cover (directs cold air over the cylinder).

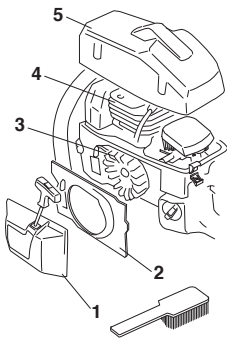

Clean the cooling system with a brush once a week, more often in demanding conditions. A dirty or blocked cooling system results in the machine overheating which causes damage to the piston and cylinder.

”Air Injection” centrifugal cleaning

Centrifugal cleaning means the following: All air to the carburettor passes through the starter. Dirt and dust is centrifuged out by the cooling fan.

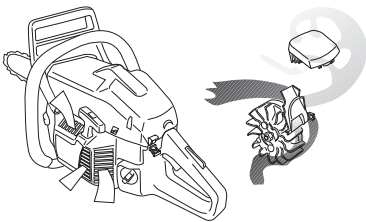

IMPORTANT! In order to maintain operation of the centrifugal cleaning system it must be regularly maintained.

- Clean the air intake to the starter, the fins on the flywheel, the space around the flywheel, inlet pipe and carburettor compartment.

Heated handles

(357 XPG, 359 G)

On models with the model code XPG/G both the front handle bar and the rear handle are equipped with electrical heating coils. These are supplied with electricity from a generator built into the chain saw.

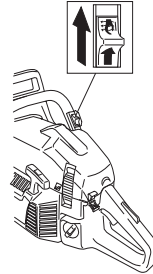

When the switch is pushed upwards, the heat is switched on. When the switch is pushed downwards, the heat is switched off.

Electrical carburettor heating

(357 XPG, 359 G)



If this chain saw has the model code XPG/G then it is equipped with an electrically heated carburettor. The electrical heating prevents icing in the carburettor. A thermostat regulates heating so that the carburettor always has the correct working temperature.

Winter use

During cold weather and under powder snow conditions, operating problems can arise due to:

- Too low engine temperature.
- Icing of the air filter and carburettor.

Special measures are therefore often required:

- Partly mask the air inlet on the starter to increase the working temperature of the engine.

Temperature 0°C or colder:



The cylinder cover is designed so it can be adjusted for running in cold weather. Twist the winter flap so that preheated air from the cylinder can pass into the carburettor space preventing icing of the air filter, etc.

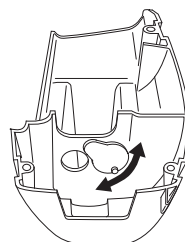

MAINTENANCE

Temperature -5°C or colder:



For running the machine in cold weather or powder snow, a special cover is available, which is mounted on the starter housing. This reduces the intake of cold air and prevents large amounts of snow from being sucked in.

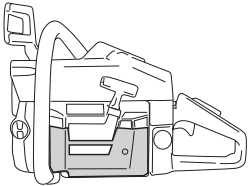

CAUTION! If the special winterising kit has been fitted or any measures have been taken to increase the temperature these changes must be reversed before the machine is used in normal temperature conditions. Otherwise there is a risk of overheating, resulting in severe damage to the engine.

IMPORTANT! Any maintenance other than that described in this manual must be carried out by your servicing dealer (retailer).

Below you will find some general maintenance instructions.

Daily maintenance

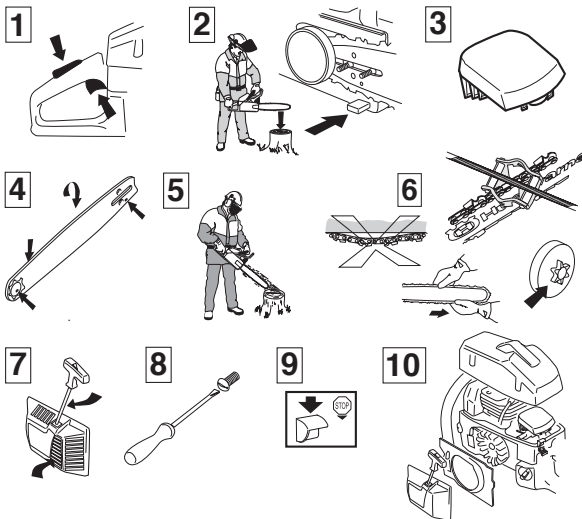

- 1 Check that the components of the throttle control work safely. (Throttle lock and throttle control.)
- 2 Clean the chain brake and check that it operates safely. Make sure that the chain catcher is undamaged, and replace it if necessary.
- 3 Clean the air filter. Replace if necessary.
- 4 The bar should be turned daily for more even wear. Check the lubrication hole in the bar, to be sure it is not clogged. Clean the bar groove. If the bar has a sprocket tip, this should be lubricated.
- 5 Check that the bar and chain are getting sufficient oil.

- 6 Sharpen the chain and check its tension and condition. Check the drive sprocket for excessive wear and replace if necessary.
- 7 Clean the air intake on the starter. Check the starter and starter cord.
- 8 Check that nuts and screws are tight.
- 9 Test the stop switch to ensure that it works.
- 10 Check the cooling system on chain saws with catalytic converters.

Weekly maintenance

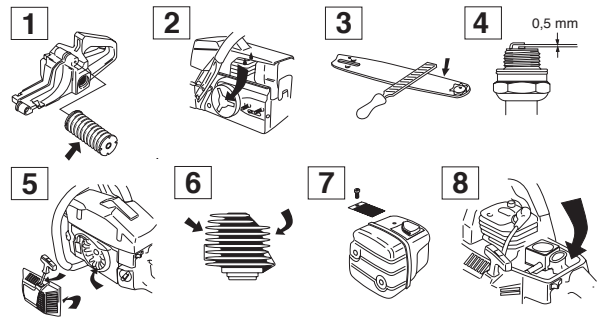

- 1 Check that the vibration damping elements are not damaged.
- 2 Lubricate the clutch drum bearing.
- 3 File off any burrs from the edges of the bar.
- 4 Clean the spark plug. Check that the electrode gap is 0.5 mm.
- 5 Clean the fins on the flywheel. Check the starter and the recoil spring.
- 6 Clean the cooling fins on the cylinder.
- 7 Clean or replace the spark arrestor mesh in the muffler.
- 8 Clean the carburettor compartment.

Monthly maintenance

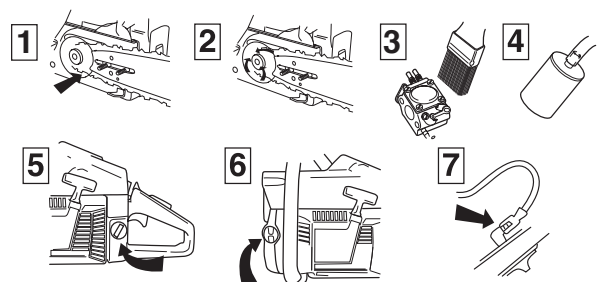

- 1 Check the brake band on the chain brake for wear.
- 2 Check the clutch centre, clutch drum and clutch spring for wear.
- 3 Clean the outside of the carburettor.
- 4 Check the fuel filter and the fuel hose. Replace if necessary.
- 5 Clean the inside of the fuel tank.
- 6 Clean the inside of the oil tank.
- 7 Check all cables and connections.

TECHNICAL DATA

Technical data

	357XP	359
Engine		
Cylinder displacement, cm ³	56,5	59,0
Cylinder bore, mm	46	47
Stroke, mm	34,0	34,0
Idle speed, rpm	2700	2700
Recommended max. speed, rpm	14000	13500
Power, kW/ rpm (Europe)	3,2/9600	2,9/9000
Power, kW/ rpm (Australia)	3,2/9600	2,9/9000
Ignition system		
Manufacturer of ignition system	SEM	SEM
Type of ignition system	CD	CD
Spark plug	NGK BPMR 7A/ Champion RCJ 7Y	NGK BPMR 7A/ Champion RCJ 7Y
Electrode gap, mm	0,5	0,5
Fuel and lubrication system		
Manufacturer of carburettor	Walbro	Walbro
Carburettor type	HDA 198/190	HDA 198
Fuel tank capacity, litre	0,68	0,68
Oil pump capacity at 9,000 rpm, ml/min	6-17	6-17
Oil tank capacity, litre	0,38	0,38
Type of oil pump	Automatic	Automatic
Weight		
Chain saw without bar or chain, empty tanks, kg	5,5: 357 XP, 357 XP E-tech 5,6: 357 XPG, 357 XPG E-tech	5,5: 359, 359 E-tech 5,6: 359 G, 359 G E-tech
Noise emissions (see note 1)		
Sound power level, measured dB(A)	113: 357 XP/G 111: 357 XP E-tech/G E-tech	113: 359 /G 111: 359 E-tech/G E-tech
Sound power level, guaranteed L _{WA} dB(A)	114: 357 XP/G 112: 357 XP E-tech/G E-tech	114: 359 /G 112: 359 E-tech/G E-tech
Noise levels (see note 2)		
Equivalent sound pressure level at operator's ear, measured according to relevant international standards, dB(A)		
Europe:	101: 357 XP/G 100: 357 XP E-tech/G E-tech	101: 359 /G 100: 359 E-tech/G E-tech
Australia:	102: 357 XP 100: 357 XP E-tech/XPG E-tech	100: 359 E-tech/G E-tech
Vibration levels (see note 3)		
Front handle, m/s ²	3,9	3,9
Rear handle, m/s ²	4,2	4,2
Chain/bar		
Standard bar length, inch/cm	15"/38	15"/38
Recommended bar lengths, inch/cm	13-24"/33-61	13-24"/33-61
Usable cutting length, inch/cm	12-23"/31-58	12-23"/31-58
Chain speed at max. power, m/sec	21,4	20,0
Pitch, inch/mm	0,325/8,25 3/8" /9,52	0,325/8,25 3/8" /9,52
Thickness of drive links, inch/mm	0,058/1,5	0,058/1,5
Number of teeth on drive sprocket	7	7

Note 1: Noise emissions in the environment measured as sound power (L_{WA}) in conformity with EC directive 2000/14/EC.

Note 2: Equivalent sound pressure level, according to ISO 7182, is calculated as the time-weighted energy total for noise pressure levels under various working conditions with the following time distribution: 1/3 idling, 1/3 max. load, 1/3 max. speed.



Note 3: Equivalent vibration level, according to ISO 7505, is calculated as the time-weighted energy total for vibration levels under various working conditions with the following time distribution: 1/3 idling, 1/3 max. load, 1/3 max. speed.

TECHNICAL DATA

Bar and chain combinations

The following combinations are CE approved.

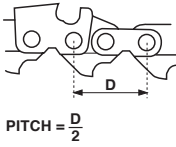
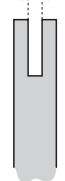
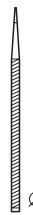
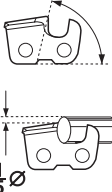
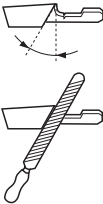
Bar			Chain
Length, inches	Pitch, inch	Max. number of teeth on tip sprocket	
13	0,325	10T	Husqvarna H25, Oregon 21BP
15	0,325	10T	
16	0,325	10T	
18	0,325	10T	
20	0,325	12T	
13	0,325	10T	Husqvarna H30, Oregon 95VP
15	0,325	10T	
16	0,325	10T	
18	0,325	10T	
15	3/8	11T	Husqvarna H42, Oregon 73LP
16	3/8	11T	
18	3/8	11T	
20	3/8	11T	
24	3/8	11T	

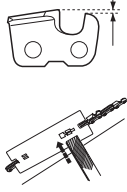
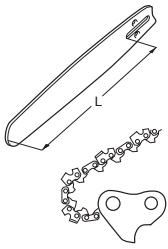
								
	inch	inch/mm	inch/mm				inch/mm	inch/cm: dl
H25	0,325"	0,058"/1,5	3/16" /4,8	85°	30°	10°	0,025"/0,65	13"/33:56 15"/38:64 16"/40:66 18"/46:72 20"/50:78
H30	0,325"	0,058"/1,5	3/16" /4,8	85°	30°	10°	0,025"/0,65	13"/33:56 15"/38:64 16"/40:66 18"/46:72 20"/50:78
H42	3/8"	0,058"/1,5	7/32" /5,5	60°	25°	10°	0,025"/0,65	15"/38:56 16"/41:60 18"/46:68 20"/51:72 24"/61:84

TECHNICAL DATA

EC-declaration of conformity

(Applies to Europe only)

Husqvarna AB, SE-561 82 Huskvarna, Sweden, tel: +46-36-146500, declares under sole responsibility that the chain saws **Husqvarna 357XP/XPG, 357XP E-tech/ XPG E-tech and 359 /G, 359 E-tech/ G E-tech** from 2002's serial numbers and onwards (the year is clearly stated in plain text on the type plate with subsequent serial number), are in conformity with the requirements of the COUNCIL'S DIRECTIVES:

of June 22, 1998 "relating to machinery" **98/37/EC**, annex IIA.

of May 3, 1989 "relating to electromagnetic compatibility" **89/336/EEC**, and applicable supplements.

of May 8, 2000 "relating to the noise emissions in the environment" **2000/14/EC**.

For information relating to noise emissions, see the chapter Technical data. The following standards have been applied: **EN292-2, CISPR 12:1997, EN608**.

Notified body: **0404, SMP Svensk Maskinprovning AB**, Fyrisborgsgatan 3, SE-754 50 Uppsala, Sweden, has carried out EC type examination in accordance with the machinery directive's (98/37/EC) article 8, point 2c. The certificates for EC type examination in accordance with annex VI, have the numbers: **404/99/679** – 357XP/G, 357 XP E-tech /G E-tech **404/99/681** – 359/G, 359 E-tech /G E-tech

In addition, SMP, Svensk Maskinprovning AB, Fyrisborgsgatan 3, SE-754 50 Uppsala, Sweden, has certified conformity with annex V of the Council's Directive of May 8, 2000 "relating to the noise emissions in the environment" 2000/14/EC. The certificates have the numbers: **01/161/013** - 357XP/G, 359 /G, **01/161/014** - 357XP E-tech/G E-tech, 359 E-tech/G E-tech.

The supplied chain saw conforms to the example that underwent EC type examination.

Huskvarna, 19 August 2002



Bo Andréasson, Development manager



1140205-26



2004-01-29

Free Manuals Download Website

<http://myh66.com>

<http://usermanuals.us>

<http://www.somanuals.com>

<http://www.4manuals.cc>

<http://www.manual-lib.com>

<http://www.404manual.com>

<http://www.luxmanual.com>

<http://aubethermostatmanual.com>

Golf course search by state

<http://golfingnear.com>

Email search by domain

<http://emailbydomain.com>

Auto manuals search

<http://auto.somanuals.com>

TV manuals search

<http://tv.somanuals.com>