

Operator's manual
240F 240R 250R
252RX 265RX

Please read the operator's manual carefully and make sure you understand the instructions before using the machine.



English

KEY TO SYMBOLS

Symbols

WARNING! Clearing saws, brushcutters and trimmers can be dangerous! Careless or incorrect use can result in serious or fatal injury to the operator or others.



Please read the operator's manual carefully and make sure you understand the instructions before using the machine.



Always wear:

- A protective helmet where there is a risk of falling objects
- Hearing protection
- Approved eye protection



Max. speed of output shaft, rpm



This product is in accordance with applicable EC directives.



Watch out for thrown objects and ricochets.



The operator of the machine must ensure, while working, that no persons or animals come closer than 15 metres.



Machines fitted with saw blades or grass blades can be thrown violently to the side when the blade comes into contact with a fixed object. The blade is capable of amputating an arm or leg. Always keep people and animals at least 15 metres from the machine.



Always wear approved protective gloves.



Wear sturdy, non-slip boots.



Only use non-metallic, flexible cutting attachments, i.e. trimmer heads with trimmer cord.



Noise emission to the environment according to the European Community's Directive. The machine's emission is specified in chapter Technical data and on label.



Other symbols/decals on the machine refer to special certification requirements for certain markets.

Switch off the engine by moving the stop switch to the STOP position before carrying out any checks or maintenance.

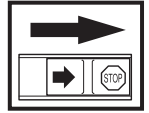

Always wear approved protective gloves.



Regular cleaning is required.

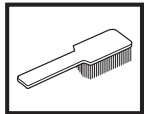

Visual check.



Approved eye protection must always be used.



CONTENTS

Contents

KEY TO SYMBOLS

Symbols 2

CONTENTS

Contents 3

Note the following before starting: 3

INTRODUCTION

Dear Customer, 4

WHAT IS WHAT?

What is what on the clearing saw? (240R) 5

What is what on the clearing saw? (240F) 6

What is what on the clearing saw? (250R) 7

What is what on the clearing saw? (252RX) 8

What is what on the clearing saw? (265RX) 9

GENERAL SAFETY PRECAUTIONS

Important 10

Personal protective equipment 10

Machine's safety equipment 11

Cutting equipment 14

ASSEMBLY

Assembling the handlebar and throttle (240R, 250R) ... 16

Fitting the handlebar (240F, 252RX) 16

Transport position, handlebar (240R, 240F, 250R, 252RX) 16

Fitting the handlebar (265RX) 17

Assembling the cutting equipment 17

Fitting a blade guard, grass blade and grass cutter 17

Fitting the blade guard and saw blade 18

Fitting the trimmer guard and trimmer head Trimmy SII 18

Fitting other guards and cutting attachments 19

Adjusting the harness and clearing saw 19

Standard harness 19

Triobalance harness 20

FUEL HANDLING

Fuel safety 21

Fuel 21

Fuelling 22

STARTING AND STOPPING

Check before starting 23

Starting and stopping 23

WORKING TECHNIQUES

General working instructions 25

MAINTENANCE

Carburettor 29

Muffler 31

Cooling system 32

Air filter 32

Bevel gear 33

Spark plug 33

Maintenance schedule 34

TECHNICAL DATA

Technical data 35

EC-declaration of conformity 38

Note the following before starting:

- Please read the operator's manual carefully.
- Long-term exposure to noise can result in permanent hearing impairment. So always use approved hearing protection.



WARNING! Under no circumstances may the design of the machine be modified without the permission of the manufacturer. Always use genuine accessories. Non-authorized modifications and/or accessories can result in serious personal injury or the death of the operator or others.



WARNING! A clearing saw, brushcutter or trimmer can be dangerous if used incorrectly or carelessly, and can cause serious or fatal injury to the operator or others. It is extremely important that you read and understand the contents of this operator's manual.

INTRODUCTION

Dear Customer,

Congratulations on your choice to buy a Husqvarna product! Husqvarna is based on a tradition that dates back to 1689, when the Swedish King Charles XI ordered the construction of a factory on the banks of the Husqvarna River, for production of muskets. The location was logical, since water power was harnessed from the Huskvarna River to create the water-powered plant. During the more than 300 years of being, the Husqvarna factory has produced a lot of different products, from wood stoves to modern kitchen appliances, sewing machines, bicycles, motorcycles etc. In 1956, the first motor driven lawn mowers appeared, followed by chain saws in 1959, and it is within this area Husqvarna is working today.

Today Husqvarna is one of the leading manufacturers in the world of forest and garden products, with quality as our highest priority. The business concept is to develop, manufacture and market motor driven products for forestry and gardening as well as for building and construction industry. Husqvarna's aim is also to be in the front edge according to ergonomics, usability, security and environmental protection. That is the reason why we have developed many different features to provide our products within these areas.

We are convinced that you will appreciate with great satisfaction the quality and performance of our product for a very long time to come. The purchase of one of our products gives you access to professional help with repairs and service whenever this may be necessary. If the retailer who sells your machine is not one of our authorised dealers, ask for the address of your nearest service workshop.

It is our wish that you will be satisfied with your product and that it will be your companion for a long time. Think of this operator's manual as a valuable document. By following its' content (using, service, maintenance etc) the life span and the second-hand value of the machine can be extended. If you will sell this machine, make sure that the buyer will get the operator's manual.

Thank you for using a Husqvarna product.

Husqvarna AB has a policy of continuous product development and therefore reserves the right to modify the design and appearance of products without prior notice.

WHAT IS WHAT?

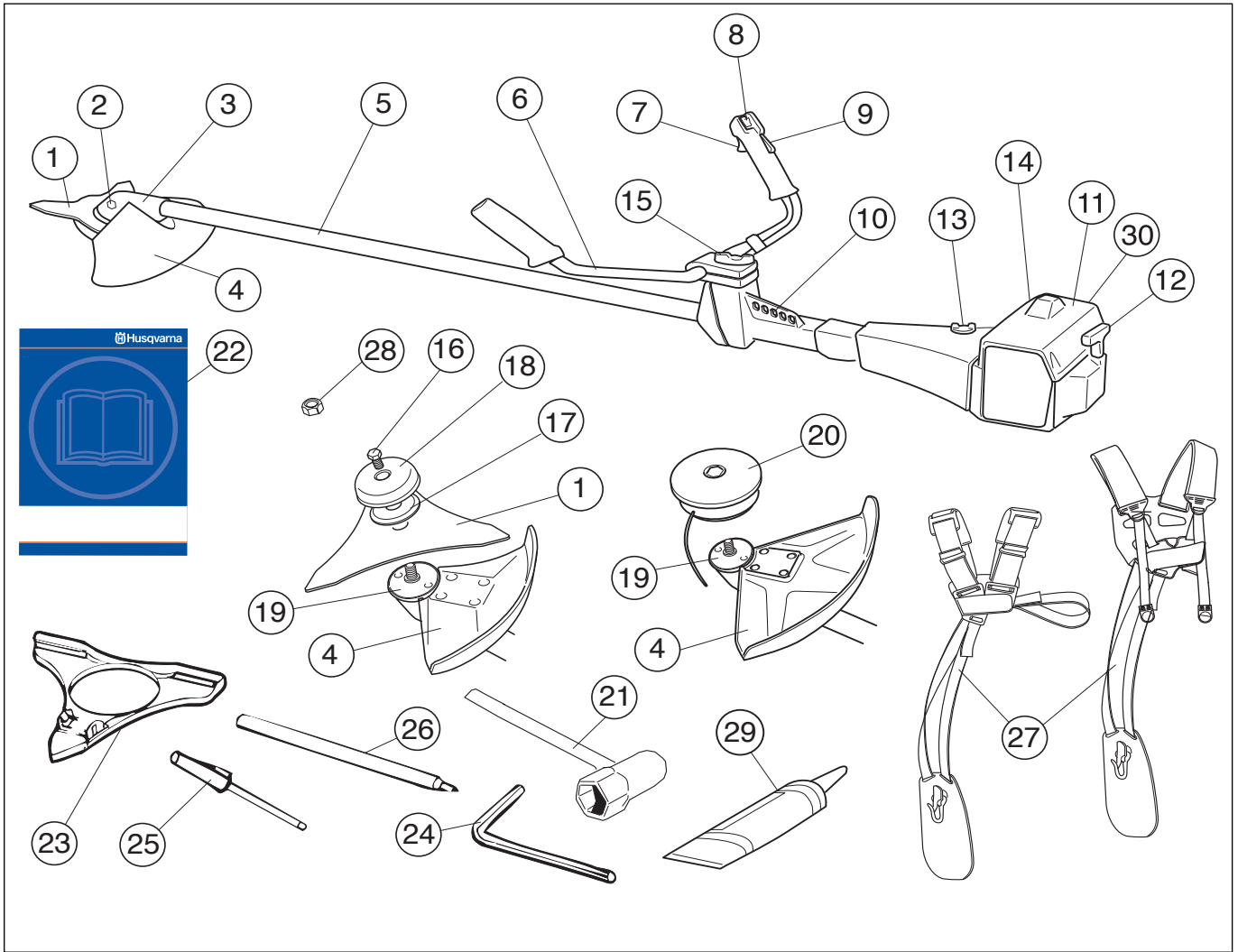

What is what on the clearing saw? (240R)

- | | |
|---------------------------------|--------------------------------|
| 1 Blade | 16 Locking screw (support cup) |
| 2 Grease filler cap, bevel gear | 17 Support flange |
| 3 Bevel gear | 18 Support cup |
| 4 Cutting attachment guard | 19 Drive disc |
| 5 Shaft | 20 Trimmer head |
| 6 Handlebar | 21 Socket spanner |
| 7 Throttle control | 22 Operator's manual |
| 8 Stop switch | 23 Transport guard |
| 9 Throttle lock | 24 Allen key |
| 10 Support eyes for harness | 25 Carburettor screwdriver |
| 11 Cylinder cover | 26 Locking pin |
| 12 Starter handle | 27 Harness |
| 13 Fuel tank | 28 Locking nut |
| 14 Choke control | 29 Gearbox grease |
| 15 Handle adjustment | 30 Air filter |

WHAT IS WHAT?

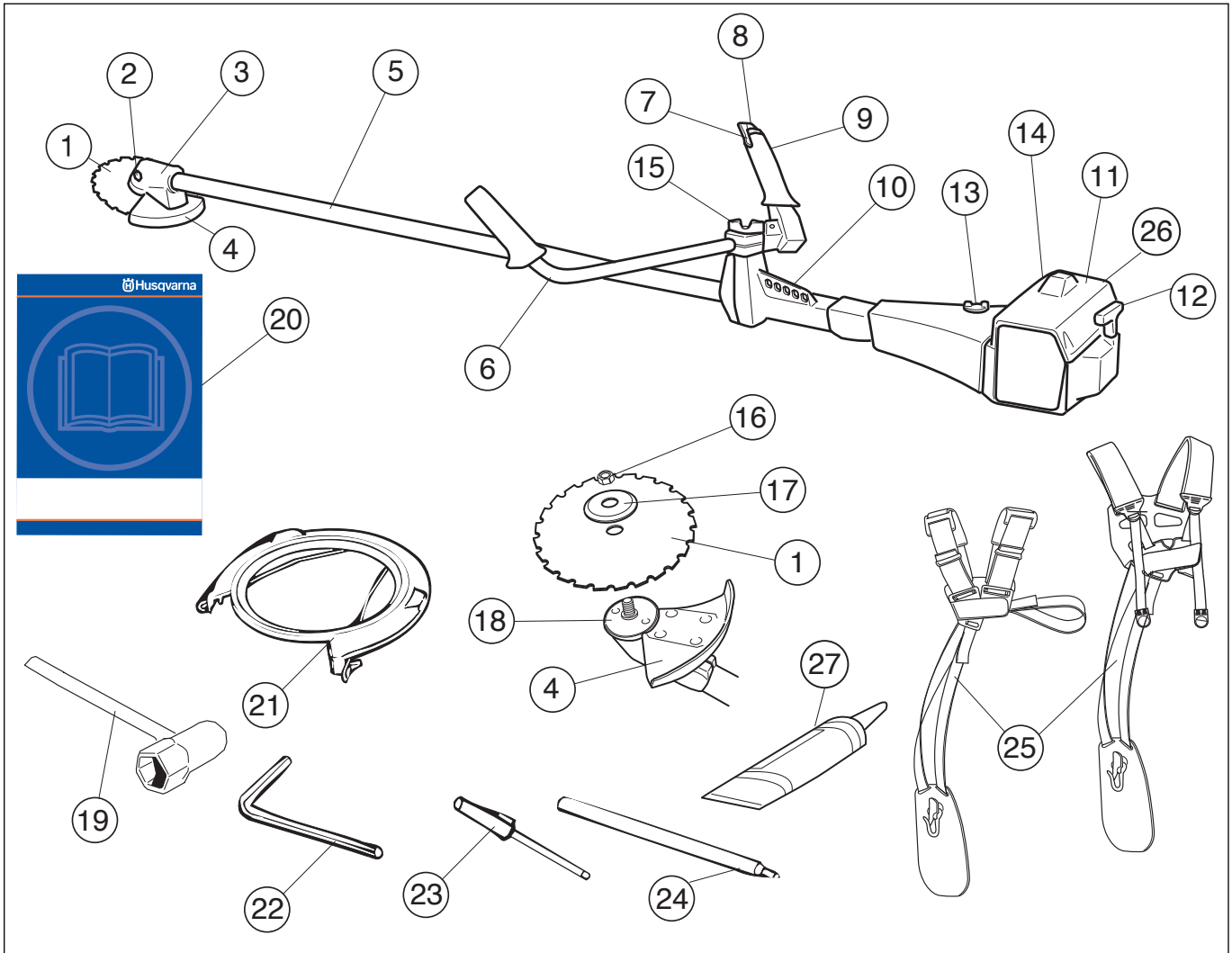

What is what on the clearing saw? (240F)

- | | |
|---------------------------------|----------------------------|
| 1 Blade | 15 Handle adjustment |
| 2 Grease filler cap, bevel gear | 16 Locking nut |
| 3 Bevel gear | 17 Support flange |
| 4 Cutting attachment guard | 18 Drive disc |
| 5 Shaft | 19 Socket spanner |
| 6 Handlebar | 20 Operator's manual |
| 7 Throttle control | 21 Transport guard |
| 8 Stop switch | 22 Allen key |
| 9 Throttle lock | 23 Carburettor screwdriver |
| 10 Support eyes for harness | 24 Locking pin |
| 11 Cylinder cover | 25 Harness |
| 12 Starter handle | 26 Air filter |
| 13 Fuel tank | 27 Gearbox grease |
| 14 Choke control | |

WHAT IS WHAT?

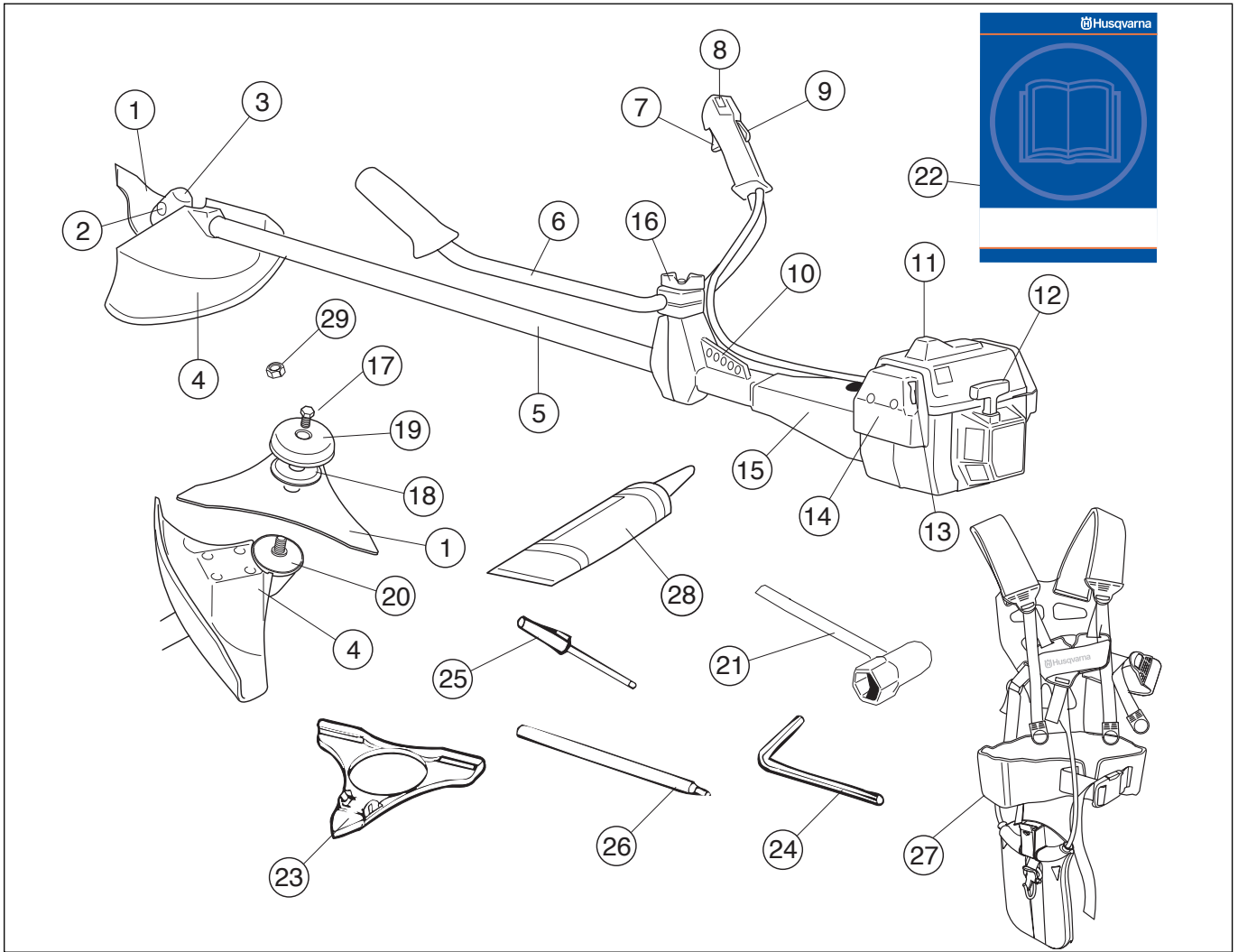

What is what on the clearing saw? (250R)

- | | |
|---------------------------------|--------------------------------|
| 1 Blade | 16 Handle adjustment |
| 2 Grease filler cap, bevel gear | 17 Locking screw (support cup) |
| 3 Bevel gear | 18 Support flange |
| 4 Cutting attachment guard | 19 Support cup |
| 5 Shaft | 20 Drive disc |
| 6 Handlebar | 21 Socket spanner |
| 7 Throttle control | 22 Operator's manual |
| 8 Stop switch | 23 Transport guard |
| 9 Throttle lock | 24 Allen key |
| 10 Support eyes for harness | 25 Carburettor screwdriver |
| 11 Cylinder cover | 26 Locking pin |
| 12 Starter handle | 27 Harness |
| 13 Choke control | 28 Gearbox grease |
| 14 Air filter | 29 Locking nut |
| 15 Fuel tank | |

WHAT IS WHAT?

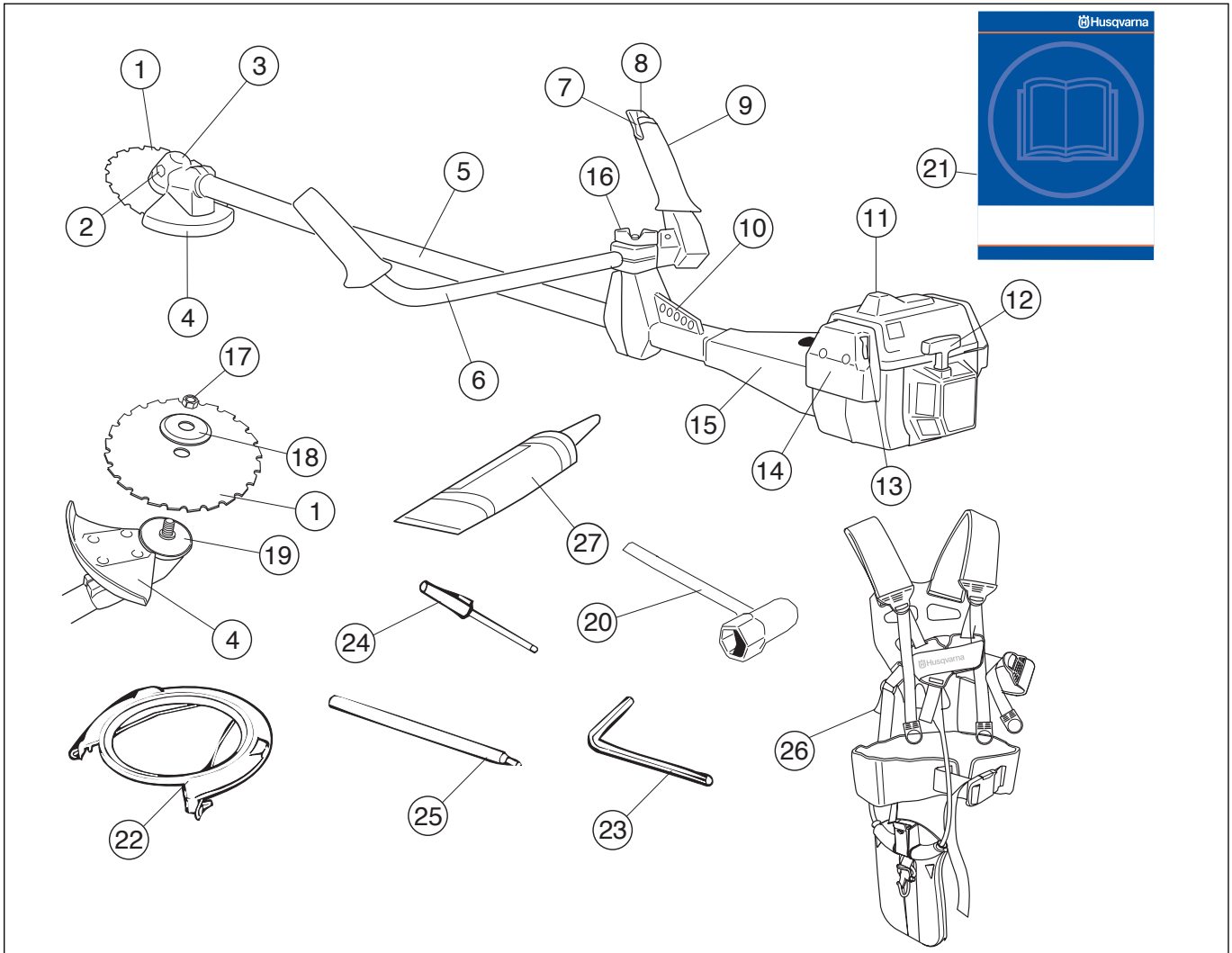

What is what on the clearing saw? (252RX)

- | | |
|---------------------------------|----------------------------|
| 1 Blade | 15 Fuel tank |
| 2 Grease filler cap, bevel gear | 16 Handle adjustment |
| 3 Bevel gear | 17 Locking nut |
| 4 Cutting attachment guard | 18 Support flange |
| 5 Shaft | 19 Drive disc |
| 6 Handlebar | 20 Socket spanner |
| 7 Throttle control | 21 Operator's manual |
| 8 Stop switch | 22 Transport guard |
| 9 Throttle lock | 23 Allen key |
| 10 Support eyes for harness | 24 Carburettor screwdriver |
| 11 Cylinder cover | 25 Locking pin |
| 12 Starter handle | 26 Harness |
| 13 Choke control | 27 Gearbox grease |
| 14 Air filter | |

WHAT IS WHAT?

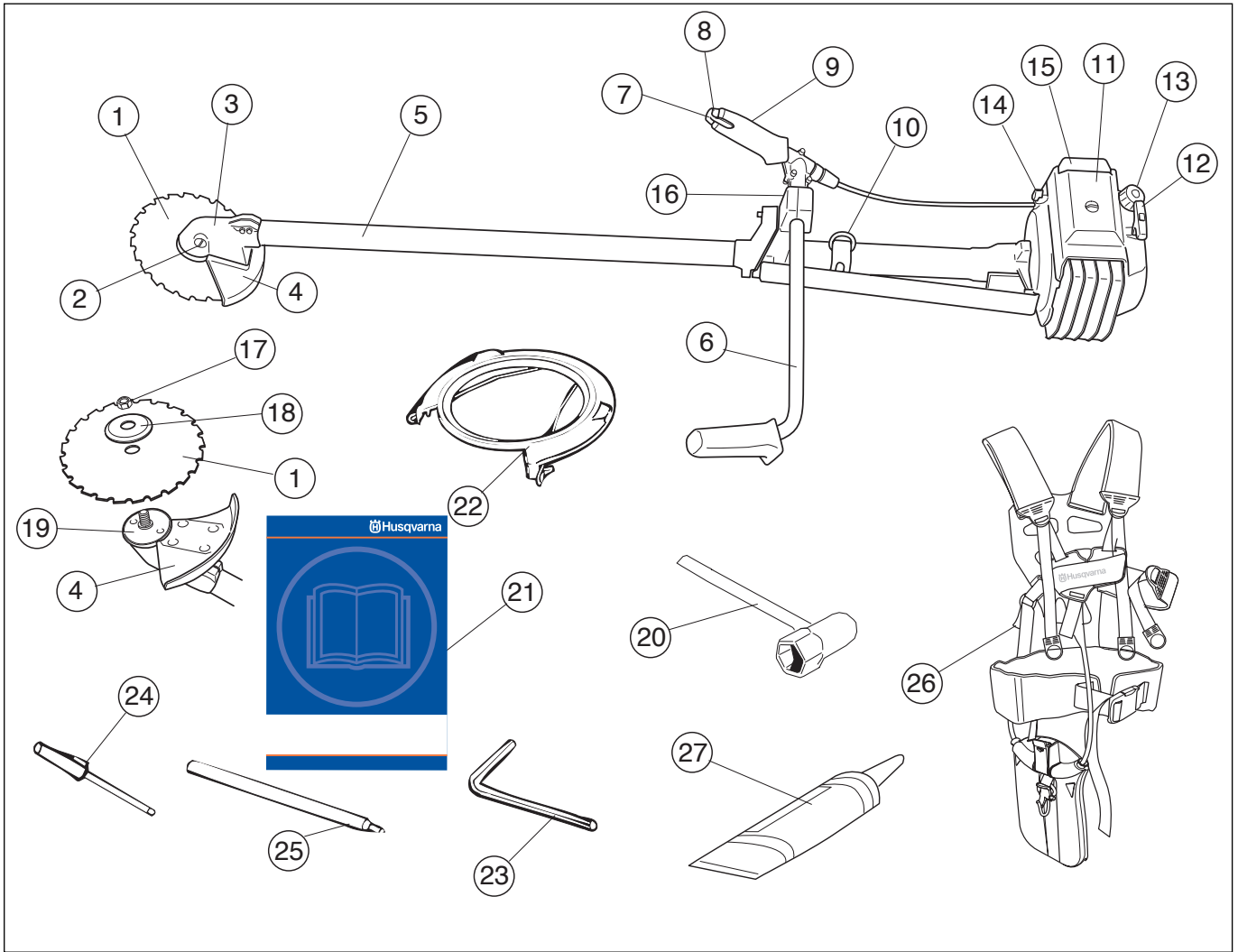

What is what on the clearing saw? (265RX)

- | | |
|---------------------------------|----------------------------|
| 1 Blade | 15 Air filter |
| 2 Grease filler cap, bevel gear | 16 Handle adjustment |
| 3 Bevel gear | 17 Locking nut |
| 4 Cutting attachment guard | 18 Support flange |
| 5 Shaft | 19 Drive disc |
| 6 Handlebar | 20 Socket spanner |
| 7 Throttle control | 21 Operator's manual |
| 8 Stop switch | 22 Transport guard |
| 9 Throttle lock | 23 Allen key |
| 10 Support eyes for harness | 24 Carburettor screwdriver |
| 11 Cylinder cover | 25 Locking pin |
| 12 Starter handle | 26 Harness |
| 13 Fuel tank | 27 Gearbox grease |
| 14 Choke control | |

GENERAL SAFETY PRECAUTIONS

Important

IMPORTANT!

The machine is only designed for trimming grass, grass clearing and/or forestry clearing.

The only accessories you can operate with this engine unit are the cutting attachments we recommend in the chapter on Technical data.

Never use the machine if you are tired, if you have drunk alcohol, or if you are taking medication that could affect your vision, your judgement or your co-ordination.

Wear personal protective equipment. See instructions under the heading Personal protective equipment.

Never use a machine that has been modified in any way from its original specification.

Never use a machine that is faulty. Carry out the checks, maintenance and service instructions described in this manual. Some maintenance and service measures must be carried out by trained and qualified specialists. See instructions under the heading Maintenance.

All covers and guards must be fitted before starting. Ensure that the spark plug cap and ignition lead are undamaged to avoid the risk of electric shock.

The machine operator must ensure that no people or animals come closer than 15 metres while working. When several operators are working in the same area the safety distance should be at least twice the tree height and no less than 15 metres.

Personal protective equipment

IMPORTANT!

A clearing saw, brushcutter or trimmer can be dangerous if used incorrectly or carelessly, and can cause serious or fatal injury to the operator or others. It is extremely important that you read and understand the contents of this operator's manual.

You must use approved personal protective equipment whenever you use the machine. Personal protective equipment cannot eliminate the risk of injury but it will reduce the degree of injury if an accident does happen. Ask your dealer for help in choosing the right equipment.



WARNING! Listen out for warning signals or shouts when you are wearing hearing protection. Always remove your hearing protection as soon as the engine stops.

HELMET

A helmet should be worn if the trees being cleared are taller than 2 m.



HEARING PROTECTION

Wear hearing protection that provides adequate noise reduction.



EYE PROTECTION

Always wear approved eye protection. If you use a visor then you must also wear approved protective goggles. Approved protective goggles must comply with standard ANSI Z87.1 in the USA or EN 166 in EU countries.

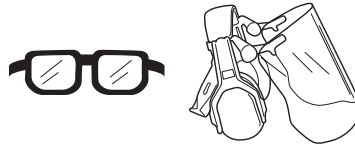

GLOVES

Gloves should be worn when necessary, e.g., when fitting cutting attachments.



BOOTS

Wear sturdy, non-slip boots.



CLOTHING

Wear clothes made of a strong fabric and avoid loose clothing that can catch on twigs and branches. Always wear heavy, long pants. Do not wear jewellery, shorts sandals or go barefoot. Secure hair so it is above shoulder level.

FIRST AID KIT

Always have a first aid kit nearby.



GENERAL SAFETY PRECAUTIONS

Machine's safety equipment

This section describes the machine's safety equipment, its purpose, and how checks and maintenance should be carried out to ensure that it operates correctly. See the "What is what?" section to locate where this equipment is positioned on your machine.

The life span of the machine can be reduced and the risk of accidents can increase if machine maintenance is not carried out correctly and if service and/or repairs are not carried out professionally. If you need further information please contact your nearest service workshop.

IMPORTANT!

All servicing and repair work on the machine requires special training. This is especially true of the machine's safety equipment. If your machine fails any of the checks described below you must contact your service agent. When you buy any of our products we guarantee the availability of professional repairs and service. If the retailer who sells your machine is not a servicing dealer, ask him for the address of your nearest service agent.



WARNING! Never use a machine with faulty safety equipment. The machine's safety equipment must be checked and maintained as described in this section. If your machine fails any of these checks contact your service agent to get it repaired.

Throttle lock

The throttle lock is designed to prevent accidental operation of the throttle control. When you press the lock (A) (i.e. when you grasp the handle) it releases the throttle control (B). When you release the handle the throttle control and the throttle lock both move back to their original positions. This movement is controlled by two independent return springs. This arrangement means that the throttle control is automatically locked at the idle setting.

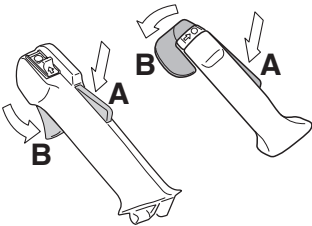

Make sure the throttle control is locked at the idle setting when the throttle lock is released.

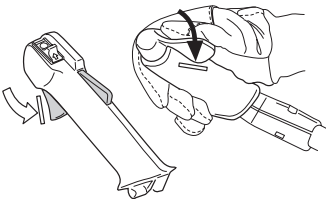

Press the throttle lock and make sure it returns to its original position when you release it.

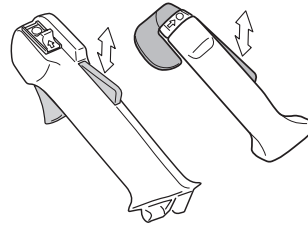

Check that the throttle control and throttle lock move freely and that the return springs work properly.

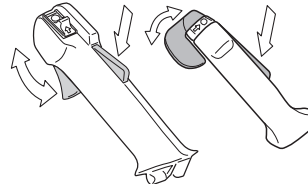

See instructions under the heading Start. Start the machine and apply full throttle. Release the throttle and check that the cutting attachment stops and remains at a standstill. If the cutting attachment rotates with the throttle in the idle position then the carburettor idle setting must be checked. See instructions under the heading Maintenance.

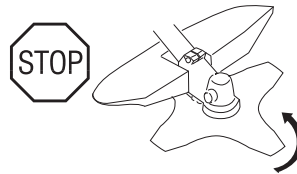
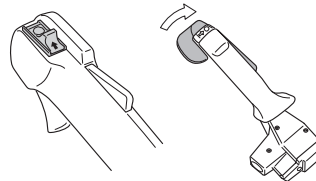

Stop switch

Use the stop switch to switch off the engine.

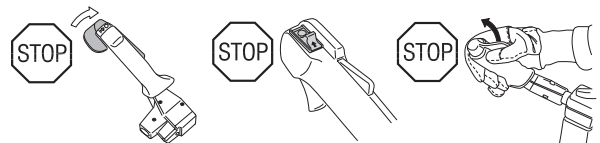

Start the engine and make sure the engine stops when you move the stop switch to the stop setting.

GENERAL SAFETY PRECAUTIONS

Cutting attachment guard

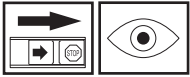

This guard is intended to prevent loose objects from being thrown towards the operator. The guard also protects the operator from accidental contact with the cutting attachment.

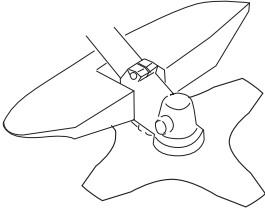

Check that the guard is undamaged and not cracked. Replace the guard if it has been exposed to impact or is cracked.

Always use the recommended guard for the cutting attachment you are using. See chapter on Technical data.



WARNING! Never use a cutting attachment without an approved guard. See the chapter on Technical data. If an incorrect or faulty guard is fitted this can cause serious personal injury.

Vibration damping system

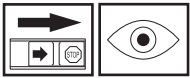

Your machine is equipped with a vibration damping system that is designed to minimize vibration and make operation easier.

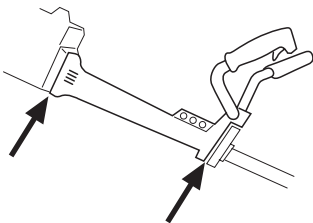

Use of incorrectly wound cord or an incorrect cutting attachment increases the level of vibration. See instructions under the heading Cutting equipment.

The machine's vibration damping system reduces the transfer of vibration between the engine unit/cutting equipment and the machine's handle unit.

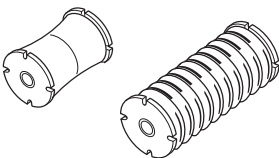

Regularly check the vibration damping units for cracks or deformation. Check that the vibration damping element is undamaged and securely attached.



WARNING! Overexposure to vibration can lead to circulatory damage or nerve damage in people who have impaired circulation. Contact your doctor if you experience symptoms of overexposure to vibration. Such symptoms include numbness, loss of feeling, tingling, pricking, pain, loss of strength, changes in skin colour or condition. These symptoms normally appear in the fingers, hands or wrists. The risk increases at low temperatures.

Quick release

There is an easily accessible, quick release fitted at the front as a safety precaution in case the engine catches fire, or in any other situation that requires you to free yourself from the machine and harness. See instructions under the heading Adjusting the harness and clearing saw.

Certain harnesses also have a quick release fitted to the support hook.

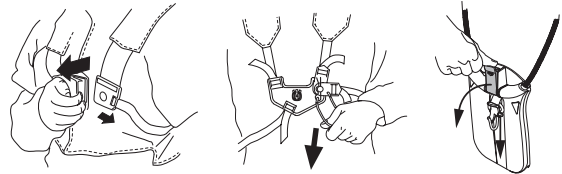

Check that the harness straps are correctly positioned. Once the harness and machine have been adjusted, check that the harness quick release works correctly.

Muffler



The muffler is designed to keep noise levels to a minimum and to direct exhaust fumes away from the user.

A muffler fitted with a catalytic converter is also designed to reduce harmful exhaust gases.



In countries that have a warm and dry climate there is a significant risk of fire. We therefore fit certain mufflers with a spark arrestor mesh. Check whether the muffler on your machine is fitted with this kind of mesh.

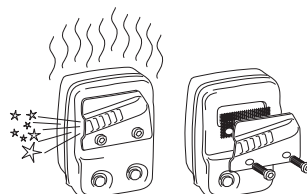

GENERAL SAFETY PRECAUTIONS

For mufflers it is very important that you follow the instructions on checking, maintaining and servicing your machine. See instructions under the heading Checking, maintaining and servicing the machine's safety equipment.

Never use a machine that has a faulty muffler.



Regularly check that the muffler is securely attached to the machine.

If the muffler on your machine is fitted with a spark arrestor mesh this must be cleaned regularly. A blocked mesh will cause the engine to overheat and may lead to serious damage.

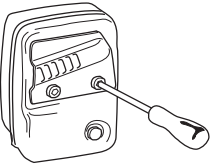

WARNING! Mufflers fitted with catalytic converters get very hot during use and remain so for some time after stopping. This also applies at idle speed. Contact can result in burns to the skin. Remember the risk of fire!



WARNING! The inside of the muffler contain chemicals that may be carcinogenic. Avoid contact with these elements in the event of a damaged muffler.



WARNING! Bear in mind that:

Engine exhaust fumes contain carbon monoxide, which can cause carbon monoxide poisoning. For this reason you should not start or run the machine indoors, or anywhere that is poorly ventilated.

The exhaust fumes from the engine are hot and may contain sparks which can start a fire. Never start the machine indoors or near combustible material!

Locking nut

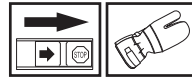

A locking nut is used to secure some types of cutting attachment.

When fitting, tighten the nut in the opposite direction to the direction of rotation of the cutting attachment. To remove it, undo the nut in the same direction as the cutting attachment rotates. (CAUTION! The nut has a left-hand thread.)

When loosening and tightening the saw blade nut, there is a risk of injury from the teeth of the saw blade. You should therefore always ensure that your hand is shielded by the blade guard when doing this. Always use a socket spanner with a shaft that is long enough to allow this. The arrow in the diagram shows the area where you should operate the socket spanner when loosening or tightening the nut.

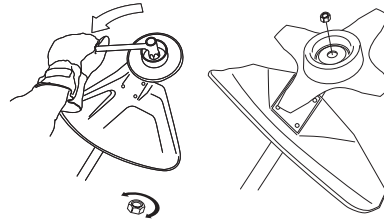

The nylon lining inside the locking nut must not be so worn that you can turn it by hand. The lining should offer a resistance of at least 1.5 Nm. The nut should be replaced after it has been put on approx. 10 times.

Locking screw

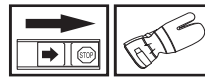

The lock screw must be tightened securely for ball-bearing-mounted support cups.

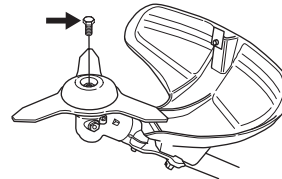

GENERAL SAFETY PRECAUTIONS

Cutting equipment

This section describes how to choose and maintain your cutting equipment in order to:

- Reduce the risk of blade thrust.
- Obtain maximum cutting performance.
- Extend the life of cutting equipment.

IMPORTANT!

Only use cutting attachments with the guards we recommend! See the chapter on Technical data.

Refer to the instructions for the cutting attachment to check the correct way to load the cord and the correct cord diameter.

Keep the teeth of the blade correctly sharpened! Follow our recommendations. Also refer to the instructions on the blade packaging.

Maintain the correct blade setting! Follow our instructions and use the recommended file gauge.



WARNING! Always stop the engine before doing any work on the cutting attachment. This continues to rotate even after the throttle has been released. Ensure that the cutting attachment has stopped completely and disconnect the HT lead from the spark plug before you start to work on it.



WARNING! Using an incorrect cutting attachment or an incorrectly sharpened blade increases the risk of kickback.

Cutting equipment

Saw blades are intended for cutting fibrous types of wood.

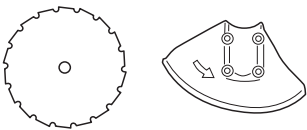

Grass blades and grass cutters are intended for cutting coarse grass.

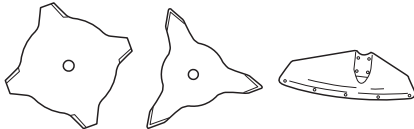

A trimmer head is intended for trimming grass.



General rules



Only use cutting attachments with the guards we recommend! See the chapter on Technical data.

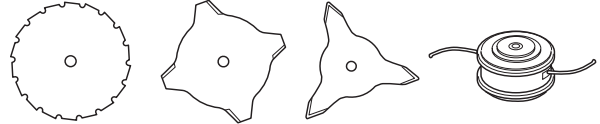

Keep the teeth of the blade correctly sharpened! Follow our instructions and use the recommended file gauge. An incorrectly sharpened or damaged blade increases the risk of accidents.

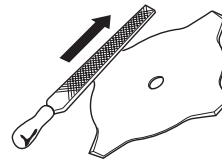

Keep the correct setting on the saw blade! Follow our instructions and use the recommended setting tool. An incorrectly set saw blade increases the risk of jamming and kickback, and damage to the saw blade.

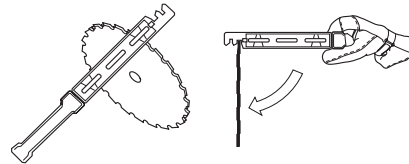

Check the cutting attachment for damage or cracks. A damaged cutting attachment should always be replaced.

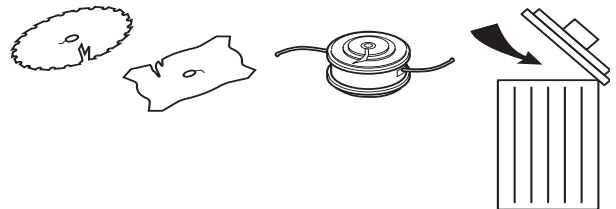

Sharpening grass cutters and grass blades

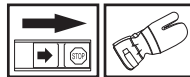

- See the cutting attachment packaging for correct sharpening instructions. Sharpen blades and cutters using a single-cut flat file.
- Sharpen all edges equally to maintain the balance of the blade.

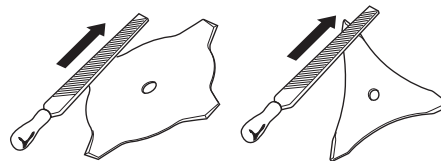

WARNING! Always discard a blade that is bent, twisted, cracked, broken or damaged in any other way. Never attempt to straighten a twisted blade so that it can be reused. Only use original blades of the specified type.

GENERAL SAFETY PRECAUTIONS

Sharpening the saw blade



- See the cutting attachment packaging for correct sharpening instructions.

A correctly sharpened blade is essential for working efficiently and to avoid unnecessary wear to the blade and clearing saw.



- Make sure that the blade is well supported when you file it. Use a 5.5 mm round file with a file holder.

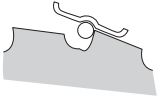

- The filing angle is 15°. File alternate teeth to the right and those in between to the left. If the blade has been heavily pitted by stones it may be necessary to dress the top edges of the teeth with a flat file, in exceptional cases. If so, this should be done before filing with a round file. The top edges must be filed down by the same amount for all the teeth.

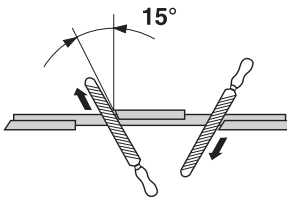

Adjust the blade setting. This should be 1 mm.

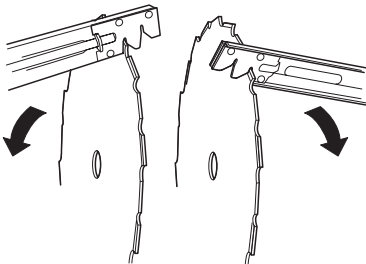

Trimmer head

IMPORTANT!

Always ensure the trimmer cord is wound tightly and evenly around the drum, otherwise the machine will generate harmful vibration.

- Only use the recommended trimmer heads and trimmer cords. These have been tested by the manufacturer to suit a particular engine size. This is especially important when a fully automatic trimmer head is used. Only use the recommended cutting attachment. See the chapter on Technical data.

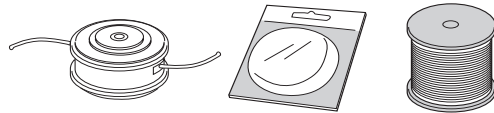

- Smaller machines generally require small trimmer heads and vice versa. This is because when clearing using a cord the engine must throw out the cord radially from the trimmer head and overcome the resistance of the grass being cleared.
- The length of the cord is also important. A longer cord requires greater engine power than a shorter cord of the same diameter.
- Make sure that the cutter on the trimmer guard is intact. This is used to cut the cord to the correct length.
- To increase the life of the cord it can be soaked in water for a couple of days. This will make the line tougher so that it lasts longer.

ASSEMBLY

Assembling the handlebar and throttle

(240R, 250R)



- Remove the screw at the rear of the throttle handle.
- Slide the throttle handle onto the right side of the handlebar, (see diagram).

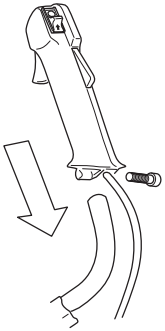

- Align the screw hole in the throttle handle with the hole in the handlebar.
- Refit the screw in the hole in the rear of the throttle handle.
- Screw the screw through the handle and handlebar. Tighten it.
- Unscrew the knob from the handlebar mounting.
- Position the handlebar as shown. Fit the mounting components and tighten the knob lightly.

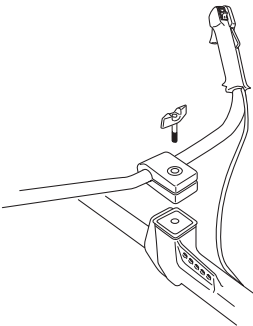

- Put on the harness and hang the machine from the support hook. Now make a final adjustment so that the machine is in a comfortable working position when it hangs from the harness.



- Tighten the knob.

Fitting the handlebar

(240F, 252RX)



- Unscrew the knob from the handlebar mounting.
- Position the handlebar as shown. Fit the mounting components and tighten the knob lightly.

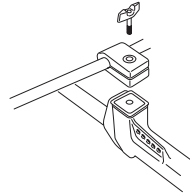

- Fit the right handle to the handlebar using the screw, washer, sleeve and nut as shown. Tighten.

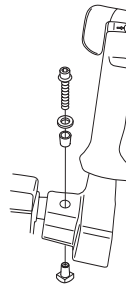

- Put on the harness and hang the machine from the support hook. Now make a final adjustment so that the machine is in a comfortable working position when it hangs from the harness.

Tighten the knob.



Transport position, handlebar

(240R, 240F, 250R, 252RX)



- The handlebar can easily be turned to fit along the shaft for easier transportation and storage.
- Loosen the knob. Turn the handlebar clockwise so that the throttle handle rests against the engine.
- Now twist the handlebar around the shaft. Tighten the knob.

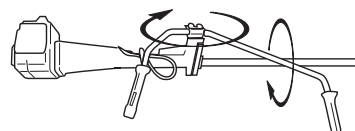

- Fit the transport guard to the cutting attachment.

ASSEMBLY

Fitting the handlebar

(265RX)



- Fit the left handlebar in the handlebar mounting.
- Fit the right handle to the handlebar.
- Adjust roughly and tighten the screws slightly.

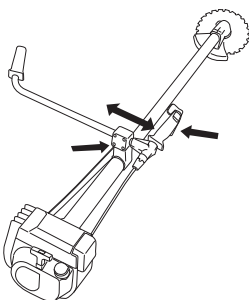

- Now make a final adjustment, with the machine hanging from the harness, to obtain the most comfortable working position. Tighten the screws.



- Make the final adjustment to the right handle and lock it in the most comfortable position.

Adjusting the throttle trigger

The throttle trigger can be adjusted to give the best working position. This is done using the Allen screws by the right handle.

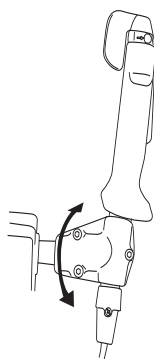

Assembling the cutting equipment



WARNING!

When fitting the cutting attachment it is extremely important that the raised section on the drive disc/support flange engages correctly in the centre hole of the cutting attachment. If the cutting attachment is fitted incorrectly it can result in serious and/or fatal personal injury.

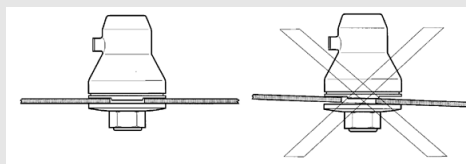

WARNING! Never use a cutting attachment without an approved guard. See the chapter on Technical data. If an incorrect or faulty guard is fitted this can cause serious personal injury.

IMPORTANT! If a saw blade or grass blade are to be used the machine must be equipped with the correct handlebar, blade guard and harness.

Fitting a blade guard, grass blade and grass cutter



- The blade guard (A) is fitted using 4 screws (L) and the support plate (M) as shown.

CAUTION! Always use the recommended guard for the cutting attachment you are using. See chapter on Technical data.

- Fit the drive disc (B) on the output shaft.
- Turn the blade shaft until one of the holes in the drive disc aligns with the corresponding hole in the gear housing.
- Insert the locking pin (C) in the hole to lock the shaft.
- Place the blade (D) on the output shaft.

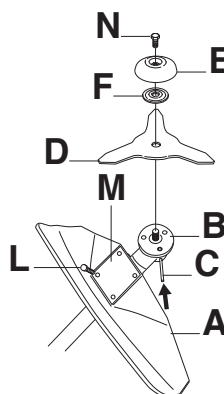

ASSEMBLY

- Fit the support flange (F) on the output shaft. Make sure that the blade is centered by fitting it to the guide on the support flange.
- Screw the support cup (E) onto the output shaft threads (CAUTION! Left-hand thread). Tighten to a torque of 35-50 Nm (3.5-5.0 kpm). Use the socket spanner in the tool kit. Note that the locking pin (C) must remain inside the gear housing to lock the drive disk. Hold the shaft of the socket spanner as close to the blade guard/combination guard as possible.

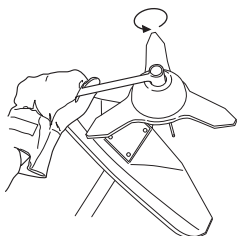

WARNING! Tighten the lock screw (N) in the center hole of the support cup. Tighten to a torque of 35-50 Nm (3.5-5.0 kpm), CAUTION! Left-hand thread. If the lock screw is not fitted in the support cup, there is a risk that the support cup will come unscrewed. This means that the blade will also come loose, which could result in serious or fatal injury to the operator or others.

Fitting the blade guard and saw blade



- The blade guard (A) is fitted using 4 screws (L) as shown.

CAUTION!

Always use the recommended guard for the cutting attachment you are using. See chapter on Technical data.

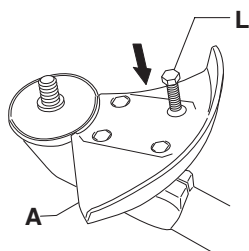

- Fit the drive disc (B) on the output shaft.
- Turn the blade shaft until one of the holes in the drive disc aligns with the corresponding hole in the gear housing.
- Insert the locking pin (C) in the hole to lock the shaft.
- Place the blade (D) and support flange (F) on the output shaft.
- Fit the nut (G). Tighten the nut to a torque of 35-50 Nm. Use the socket spanner in the tool kit. Grasp the handle of the spanner as close to the blade guard/combination guard as possible.

To tighten the nut, turn the spanner in the opposite direction to the direction of rotation (Caution! left-hand thread).

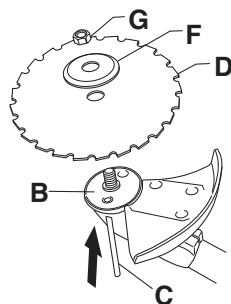

When loosening and tightening the saw blade nut, there is a risk of injury from the teeth of the saw blade. You should therefore always ensure that your hand is shielded by the blade guard when doing this. Always use a socket spanner with a shaft that is long enough to allow this. The arrow in the diagram shows the area where you should operate the socket spanner when loosening or tightening the nut.

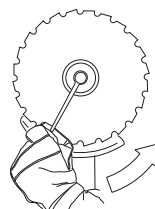

Fitting the trimmer guard and trimmer head Trimmy SII



- Fit the correct trimmer guard (A) for use with the trimmer head. Secure the trimmer guard using the 4 screws (L) and the support plate (M) as shown.
- Fit the drive disc (B) on the output shaft.
- Turn the blade shaft until one of the holes in the drive disc aligns with the corresponding hole in the gear housing.
- Insert the locking pin (C) in the hole to lock the shaft.

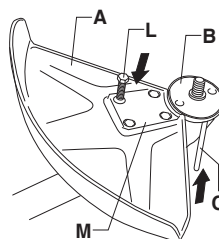

- Screw on the trimmer head/plastic blades (H) in the opposite direction to the direction of rotation.
- Tighten the trimmer head to a torque of 35-50 Nm.

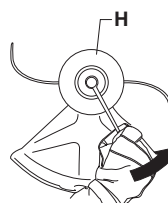

- To dismantle, follow the instructions in the reverse order.

ASSEMBLY

Fitting other guards and cutting attachments



Fit the trimmer guard/combination guard (A) intended for use with the trimmer head/plastic blades. Secure the trimmer guard using the 4 screws (L) and the support plate (M) as shown.

- Fit the drive disc (B) on the output shaft.
- Turn the blade shaft until one of the holes in the drive disc aligns with the corresponding hole in the gear housing.
- Insert the locking pin (C) in the hole to lock the shaft.

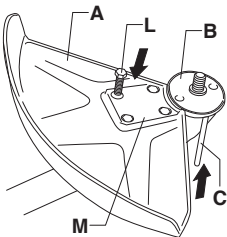

- Screw on the trimmer head/plastic blades (H) in the opposite direction to the direction of rotation.

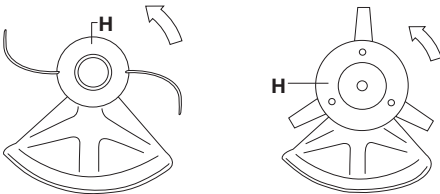

- To dismantle, follow the instructions in the reverse order.

Adjusting the harness and clearing saw



WARNING! When using a clearing saw it must always be hooked securely to the harness. Otherwise you will be unable to control the clearing saw safely and this can result in injury to yourself or others. Never use a harness with a defective quick release.

Standard harness



Safety release

At the front is an easily accessible, quick release. Use this if the engine catches fire or in any other emergency situation that requires you to free yourself from the machine and harness.

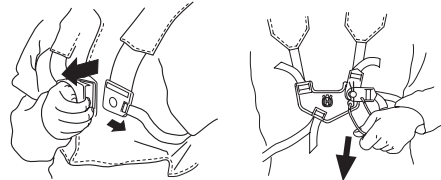

Spreading the load on your shoulders

A well-adjusted harness and machine makes work much easier. Adjust the harness for the best working position. Tension the side straps so that the weight is evenly distributed across both shoulders.



Correct height

1 Forestry clearing

The machine should be supported in a harness when forestry clearing so that the cutting equipment is angled slightly forwards in relation to the ground. Adjust the height using the strap on the harness for the support hook.

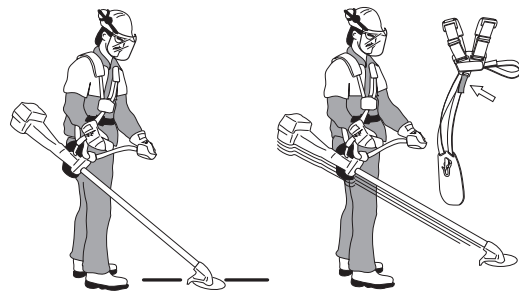

2 Grass clearing

The machine should be supported in a harness when grass clearing so that the cutting equipment is parallel to the ground.



ASSEMBLY

Triobalance harness



Safety release

Push down the red release lever to release the machine from the harness.

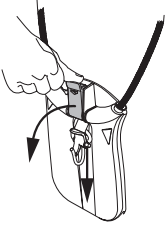

Adjusting the harness

- 1 Tighten the hip strap so that it sits securely.

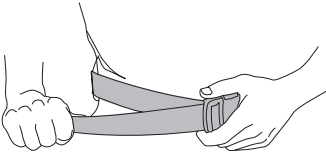

- 2 Tighten the chest strap under your left arm so that it fits closely around your body.

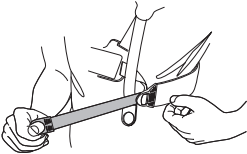

- 3 Adjust the shoulder strap to distribute the load evenly across your shoulders. Press downwards on the suspension hook to load the harness.



- 4 Adjust the height of the suspension hook as described in the instructions for the standard harness. (Forestry clearing)



- 5 If you need to lower the suspension hook, for trimming for example, move the suspension strap (A) to the lower mounting point on the backplate.

- 6 The elastic strap (B) can be tightened to transfer more load from the shoulder straps to the hip strap.

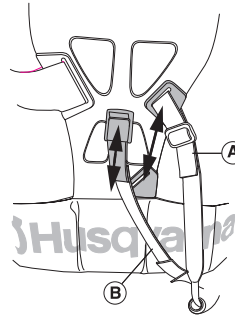

Correct balance

1 Forestry clearing

The machine is balanced by moving the support ring on the machine forwards or backwards. On some models the support ring is fixed, however, this will then have a number of holes for the support hook. The machine is correctly balanced when it freely hangs horizontally from the support hook. In this way the risk of hitting stones is reduced if you need to release the handlebar.

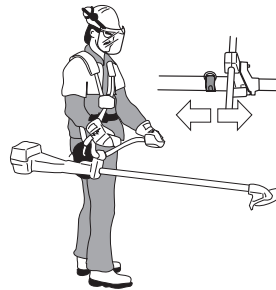

2 Grass clearing

Let the blade balance at a comfortable cutting height, i.e. close to the ground.



FUEL HANDLING

Fuel safety

Never start the machine:

- 1 If you have spilt fuel on it. Wipe off the spillage and allow remaining fuel to evaporate.
- 2 If you have spilt fuel on yourself or your clothes, change your clothes. Wash any part of your body that has come in contact with fuel. Use soap and water.
- 3 If the machine is leaking fuel. Check regularly for leaks from the fuel cap and fuel lines.

Transport and storage

- Store and transport the machine and fuel so that there is no risk of any leakage or fumes coming into contact with sparks or naked flames, for example, from electrical machinery, electric motors, electrical relays/switches or boilers.
- When storing and transporting fuel always use approved containers intended for this purpose.
- When storing the machine for long periods the fuel tank must be emptied. Contact your local petrol station to find out where to dispose of excess fuel.
- Ensure the machine is cleaned and that a complete service is carried out before long-term storage.
- The transport guard must always be fitted to the cutting attachment when the machine is being transported or in storage.
- In order to prevent unintentional starting of the engine, the spark plug cap must always be removed during long-term storage, if the machine is not under close supervision and when performing all service measures.



WARNING! Take care when handling fuel. Bear in mind the risk of fire, explosion and inhaling fumes.

Fuel

CAUTION! The machine is equipped with a two-stroke engine and must always be run using a mixture of petrol and two-stroke engine oil. It is important to accurately measure the amount of oil to be mixed to ensure that the correct mixture is obtained. When mixing small amounts of fuel, even small inaccuracies can drastically affect the ratio of the mixture.



WARNING! Fuel and fuel fumes are highly inflammable and can cause serious injury when inhaled or allowed to come in contact with the skin. For this reason observe caution when handling fuel and make sure there is adequate ventilation.

Petrol



CAUTION! Always use a quality petrol/oil mixture at least 90 octane (RON). If your machine is equipped with a catalytic converter (see chapter on Technical data) always use a good quality unleaded petrol/oil mixture. Leaded petrol will destroy the catalytic converter.

Use low-emission petrol, also known as alkylate petrol, if it is available.



- The lowest octane recommended is 90 (RON). If you run the engine on a lower octane grade than 90 so-called knocking can occur. This gives rise to a high engine temperature, which can result in serious engine damage.
- When working at continuous high revs a higher octane rating is recommended.

Two-stroke oil

- For best results and performance use HUSQVARNA two-stroke engine oil, which is specially formulated for our air-cooled two-stroke engines.
- Never use two-stroke oil intended for water-cooled engines, sometimes referred to as outboard oil (rated TCW).
- Never use oil intended for four-stroke engines.
- A poor oil quality and/or too high oil/fuel ratio may jeopardise function and decrease the life time of catalytic converters.
- Mixing ratio
 - 1:50 (2%) with HUSQVARNA two-stroke oil or equivalent.
 - 1:33 (3%) with other oils designed for air-cooled, two-stroke engines classified for JASO FB/ISA EGB, or higher.

Petrol, litre	Two-stroke oil, litre	
	2% (1:50)	3% (1:33)
5	0,10	0,15
10	0,20	0,30
15	0,30	0,45
20	0,40	0,60

FUEL HANDLING

Mixing

- Always mix the petrol and oil in a clean container intended for fuel.
- Always start by filling half the amount of the petrol to be used. Then add the entire amount of oil. Mix (shake) the fuel mixture. Add the remaining amount of petrol.
- Mix (shake) the fuel mixture thoroughly before filling the machine's fuel tank.

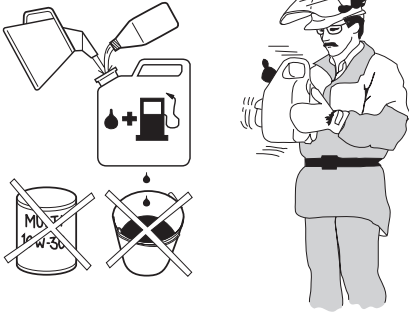

- Do not mix more than one month's supply of fuel at a time.
- If the machine is not used for some time the fuel tank should be emptied and cleaned.



WARNING! The catalytic converter muffler gets very hot during and after use. This also applies during idling. Be aware of the fire hazard, especially when working near flammable substances and/or vapours.

Fuelling



WARNING! Taking the following precautions, will lessen the risk of fire:

Do not smoke or place hot objects near fuel.

Always shut off the engine before refuelling.

Always stop the engine and let it cool for a few minutes before refuelling.

When refuelling, open the fuel cap slowly so that any excess pressure is released gently.

Tighten the fuel cap carefully after refuelling.

Always move the machine away from the refuelling area before starting.

- Clean the area around the fuel cap. Contamination in the tank can cause operating problems.
- Ensure that the fuel is well mixed by shaking the container before filling the tank.

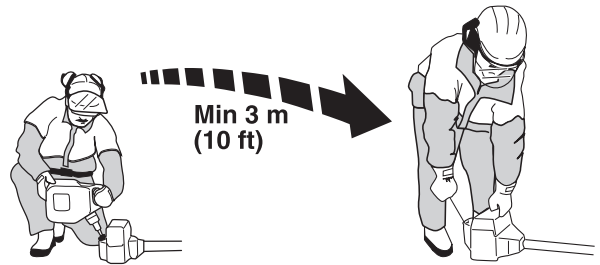

STARTING AND STOPPING

Check before starting

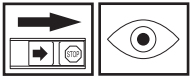

- Check the blade to ensure that no cracks have formed at the bottom of the teeth or by the centre hole. The most common reason why cracks are formed is that sharp corners have been formed at the bottom of the teeth while sharpening or that the blade has been used with dull teeth. Discard a blade if cracks are found.

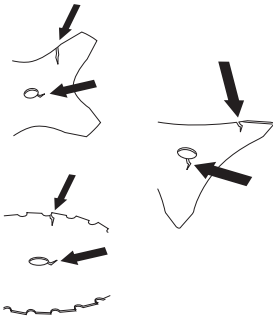

- Check that the support flange is not cracked due to fatigue or due to being tightened too much. Discard the support flange if it is cracked.

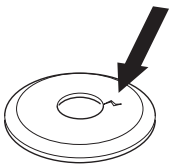

- Ensure the locking nut has not lost its captive force. The nut lock should have a locking force of at least 1.5 Nm. The tightening torque of the locking nut should be 35-50 Nm.



- Check that the blade guard is not damaged or cracked. Replace the blade guard if it is exposed to impact or is cracked.

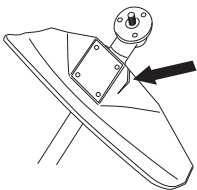

- Check that the trimmer head and trimmer guard are not damaged or cracked. Replace the trimmer head or trimmer guard if they have been exposed to impact or are cracked.

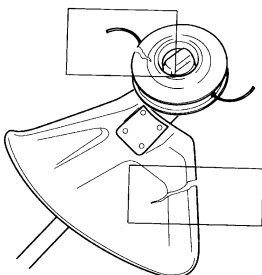

- Never use the machine without a guard nor with a defective guard.

Starting and stopping



WARNING! The complete clutch cover and shaft must be fitted before the machine is started, otherwise the clutch can come loose and cause personal injury.

Always move the machine away from the refuelling area before starting. Place the machine on a flat surface. Ensure the cutting attachment cannot come into contact with any object.

Make sure no unauthorised persons are in the working area, otherwise there is a risk of serious personal injury. The safety distance is 15 metres.

Cold engine

Ignition: Set the stop switch to the start position.

Choke: Set the choke control in the choke position.

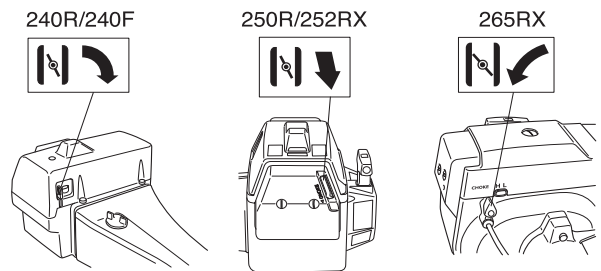

Warm engine

Use the same starting procedure as for a cold engine but without setting the choke control in the choke position. Set the throttle to the start position by moving the choke control to the choke position and then returning it to its original position.

STARTING AND STOPPING

Starting



WARNING! When the engine is started with the choke in either the choke or start throttle positions the cutting attachment will start to rotate immediately.

Hold the body of the machine on the ground using your left hand (CAUTION! Not with your foot!). Grip the starter handle, slowly pull out the cord with your right hand until you feel some resistance (the starter pawls grip), now quickly and powerfully pull the cord. **Never twist the starter cord around your hand.**

Reset the choke control as soon as the engine fires and repeat until the engine starts. The throttle will automatically disengage from the start setting when you apply more throttle.

CAUTION! Do not pull the starter cord all the way out and do not let go of the starter handle when the cord is fully extended. This can damage the machine.

Stopping

Stop the engine by switching off the ignition.

240R/250R

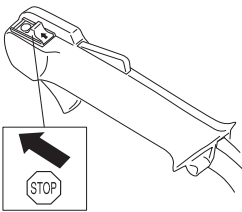

240F/252RX/265RX

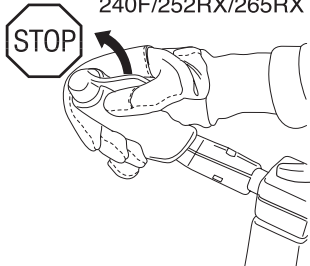

WORKING TECHNIQUES

General working instructions

IMPORTANT!

This section describes the basic safety precautions for working with clearing saws and trimmers.

If you encounter a situation where you are uncertain how to proceed you should ask an expert. Contact your dealer or your service workshop.

Avoid all usage which you consider to be beyond your capability.

You must understand the difference between forestry clearing, grass clearing and grass trimming before use.

Basic safety rules



- 1 Look around you:
 - To ensure that people, animals or other things cannot affect your control of the machine.
 - To ensure that people, animals, etc., do not come into contact with the cutting attachment or loose objects that are thrown out by the cutting attachment.
 - CAUTION! Do not use the machine unless you are able to call for help in the event of an accident.
- 2 Do not use the machine in bad weather, such as dense fog, heavy rain, strong wind, intense cold, etc. Working in bad weather is tiring and often brings added risks, such as icy ground, unpredictable felling direction, etc.
- 3 Make sure you can move and stand safely. Check the area around you for possible obstacles (roots, rocks, branches, ditches, etc.) in case you have to move suddenly. Take great care when working on sloping ground.



- 4 Take great care when cutting a tree that is in tension. A tree that is in tension may spring back to its normal position before or after being cut. If you position yourself incorrectly or make the cut in the wrong place the tree may hit you or the machine and cause you to lose control. Both situations can cause serious personal injury.

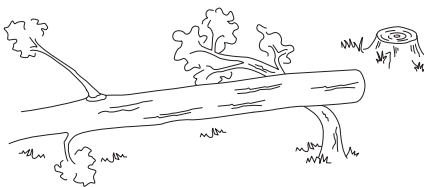

- 5 Switch off the engine before moving to another area. Fit the transport guard before carrying or transporting the equipment any distance.
- 6 Never put the machine down with the engine running unless you have it in clear sight.

The ABC of clearing

- Always use the correct equipment.
- Make sure the equipment is well adjusted.
- Follow the safety precautions.
- Organise your work carefully.
- Always use full throttle when starting to cut with the blade.
- Always use sharp blades.
- Avoid stones.
- Control the felling direction (take advantage of the wind).



WARNING! Neither the operator of the machine nor anyone else may attempt to remove the cut material while the engine is running or the cutting equipment is rotating, as this can result in serious injury.

Stop the engine and cutting equipment before you remove material that has wound around the blade shaft as otherwise there is a risk of injury. The bevel gear can get hot during use and may remain so for a while afterwards. You could get burnt if you touch it.



WARNING! Watch out for thrown objects. Always wear approved eye protection. Never lean over the cutting attachment guard. Stones, rubbish, etc. can be thrown up into the eyes causing blindness or serious injury.

Keep unauthorised persons at a distance. Children, animals, onlookers and helpers should be kept outside the safety zone of 15 m. Stop the machine immediately if anyone approaches. Never swing the machine around without first checking behind you to make sure no-one is within the safety zone.



WARNING! Sometimes branches or grass get caught between the guard and cutting attachment. Always stop the engine before cleaning.

WORKING TECHNIQUES

Working methods



WARNING! Avoid cutting with the area of the blade between the 12 o'clock and 3 o'clock positions. Because of the speed of rotation of the blade kickback can occur if you attempt to cut thick stems with this area of the blade.

- Before you start clearing, check the clearing area, the type of terrain, the slope of the ground, whether there are stones, hollows etc.
- Start at whichever end of the area is easiest, and clear an open space from which to work.
- Work systematically to and fro across the area, clearing a width of around 4-5 m on each pass. This exploits the full reach of the machine in both directions and gives the operator a convenient and varied working area to work in.

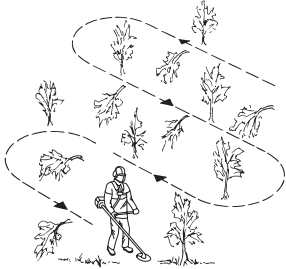

- Clear a strip around 75 m long. Move your fuel can as work progresses.
- On sloping ground you should work along the slope. It is much easier to work along a slope than it is to work up and down it.
- You should plan the strip so that you avoid going over ditches or other obstacles on the ground. You should also orient the strip to take advantage of wind conditions, so that cleared stems fall in the cleared area of the stand.

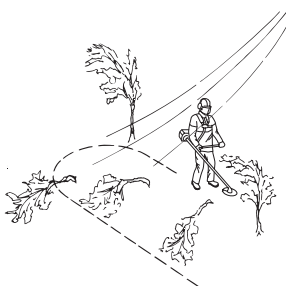

Forestry clearing using a saw blade

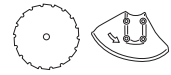

- The risk of kickback increases with increasing stem size. You should therefore avoid cutting with the area of the blade between 12 o'clock and 3 o'clock.

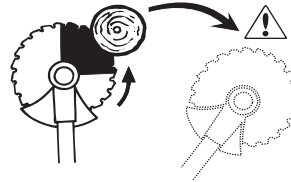

- To fell to the left, the bottom of the tree should be pushed to the right. Tilt the blade and bring it diagonally down to the right, exerting firm pressure. At the same time push the stem using the blade guard. Cut with the area of the blade between 3 o'clock and 5 o'clock. Apply full throttle before advancing the blade.

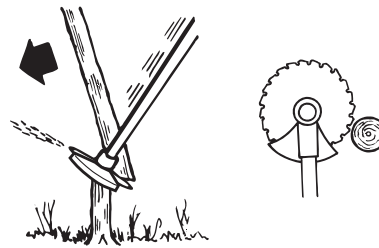

- To fell to the right, the bottom of the tree should be pushed to the left. Tilt the blade and bring it diagonally up to the right. Cut with the area of the blade between 3 o'clock and 5 o'clock so that the direction of rotation of the blade pushes the bottom of the tree to the left.

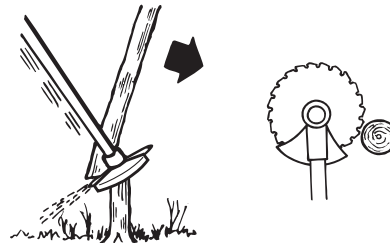

- To fell a tree forwards, the bottom of the tree should be pulled backwards. Pull the blade backwards with a quick, firm movement.

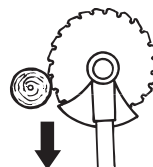

- Large stems must be cut from two sides. First determine which direction the stem will fall. Make the first cut on the felling side. Then finish cutting the stem from the other

WORKING TECHNIQUES

side. Adjust the cutting pressure to match the size of the stem and the hardness of the wood. Small stems require more pressure, while large stems require less pressure.

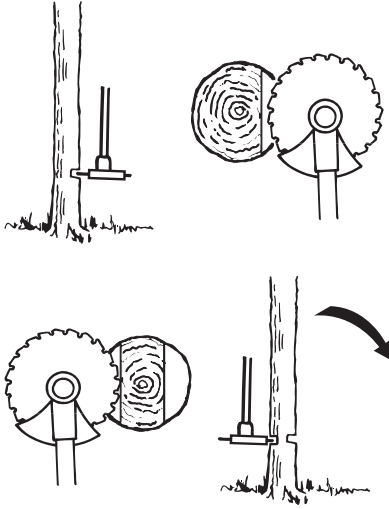

- If the stems are tightly packed, adapt your walking pace to suit.
- If the blade jams in a stem, never jerk the machine free. If you do this the blade, bevel gear, shaft or handlebar may be damaged. Release the handles, grip the shaft with both hands and gently pull the machine free.

Brush cutting with a saw blade



- Thin stems and brush are mown down. Work with a sawing movement, swinging sideways.
- Try to cut several stems in a single sawing movement.
- With groups of hardwood stems, first clear around the group. Start by cutting the stems high up around the outside of the group to avoid jamming. Then cut the stems to the required height. Now try to reach in with the blade and cut from the centre of the group. If it is still difficult to gain access, cut the stems high up and let them fall. This will reduce the risk of jamming.

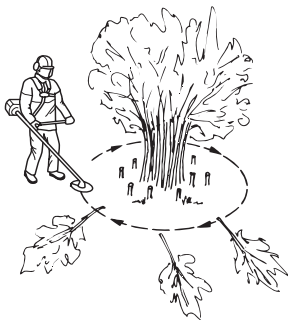

Grass clearing using a grass blade



- Grass blades and grass cutters must not be used on woody stems.
- A grass blade is used for all types of tall or coarse grass.
- The grass is cut down with a sideways, swinging movement, where the movement from right-to-left is the clearing stroke and the movement from left-to-right is the return stroke. Let the left-hand side of the blade (between 8 and 12 o'clock) do the cutting.

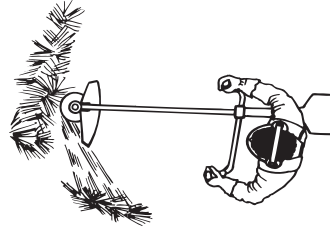

- If the blade is angled to the left when clearing grass, the grass will collect in a line, which makes it easier to collect, e.g. by raking.
- Try to work rhythmically. Stand firmly with your feet apart. Move forward after the return stroke and stand firmly again.
- Let the support cup rest lightly against the ground. It is used to protect the blade from hitting the ground.
- Reduce the risk of material wrapping around the blade by following these instructions:
 - 1 Always work at full throttle.
 - 2 Avoid the previously cut material during the return stroke.
- Stop the engine, unclip the harness and place the machine on the ground before you start to collect the cut material.

WORKING TECHNIQUES

Grass trimming with a trimmer head



Trimming

- Hold the trimmer head just above the ground at an angle. It is the end of the cord that does the work. Let the cord work at its own pace. Never press the cord into the area to be cut.

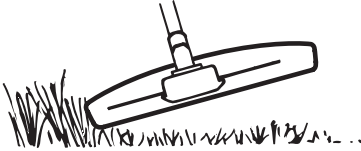

- The cord can easily remove grass and weeds up against walls, fences, trees and borders, however it can also damage sensitive bark on trees and bushes, and damage fence posts.
- Reduce the risk of damaging plants by shortening the cord to 10-12 cm and reducing the engine speed.

Clearing

- The clearing technique removes all unwanted vegetation. Keep the trimmer head just above the ground and tilt it. Let the end of the cord strike the ground around trees, posts, statues and the like. CAUTION! This technique increases the wear on the cord.

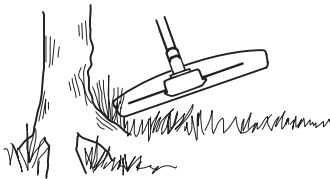

- The cord wears quicker and must be fed forward more often when working against stones, brick, concrete, metal fences, etc., than when coming into contact with trees and wooden fences.
- When trimming and clearing you should use less than full throttle so that the cord lasts longer and to reduce the wear on the trimmer head.

Cutting



- The trimmer is ideal for cutting grass that is difficult to reach using a normal lawn mower. Keep the cord parallel to the ground when cutting. Avoid pressing the trimmer head against the ground as this can ruin the lawn and damage the tool.

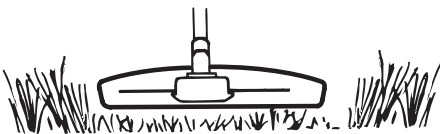

- Do not allow the trimmer head to constantly come into contact with the ground during normal cutting. Constant contact of this type can cause damage and wear to the trimmer head.

Sweeping

- The fan effect of the rotating cord can be used for quick and easy clearing up. Hold the cord parallel to and above the area to be swept and move the tool to and fro.

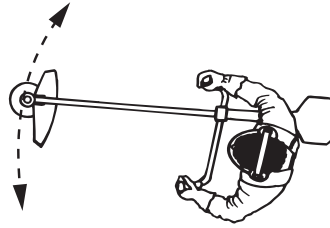

- When cutting and sweeping you should use full throttle to obtain the best results.

MAINTENANCE

Carburettor

Your Husqvarna product has been designed and manufactured to specifications that reduce harmful emissions. After the engine has used 8-10 tanks of fuel the engine will be run-in. To ensure that it continues to run at peak performance and to minimise harmful exhaust emissions after the running-in period, ask your dealer/service workshop (who will have a rev counter at their disposal) to adjust your carburettor.



WARNING! The complete clutch cover and shaft must be fitted before the machine is started, otherwise the clutch can come loose and cause personal injury.

Carburettor adjustment

The carburettor can be designed in different ways, depending on the existing environmental and emissions legislation. Some machines are equipped with movement limiters on the carburettor's adjuster screws. These limit the adjustment range to a maximum of 1/2 turn.

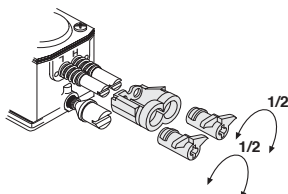

Function



- The carburettor governs the engine's speed via the throttle control. Air and fuel are mixed in the carburettor. The air/fuel mixture is adjustable. Correct adjustment is essential to get the best performance from the machine.
- Adjusting the carburettor means that the engine is adapted to local operating conditions, e.g. climate, altitude, petrol and the type of 2-stroke oil.
- The carburettor has three adjustment controls:

L = Low speed jet

H = High speed jet

T = Idle adjustment screw

240R/240F

250R/252RX

265RX

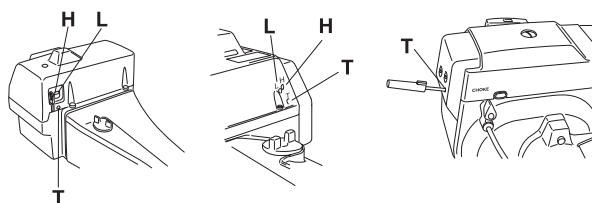

- The L and H-jets are used to adjust the supply of fuel to match the rate that air is admitted, which is controlled with the throttle. If they are screwed clockwise the air/fuel ratio becomes leaner (less fuel) and if they are turned anti-clockwise the ratio becomes richer (more fuel). A lean mixture gives a higher engine speed and a rich mixture gives a lower engine speed.

- The T-screw regulates the throttle setting at idle speed. If the T-screw is turned clockwise this gives a higher idle speed; turning it anti-clockwise gives a lower idle speed.

Basic setting

- The basic carburettor settings are adjusted during testing at the factory. The basic setting is richer than the optimal setting and should be maintained for the first few hours the machine is in use. The carburettor should then be finely adjusted. Fine adjustment should be carried out by a skilled technician.

The basic setting can vary between: H = 1 - 1 1/4 turns and L = 1 - 1 1/4 turns.

CAUTION! If the cutting attachment rotates when the engine is idling the idle adjustment screw T should be turned anti-clockwise until the cutting attachment stops.

240R, 240F, 250R, 252RX:

Rec. idle speed 2700 rpm

265RX:

Rec. idle speed 2250 rpm



WARNING! If the idle speed cannot be adjusted so that the cutting attachment stops, contact your dealer/service workshop. Do not use the machine until it has been correctly adjusted or repaired.

CAUTION! The machine should only be run for short periods at its highest speed. For optimum adjustment of the carburettor, contact a qualified dealer/service workshop that has a revolution counter at their disposal.

Recommended max. speed: See the Technical data section.

During the running-in period (8-10 tanks of fuel) the maximum speed should be set 600-700 rpm below the recommended maximum speed (= open the high speed jet H a further 1/8 turn).

Conditions

- Before any adjustments are made, make sure that the air filter is clean and the air filter cover is fitted. If you adjust the carburettor when the air filter is dirty it will result in a leaner mixture when the filter is finally cleaned. This can lead to serious engine damage.
- Carefully turn both jets, L and H, so that they are midway between fully screwed in and fully screwed out.
- Do not attempt to adjust the L and H jets beyond either stop as this could cause damage.
- Now start the machine according to the starting instructions and let it warm up for 10 minutes.

CAUTION! If the cutting attachment rotates when the engine is idling the idle adjustment screw T should be turned anti-clockwise until the cutting attachment stops.

MAINTENANCE

Low speed jet L (240R, 240F, 250R, 252RX)

Try to find the highest idle speed by turning the low speed jet L clockwise then anti-clockwise. When the highest speed has been found, turn the low speed jet L 1/4 turn anti-clockwise.

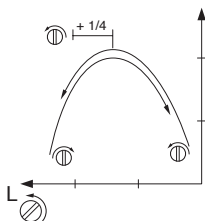

CAUTION! If the cutting attachment rotates when the engine is idling the idle adjustment screw T should be turned anti-clockwise until the cutting attachment stops.

Fine adjustment of the idle speed T

Adjust the idle speed using the idle adjustment screw T, if it is necessary to readjust. First turn the idle adjustment screw T clockwise until the cutting attachment starts to rotate. Then turn the screw anticlockwise until the cutting attachment stops. The idle speed is correctly adjusted when the engine will run smoothly in every position. The idle speed should also be well below the speed at which the cutting attachment starts to rotate.



WARNING! If the idle speed cannot be adjusted so that the cutting attachment stops, contact your dealer/service workshop. Do not use the machine until it has been correctly adjusted or repaired.

High speed jet H (240R, 240F)

The high speed jet H affects the engine power, speed, temperature and fuel consumption. If the high speed jet H is set too lean (screwed in too far) the engine speed will be too high and cause engine damage. Do not let the engine run at full speed for more than 10 seconds.

Apply full throttle and turn the high speed jet H very slowly clockwise until the engine slows down. Then turn the high speed jet H very slowly anticlockwise until the engine starts to run unevenly. Now turn the high speed jet H slowly clockwise a little way until the engine runs smoothly.

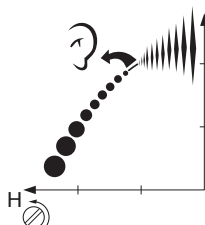

Note that the engine should not be under load when you adjust the high speed jet H. You should therefore remove the cutting attachment, nut, support flange and drive disc before adjusting the high speed jet H.

The high speed jet H is adjusted correctly when the machine burbles a little. If the machine races then the setting is too lean. If the engine produces a lot of smoke and burbles a lot then the setting is too rich.

CAUTION! For optimum adjustment of the carburettor, contact a qualified dealer/service workshop that has a revolution counter at their disposal.

High speed jet H (250R, 252RX)

The high speed jet H affects the engine power, speed, temperature and fuel consumption. If the high speed jet H is set too lean (screwed in too far) the engine speed will be too high and cause engine damage. Do not let the engine run at full speed for more than 10 seconds.

Setting procedure without a load (Blade can be used)

The machine is equipped with speed control in the ignition system. It is extremely important to be aware of this when adjusting the carburettor.

250R, 252RX: Speed control at: 13500 rpm

When attempting to adjust the speed over that specified, the speed is not changed, but only causes the engine to receive too little fuel resulting in a large risk of engine failure.

Run the machine warm for approximately 5 minutes alternating between short intervals of full throttle and idling. When the carburettor is to be adjusted, apply full throttle and turn the H-needle anti-clockwise until the engine speed reaches 10,500-11,000 r/min (burbles) or until the cap reaches its stop position. Now turn the H-needle slowly clockwise until the engine reaches the speed when the speed control comes into force. In some cases, speed control can come into force at 200-300 revs below or above that specified. It is important that you do not continue to turn the H-needle clockwise when the engine speed has stabilised. Screw the H-needle (anti-clockwise) a few tenths of a turn instead.

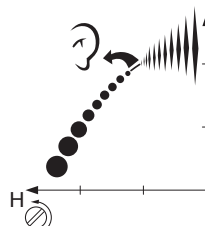

MAINTENANCE

Setting procedure with a load (Trimmer head should be used)

Ensure the length of the trimmer cord is correct, i.e. exactly reaches the knife on the trimmer guard. Use either 3 mm or 3.3 mm diameter trimmer cord.

Run the machine warm for about 5 minutes mostly at full throttle. When the carburettor is to be adjusted, apply full throttle and turn the H-needle anti-clockwise until the engine burbles or until the cap reaches its stop position. (If the engine runs smoothly when the cap is in its stop position no further adjustment is necessary!) Turn the H-needle slowly clockwise until the engine runs absolutely smoothly. (Bubbling has stopped completely). Now screw the H-needle (anti-clockwise) a few tenths of a turn.

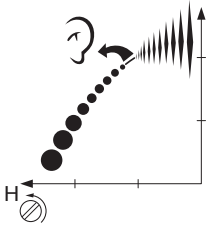

CAUTION! For optimum adjustment of the carburettor, contact a qualified dealer/service workshop that has a revolution counter at their disposal.

265RX

The machine is equipped with fixed L and H-needles, in order to ensure that the machine always receives the correct mixture of fuel and air.

When the engine lacks power or accelerates poorly, proceed as follows:

- Check the air filter and replace if necessary.
- When this does not help, contact an authorised service workshop. The needles are available in different sizes.

The T-screw regulates the throttle setting at idle speed. If the T-screw is turned clockwise this gives a higher idle speed; turning it anti-clockwise gives a lower idle speed.

265RX

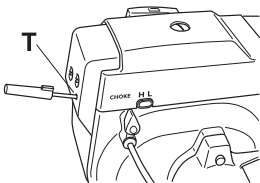

Correctly adjusted carburettor

When the carburettor is correctly adjusted the machine will accelerate without hesitation and burble a little at maximum speed. It is also important that the cutting attachment does not rotate at idle. If the low speed jet L is set too lean it may cause starting difficulties and poor acceleration.

If the high speed jet H is set too lean it will result in less power, less performance, poor acceleration and/or damage to the engine.

If both the L and H jets are set too rich it will result in acceleration problems or too low a working speed.

Muffler

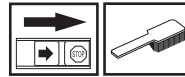

CAUTION! Some mufflers are fitted with a catalytic converter. See chapter on Technical data to see whether your machine is fitted with a catalytic converter.

The muffler is designed to reduce the noise level and to direct the exhaust gases away from the operator. The exhaust gases are hot and can contain sparks, which may cause fire if directed against dry and combustible material. Some mufflers are equipped with a special spark arrestor mesh. If your machine has this type of muffler, you should clean the mesh at least once a week. This is best done with a wire brush. On mufflers without a catalytic converter the mesh should be cleaned weekly, or replaced if necessary. On mufflers fitted with a catalytic converter the mesh should be checked, and if necessary cleaned, monthly. **If the mesh is damaged it should be replaced.**

If the mesh is frequently blocked, this can be a sign that the performance of the catalytic converter is impaired. Contact your dealer to inspect the muffler. A blocked mesh will cause the machine to overheat and result in damage to the cylinder and piston.

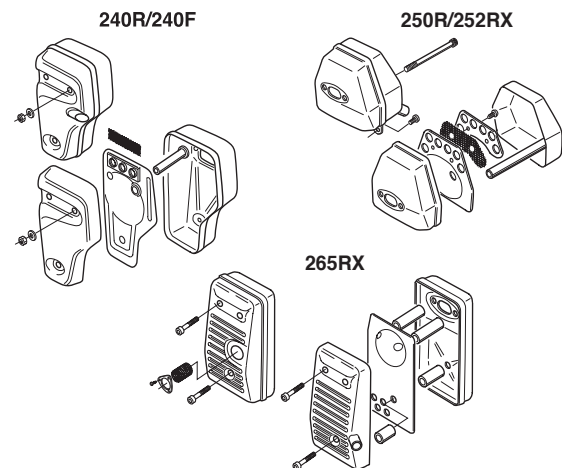

CAUTION! Never use a machine with a defective muffler.



WARNING! Mufflers fitted with catalytic converters get very hot during use and remain so for some time after stopping. This also applies at idle speed. Contact can result in burns to the skin. Remember the risk of fire!

MAINTENANCE

Cooling system

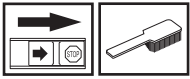

To keep the working temperature as low as possible the machine is equipped with a cooling system.

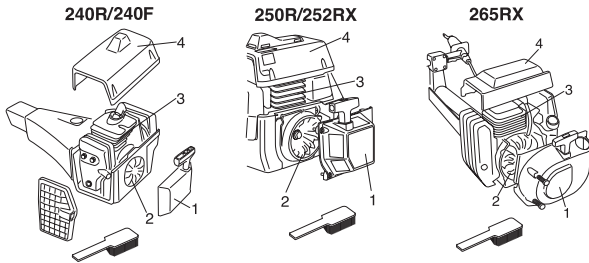

The cooling system consists of:

- 1 Air intake on the starter.
- 2 Fins on the flywheel.
- 3 Cooling fins on the cylinder.
- 4 Cylinder cover (directs cold air over the cylinder).

Clean the cooling system with a brush once a week, more often in demanding conditions. A dirty or blocked cooling system results in the machine overheating which causes damage to the piston and cylinder.

Air filter

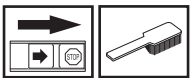

The air filter must be regularly cleaned to remove dust and dirt in order to avoid:

- Carburettor malfunctions
- Starting problems
- Loss of engine power
- Unnecessary wear to engine parts.
- Excessive fuel consumption.

Clean the filter every 25 hours, or more regularly if conditions are exceptionally dusty.

Cleaning the air filter

240R, 240F

Remove the air filter cover and take out the filter. Wash it clean in warm, soapy water. Ensure that the filter is dry before refitting it.

If the machine is used in dusty conditions the air filter should be soaked in oil. See instructions under the heading Oiling the air filter.

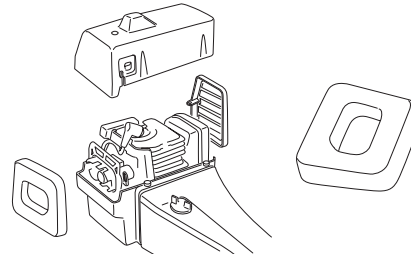

250R, 252RX

Remove the air filter cover and remove both filters, A and B. A is an air filter and B is a pre-filter. Both must be washed in warm soapy water and dried. Filter A must then be soaked in oil, see instructions under the heading Oiling the air filter.

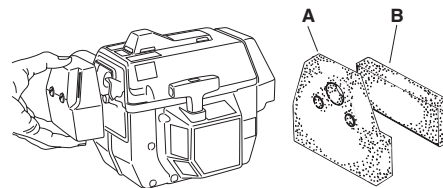

265RX

Remove the air filter cover and take out the filter. Wash it clean in warm, soapy water.

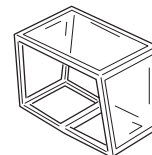

Ensure that the filter is dry before refitting it.

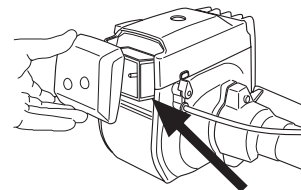

MAINTENANCE

Oiling the air filter

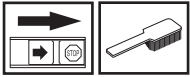

Always use HUSQVARNA filter oil, art. no. 531 00 92-48. The filter oil contains a solvent to make it spread evenly through the filter. You should therefore avoid skin contact.

Put the filter in a plastic bag and pour the filter oil over it. Knead the plastic bag to distribute the oil. Squeeze the excess oil out of the filter inside the plastic bag and pour off the excess before fitting the filter to the machine. Never use common engine oil. This would drain through the filter quite quickly and collect in the bottom.

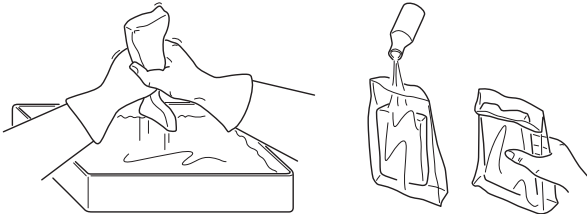

An air filter that has been in use for a long time cannot be cleaned completely. The filter must therefore be replaced with a new one at regular intervals. **A damaged air filter must always be replaced.**

Bevel gear



The bevel gear is filled with the right quantity of grease at the factory. However, before using the machine you should check that the bevel gear is filled three-quarters full with grease. Use HUSQVARNA special grease.

The grease in the bevel gear does not normally need to be changed except if repairs are carried out.

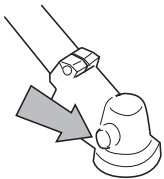

Spark plug



The spark plug condition is influenced by:

- Incorrect carburettor adjustment.
- An incorrect fuel mixture (too much or incorrect type of oil).
- A dirty air filter.

These factors cause deposits on the spark plug electrodes, which may result in operating problems and starting difficulties.

If the machine is low on power, difficult to start or runs poorly at idle speed: always check the spark plug first before taking any further action. If the spark plug is dirty, clean it and check that the electrode gap is 0.5 mm. The spark plug should be replaced after about a month in operation or earlier if necessary.

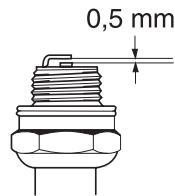

CAUTION! Always use the recommended spark plug type! Use of the wrong spark plug can damage the piston/cylinder. Check that the spark plug is fitted with a suppressor.

MAINTENANCE

Maintenance schedule

The following is a list of the maintenance that must be performed on the machine. Most of the items are described in the Maintenance section. The user must only carry out the maintenance and service work described in this Operator's Manual. More extensive work must be carried out by an authorised service workshop.

Maintenance	Daily maintenance	Weekly maintenance	Monthly maintenance
Clean the outside of the machine.	X		
Check that the harness is not damaged.	X		
Make sure the throttle trigger lock and the throttle function correctly from a safety point of view.	X		
Check that the handle and handlebar are undamaged and secured correctly.	X		
Check that the stop switch works correctly.	X		
Check that the cutting attachment does not rotate at idle.	X		
Clean the air filter. Replace if necessary.	X		
Check that the guard is undamaged and not cracked. Replace the guard if it has been exposed to impact or is cracked.	X		
Check that the blade is correctly centred, is sharp, and is not cracked. An off-centre blade will cause vibration that could result in damage to the machine.	X		
Check that the trimmer head is undamaged and not cracked. Replace the trimmer head if necessary.	X		
Check that the locking nut of the cutting equipment is tighten correctly.	X		
Check that the locking screw is tightened when using a support cup with bearings.	X		
Check that the transport guard for the blade is intact and that it can be secured correctly.	X		
Check that nuts and screws are tight.	X		
Check that there are no fuel leaks from the engine, tank or fuel lines.	X		
Check the starter and starter cord.		X	
Check that the vibration damping elements are not damaged.		X	
Clean the outside of the spark plug. Remove it and check the electrode gap. Adjust the gap to 0.5 mm or replace the spark plug. Check that the spark plug is fitted with a suppressor.		X	
Clean the machines cooling system.		X	
Clean or replace the spark arrestor mesh on the muffler (only applies to mufflers without a catalytic converter).		X	
Clean the outside of the carburettor and the space around it.		X	
Check that the bevel gear is filled three-quarters full with lubricant. Fill if necessary using special grease.		X	
Check the fuel filter from contamination and the fuel hose from cracks or other defects. Replace if necessary.			X
Check all cables and connections.			X
Check the clutch, clutch springs and the clutch drum for wear. Replace if necessary by an authorized service workshop.			X
Replace the spark plug. Check that the spark plug is fitted with a suppressor.			X
Check and clean the spark arrestor mesh on the muffler (only applies to mufflers fitted with a catalytic converter).			X

TECHNICAL DATA

Technical data

Technical data	240R	240F
Engine		
Cylinder displacement, cm ³	40,2	40,2
Cylinder bore, mm	40	40
Stroke, mm	32	32
Idle speed, rpm	2700	2700
Recommended max. speed, rpm	13500	13500
Speed of output shaft, rpm	9190	9190
Max. engine output, acc. to ISO 8893	1,8/9000	1,8/9000
Catalytic converter muffler	No	No
Speed-regulated ignition system	No	No
Ignition system		
Manufacturer/type of ignition system	EM/ET	EM/ET
Spark plug	NGK BPMR 7A/ Champion RCJ 7Y	NGK BPMR 7A/ Champion RCJ 7Y
Electrode gap, mm	0,5	0,5
Fuel and lubrication system		
Manufacturer/type of carburettor	Zama C1Q	Zama C1Q
Fuel tank capacity, litre	0,8	0,8
Weight		
Weight without fuel, cutting attachment and guard, kg	8,6	8,4
Noise emissions		
(see note 1)		
Sound power level, measured dB(A)	114	114
Sound power level, guaranteed L _{WA} dB(A)	114	116
Sound levels		
(see note 2)		
Equivalent noise pressure level at the operator's ear, measured according to EN/ISO 11806 and ISO 7917, dB(A), min./max.:	100/104	98/101
Vibration levels		
Vibration levels at handles, measured according to EN/ISO 11806 and ISO 7916, m/s ²		
At idle, left/right handles, min.:	2,1/2,1	3,2/3,0
At idle, left/right handles, max.:	2,4/2,8	3,8/4,1
At max. speed, left/right handles, min.:	2,9/2,4	1,9/2,4
At max. speed, left/right handles, max.:	4,0/3,5	4,2/4,7

Note 1: Noise emissions in the environment measured as sound power (L_{WA}) in conformity with EC directive 2000/14/EC.

Note 2: Equivalent sound pressure level is calculated as the time-weighted energy total for sound pressure levels under various working conditions with the following time distribution: 1/2 idling and 1/2 max speed.

NOTE! The noise pressure level at operator's ear and vibrations on the handles are measured with all the approved cutting attachments for the machine. The table indicates the lowest and highest values.

TECHNICAL DATA

Technical data	250R	252RX	265RX
Engine			
Cylinder displacement, cm ³	48,7	50,9	65,1
Cylinder bore, mm	44	45	48
Stroke, mm	32	32	36
Idle speed, rpm	2700	2700	2250
Recommended max. speed, rpm	12500	14000	11500
Speed of output shaft, rpm	9190	10300	9120
Max. engine output, acc. to ISO 8893	2,1/9000	2,4/9000	3,0/8400
Catalytic converter muffler	No	No	No
Ignition system			
Manufacturer/type of ignition system	EM/ET	EM/ET	SEM GA 6CD
Spark plug	NGK BPMR 7A/ Champion RCJ 7Y	NGK BPMR 7A/ Champion RCJ 7Y	NGK BPMR 7A/ Champion RCJ 7Y
Electrode gap, mm	0,5	0,5	0,5
Fuel and lubrication system			
Manufacturer/type of carburettor	Walbro HDA	Walbro HDA	Tillotson HS
Fuel tank capacity, litre	0,8	0,8	1,0
Weight			
Weight without fuel, cutting attachment and guard, kg	9,2	8,9	10,8
Noise emissions			
(see note 1)			
Sound power level, measured dB(A)	112	112	115
Sound power level, guaranteed L _{WA} dB(A)	114	114	116
Sound levels			
(see note 2)			
Equivalent noise pressure level at the operator's ear, measured according to EN/ISO 11806 and ISO 7917, dB(A), min./max.:	97/104	96/103	98/100
Vibration levels			
Vibration levels at handles, measured according to EN/ISO 11806 and ISO 7916, m/s ²			
At idle, left/right handles, min.:	2,7/3,2	2,8/2,8	4,5/4,0
At idle, left/right handles, max.:	3,5/6,0	4,5/3,9	5,1/4,6
At max. speed, left/right handles, min.:	1,0/1,0	1,2/1,4	3,0/3,9
At max. speed, left/right handles, max.:	2,1/2,0	1,6/1,7	3,9/5,1

Note 1: Noise emissions in the environment measured as sound power (L_{WA}) in conformity with EC directive 2000/14/EC.

Note 2: Equivalent sound pressure level is calculated as the time-weighted energy total for sound pressure levels under various working conditions with the following time distribution: 1/2 idling and 1/2 max speed.

NOTE! The noise pressure level at operator's ear and vibrations on the handles are measured with all the approved cutting attachments for the machine. The table indicates the lowest and highest values.

TECHNICAL DATA

Approved accessories 240R, 240F	Type	Cutting attachment guard, Art. no.
Centre hole in blades/cutters, Ø 20 mm	Output shaft thread M12	
Grass blade/grass cutter	Multi 255-3 (Ø 255 3 teeth)	502 26 34-01
	Multi 275-4 (Ø 275 4 teeth)	502 26 34-01
	Multi 300-3 (Ø 300 3 teeth)	502 26 34-01
Saw blade	Maxi XS 200-22 (Ø 200 22 teeth)	502 27 22-01
Plastic blades	Tricut Ø 300 mm	503 91 60-01 / 502 26 34-01
Trimmer head	Trimmy S	503 91 60-01
	Trimmy S II	503 91 60-01
	Auto 55	503 91 60-01
Support cup	Fixed	-
	With ball bearing	-

Approved accessories 250R	Type	Cutting attachment guard, Art. no.
Centre hole in blades/cutters, Ø 20 mm	Output shaft thread M12	
Grass blade/grass cutter	Multi 255-3 (Ø 255 3 teeth)	502 26 34-01
	Multi 275-4 (Ø 275 4 teeth)	502 26 34-01
	Multi 300-3 (Ø 300 3 teeth)	502 26 34-01
Saw blade	Maxi XS 200-22 (Ø 200 22 teeth)	502 27 22-01
	Maxi XS 225-22 (Ø 225 22 teeth)	502 03 94-03
Plastic blades	Tricut Ø 300 mm	503 91 60-01 / 502 26 34-01
Trimmer head	Trimmy S	503 91 60-01
	Trimmy S II	503 91 60-01
	Auto 55	503 91 60-01
Support cup	With ball bearing	-
Chopping blade	-	Set 537 16 55-01

Approved accessories 252RX	Type	Cutting attachment guard, Art. no.
Centre hole in blades/cutters, Ø 20 mm	Output shaft thread M12	
Grass blade/grass cutter	Multi 255-3 (Ø 255 3 teeth)	502 26 34-01
	Multi 275-4 (Ø 275 4 teeth)	502 26 34-01
	Multi 300-3 (Ø 300 3 teeth)	502 26 34-01
Saw blade	Maxi XS 200-22 (Ø 200 22 teeth)	502 27 22-01
	Maxi XS 225-22 (Ø 225 22 teeth)	502 03 94-03
Trimmer head	Trimmy S	503 91 60-01
	Trimmy S II	503 91 60-01
	Auto 55	503 91 60-01
Support cup	With ball bearing	-

Approved accessories 265RX	Type	Cutting attachment guard, Art. no.
Centre hole in blades/cutters, Ø 20 mm	Output shaft thread M12	
Grass blade/grass cutter	Multi 300-3 (Ø 300 3 teeth)	502 26 34-01
Saw blade	Maxi XS 200-22 (Ø 200 22 teeth)	502 27 22-01
	Maxi XS 225-22 (Ø 225 22 teeth)	502 03 94-03
	Opti 255-22 (Ø 255 22 teeth)	502 03 95-03
Trimmer head	Trimmy S	503 91 60-01
	Trimmy S II	503 91 60-01
Support cup	With ball bearing	-

TECHNICAL DATA

EC-declaration of conformity

(Applies to Europe only)

We, **Husqvarna AB**, SE-561 82 Huskvarna, Sweden, tel: +46-36-146500, declare that the clearing saws **Husqvarna 240R, 240F, 250R, 252RX and 265RX** with serial numbers dating from 2002 onwards (the year is clearly stated on the rating plate, followed by the serial number), comply with the requirements of the COUNCIL'S DIRECTIVE:

of June 22, 1998 "relating to machinery" **98/37/EC**, annex IIA.

of May 3, 1989 "relating to electromagnetic compatibility" **89/336/EEC**, and applicable supplements.

of May 8, 2000 "relating to the noise emissions in the environment" **2000/14/EC**.

For information relating to noise emissions, see the chapter Technical data. The following standards have been applied: **EN292-2, CISPR 12:1997, EN608**.

SMP Svensk Maskinprovning AB, Fyrisborgsgatan 3, SE-754 50 Uppsala, Sweden, has carried out voluntary type approval for Husqvarna AB. The certificates have the numbers: **SEC/94/053, 01/164/016** - 240R, **SEC/03/1008, 01/164/036** - 240F, **SEC/01/819, 01/164/017** - 250R, **SEC/97/493, 01/164/017** - 252RX, **SEC/94/054, 01/164/018** - 265RX.

Huskvarna January 3, 2002



Bo Andréasson, Development manager

**Montering av trimmer
Head installation
Trimmy S**

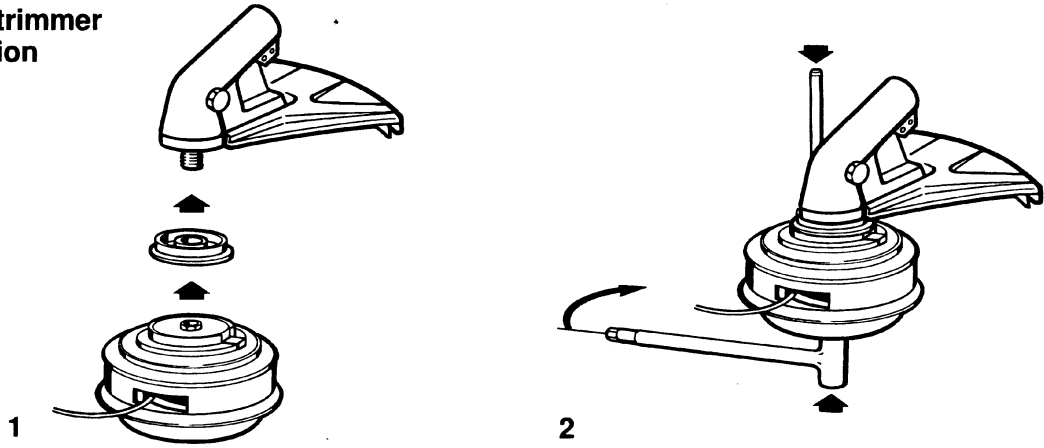

**Montering av ny tråd
Assembling new cord**

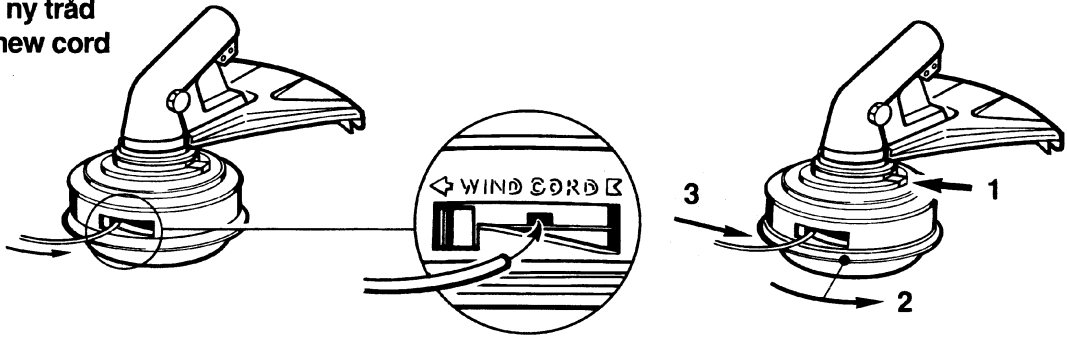

**Justering av tråd
Cord adjustment**

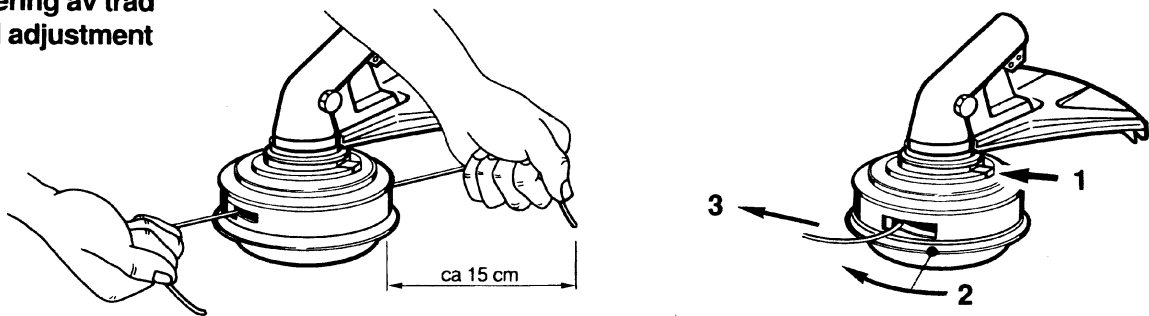

**Reservdelar
Spare parts**

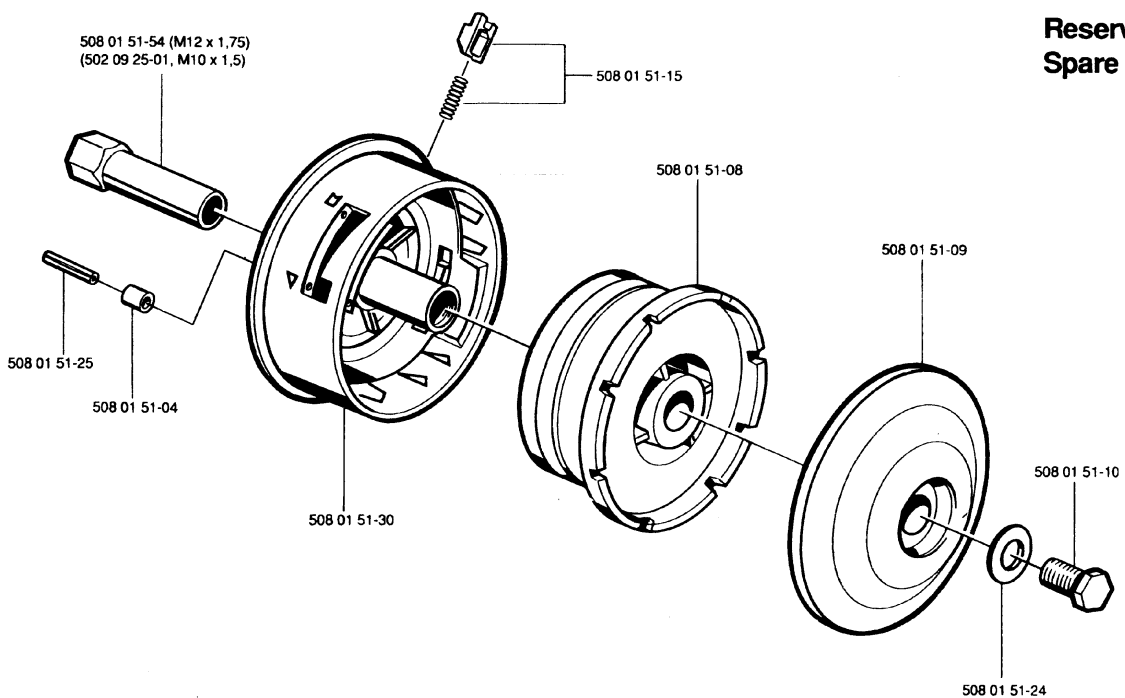

TRIMMY S

- (S) **OBS!** Distantring och låsring skall monteras på klingaxeln vid användande av Trimmy S på modellerna 240R ; 245R/RX med serienr. över 4140001. På 250R med serienr. över 4400001. På 250RX med serienr. över 4200001. Distantring och låsring monteras mellan medbringaren A och trimmern B enl.bild.
- (N) **OBS!** Avstandsstykke og låsering må monteres på bladakselen ved bruk av Trimmy S på modellene 240R,245R/RX med serienr. over 4140001. På 250R med serienr. over 4400001. På 250RX med serienr. over 4200001. Avstandsstykke og låsring monteres mellom medbringeren A og trimmeren B som vist på tegningen.
- (Dk) **BEMÆRK!** Der skal monteres en afstandsskive og låsering på klingeakslen ved brug af Trimmy S på modellerne 240R; 245R/RX med serienr. over 4140001. På 250R med serienr. over 4400001. På 250RX med serienr. over 4200001. Afstandsskiven og låseringen monteres mellem medbringeren A og trimmeren B ifølge billedet.
- (St) **HUOM!** Väliirengas ja lukkorengas on asennettava teräkselille käytettäessä Trimmy S -trimmipäätä malleissa 240R; 245R/RX sarjanumerosta 4140001 ylöspäin. Mallissa 250R sarjanumerosta 4400001 ylöspäin. Mallissa 250RX sarjanumerosta 4200001 ylöspäin. Väliirengas ja lukkorengas asennetaan vääntiön A ja trimmipään B väliin kuvan mukaisesti.
- (Eng) **NOTE!** The spacer and circlip should be fitted on the blade axle when using Trimmy S on models 240R; 245R/RX with serial numbers higher than 4140001. On 250R with serial numbers higher than 4400001. On 250RX with serial numbers higher than 4200001. The spacer and circlip are fitted between the drive disc A and trimmer head B as shown in the figure.
- (D) **ACHTUNG!** Wenn Trimmy S zusammen mit den Modellen 240R, 245R/RX mit Seriennummern über 4140001, 250R mit Seriennummern über 4400001, 250RX mit Seriennummern über 4200001 angewendet werden soll, sind ein Abstandsring und ein Sicherungsring an die Klingennachse zu montieren. Abstandsring und Sicherungsring werden gemäß der Abbildung zwischen Mitnehmer A und Trimmer B angebracht.
- (NL) **N.B.!** De afstandsring en de sluitring dienen bij het gebruik van de Trimmy S op model 240R alsmede op model 245R/RX met serienrs. hoger dan 4140001 te worden gemonteerd op de as van het zaagblad. Verder bij de 250R met serienrs. hoger dan 4400001 en bij de 250RX met serienrs. hoger dan 4200001. Afstandsring en sluitring dienen te worden gemonteerd tussen de meenemer A en de trimmer B volgens afbeelding.
- (F) **Attention!** Une bague entretoise et une bague d'arrêt doivent être montées sur l'axe de lame en utilisant Trimmy S, modèles 240R,245R/RX à partir du n° de série 4140001, modèle 250R à partir du n° de série 4400001, modèle 250RX à partir du n° de série 4200001. La bague entretoise et la bague d'arrêt se montent entre l'entraîneur A et la tête de coupe B suivant la figure.
- (It) **NB -** Per utilizzare Trimmy S sui modelli 240R/RX, 245R/RX con numero di serie a partire da 4140001, modelli 250R con numero di serie a partire da 4400001 e modelli 250RX con numero di serie a partire da 4200001, è necessario inserire un distanziale ed un anello di bloccaggio sull'albero della lama, installandoli fra la piastra adduttrice A e l'attrezzo B.
- (Esp) **¡ATENCIÓN!** El anillo espaciador y la presilla deben montarse en el eje de la hoja al utilizar el Trimmy S en los modelos 240R y 245R/RX con número de serie superior a 4140001; en las 250R con número de serie superior a 4400001 y en las 250RX con número de serie superior a 4200001. El anillo espaciador y la presilla se montan entre la brida A y el cabezal de corte B como se indica en el grabado.
- (Port) **Atenção!** O anel espaçador e o freio devem ser montados no veio com flange, aquando da utilização do Trimmy S, nos modelos 240R; 245R/RX com o número de série superior a 4140001. No modelo 250R, com o número de série superior a 4400001. No modelo 250RX, com o número de série superior a 4200001. O anel espaçador e o freio montam-se entre o porta-ferros A e o afinador B, conforme desenho anexo..
- (Gr) **ΠΡΟΣΟΧΗ!** Διαχωριστική ροδέλα και ασφαλιστικός δακτύλιος πρέπει να μονταριστούν στον άξονα των λεπίδων, στα μοντέλα Trimmy S 240R. Στα 245R/RX με αριθμό σειράς μεγαλύτερο από 4140001. Στα 250R με αριθμό σειράς μεγαλύτερο από 4400001. Στα 250RX με αριθμό σειράς μεγαλύτερο από 4200001. Η διαχωριστική ροδέλα και ο ασφαλιστικός δακτύλιος μοντάρονται μεταξύ προστατευτικού δίσκου A και τρίμμερ B, όπως φαίνεται στην εικόνα.

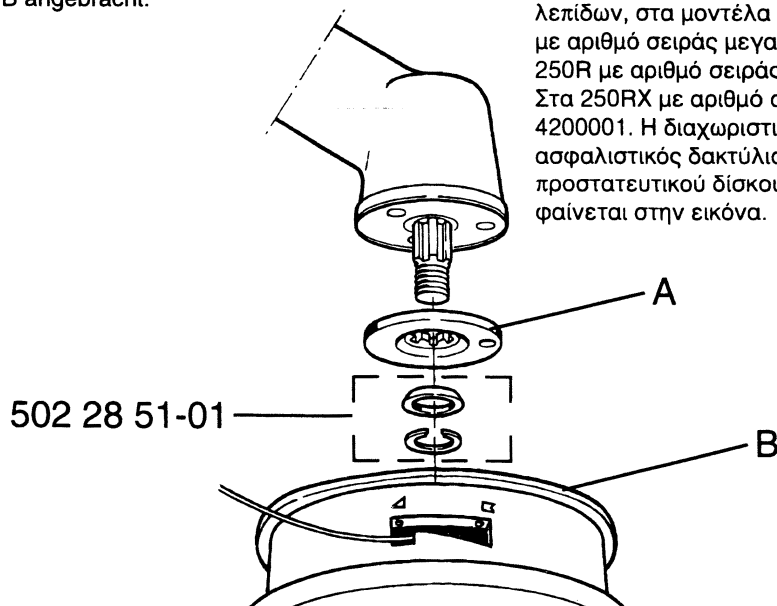

Trimmy SII



1

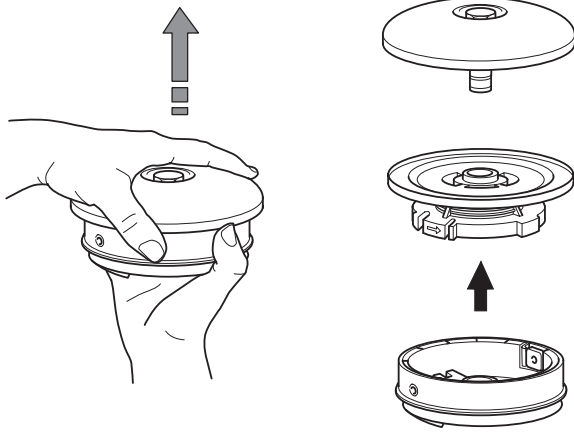

2

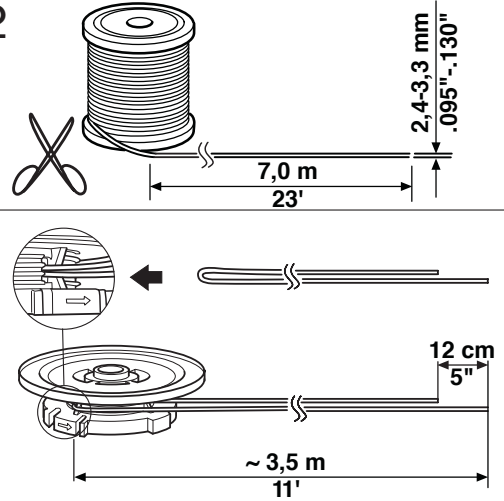

3

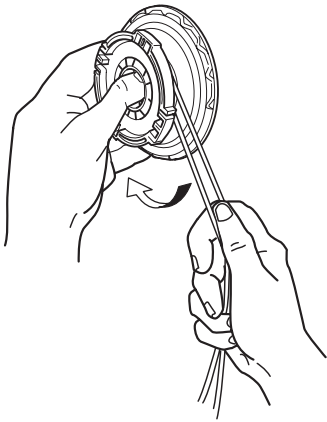

4

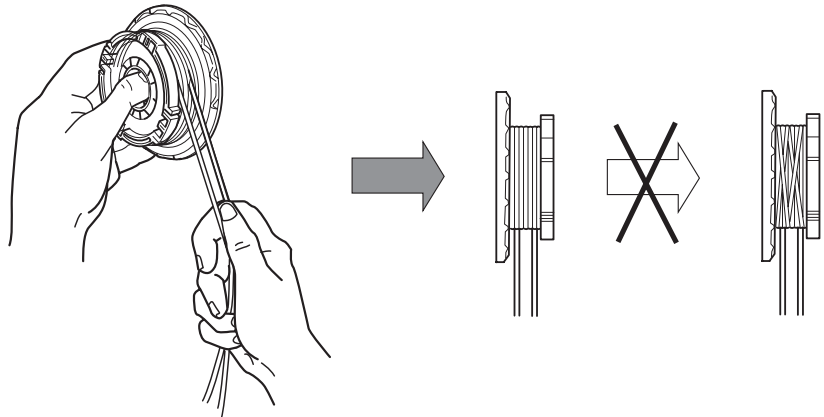

5

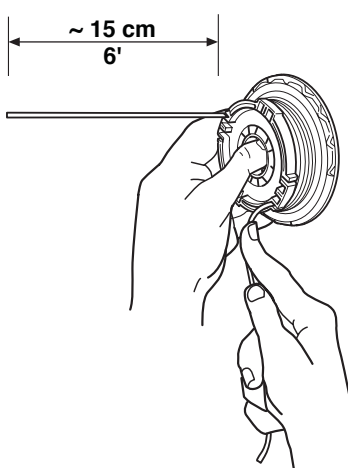

6

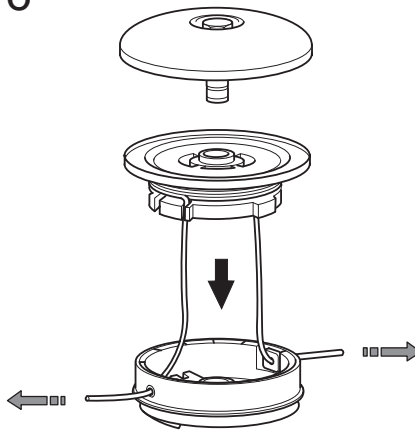

7

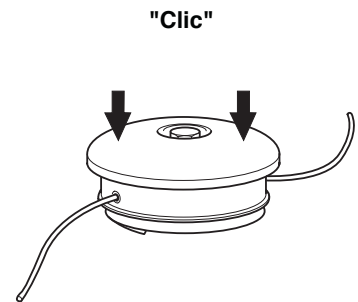

8

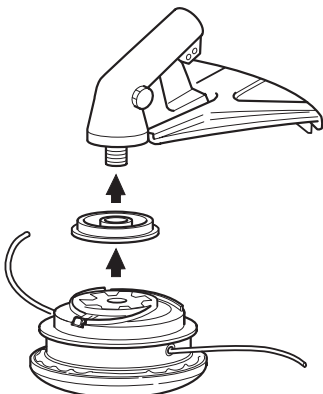

9

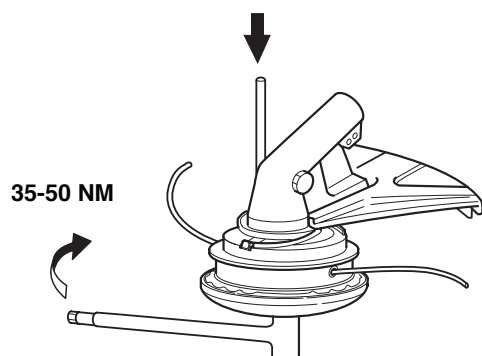

Trimmy SII

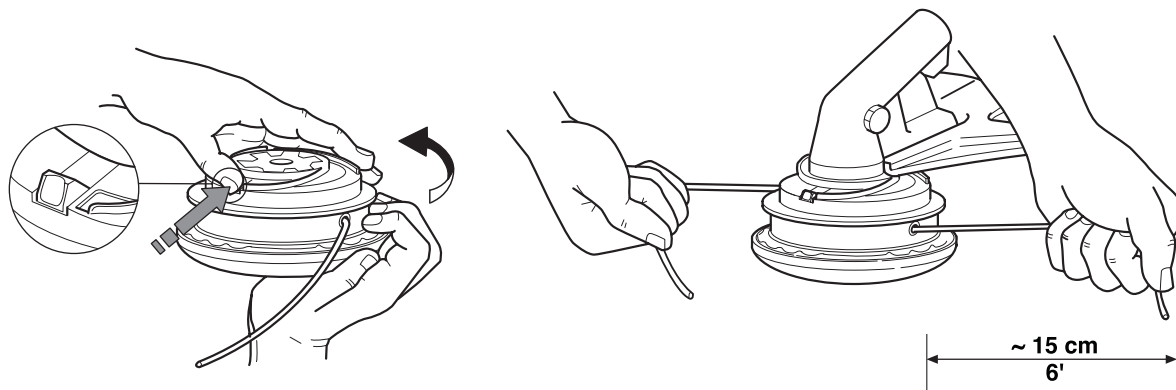

1

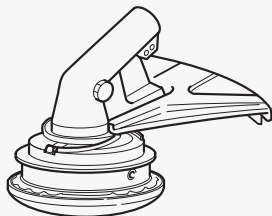

2

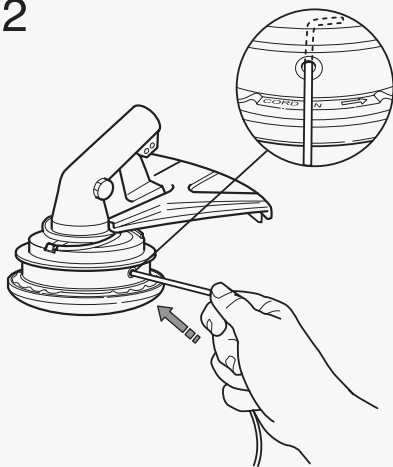

3

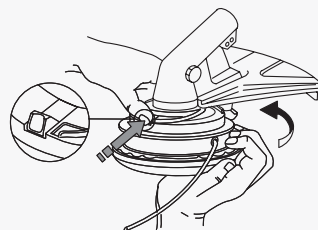

4

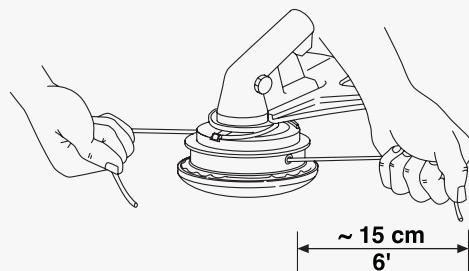

Auto 55

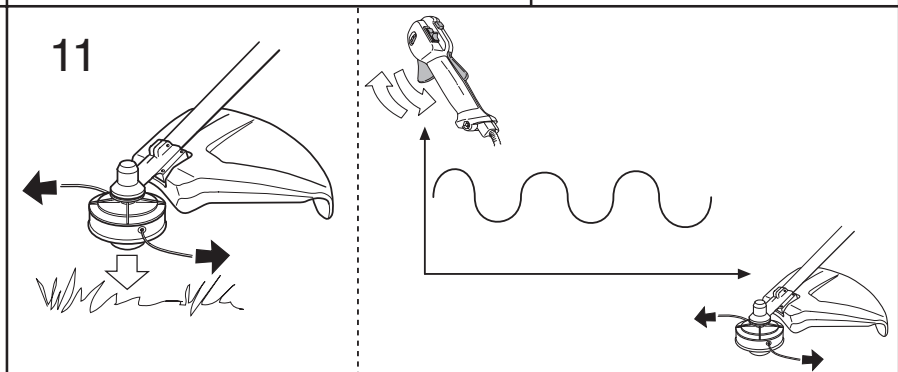
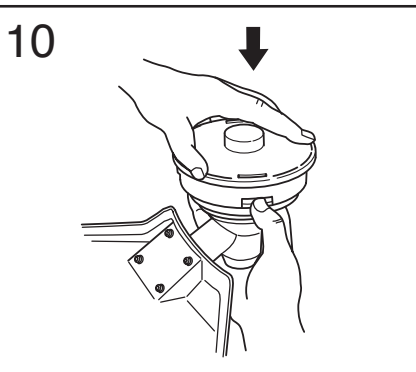
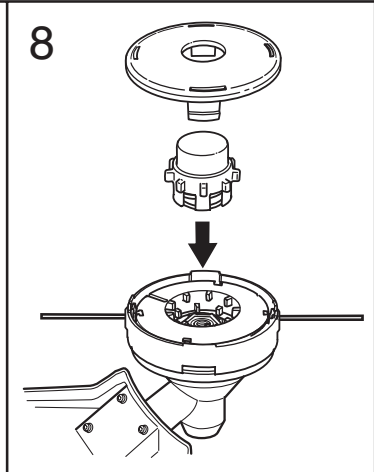
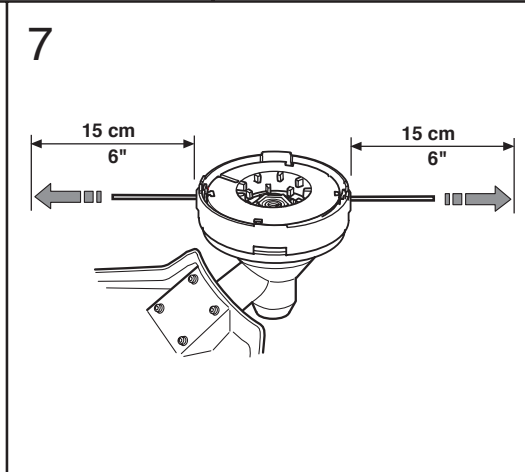
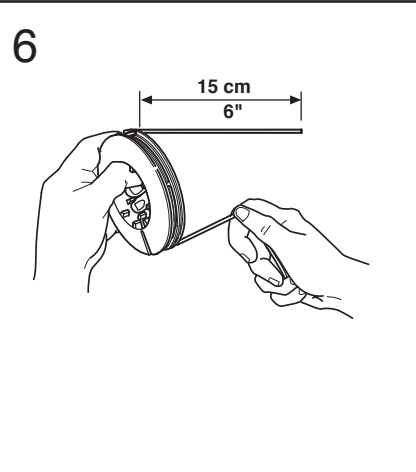
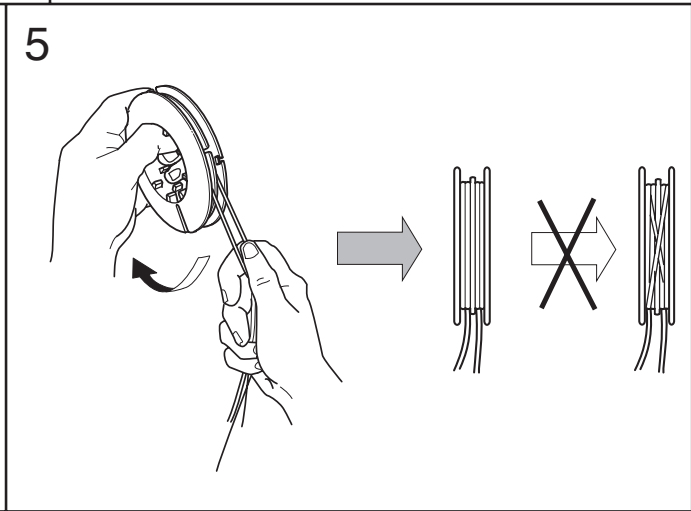
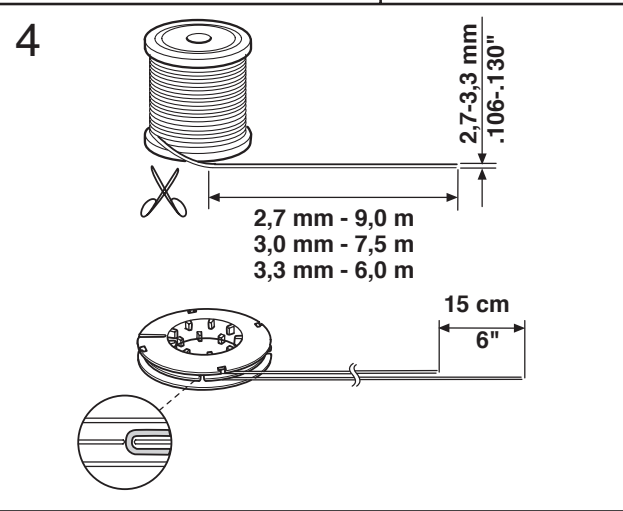
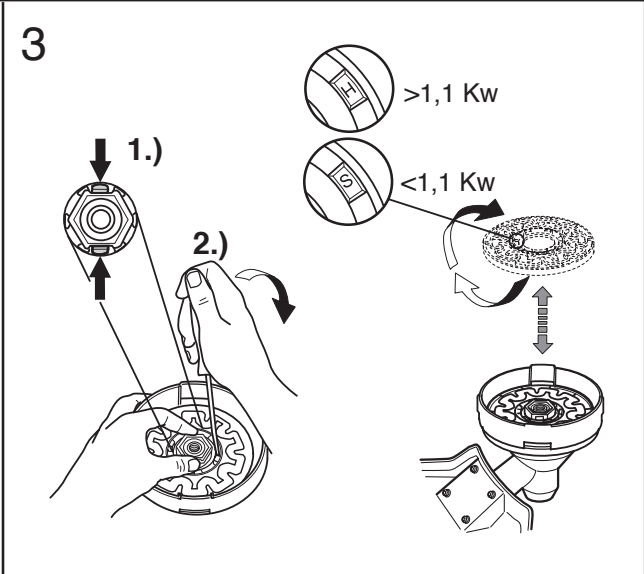
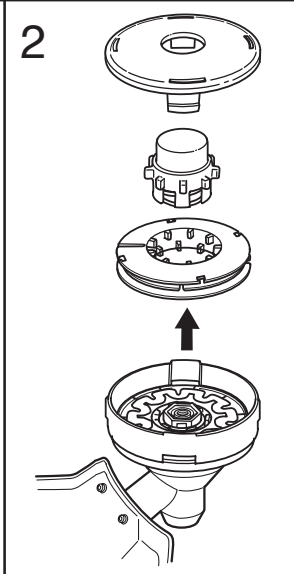
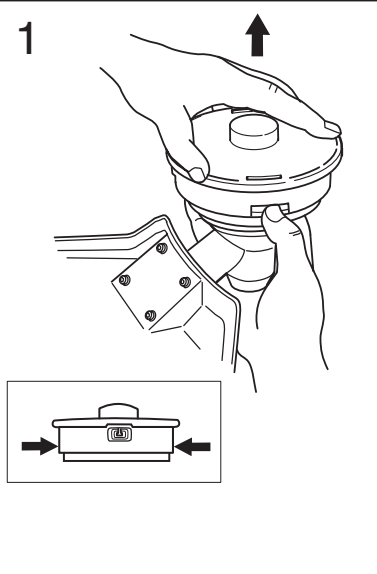

Tri Cut

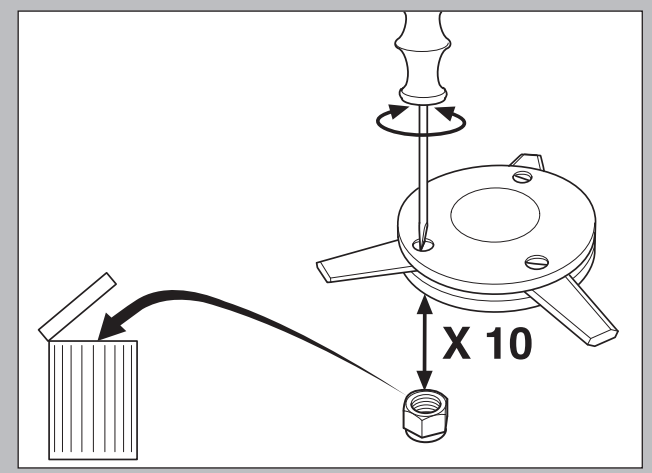
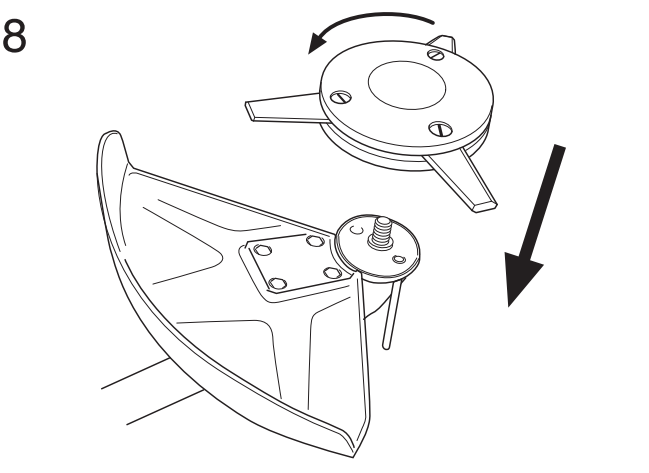
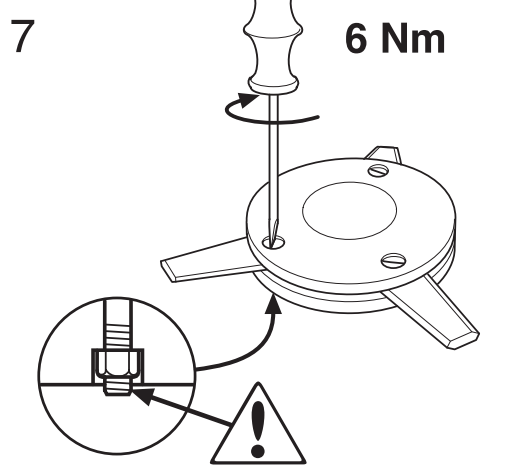
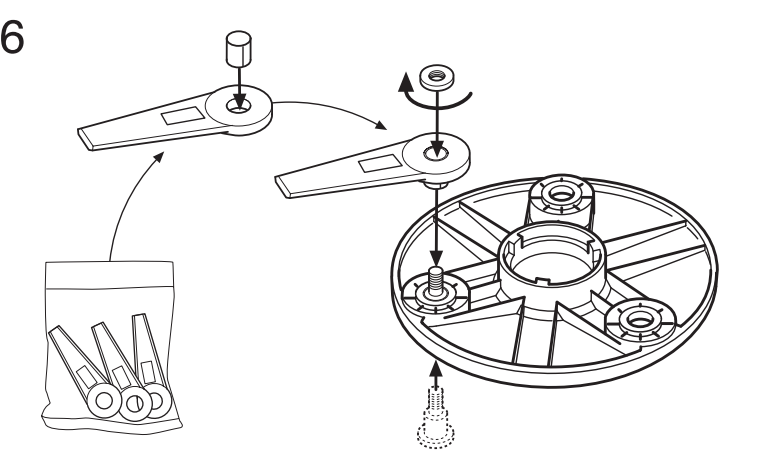
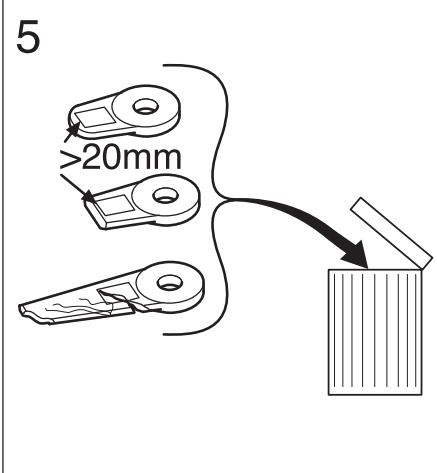
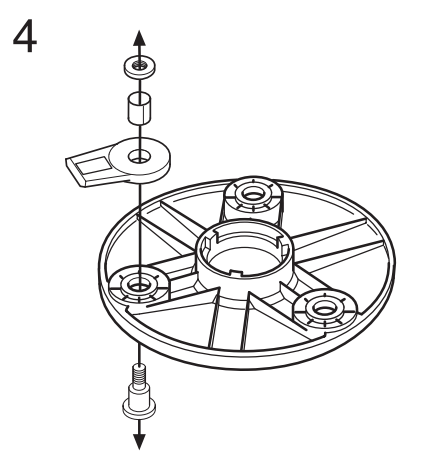
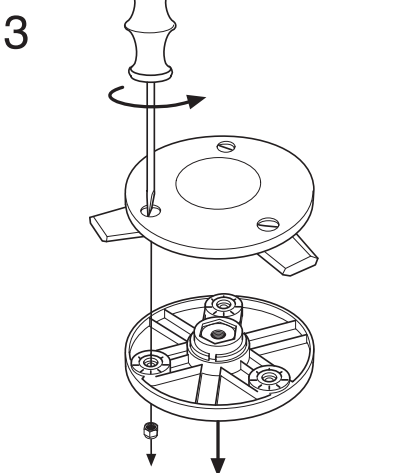
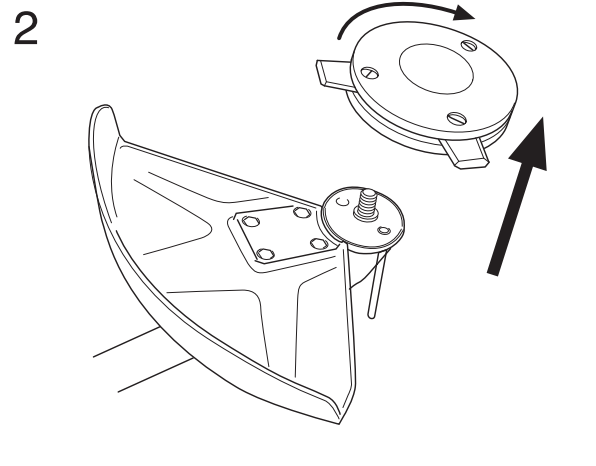
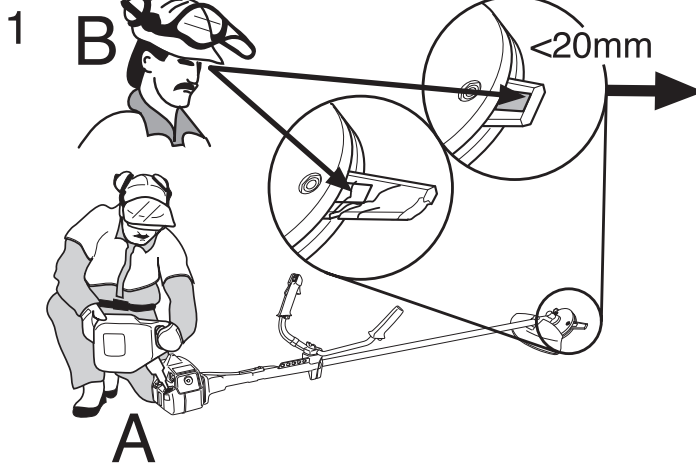



1150016-26



2005-09-26

Free Manuals Download Website

<http://myh66.com>

<http://usermanuals.us>

<http://www.somanuals.com>

<http://www.4manuals.cc>

<http://www.manual-lib.com>

<http://www.404manual.com>

<http://www.luxmanual.com>

<http://aubethermostatmanual.com>

Golf course search by state

<http://golfingnear.com>

Email search by domain

<http://emailbydomain.com>

Auto manuals search

<http://auto.somanuals.com>

TV manuals search

<http://tv.somanuals.com>