

▶ FFB63806PW
FFB63806PM

EN **User Manual**
Dishwasher

USER MANUAL



AEG

CONTENTS

1. SAFETY INFORMATION.....	2
2. SAFETY INSTRUCTIONS.....	4
3. PRODUCT DESCRIPTION.....	6
4. CONTROL PANEL.....	7
5. PROGRAMMES.....	7
6. SETTINGS.....	10
7. OPTIONS.....	13
8. BEFORE FIRST USE.....	14
9. DAILY USE.....	15
10. HINTS AND TIPS.....	18
11. CARE AND CLEANING.....	19
12. TROUBLESHOOTING.....	21
13. TECHNICAL INFORMATION.....	24

FOR PERFECT RESULTS

Thank you for choosing this AEG product. We have created it to give you impeccable performance for many years, with innovative technologies that help make life simpler features you might not find on ordinary appliances. Please spend a few minutes reading to get the very best from it.

Visit our website for:



Get usage advice, brochures, trouble shooter, service information:

www.aeg.com/webselfservice



Register your product for better service:

www.registeraeg.com



Buy Accessories, Consumables and Original spare parts for your appliance:

www.aeg.com/shop

CUSTOMER CARE AND SERVICE

Always use original spare parts.

When contacting our Authorised Service Centre, ensure that you have the following data available: Model, PNC, Serial Number.

The information can be found on the rating plate.

 Warning / Caution-Safety information

 General information and tips

 Environmental information

Subject to change without notice.

1. SAFETY INFORMATION

Before the installation and use of the appliance, carefully read the supplied instructions. The

manufacturer is not responsible for any injuries or damages that are the result of incorrect installation or usage. Always keep the instructions in a safe and accessible location for future reference.

1.1 Children and vulnerable people safety

- This appliance can be used by children aged from 8 years and above and persons with reduced physical, sensory or mental capabilities or lack of experience and knowledge if they have been given supervision or instruction concerning the use of the appliance in a safe way and understand the hazards involved.
- Children between 3 and 8 years of age and persons with very extensive and complex disabilities shall be kept away unless continuously supervised.
- Children of less than 3 years of age should be kept away unless continuously supervised.
- Do not let children play with the appliance.
- Keep detergents away from children.
- Keep children and pets away from the appliance when the door is open.
- Children shall not carry out cleaning and user maintenance of the appliance without supervision.

1.2 General Safety

- This appliance is intended to be used in household and similar applications such as:
 - farm houses; staff kitchen areas in shops, offices and other working environments;
 - by clients in hotels, motels, bed & breakfast and other residential type environments.
- Do not change the specification of this appliance.
- The operating water pressure (minimum and maximum) must be between 0.5 (0.05) / 8 (0.8) bar (MPa)
- Obey the maximum number of 13 place settings.

- If the supply cord is damaged, it must be replaced by the manufacturer, its Authorised Service Centre or similarly qualified persons in order to avoid a hazard.
- Put the cutlery in the cutlery basket with the sharp ends pointing down or put them in the cutlery drawer in a horizontal position with the sharp edges down.
- Do not leave the appliance with the open door unattended to avoid stepping accidentally onto it.
- Before any maintenance operation, deactivate the appliance and disconnect the mains plug from the socket.
- Do not use high pressure water sprays and/or steam to clean the appliance.
- If the appliance has ventilation openings in the base, they must not be covered e.g. by a carpet.
- The appliance is to be connected to the water mains using the new supplied hose-sets. Old hose sets must not be reused.

2. SAFETY INSTRUCTIONS

2.1 Installation



WARNING!

Only a qualified person must install this appliance.

- Remove all the packaging.
- Do not install or use a damaged appliance.
- Do not install or use the appliance where the temperature is less than 0 °C.
- Follow the installation instructions supplied with the appliance.
- Always take care when moving the appliance as it is heavy. Always use safety gloves and enclosed footwear.

2.2 Electrical connection



WARNING!

Risk of fire and electric shock.

- The appliance must be earthed.

- Make sure that the parameters on the rating plate are compatible with the electrical ratings of the mains power supply.
- Always use a correctly installed shockproof socket.
- Do not use multi-plug adapters and extension cables.
- Make sure not to cause damage to the mains plug and to the mains cable. Should the mains cable need to be replaced, this must be carried out by our Authorised Service Centre.
- Connect the mains plug to the mains socket only at the end of the installation. Make sure that there is access to the mains plug after the installation.
- Do not pull the mains cable to disconnect the appliance. Always pull the mains plug.
- This appliance complies with the E.E.C. Directives.
- UK and Ireland only. This appliance is fitted with a 13 A mains plug. If it is necessary to change the mains plug

fuse, use only a 13 A ASTA (BS 1362) fuse.

2.3 Water connection

- Do not cause damage to the water hoses.
- Before connection to new pipes, pipes not used for a long time, where repair work has been carried out or new devices fitted (water meters, etc.), let the water flow until it is clean and clear.
- Ensure that there are no visible water leaks during and after the first use of the appliance.
- The water inlet hose has a safety valve and a sheath with an inner mains cable.

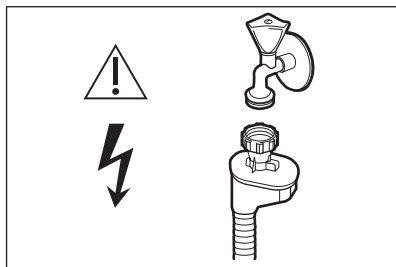

 **WARNING!**
Dangerous voltage.

- If the water inlet hose is damaged, immediately close the water tap and disconnect the mains plug from the mains socket. Contact the Authorised Service Centre to replace the water inlet hose.

2.4 Use

- Do not sit or stand on the open door.
- Dishwasher detergents are dangerous. Obey the safety instructions on the detergent packaging.
- Do not drink and play with the water in the appliance.
- Do not remove the dishes from the appliance until the programme is complete. Some detergent may remain on the dishes.
- The appliance can release hot steam if you open the door while a programme operates.
- Do not put flammable products or items that are wet with flammable products in, near or on the appliance.

2.5 Service

- To repair the appliance contact an Authorised Service Centre.
- Use original spare parts only.

2.6 Disposal

 **WARNING!**
Risk of injury or suffocation.

- Disconnect the appliance from the mains supply.
- Cut off the mains cable and discard it.
- Remove the door catch to prevent children and pets to get closed in the appliance.

3. PRODUCT DESCRIPTION

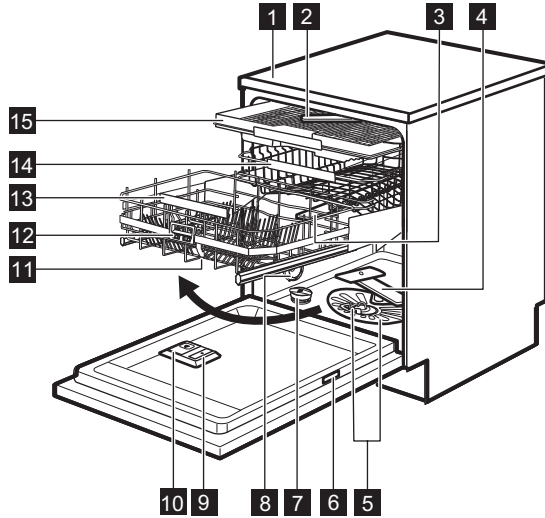

- | | |
|--------------------------|-------------------------------|
| 1 Worktop | 9 Rinse aid dispenser |
| 2 Top spray arm | 10 Detergent dispenser |
| 3 Upper spray arm | 11 Comfort Lift basket |
| 4 Lower spray arm | 12 Release handle |
| 5 Filters | 13 Lower basket handle |
| 6 Rating plate | 14 Upper basket |
| 7 Salt container | 15 Cutlery drawer |
| 8 Air vent | |

3.1 Beam-on-Floor

The Beam-on-Floor is a light that is displayed on the floor below the appliance door.

- When the programme starts, a red light comes on and stays on for the duration of the programme.
- When the programme is completed, a green light comes on.
- When the appliance has a malfunction, the red light flashes.

i The Beam-on-Floor is off when the appliance is deactivated.

i When AirDry is activated during the drying phase, the projection on the floor may not be completely visible. To see if the cycle has ended, check the control panel.

4. CONTROL PANEL

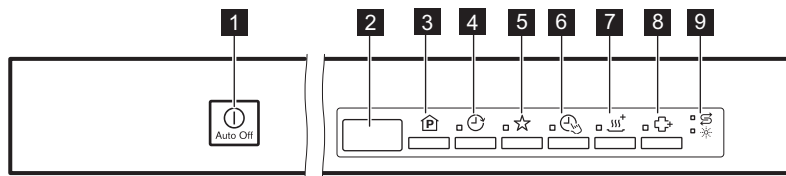

- | | |
|-----------------------------|------------------------------|
| 1 On/off button | 6 TimeSaver button |
| 2 Display | 7 XtraDry button |
| 3 Program button | 8 ExtraHygiene button |
| 4 Delay button | 9 Indicators |
| 5 MyFavourite button | |

4.1 Indicators



Indicator	Description
	Salt indicator. It is on when the salt container needs refilling.
	Rinse aid indicator. It is on when the rinse aid dispenser needs refilling.

5. PROGRAMMES

The numbering of the programmes in the table (P1, P2, etc.) reflects their sequence on the control panel.

The order of the programmes in the table may not reflect their sequence on the control panel.

Programme	Degree of soil Type of load	Programme phases	Options
P1 ECO 1)	<ul style="list-style-type: none"> Normal soil Crockery and cutlery 	<ul style="list-style-type: none"> Prewash Wash 50 °C Rinses Dry 	<ul style="list-style-type: none"> ExtraHygiene XtraDry
P2 AUTO SENSE 2)	<ul style="list-style-type: none"> All Crockery, cutlery, pots and pans 	<ul style="list-style-type: none"> Prewash Wash from 45 °C to 70 °C Rinses Dry 	<ul style="list-style-type: none"> ExtraHygiene XtraDry



Programme	Degree of soil Type of load	Programme phases	Options
P6 PRO ZONE 3)	<ul style="list-style-type: none"> Mixed soil Crockery, cutlery, pots and pans 	<ul style="list-style-type: none"> Prewash Wash 50 °C and 65 °C Rinses Dry 	<ul style="list-style-type: none"> TimeSaver XtraDry
P3  4)	<ul style="list-style-type: none"> Heavy soil Crockery, cutlery, pots and pans 	<ul style="list-style-type: none"> Prewash Wash 70 °C Rinses Dry 	<ul style="list-style-type: none"> TimeSaver ExtraHygiene XtraDry
P4 89MIN 5)	<ul style="list-style-type: none"> Normal soil Crockery and cutlery 	<ul style="list-style-type: none"> Wash 60 °C Rinses Dry 	<ul style="list-style-type: none"> ExtraHygiene XtraDry
P5 30MIN 6)	<ul style="list-style-type: none"> Light soil Crockery and cutlery 	<ul style="list-style-type: none"> Wash 60 °C Rinses 	<ul style="list-style-type: none"> ExtraHygiene XtraDry
P7  7)	<ul style="list-style-type: none"> Normal or light soil Delicate crockery and glassware 	<ul style="list-style-type: none"> Wash 45 °C Rinses Dry 	<ul style="list-style-type: none"> XtraDry
P8 SILENT 8)	<ul style="list-style-type: none"> Normal soil Crockery and cutlery 	<ul style="list-style-type: none"> Prewash Wash 50 °C Rinses Dry 	<ul style="list-style-type: none"> XtraDry
P9  9)	<ul style="list-style-type: none"> All 	<ul style="list-style-type: none"> Prewash 	

Programme	Degree of soil Type of load	Programme phases	Options
P0  10)	<ul style="list-style-type: none"> No load 	<ul style="list-style-type: none"> Self-cleaning 	

- 1) This programme offers the most efficient use of water and energy consumption for crockery and cutlery with normal soil. This is the standard programme for test institutes.
- 2) The appliance senses the degree of soil and the quantity of items in the baskets. It automatically adjusts the temperature and quantity of water, energy consumption and programme duration.
- 3) This programme is suitable for washing a load with mixed soil. Place items with heavy soil in the lower basket and with normal soil in the upper basket. The pressure and temperature of the water in the lower basket are higher than in the upper basket.
- 4) This programme is designed to wash heavily soiled items with high water pressure and at a high temperature.
- 5) This programme is suitable for washing a load with normal soil.
- 6) This programme is suitable for washing a load or a half load with fresh or light soil in a short time.
- 7) This programme controls the temperature of the water to provide special care for delicate items, glassware in particular.
- 8) This is the most silent programme. The pump works at a very low speed to reduce the noise generated by the appliance. Due to the low speed, the programme duration is long.
- 9) With this programme, you can quickly rinse off food remains from dishes and prevent odours forming in the appliance. Do not use detergent with this programme.
- 10) This programme is designed to clean the inside of the appliance effectively and efficiently. It removes limescale and grease buildup. The programme should be run at least once every 2 months with a descaler or a cleaning product designed for dishwashers and without any load.

5.1 Consumption values

Programme ¹⁾	Water (l)	Energy (kWh)	Duration (min)
P1 ECO	11	0.921	235
P2 AUTO SENSE	8 - 15	0.7 - 1.7	46 - 170
P6 PRO ZONE	14 - 16	1.2 - 1.5	160 - 180
P3 	12.5 - 14.5	1.4 - 1.7	170 - 190
P4 89MIN	12.9	1.14	89
P5 30MIN	10	0.9	30

Programme 1)	Water (l)	Energy (kWh)	Duration (min)
P7 	12 - 14	0.8 - 1.0	82 - 92
P8 SILENT	12 - 13	1.1 - 1.3	230 - 250
P9 	4	0.1	14
P0 	10	0.86	60 - 70

1) The pressure and the temperature of the water, the variations of the mains supply, the options and the quantity of dishes can change the values.

5.2 Information for test institutes

To receive the necessary information for conducting performance tests (e.g. according to EN60436), send an email to:

info.test@dishwasher-production.com

In your request please include the product number code (PNC) found on the rating plate.

For any other questions regarding your dishwasher please refer to the service book provided with your appliance.

6. SETTINGS

6.1 Programme selection mode and user mode

When the appliance is in programme selection mode it is possible to set a programme and to enter user mode.

Settings available in the user mode:



- The level of water softener according to the water hardness.
- Activation or deactivation of the rinse aid empty notification.
- The level of rinse aid according to the required dosage.
- Activation or deactivation of the acoustic signal for the end of a programme.
- Activation or deactivation of AirDry.

As the appliance stores the saved settings, there is no need to configure it before every cycle.

How to set the programme selection mode







The appliance is in programme selection mode when the display shows the programme number **P1**.

After activation, the appliance is in programme selection mode by default. If not, set the programme selection mode the following way:

Press and hold simultaneously  and  until the appliance is in programme selection mode.

How to enter user mode

Make sure the appliance is in programme selection mode.

To enter user mode, press and hold simultaneously  and  until the indicators , , ,  and  flash and the display is blank.

6.2 The water softener

The water softener removes minerals from the water supply, which would have a negative effect on the washing results and on the appliance.

The higher the content of these minerals, the harder your water is. Water hardness is measured in equivalent scales.

The water softener should be adjusted according to the hardness of the water in your area. Your local water authority can advise you on the hardness of the water in your area. It is important to set the right level of the water softener to assure good washing results.

Water hardness

German degrees (°dH)	French degrees (°fH)	mmol/l	Clarke degrees	Water softener level
47 - 50	84 - 90	8.4 - 9.0	58 - 63	10
43 - 46	76 - 83	7.6 - 8.3	53 - 57	9
37 - 42	65 - 75	6.5 - 7.5	46 - 52	8
29 - 36	51 - 64	5.1 - 6.4	36 - 45	7
23 - 28	40 - 50	4.0 - 5.0	28 - 35	6
19 - 22	33 - 39	3.3 - 3.9	23 - 27	5 1)
15 - 18	26 - 32	2.6 - 3.2	18 - 22	4
11 - 14	19 - 25	1.9 - 2.5	13 - 17	3
4 - 10	7 - 18	0.7 - 1.8	5 - 12	2
<4	<7	<0.7	< 5	1 2)

1) Factory setting.

2) Do not use salt at this level.

Regardless of the type of detergent used, set the proper water hardness level to keep the salt refill indicator active.



Multi-tabs containing salt are not effective enough to soften hard water.

How to set the water softener level

Make sure the appliance is in user mode.

- Press .
 - The indicators and are off.
 - The indicator still flashes.

- The display shows the current setting: e.g. 5 = level 5.
- Press repeatedly to change the setting.
 - Press the on/off button to confirm the setting.

6.3 The rinse aid empty notification

The rinse aid helps to dry the dishes without streaks and stains. It is automatically released during the hot rinse phase.







When the rinse aid chamber is empty, the rinse aid indicator is turned on notifying to refill rinse aid. If the drying results are satisfactory while using multi-tablets only, it is possible to deactivate

the notification for refilling rinse aid. However, for best drying performance, always use rinse aid.

If standard detergent or multi-tablets without rinse aid are used, activate the notification to keep the rinse aid refill indicator active.

How to deactivate the rinse aid empty notification

Make sure the appliance is in user mode.

1. Press .
 - The indicators , ,  and  are off.
 - The indicator  still flashes.
 - The display shows the current setting.
 - **0d** = the rinse aid empty notification is deactivated.
 - **1d** = the rinse aid empty notification is activated.
2. Press  to change the setting.
3. Press on/off to confirm the setting.







6.4 The rinse aid level

It is possible to set the released quantity of rinse aid between level 1 (minimum quantity) and level 6 (maximum quantity). Level 0 deactivates the rinse aid dispenser and no rinse aid is released.

Factory setting: level 4.

How to set the rinse aid level

Make sure the appliance is in user mode.

1. Press .
 - The indicators , ,  and  are off.
 - The indicator  still flashes.
 - The display shows the current setting: e.g. **4A** = level 4.
 - The levels of rinse aid range from 0A to 6A where 0A means no rinse aid is used.
2. Press  repeatedly to change the setting.
3. Press on/off to confirm the setting.







6.5 Acoustic signals

Acoustic signals sound when a malfunction of the appliance occurs. It is not possible to deactivate these acoustic signals.

There is also an acoustic signal that sounds when the programme is completed. By default this acoustic signal is deactivated but it is possible to activate it.

How to activate the acoustic signal for the end of programme

Make sure the appliance is in user mode.

1. Press .
 - The indicators , ,  and  are off.
 - The indicator  still flashes.
 - The display shows the current setting.
 - **0b** = the acoustic signal is deactivated.
 - **1b** = the acoustic signal is activated.
2. Press  to change the setting.
3. Press on/off to confirm the setting.

6.6 AirDry

AirDry improves the drying results with less energy consumption.

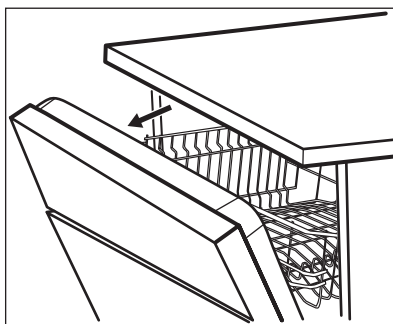

-  During the drying phase, the door opens automatically and remains ajar.

**CAUTION!**

Do not try to close the appliance door within 2 minutes after automatic opening. This can cause damage to the appliance. If, afterwards, the door is closed for another 3 minutes, the running programme ends.

AirDry is automatically activated with all programmes excluding (if applicable).

To improve the drying performance refer to the XtraDry option or activate AirDry.

**CAUTION!**

If children have access to the appliance, it is advised to deactivate AirDry as opening the door may pose a danger.

How to deactivate AirDry

Make sure the appliance is in user mode.

1. Press
 - The indicators , , and are off.
 - The indicator still flashes.
 - The display shows the current setting.

- = AirDry is deactivated.
- = AirDry is activated.

2. Press to change the setting.
3. Press on/off to confirm the setting.

6.7 MyFavourite

This option allows to set and save the most frequently used programme.

It is possible to save only 1 programme. A new setting cancels the previous one.

How to save the MyFavourite programme

1. Set the chosen programme. It is also possible to set applicable options together with the programme.
2. Press and hold until the related indicator is on.

How to set the MyFavourite programme

Press .

- The MyFavourite indicator is on.
- The display shows the number and the duration of the programme.
- If options are saved together with the programme, the indicators related to the options are on.

7. OPTIONS



Desired options must be activated every time before you start a programme. It is not possible to activate or deactivate options while a programme is running.



Not all options are compatible with each other. If you select non compatible options, the appliance automatically deactivates one or more of them. Only the indicators of the still active options are on.



If an option is not applicable to a programme, the related indicator is off or it flashes quickly for a few seconds and then goes out.



Activating options can affect the water and energy consumption as well as the programme duration.

7.1 XtraDry

Activate this option to boost the drying performance.

XtraDry is a permanent option for all programmes other than **ECO**. It is

automatically activated in next cycles. This configuration can be changed at any time.



Every time **ECO** is activated, XtraDry is off and needs to be chosen manually.

Activating XtraDry deactivates TimeSaver and vice versa.

How to activate XtraDry

Press .

The related indicator is on.

The display shows the updated programme duration.

7.2 TimeSaver

The TimeSaver allows to reduce the duration of a selected programme by approximately 50%.

The washing results are the same as with the normal programme duration. The drying results can decrease.

This option increases the pressure and the temperature of the water. The

washing and the drying phases are shorter.

By default, TimeSaver is off, but it is possible to activate it manually. This option cannot be combined with XtraDry.

How to activate TimeSaver

Press .

The related indicator is on.

The display shows the updated programme duration.

7.3 ExtraHygiene

This option provides better hygiene results by keeping the temperature at 70 °C for at least 10 minutes during the last rinsing phase.

How to activate ExtraHygiene

Press .

The related indicator is on.

The display shows the updated programme duration.

8. BEFORE FIRST USE

1. **Make sure that the current level of the water softener agrees with the hardness of the water supply. If not, adjust the level of the water softener.**
2. Fill the salt container.
3. Fill the rinse aid dispenser.
4. Open the water tap.
5. Start a programme to remove any processing residuals that can still be inside the appliance. Do not use detergent and do not load the baskets.

After starting a programme, it may take up to 5 minutes for the appliance to recharge the resin in the water softener. It seems that the appliance is not working. The washing phase starts only after this procedure is completed. The procedure is repeated periodically.

8.1 The salt container



CAUTION!

Use rough salt designed for dishwashers only. Fine salt increases the risk of corrosion.

The salt is used to recharge the resin in the water softener and to assure good washing results in daily use.

How to fill the salt container



Make sure that the Comfort Lift basket is empty and locked in the raised position.

1. Turn the cap of the salt container counterclockwise and remove it.
2. Put 1 litre of water in the salt container (only for the first time).

3. Fill the salt container with dishwasher salt (until it is full).

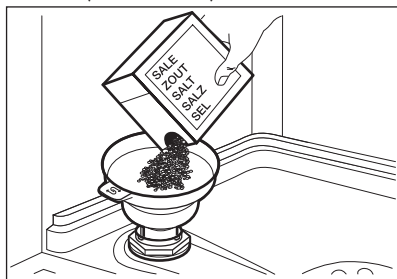

4. Carefully shake the funnel by its handle to get the last granules inside.
5. Remove the salt around the opening of the salt container.

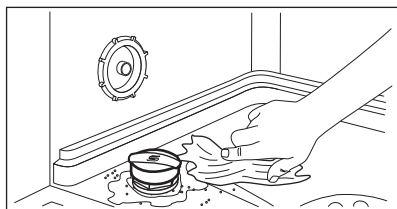

6. Turn the cap of the salt container clockwise to close the salt container.



CAUTION!

Water and salt can come out of the salt container when you fill it. After you fill the salt container, immediately start the shortest programme to prevent corrosion. Do not put dishes in the baskets.

8.2 How to fill the rinse aid dispenser

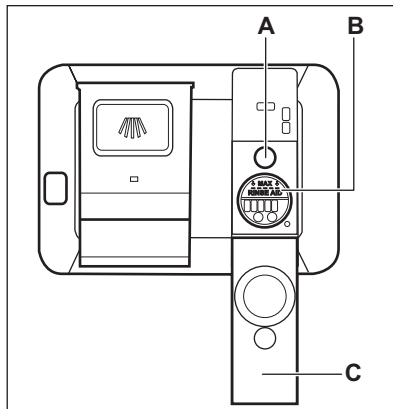

CAUTION!

Only use rinse aid designed specifically for dishwashers.

1. Open the lid (C).
2. Fill the dispenser (B) until the rinse aid reaches the marking "MAX".
3. Remove the spilled rinse aid with an absorbent cloth to prevent excessive foam formation.
4. Close the lid. Make sure that the lid locks into position.



Fill the rinse aid dispenser when the indicator (A) is clear.

9. DAILY USE

1. Open the water tap.
2. Press the on/off button to activate the appliance.
Make sure that the appliance is in programme selection mode.
 - If the salt indicator is on, fill the salt container.
 - If the rinse aid indicator is on, fill the rinse aid dispenser.
3. Load the baskets.
4. Add the detergent.
5. Set and start a programme suitable for the type of load and the degree of soil.

9.1 Comfort Lift



CAUTION!

Do not sit on the rack or put excessive pressure on the locked basket.



CAUTION!

Do not exceed the max load capacity of 18 kg.

**CAUTION!**

Make sure that items do not stick out of the basket frame as it can cause damage to the items and the Comfort Lift mechanism.

The Comfort Lift mechanism allows to lift the lower rack up (to the second rack level) and put it down to load and unload dishes easily.

To load or unload the lower basket:

1. Lift the basket by pulling the rack out of the dishwasher by the basket handle. The trigger handle should not be used.

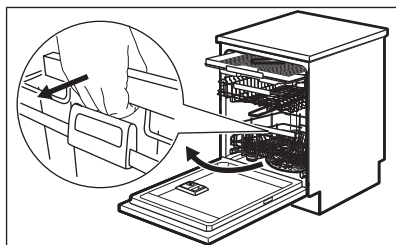

The basket is automatically locked on the upper level.

2. Carefully place items in the basket or remove them (refer to **Basket loading leaflet**).
3. Lower the basket by connecting the trigger handle with the basket frame as shown below. Lift the trigger handle completely and the basket disengages on both sides.

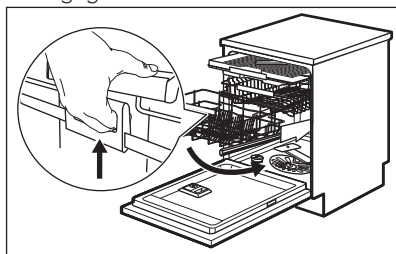

Once the basket is unlocked, push the rack down. The mechanism returns to its default position on the lower level.

There are two ways of lowering the basket depending on the loading:

- If there is a full load of plates, slightly push the basket down.
- If the basket is empty or half-loaded, press the basket down.

9.2 Using the detergent

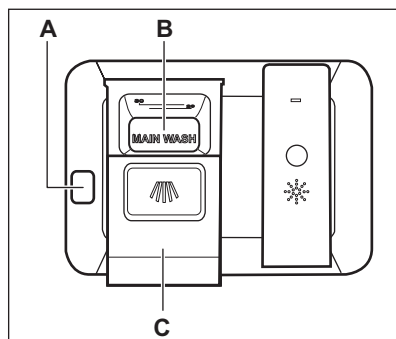
**CAUTION!**

Only use detergent specifically designed for dishwashers.

1. Press the release button (A) to open the lid (C).
2. Put the detergent, in powder or tablets, in the compartment (B).
3. If the programme has a prewash phase, put a small quantity of detergent on the inner part of the appliance door.
4. Close the lid. Make sure that the lid locks into position.

9.3 Setting and starting a programme

Starting a programme

1. Keep the appliance door ajar.
2. Press the on/off button to activate the appliance. Make sure that the appliance is in programme selection mode.
3. Press repeatedly  until the display shows the number of the chosen programme. The display shows the programme number for

approximately 3 seconds and then shows the programme duration.

- To select the MyFavourite programme, press ☆.
 - The indicators of the options related to the MyFavourite programme are on.
4. Set the applicable options.
 5. Close the appliance door to start the programme.

Starting a programme with delay start

1. Set a programme.
2. Press ⌚ repeatedly until the display shows the desired delay time (from 1 to 24 hours).

The indicator ⌚ is on.

3. Close the appliance door to start the countdown.

During the countdown, it is possible to increase the delay time but not to change the programme and options.

When the countdown is completed, the programme starts.

Opening the door while the appliance operates

Opening the door while a programme is running stops the appliance. It may affect the energy consumption and the programme duration. After closing the door, the appliance continues from the point of interruption.



If the door is opened for more than 30 seconds during the drying phase, the running programme ends. It does not happen if the door is opened by AirDry function.

Cancelling the delay start while the countdown operates

When you cancel the delay start you have to set the programme and options again.

Press and hold simultaneously ⌚ and ☆ until the appliance is in programme selection mode.

Cancelling the programme

Press and hold simultaneously ⌚ and ☆ until the appliance is in programme selection mode.

Make sure that there is detergent in the detergent dispenser before you start a new programme.

End of the programme

When the programme is completed the display shows 0:00.

All buttons are inactive except for the on/off button.

1. Press the on/off button or wait for the Auto Off function to automatically deactivate the appliance.
If you open the door before the activation of Auto Off, the appliance is automatically deactivated.
2. Close the water tap.

The Auto Off function

This function decreases energy consumption by deactivating automatically the appliance when it is not operating.

The function comes into operation:

- 5 minutes after the completion of the programme.
- After 5 minutes if the programme has not started.

10. HINTS AND TIPS

10.1 General

Follow the hints below to ensure optimal cleaning and drying results in daily use and to help you protect the environment.

- Remove larger residues of food from the dishes into the waste bin.
- Do not pre-rinse dishes by hand. When needed, select a programme with a prewash phase.
- Always use the whole space of the baskets.
- Make sure that items in the baskets do not touch or cover each other. Only then can the water completely reach and wash the dishes.
- You can use dishwasher detergent, rinse aid and salt separately or you can use the multi-tablets (e.g. "All in 1"). Follow the instructions on the packaging.
- Select a programme according to the type of load and the degree of soil.

ECO offers the most efficient use of water and energy consumption.

10.2 Using salt, rinse aid and detergent

- Only use salt, rinse aid and detergent designed for dishwasher. Other products can cause damage to the appliance.
- In areas with hard and very hard water, we recommend to use basic dishwasher detergent (powder, gel, tablets containing no additional agents), rinse aid and salt separately for optimal cleaning and drying results.
- Detergent tablets do not fully dissolve with short programmes. To prevent detergent residues on the tableware, we recommend that you use tablets with long programmes.
- Do not use more than the correct quantity of detergent. Refer to the instructions on the detergent packaging.

10.3 What to do if you want to stop using multi-tablets

Before you start to use separately detergent, salt and rinse aid, complete the following steps:

1. Set the highest level of the water softener.
2. Make sure that the salt and rinse aid containers are full.
3. Start the shortest programme with a rinsing phase. Do not add detergent and do not load the baskets.
4. When the programme is completed, adjust the water softener according to the water hardness in your area.
5. Adjust the released quantity of rinse aid.
6. Activate the rinse aid empty notification.

10.4 Loading the baskets

- Use the appliance to wash dishwasher-safe items only.
- Do not wash in the appliance items made of wood, horn, aluminium, pewter and copper.
- Do not wash in the appliance items that can absorb water (sponges, household cloths).
- Remove large food residues from dishes.
- Soak cookware with burnt-on food before washing it in the appliance.
- Put hollow items (cups, glasses and pans) with the opening facing downwards.
- Make sure that glasses do not touch each other.
- Put light items in the upper basket. Make sure that the items do not move freely.
- Put cutlery and small items in the cutlery drawer.
- Make sure that the spray arms can move freely before you start a programme.

10.5 Before starting a programme

Before you start the selected programme, make sure that:

- The filters are clean and correctly installed.
- The cap of the salt container is tight.
- The spray arms are not clogged.
- There is enough salt and rinse aid (unless you use multi-tablets).
- The arrangement of the items in the baskets is correct.
- The programme is suitable to the type of load and the degree of soil.

- The correct quantity of detergent is used.

10.6 Unloading the baskets

1. Let the tableware cool down before you remove it from the appliance. Hot items can be easily damaged.
2. First remove items from the lower basket, then from the upper basket.

i After the programme is completed, water can still remain on the inside surfaces of the appliance.

11. CARE AND CLEANING



WARNING!

Before maintenance, deactivate the appliance and disconnect the mains plug from the main socket.



Dirty filters and clogged spray arms decrease the washing results. Make a check regularly and, if necessary, clean them.

11.1 Cleaning the filters

The filter system is made of 3 parts.

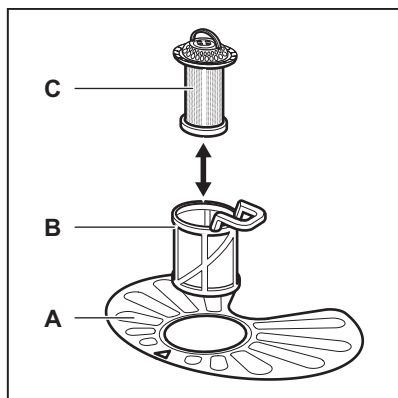

1. Turn the filter (B) counterclockwise and remove it.

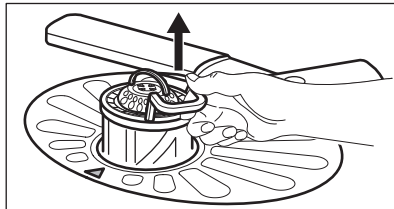
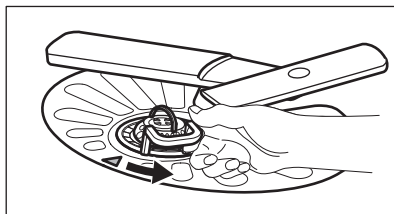

2. Remove the filter (C) out of filter (B).
3. Remove the flat filter (A).

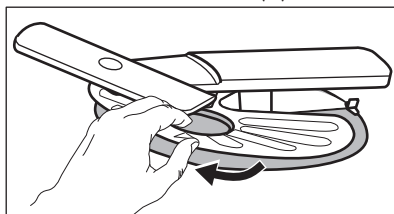

4. Wash the filters.

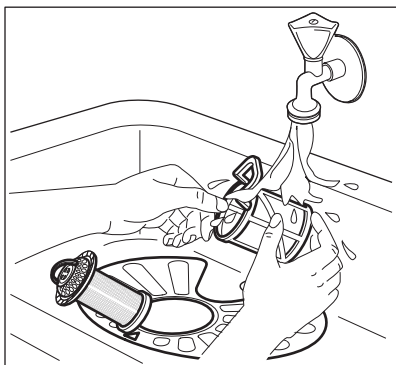

5. Make sure that there are no residues of food or soil in or around the edge of the sump.
6. Put back in place the flat filter (A). Make sure that it is correctly positioned under the 2 guides.

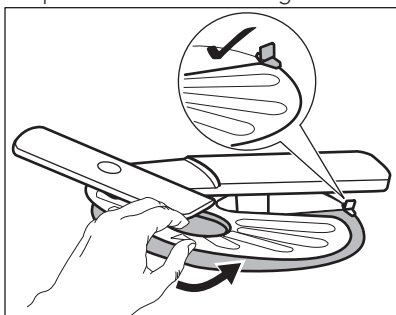

7. Reassemble the filters (B) and (C).
8. Put back the filter (B) in the flat filter (A). Turn it clockwise until it locks.

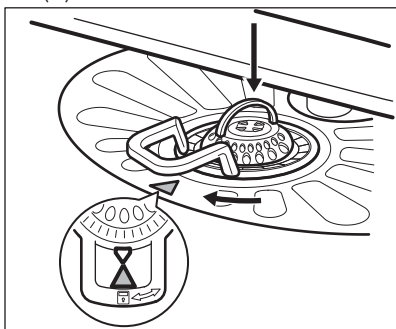
**CAUTION!**

An incorrect position of the filters can cause bad washing results and damage to the appliance.

11.2 Cleaning the upper spray arm

We recommend to clean the upper spray arm regularly to prevent soil from clogging the holes.

Clogged holes can cause unsatisfactory washing results.

1. Pull out the upper basket.
2. To detach the spray arm from the basket, press the spray arm upwards and simultaneously turn it clockwise.

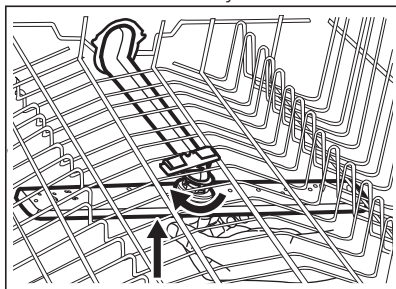

3. Wash the spray arm under running water. Use a thin pointed tool, e.g. a toothpick, to remove particles of soil from the holes.

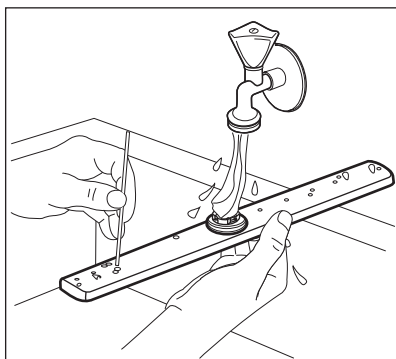

4. To install the spray arm back, press the spray arm upwards and simultaneously turn it counterclockwise until it locks into place.

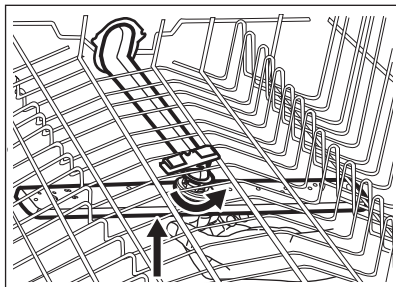

11.3 External cleaning

- Clean the appliance with a moist soft cloth.
- Only use neutral detergents.
- Do not use abrasive products, abrasive cleaning pads or solvents.

11.4 Internal cleaning

- Carefully clean the appliance, including the rubber gasket of the door, with a soft damp cloth.

- To maintain the performance of your appliance, use a cleaning product designed specifically for dishwashers at least once every two months. Carefully follow the instructions on the packaging of the product.
- Use the 📄 programme for optimal cleaning results.
- Do not use abrasive products, abrasive cleaning pads, sharp tools, strong chemicals, scourer or solvents.
- Using short-duration programmes regularly can cause grease and limescale buildup inside the appliance. Run long-duration programmes at least twice a month to prevent the buildup.

12. TROUBLESHOOTING



WARNING!

Improper repair of the appliance may pose a danger to the safety of the user. Any repairs must be performed by qualified personnel.

to contact an Authorised Service Centre.

Refer to the below table for information on possible problems.

With some problems, the display shows an alarm code.

The majority of problems that may occur can be solved without the need

Problem and alarm code	Possible cause and solution
You cannot activate the appliance.	<ul style="list-style-type: none"> • Make sure that the mains plug is connected to the mains socket. • Make sure that there is no damaged fuse in the fuse box.
The programme does not start.	<ul style="list-style-type: none"> • Make sure that the appliance door is closed. • If the delay start is set, cancel the setting or wait for the end of the countdown. • The appliance recharges the resin inside the water softener. The duration of the procedure is approximately 5 minutes.

Problem and alarm code	Possible cause and solution
<p>The appliance does not fill with water.</p> <p>The display shows <i>10</i> or <i>11</i>.</p>	<ul style="list-style-type: none"> • Make sure that the water tap is open. • Make sure that the pressure of the water supply is not too low. For this information, contact your local water authority. • Make sure that the water tap is not clogged. • Make sure that the filter in the inlet hose is not clogged. • Make sure that the inlet hose has no kinks or bends.
<p>The appliance does not drain the water.</p> <p>The display shows <i>20</i>.</p>	<ul style="list-style-type: none"> • Make sure that the sink spigot is not clogged. • Make sure that the filter in the outlet hose is not clogged. • Make sure that the interior filter system is not clogged. • Make sure that the drain hose has no kinks or bends.
<p>The anti-flood device is on.</p> <p>The display shows <i>30</i>.</p>	<ul style="list-style-type: none"> • Close the water tap and contact an Authorised Service Centre.
<p>The appliance stops and starts more times during operation.</p>	<ul style="list-style-type: none"> • It is normal. It provides optimal cleaning results and energy savings.
<p>The programme lasts too long.</p>	<ul style="list-style-type: none"> • If the delay start option is set, cancel the delay setting or wait for the end of the countdown. • Activate the TimeSaver option to reduce the programme duration. • Activating options can increase the programme duration.
<p>The remaining time in the display increases and skips nearly to the end of the programme duration.</p>	<ul style="list-style-type: none"> • This is not a defect. The appliance is working correctly.
<p>Small leak from the appliance door.</p>	<ul style="list-style-type: none"> • The appliance is not levelled. Loosen or tighten the adjustable feet (if applicable). • The appliance door is not centred on the tub. Adjust the rear foot (if applicable).
<p>The appliance door is difficult to close.</p>	<ul style="list-style-type: none"> • The appliance is not levelled. Loosen or tighten the adjustable feet (if applicable). • Parts of the tableware are protruding from the baskets.
<p>Rattling or knocking sounds from the inside of the appliance.</p>	<ul style="list-style-type: none"> • The tableware is not properly arranged in the baskets. Refer to basket loading leaflet. • Make sure that the spray arms can rotate freely.
<p>The appliance trips the circuit-breaker.</p>	<ul style="list-style-type: none"> • The amperage is insufficient to supply simultaneously all the appliances in use. Check the socket amperage and the capacity of the meter or turn off one of the appliances in use. • Internal electrical fault of the appliance. Contact an Authorised Service Centre.



Refer to "**Before first use**", "**Daily use**", or "**Hints and tips**" for other possible causes.

the problem occurs again, contact an Authorised Service Centre.

For alarm codes not described in the table, contact an Authorised Service Centre.

Once you have checked the appliance, deactivate and activate the appliance. If

12.1 The washing and drying results are not satisfactory

Problem	Possible cause and solution
Poor washing results.	<ul style="list-style-type: none"> Refer to "Daily use", "Hints and tips" and the basket loading leaflet. Use more intensive washing programmes. Clean spray arm jets and the filter. Refer to "Care and Cleaning".
Poor drying results.	<ul style="list-style-type: none"> Tableware has been left for too long inside the closed appliance. There is no rinse aid or the dosage of rinse aid is not sufficient. Adjust the rinse aid level to a higher level. Plastic items may need to be towel dried. For the best drying performance, activate XtraDry and AirDry. We recommend to always use rinse aid, even in combination with multi-tablets.
There are whitish streaks or bluish layers on glasses and dishes.	<ul style="list-style-type: none"> The released quantity of rinse aid is too high. Adjust the rinse aid level to a lower level. The quantity of detergent is too high.
There are stains and dry water drops on glasses and dishes.	<ul style="list-style-type: none"> The released quantity of rinse aid is not sufficient. Adjust the rinse aid level to a higher level. The quality of the rinse aid can be the cause.
The dishes are wet.	<ul style="list-style-type: none"> For the best drying performance, activate XtraDry and AirDry . The programme does not have a drying phase or has a drying phase with low temperature. The rinse aid dispenser is empty. The quality of the rinse aid can be the cause. The quality of the multi-tablets can be the cause. Try a different brand or activate the rinse aid dispenser and use rinse aid and multi-tablets together.
The interior of the appliance is wet.	<ul style="list-style-type: none"> This is not a defect of the appliance. Humid air condensates on the appliance walls.
Unusual foam during washing.	<ul style="list-style-type: none"> Use the detergent designed specifically for dishwashers. There is a leak in the rinse aid dispenser. Contact an Authorised Service Centre.

Problem	Possible cause and solution
Traces of rust on cutlery.	<ul style="list-style-type: none"> • There is too much salt in the water used for washing. Refer to "The water softener". • Silver and stainless steel cutlery were placed together. Avoid putting silver and stainless steel items close together.
There are residues of detergent in the dispenser at the end of the programme.	<ul style="list-style-type: none"> • The detergent tablet got stuck in the dispenser and was not completely washed away by water. • Water cannot wash away the detergent from the dispenser. Make sure that the spray arm is not blocked or clogged. • Make sure that items in the baskets do not impede the lid of the detergent dispenser from opening.
Odours inside the appliance.	<ul style="list-style-type: none"> • Refer to "Internal cleaning".
Limescale deposits on the tableware, on the tub and on the inside of the door.	<ul style="list-style-type: none"> • The level of salt is low. Check the salt indicator. • The cap of the salt container is loose. • Your tap water is hard. Refer to "The water softener". • Use salt and set regeneration of the water softener even when multi-functional tablets are used. Refer to "The water softener". • If lime scale deposits still remain, clean the appliance with appliance cleaners which are particularly suitable for this purpose. • Try a different detergent. • Contact the detergent manufacturer.
Dull, discoloured or chipped tableware.	<ul style="list-style-type: none"> • Make sure that only dishwasher-safe items are washed in the appliance. • Load and unload the basket carefully. Refer to basket loading leaflet. • Place delicate items in the upper basket. • For washing delicate items and glassware, select the dedicated programme. Refer to "Programmes".



Refer to "**Before first use**", "**Daily use**" or "**Hints and tips**" for other possible causes.

13. TECHNICAL INFORMATION

Dimensions	Width / height / depth (mm)	596 / 850 / 610
Electrical connection ¹⁾	Voltage (V)	220 - 240
	Frequency (Hz)	50

Water supply pressure	bar (minimum and maximum)	0.5 - 8
	MPa (minimum and maximum)	0.05 - 0.8
Water supply	Cold water or hot water 2)	max 60 °C
Capacity	Place settings	13
Power consumption	Left-on mode (W)	5.0
	Off-mode (W)	0.50

1) Refer to the rating plate for other values.

2) If the hot water comes from alternative source of energy (e.g. solar panels), use the hot water supply to decrease energy consumption.

14. ENVIRONMENTAL CONCERNS

Recycle materials with the symbol . Put the packaging in relevant containers to recycle it. Help protect the environment and human health by recycling waste of electrical and electronic appliances. Do not dispose of

appliances marked with the symbol  with the household waste. Return the product to your local recycling facility or contact your municipal office.

www.aeg.com/shop



117871110-A-132018



AEG

Free Manuals Download Website

<http://myh66.com>

<http://usermanuals.us>

<http://www.somanuals.com>

<http://www.4manuals.cc>

<http://www.manual-lib.com>

<http://www.404manual.com>

<http://www.luxmanual.com>

<http://aubethermostatmanual.com>

Golf course search by state

<http://golfingnear.com>

Email search by domain

<http://emailbydomain.com>

Auto manuals search

<http://auto.somanuals.com>

TV manuals search

<http://tv.somanuals.com>